

STATE OF ILLINOIS
DEPARTMENT OF TRANSPORTATION

NOTES

Bar splicer assemblies shall be of an approved type and shall develop in tension at least 125 percent of the yield strength of the lapped reinforcement bars.
Splicer rods shall be of minimum 60 ksi yield strength, threaded or coiled full length.
All reinforcement bars shall be lapped and tied to the splicer rods or dowel bars.
Bar splicer assemblies shall be epoxy coated according to the requirements for reinforcement bars.
Other systems of similar design may be submitted to the Engineer for approval. Approval shall be based on certified test results from an approved testing laboratory that the proposed bar splicer assembly satisfies the following requirements:

- ① Minimum Capacity (Tension in kips) = $1.25 \times f_y \times A_t$
 - ② Minimum *Pull-out Strength (Tension in kips) = $0.66 \times f_y \times A_t$
- Where f_y = Yield strength of lapped reinforcement bars in ksi.
 A_t = Tensile stress area of lapped reinforcement bars.
* = 28 day concrete

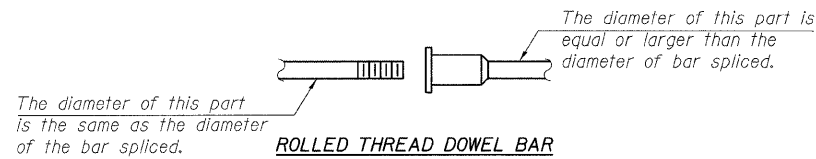

ROLLED THREAD DOWEL BAR



** ONE PIECE

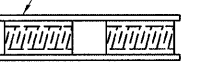
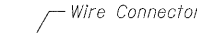

WELDED SECTIONS

BAR SPLICER ASSEMBLY ALTERNATIVES

**Heavy Hex Nuts conforming to ASTM A 563, Grade C, D or DH may be used.

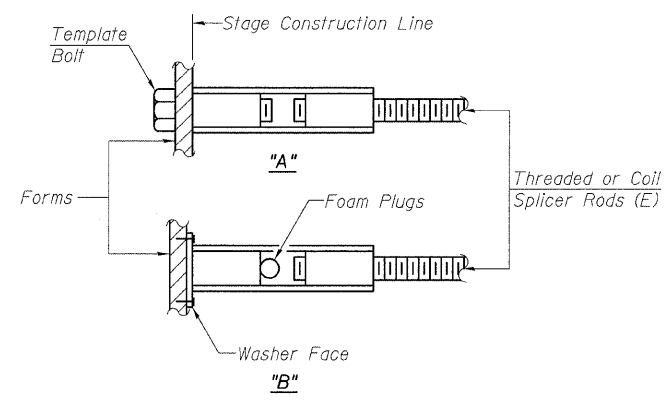

INSTALLATION AND SETTING METHODS

"A" : Set bar splicer assembly by means of a template bolt.
"B" : Set bar splicer assembly by nailing to wood forms or cementing to steel forms.
(E) : Indicates epoxy coating.

Bar Size to be Spliced	Splicer Rod or Dowel Bar Length	Strength Requirements	
		Min. Capacity kips - tension	Min. Pull-Out Strength kips - tension
#4	1'-8"	14.7	7.9
#5	2'-2"	23.0	12.3
#6	2'-7"	33.1	17.4
#7	3'-5"	45.1	23.8
#8	4'-6"	58.9	31.3
#9	5'-9"	75.0	39.6
#10	7'-3"	95.0	50.3
#11	9'-0"	117.4	61.8

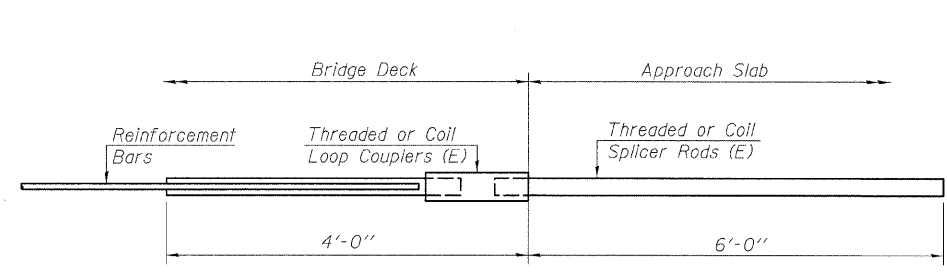

FOR INTEGRAL OR SEMI-INTEGRAL ABUTMENTS

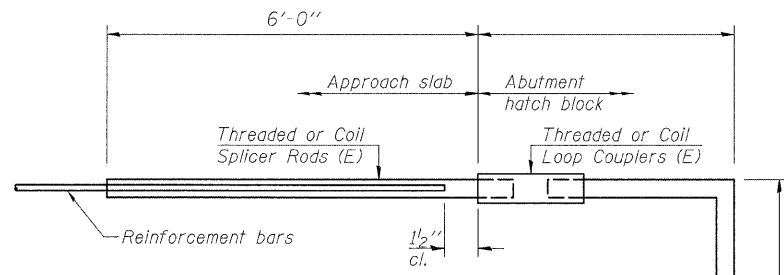

FOR STUB ABUTMENTS

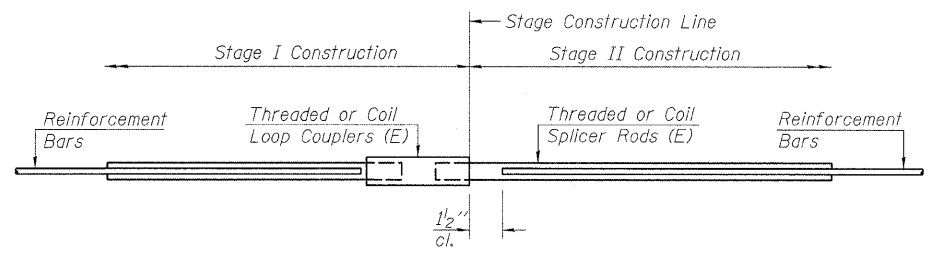

STANDARD

Bar Splicer for #5 bar
Min. Capacity = 23.0 kips - tension
Min. Pull-out Strength = 12.3 kips - tension
No. Required =

Bar Splicer for #5 bar
Min. Capacity = 23.0 kips - tension
Min. Pull-out Strength = 12.3 kips - tension
No. Required =

Bar Size	No. Assemblies Required	Location
#5	4	Deck
#5	16	Abutment
#8	32	Deck

BAR SPLICER ASSEMBLY DETAILS
STRUCTURE NO. 060-0012 (E.B.)
STRUCTURE NO. 060-0013 (W.B.)

DESIGNED EML
CHECKED JJD
DRAWN EML
CHECKED JJD

BSD-1 10-1-08



SHEET NO. 14 14 SHEETS	F.A.I. RTE.	SECTION	COUNTY	TOTAL SHEETS	SHEET NO.
	70	60-(5,6,7)RS, 60-(6,7)BR	MADISON	185	128
CONTRACT NO. 76C56					
FED. ROAD DIST. NO. ILLINOIS FED. AID PROJECT					