

# **BID PROPOSAL INSTRUCTIONS**

**ABOUT IDOT PROPOSALS:** All proposals are potential bidding proposals. Each proposal contains all certifications and affidavits, a proposal signature sheet and a proposal bid bond.

## **PREQUALIFICATION**

Any contractor who desires to become pre-qualified to bid on work advertised by IDOT must submit the properly completed pre-qualification forms to the Bureau of Construction no later than 4:30 p.m. prevailing time twenty-one days prior to the letting of interest. This pre-qualification requirement applies to first time contractors, contractors renewing expired ratings, contractors maintaining continuous pre-qualification or contractors requesting revised ratings. To be eligible to bid, existing pre-qualification ratings must be effective through the date of letting.

## **WHO CAN BID ?**

Bids will be accepted from only those companies that request and receive written Authorization to Bid from IDOT's Central Bureau of Construction.

## **REQUESTS FOR AUTHORIZATION TO BID**

Contractors wanting to bid on items included in a particular letting must submit the properly completed "Request for Authorization to Bid/or Not For Bid Status" (BDE 124) and the ORIGINAL "Affidavit of Availability" (BC 57) to the proper office no later than 4:30 p.m. prevailing time, three (3) days prior to the letting date.

## **WHAT CONSTITUTES WRITTEN AUTHORIZATION TO BID?**

When a prospective prime bidder submits a "Request for Authorization to Bid/or Not For Bid Status"(BDE 124) he/she must indicate at that time which items are being requested For Bidding purposes. Only those items requested For Bidding will be analyzed. After the request has been analyzed, the bidder will be issued an **Authorization to Bid or Not for Bid Report**, approved by the Central Bureau of Construction and the Chief Procurement Officer that indicates which items have been approved For Bidding. If **Authorization to Bid** cannot be approved, the **Authorization to Bid or Not for Bid Report** will indicate the reason for denial.

## **ABOUT AUTHORIZATION TO BID**

Firms that have not received an Authorization to Bid or Not For Bid Report within a reasonable time of complete and correct original document submittal should contact the Department as to the status. Firms unsure as to authorization status should call the Prequalification Section of the Bureau of Construction at the number listed at the end of these instructions.

## **ADDENDA AND REVISIONS**

It is the bidder's responsibility to determine which, if any, addenda or revisions pertain to any project they may be bidding. Failure to incorporate all relevant addenda or revisions may cause the bid to be declared unacceptable.

Each addendum or revision will be included with the Electronic Plans and Proposals. Addenda and revisions will also be placed on the Addendum/Revision Checklist and each subscription service subscriber will be notified by e-mail of each addendum and revision issued.

The Internet is the Department's primary way of doing business. The subscription service emails are an added courtesy the Department provides. It is suggested that bidders check IDOT's website at <http://www.dot.il.gov/desenv/delett.html> before submitting final bid information.

***IDOT IS NOT RESPONSIBLE FOR ANY E-MAIL FAILURES.***

Addenda questions may be directed to the Contracts Office at (217)782-7806 or [DOT.D&Econtracts@illinois.gov](mailto:DOT.D&Econtracts@illinois.gov)

Technical questions about downloading these files may be directed to Tim Garman at (217)524-1642 or [Timothy.Garman@illinois.gov](mailto:Timothy.Garman@illinois.gov).

## **STANDARD GUIDELINES FOR SUBMITTING BIDS**

- All pages should be single sided.
- Use the Cover Page that is provided in the Bid Proposal (posted on the IDOT Web Site) as the first page of your submitted bid. It has the item number in large bold type in the upper left-hand corner and lines provided for your company name and address in the upper right-hand corner.
- Do not use report covers, presentation folders or special bindings and do not staple multiple times on left side like a book. Use only 1 staple in the upper left hand corner. Make sure all elements of your bid are stapled together including the bid bond or guaranty check (if required).
- Do not include any certificates of eligibility, your authorization to bid, Addendum Letters or affidavit of availability.
- Do not include the Subcontractor Documentation with your bid (pages i – iii and pages a – g). This documentation is required only if you are awarded the project.
- Use the envelope cover sheet (provided with the proposal) as the cover for the proposal envelope.
- Do not rely on overnight services to deliver your proposal prior to 10 AM on letting day. It will not be read if it is delivered after 10 AM.
- Do not submit your Substance Abuse Prevention Program (SAPP) with your bid. If you are awarded the contract this form is to be submitted to the district engineer at the pre-construction conference.

## **BID SUBMITTAL CHECKLIST**

- Cover page** (the sheet that has the item number on it) – This should be the first page of your bid proposal, **followed by your bid (the Schedule of Prices/Pay Items)**. If you are using special software or CBID to generate your schedule of prices, do not include the blank pages of the schedule of prices that came with the proposal package.
- Page 4 (Item 9)** – Check “YES” if you will use a subcontractor(s) with an annual value over \$50,000. Include the subcontractor(s) name, address, general type of work to be performed and the dollar amount. If you will use subcontractor(s) but are uncertain who or the dollar amount; check “YES” but leave the lines blank.
- After page 4** – Insert the following documents: The **Illinois Office Affidavit** (Not applicable to federally funded projects) followed by Cost Adjustments for Steel, Bituminous and Fuel (if applicable) and the Contractor Letter of Assent (if applicable). The general rule should be, if you don’t know where it goes, put it after page 4.
- Page 10 (Paragraph J)** – Check “YES” or “NO” whether your company has any business in Iran.
- Page 10 (Paragraph K)** – (Not applicable to federally funded projects) List the name of the apprenticeship and training program sponsor holding the certificate of registration from the US Department of Labor. If no applicable program exists, please indicate the work/job category **Your bid will not be read if this is not completed.** Do not include certificates with your bid. Keep the certificates in your office in case they are requested by IDOT.
- Page 11 (Paragraph L)** – A copy of your State Board of Elections certificate of registration is no longer required with your bid.
- Page 11 (Paragraph M)** – Indicate if your company has hired a lobbyist in connection with the job for which you are submitting the bid proposal.
- Page 12 (Paragraph C)** – This is a work sheet to determine if a completed Form A is required. It is not part of the form and you do not need to make copies for each completed Form A.
- Pages 14-17 (Form A)** – One Form A (4 pages) is required for each applicable person in your company. Copies of the forms can be used and only need to be changed when the information changes. The certification signature and date must be original for each letting. **Do not staple the forms together.** If you answered “NO” to all of the questions in Paragraph C (page 12), complete the first section (page 14) with your company information and then sign and date the Not Applicable statement on page 17.
- Page 18 (Form B)** - If you check “YES” to having other current or pending contracts it is acceptable to use the phrase, “See Affidavit of Availability on file”. **Ownership Certification** (at the bottom of the page) - Check N/A if the Form A(s) you submitted accounts for 100 percent of the company ownership. Check YES if any percentage of ownership falls outside of the parameters that require reporting on the Form A. Checking NO indicates that the Form A(s) you submitted is not correct and you will be required to submit a revised Form A.
- Page 20 (Workforce Projection)** – Be sure to include the Duration of the Project. It is acceptable to use the phrase “Per Contract Specifications”.

**Proposal Bid Bond** – (Insert after the proposal signature page) Submit your proposal Proposal Bid Bond (if applicable) using the current Proposal Bid Bond form provided in the proposal package. The Power of Attorney page should be stapled to the Proposal Bid Bond. If you are using an electronic bond, include your bid bond number on the Proposal Bid Bond and attach the Proof of Insurance printed from the Surety’s Web Site.

**Disadvantaged Business Utilization Plan and/or Good Faith Effort** – The last items in your bid should be the DBE Utilization Plan (SBE 2026), followed by the DBE Participation Statement (SBE 2025) and supporting paperwork. If you have documentation of a Good Faith Effort, it is to follow the SBE Forms.

**The Bid Letting is now available in streaming Audio/Video from the IDOT Web Site.** A link to the stream will be placed on the main page of the current letting on the day of the Letting. The stream will not begin until 10 AM. The actual reading of the bids does not begin until approximately 10:30 AM.

Following the Letting, the As-Read Tabulation of Bids will be posted by the end of the day. You will find the link on the main Web page for the current letting.

**QUESTIONS: pre-letting up to execution of the contract**

Contractor pre-qualification .....	217-782-3413
Small Business, Disadvantaged Business Enterprise (DBE) .....	217-785-4611
Contracts, Bids, Letting process or Internet downloads .....	217-782-7806
Estimates Unit.....	217-785-3483
Aeronautics.....	217-785-8515
IDNR (Land Reclamation, Water Resources, Natural Resources).....	217-782-6302

**QUESTIONS: following contract execution**

Subcontractor documentation, payments .....	217-782-3413
Railroad Insurance .....	217-785-0275

# 116

RETURN WITH BID

Proposal Submitted By
Name
Address
City

Letting January 17, 2014

**NOTICE TO PROSPECTIVE BIDDERS**

This proposal can be used for bidding purposes by only those companies that request and receive written AUTHORIZATION TO BID from IDOT's Central Bureau of Construction.

**BIDDERS NEED NOT RETURN THE ENTIRE PROPOSAL**

# Notice to Bidders, Specifications, Proposal, Contract and Contract Bond



**Illinois Department  
of Transportation**

Springfield, Illinois 62764

**Contract No. 76G67  
CLINTON County  
Section (20,21)-J  
Route FAP 327  
Project ACHSIP-0327(059)  
District 8 Construction Funds**

PLEASE MARK THE APPROPRIATE BOX BELOW:

- A Bid Bond is included.
  
- A Cashier's Check or a Certified Check is included

Plans Included  
Herein

Prepared by \_\_\_\_\_ F

Checked by \_\_\_\_\_

(Printed by authority of the State of Illinois)

**Page intentionally left blank**

RETURN WITH BID



PROPOSAL

TO THE DEPARTMENT OF TRANSPORTATION

1. Proposal of \_\_\_\_\_  
\_\_\_\_\_

Taxpayer Identification Number (Mandatory) \_\_\_\_\_

For the improvement identified and advertised for bids in the Invitation for Bids as:

**Contract No. 76G67  
CLINTON County  
Section (20,21)-J  
Project ACHSIP-0327(059)  
Route FAP 327  
District 8 Construction Funds**

**This project consists of guardrail replacement, ditch regrading, rip rap placement and safety shoulders with rumble strips along a 2.09 mile stretch of US 50 from Huey Road to Creek Road in Clinton County.**

2. The undersigned bidder will furnish all labor, material and equipment to complete the above described project in a good and workmanlike manner as provided in the contract documents provided by the Department of Transportation. This proposal will become part of the contract and the terms and conditions contained in the contract documents will govern performance and payments.

**RETURN WITH BID**

3. **ASSURANCE OF EXAMINATION AND INSPECTION/WAIVER.** The undersigned bidder further declares that he/she has carefully examined the proposal, plans, specifications, addenda form of contract and contract bond, and special provisions, and that he/she has inspected in detail the site of the proposed work, and that he/she has familiarized themselves with all of the local conditions affecting the contract and the detailed requirements of construction, and understands that in making this bid proposal he/she waives all right to plead any misunderstanding regarding the same.
  
4. **EXECUTION OF CONTRACT AND CONTRACT BOND.** The undersigned bidder further agrees to execute a contract for this work and present the same to the department within fifteen (15) days after the contract has been mailed to him/her. The undersigned further agrees that he/she and his/her surety will execute and present within fifteen (15) days after the contract has been mailed to him/her contract bond satisfactory to and in the form prescribed by the Department of Transportation, in the penal sum of the full amount of the contract, or as specified in the special provisions, guaranteeing the faithful performance of the work in accordance with the terms of the contract.
  
5. **PROPOSAL GUARANTY.** Accompanying this proposal is either a bid bond on the department form, executed by a corporate surety company satisfactory to the department, or a proposal guaranty check consisting of a bank cashier's check or a properly certified check for not less than 5 per cent of the amount bid or for the amount specified in the following schedule:

<u>Amount of Bid</u>		<u>Proposal Guaranty</u>	<u>Amount of Bid</u>		<u>Proposal Guaranty</u>	
Up to	\$5,000 .....	\$150	\$2,000,000	to	\$3,000,000 .....	\$100,000
\$5,000	to \$10,000 .....	\$300	\$3,000,000	to	\$5,000,000 .....	\$150,000
\$10,000	to \$50,000 .....	\$1,000	\$5,000,000	to	\$7,500,000 .....	\$250,000
\$50,000	to \$100,000 .....	\$3,000	\$7,500,000	to	\$10,000,000 .....	\$400,000
\$100,000	to \$150,000 .....	\$5,000	\$10,000,000	to	\$15,000,000 .....	\$500,000
\$150,000	to \$250,000 .....	\$7,500	\$15,000,000	to	\$20,000,000 .....	\$600,000
\$250,000	to \$500,000 .....	\$12,500	\$20,000,000	to	\$25,000,000 .....	\$700,000
\$500,000	to \$1,000,000 .....	\$25,000	\$25,000,000	to	\$30,000,000 .....	\$800,000
\$1,000,000	to \$1,500,000 .....	\$50,000	\$30,000,000	to	\$35,000,000 .....	\$900,000
\$1,500,000	to \$2,000,000 .....	\$75,000	over		\$35,000,000 .....	\$1,000,000

Bank cashier's checks or properly certified checks accompanying bid proposals will be made payable to the Treasurer, State of Illinois.

If a combination bid is submitted, the proposal guaranties which accompany the individual bid proposals making up the combination will be considered as also covering the combination bid.

The amount of the proposal guaranty check is \_\_\_\_\_ \$( \_\_\_\_\_ ). If this proposal is accepted and the undersigned will fail to execute a contract bond as required herein, it is hereby agreed that the amount of the proposal guaranty will become the property of the State of Illinois, and shall be considered as payment of damages due to delay and other causes suffered by the State because of the failure to execute said contract and contract bond; otherwise, the bid bond will become void or the proposal guaranty check will be returned to the undersigned.

**Attach Cashier's Check or Certified Check Here**

In the event that one proposal guaranty check is intended to cover two or more bid proposals, the amount must be equal to the sum of the proposal guaranties which would be required for each individual bid proposal. If the guaranty check is placed in another bid proposal, state below where it may be found.

The proposal guaranty check will be found in the bid proposal for:

Item \_\_\_\_\_

Section No. \_\_\_\_\_

County \_\_\_\_\_

**Mark the proposal cover sheet as to the type of proposal guaranty submitted.**

**RETURN WITH BID**

6. **COMBINATION BIDS.** The undersigned bidder further agrees that if awarded the contract for the sections contained in the following combination, he/she will perform the work in accordance with the requirements of each individual contract comprising the combination bid specified in the schedule below, and that the combination bid shall be prorated against each section in proportion to the bid submitted for the same. If an error is found to exist in the gross sum bid for one or more of the individual sections included in a combination, the combination bid shall be corrected as provided in the specifications.

**When a combination bid is submitted, the schedule below must be completed in each proposal comprising the combination.**

**If alternate bids are submitted for one or more of the sections comprising the combination, a combination bid must be submitted for each alternate.**

**Schedule of Combination Bids**

Combination No.	Sections Included in Combination	Combination Bid	
		Dollars	Cents

7. **SCHEDULE OF PRICES.** The undersigned bidder submits herewith, in accordance with the rules and instructions, a schedule of prices for the items of work for which bids are sought. The unit prices bid are in U.S. dollars and cents, and all extensions and summations have been made. The bidder understands that the quantities appearing in the bid schedule are approximate and are provided for the purpose of obtaining a gross sum for the comparison of bids. If there is an error in the extension of the unit prices, the unit prices will govern. Payment to the contractor awarded the contract will be made only for actual quantities of work performed and accepted or materials furnished according to the contract. The scheduled quantities of work to be done and materials to be furnished may be increased, decreased or omitted as provided elsewhere in the contract.
8. **AUTHORITY TO DO BUSINESS IN ILLINOIS.** Section 20-43 of the Illinois Procurement Code (the Code) (30 ILCS 500/20-43) provides that a person (other than an individual acting as a sole proprietor) must be a legal entity authorized to do business in the State of Illinois prior to submitting the bid.
9. **EXECUTION OF CONTRACT:** The Department of Transportation will, in accordance with the rules governing Department procurements, execute the contract and shall be the sole entity having the authority to accept performance and make payments under the contract. Execution of the contract by the Chief Procurement Officer (CPO) or the State Purchasing Officer (SPO) is for approval of the procurement process and execution of the contract by the Department. Neither the CPO nor the SPO shall be responsible for administration of the contract or determinations respecting performance or payment there under except as otherwise permitted in the Code.
10. **The services of a subcontractor will be used.**

Check box Yes   
 Check box No

For known subcontractors with subcontracts with an annual value of more than \$50,000, the contract shall include their name, address, general type of work to be performed, and the dollar allocation for each subcontractor.  
 (30 ILCS 500/20-120)

---



---



ILLINOIS DEPARTMENT OF TRANSPORTATION  
 SCHEDULE OF PRICES  
 CONTRACT  
 NUMBER -

76G67

State Job # - C-98-068-13

Project Number  
 ACHSIP-0327/059/

Route  
 FAP 327

County Name - CLINTON - -

Code - 27 - -

District - 8 - -

Section Number - (20,21)-J

Item Number	Pay Item Description	Unit of Measure	Quantity	x	Unit Price	=	Total Price
X7030140	PAVT MK TAPE T3 6 SP	FOOT	2,250.000				
Z0076600	TRAINEES	HOUR	500.000		0.800		400.000
Z0076604	TRAINEES TPG	HOUR	500.000		10.000		5,000.000
20200100	EARTH EXCAVATION	CU YD	1,550.000				
25000210	SEEDING CL 2A	ACRE	5.750				
25000400	NITROGEN FERT NUTR	POUND	518.000				
25000500	PHOSPHORUS FERT NUTR	POUND	518.000				
25000600	POTASSIUM FERT NUTR	POUND	518.000				
25100115	MULCH METHOD 2	ACRE	4.750				
25100900	TURF REINF MAT	SQ YD	3,333.000				
28000250	TEMP EROS CONTR SEED	POUND	475.000				
28000305	TEMP DITCH CHECKS	FOOT	900.000				
28100205	STONE RIPRAP CL A3	TON	1,062.000				
28200200	FILTER FABRIC	SQ YD	3,962.000				
40201000	AGGREGATE-TEMP ACCESS	TON	58.000				
40600200	BIT MATLS PR CT	TON	22.500				
40600300	AGG PR CT	TON	14.000				

ILLINOIS DEPARTMENT OF TRANSPORTATION  
 SCHEDULE OF PRICES  
 CONTRACT  
 NUMBER -

76G67

State Job # - C-98-068-13

Project Number  
 ACHSIP-0327/059/

Route  
 FAP 327

County Name - CLINTON - -

Code - 27 - -

District - 8 - -

Section Number - (20,21)-J

Item Number	Pay Item Description	Unit of Measure	Quantity	x	Unit Price	=	Total Price
40603092	HMA BC IL-19.0 FG N90	TON	4,403.000				
40603345	HMA SC "D" N90	TON	1,132.000				
44000100	PAVEMENT REM	SQ YD	3,993.000				
44000200	DRIVE PAVEMENT REM	SQ YD	57.000				
48102100	AGG WEDGE SHLD TYPE B	TON	5.000				
63000003	SPBGR TY A 9FT POSTS	FOOT	2,075.000				
63000350	LSG OV CUL 12'6" SPAN	FOOT	612.500				
63000360	LSG OV CUL 18'9" SPAN	FOOT	337.500				
63100167	TR BAR TRM T1 SPL TAN	EACH	21.000				
63200310	GUARDRAIL REMOV	FOOT	1,823.000				
64200108	SHOULDER RUM STRIP 8	FOOT	17,659.000				
67000400	ENGR FIELD OFFICE A	CAL MO	6.000				
67100100	MOBILIZATION	L SUM	1.000				
70100450	TRAF CONT-PROT 701201	L SUM	1.000				
70100460	TRAF CONT-PROT 701306	L SUM	1.000				

ILLINOIS DEPARTMENT OF TRANSPORTATION  
 SCHEDULE OF PRICES  
 CONTRACT  
 NUMBER -

76G67

State Job # - C-98-068-13

Project Number  
 ACHSIP-0327/059/

Route  
 FAP 327

County Name - CLINTON - -

Code - 27 - -

District - 8 - -

Section Number - (20,21)-J

Item Number	Pay Item Description	Unit of Measure	Quantity	x	Unit Price	=	Total Price
70100500	TRAF CONT-PROT 701326	L SUM	1.000				
70103815	TR CONT SURVEILLANCE	CAL DA	64.000				
70300100	SHORT TERM PAVT MKING	FOOT	1,632.000				
70300220	TEMP PVT MK LINE 4	FOOT	20,164.000				
70301000	WORK ZONE PAVT MK REM	SQ FT	1,669.000				
78001110	PAINT PVT MK LINE 4	FOOT	20,164.000				
78100100	RAISED REFL PAVT MKR	EACH	225.000				
78200410	GUARDRAIL MKR TYPE A	EACH	26.000				
78201000	TERMINAL MARKER - DA	EACH	21.000				
78300200	RAISED REF PVT MK REM	EACH	225.000				

**CONTRACT NUMBER**

**76G67**

**THIS IS THE TOTAL BID**

**\$ \_\_\_\_\_**

**NOTES:**

- 1. Each PAY ITEM should have a UNIT PRICE and a TOTAL PRICE.**
- 2. The UNIT PRICE shall govern if no TOTAL PRICE is shown or if there is a discrepancy between the product of the UNIT PRICE multiplied by the QUANTITY.**
- 3. If a UNIT PRICE is omitted, the TOTAL PRICE will be divided by the QUANTITY in order to establish a UNIT PRICE.**
- 4. A bid may be declared UNACCEPTABLE if neither a unit price nor a total price is shown.**

## RETURN WITH BID

### **STATE REQUIRED ETHICAL STANDARDS GOVERNING CONTRACT PROCUREMENT: ASSURANCES, CERTIFICATIONS AND DISCLOSURES**

#### **I. GENERAL**

**A.** Article 50 of the Code establishes the duty of all State CPOs, SPOs, and their designees to maximize the value of the expenditure of public moneys in procuring goods, services, and contracts for the State of Illinois and to act in a manner that maintains the integrity and public trust of State government. In discharging this duty, they are charged by law to use all available information, reasonable efforts, and reasonable actions to protect, safeguard, and maintain the procurement process of the State of Illinois.

**B.** In order to comply with the provisions of Article 50 and to carry out the duty established therein, all bidders are to adhere to ethical standards established for the procurement process, and to make such assurances, disclosures and certifications required by law. Except as otherwise required in subsection III, paragraphs J-M, by execution of the Proposal Signature Sheet, the bidder indicates that each of the mandated assurances have been read and understood, that each certification is made and understood, and that each disclosure requirement has been understood and completed.

**C.** In addition to all other remedies provided by law, failure to comply with any assurance, failure to make any disclosure or the making of a false certification shall be grounds for the CPO to void the contract, and may result in the suspension or debarment of the bidder or subcontractor. If a false certification is made by a subcontractor the contractor's submitted bid and the executed contract may not be declared void unless the contractor refuses to terminate the subcontract upon the State's request after a finding that the subcontractor's certification was false.

I acknowledge, understand and accept these terms and conditions.

#### **II. ASSURANCES**

The assurances hereinafter made by the bidder are each a material representation of fact upon which reliance is placed should the Department enter into the contract with the bidder.

##### **A. Conflicts of Interest**

Section 50-13. Conflicts of Interest.

(a) Prohibition. It is unlawful for any person holding an elective office in this State, holding a seat in the General Assembly, or appointed to or employed in any of the offices or agencies of state government and who receives compensation for such employment in excess of 60% of the salary of the Governor of the State of Illinois, or who is an officer or employee of the Capital Development Board or the Illinois State Toll Highway Authority, or who is the spouse or minor child of any such person to have or acquire any contract, or any direct pecuniary interest in any contract therein, whether for stationery, printing, paper, or any services, materials, or supplies, that will be wholly or partially satisfied by the payment of funds appropriated by the General Assembly of the State of Illinois or in any contract of the Capital Development Board or the Illinois State Toll Highway Authority.

(b) Interests. It is unlawful for any firm, partnership, association or corporation, in which any person listed in subsection (a) is entitled to receive (i) more than 7 1/2% of the total distributable income or (ii) an amount in excess of the salary of the Governor, to have or acquire any such contract or direct pecuniary interest therein.

(c) Combined interests. It is unlawful for any firm, partnership, association, or corporation, in which any person listed in subsection (a) together with his or her spouse or minor children is entitled to receive (i) more than 15%, in the aggregate, of the total distributable income or (ii) an amount in excess of 2 times the salary of the Governor, to have or acquire any such contract or direct pecuniary interest therein.

(d) Securities. Nothing in this Section invalidates the provisions of any bond or other security previously offered or to be offered for sale or sold by or for the State of Illinois.

(e) Prior interests. This Section does not affect the validity of any contract made between the State and an officer or employee of the State or member of the General Assembly, his or her spouse, minor child or any combination of those persons if that contract was in existence before his or her election or employment as an officer, member, or employee. The contract is voidable, however, if it cannot be completed within 365 days after the officer, member, or employee takes office or is employed.

The current salary of the Governor is \$177,412.00. Sixty percent of the salary is \$106,447.20.

## RETURN WITH BID

The bidder assures the Department that the award and execution of the contract would not cause a violation of Section 50-13, or that an effective exemption has been issued by the Board of Ethics to any individual subject to the Section 50-13 prohibitions pursuant to the provisions of Section 50-20 of the Code. Information concerning the exemption process is available from the Department upon request.

### **B. Negotiations**

Section 50-15. Negotiations.

It is unlawful for any person employed in or on a continual contractual relationship with any of the offices or agencies of State government to participate in contract negotiations on behalf of that office or agency with any firm, partnership, association, or corporation with whom that person has a contract for future employment or is negotiating concerning possible future employment.

The bidder assures the Department that the award and execution of the contract would not cause a violation of Section 50-15, and that the bidder has no knowledge of any facts relevant to the kinds of acts prohibited therein.

### **C. Inducements**

Section 50-25. Inducement.

Any person who offers or pays any money or other valuable thing to any person to induce him or her not to bid for a State contract or as recompense for not having bid on a State contract is guilty of a Class 4 felony. Any person who accepts any money or other valuable thing for not bidding for a State contract or who withholds a bid in consideration of the promise for the payment of money or other valuable thing is guilty of a Class 4 felony.

The bidder assures the Department that the award and execution of the contract would not cause a violation of Section 50-25, and that the bidder has no knowledge of any facts relevant to the kinds of acts prohibited therein.

### **D. Revolving Door Prohibition**

Section 50-30. Revolving door prohibition.

CPOs, SPOs, procurement compliance monitors, their designees whose principal duties are directly related to State procurement, and executive officers confirmed by the Senate are expressly prohibited for a period of 2 years after terminating an affected position from engaging in any procurement activity relating to the State agency most recently employing them in an affected position for a period of at least 6 months. The prohibition includes, but is not limited to: lobbying the procurement process; specifying; bidding; proposing bid, proposal, or contract documents; on their own behalf or on behalf of any firm, partnership, association, or corporation. This Section applies only to persons who terminate an affected position on or after January 15, 1999.

The bidder assures the Department that the award and execution of the contract would not cause a violation of Section 50-30, and that the bidder has no knowledge of any facts relevant to the kinds of acts prohibited therein.

### **E. Reporting Anticompetitive Practices**

Section 50-40. Reporting anticompetitive practices.

When, for any reason, any vendor, bidder, contractor, CPO, SPO, designee, elected official, or State employee suspects collusion or other anticompetitive practice among any bidders, offerors, contractors, proposers, or employees of the State, a notice of the relevant facts shall be transmitted to the Attorney General and the CPO.

The bidder assures the Department that it has not failed to report any relevant facts concerning the practices addressed in Section 50-40 which may involve the contract for which the bid is submitted.

### **F. Confidentiality**

Section 50-45. Confidentiality.

Any CPO, SPO, designee, or executive officer who willfully uses or allows the use of specifications, competitive bid documents, proprietary competitive information, proposals, contracts, or selection information to compromise the fairness or integrity of the procurement, bidding, or contract process shall be subject to immediate dismissal, regardless of the Personnel code, any contract, or any collective bargaining agreement, and may in addition be subject to criminal prosecution.

The bidder assures the Department that it has no knowledge of any fact relevant to the practices addressed in Section 50-45 which may involve the contract for which the bid is submitted.

## RETURN WITH BID

### G. Insider Information

Section 50-50. Insider information.

It is unlawful for any current or former elected or appointed State official or State employee to knowingly use confidential information available only by virtue of that office or employment for actual or anticipated gain for themselves or another person.

The bidder assures the Department that it has no knowledge of any facts relevant to the practices addressed in Section 50-50 which may involve the contract for which the bid is submitted.

I acknowledge, understand and accept these terms and conditions for the above assurances.

### III. CERTIFICATIONS

The certifications hereinafter made by the bidder are each a material representation of fact upon which reliance is placed should the Department enter into the contract with the bidder. Section 50-2 of the Code provides that every person that has entered into a multi-year contract and every subcontractor with a multi-year subcontract shall certify, by July 1 of each fiscal year covered by the contract after the initial fiscal year, to the responsible CPO whether it continues to satisfy the requirements of Article 50 pertaining to the eligibility for a contract award. If a contractor or subcontractor is not able to truthfully certify that it continues to meet all requirements, it shall provide with its certification a detailed explanation of the circumstances leading to the change in certification status. A contractor or subcontractor that makes a false statement material to any given certification required under Article 50 is, in addition to any other penalties or consequences prescribed by law, subject to liability under the Whistleblower Reward and Protection Act for submission of a false claim.

#### A. Bribery

Section 50-5. Bribery.

(a) Prohibition. No person or business shall be awarded a contract or subcontract under this Code who:

(1) has been convicted under the laws of Illinois or any other state of bribery or attempting to bribe an officer or employee of the State of Illinois or any other state in that officer's or employee's official capacity; or

(2) has made an admission of guilt of that conduct that is a matter of record but has not been prosecuted for that conduct.

(b) Businesses. No business shall be barred from contracting with any unit of State or local government, or subcontracting under such a contract, as a result of a conviction under this Section of any employee or agent of the business if the employee or agent is no longer employed by the business and:

(1) the business has been finally adjudicated not guilty; or

(2) the business demonstrates to the governmental entity with which it seeks to contract, or which is signatory to the contract which the subcontract relates, and that entity finds that the commission of the offense was not authorized, requested, commanded, or performed by a director, officer, or high managerial agent on behalf of the business as provided in paragraph (2) of subsection (a) of Section 5-4 of the Criminal Code of 2012.

(c) Conduct on behalf of business. For purposes of this Section, when an official, agent, or employee of a business committed the bribery or attempted bribery on behalf of the business and in accordance with the direction or authorization of a responsible official of the business, the business shall be chargeable with the conduct.

(d) Certification. Every bid submitted to and contract executed by the State, and every subcontract subject to Section 20-120 of the Code shall contain a certification by the contractor or the subcontractor, respectively, that the contractor or subcontractor is not barred from being awarded a contract or subcontract under this Section and acknowledges that the CPO may declare the related contract void if any certifications required by this Section are false. A contractor who makes a false statement, material to the certification, commits a Class 3 felony.

The contractor or subcontractor certifies that it is not barred from being awarded a contract under Section 50.5.

#### B. Felons

Section 50-10. Felons.

(a) Unless otherwise provided, no person or business convicted of a felony shall do business with the State of Illinois or any State agency, or enter into a subcontract, from the date of conviction until 5 years after the date of completion of the sentence for that felony, unless no person held responsible by a prosecutorial office for the facts upon which the conviction was based continues to have any involvement with the business.

(b) Certification. Every bid submitted to and contract executed by the State and every subcontract subject to Section 20-120 of the Code shall contain a certification by the bidder or contractor or subcontractor, respectively, that the bidder, contractor, or subcontractor is not barred from being awarded a contract or subcontract under this Section and acknowledges that the CPO may declare the related contract void if any of the certifications required by this Section are false.

## RETURN WITH BID

### **C. Debt Delinquency**

Section 50-11 and 50-12. Debt Delinquency.

The contractor or bidder or subcontractor, respectively, certifies that it, or any affiliate, is not barred from being awarded a contract or subcontract under the Code. Section 50-11 prohibits a person from entering into a contract with a State agency, or entering into a subcontract, if it knows or should know that it, or any affiliate, is delinquent in the payment of any debt to the State as defined by the Debt Collection Board. Section 50-12 prohibits a person from entering into a contract with a State agency, or entering into a subcontract, if it, or any affiliate, has failed to collect and remit Illinois Use Tax on all sales of tangible personal property into the State of Illinois in accordance with the provisions of the Illinois Use Tax Act. The bidder or contractor or subcontractor, respectively, further acknowledges that the CPO may declare the related contract void if this certification is false or if the bidder, contractor, or subcontractor, or any affiliate, is determined to be delinquent in the payment of any debt to the State during the term of the contract.

### **D. Prohibited Bidders, Contractors and Subcontractors**

Section 50-10.5 and 50-60(c). Prohibited bidders, contractors and subcontractors.

The bidder or contractor or subcontractor, respectively, certifies in accordance with 30 ILCS 500/50-10.5 that no officer, director, partner or other managerial agent of the contracting business has been convicted of a felony under the Sarbanes-Oxley Act of 2002 or a Class 3 or Class 2 felony under the Illinois Securities Law of 1953 or if in violation of Subsection (c) for a period of five years from the date of conviction. Every bid submitted to and contract executed by the State and every subcontract subject to Section 20-120 of the Code shall contain a certification by the bidder, contractor, or subcontractor, respectively, that the bidder, contractor, or subcontractor is not barred from being awarded a contract or subcontract under this Section and acknowledges that the CPO shall declare the related contract void if any of the certifications completed pursuant to this Section are false.

### **E. Section 42 of the Environmental Protection Act**

The bidder or contractor or subcontractor, respectively, certifies in accordance with 30 ILCS 500/50-14 that the bidder, contractor, or subcontractor, is not barred from being awarded a contract or entering into a subcontract under this Section which prohibits the bidding on or entering into contracts with the State of Illinois or a State agency, or entering into any subcontract, that is subject to the Code by a person or business found by a court or the Pollution Control Board to have committed a willful or knowing violation of Section 42 of the Environmental Protection Act for a period of five years from the date of the order. The bidder or contractor or subcontractor, respectively, acknowledges that the CPO may declare the contract void if this certification is false.

### **F. Educational Loan**

Section 3 of the Educational Loan Default Act provides no State agency shall contract with an individual for goods or services if that individual is in default, as defined in Section 2 of this Act, on an educational loan. Any contract used by any State agency shall include a statement certifying that the individual is not in default on an educational loan as provided in this Section.

The bidder, if an individual as opposed to a corporation, partnership or other form of business organization, certifies that the bidder is not in default on an educational loan as provided in Section 3 of the Act.

### **G. Bid-Rigging/Bid Rotating**

Section 33E-11 of the Criminal Code of 2012 provides:

(a) Every bid submitted to and public contract executed pursuant to such bid by the State or a unit of local government shall contain a certification by the prime contractor that the prime contractor is not barred from contracting with any unit of State or local government as a result of a violation of either Section 33E-3 or 33E-4 of this Article.

(b) A contractor who makes a false statement, material to the certification, commits a Class 3 felony.

A violation of Section 33E-3 would be represented by a conviction of the crime of bid-rigging which, in addition to Class 3 felony sentencing, provides that any person convicted of this offense or any similar offense of any state or the United States which contains the same elements as this offense shall be barred for 5 years from the date of conviction from contracting with any unit of State or local government. No corporation shall be barred from contracting with any unit of State or local government as a result of a conviction under this Section of any employee or agent of such corporation if the employee so convicted is no longer employed by the corporation and: (1) it has been finally adjudicated not guilty or (2) if it demonstrates to the governmental entity with which it seeks to contract and that entity finds that the commission of the offense was neither authorized, requested, commanded, nor performed by a director, officer or a high managerial agent in behalf of the corporation.



## RETURN WITH BID

A violation of Section 33E-4 would be represented by a conviction of the crime of bid-rotating which, in addition to Class 2 felony sentencing, provides that any person convicted of this offense or any similar offense of any state or the United States which contains the same elements as this offense shall be permanently barred from contracting with any unit of State or local government. No corporation shall be barred from contracting with any unit of State or local government as a result of a conviction under this Section of any employee or agent of such corporation if the employee so convicted is no longer employed by the corporation and: (1) it has been finally adjudicated not guilty or (2) if it demonstrates to the governmental entity with which it seeks to contract and that entity finds that the commission of the offense was neither authorized, requested, commanded, nor performed by a director, officer or a high managerial agent in behalf of the corporation.

The bidder certifies that it is not barred from contracting with the Department by reason of a violation of either Section 33E-3 or Section 33E-4.

### **H. International Anti-Boycott**

Section 5 of the International Anti-Boycott Certification Act provides every contract entered into by the State of Illinois for the manufacture, furnishing, or purchasing of supplies, material, or equipment or for the furnishing of work, labor, or services, in an amount exceeding the threshold for small purchases according to the purchasing laws of this State or \$10,000.00, whichever is less, shall contain certification, as a material condition of the contract, by which the contractor agrees that neither the contractor nor any substantially-owned affiliated company is participating or shall participate in an international boycott in violation of the provisions of the U.S. Export Administration Act of 1979 or the regulations of the U.S. Department of Commerce promulgated under that Act.

The bidder makes the certification set forth in Section 5 of the Act.

### **I. Drug Free Workplace**

The Illinois "Drug Free Workplace Act" applies to this contract and it is necessary to comply with the provisions of the "Act" if the contractor is a corporation, partnership, or other entity (including a sole proprietorship) which has 25 or more employees.

The bidder certifies that if awarded a contract in excess of \$5,000 it will provide a drug free workplace in compliance with the provisions of the Act.

### **J. Disclosure of Business Operations in Iran**

Section 50-36 of the Code, 30ILCS 500/50-36 provides that each bid, offer, or proposal submitted for a State contract shall include a disclosure of whether or not the Company acting as the bidder, offeror, or proposing entity, or any of its corporate parents or subsidiaries, within the 24 months before submission of the bid, offer, or proposal had business operations that involved contracts with or provision of supplies or services to the Government of Iran, companies in which the Government of Iran has any direct or indirect equity share, consortiums or projects commissioned by the Government of Iran, or companies involved in consortiums or projects commissioned by the Government of Iran and either of the following conditions apply:

- (1) More than 10% of the Company's revenues produced in or assets located in Iran involve oil-related activities or mineral-extraction activities; less than 75% of the Company's revenues produced in or assets located in Iran involve contracts with or provision of oil-related or mineral-extraction products or services to the Government of Iran or a project or consortium created exclusively by that government; and the Company has failed to take substantial action.
- (2) The Company has, on or after August 5, 1996, made an investment of \$20 million or more, or any combination of investments of at least \$10 million each that in the aggregate equals or exceeds \$20 million in any 12-month period, which directly or significantly contributes to the enhancement of Iran's ability to develop petroleum resources of Iran.

The terms "Business operations", "Company", "Mineral-extraction activities", "Oil-related activities", "Petroleum resources", and "Substantial action" are all defined in the Code.

Failure to make the disclosure required by the Code shall cause the bid, offer or proposal to be considered not responsive. The disclosure will be considered when evaluating the bid or awarding the contract. The name of each Company disclosed as doing business or having done business in Iran will be provided to the State Comptroller.

Check the appropriate statement:

Company has no business operations in Iran to disclose.

Company has business operations in Iran as disclosed the attached document.

## RETURN WITH BID

### **K. Apprenticeship and Training Certification (Does not apply to federal aid projects)**

In accordance with the provisions of Section 30-22 (6) of the Code, the bidder certifies that it is a participant, either as an individual or as part of a group program, in the approved apprenticeship and training programs applicable to each type of work or craft that the bidder will perform with its own forces. The bidder further certifies for work that will be performed by subcontract that each of its subcontractors submitted for approval either (a) is, at the time of such bid, participating in an approved, applicable apprenticeship and training program; or (b) will, prior to commencement of performance of work pursuant to this contract, begin participation in an approved apprenticeship and training program applicable to the work of the subcontract. The Department, at any time before or after award, may require the production of a copy of each applicable Certificate of Registration issued by the United States Department of Labor evidencing such participation by the contractor and any or all of its subcontractors. Applicable apprenticeship and training programs are those that have been approved and registered with the United States Department of Labor. The bidder shall list in the space below, the official name of the program sponsor holding the Certificate of Registration for all of the types of work or crafts in which the bidder is a participant and that will be performed with the bidder's forces. Types of work or craft work that will be subcontracted shall be included and listed as subcontract work. The list shall also indicate any type of work or craft job category that does not have an applicable apprenticeship or training program. **The bidder is responsible for making a complete report and shall make certain that each type of work or craft job category that will be utilized on the project as reported on the Construction Employee Workforce Projection (Form BC-1256) and returned with the bid is accounted for and listed.**

**NA-FEDERAL**

---

---

---

The requirements of this certification and disclosure are a material part of the contract, and the contractor shall require this certification provision to be included in all approved subcontracts. In order to fulfill this requirement, it shall not be necessary that an applicable program sponsor be currently taking or that it will take applications for apprenticeship, training or employment during the performance of the work of this contract.

**RETURN WITH BID**

**L. Political Contributions and Registration with the State Board of Elections**

Sections 20-160 and 50-37 of the Code regulate political contributions from business entities and any affiliated entities or affiliated persons bidding on or contracting with the state. Generally under Section 50-37, any business entity, and any affiliated entity or affiliated person of the business entity, whose current year contracts with all state agencies exceed an awarded value of \$50,000, are prohibited from making any contributions to any political committees established to promote the candidacy of the officeholder responsible for the awarding of the contracts or any other declared candidate for that office for the duration of the term of office of the incumbent officeholder or a period 2 years after the termination of the contract, whichever is longer. Any business entity and affiliated entities or affiliated persons whose state contracts in the current year do not exceed an awarded value of \$50,000, but whose aggregate pending bids and proposals on state contracts exceed \$50,000, either alone or in combination with contracts not exceeding \$50,000, are prohibited from making any political contributions to any political committee established to promote the candidacy of the officeholder responsible for awarding the pending contract during the period beginning on the date the invitation for bids or request for proposals is issued and ending on the day after the date of award or selection if the entity was not awarded or selected. Section 20-160 requires certification of registration of affected business entities in accordance with procedures found in Section 9-35 of The Election Code.

By submission of a bid, the contractor business entity acknowledges and agrees that it has read and understands Sections 20-160 and 50-37 of the Code, and that it makes the following certification:

**The undersigned bidder certifies that it has registered as a business with the State Board of Elections and acknowledges a continuing duty to update the registration in accordance with the above referenced statutes. If the business entity is required to register, the CPO shall verify that it is in compliance on the date the bid or proposal is due. The CPO shall not accept a bid or proposal if the business entity is not in compliance with the registration requirements.**

These requirements and compliance with the above referenced statutory sections are a material part of the contract, and any breach thereof shall be cause to void the contract under Section 50-60 of the Code. This provision does not apply to Federal-aid contracts.

**M. Lobbyist Disclosure**

Section 50-38 of the Code requires that any bidder or offeror on a State contract that hires a person required to register under the Lobbyist Registration Act to assist in obtaining a contract shall:

- (i) Disclose all costs, fees, compensation, reimbursements, and other remunerations paid or to be paid to the lobbyist related to the contract,
- (ii) Not bill or otherwise cause the State of Illinois to pay for any of the lobbyist's costs, fees, compensation, reimbursements, or other remuneration, and
- (iii) Sign a verification certifying that none of the lobbyist's costs, fees, compensation, reimbursements, or other remuneration were billed to the State.

This information, along with all supporting documents, shall be filed with the agency awarding the contract and with the Secretary of State. The CPO shall post this information, together with the contract award notice, in the online Procurement Bulletin.

Pursuant to Subsection (c) of this Section, no person or entity shall retain a person or entity to attempt to influence the outcome of a procurement decision made under the Code for compensation contingent in whole or in part upon the decision or procurement. Any person who violates this subsection is guilty of a business offense and shall be fined not more than \$10,000.

Bidder acknowledges that it is required to disclose the hiring of any person required to register pursuant to the Illinois Lobbyist Registration Act (25 ILCS 170) in connection with this contract.

Bidder has not hired any person required to register pursuant to the Illinois Lobbyist Registration Act in connection with this contract.

Or

Bidder has hired the following persons required to register pursuant to the Illinois Lobbyist Registration Act in connection with the contract:

Name and address of person: \_\_\_\_\_  
All costs, fees, compensation, reimbursements and other remuneration paid to said person: \_\_\_\_\_  
\_\_\_\_\_  
\_\_\_\_\_

I acknowledge, understand and accept these terms and conditions for the above certifications.

## RETURN WITH BID

### IV. DISCLOSURES

- A. The disclosures hereinafter made by the bidder are each a material representation of fact upon which reliance is placed should the Department enter into the contract with the bidder. The bidder further certifies that the Department has received the disclosure forms for each bid.

The CPO may void the bid, or contract, respectively, if it is later determined that the bidder or subcontractor rendered a false or erroneous disclosure. A contractor or subcontractor may be suspended or debarred for violations of the Code. Furthermore, the CPO may void the contract and the surety providing the performance bond shall be responsible for completion of the contract.

### B. Financial Interests and Conflicts of Interest

1. Section 50-35 of the Code provides that all bids of more than \$25,000 shall be accompanied by disclosure of the financial interests of the bidder. This disclosed information for the successful bidder, will be maintained as public information subject to release by request pursuant to the Freedom of Information Act, filed with the Procurement Policy Board, and shall be incorporated as a material term of the contract. Furthermore, pursuant to Section 5-5, the Procurement Policy Board may review a proposal, bid, or contract and issue a recommendation to void a contract or reject a proposal or bid based on any violation of the Code or the existence of a conflict of interest as provided in subsections (b) and (d) of Section 50-35.

The financial interests to be disclosed shall include ownership or distributive income share that is in excess of 5%, or an amount greater than 60% of the annual salary of the Governor, of the bidding entity or its parent entity, whichever is less, unless the contractor or bidder is a publicly traded entity subject to Federal 10K reporting, in which case it may submit its 10K disclosure in place of the prescribed disclosure. If a bidder is a privately held entity that is exempt from Federal 10K reporting, but has more than 200 shareholders, it may submit the information that Federal 10K companies are required to report, and list the names of any person or entity holding any ownership share that is in excess of 5%. The disclosure shall include the names, addresses, and dollar or proportionate share of ownership of each person making the disclosure, their instrument of ownership or beneficial relationship, and notice of any potential conflict of interest resulting from the current ownership or beneficial interest of each person making the disclosure having any of the relationships identified in Section 50-35 and on the disclosure form.  
**The current annual salary of the Governor is \$177,412.00.**

In addition, all disclosures shall indicate any other current or pending contracts, proposals, leases, or other ongoing procurement relationships the bidding entity has with any other unit of state government and shall clearly identify the unit and the contract, proposal, lease, or other relationship.

2. Disclosure Forms. Disclosure Form A is attached for use concerning the individuals meeting the above ownership or distributive share requirements. A separate Disclosure Form A must be submitted with the bid for each individual meeting the above requirements. In addition, a second form (Disclosure Form B) provides for the disclosure of current or pending procurement relationships with other (non-IDOT) state agencies and a total ownership certification. **The forms must be included with each bid.**

### C. Disclosure Form Instructions

#### Form A Instructions for Financial Information & Potential Conflicts of Interest

If the bidder is a publicly traded entity subject to Federal 10K reporting, the 10K Report may be submitted to meet the requirements of Form A. If a bidder is a privately held entity that is exempt from Federal 10K reporting, but has more than 200 shareholders, it may submit the information that Federal 10K companies are required to report, and list the names of any person or entity holding any ownership share that is in excess of 5%. If a bidder is not subject to Federal 10K reporting, the bidder must determine if any individuals are required by law to complete a financial disclosure form. To do this, the bidder should answer each of the following questions. A "YES" answer indicates Form A must be completed. If the answer to each of the following questions is "NO", then the NOT APPLICABLE STATEMENT on Form A must be signed and dated by a person that is authorized to execute contracts for the bidding company. Note: These questions are for assistance only and are not required to be completed.

1. Does anyone in your organization have a direct or beneficial ownership share of greater than 5% of the bidding entity or parent entity? YES \_\_\_ NO \_\_\_
2. Does anyone in your organization have a direct or beneficial ownership share of less than 5%, but which has a value greater than 60% of the annual salary of the Governor? YES \_\_\_ NO \_\_\_
3. Does anyone in your organization receive more than 60% of the annual salary of the Governor of the bidding entity's or parent entity's distributive income? YES \_\_\_ NO \_\_\_
4. Does anyone in your organization receive greater than 5% of the bidding entity's or parent entity's total distributive income, but which is less than 60% of the annual salary of the Governor? YES \_\_\_ NO \_\_\_

(Note: Only one set of forms needs to be completed per person per bid even if a specific individual would require a yes answer to more than one question.)

A "YES" answer to any of these questions requires the completion of Form A. The bidder must determine each individual in the bidding entity or the bidding entity's parent company that would cause the questions to be answered "Yes". Each form must be signed and dated by a person that is authorized to execute contracts for your organization. **Photocopied or stamped signatures are not acceptable.** The person signing can be, but does not have to be, the person for which the form is being completed. The bidder is responsible for the accuracy of any information provided.

If the answer to each of the above questions is "NO", then the NOT APPLICABLE STATEMENT of Form A must be signed and dated by a person that is authorized to execute contracts for your company.

## RETURN WITH BID

### **Form B: Instructions for Identifying Other Contracts & Procurement Related Information**

Disclosure Form B must be completed for each bid submitted by the bidding entity. *Note: Checking the NOT APPLICABLE STATEMENT on Form A does not allow the bidder to ignore Form B. Form B must be completed, checked, and dated or the bidder may be considered nonresponsive and the bid will not be accepted.*

The Bidder shall identify, by checking Yes or No on Form B, whether it has any pending contracts (including leases), bids, proposals, or other ongoing procurement relationship with any other (non-IDOT) State of Illinois agency. If "No" is checked, the bidder only needs to complete the check box on the bottom of Form B. If "Yes" is checked, the bidder must do one of the following:

Option I: If the bidder did not submit an Affidavit of Availability to obtain authorization to bid, the bidder must list all non-IDOT State of Illinois agency pending contracts, leases, bids, proposals, and other ongoing procurement relationships. These items may be listed on Form B or on an attached sheet(s). Do not include IDOT contracts. Contracts with cities, counties, villages, etc. are not considered State of Illinois agency contracts and are not to be included. Contracts with other State of Illinois agencies such as the Department of Natural Resources or the Capital Development Board must be included. Bidders who submit Affidavits of Availability are suggested to use Option II.

Option II: If the bidder is required and has submitted an Affidavit of Availability in order to obtain authorization to bid, the bidder may write or type "See Affidavit of Availability" which indicates that the Affidavit of Availability is incorporated by reference and includes all non-IDOT State of Illinois agency pending contracts, leases, bids, proposals, and other ongoing procurement relationships. For any contracts that are not covered by the Affidavit of Availability, the bidder must identify them on Form B or on an attached sheet(s). These might be such things as leases.

RETURN WITH BID

ILLINOIS DEPARTMENT OF TRANSPORTATION

Form A Financial Information & Potential Conflicts of Interest Disclosure

Contractor Name, Legal Address, City, State, Zip, Telephone Number, Email Address, Fax Number (if available)

Disclosure of the information contained in this Form is required by the Section 50-35 of the Code (30 ILCS 500). Vendors desiring to enter into a contract with the State of Illinois must disclose the financial information and potential conflict of interest information as specified in this Disclosure Form. This information shall become part of the publicly available contract file. This Form A must be completed for bids in excess of \$25,000, and for all open-ended contracts. A publicly traded company may submit a 10K disclosure (or equivalent if applicable) in satisfaction of the requirements set forth in Form A. See Disclosure Form Instructions.

The current annual salary of the Governor is \$177,412.00.

DISCLOSURE OF FINANCIAL INFORMATION

- 1. Disclosure of Financial Information. The individual named below has an interest in the BIDDER (or its parent) in terms of ownership or distributive income share in excess of 5%, or an interest which has a value of more than 60% of the annual salary of the Governor. (Make copies of this form as necessary and attach a separate Disclosure Form A for each individual meeting these requirements)

FOR INDIVIDUAL (type or print information) NAME: ADDRESS Type of ownership/distributable income share: stock sole proprietorship Partnership other: (explain on separate sheet): % or \$ value of ownership/distributable income share:

- 2. Disclosure of Potential Conflicts of Interest. Check "Yes" or "No" to indicate which, if any, of the following potential conflict of interest relationships apply. If the answer to any question is "Yes", please attach additional pages and describe.

(a) State employment, currently or in the previous 3 years, including contractual employment of services. Yes \_\_\_ No \_\_\_

If your answer is yes, please answer each of the following questions.

- 1. Are you currently an officer or employee of either the Capitol Development Board or the Illinois State Toll Highway Authority? Yes \_\_\_ No \_\_\_
2. Are you currently appointed to or employed by any agency of the State of Illinois? If you are currently appointed to or employed by any agency of the State of Illinois, and your annual salary exceeds 60% of the annual salary of the Governor provide the name the State agency for which you are employed and your annual salary.

**RETURN WITH BID**

3. If you are currently appointed to or employed by any agency of the State of Illinois, and your annual salary exceeds 60% of the annual salary of the Governor, are you entitled to receive (i) more than 7 1/2% of the total distributable income of your firm, partnership, association or corporation, or (ii) an amount in excess of 100% of the annual salary of the Governor? Yes \_\_\_ No \_\_\_
4. If you are currently appointed to or employed by any agency of the State of Illinois, and your annual salary exceeds 60% of the annual salary of the Governor, are you and your spouse or minor children entitled to receive (i) more than 15% in aggregate of the total distributable income of your firm, partnership, association or corporation, or (ii) an amount in excess of two times the salary of the Governor? Yes \_\_\_ No \_\_\_

---

(b) State employment of spouse, father, mother, son, or daughter, including contractual employment for services in the previous 2 years.

Yes \_\_\_ No \_\_\_

If your answer is yes, please answer each of the following questions.

1. Is your spouse or any minor children currently an officer or employee of the Capitol Development Board or the Illinois State Toll Highway Authority? Yes \_\_\_ No \_\_\_
2. Is your spouse or any minor children currently appointed to or employed by any agency of the State of Illinois? If your spouse or minor children is/are currently appointed to or employed by any agency of the State of Illinois, and his/her annual salary exceeds 60% of the annual salary of the Governor, provide the name of the spouse and/or minor children, the name of the State agency for which he/she is employed and his/her annual salary. \_\_\_\_\_
- 
3. If your spouse or any minor children is/are currently appointed to or employed by any agency of the State of Illinois, and his/her annual salary exceeds 60% of the annual salary of the Governor, are you entitled to receive (i) more than 7 1/2% of the total distributable income of your firm, partnership, association or corporation, or (ii) an amount in excess 100% of the annual salary of the Governor? Yes \_\_\_ No \_\_\_
4. If your spouse or any minor children are currently appointed to or employed by any agency of the State of Illinois, and his/her annual salary exceeds 60% of the annual salary of the Governor, are you and your spouse or any minor children entitled to receive (i) more than 15% in the aggregate of the total distributable income from your firm, partnership, association or corporation, or (ii) an amount in excess of two times the salary of the Governor? Yes \_\_\_ No \_\_\_

---

(c) Elective status; the holding of elective office of the State of Illinois, the government of the United States, any unit of local government authorized by the Constitution of the State of Illinois or the statutes of the State of Illinois currently or in the previous 3 years. Yes \_\_\_ No \_\_\_

---

(d) Relationship to anyone holding elective office currently or in the previous 2 years; spouse, father, mother, son, or daughter. Yes \_\_\_ No \_\_\_

---

(e) Appointive office; the holding of any appointive government office of the State of Illinois, the United State of America, or any unit of local government authorized by the Constitution of the State of Illinois or the statutes of the State of Illinois, which office entitles the holder to compensation in excess of the expenses incurred in the discharge of that office currently or in the previous 3 years. Yes \_\_\_ No \_\_\_

---

(f) Relationship to anyone holding appointive office currently or in the previous 2 years; spouse, father, mother, son, or daughter. Yes \_\_\_ No \_\_\_

---

(g) Employment, currently or in the previous 3 years, as or by any registered lobbyist of the State government. Yes \_\_\_ No \_\_\_

---

**RETURN WITH BID**

(h) Relationship to anyone who is or was a registered lobbyist in the previous 2 years; spouse, father, mother, son, or daughter. Yes \_\_\_ No \_\_\_

---

(i) Compensated employment, currently or in the previous 3 years, by any registered election or reelection committee registered with the Secretary of State or any county clerk of the State of Illinois, or any political action committee registered with either the Secretary of State or the Federal Board of Elections. Yes \_\_\_ No \_\_\_

---

(j) Relationship to anyone; spouse, father, mother, son, or daughter; who was a compensated employee in the last 2 years by any registered election or re-election committee registered with the Secretary of State or any county clerk of the State of Illinois, or any political action committee registered with either the Secretary of State or the Federal Board of Elections. Yes \_\_\_ No \_\_\_

---

**3. Communication Disclosure.**

Disclose the name and address of each lobbyist and other agent of the bidder or offeror who is not identified in Section 2 of this form, who is has communicated, is communicating, or may communicate with any State officer or employee concerning the bid or offer. This disclosure is a continuing obligation and must be promptly supplemented for accuracy throughout the process and throughout the term of the contract. If no person is identified, enter "None" on the line below:

Name and address of person(s): \_\_\_\_\_  
\_\_\_\_\_  
\_\_\_\_\_  
\_\_\_\_\_



**RETURN WITH BID**

**4. Debarment Disclosure.** For each of the persons identified under Sections 2 and 3 of this form, disclose whether any of the following has occurred within the previous 10 years: debarment from contracting with any governmental entity; professional licensure discipline; bankruptcies; adverse civil judgments and administrative findings; and criminal felony convictions. This disclosure is a continuing obligation and must be promptly supplemented for accuracy throughout the procurement process and term of the contract. If no person is identified, enter "None" on the line below:

Name of person(s): \_\_\_\_\_

Nature of disclosure: \_\_\_\_\_  
\_\_\_\_\_  
\_\_\_\_\_

**APPLICABLE STATEMENT**

**This Disclosure Form A is submitted on behalf of the INDIVIDUAL named on previous page. Under penalty of perjury, I certify the contents of this disclosure to be true and accurate to the best of my knowledge.**

Completed by:  \_\_\_\_\_  
Signature of Individual or Authorized Representative Date

**NOT APPLICABLE STATEMENT**

**Under penalty of perjury, I have determined that no individuals associated with this organization meet the criteria that would require the completion of this Form A.**

**This Disclosure Form A is submitted on behalf of the CONTRACTOR listed on the previous page.**

\_\_\_\_\_  
Signature of Authorized Representative Date

The bidder has a continuing obligation to supplement these disclosures under Sec. 50-35 of the Code.

RETURN WITH BID

ILLINOIS DEPARTMENT OF TRANSPORTATION

Form B Other Contracts & Financial Related Information Disclosure

Contractor Name, Legal Address, City, State, Zip, Telephone Number, Email Address, Fax Number (if available)

Disclosure of the information contained in this Form is required by the Section 50-35 of the Code (30 ILCS 500). This information shall become part of the publicly available contract file. This Form B must be completed for bids in excess of \$25,000, and for all open-ended contracts.

DISCLOSURE OF OTHER CONTRACTS AND PROCUREMENT RELATED INFORMATION

1. Identifying Other Contracts & Procurement Related Information. The BIDDER shall identify whether it has any pending contracts (including leases), bids, proposals, or other ongoing procurement relationship with any other State of Illinois agency: Yes \_\_\_ No \_\_\_

If "No" is checked, the bidder only needs to complete the signature box on the bottom of this page.

2. If "Yes" is checked. Identify each such relationship by showing State of Illinois agency name and other descriptive information such as bid or project number (attach additional pages as necessary). SEE DISCLOSURE FORM INSTRUCTIONS:

THE FOLLOWING STATEMENT MUST BE CHECKED

Signature of Authorized Representative, Date

OWNERSHIP CERTIFICATION

Please certify that the following statement is true if the individuals for all submitted Form A disclosures do not total 100% of ownership.

Any remaining ownership interest is held by individuals receiving less than \$106,447.20 of the bidding entity's or parent entity's distributive income or holding less than a 5% ownership interest.

Yes No N/A (Form A disclosure(s) established 100% ownership)

## **RETURN WITH BID**

### **SPECIAL NOTICE TO CONTRACTORS**

The following requirements of the Illinois Department of Human Rights' Rules and Regulations are applicable to bidders on all construction contracts advertised by the Illinois Department of Transportation:

#### **CONSTRUCTION EMPLOYEE UTILIZATION PROJECTION**

- (a) All bidders on construction contracts shall complete and submit, along with and as part of their bids, a Bidder's Employee Utilization Form (Form BC-1256) setting forth a projection and breakdown of the total workforce intended to be hired and/or allocated to such contract work by the bidder including a projection of minority and female employee utilization in all job classifications on the contract project.
- (b) The Department of Transportation shall review the Employee Utilization Form, and workforce projections contained therein, of the contract awardee to determine if such projections reflect an underutilization of minority persons and/or women in any job classification in accordance with the Equal Employment Opportunity Clause and Section 7.2 of the Illinois Department of Human Rights' Rules and Regulations for Public Contracts adopted as amended on September 17, 1980. If it is determined that the contract awardee's projections reflect an underutilization of minority persons and/or women in any job classification, it shall be advised in writing of the manner in which it is underutilizing and such awardee shall be considered to be in breach of the contract unless, prior to commencement of work on the contract project, it submits revised satisfactory projections or an acceptable written affirmative action plan to correct such underutilization including a specific timetable geared to the completion stages of the contract.
- (c) The Department of Transportation shall provide to the Department of Human Rights a copy of the contract awardee's Employee Utilization Form, a copy of any required written affirmative action plan, and any written correspondence related thereto. The Department of Human Rights may review and revise any action taken by the Department of Transportation with respect to these requirements.



**RETURN WITH BID**

**Contract No. 76G67  
 CLINTON County  
 Section (20,21)-J  
 Project ACHSIP-0327(059)  
 Route FAP 327  
 District 8 Construction Funds**

**PART I. IDENTIFICATION**

Dept. Human Rights # \_\_\_\_\_ Duration of Project: \_\_\_\_\_

Name of Bidder: \_\_\_\_\_

**PART II. WORKFORCE PROJECTION**

A. The undersigned bidder has analyzed minority group and female populations, unemployment rates and availability of workers for the location in which this contract work is to be performed, and for the locations from which the bidder recruits employees, and hereby submits the following workforce projection including a projection for minority and female employee utilization in all job categories in the workforce to be allocated to this contract:

**TABLE A**

TOTAL Workforce Projection for Contract													
JOB CATEGORIES	TOTAL EMPLOYEES		MINORITY EMPLOYEES						TRAINEES				
			BLACK		HISPANIC		*OTHER MINOR.		APPREN- TICES		ON THE JOB TRAINEES		
	M	F	M	F	M	F	M	F	M	F	M	F	
OFFICIALS (MANAGERS)													
SUPERVISORS													
FOREMEN													
CLERICAL													
EQUIPMENT OPERATORS													
MECHANICS													
TRUCK DRIVERS													
IRONWORKERS													
CARPENTERS													
CEMENT MASONS													
ELECTRICIANS													
PIPEFITTERS, PLUMBERS													
PAINTERS													
LABORERS, SEMI-SKILLED													
LABORERS, UNSKILLED													
TOTAL													

**TABLE B**

CURRENT EMPLOYEES TO BE ASSIGNED TO CONTRACT			
TOTAL EMPLOYEES		MINORITY EMPLOYEES	
M	F	M	F

**TABLE C**

TOTAL Training Projection for Contract								
EMPLOYEES IN TRAINING	TOTAL EMPLOYEES		BLACK		HISPANIC		*OTHER MINOR.	
	M	F	M	F	M	F	M	F
APPRENTICES								
ON THE JOB TRAINEES								

\*Other minorities are defined as Asians (A) or Native Americans (N). Please specify race of each employee shown in Other Minorities column.

**FOR DEPARTMENT USE ONLY**

**Note: See instructions on page 2**

**RETURN WITH BID**

**Contract No. 76G67  
CLINTON County  
Section (20,21)-J  
Project ACHSIP-0327(059)  
Route FAP 327  
District 8 Construction Funds**

**PART II. WORKFORCE PROJECTION - continued**

- B. Included in "Total Employees" under Table A is the total number of **new hires** that would be employed in the event the undersigned bidder is awarded this contract.

The undersigned bidder projects that: (number) \_\_\_\_\_ new hires would be recruited from the area in which the contract project is located; and/or (number) \_\_\_\_\_ new hires would be recruited from the area in which the bidder's principal office or base of operation is located.

- C. Included in "Total Employees" under Table A is a projection of numbers of persons to be employed directly by the undersigned bidder as well as a projection of numbers of persons to be employed by subcontractors.

The undersigned bidder estimates that (number) \_\_\_\_\_ persons will be directly employed by the prime contractor and that (number) \_\_\_\_\_ persons will be employed by subcontractors.

**PART III. AFFIRMATIVE ACTION PLAN**

- A. The undersigned bidder understands and agrees that in the event the foregoing minority and female employee utilization projection included under **PART II** is determined to be an underutilization of minority persons or women in any job category, and in the event that the undersigned bidder is awarded this contract, he/she will, prior to commencement of work, develop and submit a written Affirmative Action Plan including a specific timetable (geared to the completion stages of the contract) whereby deficiencies in minority and/or female employee utilization are corrected. Such Affirmative Action Plan will be subject to approval by the contracting agency and the **Department of Human Rights**.
- B. The undersigned bidder understands and agrees that the minority and female employee utilization projection submitted herein, and the goals and timetable included under an Affirmative Action Plan if required, are deemed to be part of the contract specifications.

Company \_\_\_\_\_ Telephone Number \_\_\_\_\_

Address \_\_\_\_\_

**NOTICE REGARDING SIGNATURE**

The Bidder's signature on the Proposal Signature Sheet will constitute the signing of this form. The following signature block needs to be completed only if revisions are required.

Signature:  \_\_\_\_\_ Title: \_\_\_\_\_ Date: \_\_\_\_\_

- Instructions: All tables must include subcontractor personnel in addition to prime contractor personnel.
- Table A - Include both the number of employees that would be hired to perform the contract work and the total number currently employed (Table B) that will be allocated to contract work, and include all apprentices and on-the-job trainees. The "Total Employees" column should include all employees including all minorities, apprentices and on-the-job trainees to be employed on the contract work.
- Table B - Include all employees currently employed that will be allocated to the contract work including any apprentices and on-the-job trainees currently employed.
- Table C - Indicate the racial breakdown of the total apprentices and on-the-job trainees shown in Table A.

**RETURN WITH BID**

**ADDITIONAL FEDERAL REQUIREMENTS**

In addition to the Required Contract Provisions for Federal-Aid Construction Contracts (FHWA 1273), all bidders make the following certifications.

- A. By the execution of this proposal, the signing bidder certifies that the bidding entity has not, either directly or indirectly, entered into any agreement, participated in any collusion, or otherwise taken any action, in restraint of free competitive bidding in connection with the submitted bid. This statement made by the undersigned bidder is true and correct under penalty of perjury under the laws of the United States.
- B. CERTIFICATION, EQUAL EMPLOYMENT OPPORTUNITY:
1. Have you participated in any previous contracts or subcontracts subject to the equal opportunity clause. YES \_\_\_\_\_ NO \_\_\_\_\_
  2. If answer to #1 is yes, have you filed with the Joint Reporting Committee, the Director of OFCC, any Federal agency, or the former President's Committee on Equal Employment Opportunity, all reports due under the applicable filing requirements of those organizations? YES \_\_\_\_\_ NO \_\_\_\_\_

**RETURN WITH BID**

**Contract No. 76G67  
CLINTON County  
Section (20,21)-J  
Project ACHSIP-0327(059)  
Route FAP 327  
District 8 Construction Funds**

PROPOSAL SIGNATURE SHEET

The undersigned bidder hereby makes and submits this bid on the subject Proposal, thereby assuring the Department that all requirements of the Invitation for Bids and rules of the Department have been met, that there is no misunderstanding of the requirements of paragraph 3 of this Proposal, and that the contract will be executed in accordance with the rules of the Department if an award is made on this bid.

(IF AN INDIVIDUAL)

Firm Name \_\_\_\_\_  
Signature of Owner \_\_\_\_\_  
Business Address \_\_\_\_\_  
\_\_\_\_\_

(IF A CO-PARTNERSHIP)

Firm Name \_\_\_\_\_  
By \_\_\_\_\_  
Business Address \_\_\_\_\_  
Name and Address of All Members of the Firm: \_\_\_\_\_  
\_\_\_\_\_

(IF A CORPORATION)

Corporate Name \_\_\_\_\_  
By \_\_\_\_\_  
Signature of Authorized Representative \_\_\_\_\_  
Typed or printed name and title of Authorized Representative \_\_\_\_\_  
Attest \_\_\_\_\_  
Signature \_\_\_\_\_  
(IF A JOINT VENTURE, USE THIS SECTION FOR THE MANAGING PARTY AND THE SECOND PARTY SHOULD SIGN BELOW)  
Business Address \_\_\_\_\_

(IF A JOINT VENTURE)

Corporate Name \_\_\_\_\_  
By \_\_\_\_\_  
Signature of Authorized Representative \_\_\_\_\_  
Typed or printed name and title of Authorized Representative \_\_\_\_\_  
Attest \_\_\_\_\_  
Signature \_\_\_\_\_  
Business Address \_\_\_\_\_

If more than two parties are in the joint venture, please attach an additional signature sheet.



**Illinois Department of Transportation**

**Return with Bid**  
(If Applicable)

**Division of Highways**  
**Annual Proposal Bid Bond**

This Annual Proposal Bid Bond shall become effective at 12:01 AM (CDST) on \_\_\_\_\_ and shall be valid until \_\_\_\_\_ 11:59 PM (CDST).

KNOW ALL MEN BY THESE PRESENTS, That We \_\_\_\_\_

as PRINCIPAL, and \_\_\_\_\_

as SURETY, and held jointly, severally and firmly bound unto the STATE OF ILLINOIS in the penal sum of 5 percent of the total bid price, or for the amount specified in the bid proposal under "Proposal Guaranty" in effect on the date of the Invitation for Bids, whichever is the lesser sum, well and truly to be paid unto said STATE OF ILLINOIS, for the payment of which we bind ourselves, our heirs, executors, administrators, successors and assigns.

THE CONDITION OF THE FOREGOING OBLIGATION IS SUCH that whereas, the PRINCIPAL may submit bid proposal(s) to the STATE OF ILLINOIS, acting through the Department of Transportation, for various improvements published in the Transportation Bulletin during the effective term indicated above.

NOW, THEREFORE, if the Department shall accept the bid proposal(s) of the PRINCIPAL; and if the PRINCIPAL shall, within the time and as specified in the bidding and contract documents; and if, after award by the Department, the PRINCIPAL shall enter into a contract in accordance with the terms of the bidding and contract documents including evidence of the required insurance coverages and providing such bond as specified with good and sufficient surety for the faithful performance of such contract and for the prompt payment of labor and material furnished in the prosecution thereof; or if, in the event of the failure of the PRINCIPAL to enter into such contract and to give the specified bond, the PRINCIPAL pays to the Department the difference not to exceed the penalty hereof between the amount specified in the bid proposal and such larger amount for which the Department may contract with another party to perform the work covered by said bid proposal, then this obligation shall be null and void, otherwise, it shall remain in full force and effect.

IN THE EVENT the Department determines the PRINCIPAL has failed to comply with any requirement as set forth in the preceding paragraph, then Surety shall pay the penal sum to the Department within fifteen (15) days of written demand therefor. If Surety does not make full payment within such period of time, the Department may bring an action to collect the amount owed. Surety is liable to the Department for all its expenses, including attorney's fees, incurred in any litigation in which it prevails either in whole or in part.

In TESTIMONY WHEREOF, the said PRINCIPAL has caused this instrument to be signed by its officer \_\_\_\_\_ day of \_\_\_\_\_ A.D., \_\_\_\_\_.

In TESTIMONY WHEREOF, the said SURETY has caused this instrument to be signed by its officer \_\_\_\_\_ day of \_\_\_\_\_ A.D., \_\_\_\_\_.

\_\_\_\_\_  
(Company Name)

\_\_\_\_\_  
(Company Name)

By \_\_\_\_\_  
(Signature and Title)

By \_\_\_\_\_  
(Signature of Attorney-in-Fact)

**Notary for PRINCIPAL**

**Notary for SURETY**

STATE OF \_\_\_\_\_  
COUNTY OF \_\_\_\_\_

STATE OF \_\_\_\_\_  
COUNTY OF \_\_\_\_\_

Signed and attested before me on \_\_\_\_\_ (date)  
by \_\_\_\_\_

Signed and attested before me on \_\_\_\_\_ (date)  
by \_\_\_\_\_

(Name of Person)

(Name of Person)

(Seal) \_\_\_\_\_  
(Signature of Notary Public)

(Seal) \_\_\_\_\_  
(Signature of Notary Public)

\_\_\_\_\_  
(Date Commission Expires)

\_\_\_\_\_  
(Date Commission Expires)

In lieu of completing the above section of the Annual Proposal Bid Bond form, the Principal may file an Electronic Bid Bond. By signing the proposal(s) the Principal is ensuring the identified electronic bid bond has been executed and the Principal and Surety are firmly bound unto the State of Illinois under the conditions of the bid bond as shown above.

Electronic Bid Bond ID # \_\_\_\_\_ Company/Bidder Name \_\_\_\_\_ Signature and Title \_\_\_\_\_





Item No. \_\_\_\_\_

Letting Date \_\_\_\_\_

KNOW ALL PERSONS BY THESE PRESENTS, That We \_\_\_\_\_

as PRINCIPAL, and \_\_\_\_\_

as SURETY, and held jointly, severally and firmly bound unto the STATE OF ILLINOIS in the penal sum of 5 percent of the total bid price, or for the amount specified in the bid proposal under "Proposal Guaranty" in effect on the date of the Invitation for Bids, whichever is the lesser sum, well and truly to be paid unto said STATE OF ILLINOIS, for the payment of which we bind ourselves, our heirs, executors, administrators, successors and assigns.

THE CONDITION OF THE FOREGOING OBLIGATION IS SUCH that whereas, the PRINCIPAL has submitted a bid proposal to the STATE OF ILLINOIS, acting through the Department of Transportation, for the improvement designated by the Transportation Bulletin Item Number and Letting Date indicated above.

NOW, THEREFORE, if the Department shall accept the bid proposal of the PRINCIPAL; and if the PRINCIPAL shall, within the time and as specified in the bidding and contract documents; and if, after award by the Department, the PRINCIPAL shall enter into a contract in accordance with the terms of the bidding and contract documents including evidence of the required insurance coverages and providing such bond as specified with good and sufficient surety for the faithful performance of such contract and for the prompt payment of labor and material furnished in the prosecution thereof; or if, in the event of the failure of the PRINCIPAL to enter into such contract and to give the specified bond, the PRINCIPAL pays to the Department the difference not to exceed the penalty hereof between the amount specified in the bid proposal and such larger amount for which the Department may contract with another party to perform the work covered by said bid proposal, then this obligation shall be null and void, otherwise, it shall remain in full force and effect.

IN THE EVENT the Department determines the PRINCIPAL has failed to comply with any requirement as set forth in the preceding paragraph, then Surety shall pay the penal sum to the Department within fifteen (15) days of written demand therefor. If Surety does not make full payment within such period of time, the Department may bring an action to collect the amount owed. Surety is liable to the Department for all its expenses, including attorney's fees, incurred in any litigation in which it prevails either in whole or in part.

In TESTIMONY WHEREOF, the said PRINCIPAL has caused this instrument to be signed by its officer \_\_\_\_\_ day of \_\_\_\_\_ A.D., \_\_\_\_\_ .

In TESTIMONY WHEREOF, the said SURETY has caused this instrument to be signed by its officer \_\_\_\_\_ day of \_\_\_\_\_ A.D., \_\_\_\_\_ .

\_\_\_\_\_  
(Company Name)

\_\_\_\_\_  
(Company Name)

By \_\_\_\_\_  
(Signature and Title)

By \_\_\_\_\_  
(Signature of Attorney-in-Fact)

**Notary for PRINCIPAL**

**Notary for SURETY**

STATE OF \_\_\_\_\_  
COUNTY OF \_\_\_\_\_

STATE OF \_\_\_\_\_  
COUNTY OF \_\_\_\_\_

Signed and attested before me on \_\_\_\_\_ (date)  
by \_\_\_\_\_

Signed and attested before me on \_\_\_\_\_ (date)  
by \_\_\_\_\_

(Name of Person)

(Name of Person)

(Seal) \_\_\_\_\_  
(Signature of Notary Public)

(Seal) \_\_\_\_\_  
(Signature of Notary Public)

\_\_\_\_\_  
(Date Commission Expires)

\_\_\_\_\_  
(Date Commission Expires)

In lieu of completing the above section of the Proposal Bid Bond form, the Principal may file an Electronic Bid Bond. By signing the proposal the Principal is ensuring the identified electronic bid bond has been executed and the Principal and Surety are firmly bound unto the State of Illinois under the conditions of the bid bond as shown above.

Electronic Bid Bond ID # \_\_\_\_\_ Company/Bidder Name \_\_\_\_\_ Signature and Title \_\_\_\_\_

**(1) Policy**

It is public policy that disadvantageded businesses as defined in 49 CFR Part 26 and the Special Provision shall have the maximum opportunity to participate in the performance of contracts financed in whole or in part with Federal or State funds. Consequently the requirements of 49 CFR Part 26 apply to this contract.

**(2) Obligation**

The contractor agrees to ensure that disadvantageded businesses as defined in 49 CFR Part 26 and the Special Provision have the maximum opportunity to participate in the performance of contracts or subcontracts financed in whole or in part with Federal or State funds. The contractor shall take all necessary and reasonable steps in accordance with 49 CFR Part 26 and the Special Provision to ensure that said businesses have the maximum opportunity to compete for and perform under this contract. The contractor shall not discriminate on the basis of race, color, national origin or sex in the award and performance of contracts.

**(3) Project and Bid Identification**

Complete the following information concerning the project and bid:

Route _____	Total Bid _____
Section _____	Contract DBE Goal _____ (Percent) _____ (Dollar Amount)
Project _____	
County _____	
Letting Date _____	
Contract No. _____	
Letting Item No. _____	

**(4) Assurance**

I, acting in my capacity as an officer of the undersigned bidder (or bidders if a joint venture), hereby assure the Department that on this project my company : (check one)

Meets or exceeds contract award goals and has provided documented participation as follows:  
Disadvantaged Business Participation \_\_\_\_\_ percent

Attached are the signed participation statements, forms SBE 2025, required by the Special Provision evidencing availability and use of each business participating in this plan and assuring that each business will perform a commercially useful function in the work of the contract.

Failed to meet contract award goals and has included good faith effort documentation to meet the goals and that my company has provided participation as follows:

Disadvantaged Business Participation \_\_\_\_\_ percent

The contract goals should be accordingly modified or waived. Attached is all information required by the Special Provision in support of this request including good faith effort. Also attached are the signed participation statements, forms SBE 2025, required by the Special Provision evidencing availability and use of each business participating in this plan and assuring that each business will perform a commercially useful function in the work of the contract.

\_\_\_\_\_  
Company

By \_\_\_\_\_

Title \_\_\_\_\_

Date \_\_\_\_\_

The "as read" Low Bidder is required to comply with the Special Provision.

Submit only one utilization plan for each project. The utilization plan shall be submitted in accordance with the special provision.

Bureau of Small Business Enterprises      **Local Let Projects**  
2300 South Dirksen Parkway                  Submit forms to the  
Springfield, Illinois 62764                      Local Agency



# Illinois Department of Transportation

## DBE Participation Statement

Subcontractor Registration \_\_\_\_\_

Letting \_\_\_\_\_

### Participation Statement

Item No. \_\_\_\_\_

#### (1) Instructions

Contract \_\_\_\_\_

This form must be completed for each disadvantaged business participating in the Utilization Plan. This form shall be submitted in accordance with the special provision and will be attached to the Utilization Plan form.. If additional space is needed complete an additional form for the firm.

#### (2) Work

Pay Item No.	Description	Quantity	Unit Price	Total
Total				

#### (3) Partial Payment Items

For any of the above items which are partial pay items, specifically describe the work and subcontract dollar amount:

#### (4) Commitment

The undersigned certify that the information included herein is true and correct, and that the DBE firm listed below has agreed to perform a commercially useful function in the work of the contract item(s) listed above and to execute a contract with the prime contractor. The undersigned further understand that no changes to this statement may be made without prior approval from the Department’s Bureau of Small Business Enterprises and that complete and accurate information regarding actual work performed on this project and the payment therefore must be provided to the Department.

Signature for Prime Contractor

Signature for DBE Firm

Title \_\_\_\_\_

Title \_\_\_\_\_

Date \_\_\_\_\_

Date \_\_\_\_\_

Contact \_\_\_\_\_

Contact Person \_\_\_\_\_

Phone \_\_\_\_\_

Phone \_\_\_\_\_

Firm Name \_\_\_\_\_

Firm Name \_\_\_\_\_

Address \_\_\_\_\_

Address \_\_\_\_\_

City/State/Zip \_\_\_\_\_

City/State/Zip \_\_\_\_\_

E \_\_\_\_\_

WC \_\_\_\_\_

The Department of Transportation is requesting disclosure of information that is necessary to accomplish the statutory purpose as outlined under the state and federal law. Disclosure of this information is REQUIRED. Failure to provide any information will result in the contract not being awarded. This form has been approved by the State Forms Management Center.

# PROPOSAL ENVELOPE



# PROPOSALS

for construction work advertised for bids by the  
Illinois Department of Transportation

Item No.	Item No.	Item No.

Submitted By:

Name:
Address:
Phone No.

Bidders should use an IDOT proposal envelope or affix this form to the front of a 10" x 13" envelope for the submittal of bids. If proposals are mailed, they should be enclosed in a second or outer envelope addressed to:

Engineer of Design and Environment - Room 326  
Illinois Department of Transportation  
2300 South Dirksen Parkway  
Springfield, Illinois 62764

## **NOTICE**

**Individual bids, including Bid Bond and/or supplemental information if required, should be securely stapled.**

# CONTRACTOR OFFICE COPY OF CONTRACT SPECIFICATIONS

## NOTICE

None of the following material needs to be returned with the bid package unless the special provisions require documentation and/or other information to be submitted.

**Contract No. 76G67  
CLINTON County  
Section (20,21)-J  
Project ACHSIP-0327(059)  
Route FAP 327  
District 8 Construction Funds**



**Illinois Department of Transportation**

## **SUBCONTRACTOR DOCUMENTATION**

Public Acts 96-0795, 96-0920, and 97-0895 enacted substantial changes to the provisions of the Code (30 ILCS 500). Among the changes are provisions affecting subcontractors. The Contractor awarded this contract will be required as a material condition of the contract to implement and enforce the contract requirements applicable to subcontractors that entered into a contractual agreement with a total value of \$50,000 or more with a person or entity who has a contract subject to the Code and approved in accordance with article 108.01 of the Standard Specifications for Road and Bridge Construction.

If the Contractor seeks approval of subcontractors to perform a portion of the work, and approval is granted by the Department, the Contractor shall provide a copy of the subcontract to the Illinois Department of Transportation's CPO upon request within 15 calendar days after execution of the subcontract.

Financial disclosures required pursuant to Sec. 50-35 of the Code must be submitted for all applicable subcontractors. The subcontract shall contain the certifications required to be made by subcontractors pursuant to Article 50 of the Code. This Notice to Bidders includes a document incorporating all required subcontractor certifications and disclosures for use by the Contractor in compliance with this mandate. The document is entitled State Required Ethical Standards Governing Subcontractors.

## RETURN WITH SUBCONTRACT

### STATE ETHICAL STANDARDS GOVERNING SUBCONTRACTORS

Article 50 of the Code establishes the duty of all State CPOs, SPOs, and their designees to maximize the value of the expenditure of public moneys in procuring goods, services, and contracts for the State of Illinois and to act in a manner that maintains the integrity and public trust of State government. In discharging this duty, they are charged by law to use all available information, reasonable efforts, and reasonable actions to protect, safeguard, and maintain the procurement process of the State of Illinois.

The certifications hereinafter made by the subcontractor are each a material representation of fact upon which reliance is placed should the Department approve the subcontractor. The CPO may terminate or void the contract approval if it is later determined that the bidder or subcontractor rendered a false or erroneous certification. If a false certification is made by a subcontractor the contractor's submitted bid and the executed contract may not be declared void unless the contractor refuses to terminate the subcontract upon the State's request after a finding that the subcontractor's certification was false.

Section 50-2 of the Code provides that every person that has entered into a multi-year contract and every subcontractor with a multi-year subcontract shall certify, by July 1 of each fiscal year covered by the contract after the initial fiscal year, to the responsible CPO whether it continues to satisfy the requirements of Article 50 pertaining to the eligibility for a contract award. If a contractor or subcontractor is not able to truthfully certify that it continues to meet all requirements, it shall provide with its certification a detailed explanation of the circumstances leading to the change in certification status. A contractor or subcontractor that makes a false statement material to any given certification required under Article 50 is, in addition to any other penalties or consequences prescribed by law, subject to liability under the Whistleblower Reward and Protection Act for submission of a false claim.

#### **A. Bribery**

Section 50-5. Bribery.

(a) Prohibition. No person or business shall be awarded a contract or subcontract under this Code who:

(1) has been convicted under the laws of Illinois or any other state of bribery or attempting to bribe an officer or employee of the State of Illinois or any other state in that officer's or employee's official capacity; or

(2) has made an admission of guilt of that conduct that is a matter of record but has not been prosecuted for that conduct.

(b) Businesses. No business shall be barred from contracting with any unit of State or local government, or subcontracting under such a contract, as a result of a conviction under this Section of any employee or agent of the business if the employee or agent is no longer employed by the business and:

(1) the business has been finally adjudicated not guilty; or

(2) the business demonstrates to the governmental entity with which it seeks to contract, or which is signatory to the contract to which the subcontract relates, and that entity finds that the commission of the offense was not authorized, requested, commanded, or performed by a director, officer, or high managerial agent on behalf of the business as provided in paragraph (2) of subsection (a) of Section 5-4 of the Criminal Code of 2012.

(c) Conduct on behalf of business. For purposes of this Section, when an official, agent, or employee of a business committed the bribery or attempted bribery on behalf of the business and in accordance with the direction or authorization of a responsible official of the business, the business shall be chargeable with the conduct.

(d) Certification. Every bid submitted to and contract executed by the State, and every subcontract subject to Section 20-120 of the Code shall contain a certification by the contractor or the subcontractor, respectively, that the contractor or subcontractor is not barred from being awarded a contract or subcontract under this Section and acknowledges that the CPO may declare the related contract void if any certifications required by this Section are false. A contractor who makes a false statement, material to the certification, commits a Class 3 felony.

The contractor or subcontractor certifies that it is not barred from being awarded a contract under Section 50.5.

#### **B. Felons**

Section 50-10. Felons.

(a) Unless otherwise provided, no person or business convicted of a felony shall do business with the State of Illinois or any State agency, or enter into a subcontract, from the date of conviction until 5 years after the date of completion of the sentence for that felony, unless no person held responsible by a prosecutorial office for the facts upon which the conviction was based continues to have any involvement with the business.

(b) Certification. Every bid submitted to and contract executed by the State and every subcontract subject to Section 20-120 of the Code shall contain a certification by the bidder or contractor or subcontractor, respectively, that the bidder, contractor, or subcontractor is not barred from being awarded a contract or subcontract under this Section and acknowledges that the CPO may declare the related contract void if any of the certifications required by this Section are false.

## RETURN WITH SUBCONTRACT

### C. Debt Delinquency

Section 50-11 and 50-12. Debt Delinquency.

The contractor or bidder or subcontractor, respectively, certifies that it, or any affiliate, is not barred from being awarded a contract or subcontract under the Code. Section 50-11 prohibits a person from entering into a contract with a State agency, or entering into a subcontract, if it knows or should know that it, or any affiliate, is delinquent in the payment of any debt to the State as defined by the Debt Collection Board. Section 50-12 prohibits a person from entering into a contract with a State agency, or entering into a subcontract, if it, or any affiliate, has failed to collect and remit Illinois Use Tax on all sales of tangible personal property into the State of Illinois in accordance with the provisions of the Illinois Use Tax Act. The bidder or contractor or subcontractor, respectively, further acknowledges that the CPO may declare the related contract void if this certification is false or if the bidder, contractor, or subcontractor, or any affiliate, is determined to be delinquent in the payment of any debt to the State during the term of the contract.

### D. Prohibited Bidders, Contractors and Subcontractors

Section 50-10.5 and 50-60(c). Prohibited bidders, contractors and subcontractors.

The bidder or contractor or subcontractor, respectively, certifies in accordance with 30 ILCS 500/50-10.5 that no officer, director, partner or other managerial agent of the contracting business has been convicted of a felony under the Sarbanes-Oxley Act of 2002 or a Class 3 or Class 2 felony under the Illinois Securities Law of 1953 or if in violation of Subsection (c) for a period of five years from the date of conviction. Every bid submitted to and contract executed by the State and every subcontract subject to Section 20-120 of the Code shall contain a certification by the bidder, contractor, or subcontractor, respectively, that the bidder, contractor, or subcontractor is not barred from being awarded a contract or subcontract under this Section and acknowledges that the CPO shall declare the related contract void if any of the certifications completed pursuant to this Section are false.

### E. Section 42 of the Environmental Protection Act

The bidder or contractor or subcontractor, respectively, certifies in accordance with 30 ILCS 500/50-14 that the bidder, contractor, or subcontractor, is not barred from being awarded a contract or entering into a subcontract under this Section which prohibits the bidding on or entering into contracts with the State of Illinois or a State agency, or entering into any subcontract, that is subject to the Code by a person or business found by a court or the Pollution Control Board to have committed a willful or knowing violation of Section 42 of the Environmental Protection Act for a period of five years from the date of the order. The bidder or contractor or subcontractor, respectively, acknowledges that the CPO may declare the contract void if this certification is false.

**The undersigned, on behalf of the subcontracting company, has read and understands the above certifications and makes the certifications as required by law.**

\_\_\_\_\_  
Name of Subcontracting Company

\_\_\_\_\_  
Authorized Officer

\_\_\_\_\_  
Date



**RETURN WITH SUBCONTRACT**  
**SUBCONTRACTOR DISCLOSURES**

**I. DISCLOSURES**

- A.** The disclosures hereinafter made by the subcontractor are each a material representation of fact upon which reliance is placed. The subcontractor further certifies that the Department has received the disclosure forms for each subcontract.

The CPO may void the bid, contract, or subcontract, respectively, if it is later determined that the bidder or subcontractor rendered a false or erroneous disclosure. A contractor or subcontractor may be suspended or debarred for violations of the Code. Furthermore, the CPO may void the contract.

**B. Financial Interests and Conflicts of Interest**

1. Section 50-35 of the Code provides that all subcontracts with a total value of \$50,000 or more, from subcontractors identified in Section 20-120 of the Code, shall be accompanied by disclosure of the financial interests of the subcontractor. This disclosed information for the subcontractor, will be maintained as public information subject to release by request pursuant to the Freedom of Information Act, filed with the Procurement Policy Board, and shall be incorporated as a material term of the Prime Contractor's contract. Furthermore, pursuant to this Section, the Procurement Policy Board may recommend to allow or void a contract or subcontract based on a potential conflict of interest.

The financial interests to be disclosed shall include ownership or distributive income share that is in excess of 5%, or an amount greater than 60% of the annual salary of the Governor, of the subcontracting entity or its parent entity, whichever is less, unless the subcontractor is a publicly traded entity subject to Federal 10K reporting, in which case it may submit its 10K disclosure in place of the prescribed disclosure. If a subcontractor is a privately held entity that is exempt from Federal 10K reporting, but has more than 200 shareholders, it may submit the information that Federal 10K companies are required to report, and list the names of any person or entity holding any ownership share that is in excess of 5%. The disclosure shall include the names, addresses, and dollar or proportionate share of ownership of each person making the disclosure, their instrument of ownership or beneficial relationship, and notice of any potential conflict of interest resulting from the current ownership or beneficial interest of each person making the disclosure having any of the relationships identified in Section 50-35 and on the disclosure form.

**The current annual salary of the Governor is \$177,412.00.**

In addition, all disclosures shall indicate any other current or pending contracts, subcontracts, proposals, leases, or other ongoing procurement relationships the subcontracting entity has with any other unit of state government and shall clearly identify the unit and the contract, subcontract, proposal, lease, or other relationship.

2. Disclosure Forms. Disclosure Form A is attached for use concerning the individuals meeting the above ownership or distributive share requirements. A separate Disclosure Form A must be submitted with the bid for each individual meeting the above requirements. In addition, a second form (Disclosure Form B) provides for the disclosure of current or pending procurement relationships with other (non-IDOT) state agencies and a total ownership certification. **The forms must be included with each bid.**

**C. Disclosure Form Instructions**

**Form A Instructions for Financial Information & Potential Conflicts of Interest**

If the subcontractor is a publicly traded entity subject to Federal 10K reporting, the 10K Report may be submitted to meet the requirements of Form A. If a subcontractor is a privately held entity that is exempt from Federal 10K reporting, but has more than 200 shareholders, it may submit the information that Federal 10K companies are required to report, and list the names of any person or entity holding any ownership share that is in excess of 5%. If a subcontractor is not subject to Federal 10K reporting, the subcontractor must determine if any individuals are required by law to complete a financial disclosure form. To do this, the subcontractor should answer each of the following questions. A "YES" answer indicates Form A must be completed. If the answer to each of the following questions is "NO", then the **NOT APPLICABLE STATEMENT** on the second page of Form A must be signed and dated by a person that is authorized to execute contracts for the subcontracting company. Note: These questions are for assistance only and are not required to be completed.

1. Does anyone in your organization have a direct or beneficial ownership share of greater than 5% of the bidding entity or parent entity? YES \_\_\_ NO \_\_\_
2. Does anyone in your organization have a direct or beneficial ownership share of less than 5%, but which has a value greater than 60% of the annual salary of the Governor? YES \_\_\_ NO \_\_\_
3. Does anyone in your organization receive more than 60% of the annual salary of the Governor of the subcontracting entity's or parent entity's distributive income? YES \_\_\_ NO \_\_\_

(Note: Distributive income is, for these purposes, any type of distribution of profits. An annual salary is not distributive income.)

4. Does anyone in your organization receive greater than 5% of the subcontracting entity's or parent entity's total distributive income, but which is less than 60% of the annual salary of the Governor? YES \_\_\_ NO \_\_\_

(Note: Only one set of forms needs to be completed per person per subcontract even if a specific individual would require a yes answer to more than one question.)

A "YES" answer to any of these questions requires the completion of Form A. The subcontractor must determine each individual in the subcontracting entity or the subcontracting entity's parent company that would cause the questions to be answered "Yes". Each form must be signed and dated by a person that is authorized to execute contracts for your organization. **Photocopied or stamped signatures are not acceptable.** The person signing can be, but does not have to be, the person for which the form is being completed. The subcontractor is responsible for the accuracy of any information provided.

If the answer to each of the above questions is "NO", then the **NOT APPLICABLE STATEMENT** on page 2 of Form A must be signed and dated by a person that is authorized to execute contracts for your company.

## RETURN WITH SUBCONTRACT

### **Form B: Instructions for Identifying Other Contracts & Procurement Related Information**

Disclosure Form B must be completed for each subcontract submitted by the subcontracting entity. *Note: Checking the NOT APPLICABLE STATEMENT on Form A does not allow the subcontractor to ignore Form B. Form B must be completed, checked, and dated or the subcontract will not be approved.*

The Subcontractor shall identify, by checking Yes or No on Form B, whether it has any pending contracts, subcontracts, leases, bids, proposals, or other ongoing procurement relationship with any other (non-IDOT) State of Illinois agency. If "No" is checked, the subcontractor only needs to complete the check box on the bottom of Form B. If "Yes" is checked, the subcontractor must list all non-IDOT State of Illinois agency pending contracts, subcontracts, leases, bids, proposals, and other ongoing procurement relationships. These items may be listed on Form B or on an attached sheet(s). Contracts with cities, counties, villages, etc. are not considered State of Illinois agency contracts and are not to be included. Contracts or subcontracts with other State of Illinois agencies such as the Department of Natural Resources or the Capital Development Board must be included.

RETURN WITH SUBCONTRACT

ILLINOIS DEPARTMENT OF TRANSPORTATION

Form A Subcontractor: Financial Information & Potential Conflicts of Interest Disclosure

Subcontractor Name, Legal Address, City, State, Zip, Telephone Number, Email Address, Fax Number (if available)

Disclosure of the information contained in this Form is required by the Section 50-35 of the Code (30 ILCS 500). Subcontractors desiring to enter into a subcontract of a State of Illinois contract must disclose the financial information and potential conflict of interest information as specified in this Disclosure Form.

The current annual salary of the Governor is \$177,412.00.

DISCLOSURE OF FINANCIAL INFORMATION

1. Disclosure of Financial Information. The individual named below has an interest in the SUBCONTRACTOR (or its parent) in terms of ownership or distributive income share in excess of 5%, or an interest which has a value of more than 60% of the annual salary of the Governor.

FOR INDIVIDUAL (type or print information) NAME: ADDRESS Type of ownership/distributable income share: stock sole proprietorship Partnership other: (explain on separate sheet): % or \$ value of ownership/distributable income share:

2. Disclosure of Potential Conflicts of Interest. Check "Yes" or "No" to indicate which, if any, of the following potential conflict of interest relationships apply. If the answer to any question is "Yes", please attach additional pages and describe.

(a) State employment, currently or in the previous 3 years, including contractual employment of services. Yes \_\_\_ No \_\_\_

If your answer is yes, please answer each of the following questions.

1. Are you currently an officer or employee of either the Capitol Development Board or the Illinois State Toll Highway Authority? Yes \_\_\_ No \_\_\_

2. Are you currently appointed to or employed by any agency of the State of Illinois? If you are currently appointed to or employed by any agency of the State of Illinois, and your annual salary exceeds 60% of the annual salary of the Governor, provide the name the State agency for which you are employed and your annual salary.

**RETURN WITH SUBCONTRACT**

3. If you are currently appointed to or employed by any agency of the State of Illinois, and your annual salary exceeds 60% of the annual salary of the Governor, are you entitled to receive (i) more than 7 1/2% of the total distributable income of your firm, partnership, association or corporation, or (ii) an amount in excess of 100% of the annual salary of the Governor?  
Yes \_\_\_ No \_\_\_

4. If you are currently appointed to or employed by any agency of the State of Illinois, and your annual salary exceeds 60% of the annual salary of the Governor, are you and your spouse or minor children entitled to receive (i) more than 15 % in the aggregate of the total distributable income of your firm, partnership, association or corporation, or (ii) an amount in excess of two times the salary of the Governor?  
Yes \_\_\_ No \_\_\_

---

(b) State employment of spouse, father, mother, son, or daughter, including contractual employment services in the previous 2 years.

Yes \_\_\_ No \_\_\_

If your answer is yes, please answer each of the following questions.

1. Is your spouse or any minor children currently an officer or employee of the Capitol Development Board or the Illinois State Toll Highway Authority?  
Yes \_\_\_ No \_\_\_

2. Is your spouse or any minor children currently appointed to or employed by any agency of the State of Illinois? If your spouse or minor children is/are currently appointed to or employed by any agency of the State of Illinois, and his/her annual salary exceeds 60% of the annual salary of the Governor, provide the name of your spouse and/or minor children, the name of the State agency for which he/she is employed and his/her annual salary. \_\_\_\_\_

3. If your spouse or any minor children is/are currently appointed to or employed by any agency of the State of Illinois, and his/her annual salary exceeds 60% of the annual salary of the Governor, are you entitled to receive (i) more than 7 1/2% of the total distributable income of your firm, partnership, association or corporation, or (ii) an amount in excess of 100% of the annual salary of the Governor?  
Yes \_\_\_ No \_\_\_

4. If your spouse or any minor children are currently appointed to or employed by any agency of the State of Illinois, and his/her annual salary exceeds 60% of the annual salary of the Governor, are you and your spouse or minor children entitled to receive (i) more than 15 % in the aggregate of the total distributable income of your firm, partnership, association or corporation, or (ii) an amount in excess of two times the salary of the Governor?  
Yes \_\_\_ No \_\_\_

---

(c) Elective status; the holding of elective office of the State of Illinois, the government of the United States, any unit of local government authorized by the Constitution of the State of Illinois or the statutes of the State of Illinois currently or in the previous 3 years.  
Yes \_\_\_ No \_\_\_

---

(d) Relationship to anyone holding elective office currently or in the previous 2 years; spouse, father, mother, son, or daughter.  
Yes \_\_\_ No \_\_\_

---

(e) Appointive office; the holding of any appointive government office of the State of Illinois, the United States of America, or any unit of local government authorized by the Constitution of the State of Illinois or the statutes of the State of Illinois, which office entitles the holder to compensation in excess of the expenses incurred in the discharge of that office currently or in the previous 3 years.  
Yes \_\_\_ No \_\_\_

---

(f) Relationship to anyone holding appointive office currently or in the previous 2 years; spouse, father, mother, son, or daughter.  
Yes \_\_\_ No \_\_\_

---

(g) Employment, currently or in the previous 3 years, as or by any registered lobbyist of the State government.  
Yes \_\_\_ No \_\_\_

**RETURN WITH SUBCONTRACT**

(h) Relationship to anyone who is or was a registered lobbyist in the previous 2 years; spouse, father, mother, son, or daughter. Yes \_\_\_ No \_\_\_

---

(i) Compensated employment, currently or in the previous 3 years, by any registered election or reelection committee registered with the Secretary of State or any county clerk of the State of Illinois, or any political action committee registered with either the Secretary of State or the Federal Board of Elections. Yes \_\_\_ No \_\_\_

---

(j) Relationship to anyone; spouse, father, mother, son, or daughter; who was a compensated employee in the last 2 years by any registered election or re-election committee registered with the Secretary of State or any county clerk of the State of Illinois, or any political action committee registered with either the Secretary of State or the Federal Board of Elections. Yes \_\_\_ No \_\_\_

---

**3 Communication Disclosure.**

Disclose the name and address of each lobbyist and other agent of the bidder or offeror who is not identified in Section 2 of this form, who is has communicated, is communicating, or may communicate with any State officer or employee concerning the bid or offer. This disclosure is a continuing obligation and must be promptly supplemented for accuracy throughout the process and throughout the term of the contract. If no person is identified, enter "None" on the line below:

Name and address of person(s): \_\_\_\_\_  
\_\_\_\_\_  
\_\_\_\_\_  
\_\_\_\_\_

**RETURN WITH SUBCONTRACT**

**4. Debarment Disclosure.** For each of the persons identified under Sections 2 and 3 of this form, disclose whether any of the following has occurred within the previous 10 years: debarment from contracting with any governmental entity; professional licensure discipline; bankruptcies; adverse civil judgments and administrative findings; and criminal felony convictions. This disclosure is a continuing obligation and must be promptly supplemented for accuracy throughout the procurement process and term of the contract. If no person is identified, enter "None" on the line below:

Name of person(s): \_\_\_\_\_

Nature of disclosure: \_\_\_\_\_  
\_\_\_\_\_  
\_\_\_\_\_

**APPLICABLE STATEMENT**

**This Disclosure Form A is submitted on behalf of the INDIVIDUAL named on previous page. Under penalty of perjury, I certify the contents of this disclosure to be true and accurate to the best of my knowledge.**

Completed by:  \_\_\_\_\_ Date \_\_\_\_\_  
Signature of Individual or Authorized Officer

**NOT APPLICABLE STATEMENT**

**Under penalty of perjury, I have determined that no individuals associated with this organization meet the criteria that would require the completion of this Form A.**

**This Disclosure Form A is submitted on behalf of the SUBCONTRACTOR listed on the previous page.**

\_\_\_\_\_ Date \_\_\_\_\_  
Signature of Authorized Officer

RETURN WITH SUBCONTRACT

ILLINOIS DEPARTMENT OF TRANSPORTATION

Form B
Subcontractor: Other Contracts & Financial Related Information Disclosure

Form with fields: Subcontractor Name, Legal Address, City, State, Zip, Telephone Number, Email Address, Fax Number (if available)

Disclosure of the information contained in this Form is required by the Section 50-35 of the Code (30 ILCS 500). This information shall become part of the publicly available contract file. This Form B must be completed for subcontracts with a total value of \$50,000 or more, from subcontractors identified in Section 20-120 of the Code, and for all open-ended contracts.

DISCLOSURE OF OTHER CONTRACTS, SUBCONTRACTS, AND PROCUREMENT RELATED INFORMATION

1. Identifying Other Contracts & Procurement Related Information. The SUBCONTRACTOR shall identify whether it has any pending contracts, subcontracts, including leases, bids, proposals, or other ongoing procurement relationship with any other State of Illinois agency: Yes \_\_\_ No \_\_\_

If "No" is checked, the subcontractor only needs to complete the signature box on the bottom of this page.

2. If "Yes" is checked. Identify each such relationship by showing State of Illinois agency name and other descriptive information such as bid or project number (attach additional pages as necessary). SEE DISCLOSURE FORM INSTRUCTIONS:

THE FOLLOWING STATEMENT MUST BE CHECKED

Signature box with fields for Signature of Authorized Officer and Date

OWNERSHIP CERTIFICATION

Please certify that the following statement is true if the individuals for all submitted Form A disclosures do not total 100% of ownership

Any remaining ownership interest is held by individuals receiving less than \$106,447.20 of the bidding entity's or parent entity's distributive income or holding less than a 5% ownership interest.

Yes No N/A (Form A disclosure(s) established 100% ownership)



- 1. TIME AND PLACE OF OPENING BIDS.** Sealed proposals for the improvement described herein will be received by the Department of Transportation. Electronic bids are to be submitted to the electronic bidding system (ics-Integrated Contractors Exchange). Paper-based bids are to be submitted to the Chief Procurement Officer for the Department of Transportation in care of the Chief Contracts Official at the Harry R. Hanley Building, 2300 South Dirksen Parkway, in Springfield, Illinois until 10:00 o'clock a.m. January 17, 2014. All bids will be gathered, sorted, publicly opened and read in the auditorium at the Department of Transportation's Harry R. Hanley Building shortly after the 10:00 a.m. cut off time.
- 2. DESCRIPTION OF WORK.** The proposed improvement is identified and advertised for bids in the Invitation for Bids as:

**Contract No. 76G67  
CLINTON County  
Section (20,21)-J  
Project ACHSIP-0327(059)  
Route FAP 327  
District 8 Construction Funds**

**This project consists of guardrail replacement, ditch regrading, rip rap placement and safety shoulders with rumble strips along a 2.09 mile stretch of US 50 from Huey Road to Creek Road in Clinton County.**

- 3. INSTRUCTIONS TO BIDDERS.** (a) This Notice, the invitation for bids, proposal and letter of award shall, together with all other documents in accordance with Article 101.09 of the Standard Specifications for Road and Bridge Construction, become part of the contract. Bidders are cautioned to read and examine carefully all documents, to make all required inspections, and to inquire or seek explanation of the same prior to submission of a bid.  
  
(b) State law, and, if the work is to be paid wholly or in part with Federal-aid funds, Federal law requires the bidder to make various certifications as a part of the proposal and contract. By execution and submission of the proposal, the bidder makes the certification contained therein. A false or fraudulent certification shall, in addition to all other remedies provided by law, be a breach of contract and may result in termination of the contract.
- 4. AWARD CRITERIA AND REJECTION OF BIDS.** This contract will be awarded to the lowest responsive and responsible bidder considering conformity with the terms and conditions established by the Department in the rules, Invitation for Bids and contract documents. The issuance of plans and proposal forms for bidding based upon a prequalification rating shall not be the sole determinant of responsibility. The Department reserves the right to determine responsibility at the time of award, to reject any or all proposals, to readvertise the proposed improvement, and to waive technicalities.

By Order of the  
Illinois Department of Transportation

Ann L. Schneider,  
Secretary



INDEX  
 FOR  
 SUPPLEMENTAL SPECIFICATIONS  
 AND RECURRING SPECIAL PROVISIONS

Adopted January 1, 2014

This index contains a listing of SUPPLEMENTAL SPECIFICATIONS, frequently used RECURRING SPECIAL PROVISIONS, and LOCAL ROADS AND STREETS RECURRING SPECIAL PROVISIONS.

ERRATA Standard Specifications for Road and Bridge Construction (Adopted 1-1-12) (Revised 1-1-14)

SUPPLEMENTAL SPECIFICATIONS

<u>Std. Spec. Sec.</u>	<u>Page No.</u>
101 Definition of Terms .....	1
102 Advertisement, Bidding, Award, and Contract Execution .....	2
105 Control of Work .....	3
106 Control of Materials .....	5
107 Legal Regulations and Responsibility to Public .....	6
108 Prosecution and Progress .....	14
109 Measurement and Payment .....	15
202 Earth and Rock Excavation .....	17
211 Topsoil and Compost .....	18
253 Planting Woody Plants .....	19
280 Temporary Erosion and Sediment Control .....	21
312 Stabilized Subbase .....	22
406 Hot-Mix Asphalt Binder and Surface Course .....	23
407 Hot-Mix Asphalt Pavement (Full-Depth) .....	26
420 Portland Cement Concrete Pavement .....	30
424 Portland Cement Concrete Sidewalk .....	32
440 Removal of Existing Pavement and Appurtenances .....	33
503 Concrete Structures .....	34
504 Precast Concrete Structures .....	37
506 Cleaning and Painting New Steel Structures .....	38
512 Piling .....	39
516 Drilled Shafts .....	40
521 Bearings .....	41
540 Box Culverts .....	42
588 Bridge Relief Joint System .....	43
589 Elastic Joint Sealer .....	45
602 Catch Basin, Manhole, Inlet, Drainage Structure, and Valve Vault Construction, Adjustment, and Reconstruction .....	46
603 Adjusting Frames and Grates of Drainage and Utility Structures .....	47
606 Concrete Gutter, Curb, Median, and Paved Ditch .....	49
610 Shoulder Inlets with Curb .....	50
639 Precast Prestressed Concrete Sight Screen .....	51
642 Shoulder Rumble Strips .....	52
643 Impact Attenuators .....	53
644 High Tension Cable Median Barrier .....	55
701 Work Zone Traffic Control and Protection .....	57
706 Impact Attenuators, Temporary .....	60
707 Movable Traffic Barrier .....	63
708 Temporary Water Filled Barrier .....	65
730 Wood Sign Support .....	67
780 Pavement Striping .....	68
860 Master Controller .....	73
1001 Cement .....	74
1003 Fine Aggregates .....	75
1004 Coarse Aggregates .....	77
1006 Metals .....	81
1011 Mineral Filler .....	83
1017 Packaged, Dry, Combined Materials for Mortar .....	84

1018 Packaged Rapid Hardening Mortar or Concrete ..... 85  
1019 Controlled Low-Strength Material ..... 86  
1020 Portland Cement Concrete ..... 87  
1024 Grout and Nonshrink Grout ..... 126  
1030 Hot-Mix Asphalt ..... 127  
1040 Drain Pipe, Tile, Drainage Mat, and Wall Drain ..... 132  
1042 Precast Concrete Products ..... 133  
1070 Foundation and Breakaway Devices ..... 134  
1073 Controller ..... 135  
1081 Materials for Planting ..... 136  
1082 Preformed Bearing Pads ..... 137  
1083 Elastomeric Bearings ..... 138  
1095 Pavement Markings ..... 139  
1101 General Equipment ..... 142  
1102 Hot-Mix Asphalt Equipment ..... 144  
1105 Pavement Marking Equipment ..... 146  
1106 Work Zone Traffic Control Devices ..... 147

RECURRING SPECIAL PROVISIONS

The following RECURRING SPECIAL PROVISIONS indicated by an "X" are applicable to this contract and are included by reference:

<u>CHECK SHEET #</u>	<u>PAGE NO.</u>
1 X Additional State Requirements for Federal-Aid Construction Contracts (Eff. 2-1-69) (Rev. 1-1-10) .....	149
2 X Subletting of Contracts (Federal-Aid Contracts) (Eff. 1-1-88) (Rev. 5-1-93) .....	152
3 X EEO (Eff. 7-21-78) (Rev. 11-18-80) .....	153
4 Specific Equal Employment Opportunity Responsibilities Non Federal-Aid Contracts (Eff. 3-20-69) (Rev. 1-1-94) .....	163
5 Required Provisions - State Contracts (Eff. 4-1-65) (Rev. 1-1-13) .....	168
6 Asbestos Bearing Pad Removal (Eff. 11-1-03) .....	173
7 Asbestos Waterproofing Membrane and Asbestos Hot-Mix Asphalt Surface Removal (Eff. 6-1-89) (Rev. 1-1-09) .....	174
8 Haul Road Stream Crossings, Other Temporary Stream Crossings, and In-Stream Work Pads (Eff. 1-2-92) (Rev. 1-1-98) .....	175
9 Construction Layout Stakes Except for Bridges (Eff. 1-1-99) (Rev. 1-1-07) .....	176
10 Construction Layout Stakes (Eff. 5-1-93) (Rev. 1-1-07) .....	179
11 Use of Geotextile Fabric for Railroad Crossing (Eff. 1-1-95) (Rev. 1-1-07) .....	182
12 Subsealing of Concrete Pavements (Eff. 11-1-84) (Rev. 1-1-07) .....	184
13 Hot-Mix Asphalt Surface Correction (Eff. 11-1-87) (Rev. 1-1-09) .....	188
14 Pavement and Shoulder Resurfacing (Eff. 2-1-00) (Rev. 1-1-09) .....	190
15 PCC Partial Depth Hot-Mix Asphalt Patching (Eff. 1-1-98) (Rev. 1-1-07) .....	191
16 Patching with Hot-Mix Asphalt Overlay Removal (Eff. 10-1-95) (Rev. 1-1-07) .....	193
17 Polymer Concrete (Eff. 8-1-95) (Rev. 1-1-08) .....	194
18 PVC Pipeliner (Eff. 4-1-04) (Rev. 1-1-07) .....	196
19 Pipe Underdrains (Eff. 9-9-87) (Rev. 1-1-07) .....	197
20 X Guardrail and Barrier Wall Delineation (Eff. 12-15-93) (Rev. 1-1-12) .....	198
21 Bicycle Racks (Eff. 4-1-94) (Rev. 1-1-12) .....	202
22 Temporary Modular Glare Screen System (Eff. 1-1-00) (Rev. 1-1-07) .....	204
23 Temporary Portable Bridge Traffic Signals (Eff. 8-1-03) (Rev. 1-1-07) .....	206
24 Work Zone Public Information Signs (Eff. 9-1-02) (Rev. 1-1-07) .....	208
25 Night Time Inspection of Roadway Lighting (Eff. 5-1-96) .....	209
26 English Substitution of Metric Bolts (Eff. 7-1-96) .....	210
27 English Substitution of Metric Reinforcement Bars (Eff. 4-1-96) (Rev. 1-1-03) .....	211
28 Calcium Chloride Accelerator for Portland Cement Concrete (Eff. 1-1-01) (Rev. 1-1-13) .....	212
29 Portland Cement Concrete Inlay or Overlay for Pavements (Eff. 11-1-08) (Rev. 1-1-13) .....	213
30 Quality Control of Concrete Mixtures at the Plant (Eff. 8-1-00) (Rev. 1-1-14) .....	216
31 Quality Control/Quality Assurance of Concrete Mixtures (Eff. 4-1-92) (Rev. 1-1-14) .....	224
32 Digital Terrain Modeling for Earthwork Calculations (Eff. 4-1-07) .....	240
33 Pavement Marking Removal (Eff. 4-1-09) .....	242
34 Preventive Maintenance – Bituminous Surface Treatment (Eff. 1-1-09) (Rev. 1-1-12) .....	243
35 Preventive Maintenance – Cape Seal (Eff. 1-1-09) (Rev. 1-1-12) .....	249
36 Preventive Maintenance – Micro-Surfacing (Eff. 1-1-09) (Rev. 1-1-12) .....	264
37 Preventive Maintenance – Slurry Seal (Eff. 1-1-09) (Rev. 1-1-12) .....	275
38 Temporary Raised Pavement Markers (Eff. 1-1-09) (Rev. 1-1-14) .....	285
39 Restoring Bridge Approach Pavements Using High-Density Foam (Eff. 1-1-09) (Rev. 1-1-12) .....	286

**TABLE OF CONTENTS**

LOCATION OF PROJECT ..... 1

DESCRIPTION OF PROJECT ..... 1

MONTHLY LABOR SUMMARY AND ACTIVITY REPORTING SYSTEM ..... 1

EMBANKMENT ..... 4

SEEDING, CLASS 2 ..... 4

HOT-MIX ASPHALT..... 5

OFFICE COPY MACHINE ..... 5

TELEPHONE ANSWERING MACHINE ..... 6

TRAFFIC CONTROL PLAN ..... 6

CONSTRUCTION AND MAINTENANCE SIGN SUPPORTS ..... 7

PAVEMENT MARKING TAPE, TYPE III, SPECIAL ..... 8

CONTRACTOR COOPERATION ..... 8

GUARDRAIL POSTS ..... 8

GUARDRAIL REMOVAL..... 9

HOT MIX ASPHALT QUALITY CONTROL FOR PERFORMANCE (BMPR)..... 9

STATUS OF UTILITIES TO BE ADJUSTED ..... 13

AUTOMATED FLAGGER ASSISTANCE DEVICES (BDE)..... 14

DISADVANTAGED BUSINESS ENTERPRISE PARTICIPATION (BDE) ..... 15

FRICTION AGGREGATE (BDE) ..... 24

HOT-MIX ASPHALT – MIXTURE DESIGN COMPOSITION AND VOLUMETRIC REQUIREMENTS (BDE)  
 ..... 28

HOT-MIX ASPHALT – MIXTURE DESIGN VERIFICATION AND PRODUCTION (BDE) ..... 31

PAVEMENT MARKING FOR BIKE SYMBOL (BDE)..... 33

PAYROLLS AND PAYROLL RECORDS (BDE) ..... 35

PROGRESS PAYMENTS (BDE) ..... 37

RECLAIMED ASPHALT PAVEMENT AND RECLAIMED ASPHALT SHINGLES (BDE) ..... 38

REMOVAL AND DISPOSAL OF REGULATED SUBSTANCES (BDE) ..... 49

REMOVAL AND DISPOSAL OF SURPLUS MATERIALS (BDE) ..... 53

TRACKING THE USE OF PESTICIDES (BDE)..... 54

TRAINING SPECIAL PROVISIONS (BDE) ..... 54

IDOT TRAINING PROGRAM GRADUATE ON-THE-JOB TRAINING SPECIAL PROVISION (TPG)..... 57

WARM MIX ASPHALT (BDE) ..... 59

WEEKLY DBE TRUCKING REPORTS (BDE)..... 65

WORKING DAYS (BDE) ..... 65

BITUMINOUS MATERIALS COST ADJUSTMENTS (BDE) (RETURN FORM WITH BID) ..... 66

FUEL COST ADJUSTMENT (BDE) (RETURN FORM WITH BID) ..... 69

STEEL COST ADJUSTMENT (BDE) (RETURN FORM WITH BID) ..... 73  
STORM WATER POLLUTION PREVENTION PLAN..... 77

## STATE OF ILLINOIS

---

### SPECIAL PROVISIONS

The following Special Provisions supplement the "Standard Specifications for Road and Bridge Construction, Adopted January 1, 2012", the latest edition of the "Manual on Uniform Traffic Control Devices for Streets and Highways", and the "Manual of Test Procedures for Materials" in effect on the date of invitation for bids, and the "Supplemental Specifications and Recurring Special Provisions" indicated on the Check Sheet included herein, which apply to and govern the construction of FAP Route 327 (US 50); Project ACHSIP-0327(059); Section (20,21)-J; Clinton County; Contract No. 76G67 and in case of conflict with any part, or parts, of said Specifications, the said Special Provisions shall take precedence and shall govern.

#### LOCATION OF PROJECT

US 50 from Huey Rd. to Creek Rd.

#### DESCRIPTION OF PROJECT

HMA Shoulders and milled rumble strip. Guardrail replacement, rip rap, ditch regrading and turf reinforcement mat.

#### MONTHLY LABOR SUMMARY AND ACTIVITY REPORTING SYSTEM

Effective: 1-1-1995

Revised June 2001

##### I. Monthly Labor Summary Report, Form SBE 148

The prime contractor and each first and second tier sub-contractor, (hereinafter referred to as "subcontractor") shall submit a certified Monthly Labor Summary Report directly to the District Engineer.

This report is in lieu of submittal of the Monthly Workforce Analysis Report, Form SBE 956.

This report must be received in District Eight no later than the tenth day of the next month.

This Report shall be submitted by the prime contractor and each subcontractor, for each consecutive month, from the start, to the completion of their work on the contract.

The data source for this Report will be a summation of all personnel and hours worked on each subject contract for the month based on weekly payrolls for that month.

The Monthly Labor Summary Report is required to be submitted in one of the following formats:

- a.) For contractors having IDOT contracts valued in the aggregate at \$250,000 or less, the report may be typed or clearly handwritten using Form SBE 148 for submittal to the District Engineer for District Eight.
- b.) For contractors having IDOT contracts valued in the aggregate at more than \$250,000, the report must be submitted in a specific "Fixed Length Comma Delimited ASCII Text File Format". The subject file format is detailed on the next page. Submittal of this file may be by 3.5 inch disk, modem, or by e-mail.

II. Monthly Contract Activity Report, Form SBE 248

The prime contractor and each subcontractor shall submit a monthly report directly to the District Engineer reflecting their contract activity on all Illinois Department of Transportation contracts they have in force in District Eight.

This report shall be submitted for each consecutive month, from the start, to the completion of all contracts in District Eight.

The report must be received in the District Office no later than the tenth day of the next month.

Monthly Labor Summary and Activity Reporting System Codes and Formats

Indicated below for your reference are the Employee Codes and File Formats required for this system.

I.) Monthly Labor Summary Report, Form SBE 148

The following employee codes are to be used to identify each individual on the Summary Report:

- 1. **Gender:** M - Male F - Female
- 2. **Ethnic Group:** 1 - White 2 - Black 3 - Hispanic  
4 - American Indian/Alaskan Native 5 - Asian/Pacific Islander
- 3. **Work Classification:** OF - Official SU - Supervisor FO - Foremen  
CL - Clerical CA - Carpenter EO - Operator ME - Mechanic  
TD - Truck Driver IW - Ironworker PA - Painter OT - Other  
EL - Electrician PP - Pipefitter TE - Technical LA - Laborer  
CM - Cement Mason
- 4. **Employee Status:** O - Owner Operator J - Journeyman  
C - Company A - Apprentice T - Trainee

Specific "Fixed Length Comma Delimited ASCII File Format"

Order	Field Name	Type	Size
1	Contractor Number	A	4
2	Contractor Reference Number	A	6
3	Contract Number	A	5
4	Period (07/28/2000)	D	10
5	SSN (111-11-1111)	A	11
6	Name	A	40
7	Gender	A	1
8	Ethnic Group	A	1
9	Work Classification	A	1
10	Employee Status	A	1
11	Total Hours (000060.00)	N	10

File Name Conventions: (Contractor Number + Report Month/Year).Txt  
 i.e. 20001298.Txt

II.) Monthly Contract Activity Report, Form SBE 248

The following activity codes are to be used to identify the contractor's contract status each month on the Monthly Activity Report, Form SBE 248:

- A. Contract Status:      1 - Not Started      2 - Active      3 - No Work
- 4 - Suspended      5 - Complete

Failure to comply with this special provision may result in the withholding of payments to the contractor, and/or cancellation, termination, or suspension of the contract in whole or part.

Compliance with this Special Provision shall be considered incidental to the cost of the contract and no additional compensation will be allowed for any costs incurred.

All prime and subcontractors having contracts in the aggregate exceeding \$250,000 must provide a "Fixed Length Comma Delimited ASCII File" for approval prior to the start of construction.

This Special Provision must be included in each subcontract agreement.

The Department of Transportation is requesting disclosure of information necessary to accomplish the statutory purpose as outlined under 23CFR part 230 and 41CFR part 60.4 and the Illinois Human Rights Act. Disclosure of this information is REQUIRED. Failure to comply with this special provision may result in the withholding of payments to the contractor, and/or cancellation, termination, or suspension of the contract in whole or part.

Compliance with this Special Provision shall be considered incidental to the cost of the contract and no additional compensation will be allowed for any costs incurred.

This Special Provision must be included in each subcontract agreement.



## **EMBANKMENT**

Revised November 1, 2006

Material which is proposed for use by the Contractor to be used for embankment construction must be inspected and approved by the District Geotechnical Engineer. In order to be approved for use as embankment material, it must meet all applicable requirements of Sections 202, 203, 204, 205, and 502 of the Standard Specifications and meet the following requirements:

1. It must fall in one of the following Highway Research Board Classifications: A-1, A-2, A-3, A-4, A-6, or A-7-6.
2. It shall have a Liquid Limit of 49 or less.
3. Any A-4, A-6 or A-7-6 material to be used as borrow for embankment construction shall not have an organic content greater than 7%.
4. Classification of the material for points 1 and 2 shall be determined in accordance with the latest AASHTO Designation: M 145.
5. When tested for density in place, any soil classified as an A-4 shall not contain more than 100% of optimum moisture content determined according to AASHTO T-99.

The outside 9 feet (3 meters) of those portions of the embankment which will be permanently exposed in the completed roadway shall be constructed using native materials of a classification that will support vegetation and contain a plasticity index of 12 or greater as directed by the Engineer.

The lime modified soil layer shall be constructed with a minimum of 18 inches (450 mm) of "reactive" soil as defined by Article 1009.02 of the Standard Specifications.

## **SEEDING, CLASS 2**

In addition to the requirements of Section 250, when Class 2 seeding is done between March 1<sup>st</sup> and June 1<sup>st</sup>, the seed mixture shall also include 48 pounds per acre (55kg/ha) of Spring Oats. When Class 2 seeding is done between August 1<sup>st</sup> and November 15<sup>th</sup>, the seed mixture shall also include 56 pounds per acre (63kg/ha) of Balboa Farm Rye or 60 pounds per acre (67kg/ha) of Winter Wheat.

**HOT-MIX ASPHALT**

Eff.: 12/1/2009

Revise the first paragraph of Article 1030.05(d)(3) to read as follows:

Required Field Tests. The Contractor shall control the compaction process by testing the mix density at random locations determined by the Engineer in accordance with the QC/QA document, "Determination of Random Density Test Site Locations", and recording the results on forms approved by the Engineer. The density locations will be disclosed and marked by the Engineer after all compaction efforts have been completed. Locations shall be laid out using a tape measure or an approved measuring wheel. The Contractor shall follow the density testing procedures detailed in the QC/QA document, "Illinois-Modified ASTM D 2950, Standard Test Method for Determination of Density of Bituminous Concrete In-Place by Nuclear Method".

Revise the third paragraph of Article 1030.05(d)(3) to read as follows:

If the Engineer determines the nuclear density test method is not appropriate for the mixture, cores shall be taken at random locations determined by the Engineer in accordance with the QC/QA document, "Determination of Random Density Test Site Locations". The density locations will be disclosed and marked by the Engineer after all compaction efforts have been completed. Locations shall be laid out using a tape measure or approved measuring wheel. Three QC cores shall be taken at equal distances transversely across the test site. Three QA cores shall be taken 1.0 foot longitudinally to the location of the QC cores using the same transverse offset. Each set of three cores shall be averaged to provide a single test site result for acceptance. Core densities shall be determined using the Illinois-Modified AASHTO T 166 or T 275 procedure.

**OFFICE COPY MACHINE**

*Effective: January 1, 1987*

*Revised: November 1, 2006*

The copier specified in Article 670.02 shall meet the following specifications:

- (1) Edge-to-edge copying.
- (2) Up to 11 in x 17 in (275 mm x 425 mm) size for copy-size capabilities.
- (3) A detachable platen cover in order to copy portions of large-bound documents.
- (4) A cabinet stand for the copier.

## **TELEPHONE ANSWERING MACHINE**

*Effective: January 11, 1990*

*Revised: November 1, 2006*

The telephone answering machine specified in Article 670.02 shall meet the following minimum specifications:

- (1) Time/Day Indication - A computerized voice records the date and time that each message is received.
- (2) Beeperless Remote - Any remote touch-tone phone can be used to review all messages by the use of an access code.
- (3) Digital System - Pre-recorded and received messages are managed on separate cassettes.
- (4) Conversation Record - The operator can record any phone call.
- (5) Remote Turn-On - Any remote touch-tone phone can be used to turn on the answering machine by the use of an access code.
- (6) Full Message - The Caller is advised if the memory is insufficient to record the call.
- (7) Battery Back-Up - The settings and messages are protected from power failures.
- (8) Two-Line Capacity - Projects that have a second phone line through the provision of a 670.05 Engineer's Field Laboratory shall provide a single phone answering machine that services both lines.

Prior to the purchase of this item, the Contractor shall submit specifications for the proposed machine to the Engineer for his approval.

## **TRAFFIC CONTROL PLAN**

*Effective: July 12, 1993*

*Revised: May 12, 1997*

Traffic control shall be in accordance with the applicable sections of the "Standard Specifications for Road and Bridge Construction", the applicable guidelines contained in the "National Manual on Uniform Traffic Control Devices for Streets and Highways", Illinois Supplement to the National Manual of Uniform Traffic Control Devices, these Special Provisions, and any special details and Highway Standards contained herein and in the plans.

Special attention is called to Articles 107.09 and 107.14 of the "Standard Specifications for Road and Bridge Construction" and the following Highway Standards relating to traffic control:

701001	701006	701011	701201	701301	701306
701311	701326	701901			

In addition, the following Special Provision(s) will also govern traffic control for this project:

#### Construction and Maintenance Sign Supports

Custom signs shall be installed 500' in advance of each end of this project. The signs shall have the legend "NO PASSING PERMITTED IN THE CONSTRUCTION ZONE". These signs shall meet the requirements of Articles 701.14 and 1106.01 of the Standard Specifications. The sign faces shall be fluorescent orange with black letters. The legend shall be clearly legible by approaching motorists at least 1000' in advance of the sign locations. These signs shall be installed immediately prior to the pavement removal and replacement operations and when the existing pavement markings have been covered (see the special provision for PAVEMENT MARKING TAPE, TYPE III, SPECIAL and General Note 6 in the plans.) These signs shall remain in place until the pavement removal, pavement replacement and shoulder operations have been completed and the original centerline and the existing pavement markings have been restored.

The cost of furnishing, installing and removal of these signs shall be included in the cost of TRAFFIC CONTROL & PROTECTION, STANDARD 701201.

### **CONSTRUCTION AND MAINTENANCE SIGN SUPPORTS**

*Effective: April 21, 1981*

*Revised: November 1, 2006*

This work shall be done according to Section 1106 of the Standard Specifications and Highway Standard 701901 except as herein modified.

All construction signs mounted on permanent support for use in temporary traffic control having an area of 10 square feet (1 square meter) or more shall be mounted on two 4 in x 4 in (100 mm x 100 mm) or two 4 in x 6 in (100 mm x 150 mm) wood posts.

Type A metal post (two for each sign) conforming to Article 1006.29 of the Standard Specifications may be used in lieu of wood posts. Type A metal posts used for these signs may be unfinished.

This work shall not be paid for separately; but shall be considered included in the cost of the traffic control items in this contract.

### **PAVEMENT MARKING TAPE, TYPE III, SPECIAL**

This work shall consist of furnishing, installing and maintaining matte black temporary pavement marking tape according to Section 703.

The matte black pavement marking tape shall be used to temporarily cover the existing pavement markings and shall be 2 inches wider than the existing line to be covered.

The pavement marking tape shall conform to Article 1095.06 except it shall be matte black and shall have no reflective value.

Method of Measurement: Temporary pavement marking tape of the various line widths will be measured for payment in feet in place and accepted.

Basis of Payment: This work will be paid for at the contract unit price per foot for PAVEMENT MARKING TAPE, TYPE III, SPECIAL of the line width specified.

### **CONTRACTOR COOPERATION**

Description: This work shall consist of any coordination of proposed project start dates and sequence of construction with the Engineer and other Contractors required for an effective and timely schedule, in accordance with Section 105.08 of the Standard Specifications. This work also pertains to delays and inconvenience incurred by the Contractor resulting from lack of coordination specified herein.

The Contractor must be aware that, during the duration of this Contract, other separate contracts may be under construction on or near the work covered by this Contract. Special attention is brought to the work covered by this Contract that may be on or near the work covered by Contract No. 76G46, cape seal of US Route 50 from Huey Rd. to Shattuc Rd.

Construction Requirements: The Contractor shall schedule and conduct work and shall place and dispose of material being used so as not to interfere with or cause unnecessary inconvenience or delay to the operations of other Contractors within the limits of the same project. The Contractor shall perform the work in proper sequence with the work of the other Contractors. Full cooperation of the Contractors involved, in careful and complete coordination of their respective activities in the area, will be required.

Basis of Payment: Any additional costs, delays, or inconvenience incurred by the Contractor to meet the requirements of this provision or resulting from failure to meet the requirements of this provision shall be considered incidental to this Contract and no additional compensation will be allowed.

### **GUARDRAIL POSTS**

All guardrail posts, whether wood or steel, shall be 9 foot. The cost for the additional length shall be included in the cost for the associated pay items and no additional compensation will be allowed.

**GUARDRAIL REMOVAL**

This work shall be performed according to Section 632 of the Standard Specifications except as follows:

All existing posts shall be removed totally, leaving no remnants at or below the ground surface.

Various materials (such as steel and wood posts, timbers, railroad ties, riprap, guardrail elements and other items) have been placed on the foreslope to stabilize the slope and shoulder. All of this material shall be removed to allow regrading of the slope and shoulder, placing of riprap and installation of new guardrail. The cost for removal and proper disposal of this material shall be included in the cost of Guardrail Removal and no additional compensation will be allowed.

No guardrail will be salvaged and shall be disposed of per Article 202.03 of the Standard Specifications.

Basis of Payment: This work will be paid for at the contract unit price per foot for GUARDRAIL REMOVAL.

**HOT MIX ASPHALT QUALITY CONTROL FOR PERFORMANCE (BMPR)**

Effective: January 1, 2012

Revised: January 1, 2013

Description. This special provision describes the procedures for production, placement and payment of hot-mix asphalt (HMA). This work shall be according to the Standard Specifications except as modified herein. This special provision shall apply to HMA mixtures as listed in the following table.

Mixture/Use:	HMA Surface Course, Mix "D", N90
Location:	US 50 widening and shoulder – 1132 Tons
Mixture/Use:	HMA Binder Course, IL-19.0 FG, N90
Location:	US 50 widening and shoulder – 4403 Tons
Mixture/Use:	
Location:	

Exceptions may be approved for small tonnage less than 800 (725 metric) tons and miscellaneous mixture applications as defined by the Engineer.

Delete Articles:	406.06(b)(1), 2 <sup>nd</sup> Paragraph	(Temperature requirements)
	406.06 (e), 3 <sup>rd</sup> Paragraph	(Pavers speed requirements)
	406.07	(Compaction)
	1030.05(a)(4, 5, 9,)	(QC/QA Documents)
	1030.05(d)(2)a.	(Plant Tests)
	1030.05(d)(2)b.	(Dust-to-Asphalt and Moisture Content)
	1030.05(d)(2)d.	(Small Tonnage)
	1030.05(d)(2)f.	(HMA Sampling)
	1030.05(d)(3)	(Required Field Tests)
	1030.05(d)(4)	(Control Limits)
	1030.05(d)(5)	(Control Charts)
	1030.05(d)(7)	(Corrective Action for Field Tests (Density))
	1030.05(e)	(Quality Assurance by the Engineer)
	1030.05(f)	(Acceptance by the Engineer)
	1030.06(a), 3 <sup>rd</sup> paragraph	(Before start-up...)
	1030.06(a), 7 <sup>th</sup> paragraph	(After an acceptable...)
	1030.06(a), 8 <sup>th</sup> paragraph	(If a mixture...)
	1030.06(a), 9 <sup>th</sup> paragraph	(A nuclear/core...)

Definitions:

- (a) Quality Control (QC): All production and construction activities by the Contractor required to achieve the required level of quality.
- (b) Quality Assurance (QA): All monitoring and testing activities by the Engineer required to assess product quality, level of payment, and acceptability of the product.
- (c) Pay Parameters: Pay Parameters shall be field Voids in the Mineral Aggregate (VMA), voids, and density. Field VMA will be calculated using the combined aggregates bulk specific gravity ( $G_{sb}$ ) from the mix design.
- (d) Mixture Lot. A lot shall begin once an acceptable test strip has been completed and the AJMF has been determined. If the test strip is waived, a subplot shall begin with the start of production. A mixture lot shall consist of four sublots unless it is the last or only lot, in which case it may consist of as few as one subplot
- (e) Mixture Sublot. A mixture subplot for field VMA, voids, and Dust/AC shall be 1000 tons (910 metric tons).
- If the remaining quantity is greater than 200 but less than 1000 tons, a subplot will consist of that amount.
  - If the remaining quantity is less than or equal to 200 tons, the quantity shall be combined with the previous subplot.
- (f) Density Interval. Density Intervals shall be every 0.2 mile (320 m) for lift thickness equal to or less than 3 in. (75 mm) and 0.1 mile (160 m) for lift thickness greater than 3 in. (75 mm).

(g) Density Sublot. A sublot for density shall be the average of five consecutive Density Intervals. If a Density Interval is less than 200 ft (60 m), it will be combined with the previous Density Intervals.

- If one or two Density Intervals remain outside a sublot, they shall be included in the previous sublot.
- If three or more Density Intervals remain, they shall be considered a sublot.

(h) Density Test: A density test consists of a core taken at a random longitudinal and transverse offset within each Density Interval. The HMA maximum theoretical gravity ( $G_{mm}$ ) will be based on the running average of four Department test results. Initial  $G_{mm}$  will be based on the average of the first four test results. If less than four  $G_{mm}$  results are available, use an average of all available Department  $G_{mm}$  test results.

The random transverse offset excludes a distance from each outer edge equal to the lift thickness or a minimum of 4 in. (100 mm). If within one foot of an unconfined edge, 2.0 percent density will be added to the density of any core.

Quality Control (QC) by the Contractor:

The Contractor's QC plan shall include the schedule of testing for both pay parameters and non-pay parameters required to control the product such as asphalt binder content and mixture gradation. The minimum test frequency shall be according to the following table.

Minimum Quality Control Sampling and Testing Requirements

Quality Characteristic		Minimum Test Frequency
Mixture Gradation		1 per sublot
Asphalt Binder Content		
Dust/AC Ratio		
Field VMA		
Voids	$G_{mb}$	
	$G_{mm}$	

The Contractor's splits in conjunction with other quality control tests shall be used to control production.

The Contractor shall submit split jobsite mix sample test results to the Engineer within 48 hours of the time of sampling. All QC testing shall be performed in a qualified laboratory by personnel who have successfully completed the Department's HMA Level I training.



Quality Assurance (QA) by the Engineer:

Voids, field VMA and Dust/AC ratio: The Engineer will determine the random tonnage and the Contractor shall be responsible for obtaining the sample according to the “PFP Hot-Mix Asphalt Random Jobsite Sampling” procedure.

Density: The Engineer will identify the random locations for each density testing interval. The Contractor shall be responsible for obtaining the four inch cores within the same day and prior to opening to traffic unless otherwise approved by the Engineer according to the “PFP Random Density Procedure”. The locations will be identified after final rolling and cores shall be obtained under the supervision of the Engineer. All core holes shall be filled immediately upon completion of coring. All water shall be removed from the core holes prior to filling. All core holes shall be filled with a rapid hardening mortar or concrete which shall be mixed in a separate container prior to placement in the hole. Any depressions in the surface of the filled core holes greater than 1/4 inch at the time of final inspection will require removal of the fill material to the depth of the lift thickness and replacement.

The Engineer will witness and secure all mixture and density samples. The Contractor shall transport the secured sample to a location designated by the Engineer.

The Engineer will test one or all of the randomly selected split samples from each lot for voids, field VMA and dust/AC ratio. The Engineer will test a minimum of one sample per project. The Engineer will test all of the pavement cores for density. All QA testing will be performed in a qualified laboratory by personnel who have successfully completed the Department’s HMA Level I training. QA test results will be available to the Contractor within 10 working days from receipt of secured cores and split mixture samples.

The Engineer will maintain a complete record of all Department test results and copies will be provided to the Contractor with each set of subplot results. The records will contain, as a minimum, the originals of all Department test results and raw data, random numbers used and resulting calculations for sampling locations, and quality level analysis calculations.

If the QA results do not meet the 100% subplot pay factor limits or do not compare to QC results within the precision limits listed below, the Engineer will test all split mix samples for the lot.

<b>Test Parameter</b>	<b>Limits of Precision</b>
G <sub>mb</sub>	0.030
G <sub>mm</sub>	0.026
Dust/Asphalt AC Ratio	0.20
Field VMA	1.0 %

Acceptance by the Engineer: All tests shall be within the acceptable limits listed below:

Parameter		Acceptable Limits
Field VMA		-1.0 – +3.0% <sup>1/</sup>
Voids		2.0 – 6.0% <sup>2/</sup>
Density:	IL-9.5, IL-12.5, IL-19.0, IL-25.0, IL-4.75, IL-9.5FG <sup>4/</sup>	90.0 – 98.0%
	SMA	92.0 – 98.0%
Dust / AC Ratio		0.4 – 1.6 <sup>3/</sup>

1/ Based on minimum required VMA from mix design

2/ The acceptable range for SMA mixtures shall be 2.0% - 5.0%

3/ Does not apply to SMA.

4/ Acceptable density limits for IL-9.5FG placed less than 1.25 in. shall be 89.0% - 98.0%

In addition, no visible pavement distresses shall be present such as, but not limited to, segregation, excessive coarse aggregate fracturing or flushing.

Basis of Payment: Payment will be based on the calculation of the Composite Pay Factor using QA results for each mix according to the “QCP Payment Calculation” document.

Dust / AC Ratio. A monetary deduction will be made using the pay adjustment table below for dust/AC ratios that deviate from the 0.6 to 1.2 range.

Dust / AC Pay Adjustment Table<sup>1/</sup>

Range	Deduct / subplot
$0.6 \leq X \leq 1.2$	\$0
$0.5 \leq X < 0.6$ or $1.2 < X \leq 1.4$	\$1000
$0.4 \leq X < 0.5$ or $1.4 < X \leq 1.6$	\$3000
$X < 0.4$ or $X > 1.6$	Shall be removed and replaced

1/ Does not apply to SMA.

## STATUS OF UTILITIES TO BE ADJUSTED

### NO UTILITIES TO BE ADJUSTED

The above represents the best information of the Department and is only included for the convenience of the bidder. The applicable provisions of Sections 102, 103, and Articles 105.07 and 107.20 of the Standard Specifications for Road and Bridge Construction shall apply.

If any utility adjustment or removal has not been completed when required by the Contractor's operation, the Contractor should notify the Engineer in writing. A request for an extension of time will be considered to the extent the Contractor's operations were affected.

## **AUTOMATED FLAGGER ASSISTANCE DEVICES (BDE)**

Effective: January 1, 2008

Description. This work shall consist of furnishing and operating automated flagger assistance devices (AFADs) as part of the work zone traffic control and protection for two-lane highways where two-way traffic is maintained over one lane of pavement. Use of these devices shall be at the option of the Contractor.

Equipment. AFADs shall be according to the FHWA memorandum, "MUTCD - Revised Interim Approval for the use of Automated Flagger Assistance Devices in Temporary Traffic Control Zones (IA-4R)", dated January 28, 2005. The devices shall be mounted on a trailer or a moveable cart and shall meet the requirements of NCHRP 350, Category 4.

The AFAD shall be the Stop/Slow type. This device uses remotely controlled "STOP" and "SLOW" signs to alternately control right-of-way.

Signs for the AFAD shall be according to Article 701.03 of the Standard Specifications and the MUTCD. The signs shall be 24 x 24 in. (600 x 600 mm) having an octagon shaped "STOP" sign on one side and a diamond shaped "SLOW" sign on the opposite side. The letters on the signs shall be 8 in. (200 mm) high. If the "STOP" sign has louvers, the full sign face shall be visible at a distance of 50 ft (15 m) and greater.

The signs shall be supplemented with one of the following types of lights.

- (a) Flashing Lights. When flashing lights are used, white or red flashing lights shall be mounted within the "STOP" sign face and white or yellow flashing lights within the "SLOW" sign face.
- (b) Stop and Warning Beacons. When beacons are used, a stop beacon shall be mounted 24 in. (600 mm) or less above the "STOP" sign face and a warning beacon mounted 24 in. (600 mm) or less above, below, or to the side of the "SLOW" sign face. As an option, a Type B warning light may be used in lieu of the warning beacon.

A "WAIT ON STOP" sign shall be placed on the right hand side of the roadway at a point where drivers are expected to stop. The sign shall be 24 x 30 in. (600 x 750 mm) with a black legend and border on a white background. The letters shall be at least 6 in. (150 mm) high.

This device may include a gate arm or mast arm that descends to a horizontal position when the "STOP" sign is displayed and rises to a vertical position when the "SLOW" sign is displayed. When included, the end of the arm shall reach at least to the center of the lane being controlled. The arm shall have alternating red and white retroreflective stripes, on both sides, sloping downward at 45 degrees toward the side on which traffic will pass. The stripes shall be 6 in. (150 mm) in width and at least 2 in. (50 mm) in height.

Flagging Requirements. Flaggers and flagging requirements shall be according to Article 701.13 of the Standard Specifications and the following.

AFADs shall be placed at each end of the traffic control, where a flagger is shown on the plans. The flaggers shall be able to view the face of the AFAD and approaching traffic during operation.

To stop traffic, the "STOP" sign shall be displayed, the corresponding lights/beacon shall flash, and when included, the gate arm shall descend to a horizontal position. To permit traffic to move, the "SLOW" sign shall be displayed, the corresponding lights/beacon shall flash, and when included, the gate arm shall rise to a vertical position.

If used at night, the AFAD location shall be illuminated according to Section 701 of the Standard Specifications.

When not in use, AFADs will be considered nonoperating equipment and shall be stored according to Article 701.11 of the Standard Specifications.

Basis of Payment. This work will not be paid for separately but shall be considered as included in the cost of the various traffic control items included in the contract.

## **DISADVANTAGED BUSINESS ENTERPRISE PARTICIPATION (BDE)**

Effective: September 1, 2000

Revised: August 2, 2011

FEDERAL OBLIGATION. The Department of Transportation, as a recipient of federal financial assistance, is required to take all necessary and reasonable steps to ensure nondiscrimination in the award and administration of contracts. Consequently, the federal regulatory provisions of 49 CFR Part 26 apply to this contract concerning the utilization of disadvantaged business enterprises. For the purposes of this Special Provision, a disadvantaged business enterprise (DBE) means a business certified by the Department in accordance with the requirements of 49 CFR Part 26 and listed in the Illinois Unified Certification Program (IL UCP) DBE Directory.

STATE OBLIGATION. This Special Provision will also be used by the Department to satisfy the requirements of the Business Enterprise for Minorities, Females, and Persons with Disabilities Act, 30 ILCS 575. When this Special Provision is used to satisfy state law requirements on 100 percent state-funded contracts, the federal government has no involvement in such contracts (not a federal-aid contract) and no responsibility to oversee the implementation of this Special Provision by the Department on those contracts. DBE participation on 100 percent state-funded contracts will not be credited toward fulfilling the Department's annual overall DBE goal required by the US Department of Transportation to comply with the federal DBE program requirements.

CONTRACTOR ASSURANCE. The Contractor makes the following assurance and agrees to include the assurance in each subcontract that the Contractor signs with a subcontractor.

The Contractor, subrecipient, or subcontractor shall not discriminate on the basis of race, color, national origin, or sex in the performance of this contract. The Contractor shall carry out applicable requirements of 49 CFR Part 26 in the award and administration of contracts funded in whole or in part with federal or state funds. Failure by the Contractor to carry out these requirements is a material breach of this contract, which may result in the termination of this contract or such other remedy as the recipient deems appropriate.

OVERALL GOAL SET FOR THE DEPARTMENT. As a requirement of compliance with 49 CFR Part 26, the Department has set an overall goal for DBE participation in its federally assisted contracts. That goal applies to all federal-aid funds the Department will expend in its federally assisted contracts for the subject reporting fiscal year. The Department is required to make a good faith effort to achieve the overall goal. The dollar amount paid to all approved DBE companies performing work called for in this contract is eligible to be credited toward fulfillment of the Department's overall goal.

CONTRACT GOAL TO BE ACHIEVED BY THE CONTRACTOR. This contract includes a specific DBE utilization goal established by the Department. The goal has been included because the Department has determined that the work of this contract has subcontracting opportunities that may be suitable for performance by DBE companies. The determination is based on an assessment of the type of work, the location of the work, and the availability of DBE companies to do a part of the work. The assessment indicates that, in the absence of unlawful discrimination, and in an arena of fair and open competition, DBE companies can be expected to perform **15.00%** of the work. This percentage is set as the DBE participation goal for this contract. Consequently, in addition to the other award criteria established for this contract, the Department will only award this contract to a bidder who makes a good faith effort to meet this goal of DBE participation in the performance of the work. A bidder makes a good faith effort for award consideration if either of the following is done in accordance with the procedures set for in this Special Provision:

- (a) The bidder documents that enough DBE participation has been obtained to meet the goal: or
- (b) The bidder documents that a good faith effort has been made to meet the goal, even though the effort did not succeed in obtaining enough DBE participation to meet the goal.

DBE LOCATOR REFERENCES. Bidders shall consult the IL UCP DBE Directory as a reference source for DBE-certified companies. In addition, the Department maintains a letting and item specific DBE locator information system whereby DBE companies can register their interest in providing quotes on particular bid items advertised for letting. Information concerning DBE companies willing to quote work for particular contracts may be obtained by contacting the Department's Bureau of Small Business Enterprises at telephone number (217)785-4611, or by visiting the Department's website at [www.dot.il.gov](http://www.dot.il.gov).

BIDDING PROCEDURES. Compliance with this Special Provision is a material bidding requirement. The failure of the bidder to comply will render the bid not responsive.

- (a) The bidder shall submit a Disadvantaged Business Utilization Plan on Department forms SBE 2025 and 2026 with the bid.
- (b) The Utilization Plan shall indicate that the bidder either has obtained sufficient DBE participation commitments to meet the contract goal or has not obtained enough DBE participation commitments in spite of a good faith effort to meet the goal. The Utilization Plan shall further provide the name, telephone number, and telefax number of a responsible official of the bidder designated for purposes of notification of plan approval or disapproval under the procedures of this Special Provision.
- (c) The Utilization Plan shall include a DBE Participation Commitment Statement, Department form SBE 2025, for each DBE proposed for the performance of work to achieve the contract goal. For bidding purposes, submission of the completed SBE 2025 forms, signed by the DBEs and faxed to the bidder will be acceptable as long as the original is available and provided upon request. All elements of information indicated on the said form shall be provided, including but not limited to the following:
  - (1) The names and addresses of DBE firms that will participate in the contract;
  - (2) A description, including pay item numbers, of the work each DBE will perform;
  - (3) The dollar amount of the participation of each DBE firm participating. The dollar amount of participation for identified work shall specifically state the quantity, unit price, and total subcontract price for the work to be completed by the DBE. If partial pay items are to be performed by the DBE, indicate the portion of each item, a unit price where appropriate and the subcontract price amount;
  - (4) DBE Participation Commitment Statements, form SBE 2025, signed by the bidder and each participating DBE firm documenting the commitment to use the DBE subcontractors whose participation is submitted to meet the contract goal;
  - (5) if the bidder is a joint venture comprised of DBE companies and non-DBE companies, the plan must also include a clear identification of the portion of the work to be performed by the DBE partner(s); and,
  - (6) If the contract goal is not met, evidence of good faith efforts.

GOOD FAITH EFFORT PROCEDURES. The contract will not be awarded until the Utilization Plan submitted by the apparent successful bidder is approved. All information submitted by the bidder must be complete, accurate and adequately document that enough DBE participation has been obtained or document that good faith efforts of the bidder, in the event enough DBE participation has not been obtained, before the Department will commit to the performance of the contract by the bidder. The Utilization Plan will be approved by the Department if the Utilization Plan documents sufficient commercially useful DBE work performance to meet the contract goal or the bidder submits sufficient documentation of a good faith effort to meet the contract goal pursuant to 49 CFR Part 26, Appendix A. The Utilization Plan will not be approved by the Department if the Utilization Plan does not document sufficient DBE participation to meet the contract goal unless the apparent successful bidder documented in the Utilization Plan that it made a good faith effort to meet the goal. This means that the bidder must show that all necessary and reasonable steps were taken to achieve the contract goal. Necessary and reasonable steps are those which, by their scope, intensity and appropriateness to the objective, could reasonably be expected to obtain sufficient DBE participation, even if they were not successful. The Department will consider the quality, quantity, and intensity of the kinds of efforts that the bidder has made. Mere *pro forma* efforts, in other words, efforts done as a matter of form, are not good faith efforts; rather, the bidder is expected to have taken genuine efforts that would be reasonably expected of a bidder actively and aggressively trying to obtain DBE participation sufficient to meet the contract goal.

- (a) The following is a list of types of action that the Department will consider as part of the evaluation of the bidder's good faith efforts to obtain participation. These listed factors are not intended to be a mandatory checklist and are not intended to be exhaustive. Other factors or efforts brought to the attention of the Department may be relevant in appropriate cases, and will be considered by the Department.
  - (1) Soliciting through all reasonable and available means (e.g. attendance at pre-bid meetings, advertising and/or written notices) the interest of all certified DBE companies that have the capability to perform the work of the contract. The bidder must solicit this interest within sufficient time to allow the DBE companies to respond to the solicitation. The bidder must determine with certainty if the DBE companies are interested by taking appropriate steps to follow up initial solicitations.
  - (2) Selecting portions of the work to be performed by DBE companies in order to increase the likelihood that the DBE goals will be achieved. This includes, where appropriate, breaking out contract work items into economically feasible units to facilitate DBE participation, even when the prime Contractor might otherwise prefer to perform these work items with its own forces.
  - (3) Providing interested DBE companies with adequate information about the plans, specifications, and requirements of the contract in a timely manner to assist them in responding to a solicitation.

- (4) a. Negotiating in good faith with interested DBE companies. It is the bidder's responsibility to make a portion of the work available to DBE subcontractors and suppliers and to select those portions of the work or material needs consistent with the available DBE subcontractors and suppliers, so as to facilitate DBE participation. Evidence of such negotiation includes the names, addresses, and telephone numbers of DBE companies that were considered; a description of the information provided regarding the plans and specifications for the work selected for subcontracting; and evidence as to why additional agreements could not be reached for DBE companies to perform the work.
    - b. A bidder using good business judgment would consider a number of factors in negotiating with subcontractors, including DBE subcontractors, and would take a firm's price and capabilities as well as contract goals into consideration. However, the fact that there may be some additional costs involved in finding and using DBE companies is not in itself sufficient reason for a bidder's failure to meet the contract DBE goal, as long as such costs are reasonable. Also the ability or desire of a bidder to perform the work of a contract with its own organization does not relieve the bidder of the responsibility to make good faith efforts. Bidders are not, however, required to accept higher quotes from DBE companies if the price difference is excessive or unreasonable.
  - (5) Not rejecting DBE companies as being unqualified without sound reasons based on a thorough investigation of their capabilities. The bidder's standing within its industry, membership in specific groups, organizations, or associations and political or social affiliations (for example union vs. non-union employee status) are not legitimate causes for the rejection or non-solicitation of bids in the bidder's efforts to meet the project goal.
  - (6) Making efforts to assist interested DBE companies in obtaining bonding, lines of credit, or insurance as required by the recipient or Contractor.
  - (7) Making efforts to assist interested DBE companies in obtaining necessary equipment, supplies, materials, or related assistance or services.
  - (8) Effectively using the services of available minority/women community organizations; minority/women contractors' groups; local, state, and federal minority/women business assistance offices; and other organizations as allowed on a case-by-case basis to provide assistance in the recruitment and placement of DBE companies.
- (b) If the Department determines that the apparent successful bidder has made a good faith effort to secure the work commitment of DBE companies to meet the contract goal, the Department will award the contract provided that it is otherwise eligible for award. If the Department determines that the bidder has failed to meet the requirements of this Special Provision or that a good faith effort has not been made, the Department will notify the responsible company official designated in the Utilization Plan that the bid is not responsive. The notification shall include a statement of reasons for the determination.



- (c) The bidder may request administrative reconsideration of a determination adverse to the bidder within the five working days after the receipt of the notification date of the determination by delivering the request to the Department of Transportation, Bureau of Small Business Enterprises, Contract Compliance Section, 2300 South Dirksen Parkway, Room 319, Springfield, Illinois 62764 (Telefax: (217)785-1524). Deposit of the request in the United States mail on or before the fifth business day shall not be deemed delivery. The determination shall become final if a request is not made and delivered. A request may provide additional written documentation and/or argument concerning the issues raised in the determination statement of reasons, provided the documentation and arguments address efforts made prior to submitting the bid. The request will be forwarded to the Department's Reconsideration Officer. The Reconsideration Officer will extend an opportunity to the bidder to meet in person in order to consider all issues of documentation and whether the bidder made a good faith effort to meet the goal. After the review by the Reconsideration Officer, the bidder will be sent a written decision within ten working days after receipt of the request for consideration, explaining the basis for finding that the bidder did or did not meet the goal or make adequate good faith efforts to do so. A final decision by the Reconsideration Officer that a good faith effort was made shall approve the Utilization Plan submitted by the bidder and shall clear the contract for award. A final decision that a good faith effort was not made shall render the bid not responsive.

CALCULATING DBE PARTICIPATION. The Utilization Plan values represent work anticipated to be performed and paid for upon satisfactory completion. The Department is only able to count toward the achievement of the overall goal and the contract goal the value of payments made for the work actually performed by DBE companies. In addition, a DBE must perform a commercially useful function on the contract to be counted. A commercially useful function is generally performed when the DBE is responsible for the work and is carrying out its responsibilities by actually performing, managing, and supervising the work involved. The Department and Contractor are governed by the provisions of 49 CFR Part 26.55(c) on questions of commercially useful functions as it affects the work. Specific counting guidelines are provided in 49 CFR Part 26.55, the provisions of which govern over the summary contained herein.

- (a) DBE as the Contractor: 100 percent goal credit for that portion of the work performed by the DBE's own forces, including the cost of materials and supplies. Work that a DBE subcontracts to a non-DBE does not count toward the DBE goals.
- (b) DBE as a joint venture Contractor: 100 percent goal credit for that portion of the total dollar value of the contract equal to the distinct, clearly defined portion of the work performed by the DBE's own forces.
- (c) DBE as a subcontractor: 100 percent goal credit for the work of the subcontract performed by the DBE's own forces, including the cost of materials and supplies, excluding the purchase of materials and supplies or the lease of equipment by the DBE subcontractor from the prime Contractor or its affiliates. Work that a DBE subcontractor in turn subcontracts to a non-DBE does not count toward the DBE goal.

- (d) DBE as a trucker: 100 percent goal credit for trucking participation provided the DBE is responsible for the management and supervision of the entire trucking operation for which it is responsible. At least one truck owned, operated, licensed, and insured by the DBE must be used on the contract. Credit will be given for the following:
- (1) The DBE may lease trucks from another DBE firm, including an owner-operator who is certified as a DBE. The DBE who leases trucks from another DBE receives credit for the total value of the transportation services the lessee DBE provides on the contract.
  - (2) The DBE may also lease trucks from a non-DBE firm, including from an owner-operator. The DBE who leases trucks from a non-DBE is entitled to credit only for the fee or commission is receives as a result of the lease arrangement.
- (e) DBE as a material supplier:
- (1) 60 percent goal credit for the cost of the materials or supplies purchased from a DBE regular dealer.
  - (2) 100 percent goal credit for the cost of materials of supplies obtained from a DBE manufacturer.
  - (3) 100 percent credit for the value of reasonable fees and commissions for the procurement of materials and supplies if not a regular dealer or manufacturer.

**CONTRACT COMPLIANCE.** Compliance with this Special Provision is an essential part of the contract. The Department is prohibited by federal regulations from crediting the participation of a DBE included in the Utilization Plan toward either the contract goal or the Department's overall goal until the amount to be applied toward the goals has been paid to the DBE. The following administrative procedures and remedies govern the compliance by the Contractor with the contractual obligations established by the Utilization Plan. After approval of the Utilization Plan and award of the contract, the Utilization Plan and individual DBE Participation Statements become part of the contract. If the Contractor did not succeed in obtaining enough DBE participation to achieve the advertised contract goal, and the Utilization Plan was approved and contract awarded based upon a determination of good faith, the total dollar value of DBE work calculated in the approved Utilization Plan as a percentage of the awarded contract value shall become the amended contract goal. All work indicated for performance by an approved DBE shall be performed, managed, and supervised by the DBE executing the Participation Statement.

- (a) **NO AMENDMENT.** No amendment to the Utilization Plan may be made without prior written approval from the Department's Bureau of Small Business Enterprises. All requests for amendment to the Utilization Plan shall be submitted to the Department of Transportation, Bureau of Small Business Enterprises, Contract Compliance Section, 2300 South Dirksen Parkway, Room 319, Springfield, Illinois 62764. Telephone number (217)785-4611. Telefax number (217)785-1524.
- (b) **TERMINATION OR REPLACEMENT.** The Contractor shall not terminate or replace a DBE listed on the approved Utilization Plan, or perform with other forces work designated for a listed DBE except as provided in the Special Provision.

- (c) CHANGES TO WORK. Any deviation from the DBE condition-of-award or contract plans, specifications, or special provisions must be approved, in writing, by the Department as provided elsewhere in the Contract. The Contractor shall notify affected DBEs in writing of any changes in the scope of work which result in a reduction in the dollar amount condition-of-award to the contract. Where the revision includes work committed to a new DBE subcontractor, not previously involved in the project, then a Request for Approval of Subcontractor, Department form BC 260A, must be signed and submitted. If the commitment of work is in the form of additional tasks assigned to an existing subcontract, then a new Request for Approval of Subcontractor shall not be required. However, the Contractor must document efforts to assure that the existing DBE subcontractor is capable of performing the additional work and has agreed in writing to the change.
- (d) ALTERNATIVE WORK METHODS. In addition to the above requirements for reductions in the condition of award, additional requirements apply to the two cases of Contractor-initiated work substitution proposals. Where the contract allows alternate work methods which serve to delete or create underruns in condition of award DBE work, and the Contractor selects that alternate method or, where the Contractor proposes a substitute work method or material that serves to diminish or delete work committed to a DBE and replace it with other work, then the Contractor must demonstrate one of the following:
- (1) That the replacement work will be performed by the same DBE (as long as the DBE is certified in the respective item of work) in a modification of the condition of award; or
  - (2) That the DBE is aware that its work will be deleted or will experience underruns and has agreed in writing to the change. If this occurs, the Contractor shall substitute other work of equivalent value to a certified DBE or provide documentation of good faith efforts to do so; or
  - (3) That the DBE is not capable of performing the replacement work or has declined to perform the work at a reasonable competitive price. If this occurs, the Contractor shall substitute other work of equivalent value to a certified DBE or provide documentation of good faith efforts to do so.
- (e) TERMINATION AND REPLACEMENT PROCEDURES. The Contractor shall not terminate or replace a DBE subcontractor listed in the approved Utilization Plan without prior written consent. This includes, but is not limited to, instances in which the Contractor seeks to perform work originally designated for a DBE subcontractor with its own forces or those of an affiliate, a non-DBE firm, or with another DBE firm. Written consent will be granted only if the Bureau of Small Business Enterprises agrees, for reasons stated in its concurrence document, that the Contractor has good cause to terminate or replace the DBE firm. Before transmitting to the Bureau of Small Business Enterprises any request to terminate and/or substitute a DBE subcontractor, the Contractor shall give notice in writing to the DBE subcontractor, with a copy to the Bureau, of its intent to request to terminate and/or substitute, and the reason for the request. The Contractor shall give the DBE five days to respond to the Contractor's notice. The DBE so notified shall advise the Bureau and the Contractor of the reasons, if any, why it objects to the proposed termination of its subcontract and why the Bureau should not approve the Contractor's action. If required in a particular case as a matter of public necessity, the Bureau may provide a response period shorter than five days.

For purposes of this paragraph, good cause includes the following circumstances:

- (1) The listed DBE subcontractor fails or refuses to execute a written contract;
- (2) The listed DBE subcontractor fails or refuses to perform the work of its subcontract in a way consistent with normal industry standards. Provided, however, that good cause does not exist if the failure or refusal of the DBE subcontractor to perform its work on the subcontract results from the bad faith or discriminatory action of the prime contractor;
- (3) The listed DBE subcontractor fails or refuses to meet the prime Contractor's reasonable, nondiscriminatory bond requirements;
- (4) The listed DBE subcontractor becomes bankrupt, insolvent, or exhibits credit unworthiness;
- (5) The listed DBE subcontractor is ineligible to work on public works projects because of suspension and debarment proceedings pursuant 2 CFR Parts 180, 215 and 1,200 or applicable state law.
- (6) You have determined that the listed DBE subcontractor is not a responsible contractor;
- (7) The listed DBE subcontractor voluntarily withdraws from the projects and provides to you written notice of its withdrawal;
- (8) The listed DBE is ineligible to receive DBE credit for the type of work required;
- (9) A DBE owner dies or becomes disabled with the result that the listed DBE contractor is unable to complete its work on the contract;
- (10) Other documented good cause that compels the termination of the DBE subcontractor. Provided, that good cause does not exist if the prime Contractor seeks to terminate a DBE it relied upon to obtain the contract so that the prime Contractor can self-perform the work for which the DBE contractor was engaged or so that the prime Contractor can substitute another DBE or non-DBE contractor after contract award.

When a DBE is terminated, or fails to complete its work on the Contract for any reason the Contractor shall make a good faith effort to find another DBE to substitute for the original DBE to perform at least the same amount of work under the contract as the terminated DBE to the extent needed to meet the established Contract goal.

- (f) PAYMENT RECORDS. The Contractor shall maintain a record of payments for work performed to the DBE participants. The records shall be made available to the Department for inspection upon request. After the performance of the final item of work or delivery of material by a DBE and final payment therefore to the DBE by the Contractor, but not later than thirty calendar days after payment has been made by the Department to the Contractor for such work or material, the Contractor shall submit a DBE Payment Agreement on Department form SBE 2115 to the Regional Engineer. If full and final payment has not been made to the DBE, the DBE Payment Agreement shall indicate whether a disagreement as to the payment required exists between the Contractor and the DBE or if the Contractor believes that the work has not been satisfactorily completed. If the Contractor does not have the full amount of work indicated in the Utilization Plan performed by the BDE companies indicated in the Utilization Plan and after good faith efforts are reviewed, the Department may deduct from contract payments to the Contractor the amount of the goal not achieved as liquidated and ascertained damages. The Contractor may request an administrative reconsideration of any amount deducted as damages pursuant to subsection (h) of this part.
- (g) ENFORCEMENT. The Department reserves the right to withhold payment to the Contractor to enforce the provisions of this Special Provision. Final payment shall not be made on the contract until such time as the Contractor submits sufficient documentation demonstrating achievement of the goal in accordance with this Special Provision or after liquidated damages have been determined and collected.
- (h) RECONSIDERATION. Notwithstanding any other provision of the contract, including but not limited to Article 109.09 of the Standard Specifications, the Contractor may request administrative reconsideration of a decision to deduct the amount of the goal not achieved as liquidated damages. A request to reconsider shall be delivered to the Contract Compliance Section and shall be handled and considered in the same manner as set forth in paragraph (c) of "Good Faith Effort Procedures" of this Special Provision, except a final decision that a good faith effort was not made during contract performance to achieve the goal agreed to in the Utilization Plan shall be the final administrative decision of the Department.

## **FRICITION AGGREGATE (BDE)**

Effective: January 1, 2011

Revise Article 1004.01(a)(4) of the Standard Specifications to read:

- “ (4) Crushed Stone. Crushed stone shall be the angular fragments resulting from crushing undisturbed, consolidated deposits of rock by mechanical means. Crushed stone shall be divided into the following, when specified.
- a. Carbonate Crushed Stone. Carbonate crushed stone shall be either dolomite or limestone. Dolomite shall contain 11.0 percent or more magnesium oxide (MgO). Limestone shall contain less than 11.0 percent magnesium oxide (MgO).

b. Crystalline Crushed Stone. Crystalline crushed stone shall be either metamorphic or igneous stone, including but is not limited to, quartzite, granite, rhyolite and diabase.”

Revise Article 1004.03(a) of the Standard Specifications to read:

“**1004.03 Coarse Aggregate for Hot-Mix Asphalt (HMA).** The aggregate shall be according to Article 1004.01 and the following.

(a) Description. The coarse aggregate for HMA shall be according to the following table.

Use	Mixture	Aggregates Allowed
Class A	Seal or Cover	<u>Allowed Alone or in Combination:</u> Gravel Crushed Gravel Carbonate Crushed Stone Crystalline Crushed Stone Crushed Sandstone Crushed Slag (ACBF) Crushed Steel Slag Crushed Concrete
HMA All Other	Stabilized Subbase Shoulders	<u>Allowed Alone or in Combination:</u> Gravel Crushed Gravel Carbonate Crushed Stone Crystalline Crushed Stone Crushed Sandstone Crushed Slag (ACBF) Crushed Steel Slag <sup>1/</sup> Crushed Concrete

HMA High ESAL Low ESAL	Binder IL-25.0, IL-19.0, or IL-19.0L  SMA Binder	<u>Allowed Alone or in Combination:</u> Crushed Gravel Carbonate Crushed Stone <sup>2/</sup> Crystalline Crushed Stone Crushed Sandstone Crushed Slag (ACBF) Crushed Concrete <sup>3/</sup>								
HMA High ESAL Low ESAL	C Surface and Leveling Binder IL-12.5,IL-9.5, or IL-9.5L  SMA Ndesign 50 Surface	<u>Allowed Alone or in Combination:</u> Crushed Gravel Carbonate Crushed Stone <sup>2/</sup> Crystalline Crushed Stone Crushed Sandstone Crushed Slag (ACBF) Crushed Steel Slag <sup>4/</sup> Crushed Concrete <sup>3/</sup>								
HMA High ESAL	D Surface and Leveling Binder IL-12.5 or IL-9.5  SMA Ndesign 50 Surface	<u>Allowed Alone or in Combination:</u> Crushed Gravel Carbonate Crushed Stone (other than Limestone) <sup>2/</sup> Crystalline Crushed Stone Crushed Sandstone Crushed Slag (ACBF) <sup>5/</sup> Crushed Steel Slag <sup>4/ 5/</sup> Crushed Concrete <sup>3/</sup>  <u>Other Combinations Allowed:</u> <table border="1" data-bbox="703 1186 1291 1606"> <thead> <tr> <th data-bbox="703 1249 1015 1291"><i>Up to...</i></th> <th data-bbox="1015 1249 1291 1291"><i>With...</i></th> </tr> </thead> <tbody> <tr> <td data-bbox="703 1291 1015 1344">25% Limestone</td> <td data-bbox="1015 1291 1291 1344">Dolomite</td> </tr> <tr> <td data-bbox="703 1344 1015 1459">50% Limestone</td> <td data-bbox="1015 1344 1291 1459">Any Mixture D aggregate other than Dolomite</td> </tr> <tr> <td data-bbox="703 1459 1015 1606">75% Limestone</td> <td data-bbox="1015 1459 1291 1606">Crushed Slag (ACBF)<sup>5/</sup> or Crushed Sandstone</td> </tr> </tbody> </table>	<i>Up to...</i>	<i>With...</i>	25% Limestone	Dolomite	50% Limestone	Any Mixture D aggregate other than Dolomite	75% Limestone	Crushed Slag (ACBF) <sup>5/</sup> or Crushed Sandstone
<i>Up to...</i>	<i>With...</i>									
25% Limestone	Dolomite									
50% Limestone	Any Mixture D aggregate other than Dolomite									
75% Limestone	Crushed Slag (ACBF) <sup>5/</sup> or Crushed Sandstone									

HMA High ESAL	E Surface IL-12.5 or IL-9.5  SMA Ndesign 80 Surface	<u>Allowed Alone or in Combination:</u>	
		Crushed Gravel Crystalline Crushed Stone Crushed Sandstone Crushed Slag (ACBF) <sup>5/</sup> Crushed Steel Slag <sup>5/</sup> Crushed Concrete <sup>3/</sup>  No Limestone.	
		<u>Other Combinations Allowed:</u>	
		<i>Up to...</i>	<i>With...</i>
		50% Dolomite <sup>2/</sup>	Any Mixture E aggregate
75% Dolomite <sup>2/</sup>	Crushed Sandstone, Crushed Slag (ACBF) <sup>5/</sup> , Crushed Steel Slag <sup>5/</sup> , or Crystalline Crushed Stone		
75% Crushed Gravel or Crushed Concrete <sup>3/</sup>	Crushed Sandstone, Crystalline Crushed Stone, Crushed Slag (ACBF) <sup>5/</sup> , or Crushed Steel Slag <sup>5/</sup>		
HMA High ESAL	F Surface IL-12.5 or IL-9.5  SMA Ndesign 80 Surface	<u>Allowed Alone or in Combination:</u>	
		Crystalline Crushed Stone Crushed Sandstone Crushed Slag (ACBF) <sup>5/</sup> Crushed Steel Slag <sup>5/</sup> No Limestone.	
		<u>Other Combinations Allowed:</u>	
		<i>Up to...</i>	<i>With...</i>
		50% Crushed Gravel, Crushed Concrete <sup>3/</sup> , or Dolomite <sup>2/</sup>	Crushed Sandstone, Crushed Slag (ACBF) <sup>5/</sup> , Crushed Steel Slag <sup>5/</sup> , or Crystalline Crushed Stone

- 1/ Crushed steel slag allowed in shoulder surface only.
- 2/ Carbonate crushed stone shall not be used in SMA Ndesign 80. In SMA Ndesign 50, carbonate crushed stone shall not be blended with any of the other aggregates allowed alone in Ndesign 50 SMA binder or Ndesign 50 SMA surface.



- 3/ Crushed concrete will not be permitted in SMA mixes.
- 4/ Crushed steel slag shall not be used as leveling binder.
- 5/ When either slag is used, the blend percentages listed shall be by volume.”

## **HOT-MIX ASPHALT – MIXTURE DESIGN COMPOSITION AND VOLUMETRIC REQUIREMENTS (BDE)**

Effective: November 1, 2013

Revise Article 406.14(b) of the Standard Specifications to read.

- “(b) If the HMA placed during the initial test strip (1) is determined to be unacceptable to remain in place by the Engineer, and (2) was not produced within 2.0 to 6.0 percent air voids or within the individual control limits of the JMF, the mixture and test strip will not be paid for and the mixture shall be removed at the Contractor’s expense. An additional test strip and mixture will be paid for in full, if produced within 2.0 to 6.0 percent air voids and within the individual control limits of the JMF.”

Revise Article 406.14(c) of the Standard Specifications to read.

- “(c) If the HMA placed during the initial test strip (1) is determined to be unacceptable to remain in place by the Engineer, and (2) was produced within 2.0 to 6.0 percent air voids and within the individual control limits of the JMF, the mixture shall be removed. Removal will be paid in accordance to Article 109.04. This initial mixture and test strip will be paid for at the contract unit prices. The additional mixture will be paid for at the contract unit price, and any additional test strips will be paid for at one half the unit price of each test strip.”

Revise Article 1030.04(a)(1) of the Standard Specifications to read.

“(1) High ESAL Mixtures. The Job Mix Formula (JMF) shall fall within the following limits.

High ESAL, MIXTURE COMPOSITION (% PASSING) <sup>1/</sup>										
Sieve Size	IL-25.0 mm		IL-19.0 mm		IL-12.5 mm		IL-9.5 mm		IL-4.75 mm	
	min	max	min	max	min	max	min	max	min	max
1 1/2 in. (37.5 mm)		100								
1 in. (25 mm)	90	100		100						
3/4 in. (19 mm)		90	82	100		100				
1/2 in. (12.5 mm)	45	75	50	85	90	100		100		100
3/8 in. (9.5 mm)						89	90	100		100
#4 (4.75 mm)	24	42 <sup>2/</sup>	24	50 <sup>2/</sup>	28	65	32	69	90	100
#8 (2.36 mm)	16	31	20	36	28	48 <sup>3/</sup>	32	52 <sup>3/</sup>	70	90
#16 (1.18 mm)	10	22	10	25	10	32	10	32	50	65
#50 (300 μm)	4	12	4	12	4	15	4	15	15	30
#100 (150 μm)	3	9	3	9	3	10	3	10	10	18
#200 (75 μm)	3	6	3	6	4	6	4	6	7	9
Ratio Dust/Asphalt Binder		1.0		1.0		1.0		1.0		1.0 <sup>4/</sup>

1/ Based on percent of total aggregate weight.

2/ The mixture composition shall not exceed 40 percent passing the #4 (4.75 mm) sieve for binder courses with Ndesign ≥ 90.

3/ The mixture composition shall not exceed 44 percent passing the #8 (2.36 mm) sieve for surface courses with Ndesign ≥ 90.

4/ Additional minus No. 200 (0.075 mm) material required by the mix design shall be mineral filler, unless otherwise approved by the Engineer.”

Delete Article 1030.04(a)(4) of the Standard Specifications.

Revise Article 1030.04(b)(1) of the Standard Specifications to read.

“(1) High ESAL Mixtures. The target value for the air voids of the HMA shall be 4.0 percent at the design number of gyrations. The VMA and VFA of the HMA design shall be based on the nominal maximum size of the aggregate in the mix, and shall conform to the following requirements.

VOLUMETRIC REQUIREMENTS High ESAL						
Ndesign	Voids in the Mineral Aggregate (VMA), % minimum					Voids Filled with Asphalt Binder (VFA), %
	IL-25.0	IL-19.0	IL-12.5	IL-9.5	IL-4.75 <sup>1/</sup>	
50	12.0	13.0	14.0	15.0	18.5	65 – 78 <sup>2/</sup>
70					65 - 75	
90						
105						

1/ Maximum Draindown for IL-4.75 shall be 0.3 percent

2/ VFA for IL-4.75 shall be 76-83 percent”

Delete Article 1030.04(b)(4) of the Standard Specifications.

Revise the Control Limits Table in Article 1030.05(d)(4) of the Standard Specifications to read.

“CONTROL LIMITS					
Parameter	High ESAL Low ESAL	High ESAL Low ESAL	All Other	IL-4.75	IL-4.75
	Individual Test	Moving Avg. of 4	Individual Test	Individual Test	Moving Avg. of 4
% Passing: <sup>1/</sup>					
1/2 in. (12.5 mm)	± 6 %	± 4 %	± 15 %		
No. 4 (4.75 mm)	± 5 %	± 4 %	± 10 %		
No. 8 (2.36 mm)	± 5 %	± 3 %			
No. 16 (1.18 mm)				± 4 %	± 3 %
No. 30 (600 µm)	± 4 %	± 2.5 %			
Total Dust Content No. 200 (75 µm)	± 1.5 %	± 1.0 %	± 2.5 %	± 1.5 %	± 1.0 %
Asphalt Binder Content	± 0.3 %	± 0.2 %	± 0.5 %	± 0.3 %	± 0.2 %
Voids	± 1.2 %	± 1.0 %	± 1.2 %	± 1.2 %	± 1.0 %
VMA	-0.7 % <sup>2/</sup>	-0.5 % <sup>2/</sup>		-0.7 % <sup>2/</sup>	-0.5 % <sup>2/</sup>

1/ Based on washed ignition oven

2/ Allowable limit below minimum design VMA requirement”

**HOT-MIX ASPHALT – MIXTURE DESIGN VERIFICATION AND PRODUCTION (BDE)**

Effective: November 1, 2013

Description. This special provision provides the requirements for Hamburg Wheel and tensile strength testing for High ESAL, IL-4.75, and Stone Matrix Asphalt (SMA) hot-mix asphalt (HMA) mixes during mix design verification and production. This special provision also provides the plant requirements for hydrated lime addition systems used in the production of High ESAL, IL-4.75, and SMA mixes.

Mix Design Testing. Add the following to Article 1030.04 of the Standard Specifications:

“(d) Verification Testing. High ESAL, IL-4.75, and SMA mix designs submitted for verification will be tested to ensure that the resulting mix designs will pass the required criteria for the Hamburg Wheel Test (Illinois Modified AASHTO T 324) and the Tensile Strength Test (Illinois Modified AASHTO T 283). The Department will perform a verification test on gyratory specimens compacted by the Contractor. If the mix fails the Department’s verification test, the Contractor shall make necessary changes to the mix and provide passing Hamburg Wheel and tensile strength test results from a private lab. The Department will verify the passing results.

All new and renewal mix designs shall meet the following requirements for verification testing.

(1) Hamburg Wheel Test Criteria. The maximum allowable rut depth shall be 0.5 in. (12.5 mm). The minimum number of wheel passes at the 0.5 in. (12.5 mm) rut depth criteria shall be based on the high temperature binder grade of the mix as specified in the mix requirements table of the plans.

Illinois Modified AASHTO T 324 Requirements <sup>1/</sup>

PG Grade	Number of Passes
PG 58-xx (or lower)	5,000
PG 64-xx	7,500
PG 70-xx	15,000
PG 76-xx (or higher)	20,000

1/ When produced at temperatures of 275 ± 5 °F (135 ± 3 °C) or less, loose Warm Mix Asphalt shall be oven aged at 270 ± 5 °F (132 ± 3 °C) for two hours prior to gyratory compaction of Hamburg Wheel specimens.

(2) Tensile Strength Criteria. The minimum allowable conditioned tensile strength shall be 415 kPa (60 psi) for non-polymer modified performance graded (PG) asphalt binder and 550 kPa (80 psi) for polymer modified PG asphalt binder. The maximum allowable unconditioned tensile strength shall be 1380 kPa (200 psi).”

Production Testing. Revise Article 1030.06(a) of the Standard Specifications to read:

“(a) High ESAL, IL-4.75 and SMA Mixtures. For each contract, a 300 ton (275 metric tons) test strip will be required at the beginning of HMA production for each mixture with a quantity of 3000 tons (2750 metric tons) or more according to the Manual of Test Procedures for Materials “Hot Mix Asphalt Test Strip Procedures”.

Before start-up, target values shall be determined by applying gradation correction factors to the JMF when applicable. These correction factors shall be determined from previous experience. The target values, when approved by the Engineer, shall be used to control HMA production. Plant settings and control charts shall be set according to target values.

Before constructing the test strip, target values shall be determined by applying gradation correction factors to the JMF when applicable. After any JMF adjustment, the JMF shall become the Adjusted Job Mix Formula (AJMF). Upon completion of the first acceptable test strip, the JMF shall become the AJMF regardless of whether or not the JMF has been adjusted. If an adjustment/plant change is made, the Engineer may require a new test strip to be constructed. If the HMA placed during the initial test strip is determined to be unacceptable to remain in place by the Engineer, it shall be removed and replaced.

The limitations between the JMF and AJMF are as follows.

Parameter	Adjustment
1/2 in. (12.5 mm)	± 5.0 %
No. 4 (4.75 mm)	± 4.0 %
No. 8 (2.36 mm)	± 3.0 %
No. 30 (600 µm)	*
No. 200 (75 µm)	*
Asphalt Binder Content	± 0.3 %

\* In no case shall the target for the amount passing be greater than the JMF.

Any adjustments outside the above limitations will require a new mix design.

Mixture sampled to represent the test strip shall include additional material sufficient for the Department to conduct Hamburg Wheel testing according to Illinois Modified AASHTO T324 (approximately 60 lb (27 kg) total).

The Contractor shall immediately cease production upon notification by the Engineer of failing Hamburg Wheel test. All prior produced material may be paved out provided all other mixture criteria is being met. No additional mixture shall be produced until the Engineer receives passing Hamburg Wheel tests.

The Department may conduct additional Hamburg Wheel tests on production material as determined by the Engineer.”

Revise the title of Article 1030.06(b) of the Standard Specifications to read:

“(b) Low ESAL and All Other Mixtures.”

System for Hydrated Lime Addition. Revise the fourth sentence of the third paragraph of Article 1030.04(c) of the Standard Specifications to read:

“The method of application shall be according to Article 1102.01(a)(10).”

Replace the first three sentences of the second paragraph of Article 1102.01(a)(10) of the Standard Specifications to read:

“When hydrated lime is used as the anti-strip additive, a separate bin or tank and feeder system shall be provided to store and accurately proportion the lime onto the aggregate either as a slurry, as dry lime applied to damp aggregates, or as dry lime injected onto the hot aggregates prior to adding the liquid asphalt cement. If the hydrated lime is added either as a slurry or as dry lime on damp aggregates, the lime and aggregates shall be mixed by a power driven pugmill to provide a uniform coating of the lime prior to entering the dryer. If dry hydrated lime is added to the hot dry aggregates in a dryer-drum plant, the lime shall be added in such a manner that the lime will not become entrained into the air stream of the dryer-drum and that thorough dry mixing shall occur prior to the injection point of the liquid asphalt. When a batch plant is used, the hydrated lime shall be added to the mixture in the weigh hopper or as approved by the Engineer.”

Basis of Payment. Replace the seventh paragraph of Article 406.14 of the Standard Specifications with the following:

“For mixes designed and verified under the Hamburg Wheel criteria, the cost of furnishing and introducing anti-stripping additives in the HMA will not be paid for separately, but shall be considered as included in the contract unit price of the HMA item involved.

If an anti-stripping additive is required for any other HMA mix, the cost of the additive will be paid for according to Article 109.04. The cost incurred in introducing the additive into the HMA will not be paid for separately, but shall be considered as included in the contract unit price of the HMA item involved.

No additional compensation will be awarded to the Contractor because of reduced production rates associated with the addition of the anti-stripping additive.”

**PAVEMENT MARKING FOR BIKE SYMBOL (BDE)**

Effective: January 1, 2014

Add the following to the SYMBOLS table in Article 780.14 of the Standard Specifications:

“Symbol	Large Size sq ft (sq m)	Small Size Sq ft (sq m)
Bike Symbol	6.0 (0.56)	--“

FAP Route 327 (US 50)  
Project ACHSIP-0327(059)  
Section (20,21)-J  
Clinton County  
Contract No. 76G67

## **PAYROLLS AND PAYROLL RECORDS (BDE)**

Effective: January 1, 2014

FEDERAL AID CONTRACTS. Revise the following section of Check Sheet #1 of the Recurring Special Provisions to read:

### **“STATEMENTS AND PAYROLLS**

The payroll records shall include the worker’s name, the worker’s address, the worker’s telephone number when available, the worker’s social security number, the worker’s classification or classifications, the worker’s gross and net wages paid in each pay period, the worker’s number of hours worked each day, the worker’s starting and ending times of work each day. However, any Contractor or subcontractor who remits contributions to a fringe benefit fund that is not jointly maintained and jointly governed by one or more employers and one or more labor organization must additionally submit the worker’s hourly wage rate, the worker’s hourly overtime wage rate, the worker’s hourly fringe benefit rates, the name and address of each fringe benefit fund, the plan sponsor of each fringe benefit, if applicable, and the plan administrator of each fringe benefit, if applicable.

The Contractor and each subcontractor shall submit payroll records to the Engineer each week from the start to the completion of their respective work, except that full social security numbers and home addresses shall not be included on weekly transmittals. Instead, the payrolls shall include an identification number for each employee (e.g., the last four digits of the employee’s social security number). In addition, starting and ending times of work each day may be omitted from the payroll records submitted to the Engineer. The submittals shall be on the Department’s form SBE 48, or an approved facsimile. When there has been no activity during a work week, a payroll record shall still be submitted with the appropriate box (“No Work”, “Suspended”, or “Complete”) checked on the form.”

STATE CONTRACTS. Revise Section IV of Check Sheet #5 of the Recurring Special Provisions to read:

### **“IV.COMPLIANCE WITH THE PREVAILING WAGE ACT**

1. Prevailing Wages. All wages paid by the Contractor and each subcontractor shall be in compliance with The Prevailing Wage Act (820 ILCS 130), as amended, except where a prevailing wage violates a federal law, order, or ruling, the rate conforming to the federal law, order, or ruling shall govern. The Contractor shall be responsible to notify each subcontractor of the wage rates set forth in this contract and any revisions thereto. If the Department of Labor revises the wage rates, the Contractor will not be allowed additional compensation on account of said revisions.



2. Payroll Records. The Contractor and each subcontractor shall make and keep, for a period of five years from the later of the date of final payment under the contract or completion of the contract, records of the wages paid to his/her workers. The payroll records shall include the worker's name, the worker's address, the worker's telephone number when available, the worker's social security number, the worker's classification or classifications, the worker's gross and net wages paid in each pay period, the worker's number of hours worked each day, the worker's starting and ending times of work each day. However, any contractor or subcontractor who remits contributions to a fringe benefit fund that is not jointly maintained and jointly governed by one or more employers and one or more labor organization must additionally submit the worker's hourly wage rate, the worker's hourly overtime wage rate, the worker's hourly fringe benefit rates, the name and address of each fringe benefit fund, the plan sponsor of each fringe benefit, if applicable, and the plan administrator of each fringe benefit, if applicable. Upon seven business days' notice, these records shall be available at a location within the State, during reasonable hours, for inspection by the Department or the Department of Labor; and Federal, State, or local law enforcement agencies and prosecutors.
  
3. Submission of Payroll Records. The Contractor and each subcontractor shall submit payroll records to the Engineer each week from the start to the completion of their respective work, except that full social security numbers and home addresses shall not be included on weekly transmittals. Instead the payrolls shall include an identification number for each employee (e.g., the last four digits of the employee's social security number). In addition, starting and ending times of work each day may be omitted from the payroll records submitted to the Engineer. The submittals shall be on the Department's form SBE 48, or an approved facsimile. When there has been no activity during a work week, a payroll record shall still be submitted with the appropriate box ("No Work", "Suspended", or "Complete") checked on the form.

Each submittal shall be accompanied by a statement signed by the Contractor or subcontractor, or an officer, employee, or officer thereof, which avers that: (i) he or she has examined the records and such records are true and accurate; (ii) the hourly rate paid to each worker is not less than the general prevailing rate of hourly wages required by the Act; and (iii) the Contractor or subcontractor is aware that filing a payroll record that he/she knows to be false is a Class A misdemeanor.

4. Employee Interviews. The Contractor and each subcontractor shall permit his/her employees to be interviewed on the job, during working hours, by compliance investigators of the Department or the Department of Labor."

## **PROGRESS PAYMENTS (BDE)**

Effective: November 2, 2013

Revise Article 109.07(a) of the Standard Specifications to read:

“(a) Progress Payments. At least once each month, the Engineer will make a written estimate of the quantity of work performed in accordance with the contract, and the value thereof at the contract unit prices. The amount of the estimate approved as due for payment will be vouchered by the Department and presented to the State Comptroller for payment. No amount less than \$1000.00 will be approved for payment other than the final payment.

Progress payments may be reduced by liens filed pursuant to Section 23(c) of the Mechanics’ Lien Act, 770 ILCS 60/23(c).

If a Contractor or subcontractor has defaulted on a loan issued under the Department’s Disadvantaged Business Revolving Loan Program (20 ILCS 2705/2705-610), progress payments may be reduced pursuant to the terms of that loan agreement. In such cases, the amount of the estimate related to the work performed by the Contractor or subcontractor, in default of the loan agreement, will be offset, in whole or in part, and vouchered by the Department to the Working Capital Revolving Fund or designated escrow account. Payment for the work shall be considered as issued and received by the Contractor or subcontractor on the date of the offset voucher. Further, the amount of the offset voucher shall be a credit against the Department’s obligation to pay the Contractor, the Contractor’s obligation to pay the subcontractor, and the Contractor’s or subcontractor’s total loan indebtedness to the Department. The offset shall continue until such time as the entire loan indebtedness is satisfied. The Department will notify the Contractor and Fund Control Agent in a timely manner of such offset. The Contractor or subcontractor shall not be entitled to additional payment in consideration of the offset.

The failure to perform any requirement, obligation, or term of the contract by the Contractor shall be reason for withholding any progress payments until the Department determines that compliance has been achieved.”

## **RECLAIMED ASPHALT PAVEMENT AND RECLAIMED ASPHALT SHINGLES (BDE)**

Effective: November 1, 2012

Revise: ~~January 1, 2013~~ November 1, 2013

Revise Section 1031 of the Standard Specifications to read:

### **“SECTION 1031. RECLAIMED ASPHALT PAVEMENT AND RECLAIMED ASPHALT SHINGLES**

**1031.01 Description.** Reclaimed asphalt pavement and reclaimed asphalt shingles shall be according to the following.

- (a) Reclaimed Asphalt Pavement (RAP). RAP is the material produced by cold milling or crushing an existing hot-mix asphalt (HMA) pavement. The Contractor shall supply written documentation that the RAP originated from routes or airfields under federal, state, or local agency jurisdiction.
- (b) Reclaimed Asphalt Shingles (RAS). Reclaimed asphalt shingles (RAS). RAS is from the processing and grinding of preconsumer or post-consumer shingles. RAS shall be a clean and uniform material with a maximum of 0.5 percent unacceptable material, as defined in Bureau of Materials and Physical Research Policy Memorandum “Reclaimed Asphalt Shingle (RAS) Sources”, by weight of RAS. All RAS used shall come from a Bureau of Materials and Physical Research approved processing facility where it shall be ground and processed to 100 percent passing the 3/8 in. (9.5 mm) sieve and 93 percent passing the #4 (4.75 mm) sieve based on a dry shake gradation. RAS shall be uniform in gradation and asphalt binder content and shall meet the testing requirements specified herein. In addition, RAS shall meet the following Type 1 or Type 2 requirements.
  - (1) Type 1. Type 1 RAS shall be processed, preconsumer asphalt shingles salvaged from the manufacture of residential asphalt roofing shingles.
  - (2) Type 2. Type 2 RAS shall be processed post-consumer shingles only, salvaged from residential, or four unit or less dwellings not subject to the National Emission Standards for Hazardous Air Pollutants (NESHAP).

**1031.02 Stockpiles.** RAP and RAS stockpiles shall be according to the following.

- (a) RAP Stockpiles. The Contractor shall construct individual, sealed RAP stockpiles meeting one of the following definitions. No additional RAP shall be added to the pile after the pile has been sealed. Stockpiles shall be sufficiently separated to prevent intermingling at the base. Stockpiles shall be identified by signs indicating the type as listed below (i.e. “Homogeneous Surface”).

Prior to milling, the Contractor shall request the District provide documentation on the quality of the RAP to clarify the appropriate stockpile.

- (1) Fractionated RAP (FRAP). FRAP shall consist of RAP from Class I, HMA (High and Low ESAL) mixtures. The coarse aggregate in FRAP shall be crushed aggregate and may represent more than one aggregate type and/or quality but shall be at least C quality. All FRAP shall be fractionated prior to testing by screening into a minimum of two size fractions with the separation occurring on or between the #4 (4.75 mm) and 1/2 in. (12.5 mm) sieves. Agglomerations shall be minimized such that 100 percent of the RAP shall pass the sieve size specified below for the mix into which the FRAP will be incorporated.

Mixture FRAP will be used in:	Sieve Size that 100% of FRAP Shall Pass
IL-25.0	2 in. (50 mm)
IL-19.0	1 1/2 in. (40 mm)
IL-12.5	1 in. (25 mm)
IL-9.5	3/4 in. (20 mm)
IL-4.75	1/2 in. (13 mm)

- (2) Homogeneous. Homogeneous RAP stockpiles shall consist of RAP from Class I, HMA (High and Low ESAL) mixtures and represent: 1) the same aggregate quality, but shall be at least C quality; 2) the same type of crushed aggregate (either crushed natural aggregate, ACBF slag, or steel slag); 3) similar gradation; and 4) similar asphalt binder content. If approved by the Engineer, combined single pass surface/binder millings may be considered “homogenous” with a quality rating dictated by the lowest coarse aggregate quality present in the mixture.
- (3) Conglomerate. Conglomerate RAP stockpiles shall consist of RAP from Class I, HMA (High and Low ESAL) mixtures. The coarse aggregate in this RAP shall be crushed aggregate and may represent more than one aggregate type and/or quality but shall be at least C quality. This RAP may have an inconsistent gradation and/or asphalt binder content prior to processing. All conglomerate RAP shall be processed prior to testing by crushing to where all RAP shall pass the 5/8 in. (16 mm) or smaller screen. Conglomerate RAP stockpiles shall not contain steel slag.
- (4) Conglomerate “D” Quality (DQ). Conglomerate DQ RAP stockpiles shall consist of RAP from Class I, HMA (High or Low ESAL), or “All Other” (as defined by Article 1030.04(a)(3)) mixtures. The coarse aggregate in this RAP may be crushed or round but shall be at least D quality. This RAP may have an inconsistent gradation and/or asphalt binder content. Conglomerate DQ RAP stockpiles shall not contain steel slag.
- (5) Non-Quality. RAP stockpiles that do not meet the requirements of the stockpile categories listed above shall be classified as “Non-Quality”.

RAP/FRAP containing contaminants, such as earth, brick, sand, concrete, sheet asphalt, bituminous surface treatment (i.e. chip seal), pavement fabric, joint sealants, etc., will be unacceptable unless the contaminants are removed to the satisfaction of the Engineer. Sheet asphalt shall be stockpiled separately.

- (b) RAS Stockpiles. Type 1 and Type 2 RAS shall be stockpiled separately and shall not be intermingled. Each stockpile shall be signed indicating what type of RAS is present.

Unless otherwise ~~approved~~ specified by the Engineer, mechanically blending manufactured sand (FM 20 or FM 22) up to an equal weight of RAS with the processed RAS will be permitted to improve workability. The sand shall be "B Quality" or better from an approved Aggregate Gradation Control System source. The sand shall be accounted for in the mix design and during HMA production.

Records identifying the shingle processing facility supplying the RAS, RAS type and lot number shall be maintained by project contract number and kept for a minimum of three years.

**1031.03 Testing.** RAP/FRAP and RAS testing shall be according to the following.

- (a) RAP/FRAP Testing. When used in HMA, the RAP/FRAP shall be sampled and tested either during or after stockpiling.

(1) During Stockpiling. For testing during stockpiling, washed extraction samples shall be run at the minimum frequency of one sample per 500 tons (450 metric tons) for the first 2000 tons (1800 metric tons) and one sample per 2000 tons (1800 metric tons) thereafter. A minimum of five tests shall be required for stockpiles less than 4000 tons (3600 metric tons).

(2) After Stockpiling. For testing after stockpiling, the Contractor shall submit a plan for approval to the District proposing a satisfactory method of sampling and testing the RAP/FRAP pile either in-situ or by restockpiling. The sampling plan shall meet the minimum frequency required above and detail the procedure used to obtain representative samples throughout the pile for testing.

Each sample shall be split to obtain two equal samples of test sample size. One of the two test samples from the final split shall be labeled and stored for Department use. The Contractor shall extract the other test sample according to Department procedure. The Engineer reserves the right to test any sample (split or Department-taken) to verify Contractor test results.

- (b) RAS Testing. RAS or RAS blended with manufactured sand shall be sampled and tested during stockpiling according to Illinois Department of Transportation Policy Memorandum, "Reclaimed Asphalt Shingle (RAS) Source".

Samples shall be collected during stockpiling at the minimum frequency of one sample per 200 tons (180 metric tons) for the first 1000 tons (900 metric tons) and one sample per 250 tons (225 metric tons) thereafter. A minimum of five samples are required for stockpiles less than 1000 tons (900 metric tons). Once a  $\leq 1000$  ton (900 metric ton), five-sample/test stockpile has been established it shall be sealed. Additional incoming RAS or RAS blended with manufactured sand shall be stockpiled in a separate working pile as designated in the Quality Control plan and only added to the sealed stockpile when the test results of the working pile are complete and are found to meet the tolerances specified herein for the original sealed RAS stockpile.

Before testing, each sample shall be split to obtain two test samples. One of the two test samples from the final split shall be labeled and stored for Department use. The Contractor shall perform a washed extraction and test for unacceptable materials on the other test sample according to Department procedures. The Engineer reserves the right to test any sample (split or Department-taken) to verify Contractor test results.

If the sampling and testing was performed at the shingle processing facility in accordance with the QC Plan, the Contractor shall obtain and make available all of the test results from start of the initial stockpile.

**1031.04 Evaluation of Tests.** Evaluation of tests results shall be according to the following.

- (a) Evaluation of RAP/FRAP Test Results. All of the extraction results shall be compiled and averaged for asphalt binder content and gradation and, when applicable  $G_{mm}$ . Individual extraction test results, when compared to the averages, will be accepted if within the tolerances listed below.

Parameter	FRAP/Homogeneous /Conglomerate	Conglomerate "D" Quality
1 in. (25 mm)		± 5 %
1/2 in. (12.5 mm)	± 8 %	± 15 %
No. 4 (4.75 mm)	± 6 %	± 13 %
No. 8 (2.36 mm)	± 5 %	
No. 16 (1.18 mm)		± 15 %
No. 30 (600 μm)	± 5 %	
No. 200 (75 μm)	± 2.0 %	± 4.0 %
Asphalt Binder	± 0.4 % <sup>1/</sup>	± 0.5 %
$G_{mm}$	± 0.03	

1/ The tolerance for FRAP shall be ± 0.3 %.

If more than 20 percent of the individual sieves and/or asphalt binder content tests are out of the above tolerances, the RAP/FRAP shall not be used in HMA unless the RAP/FRAP representing the failing tests is removed from the stockpile. All test data and acceptance ranges shall be sent to the District for evaluation.

With the approval of the Engineer, the ignition oven may be substituted for extractions according to the Illinois Test Procedure, "Calibration of the Ignition Oven for the Purpose of Characterizing Reclaimed Asphalt Pavement (RAP)".

- (b) Evaluation of RAS and RAS Blended with Manufactured Sand Test Results. All of the test results, with the exception of percent unacceptable materials, shall be compiled and averaged for asphalt binder content and gradation. Individual test results, when compared to the averages, will be accepted if within the tolerances listed below.

Parameter	RAS
No. 8 (2.36 mm)	± 5 %
No. 16 (1.18 mm)	± 5 %
No. 30 (600 µm)	± 4 %
No. 200 (75 µm)	± 2.0 %
Asphalt Binder Content	± 1.5 %

If more than 20 percent of the individual sieves and/or asphalt binder content tests are out of the above tolerances, or if the percent unacceptable material exceeds 0.5 percent by weight of material retained on the # 4 (4.75 mm) sieve, the RAS or RAS blend shall not be used in Department projects. All test data and acceptance ranges shall be sent to the District for evaluation.

**1031.05 Quality Designation of Aggregate in RAP/FRAP.**

- (a) RAP. The aggregate quality of the RAP for homogenous, conglomerate, and conglomerate “D” quality stockpiles shall be set by the lowest quality of coarse aggregate in the RAP stockpile and are designated as follows.

- (1) RAP from Class I, Superpave/HMA (High ESAL), or (Low ESAL) IL-9.5L surface mixtures are designated as containing Class B quality coarse aggregate.
- (2) RAP from Superpave/HMA (Low ESAL) IL-19.0L binder mixture is designated as Class D quality coarse aggregate.
- (3) RAP from Class I, Superpave/HMA (High ESAL) binder mixtures, bituminous base course mixtures, and bituminous base course widening mixtures are designated as containing Class C quality coarse aggregate.
- (4) RAP from bituminous stabilized subbase and BAM shoulders are designated as containing Class D quality coarse aggregate.

- (b) FRAP. If the Engineer has documentation of the quality of the FRAP aggregate, the Contractor shall use the assigned quality provided by the Engineer.

If the quality is not known, the quality shall be determined as follows. Coarse and fine FRAP stockpiles containing plus #4 (4.75 mm) sieve coarse aggregate shall have a maximum tonnage of 5,000 tons (4,500 metric tons). The Contractor shall obtain a representative sample witnessed by the Engineer. The sample shall be a minimum of 50 lb (25 kg). The sample shall be extracted according to Illinois Modified AASHTO T 164 by a consultant prequalified by the Department for the specified testing. The consultant shall submit the test results along with the recovered aggregate to the District Office. The cost for this testing shall be paid by the Contractor. The District will forward the sample to the BMPR Aggregate Lab for MicroDeval Testing, according to Illinois Modified AASHTO T 327. A maximum loss of 15.0 percent will be applied for all HMA applications.

**1031.06 Use of RAP/FRAP and/or RAS in HMA.** The use of RAP/FRAP and/or RAS shall be a Contractor's option when constructing HMA in all contracts.

(a) RAP/FRAP. The use of RAP/FRAP in HMA shall be as follows.

- (1) Coarse Aggregate Size. The coarse aggregate in all RAP shall be equal to or less than the nominal maximum size requirement for the HMA mixture to be produced.
- (2) Steel Slag Stockpiles. Homogeneous RAP stockpiles containing steel slag will be approved for use in all HMA (High ESAL and Low ESAL) Surface and Binder Mixture applications.
- (3) Use in HMA Surface Mixtures (High and Low ESAL). RAP/FRAP stockpiles for use in HMA surface mixtures (High and Low ESAL) shall be FRAP or homogeneous in which the coarse aggregate is Class B quality or better. RAP/FRAP from Conglomerate stockpiles shall be considered equivalent to limestone for frictional considerations. Known frictional contributions from plus #4 (4.75 mm) homogeneous RAP and FRAP stockpiles will be accounted for in meeting frictional requirements in the specified mixture.
- (4) Use in HMA Binder Mixtures (High and Low ESAL), HMA Base Course, and HMA Base Course Widening. RAP/FRAP stockpiles for use in HMA binder mixtures (High and Low ESAL), HMA base course, and HMA base course widening shall be FRAP, homogeneous, or conglomerate, in which the coarse aggregate is Class C quality or better.
- (5) Use in Shoulders and Subbase. RAP/FRAP stockpiles for use in HMA shoulders and stabilized subbase (HMA) shall be FRAP, homogeneous, conglomerate, or conglomerate DQ.
- (6) When the Contractor chooses the RAP option, the percentage of RAP shall not exceed the amounts indicated in Article 1031.06(c)(1) below for a given N Design.

(b) RAS. RAS meeting Type 1 or Type 2 requirements will be permitted in all HMA applications as specified herein.

(c) RAP/FRAP and/or RAS Usage Limits. Type 1 or Type 2 RAS may be used alone or in conjunction with RAP or FRAP in HMA mixtures up to a maximum of 5.0% by weight of the total mix.

- (1) RAP/RAS. When RAP is used alone or RAP is used in conjunction with RAS, the percentage of virgin asphalt binder replacement shall not exceed the amounts listed in the Max RAP/RAS ABR table listed below for the given Ndesign.



**RAP/RAS Maximum Asphalt Binder Replacement (ABR) Percentage**

HMA Mixtures <sup>1/, 2/</sup>	RAP/RAS Maximum ABR %		
Ndesign	Binder/Leveling Binder	Surface	Polymer Modified
30	30	30	10
50	25	15	10
70	15	10	10
90	10	10	10
105	10	10	10

1/ For HMA “All Other” (shoulder and stabilized subbase) N-30, the RAP/RAS ABR shall not exceed 50 percent of the mixture.

2/ When RAP/RAS ABR exceeds 20 percent, the high and low virgin asphalt binder grades shall each be reduced by one grade (i.e. 25 percent ABR would require a virgin asphalt binder grade of PG64-22 to be reduced to a PG58-28). If warm mix asphalt (WMA) technology is utilized, and production temperatures do not exceed 275 °F (135 °C) the high and low virgin asphalt binder grades shall each be reduced by one grade when RAP/RAS ABR exceeds 25 percent (i.e. 26 percent RAP/RAS ABR would require a virgin asphalt binder grade of PG64-22 to be reduced to a PG58-28).

(2) FRAP/RAS. When FRAP is used alone or FRAP is used in conjunction with RAS, the percentage of virgin asphalt binder replacement shall not exceed the amounts listed in the FRAP/RAS tables listed below for the given N design.

**~~Level 1 – FRAP/RAS Maximum Asphalt Binder Replacement (ABR) Percentage~~**

<del>HMA Mixtures <sup>1/, 2/</sup></del>	<del>Level 1 – FRAP/RAS Maximum ABR %</del>		
<del>Ndesign</del>	<del>Binder/Leveling Binder</del>	<del>Surface</del>	<del>Polymer Modified <sup>3/, 4/</sup></del>
<del>30</del>	<del>35</del>	<del>35</del>	<del>10</del>
<del>50</del>	<del>30</del>	<del>25</del>	<del>10</del>
<del>70</del>	<del>25</del>	<del>20</del>	<del>10</del>
<del>90</del>	<del>20</del>	<del>15</del>	<del>10</del>
<del>105</del>	<del>10</del>	<del>10</del>	<del>10</del>

~~1/ For HMA “All Other” (shoulder and stabilized subbase) N30, the FRAP/RAS ABR shall not exceed 50 percent of the mixture.~~

~~2/ When FRAP/RAS ABR exceeds 20 percent for all mixes the high and low virgin asphalt binder grades shall each be reduced by one grade (i.e. 25 percent ABR would require a virgin asphalt binder grade of PG64-22 to be reduced to a PG58-28). If warm mix asphalt (WMA) technology is utilized, and production temperatures do not exceed 275 °F (135 °C) the high and low virgin asphalt binder grades shall each be reduced by one grade when FRAP/RAS ABR~~

~~exceeds 25 percent (i.e. 26 percent ABR would require a virgin asphalt binder grade of PG64-22 to be reduced to a PG58-28).~~

~~3/ For SMA the FRAP/RAS ABR shall not exceed 20 percent.~~

~~4/ For IL 4.75 mix the FRAP/RAS ABR shall not exceed 20 percent.~~

**Level 2 – FRAP/RAS Maximum Asphalt Binder Replacement (ABR) Percentage**

HMA Mixtures <i>1/, 2/</i>	<del>Level 2</del> – FRAP/RAS Maximum ABR %		
	Binder/Leveling Binder	Surface	Polymer Modified <sup>3/, 4/</sup>
30	40	40	10
50	40	30	10
70	30	20	10
90	30	20	10
105	30	15	10

1/ For HMA “All Other” (shoulder and stabilized subbase) N30, the FRAP/RAS ABR shall not exceed 50 percent of the mixture.

- 2/ When FRAP/RAS ABR exceeds 20 percent for all mixes the high and low virgin asphalt binder grades shall each be reduced by one grade (i.e. 25 percent ABR would require a virgin asphalt binder grade of PG64-22 to be reduced to a PG58-28). If warm mix asphalt (WMA) technology is utilized, and production temperatures do not exceed 275 °F (135 °C) the high and low virgin asphalt binder grades shall each be reduced by one grade when FRAP/RAS ABR exceeds 25 percent (i.e. 26 percent ABR would require a virgin asphalt binder grade of PG64-22 to be reduced to a PG58-28).
- 3/ For SMA the FRAP/RAS ABR shall not exceed 20 percent.
- 4/ For IL-4.75 mix the FRAP/RAS ABR shall not exceed 30 percent.

**1031.07 HMA Mix Designs.** At the Contractor’s option, HMA mixtures may be constructed utilizing RAP/FRAP and/or RAS material meeting the ~~above~~ detailed requirements specified herein.

~~FRAP/RAS mix designs exceeding the Level 1 FRAP/RAS Maximum ABR percentages shall be tested prior to submittal for verification, according to Illinois Modified AASHTO T 324 (Hamburg Wheel) and shall meet the following requirements.~~

Asphalt Binder Grade	# Repetitions	Max. Rut Depth in.-(mm)
<del>PG76-XX</del>	<del>20,000</del>	<del>1/2 (12.5)</del>
<del>PG70-XX</del>	<del>15,000</del>	<del>1/2 (12.5)</del>
<del>PG64-XX</del>	<del>7,500</del>	<del>1/2 (12.5)</del>
<del>PG58-XX</del>	<del>5,000</del>	<del>1/2 (12.5)</del>

- (a) RAP/FRAP and/or RAS. RAP/FRAP and/or RAS mix designs shall be submitted for ~~volumetric~~ verification. If additional RAP/FRAP stockpiles are tested and found that no more than 20 percent of the results, as defined under “Testing” herein, are outside of the control tolerances set for the original RAP/FRAP stockpile and HMA mix design, and meets all of the requirements herein, the additional RAP/FRAP stockpiles may be used in the original mix design at the percent previously verified.
- (b) RAS. Type 1 and Type 2 RAS are not interchangeable in a mix design. A RAS stone bulk specific gravity (Gsb) of 2.500 shall be used for mix design purposes.

**1031.08 HMA Production.** ~~Mixture production where the FRAP/RAS ABR percentage exceeds the Level 1 limits, shall be sampled within the first 500 tons (450 metric tons) on the first day of production with a split reserved for the Department. The mix sample shall be tested according to the Illinois Modified AASHTO T 324 and shall meet the requirements specified herein. Mix production shall not exceed 1500 tons (1350 metric tons) or one day’s production, whichever comes first, until the testing is completed and the mixture is found to be in conformance. The requirement to cease mix production may be waived if the plant produced mixture conformance is demonstrated prior to start of mix production for a State contract.~~ HMA production utilizing RAP/FRAP and/or RAS shall be as follows.

- (a) RAP/FRAP. The coarse aggregate in all RAP/FRAP used shall be equal to or less than the nominal maximum size requirement for the HMA mixture being produced.

To remove or reduce agglomerated material, a scalping screen, gator, crushing unit, or comparable sizing device approved by the Engineer shall be used in the RAP feed system to remove or reduce oversized material. If material passing the sizing device adversely affects the mix production or quality of the mix, the sizing device shall be set at a size specified by the Engineer.

If the RAP/FRAP control tolerances or QC/QA test results require corrective action, the Contractor shall cease production of the mixture containing RAP/FRAP and either switch to the virgin aggregate design or submit a new RAP/FRAP design.

- (b) RAS. RAS shall be incorporated into the HMA mixture either by a separate weight depletion system or by using the RAP weigh belt. Either feed system shall be interlocked with the aggregate feed or weigh system to maintain correct proportions for all rates of production and batch sizes. The portion of RAS shall be controlled accurately to within  $\pm 0.5$  percent of the amount of RAS utilized. When using the weight depletion system, flow indicators or sensing devices shall be provided and interlocked with the plant controls such that the mixture production is halted when RAS flow is interrupted.

When producing HMA containing RAS, a positive dust control system shall be utilized.

(c) RAP/FRAP and/or RAS. HMA plants utilizing RAP/FRAP and/or RAS shall be capable of automatically recording and printing the following information.

(1) Dryer Drum Plants.

- a. Date, month, year, and time to the nearest minute for each print.
- b. HMA mix number assigned by the Department.
- c. Accumulated weight of dry aggregate (combined or individual) in tons (metric tons) to the nearest 0.1 ton (0.1 metric ton).
- d. Accumulated dry weight of RAP/FRAP/RAS in tons (metric tons) to the nearest 0.1 ton (0.1 metric ton).
- e. Accumulated mineral filler in revolutions, tons (metric tons), etc. to the nearest 0.1 unit.
- f. Accumulated asphalt binder in gallons (liters), tons (metric tons), etc. to the nearest 0.1 unit.
- g. Residual asphalt binder in the RAP/FRAP material as a percent of the total mix to the nearest 0.1 percent.
- h. Aggregate and RAP/FRAP moisture compensators in percent as set on the control panel. (Required when accumulated or individual aggregate and RAP/FRAP are printed in wet condition.)

(2) Batch Plants.

- a. Date, month, year, and time to the nearest minute for each print.
- b. HMA mix number assigned by the Department.
- c. Individual virgin aggregate hot bin batch weights to the nearest pound (kilogram).
- d. Mineral filler weight to the nearest pound (kilogram).
- f. RAP/FRAP/RAS weight to the nearest pound (kilogram).
- g. Virgin asphalt binder weight to the nearest pound (kilogram).
- h. Residual asphalt binder in the RAP/FRAP/RAS material as a percent of the total mix to the nearest 0.1 percent.

The printouts shall be maintained in a file at the plant for a minimum of one year or as directed by the Engineer and shall be made available upon request. The printing system will be inspected by the Engineer prior to production and verified at the beginning of each construction season thereafter.

**1031.09 RAP in Aggregate Surface Course and Aggregate Shoulders.** The use of RAP in aggregate surface course (temporary access entrances only) and aggregate wedge shoulders Type B shall be as follows.

- (a) Stockpiles and Testing. RAP stockpiles may be any of those listed in Article 1031.02, except "Non-Quality" and "FRAP". The testing requirements of Article 1031.03 shall not apply. RAP used to construct aggregate surface course and aggregate shoulders shall be according to the current Bureau of Materials and Physical Research's Policy Memorandum, "Reclaimed Asphalt Pavement (RAP) for Aggregate Applications".
- (b) Gradation. One hundred percent of the RAP material shall pass the 1 1/2 in. (37.5 mm) sieve. The RAP material shall be reasonably well graded from coarse to fine. RAP material that is gap-graded or single sized will not be accepted."

## **REMOVAL AND DISPOSAL OF REGULATED SUBSTANCES (BDE)**

Effective: January 1, 2012

Revised: November 2, 2012

Revise Article 669.01 of the Standard Specifications to read:

**"669.01 Description.** This work shall consist of the transportation and proper disposal of contaminated soil and water. This work shall also consist of the removal, transportation, and proper disposal of underground storage tanks (UST), their content and associated underground piping to the point where the piping is above the ground, including determining the content types and estimated quantities."

Revise Article 669.08 of the Standard Specifications to read:

**"669.08 Contaminated Soil and/or Groundwater Monitoring.** The Contractor shall hire a qualified environmental firm to monitor the area containing the regulated substances. The affected area shall be monitored with a photoionization detector (PID) utilizing a lamp of 10.6eV or greater or a flame ionization detector (FID). Any field screen reading on the PID or FID in excess of background levels indicates the potential presence of contaminated material requiring handling as a non-special waste, special waste, or hazardous waste. No excavated soils can be taken to a clean construction and demolition debris (CCDD) facility or an uncontaminated soil fill operation with detectable PID or FID meter readings that are above background. The PID or FID meter shall be calibrated on-site and background level readings taken and recorded daily. All testing shall be done by a qualified engineer/technician. Such testing and monitoring shall be included in the work. The Contractor shall identify the exact limits of removal of non-special waste, special waste, or hazardous waste. All limits shall be approved by the Engineer prior to excavation. The Contractor shall take all necessary precautions.

Based upon the land use history of the subject property and/or PID or FID readings indicating contamination, a soil or groundwater sample shall be taken from the same location and submitted to an approved laboratory. Soil or groundwater samples shall be analyzed for the contaminants of concern, including pH, based on the property's land use history or the parameters listed in the maximum allowable concentration (MAC) for chemical constituents in uncontaminated soil established pursuant to Subpart F of 35 Illinois Administrative Code 1100.605. The analytical results shall serve to document the level of soil contamination. Soil and groundwater samples may be required at the discretion of the Engineer to verify the level of soil and groundwater contamination.

Samples shall be grab samples (not combined with other locations). The samples shall be taken with decontaminated or disposable instruments. The samples shall be placed in sealed containers and transported in an insulated container to the laboratory. The container shall maintain a temperature of 39 °F (4 °C). All samples shall be clearly labeled. The labels shall indicate the sample number, date sampled, location and elevation, and any other observations.

The laboratory shall use analytical methods which are able to meet the lowest appropriate practical quantitation limits (PQL) or estimated quantitation limit (EQL) specified in "Test Methods for Evaluating Solid Wastes, Physical/Chemical Methods", EPA Publication No. SW-846 and "Methods for the Determination of Organic Compounds in Drinking Water", EPA, EMSL, EPA-600/4-88/039. For parameters where the specified cleanup objective is below the acceptable detection limit (ADL), the ADL shall serve as the cleanup objective. For other parameters the ADL shall be equal to or below the specified cleanup objective."

Replace the first two paragraphs of Article 669.09 of the Standard Specifications with the following:

**"669.09 Contaminated Soil and/or Groundwater Management and Disposal.** The management and disposal of contaminated soil and/or groundwater shall be according to the following:

- (a) Soil Analytical Results Exceed Most Stringent MAC. When the soil analytical results indicate that detected levels exceed the most stringent maximum allowable concentration (MAC) for chemical constituents in uncontaminated soil established pursuant to Subpart F of 35 Illinois Administrative Code 1100.605, the soil shall be managed as follows:
  - (1) When analytical results indicate inorganic chemical constituents exceed the most stringent MAC but they are still considered within area background levels by the Engineer, the excavated soil can be utilized within the construction limits as fill, when suitable. Such soil excavated for storm sewers can be placed back into the excavated trench as backfill, when suitable, unless trench backfill is specified. If the soils cannot be utilized within the construction limits, they shall be managed and disposed of off-site as a non-special waste, special waste, or hazardous waste as applicable.

- (2) When analytical results indicate chemical constituents exceed the most stringent MAC but do not exceed the MAC for a Metropolitan Statistical Area (MSA) County, the excavated soil can be utilized within the construction limits as fill, when suitable, or managed and disposed of off-site as “uncontaminated soil” at a CCDD facility or an uncontaminated soil fill operation within an MSA County provided the pH of the soil is within the range of 6.25 - 9.0, inclusive.
  - (3) When analytical results indicate chemical constituents exceed the most stringent MAC but do not exceed the MAC for an MSA County excluding Chicago, or the MAC within the Chicago corporate limits, the excavated soil can be utilized within the construction limits as fill, when suitable, or managed and disposed of off-site as “uncontaminated soil” at a CCDD facility or an uncontaminated soil fill operation within an MSA County excluding Chicago or within the Chicago corporate limits provided the pH of the soil is within the range of 6.25 - 9.0, inclusive.
  - (4) When analytical results indicate chemical constituents exceed the most stringent MAC but do not exceed the MAC for an MSA County excluding Chicago, the excavated soil can be utilized within the construction limits as fill, when suitable, or managed and disposed of off-site as “uncontaminated soil” at a CCDD facility or an uncontaminated soil fill operation within an MSA County excluding Chicago provided the pH of the soil is within the range of 6.25 - 9.0, inclusive.
  - (5) When the Engineer determines soil cannot be managed according to Articles 669.09(a)(1) through (a)(4) above, the soil shall be managed and disposed of off-site as a non-special waste, special waste, or hazardous waste as applicable.
- (b) Soil Analytical Results Do Not Exceed Most Stringent MAC. When the soil analytical results indicate that detected levels do not exceed the most stringent MAC but the pH of the soil is less than 6.25 or greater than 9.0, the excavated soil can be utilized within the construction limits or managed and disposed of off-site as “uncontaminated soil” according to Article 202.03. However the excavated soil cannot be taken to a CCDD facility or an uncontaminated soil fill operation.
- (c) Groundwater. When groundwater analytical results indicate the detected levels are above Appendix B, Table E of 35 Illinois Administrative Code 742, the most stringent Tier 1 Groundwater Remediation Objectives for Groundwater Component of the Groundwater Ingestion Route for Class 1 groundwater, the groundwater shall be managed off-site as a special waste.

All groundwater encountered within lateral trenches may be managed within the trench and allowed to infiltrate back into the ground. If the groundwater cannot be managed within the trench it must be removed as a special or hazardous waste. The Contractor is prohibited from managing groundwater within the trench by discharging it through any existing or new storm sewer. The Contractor shall install backfill plugs within the area of groundwater contamination.



One backfill plug shall be placed down gradient to the area of groundwater contamination. Backfill plugs shall be installed at intervals not to exceed 50 ft (15 m). Backfill plugs are to be 4 ft (1.2 m) long, measured parallel to the trench, full trench width and depth. Backfill plugs shall not have any fine aggregate bedding or backfill, but shall be entirely cohesive soil or any class of concrete. The Contractor shall provide test data that the material has a permeability of less than  $10^{-7}$  cm/sec according to ASTM D 5084, Method A or per another test method approved by the Engineer.”

Revise Article 669.14 of the Standard Specifications to read:

“**669.14 Final Environmental Construction Report.** At the end of the project, the Contractor will prepare and submit three copies of the Environmental Construction Report on the activities conducted during the life of the project, one copy shall be submitted to the Resident Engineer, one copy shall be submitted to the District's Environmental Studies Unit, and one copy shall be submitted with an electronic copy in Adode.pdf format to the Geologic and Waste Assessment Unit, Bureau of Design and Environment, IDOT, 2300 South Dirksen Parkway, Springfield, Illinois 62764. The technical report shall include all pertinent information regarding the project including, but not limited to:

- (a) Measures taken to identify, monitor, handle, and dispose of soil or groundwater containing regulated substances, to prevent further migration of regulated substances, and to protect workers,
- (b) Cost of identifying, monitoring, handling, and disposing of soil or groundwater containing regulated substances, the cost of preventing further migration of regulated substances, and the cost for worker protection from the regulated substances. All cost should be in the format of the contract pay items listed in the contract plans (identified by the preliminary environmental site investigation (PESA) site number),
- (c) Plan sheets showing the areas containing the regulated substances,
- (d) Field sampling and testing results used to identify the nature and extent of the regulated substances,
- (e) Waste manifests (identified by the preliminary environmental site investigation (PESA) site number) for special or hazardous waste disposal, and
- (f) Landfill tickets (identified by the preliminary environmental site investigation (PESA) site number) for non-special waste disposal.”

Revise the second paragraph of Article 669.16 of the Standard Specifications to read:

“The transportation and disposal of soil and other materials from an excavation determined to be contaminated will be paid for at the contract unit price per cubic yard (cubic meter) for NON-SPECIAL WASTE DISPOSAL, SPECIAL WASTE DISPOSAL, or HAZARDOUS WASTE DISPOSAL.”

## REMOVAL AND DISPOSAL OF SURPLUS MATERIALS (BDE)

Effective: November 2, 2012

Revise the first four paragraphs of Article 202.03 of the Standard Specifications to read:

**“202.03 Removal and Disposal of Surplus, Unstable, Unsuitable, and Organic Materials.** Suitable excavated materials shall not be wasted without permission of the Engineer. The Contractor shall dispose of all surplus, unstable, unsuitable, and organic materials, in such a manner that public or private property will not be damaged or endangered.

Suitable earth, stones and boulders naturally occurring within the right-of-way may be placed in fills or embankments in lifts and compacted according to Section 205. Broken concrete without protruding metal bars, bricks, rock, stone, reclaimed asphalt pavement with no expansive aggregate, or uncontaminated dirt and sand generated from construction or demolition activities may be used in embankment or in fill. If used in fills or embankments, these materials shall be placed and compacted to the satisfaction of the Engineer; shall be buried under a minimum of 2 ft (600 mm) of earth cover (except when the materials include only uncontaminated dirt); and shall not create an unsightly appearance or detract from the natural topographic features of an area. Broken concrete without protruding metal bars, bricks, rock, or stone may be used as riprap as approved by the Engineer. If the materials are used for fill in locations within the right-of-way but outside project construction limits, the Contractor must specify to the Engineer, in writing, how the landscape restoration of the fill areas will be accomplished. Placement of fill in such areas shall not commence until the Contractor’s landscape restoration plan is approved by the Engineer.

Aside from the materials listed above, all other construction and demolition debris or waste shall be disposed of in a licensed landfill, recycled, reused, or otherwise disposed of as allowed by State or Federal laws and regulations. When the Contractor chooses to dispose of uncontaminated soil at a clean construction and demolition debris (CCDD) facility or at an uncontaminated soil fill operation, it shall be the Contractor’s responsibility to have the pH of the material tested to ensure the value is between 6.25 and 9.0, inclusive. A copy of the pH test results shall be provided to the Engineer.

A permit shall be obtained from IEPA and made available to the Engineer prior to open burning of organic materials (i.e., plant refuse resulting from pruning or removal of trees or shrubs) or other construction or demolition debris. Organic materials originating within the right-of-way limits may be chipped or shredded and placed as mulch around landscape plantings within the right-of-way when approved by the Engineer. Chipped or shredded material to be placed as mulch shall not exceed a depth of 6 in. (150 mm).”

### **TRACKING THE USE OF PESTICIDES (BDE)**

Effective: August 1, 2012

Add the following paragraph after the first paragraph of Article 107.23 of the Standard Specifications:

“Within 48 hours of the application of pesticides, including but not limited to herbicides, insecticides, algacides, and fungicides, the Contractor shall complete and return to the Engineer, Operations form “OPER 2720”.”

### **TRAINING SPECIAL PROVISIONS (BDE)**

Effective: October 15, 1975

This Training Special Provision supersedes Section 7b of the Special Provision entitled “Specific Equal Employment Opportunity Responsibilities,” and is in implementation of 23 U.S.C. 140(a).

As part of the Contractor’s equal employment opportunity affirmative action program, training shall be provided as follows:

The Contractor shall provide on-the-job training aimed at developing full journeyman in the type of trade or job classification involved. The number of trainees to be trained under this contract will be 1. In the event the Contractor subcontracts a portion of the contract work, he shall determine how many, if any, of the trainees are to be trained by the subcontractor, provided however, that the Contractor shall retain the primary responsibility for meeting the training requirements imposed by this special provision. The Contractor shall also insure that this Training Special Provision is made applicable to such subcontract. Where feasible, 25 percent of apprentices or trainees in each occupation shall be in their first year of apprenticeship or training.

The number of trainees shall be distributed among the work classifications on the basis of the Contractor’s needs and the availability of journeymen in the various classifications within the reasonable area of recruitment. Prior to commencing construction, the Contractor shall submit to the Illinois Department of Transportation for approval the number of trainees to be trained in each selected classification and training program to be used. Furthermore, the Contractor shall specify the starting time for training in each of the classifications. The Contractor will be credited for each trainee employed by him on the contract work who is currently enrolled or becomes enrolled in an approved program and will be reimbursed for such trainees as provided hereinafter.

Training and upgrading of minorities and women toward journeyman status is a primary objective of this Training Special Provision. Accordingly, the Contractor shall make every effort to enroll minority trainees and women (e.g. by conducting systematic and direct recruitment through public and private sources likely to yield minority and women trainees) to the extent such persons are available within a reasonable area of recruitment. The Contractor will be responsible for demonstrating the steps that he has taken in pursuance thereof, prior to a determination as to whether the Contractor is in compliance with this Training Special Provision. This training commitment is not intended, and shall not be used, to discriminate against any applicant for training, whether a member of a minority group or not.

No employee shall be employed as a trainee in any classification in which he has successfully completed a training course leading to journeyman status or in which he has been employed as a journeyman. The Contractor should satisfy this requirement by including appropriate questions in the employee application or by other suitable means. Regardless of the method used, the Contractor's records should document the findings in each case.

The minimum length and type of training for each classification will be as established in the training program selected by the Contractor and approved by the Illinois Department of Transportation and the Federal Highway Administration. The Illinois Department of Transportation and the Federal Highway Administration shall approve a program, if it is reasonably calculated to meet the equal employment opportunity obligations of the Contractor and to qualify the average trainee for journeyman status in the classification concerned by the end of the training period. Furthermore, apprenticeship programs registered with the U.S. Department of Labor, Bureau of Apprenticeship and Training, or with a State apprenticeship agency recognized by the Bureau and training programs approved by not necessarily sponsored by the U.S. Department of Labor, Manpower Administration, Bureau of Apprenticeship and Training shall also be considered acceptable provided it is being administered in a manner consistent with the equal employment obligations of Federal-aid highway construction contracts. Approval or acceptance of a training program shall be obtained from the State prior to commencing work on the classification covered by the program. It is the intention of these provisions that training is to be provided in the construction crafts rather than clerk-typists or secretarial-type positions. Training is permissible in lower level management positions such as office engineers, estimators, timekeepers, etc., where the training is oriented toward construction applications. Training in the laborer classification may be permitted provided that significant and meaningful training is provided and approved by the Illinois Department of Transportation and the Federal Highway Administration. Some offsite training is permissible as long as the training is an integral part of an approved training program and does not comprise a significant part of the overall training.

Except as otherwise noted below, the Contractor will be reimbursed 80 cents per hour of training given an employee on this contract in accordance with an approved training program. As approved by the Engineer, reimbursement will be made for training of persons in excess of the number specified herein. This reimbursement will be made even though the Contractor receives additional training program funds from other sources, provided such other source does not specifically prohibit the Contractor from receiving other reimbursement. Reimbursement for offsite training indicated above may only be made to the Contractor where he does one or more of the following and the trainees are concurrently employed on a Federal-aid project; contributes to the cost of the training, provides the instruction to the trainee or pays the trainee's wages during the offsite training period.

No payment shall be made to the Contractor if either the failure to provide the required training, or the failure to hire the trainee as a journeyman, is caused by the Contractor and evidences a lack of good faith on the part of the Contractor in meeting the requirement of this Training Special Provision. It is normally expected that a trainee will begin his training on the project as soon as feasible after start of work utilizing the skill involved and remain on the project as long as training opportunities exist in his work classification or until he has completed his training program.

It is not required that all trainees be on board for the entire length of the contract. A Contractor will have fulfilled his responsibilities under this Training Special Provision if he has provided acceptable training to the number of trainees specified. The number trained shall be determined on the basis of the total number enrolled on the contract for a significant period.

Trainees will be paid at least 60 percent of the appropriate minimum journeyman's rate specified in the contract for the first half of the training period, 75 percent for the third quarter of the training period, and 90 percent for the last quarter of the training period, unless apprentices or trainees in an approved existing program are enrolled as trainees on this project. In that case, the appropriate rates approved by the Departments of Labor or Transportation in connection with the existing program shall apply to all trainees being trained for the same classification who are covered by this Training Special Provision.

The Contractor shall furnish the trainee a copy of the program he will follow in providing the training. The Contractor shall provide each trainee with a certification showing the type and length of training satisfactorily complete.

The Contractor shall provide for the maintenance of records and furnish periodic reports documenting his performance under this Training Special Provision.

Method of Measurement. The unit of measurement is in hours.

Basis of Payment. This work will be paid for at the contract unit price of 80 cents per hour for TRAINEES. The estimated total number of hours, unit price, and total price have been included in the schedule of prices.

**IDOT TRAINING PROGRAM GRADUATE ON-THE-JOB TRAINING SPECIAL PROVISION (TPG)**

Effective: August 1, 2012

In addition to the Contractor's equal employment opportunity affirmative action efforts undertaken as elsewhere required by this Contract, the Contractor is encouraged to participate in the incentive program to provide additional on-the-job training to certified graduates of IDOT's community college pre-apprenticeship programs outlined by this Special Provision.

It is the policy of IDOT to fund IDOT pre-apprenticeship training programs based at Illinois Community Colleges throughout Illinois, by Intergovernmental Agreement with the Illinois Community College Board, to provide training and skill-improvement opportunities to assure the increased participation of minority groups, disadvantaged persons and women in all phases of the highway construction industry. The intent of this IDOT Training Program Graduate (TPG) Special Provision is to place certified graduates of these IDOT funded pre-apprentice training programs on IDOT project sites when feasible, and provide the graduates with meaningful on-the-job training intended to lead to journey-level employment. IDOT and its sub-recipients, in carrying out the responsibilities of a state contract, shall determine which state funded construction contracts shall include "Training Program Graduate (TPG) Special Provisions." To benefit from the incentives to encourage the participation in the additional on-the-job training under this Training Program Graduate (TPG) Special Provision, the Contractor shall make every reasonable effort to employ certified graduates of the IDOT funded Pre-apprenticeship Training Program to the extent such persons are available within a reasonable recruitment area.

Participation pursuant to IDOT's requirements by the Contractor or subcontractor in this Training Program Graduate (TPG) Special Provision entitles the Contractor or subcontractor to be reimbursed at \$10.00 per hour for training given a certified graduate trainee on this contract. As approved by the Department, reimbursement will be made for training persons as specified herein. This reimbursement will be made even though the Contractor or subcontractor may receive additional training program funds from other sources for other trainees, provided such other source does not specifically prohibit the Contractor or subcontractor from receiving other reimbursement. For purposes of this Special Provision the Contractor is not relieved of requirements under the Illinois Prevailing Wage Act and is not eligible for other training fund reimbursements in addition to the Training Program Graduate (TPG) Special Provision reimbursement.

No payment shall be made to the Contractor if the Contractor or subcontractor fails to provide the required training. It is normally expected that a TPG will begin training on the project as soon as feasible after start of work utilizing the skill involved and remain on the project through completion of the contract, so long as training opportunities exist in his work classification or until he has completed his training program. Should the TPG's employment end in advance of the completion of the contract, the Contractor shall promptly notify the designated IDOT staff member under this Special Provision that the TPG's involvement in the contract has ended and supply a written report of the reason for the end of the involvement, the hours completed by the TPG under the Contract and the number of hours for which the incentive payment provided under this Special Provision will be or has been claimed for the TPG.

The Contractor will provide for the maintenance of records and furnish periodic reports documenting its performance under this Special Provision.

**METHOD OF MEASUREMENT:** The unit of measurement is in hours.

**BASIS OF PAYMENT:** This work will be paid for at the contract unit price of \$10.00 per hour for TRAINEES TRAINING PROGRAM GRADUATE. The estimated total number of hours, unit price and total price have been included in the schedule of prices.

The Contractor shall provide training opportunities aimed at developing full journeyworker in the type of trade or job classification involved. The initial number of TPGs for which the incentive is available under this contract is 1. During the course of performance of the Contract the Contractor may seek approval from the Department for additional incentive eligible TPGs. In the event the Contractor subcontracts a portion of the contract work, it shall determine how many, if any, of the TPGs are to be trained by the subcontractor, provided however, that the Contractor shall retain the primary responsibility for meeting the training requirements imposed by this Special Provision. The Contractor shall also insure that this Training Program Graduate Special Provision is made applicable to such subcontract if the TPGs are to be trained by a subcontractor and that the incentive payment is passed on to each subcontractor.

For the Contractor to meet the obligations for participation in this TPG incentive program under this Special Provision, the Department has contracted by Intergovernmental Agreement with the Illinois Community College Board to provide screening, tutoring and pre-training to individuals interested in working in the applicable construction classification and has certified those students who have successfully completed the program and are eligible to be TPGs. A designated IDOT staff member, the Director of the Office of Business and Workforce Diversity (OBWD), will be responsible for providing assistance and referrals to the Contractor for the applicable TPGs. For this contract, the Director of OBWD is designated as the responsible IDOT staff member to provide the assistance and referral services related to the placement for this Special Provision. For purposes of this Contract, contacting the Director of OBWD and interviewing each candidate he/she recommends constitutes reasonable recruitment.

Prior to commencing construction, the Contractor shall submit to the Department for approval the TPGs to be trained in each selected classification. Furthermore, the Contractor shall specify the starting time for training in each of the classifications. No employee shall be employed as a TPG in any classification in which he/she has successfully completed a training course leading to journeyman status or in which he/she has been employed as a journeyman. Notwithstanding the on-the-job training purpose of this TPG Special Provision, some offsite training is permissible as long as the offsite training is an integral part of the work of the contract and does not comprise a significant part of the overall training.

Training and upgrading of TPGs of IDOT pre-apprentice training programs is intended to move said TPGs toward journeyman status and is the primary objective of this Training Program Graduate Special Provision. Accordingly, the Contractor shall make every effort to enroll TPGs by recruitment through the IDOT Illinois Community College Program to the extent such persons are available within a reasonable area of recruitment. The Contractor will be responsible for demonstrating the steps that it has taken in pursuance thereof, prior to a determination as to whether the Contractor is in compliance and entitled to the Training Program Graduate TPG Special Provision \$10.00 an hour incentive.

The Contractor or subcontractor shall provide each TPG with a certification showing the type and length of training satisfactorily completed.

## WARM MIX ASPHALT (BDE)

Effective: January 1, 2012  
~~2012~~November 1, 2013

Revised: ~~November 1,~~

Description. This work shall consist of designing, producing and constructing Warm Mix Asphalt (WMA) in lieu of Hot Mix Asphalt (HMA) at the Contractor's option. Work shall be according to Sections 406, 407, 408, 1030, and 1102 of the Standard Specifications, except as modified herein. In addition, any references to HMA in the Standard Specifications, or the special provisions shall be construed to include WMA.

WMA is an asphalt mixture which can be produced at temperatures lower than allowed for HMA utilizing approved WMA technologies. WMA technologies are defined as the use of additives or processes which allow a reduction in the temperatures at which HMA mixes are produced and placed. WMA is produced by the use of additives, a water foaming process, or combination of both. Additives include minerals, chemicals or organics incorporated into the asphalt binder stream in a dedicated delivery system. The process of foaming injects water into the asphalt binder stream, just prior to incorporation of the asphalt binder with the aggregate.

Approved WMA technologies may also be used in HMA provided all the requirements specified herein, with the exception of temperature, are met. However, asphalt mixtures produced at temperatures in excess of 275 °F (135 °C) will not be considered WMA when determining the grade reduction of the virgin asphalt binder grade.

### Materials.

Add the following to Article 1030.02 of the Standard Specifications.

“(h) Warm Mix Asphalt (WMA) Technologies (Note 3)”

Add the following note to Article 1030.02 of the Standard Specifications.

“Note 3. Warm mix additives or foaming processes shall be selected from the current Bureau of Materials and Physical Research Approved List, “Warm-Mix Asphalt Technologies”.”

### Equipment.

Revise the first paragraph of Article 1102.01 of the Standard Specifications to read:

“**1102.01 Hot-Mix Asphalt Plant.** The hot-mix asphalt (HMA) plant shall be the batch-type, continuous-type, or dryer drum plant. The plants shall be evaluated for prequalification rating and approval to produce HMA according to the current Bureau of Materials and Physical Research Policy Memorandum, “Approval of Hot-Mix Asphalt Plants and Equipment”. Once approved, the Contractor shall notify the Bureau of Materials and Physical Research to obtain approval of all plant modifications. The plants shall not be used to produce mixtures concurrently for more than one project or for private work unless permission is granted in writing by the Engineer. The plant units shall be so designed, coordinated and operated that they will function properly and produce HMA having uniform temperatures and compositions within the tolerances specified. The plant units shall meet the following requirements.”



FAP Route 327 (US 50)  
Project ACHSIP-0327(059)  
Section (20,21)-J  
Clinton County  
Contract No. 76G67

Add the following to Article 1102.01(a) of the Standard Specifications.

“(13) Equipment for Warm Mix Technologies.

- a. Foaming. Metering equipment for foamed asphalt shall have an accuracy of  $\pm 2$  percent of the actual water metered. The foaming control system shall be electronically interfaced with the asphalt binder meter.
- b. Additives. Additives shall be introduced into the plant according to the supplier’s recommendations and shall be approved by the Engineer. The system for introducing the WMA additive shall be interlocked with the aggregate feed or weigh system to maintain correct proportions for all rates of production and batch sizes.”

Mix Design Verification.

Add the following to Article 1030.04 of the Standard Specifications.

“(de) Warm Mix Technologies.

- (1) Foaming. WMA mix design verification will not be required when foaming technology is used alone (without WMA additives). However, the foaming technology shall only be used on HMA designs previously approved by the Department.
- (2) Additives. WMA mix designs utilizing additives shall be submitted to the Engineer for mix design verification. ~~Additional mixture verification requirements include Hamburg Wheel testing according to Illinois Modified AASHTO T324 and tensile strength testing according to Illinois Modified AASHTO T283 which shall meet the criteria in Tables 1 and 2 respectively herein. The Contractor shall provide the additional material as follows:~~
  - ~~a. Four gyratory specimens to be prepared in the Contractor’s lab according to Illinois Modified AASHTO T324.~~
  - ~~b. Sufficient mixture to conduct tensile strength testing according to Illinois Modified AASHTO T283.~~

~~Table 1. Illinois Modified AASHTO T324 Requirements<sup>1/</sup>~~

<del>Asphalt Binder Grade</del>	<del># Wheel Passes</del>	<del>Max Rut Depth in. (mm)</del>
<del>PG 76-XX</del>	<del>20,000</del>	<del>1/2 in. (12.5 mm)</del>
<del>PG 70-XX</del>	<del>15,000</del>	<del>1/2 in. (12.5 mm)</del>
<del>PG 64-XX</del>	<del>7,500</del>	<del>1/2 in. (12.5 mm)</del>
<del>PG 58-XX</del>	<del>5,000</del>	<del>1/2 in. (12.5 mm)</del>

~~1/ Loose WMA shall be oven aged at 270  $\pm$  5 °F (132  $\pm$  3 °C) for two hours prior to gyratory compaction of Hamburg Wheel specimens.~~

~~Table 2. Tensile Strength Requirements~~

Asphalt Binder Grade	Tensile Strength psi (kPa)	
	Minimum	Maximum
<del>PG 76-XX</del>	<del>80 (552)</del>	<del>200 (1379)</del>
<del>PG 70-XX</del>		
<del>PG 64-XX</del>	<del>60 (414)</del>	<del>200 (1379)</del>
<del>PG 58-XX</del>		

Production.

Revise the second paragraph of Article 1030.06(a) of the Standard Specifications to read:

“At the start of mix production for HMA, WMA, and HMA using WMA technologies, QC/QA mixture start-up will be required for the following situations; at the beginning of production ~~of a new mix~~ of a new mixture design, at the beginning of each production season, and at every plant utilized to produce mixtures, regardless of the mix.”

~~Insert the following after the sixth paragraph of Article 1030.06(a) of the Standard Specifications:~~

~~“Warm mix technologies shall be as follows.~~

~~(1) Mixture sampled to represent the test strip shall include additional material sufficient for the Department to conduct Hamburg Wheel testing according to Illinois Modified AASHTO T324 and tensile strength testing according to Illinois Modified AASHTO T283 (approximately 110 lb (50 kg) total).~~

~~(2) Upon completion of the start-up, WMA, or HMA using WMA technologies, production shall cease. The Contractor may revert to conventional HMA production provided a start-up has been previously completed for the current construction season for the mix design. WMA, or HMA using WMA technologies, may resume once all the test results, including Hamburg Wheel results are completed and found acceptable by the Engineer.”~~

~~Add the following after the first paragraph of Article 1030.05(d)(2)c. of the Standard Specifications:~~

~~“During production of each WMA mixture or HMA utilizing WMA technologies, the Engineer will request a minimum of one randomly located sample, identified by the Engineer, for Hamburg Wheel testing to determine compliance with the requirements specified in Table 1 herein.”~~

Quality Control/Quality Assurance Testing.

Revise the table in Article 1030.05(d)(2)a. of the Standard Specifications to read:

Parameter	Frequency of Tests		Test Method See Manual of Test Procedures for Materials
	High ESAL Mixture Low ESAL Mixture	All Other Mixtures	
Aggregate Gradation  % passing sieves: 1/2 in. (12.5 mm), No. 4 (4.75 mm), No. 8 (2.36 mm), No. 30 (600 μm) No. 200 (75 μm)  Note 1.	1 washed ignition oven test on the mix per half day of production  Note 4.	1 washed ignition oven test on the mix per day of production  Note 4.	Illinois Procedure
Asphalt Binder Content by Ignition Oven  Note 2.	1 per half day of production	1 per day	Illinois-Modified AASHTO T 308
VMA  Note 3.	Day's production ≥ 1200 tons:  1 per half day of production  Day's production < 1200 tons:  1 per half day of production for first 2 days and 1 per day thereafter (first sample of the day)	N/A	Illinois-Modified AASHTO R 35
Air Voids  Bulk Specific Gravity of Gyratory Sample  Note 5.	Day's production ≥ 1200 tons:  1 per half day of production  Day's production < 1200 tons:  1 per half day of production for first 2 days and 1 per day thereafter (first sample of the day)	1 per day	Illinois-Modified AASHTO T 312
Maximum Specific Gravity of Mixture	Day's production ≥ 1200 tons:  1 per half day of production  Day's production < 1200 tons:  1 per half day of production for first 2 days and 1 per day thereafter (first sample of the day)	1 per day	Illinois-Modified AASHTO T 209

Note 1. The No. 8 (2.36 mm) and No. 30 (600  $\mu$ m) sieves are not required for All Other Mixtures.

Note 2. The Engineer may waive the ignition oven requirement for asphalt binder content if the aggregates to be used are known to have ignition asphalt binder content calibration factors which exceed 1.5 percent. If the ignition oven requirement is waived, other Department approved methods shall be used to determine the asphalt binder content.

Note 3. The  $G_{sb}$  used in the voids in the mineral aggregate (VMA) calculation shall be the same average  $G_{sb}$  value listed in the mix design.

Note 4. The Engineer reserves the right to require additional hot bin gradations for batch

Note 5. The WMA compaction temperature for mixture volumetric testing shall be  $270 \pm 5$  °F ( $132 \pm 3$  °C) for quality control testing. The WMA compaction temperature for quality assurance testing will be  $270 \pm 5$  °F ( $132 \pm 3$  °C) if the mixture is not allowed to cool to room temperature. If the mixture is allowed to cool to room temperature it shall be reheated to standard HMA compaction temperatures.”

#### Construction Requirements.

Revise the second paragraph of Article 406.06(b)(1) of the Standard Specifications to read:

“The HMA shall be delivered at a temperature of 250 to 350 °F (120 to 175 °C).  
WMA shall be delivered at a minimum temperature of 215 °F (102 °C).”

#### Basis of Payment.

This work will be paid at the contract unit price bid for the HMA pay items involved. Anti-strip will not be paid for separately, but shall be considered as included in the cost of the work.

### **WEEKLY DBE TRUCKING REPORTS (BDE)**

Effective: June 2, 2012

The Contractor shall provide a weekly report of Disadvantaged Business Enterprise (DBE) trucks hired by the Contractor or subcontractors (i.e. not owned by the Contractor or subcontractors) that are used on the jobsite; or used for the delivery and/or removal of equipment/material to and from the jobsite. The jobsite shall also include offsite locations, such as plant sites or storage sites, when those locations are used solely for this contract.

The report shall be submitted on the form provided by the Department within ten business days following the reporting period. The reporting period shall be Monday through Sunday for each week reportable trucking activities occur. The report shall be submitted to the Engineer and a copy shall be provided to the district EEO Officer.

Any costs associated with providing weekly DBE trucking reports shall be considered as included in the contract unit prices bid for the various items of work involved and no additional compensation will be allowed.

### **WORKING DAYS (BDE)**

Effective: January 1, 2002

The Contractor shall complete the work within 65 working days.

**BITUMINOUS MATERIALS COST ADJUSTMENTS (BDE) (RETURN FORM WITH BID)**

Effective: November 2, 2006  
~~2012~~August 1, 2013

Revised: ~~January 1,~~

Description. Bituminous material cost adjustments will be made to provide additional compensation to the Contractor, or credit to the Department, for fluctuations in the cost of bituminous materials when optioned by the Contractor. The adjustments shall apply to permanent and temporary hot-mix asphalt (HMA) mixtures, bituminous surface treatments (cover and seal coats), and preventative maintenance type surface treatments. The adjustments shall not apply to bituminous prime coats, tack coats, crack filling/sealing, or joint filling/sealing.

The bidder shall indicate on the attached form whether or not this special provision will be part of the contract and submit the completed form with his/her bid. Failure to submit the form, or failure to fill out the form completely, shall make this contract exempt of bituminous materials cost adjustments.

Method of Adjustment. Bituminous materials cost adjustments will be computed as follows.

$$CA = (BPI_P - BPI_L) \times (\%AC_V / 100) \times Q$$

- Where: CA = Cost Adjustment, \$.  
BPI<sub>P</sub> = Bituminous Price Index, as published by the Department for the month the work is performed, \$/ton (\$/metric ton).  
BPI<sub>L</sub> = Bituminous Price Index, as published by the Department for the month prior to the letting, \$/ton (\$/metric ton).  
%AC<sub>V</sub> = Percent of virgin Asphalt Cement in the Quantity being adjusted. For HMA mixtures, the % AC<sub>V</sub> will be determined from the adjusted job mix formula. For bituminous materials applied, a performance graded or cutback asphalt will be considered to be 100% AC<sub>V</sub> and undiluted emulsified asphalt will be considered to be 65% AC<sub>V</sub>.  
Q = Authorized construction Quantity, tons (metric tons) (see below).

For HMA mixtures measured in square yards:  $Q, \text{ tons} = A \times D \times (G_{mb} \times 46.8) / 2000$ . For HMA mixtures measured in square meters:  $Q, \text{ metric tons} = A \times D \times (G_{mb} \times \underline{24.991}) / 1000$ . When computing adjustments for full-depth HMA pavement, separate calculations will be made for the binder and surface courses to account for their different  $G_{mb}$  and % AC<sub>V</sub>.

For bituminous materials measured in gallons:  $Q, \text{ tons} = V \times 8.33 \text{ lb/gal} \times SG / 2000$   
For bituminous materials measured in liters:  $Q, \text{ metric tons} = V \times 1.0 \text{ kg/L} \times SG / 1000$

- Where: A = Area of the HMA mixture, sq yd (sq m).  
D = Depth of the HMA mixture, in. (mm).  
G<sub>mb</sub> = Average bulk specific gravity of the mixture, from the approved mix design.  
V = Volume of the bituminous material, gal (L).  
SG = Specific Gravity of bituminous material as shown on the bill of lading.

Basis of Payment. Bituminous materials cost adjustments may be positive or negative but will only be made when there is a difference between the  $BPI_L$  and  $BPI_P$  in excess of five percent, as calculated by:

$$\text{Percent Difference} = \{(BPI_L - BPI_P) \div BPI_L\} \times 100$$

Bituminous materials cost adjustments will be calculated for each calendar month in which applicable bituminous material is placed; and will be paid or deducted when all other contract requirements for the work placed during the month are satisfied. The adjustments shall not apply during contract time subject to liquidated damages for completion of the entire contract.



Return With Bid

**ILLINOIS DEPARTMENT  
OF TRANSPORTATION**

**OPTION FOR  
BITUMINOUS MATERIALS COST ADJUSTMENTS**

The bidder shall submit this completed form with his/her bid. Failure to submit the form, or failure to fill out the form completely, shall make this contract exempt of bituminous materials cost adjustments. After award, this form, when submitted, shall become part of the contract.

**Contract No.:** \_\_\_\_\_

**Company Name:** \_\_\_\_\_

**Contractor's Option:**

Is your company opting to include this special provision as part of the contract?

Yes  No

**Signature:** \_\_\_\_\_ **Date:** \_\_\_\_\_

## **FUEL COST ADJUSTMENT (BDE) (RETURN FORM WITH BID)**

Effective: April 1, 2009

Revised: July 1, 2009

Description. Fuel cost adjustments will be made to provide additional compensation to the Contractor, or a credit to the Department, for fluctuations in fuel prices when optioned by the Contractor. The bidder shall indicate on the attached form whether or not this special provision will be part of the contract and submit the completed form with his/her bid. Failure to submit the form or failure to indicate contract number, company name and sign and date the form shall make this contract exempt of fuel cost adjustments for all categories of work. Failure to indicate "Yes" for any category of work will make that category of work exempt from fuel cost adjustment.

General. The fuel cost adjustment shall apply to contract pay items as grouped by category. The adjustment shall only apply to those categories of work checked "Yes", and only when the cumulative plan quantities for a category exceed the required threshold. Adjustments to work items in a category, either up or down, and work added by adjusted unit price will be subject to fuel cost adjustment only when the category representing the added work was subject to the fuel cost adjustment. Added work paid for by time and materials will not be subject to fuel cost adjustment. Category descriptions and thresholds for application and the fuel usage factors which are applicable to each are as follows:

(a) Categories of Work.

- (1) Category A: Earthwork. Contract pay items performed under Sections 202, 204, and 206 including any modified standard or nonstandard items where the character of the work to be performed is considered earthwork. The cumulative total of all applicable item plan quantities shall exceed 25,000 cu yd (20,000 cu m). Included in the fuel usage factor is a weighted average 0.10 gal/cu yd (0.50 liters/cu m) factor for trucking.
- (2) Category B: Subbases and Aggregate Base Courses. Contract pay items constructed under Sections 311, 312 and 351 including any modified standard or nonstandard items where the character of the work to be performed is considered construction of a subbase or aggregate, stabilized or modified base course. The cumulative total of all applicable item plan quantities shall exceed 5000 tons (4500 metric tons). Included in the fuel usage factor is a 0.60 gal/ton (2.50 liters/metric ton) factor for trucking.
- (3) Category C: Hot-Mix Asphalt (HMA) Bases, Pavements and Shoulders. Contract pay items constructed under Sections 355, 406, 407 and 482 including any modified standard or nonstandard items where the character of the work to be performed is considered HMA bases, pavements and shoulders. The cumulative total of all applicable item plan quantities shall exceed 5000 tons (4500 metric tons). Included in the fuel usage factor is 0.60 gal/ton (2.50 liters/metric ton) factor for trucking.

- (4) Category D: Portland Cement Concrete (PCC) Bases, Pavements and Shoulders. Contract pay items constructed under Sections 353, 420, 421 and 483 including any modified standard or nonstandard items where the character of the work to be performed is considered PCC base, pavement or shoulder. The cumulative total of all applicable item plan quantities shall exceed 7500 sq yd (6000 sq m). Included in the fuel usage factor is 1.20 gal/cu yd (5.94 liters/cu m) factor for trucking.
- (5) Category E: Structures. Structure items having a cumulative bid price that exceeds \$250,000 for pay items constructed under Sections 502, 503, 504, 505, 512, 516 and 540 including any modified standard or nonstandard items where the character of the work to be performed is considered structure work when similar to that performed under these sections and not included in categories A through D.

(b) Fuel Usage Factors.

English Units		
Category	Factor	Units
A - Earthwork	0.34	gal / cu yd
B – Subbase and Aggregate Base courses	0.62	gal / ton
C – HMA Bases, Pavements and Shoulders	1.05	gal / ton
D – PCC Bases, Pavements and Shoulders	2.53	gal / cu yd
E – Structures	8.00	gal / \$1000

Metric Units		
Category	Factor	Units
A - Earthwork	1.68	liters / cu m
B – Subbase and Aggregate Base courses	2.58	liters / metric ton
C – HMA Bases, Pavements and Shoulders	4.37	liters / metric ton
D – PCC Bases, Pavements and Shoulders	12.52	liters / cu m
E – Structures	30.28	liters / \$1000

(c) Quantity Conversion Factors.

Category	Conversion	Factor
B	sq yd to ton	0.057 ton / sq yd / in depth
	sq m to metric ton	0.00243 metric ton / sq m / mm depth
C	sq yd to ton	0.056 ton / sq yd / in depth
	sq m to metric ton	0.00239 m ton / sq m / mm depth
D	sq yd to cu yd	0.028 cu yd / sq yd / in depth
	sq m to cu m	0.001 cu m / sq m / mm depth

Method of Adjustment. Fuel cost adjustments will be computed as follows.

$$CA = (FPI_P - FPI_L) \times FUF \times Q$$

Where: CA = Cost Adjustment, \$  
FPI<sub>P</sub> = Fuel Price Index, as published by the Department for the month the work is performed, \$/gal (\$/liter)  
FPI<sub>L</sub> = Fuel Price Index, as published by the Department for the month prior to the letting, \$/gal (\$/liter)  
FUF = Fuel Usage Factor in the pay item(s) being adjusted  
Q = Authorized construction Quantity, tons (metric tons) or cu yd (cu m)

The entire FUF indicated in paragraph (b) will be used regardless of use of trucking to perform the work.

Progress Payments. Fuel cost adjustments will be calculated for each calendar month in which applicable work is performed; and will be paid or deducted when all other contract requirements for the items of work are satisfied. The adjustments shall not apply during contract time subject to liquidated damages for completion of the entire contract.

Final Quantities. Upon completion of the work and determination of final pay quantities, an adjustment will be prepared to reconcile any differences between estimated quantities previously paid and the final quantities. The value for the balancing adjustment will be based on a weighted average of FPI<sub>P</sub> and Q only for those months requiring the cost adjustment. The cost adjustment will be applicable to the final measured quantities of all applicable pay items.

Basis of Payment. Fuel cost adjustments may be positive or negative but will only be made when there is a difference between the FPI<sub>L</sub> and FPI<sub>P</sub> in excess of five percent, as calculated by:

$$\text{Percent Difference} = \{(FPI_L - FPI_P) \div FPI_L\} \times 100$$

Return With Bid

**ILLINOIS DEPARTMENT  
OF TRANSPORTATION**

**OPTION FOR  
FUEL COST ADJUSTMENT**

The bidder shall submit this completed form with his/her bid. Failure to submit the form or properly complete contract number, company name, and sign and date the form shall make this contract exempt of fuel cost adjustments in all categories. Failure to indicate "Yes" for any category of work at the time of bid will make that category of work exempt from fuel cost adjustment. After award, this form, when submitted shall become part of the contract.

**Contract No.:** \_\_\_\_\_

**Company Name:** \_\_\_\_\_

**Contractor's Option:**

Is your company opting to include this special provision as part of the contract plans for the following categories of work?

- |  |     |                          |
|--|-----|--------------------------|
| Category A Earthwork.                          | Yes | <input type="checkbox"/> |
| Category B Subbases and Aggregate Base Courses | Yes | <input type="checkbox"/> |
| Category C HMA Bases, Pavements and Shoulders  | Yes | <input type="checkbox"/> |
| Category D PCC Bases, Pavements and Shoulders  | Yes | <input type="checkbox"/> |
| Category E Structures                          | Yes | <input type="checkbox"/> |

**Signature:** \_\_\_\_\_ **Date:** \_\_\_\_\_

## **STEEL COST ADJUSTMENT (BDE) (RETURN FORM WITH BID)**

Effective: April 2, 2004

Revised: April 1, 2009

Description. Steel cost adjustments will be made to provide additional compensation to the Contractor, or a credit to the Department, for fluctuations in steel prices when optioned by the Contractor. The bidder shall indicate on the attached form whether or not this special provision will be part of the contract and submit the completed form with his/her bid. Failure to submit the form or failure to indicate contract number, company name, and sign and date the form shall make this contract exempt of steel cost adjustments for all items of steel. Failure to indicate "Yes" for any item of work will make that item of steel exempt from steel cost adjustment.

Types of Steel Products. An adjustment will be made for fluctuations in the cost of steel used in the manufacture of the following items:

- Metal Piling (excluding temporary sheet piling)
- Structural Steel
- Reinforcing Steel

Other steel materials such as dowel bars, tie bars, mesh reinforcement, guardrail, steel traffic signal and light poles, towers and mast arms, metal railings (excluding wire fence), and frames and grates will be subject to a steel cost adjustment when the pay items they are used in has a contract value of \$10,000 or greater.

Documentation. Sufficient documentation shall be furnished to the Engineer to verify the following:

- (a) The dates and quantity of steel, in lb (kg), shipped from the mill to the fabricator.
- (b) The quantity of steel, in lb (kg), incorporated into the various items of work covered by this special provision. The Department reserves the right to verify submitted quantities.

Method of Adjustment. Steel cost adjustments will be computed as follows:

$$SCA = Q \times D$$

Where: SCA = steel cost adjustment, in dollars  
Q = quantity of steel incorporated into the work, in lb (kg)  
D = price factor, in dollars per lb (kg)

$$D = MPI_M - MPI_L$$

Where:  $MPI_M$  = The Materials Cost Index for steel as published by the Engineering News-Record for the month the steel is shipped from the mill. The indices will be converted from dollars per 100 lb to dollars per lb (kg).

$MPI_L$  = The Materials Cost Index for steel as published by the Engineering News-Record for the month prior to the letting. The indices will be converted from dollars per 100 lb to dollars per lb (kg).

The unit weights (masses) of steel that will be used to calculate the steel cost adjustment for the various items are shown in the attached table.

No steel cost adjustment will be made for any products manufactured from steel having a mill shipping date prior to the letting date.

If the Contractor fails to provide the required documentation, the method of adjustment will be calculated as described above; however, the  $MPI_M$  will be based on the date the steel arrives at the job site. In this case, an adjustment will only be made when there is a decrease in steel costs.

Basis of Payment. Steel cost adjustments may be positive or negative but will only be made when there is a difference between the  $MPI_L$  and  $MPI_M$  in excess of five percent, as calculated by:

$$\text{Percent Difference} = \{(MPI_L - MPI_M) \div MPI_L\} \times 100$$

Steel cost adjustments will be calculated by the Engineer and will be paid or deducted when all other contract requirements for the items of work are satisfied. Adjustments will only be made for fluctuations in the cost of the steel as described herein. No adjustment will be made for changes in the cost of manufacturing, fabrication, shipping, storage, etc.

The adjustments shall not apply during contract time subject to liquidated damages for completion of the entire contract.

**Attachment**

Item	Unit Mass (Weight)
Metal Piling (excluding temporary sheet piling)	
Furnishing Metal Pile Shells 12 in. (305 mm), 0.179 in. (3.80 mm) wall thickness)	23 lb/ft (34 kg/m)
Furnishing Metal Pile Shells 12 in. (305 mm), 0.250 in. (6.35 mm) wall thickness)	32 lb/ft (48 kg/m)
Furnishing Metal Pile Shells 14 in. (356 mm), 0.250 in. (6.35 mm) wall thickness)	37 lb/ft (55 kg/m)
Other piling	See plans
Structural Steel	See plans for weights (masses)
Reinforcing Steel	See plans for weights (masses)
Dowel Bars and Tie Bars	6 lb (3 kg) each
Mesh Reinforcement	63 lb/100 sq ft (310 kg/sq m)
Guardrail	
Steel Plate Beam Guardrail, Type A w/steel posts	20 lb/ft (30 kg/m)
Steel Plate Beam Guardrail, Type B w/steel posts	30 lb/ft (45 kg/m)
Steel Plate Beam Guardrail, Types A and B w/wood posts	8 lb/ft (12 kg/m)
Steel Plate Beam Guardrail, Type 2	305 lb (140 kg) each
Steel Plate Beam Guardrail, Type 6	1260 lb (570 kg) each
Traffic Barrier Terminal, Type 1 Special (Tangent)	730 lb (330 kg) each
Traffic Barrier Terminal, Type 1 Special (Flared)	410 lb (185 kg) each
Steel Traffic Signal and Light Poles, Towers and Mast Arms	
Traffic Signal Post	11 lb/ft (16 kg/m)
Light Pole, Tenon Mount and Twin Mount, 30 - 40 ft (9 - 12 m)	14 lb/ft (21 kg/m)
Light Pole, Tenon Mount and Twin Mount, 45 - 55 ft (13.5 - 16.5 m)	21 lb/ft (31 kg/m)
Light Pole w/Mast Arm, 30 - 50 ft (9 - 15.2 m)	13 lb/ft (19 kg/m)
Light Pole w/Mast Arm, 55 - 60 ft (16.5 - 18 m)	19 lb/ft (28 kg/m)
Light Tower w/Luminaire Mount, 80 - 110 ft (24 - 33.5 m)	31 lb/ft (46 kg/m)
Light Tower w/Luminaire Mount, 120 - 140 ft (36.5 - 42.5 m)	65 lb/ft (97 kg/m)
Light Tower w/Luminaire Mount, 150 - 160 ft (45.5 - 48.5 m)	80 lb/ft (119 kg/m)
Metal Railings (excluding wire fence)	
Steel Railing, Type SM	64 lb/ft (95 kg/m)
Steel Railing, Type S-1	39 lb/ft (58 kg/m)
Steel Railing, Type T-1	53 lb/ft (79 kg/m)
Steel Bridge Rail	52 lb/ft (77 kg/m)
Frames and Grates	
Frame	250 lb (115 kg)
Lids and Grates	150 lb (70 kg)



Return With Bid

**ILLINOIS DEPARTMENT  
OF TRANSPORTATION**

**OPTION FOR  
STEEL COST ADJUSTMENT**

The bidder shall submit this completed form with his/her bid. Failure to submit the form or properly complete contract number, company name, and sign and date the form shall make this contract exempt of steel cost adjustments for all items of steel. Failure to indicate "Yes" for any item of work will make that item of steel exempt from steel cost adjustment. After award, this form, when submitted shall become part of the contract.

**Contract No.:** \_\_\_\_\_

**Company Name:** \_\_\_\_\_

**Contractor's Option:**

Is your company opting to include this special provision as part of the contract plans for the following items of work?

- Metal Piling Yes
- Structural Steel Yes
- Reinforcing Steel Yes
- Dowel Bars, Tie Bars and Mesh Reinforcement Yes
- Guardrail Yes
- Steel Traffic Signal and Light Poles, Towers and Mast Arms Yes
- Metal Railings (excluding wire fence) Yes
- Frames and Grates Yes

**Signature:** \_\_\_\_\_ **Date:** \_\_\_\_\_

**STORM WATER POLLUTION PREVENTION PLAN**



**Storm Water Pollution Prevention Plan**

Route	<u>FAP 327</u>	Marked Rte.	<u>US 50</u>
Section	<u>(20,21)-J</u>	Project No.	<u>C-98-068-13</u>
County	<u>Clinton</u>	Contract No.	<u>76G67</u>

This plan has been prepared to comply with the provisions of the National Pollutant Discharge Elimination System (NPDES) Permit No. ILR10 (Permit ILR10), issued by the Illinois Environmental Protection Agency (IEPA) for storm water discharges from construction site activities.

I certify under penalty of law that this document and all attachments were prepared under my direction or supervision in accordance with a system designed to assure that qualified personnel properly gathered and evaluated the information submitted. Based on my inquiry of the person or persons who manage the system, or those persons directly responsible for gathering the information, the information submitted is, to the best of my knowledge and belief, true, accurate and complete. I am aware that there are significant penalties for submitting false information, including the possibility of fine and imprisonment for knowing violations.

\_\_\_\_\_  
 Jeffrey L. Keirn  
 Print Name  
 Deputy Director of Highways/Region Five Engineer  
 Title  
 Illinois Department of Transportation  
 Agency

\_\_\_\_\_  
*Jeffrey L. Keirn*  
 Signature  
 10/18/13  
 Date

**I. Site Description:**

- A. Provide a description of the project location (include latitude and longitude):  
 US 50 from Huey Rd. to Creek Rd.
- B. Provide a description of the construction activity which is the subject of this plan:  
 Include removal and replacement of existing guardrail, ditch reshaping and addition of rip rap.
- C. Provide the estimated duration of this project:  
 64 days.
- D. The total area of the construction site is estimated to be 5.48 acres.  
 The total area of the site estimated to be disturbed by excavation, grading or other activities is 5.48 acres.
- E. The following is a weighted average of the runoff coefficient for this project after construction activities are completed:  
 0.83
- F. List all soils found within project boundaries. Include map unit name, slope information, and erosivity:  
 See the list of locations and soil types attached.
- G. Provide an aerial extent of wetland acreage at the site:  
 No wetland impact.
- H. Provide a description of potentially erosive areas associated with this project:  
 Work is being done on the top of the foreslope and down the foreslope mostly with ditch disturbance in the areas of

the TRM.

- I. The following is a description of soil disturbing activities by stages, their locations, and their erosive factors (e.g. steepness of slopes, length of slopes, etc):

This project will include the removal and replacement of existing guardrail, ditch reshaping and installing HMA shoulders throughout. Temporary erosion control seeding, ditch checks and mulch method 2 are being used.

- J. See the erosion control plans and/or drainage plans for this contract for information regarding drainage patterns, approximate slopes anticipated before and after major grading activities, locations where vehicles enter or exit the site and controls to prevent offsite sediment tracking (to be added after contractor identifies locations), areas of soil disturbance, the location of major structural and non-structural controls identified in the plan, the location of areas where stabilization practices are expected to occur, surface waters (including wetlands) and locations where storm water is discharged to surface water including wetlands.

- K. Identify who owns the drainage system (municipality or agency) this project will drain into:

Roadside ditches(Illinois Department of Transportation).

- L. The following is a list of receiving water(s) and the ultimate receiving water(s) for this site. The location of the receiving waters can be found on the erosion and sediment control plans:

Tributary to Lost Creek, to Lost Creek, to Crooked Creek, to Kaskaskia River, to Mississippi River.

- M. Describe areas of the site that are to be protected or remain undisturbed. These areas may include steep slopes, highly erodible soils, streams, stream buffers, specimen trees, natural vegetation, nature preserves, etc.

N/A

- N. The following sensitive environmental resources are associated with this project, and may have the potential to be impacted by the proposed development:

- Floodplain
- Wetland Riparian
- Threatened and Endangered Species
- Historic Preservation
- 303(d) Listed receiving waters for suspended solids, turbidity, or siltation
- Receiving waters with Total Maximum Daily Load (TMDL) for sediment, total suspended solids, turbidity or siltation
- Applicable Federal, Tribal, State or Local Programs
- Other

- 1. 303(d) Listed receiving waters (fill out this section if checked above):

- a. The name(s) of the listed water body, and identification of all pollutants causing impairment:
- b. Provide a description of how erosion and sediment control practices will prevent a discharge of sediment resulting from a storm event equal to or greater than a twenty-five (25) year, twenty-four (24) hour rainfall event:
- c. Provide a description of the location(s) of direct discharge from the project site to the 303(d) water body:
- d. Provide a description of the location(s) of any dewatering discharges to the MS4 and/or water body:

- 2. TMDL (fill out this section if checked above)

- a. The name(s) of the listed water body:
- b. Provide a description of the erosion and sediment control strategy that will be incorporated into the site design that

is consistent with the assumptions and requirements of the TMDL:

- c. If a specific numeric waste load allocation has been established that would apply to the project's discharges, provide a description of the necessary steps to meet that allocation:

O. The following pollutants of concern will be associated with this construction project:

- |  |  |
|--|--|
| <input checked="" type="checkbox"/> Soil Sediment            | <input checked="" type="checkbox"/> Petroleum (gas, diesel, oil, kerosene, hydraulic oil / fluids) |
| <input type="checkbox"/> Concrete                            | <input checked="" type="checkbox"/> Antifreeze / Coolants  |
| <input type="checkbox"/> Concrete Truck Waste                | <input type="checkbox"/> Waste water from cleaning construction equipment                          |
| <input type="checkbox"/> Concrete Curing Compounds           | <input type="checkbox"/> Other (specify)   |
| <input type="checkbox"/> Solid Waste Debris                  | <input type="checkbox"/> Other (specify)   |
| <input type="checkbox"/> Paints                              | <input type="checkbox"/> Other (specify)   |
| <input type="checkbox"/> Solvents                            | <input type="checkbox"/> Other (specify)   |
| <input checked="" type="checkbox"/> Fertilizers / Pesticides | <input type="checkbox"/> Other (specify)   |

**II. Controls:**

This section of the plan addresses the controls that will be implemented for each of the major construction activities described in I.C. above and for all use areas, borrow sites, and waste sites. For each measure discussed, the Contractor will be responsible for its implementation as indicated. The Contractor shall provide to the Resident Engineer a plan for the implementation of the measures indicated. The Contractor, and subcontractors, will notify the Resident Engineer of any proposed changes, maintenance, or modifications to keep construction activities compliant with the Permit ILR10. Each such Contractor has signed the required certification on forms which are attached to, and are a part of, this plan:

**A. Erosion and Sediment Controls**

1. **Stabilized Practices:** Provided below is a description of interim and permanent stabilization practices, including site specific scheduling of the implementation of the practices. Site plans will ensure that existing vegetation is preserved where attainable and disturbed portions of the site will be stabilized. Stabilization practices may include but are not limited to: temporary seeding, permanent seeding, mulching, geotextiles, sodding, vegetative buffer strips, protection of trees, preservation of mature vegetation, and other appropriate measures. Except as provided below in II(A)(1)(a) and II(A)(3), stabilization measures shall be initiated as soon as practicable in portions of the site where construction activities have temporarily or permanently ceased, but in no case more than seven (7) days after the construction activity in that portion of the site has temporarily or permanently ceases on all disturbed portions of the site where construction will not occur for a period of fourteen (14) or more calendar days.

Where the initiation of stabilization measures by the seventh day after construction activity temporarily or permanently ceases is precluded by snow cover, stabilization measures shall be initiated as soon as practicable thereafter.

The following stabilization practices will be used for this project:

- |   |  |
|---|--|
| <input type="checkbox"/> Preservation of Mature Vegetation            | <input checked="" type="checkbox"/> Erosion Control Blanket / Mulching |
| <input type="checkbox"/> Vegetated Buffer Strips                      | <input type="checkbox"/> Sodding                                       |
| <input type="checkbox"/> Protection of Trees                          | <input type="checkbox"/> Geotextiles                                   |
| <input checked="" type="checkbox"/> Temporary Erosion Control Seeding | <input type="checkbox"/> Other (specify)                               |
| <input type="checkbox"/> Temporary Turf (Seeding, Class 7)            | <input type="checkbox"/> Other (specify)                               |
| <input type="checkbox"/> Temporary Mulching                           | <input type="checkbox"/> Other (specify)                               |
| <input checked="" type="checkbox"/> Permanent Seeding                 | <input type="checkbox"/> Other (specify)                               |

Describe how the stabilization practices listed above will be utilized during construction:

During construction time at each location limited and temporary measures will be taken then final seeding and mulching will be done when appropriate.

Describe how the stabilization practices listed above will be utilized after construction activities have been completed:

Upon completion of all earth disturbing activities at each location, temporary erosion control seeding followed by permanent seeding shall be placed on all disturbed areas. Mulch shall be placed over the

disturbed areas to help prevent erosion until the vegetation has been established.

2. **Structural Practices:** Provided below is a description of structural practices that will be implemented, to the degree attainable, to divert flows from exposed soils, store flows or otherwise limit runoff and the discharge of pollutants from exposed areas of the site. Such practices may include but are not limited to: perimeter erosion barrier, earth dikes, drainage swales, sediment traps, ditch checks, subsurface drains, pipe slope drains, level spreaders, storm drain inlet protection, rock outlet protection, reinforced soil retaining systems, gabions, and temporary or permanent sediment basins. The installation of these devices may be subject to Section 404 of the Clean Water Act.

The following structural practices will be used for this project:

- |   |  |
|---|--|
| <input type="checkbox"/> Perimeter Erosion Barrier          | <input type="checkbox"/> Rock Outlet Protection  |
| <input checked="" type="checkbox"/> Temporary Ditch Check   | <input checked="" type="checkbox"/> Riprap       |
| <input type="checkbox"/> Storm Drain Inlet Protection       | <input type="checkbox"/> Gabions                 |
| <input type="checkbox"/> Sediment Trap                      | <input type="checkbox"/> Slope Mattress          |
| <input type="checkbox"/> Temporary Pipe Slope Drain         | <input type="checkbox"/> Retaining Walls         |
| <input type="checkbox"/> Temporary Sediment Basin           | <input type="checkbox"/> Slope Walls             |
| <input type="checkbox"/> Temporary Stream Crossing          | <input type="checkbox"/> Concrete Revetment Mats |
| <input type="checkbox"/> Stabilized Construction Exits      | <input type="checkbox"/> Level Spreaders         |
| <input checked="" type="checkbox"/> Turf Reinforcement Mats | <input type="checkbox"/> Other (specify)         |
| <input type="checkbox"/> Permanent Check Dams               | <input type="checkbox"/> Other (specify)         |
| <input type="checkbox"/> Permanent Sediment Basin           | <input type="checkbox"/> Other (specify)         |
| <input type="checkbox"/> Aggregate Ditch                    | <input type="checkbox"/> Other (specify)         |
| <input type="checkbox"/> Paved Ditch                        | <input type="checkbox"/> Other (specify)         |

Describe how the structural practices listed above will be utilized during construction:

Temporary ditch checks will be used where needed.

Describe how the structural practices listed above will be utilized after construction activities have been completed:

TRM's will be placed and left for long term reinforcement.

3. **Storm Water Management:** Provided below is a description of measures that will be installed during the construction process to control pollutants in storm water discharges that will occur after construction operations have been completed. The installation of these devices may be subject to Section 404 of the Clean Water Act.

- a. Such practices may include but are not limited to: storm water detention structures (including wet ponds), storm water retention structures, flow attenuation by use of open vegetated swales and natural depressions, infiltration of runoff on site, and sequential systems (which combine several practices).

The practices selected for implementation were determined on the basis of the technical guidance in Chapter 41 (Construction Site Storm Water Pollution Control) of the IDOT Bureau of Design and Environment Manual. If practices other than those discussed in Chapter 41 are selected for implementation or if practices are applied to situations different from those covered in Chapter 41, the technical basis for such decisions will be explained below.

- b. Velocity dissipation devices will be placed at discharge locations and along the length of any outfall channel as necessary to provide a non-erosive velocity flow from the structure to a water course so that the natural physical and biological characteristics and functions are maintained and protected (e.g. maintenance of hydrologic conditions such as the hydroperiod and hydrodynamics present prior to the initiation of construction activities).

Description of storm water management controls:

Temporary seeding initially and then permanent seeding and mulching will be used to control erosion of any exposed soil. Temporary ditch checks will be used to aid in sediment control while construction of permanent features are established.

4. **Approved State or Local Laws:** The management practices, controls and provisions contained in this plan will be in accordance with IDOT specifications, which are at least as protective as the requirements contained in the Illinois Environmental Protection Agency's Illinois Urban Manual. Procedures and

requirements specified in applicable sediment and erosion site plans or storm water management plans approved by local officials shall be described or incorporated by reference in the space provided below. Requirements specified in sediment and erosion site plans, site permits, storm water management site plans or site permits approved by local officials that are applicable to protecting surface water resources are, upon submittal of an NOI, to be authorized to discharge under the Permit ILR10 incorporated by reference and are enforceable under this permit even if they are not specifically included in the plan.

Description of procedures and requirements specified in applicable sediment and erosion site plans or storm water management plans approved by local officials:

N/A

5. **Contractor Required Submittals:** Prior to conducting any professional services at the site covered by this plan, the Contractor and each subcontractor responsible for compliance with the permit shall submit to the Resident Engineer a Contractor Certification Statement, BDE 2342a.
- a. The Contractor shall provide a construction schedule containing an adequate level of detail to show major activities with implementation of pollution prevention BMPs, including the following items:
- Approximate duration of the project, including each stage of the project
  - Rainy season, dry season, and winter shutdown dates
  - Temporary stabilization measures to be employed by contract phases
  - Mobilization timeframe
  - Mass clearing and grubbing/roadside clearing dates
  - Deployment of Erosion Control Practices
  - Deployment of Sediment Control Practices (including stabilized construction entrances/exits)
  - Deployment of Construction Site Management Practices (including concrete washout facilities, chemical storage, refueling locations, etc.)
  - Paving, saw-cutting, and any other pavement related operations
  - Major planned stockpiling operations
  - Timeframe for other significant long-term operations or activities that may plan non-storm water discharges such as dewatering, grinding, etc.
  - Permanent stabilization activities for each area of the project
- b. The Contractor and each subcontractor shall provide, as an attachment to their signed Contractor Certification Statement, a discussion of how they will comply with the requirements of the permit in regard to the following items and provide a graphical representation showing location and type of BMPs to be used when applicable:
- Vehicle Entrances and Exits – Identify type and location of stabilized construction entrances and exits to be used and how they will be maintained.
  - Material Delivery, Storage and Use – Discuss where and how materials including chemicals, concrete curing compounds, petroleum products, etc. will be stored for this project.
  - Stockpile Management – Discuss what BMPs will be used to prevent pollution of storm water from stockpiles.
  - Waste Disposal – Discuss methods of waste disposal that will be used for this project.
  - Spill Prevention and Control – Discuss steps that will be taken in the event of a material spill (chemicals, concrete curing compounds, petroleum, etc.)
  - Concrete Residuals and Washout Wastes – Discuss the location and type of concrete washout facilities to be used on this project and how they will be signed and maintained.
  - Litter Management – Discuss how litter will be maintained for this project (education of employees, number of dumpsters, frequency of dumpster pick-up, etc.).
  - Vehicle and Equipment Fueling – Identify equipment fueling locations for this project and what BMPs will be used to ensure containment and spill prevention.
  - Vehicle and Equipment Cleaning and Maintenance – Identify where equipment cleaning and maintenance locations for this project and what BMPs will be used to ensure containment and spill prevention.
  - Additional measures indicated in the plan.

### III. Maintenance:

When requested by the Contractor, the Resident Engineer will provide general maintenance guides to the Contractor for the practices associated with this project. The following additional procedures will be used to maintain, in good and effective operating conditions, the vegetation, erosion and sediment control measures and other protective measures identified in this plan. It will be the Contractor's responsibility to attain maintenance guidelines for any manufactured BMPs which are to be installed and maintained per manufacture's specifications.

During construction, the Contractor will:

Inspect construction entrances from existing roads daily to control off site vehicle tracking. Clean existing roads and maintain entrances per IDOT Standard Specifications Section 107.

Inspect erosion control measures once per week, or as needed, and following any storm event of 0.5" of rain or greater (or 5" of snowfall) during the construction duration.

Maintain erosion control measures in good working order, or replace if specified by the Resident Engineer. If a repair is necessary, the Contractor shall initiate the repair within 24 hours of the report.

Remove and dispose of sediment from inlet and pipe protection measures when it has reached one-third the height of the fence.

Inspect temporary or permanent seeding for bare spots, washouts and healthy growth.

The site contractor will select as many as three individuals who will be responsible for the inspection, maintenance and repair activities and filling out the inspection and maintenance report.

Personnel selected for inspection responsibilities will receive training from the site contractor. They will be trained in all the inspection and maintenance practices necessary for keeping the erosion and sediment controls used onsite in good working order.

**IV Inspections:**

Qualified personnel shall inspect disturbed areas of the construction site which have not yet been finally stabilized, structural control measures, and locations where vehicles and equipment enter and exit the site using IDOT Storm Water Pollution Prevention Plan Erosion Control Inspection Report (BC 2259). Such inspections shall be conducted at least once every seven (7) calendar days and within twenty-four (24) hours of the end of a storm that is 0.5 inch or greater or equivalent snowfall.

If any violation of the provisions of this plan is identified during the conduct of the construction work covered by this plan, the Resident Engineer shall notify the appropriate IEPA Field Operations Section office by email at: [epa.swnoncomp@illinois.gov](mailto:epa.swnoncomp@illinois.gov), telephone or fax within twenty-four (24) hours of the incident. The Resident Engineer shall then complete and submit an "Incidence of Non-Compliance" (ION) report for the identified violation within five (5) days of the incident. The Resident Engineer shall use forms provided by IEPA and shall include specific information on the cause of noncompliance, actions which were taken to prevent any further causes of noncompliance, and a statement detailing any environmental impact which may have resulted from the noncompliance. All reports of non-compliance shall be signed by a responsible authority in accordance with Part VI. G of the Permit ILR10.

The Incidence of Non-Compliance shall be mailed to the following address:

Illinois Environmental Protection Agency  
Division of Water Pollution Control  
Attn: Compliance Assurance Section  
1021 North Grand East  
Post Office Box 19276  
Springfield, Illinois 62794-9276

**V. Failure to Comply:**

Failure to comply with any provisions of this Storm Water Pollution Prevention Plan will result in the implementation of a National Pollutant Discharge Elimination System/Erosion and Sediment Control Deficiency Deduction against the Contractor and/or penalties under the Permit ILR10 which could be passed on to the Contractor.



**Contractor Certification Statement**

Prior to conducting any professional services at the site covered by this contract, the Contractor and every subcontractor must complete and return to the Resident Engineer the following certification. A separate certification must be submitted by each firm. Attach to this certification all items required by Section II.5 of the Storm Water Pollution Prevention Plan (SWPPP) which will be handled by the Contractor/subcontractor completing this form.

Route	<u>FAP 327</u>	Marked Rte.	<u>US 50</u>
Section	<u>(20,21)-J</u>	Project No.	<u>C-98-068-13</u>
County	<u>Clinton</u>	Contract No.	<u>76G67</u>

This certification statement is a part of the SWPPP for the project described above, in accordance with the General NPDES Permit No. ILR10 issued by the Illinois Environmental Protection Agency.

I certify under penalty of law that I understand the terms of the Permit No. ILR 10 that authorizes the storm water discharges associated with industrial activity from the construction site identified as part of this certification.

In addition, I have read and understand all of the information and requirements stated in the SWPPP for the above mentioned project; I have received copies of all appropriate maintenance procedures; and, I have provided all documentation required to be in compliance with the Permit ILR10 and SWPPP and will provide timely updates to these documents as necessary.

- Contractor
- Sub-Contractor

_____	_____
Print Name	Signature
_____	_____
Title	Date
_____	_____
Name of Firm	Telephone
_____	_____
Street Address	City/State/ZIP

Items which this Contractor/subcontractor will be responsible for as required in Section II.5. of the SWPPP:

\_\_\_\_\_

\_\_\_\_\_

\_\_\_\_\_

\_\_\_\_\_



**S.W.P.P INFORMATION**

FAP 327 (US 50)  
 Section (20,21)-J  
 Clinton County  
 D-98-006-13

Soil Type	Soil Symbol	Drainage	Permeability	Flooding	Slopes (%)	Water Erosion	Wind Erosion
Hoyleton Silt Loam, Eroded	3B2	Somewhat Poorly Drained	Slow to Moderately Slow	None	2 - 5	Moderate	Low
Hoyleton-Darmstadt Complex	912A	Somewhat Poorly Drained	Very Slow to Moderately Slow	None	0 - 2	Low	Low
Hoyleton-Darmstadt Complex, Eroded	912B2	Somewhat Poorly Drained	Very Slow to Moderately Slow	None	2 - 5	Moderate	Low
Cisne-Huey Complex	991	Poorly Drained	Very Slow to Moderately Slow	None	0 - 2	Low	Low

**EXAMPLE SOIL TYPE (SOIL SYMBOL) - a DRAINAGE soil with PERMEABILITY permeability. This soil is FLOODING flooded with SLOPES slopes. This soil has a WATER EROSION susceptibility to water erosion and a WIND EROSION susceptibility to wind erosion.**

SLW\CUsers\swdmorep\AppData\Local\Microsoft\Windows\Temporary Internet Files\Content.Outlook\OTSSYQSG\WPPP Information (SLW 91713).xlsx

STATE OF ILLINOIS  
 DEPARTMENT OF TRANSPORTATION  
 PLANS FOR PROPOSED  
 F.A.P. ROUTE 327 (US 50)  
 SECTION (20,21)-J  
 CLINTON COUNTY  
 C-98-068-13  
 PROJECT ACHSIP-0327 (059)  
 FOR INDEX OF SHEETS SEE SHEET NO.2



LOCATION OF SECTION INDICATED THUS ■

D-98-066-13

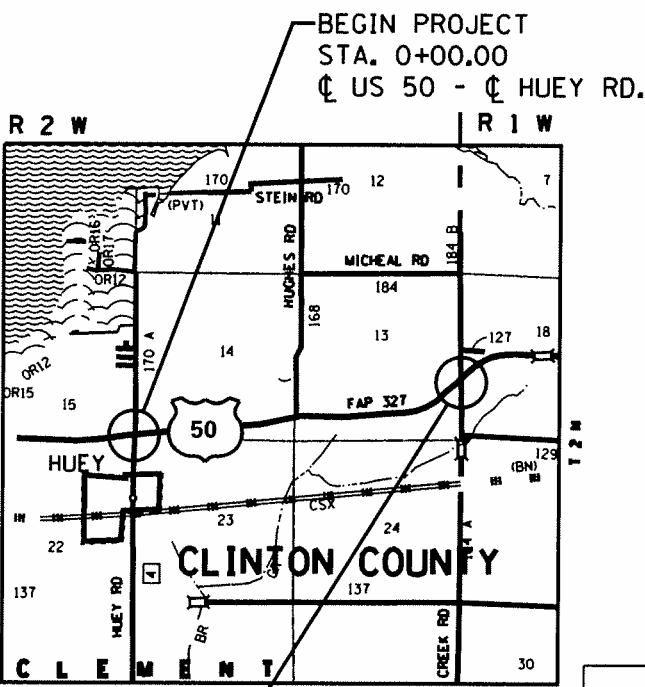

RECEIVED  
 OCT 23 2013  
 CLINTON COUNTY

JOINT UTILITY LOCATION  
 INFORMATION FOR EXCAVATIONS  
 PHONE: (800) 892-0123

END PROJECT  
 STA. 111+06.00  
 @ US 50 - @ CREEK RD.

**LOCATION MAP**  
 NOT TO SCALE

GROSS LENGTH: 11,106'  
 NET LENGTH: 8,985'

CONTRACT NO. 76G67

SUBMITTED 10/18/13  
*Jeffrey Z. K...*  
 DEPUTY DIRECTOR OF HIGHWAYS  
 REGION FIVE ENGINEER

ENGINEER OF DESIGN & ENVIRONMENT

APPROVED \_\_\_\_\_

DIRECTOR, DIVISION OF HIGHWAYS

PRINTED BY THE AUTHORITY OF THE STATE OF ILLINOIS

PLOT DATE: 10/18/2013

PROJECT ENGINEER: MICHAEL PRITCHETT (618) 346-3180  
 SQUAD LEADER: BO WEDMORE (618) 346-3206

INDEX OF SHEETS

TOTAL SHEETS	SHEET NO.
25	2
CONTRACT NO. 76667	

- 1 COVER SHEET
- 2 INDEX OF SHEETS, HIGHWAY STANDARDS, ADT
- 3-4 GENERAL NOTES, COMMITMENTS, MIX CHART
- 5-6 SUMMARY OF QUANTITIES
- 7 LOCATION MAP
- 8-11 SCHEDULE OF QUANTITIES
- 12 TYPICAL SECTIONS
- 13-14 ENTRANCE DETAILS
- 15-19 MISCELLANEOUS DETAILS
- 20-25 GUARDRAIL LOCATION DETAILS

**HIGHWAY STANDARDS**

- 000001-06 STANDARD SYMBOLS, ABBREVIATIONS AND PATTERNS
- 630001-10 STEEL PLATE BEAM GUARDRAIL
- 630106-01 LONG-SPAN GUARDRAIL OVER CULVERT
- 630301-06 SHOULDER WIDENING FOR TYPE 1 (SPECIAL) GUARDRAIL TERMINALS
- 642006 SHOULDER RUMBLE STRIPS, 8 IN.
- 701001-02 OFF-RD OPERATIONS, 2L, 2W, MORE THAN 15' AWAY
- 701006-05 OFF-RD OPERATIONS, 2L, 2W, 15' TO 24" FROM PAVEMENT EDGE
- 701011-04 OFF-RD MOVING OPERATIONS, 2L, 2W, DAY ONLY
- 701201-04 LANE CLOSURE, 2L, 2W, DAY ONLY, FOR SPEEDS > 45MPH
- 701301-04 LANE CLOSURE, 2L, 2W, SHORT TIME OPERATIONS
- 701306-03 LANE CLOSURE, 2L, 2W, SLOW MOVING OPERATIONS  
DAY ONLY FOR SPEEDS >= 45MPH
- 701311-03 LANE CLOSURE 2L, 2W MOVING OPERATIONS-DAY ONLY
- 701326-04 LANE CLOSURE, 2L, 2W, PAVMENT WIDENING FOR SPEEDS >= 45 MPH
- 701901-03 TRAFFIC CONTROL DEVICES
- 780001-04 TYPICAL PAVEMENT MARKINGS

ADT INFORMATION

- 2011 ADT = 4000 (ACTUAL)
- 2014 ADT = 4100 (ESTIMATED)
- 2034 ADT = 4500 (ESTIMATED)
- SU = 4.0%
- MU = 11.9%

**INDEX OF SHEETS,  
STANDARDS AND ADT**

F.A.P. ROUTE 327 (US 50)  
SECTION (20,21)-J  
CLINTON COUNTY

PLOT DATE: 10/21/2013

\*\*\*DATE\*\*  
10/21/2013  
c:\pwwork\pwwork\adtdot\eedmore\p\035108\08\087667-sht-pln.dgn

# GENERAL NOTES

TOTAL SHEETS	SHEET NO.
25	3
CONTRACT NO. 76G67	

1. THE CONTRACTOR SHALL VERIFY ALL DIMENSIONS AND CONDITIONS IN THE FIELD PRIOR TO CONSTRUCTION AND ORDERING OF MATERIALS.
2. NO OVERNIGHT LANE CLOSURES SHALL BE ALLOWED ON THE PROJECT.
3. FLAGMEN SHALL BE PRESENT DURING ALL CLOSURE HOURS INCLUDING LUNCH HOUR AND NO ADDITIONAL COMPENSATION SHALL BE ALLOWED.
4. THE LAYOUT OF THE GUARDRAIL IS APPROXIMATE. POST SPACING, END TERMINALS AND OFFSET FROM EDGE OF PAVEMENT SHALL BE DETERMINED BY THE ENGINEER.
5. ILLINOIS STATE LAW REQUIRES A 48-HOUR NOTICE BE GIVEN TO UTILITIES BEFORE DIGGING. FIELD MARKING OF FACILITIES MAY BE OBTAINED BY CONTACTING J.U.L.I.E. OR FOR NON-MEMBERS, THE UTILITY COMPANY DIRECTLY. AGENCIES KNOWN TO HAVE FACILITIES WITHIN THE PROJECT AREA ARE AS FOLLOWS:
  - AMEREN IL - ELECTRIC & GAS
  - AT&T - COMMUNICATIONS
  - CLINTON COUNTY EAST PUBLIC WATER DISTRICT - WATER
  - CLINTON COUNTY ELECTRIC COOPERATIVE, INC. - ELECTRIC
  - FRONTIER NORTH, INC. - COMMUNICATIONS
  - LIBERTY UTILITIES - GAS
- MEMBERS OF J.U.L.I.E. (800) 892-0123 OR 811 ARE INDICATED BY \*. NON-J.U.L.I.E. MEMBERS MUST BE NOTIFIED INDIVIDUALLY.
6. EXISTING CENTERLINE SKIP-DASH FOR US 50 IN THE PROJECT AREA SHALL BE COVERED WITH PAVEMENT MARKING TAPE, TYPE III, BLACK WHEN SHIFTING TRAFFIC. 2250 FOOT OF PAVEMENT MARKING TAPE, TYPE III, BLACK 6" SPECIAL, HAS BEEN INCLUDED IN THE SUMMARY OF QUANTITIES. THIS WILL ALLOW THE SHORT TERM PAVEMENT MARKING TO BE USED TO SHIFT THE CENTERLINE IN ORDER TO PROVIDE EQUAL WIDTH LANES FROM THE REMAINING PAVEMENT.
7. THE CONTRACTOR AND THE ENGINEER SHALL BE AWARE THAT NO SURVEY WAS PERFORMED FOR THIS PROJECT. THE STATIONING, TOPOGRAPHY AND QUANTITIES SHOWN ON THESE PLANS WERE CREATED USING MICROFILM AND FIELD MEASUREMENTS. ALL SHALL BE ASSUMED TO BE APPROXIMATE. THE CONTRACTOR SHALL VERIFY DIMENSIONS AND CONDITIONS IN THE FIELD PRIOR TO CONSTRUCTION AND ORDERING OF MATERIALS.

## GENERAL NOTES

F.A.P. ROUTE 327 (US 50)  
SECTION (20,21)-J  
CLINTON COUNTY

PLOT DATE: 10/21/2013

# COMMITMENTS

TOTAL SHEETS	SHEET NO.
25	4
CONTRACT NO. 76G67	

1. THE PROJECT SHOULD NOT HAVE ANY ADVERSE EFFECT ON THE SUITABLE HABITAT FOR THE EASTERN MASSASAUGA (SISTRURUS CATENATUS), PROVIDING THAT WORKERS ON THE PROJECT ARE INSTRUCTED THAT ANY SNAKES ENCOUNTERED ARE NOT TO BE KILLED.

MIXTURE USE	SURFACE	BINDER
AC/PG	PG 64-22	PG 64-22
DESIGN AIR VOIDS	4.0% @ Ndes=90	4.0% @ Ndes=90
MIX COMPOSITION (GRADATION MIXTURE)	IL 9.5	IL 19.0 FG
	MIXTURE "D"	MIXTURE "B"

PLAN QUANTITIES FOR BITUMINOUS CONCRETE SURFACE COURSE ITEMS ARE CALCULATED USING A UNIT WEIGHT OF 112 LBS/SO YD/IN (59.3 KG/SO M/25MM) THICKNESS.

## GENERAL NOTES

F.A.P. ROUTE 327 (US 50)  
SECTION (20,21)-J  
CLINTON COUNTY

PLOT DATE: 10/21/2013

\*\*DATE\*\*  
 10/21/2013  
 c:\p\work\p\1001\wedmore\p\035108\0876g67-sht-pln.dgn

TOTAL SHEETS	SHEET NO.
25	5
CONTRACT NO. 76667	

# SUMMARY OF QUANTITIES

90/10  
FED/STATE

CODE NO	ITEM	UNIT	ROADWAY
			RURAL
20200100	EARTH EXCAVATION	CU YD	1550
25000210	SEEDING, CLASS 2A	ACRE	5.75
25000400	NITROGEN FERTILIZER NUTRIENT	POUND	518
25000500	PHOSPHORUS FERTILIZER NUTRIENT	POUND	518
25000600	POTASSIUM FERTILIZER NUTRIENT	POUND	518
25100115	MULCH, METHOD 2	ACRE	4.75
25100900	TURF REINFORCEMENT MAT	SQ YD	3333
28000250	TEMPORARY EROSION CONTROL SEEDING	POUND	475
28000305	TEMPORARY DITCH CHECKS	FOOT	900
28100205	STONE RIPRAP, CLASS A3	TON	1062
28200200	FILTER FABRIC	SQ YD	3962
40201000	AGGREGATE FOR TEMPORARY ACCESS	TON	58
40600200	BITUMINOUS MATERIALS (PRIME COAT)	TON	22.5
40600300	AGGREGATE (PRIME COAT)	TON	14
40603092	HOT-MIX ASPHALT BINDER COURSE, IL-19.0 FG, N90	TON	4403
40603345	HOT-MIX ASPHALT SURFACE COURSE, MIX "D", N90	TON	1132
44000100	PAVEMENT REMOVAL	SQ YD	3993
44000200	DRIVEWAY PAVEMENT REMOVAL	SQ YD	57
48102100	AGGREGATE WEDGE SHOULDER, TYPE B	TON	5
* 63000003	STEEL PLATE BEAM GUARDRAIL, TYPE A, 9 FOOT POSTS	FOOT	2075
* 63000350	LONG-SPAN GUARDRAIL OVER CULVERT, 12 FT 6 IN SPAN	FOOT	612.5

21

\* SPECIALTY ITEM

## SUMMARY OF QUANTITIES

F.A.P. ROUTE 327 (US 50)  
SECTION (20,21)-J  
CLINTON COUNTY

PLOT DATE: 10/21/2013

10/21/2013  
 c:\pwr\work\pwr\dot\wedmore\p\0351108\0876967-sht-pln.dgn



TOTAL SHEETS	SHEET NO.
25	7
CONTRACT NO. 76667	

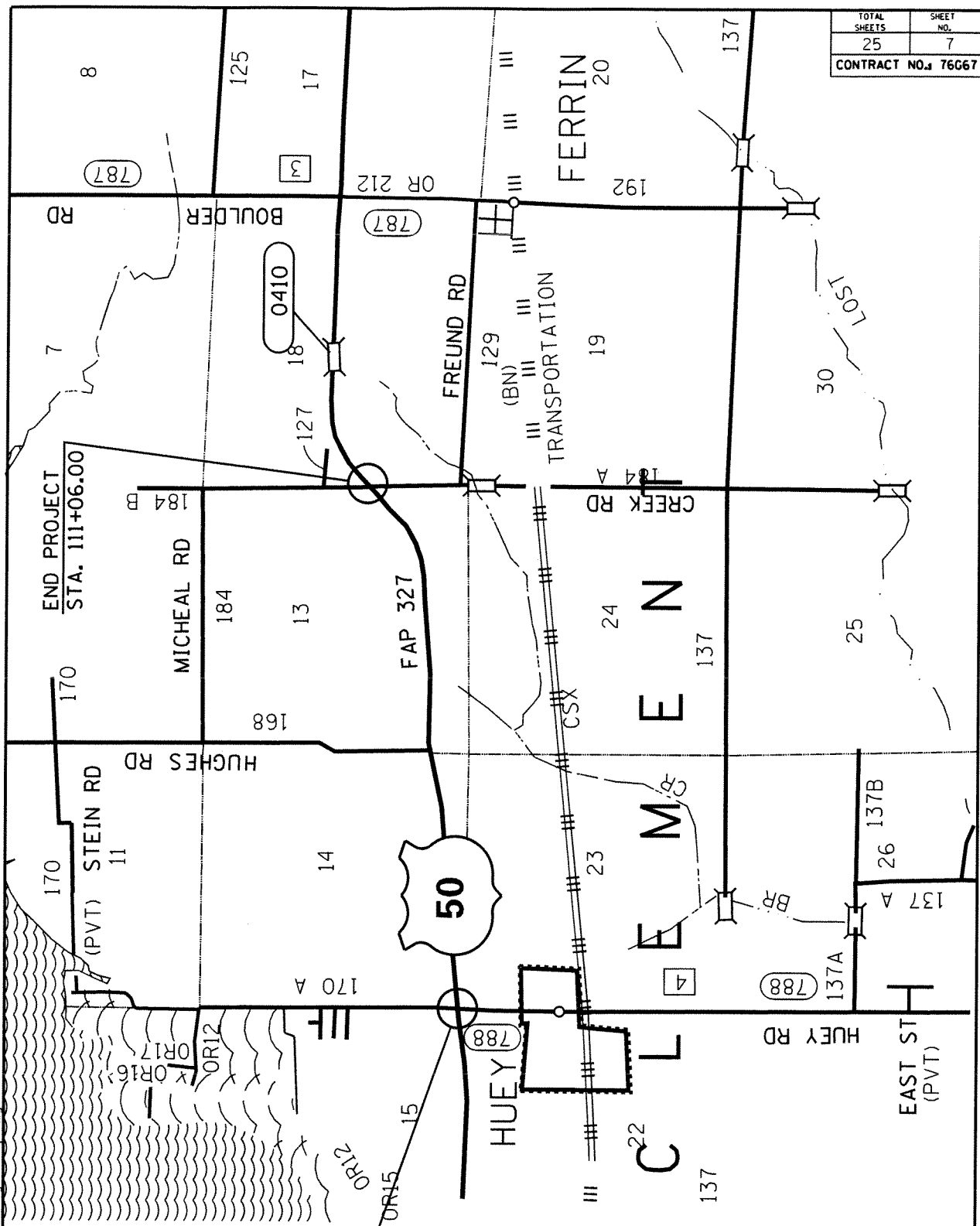

END PROJECT  
STA. 111+06.00

BEGIN PROJECT  
STA. 0+00.00

NOT TO SCALE

LOCATION MAP

F.A.P. ROUTE 327 (US 50)  
SECTION (20,21)-J  
CLINTON COUNTY

PLOT DATE: 10/21/2013

DATE: 10/21/2013  
c:\p\work\p\dot\wedmore.jp\0351108\487667-sht-plondon



**GUARDRAIL SCHEDULE**

LOCATION	LENGTH		LT/RT	STEEL PLATE BEAM GUARDRAIL TYPE A, 9 FOOT POSTS	LONG-SPAN GUARDRAIL OVER CULVERT 12'-6" SPAN	LONG-SPAN GUARDRAIL OVER CULVERT 18'-9" SPAN	TRAFFIC BARRIER TERMINAL TYPE I, (SPECIAL) TANGENT	STONE RIPRAP CLASS A3	FILTER FABRIC	GUARDRAIL MARKERS, TYPE A	TERMINAL MARKERS DIRECT APPLIED	
	STA.	TO STA.										FOOT
	11+10.00	TO 13+10.00	200.0	LT			2	52.0	194	1	2	
	13+64.25	TO 16+89.25	325.0	LT			2	85.0	316	3	2	
	17+42.00	TO 19+54.50	212.5	LT			2	56.0	207	1	2	
	19+99.75	TO 28+87.25	887.5	LT	162.50		2	231.0	863	8	2	
	55+83.13	TO 59+39.38	356.3	LT		168.75	2	93.0	346	1	2	
	72+39.25	TO 77+39.25	500.0	LT	162.50		2	130.0	486	3	2	
	17+38.25	TO 19+38.25	200.0	RT			2	52.0	194	1	2	
	19+87.25	TO 26+49.75	662.5	RT	162.50		2	172.0	644	5	2	
	55+20.63	TO 58+76.88	356.3	RT		168.75	2	93.0	346	1	2	
	71+63.75	TO 75+60.00	375.0	RT	125.00		3	98.0	365	1	3	
<b>TOTAL</b>					2075.0	612.5	337.5	21	1062.0	3962	26	21

**NOTES:**

- 1 THE LAST THREE (3) SECTIONS OF GUARDRAIL ON THE EAST END OF THE STANDARD LONG-SPAN SECTION ARE BEING REPLACED WITH TWO (2) SECTIONS OF RADIUS. TO BE PAID FOR AS STANDARD SPBGR. SEE GUARDRAIL LOCATION DETAIL.

NOT TO SCALE

**SCHEDULE OF QUANTITIES**

F.A.P. ROUTE 327 (US 50)  
SECTION (20,21)-J  
CLINTON COUNTY

DATE: 10/21/2013  
 C:\p\work\p\p\dot\wedmore b\09351108\0876467-shr-plot.dgn

SEEDING/EROSION CONTROL SCHEDULE

LOCATION		LT/RT	SEEDING CLASS 2A	NITROGEN FERTILIZER NUTRIENT			PHOSPHORUS FERTILIZER NUTRIENT			POTASSIUM FERTILIZER NUTRIENT			MULCH, METHOD 2	TEMPORARY EROSION CONTROL SEEDING		TURF REINFORCEMENT MAT	NOTES
STA.	TO STA.			ACRE	POUND	POUND	POUND	POUND	POUND	POUND	POUND	POUND		POUND	ACRE		
0+00.00	TO 89+85.00	LT	2.25	202.5	202.5	202.5	202.5	202.5	202.5	202.5	202.5	2.25	225				
0+00.00	TO 89+85.00	RT	2.50	225.0	225.0	225.0	225.0	225.0	225.0	225.0	225.0	2.50	250				
7+45.00	TO 17+45.00	RT	0.50	45.0	45.0	45.0	45.0	45.0	45.0	45.0	45.0			1667		CENTERED ON 6X4 CMP	
47+87.00	TO 52+87.00	LT	0.25	22.5	22.5	22.5	22.5	22.5	22.5	22.5	22.5			833		WEST OF HUGHES RD.	
53+43.00	TO 58+43.00	LT	0.25	22.5	22.5	22.5	22.5	22.5	22.5	22.5	22.5			833		EAST OF HUGHES RD.	
TOTAL			5.75	517.5	517.5	517.5	517.5	517.5	517.5	517.5	517.5	4.75	475	3333			
USE			5.75	518	518	518	518	518	518	518	518	4.75	475	3333			

TOTAL SHEETS: 25  
 SHEET NO.: 9  
 CONTRACT NO.: 76667

PAVEMENT MARKING SCHEDULE

LOCATION			PAINT PAVEMENT MARKING - LINE 4"		TEMPORARY PAVEMENT MARKING - LINE 4"		SHORT TERM PAVEMENT MARKING		PAVEMENT MARKING TAPE, TYPE III 6", SPECIAL	WORK ZONE PAVEMENT MARKING REMOVAL	COMMENTS
STA	TO	STA	RT/LT	(WHITE)	(YELLOW)	(WHITE)	(YELLOW)	(YELLOW)			
00+00.00	TO	53+15.00	LT	5259		5259					WHITE EDGELINE
53+15.00	TO	89+85.00	LT	3670		3670					WHITE EDGELINE
00+00.00	TO	89+85.00	RT	8985		8985					WHITE EDGELINE
00+00.00	TO	89+85.00	CENTER		2250		2250	1632	2250	1669	CENTERLINE SHIFT
SUB-TOTAL				17914	2250	17914	2250	1632	2250	1669	
TOTAL				20164	2250	20164	2250	1632	2250	1669	

NOT TO SCALE

SCHEDULE OF QUANTITIES

F.A.P. ROUTE 327 (US 50)  
 SECTION (20,21)-J  
 CLINTON COUNTY

PLOT DATE: 10/21/2013

## SHOULDER SCHEDULE

LOCATION		RT/LT	EARTH EXCAVATION CUYD	PAVEMENT REMOVAL SQ YD	HMA SC "D" N90 TON	HMA BC IL-19.0 FG N90 TON	BITUMINOUS MATERIALS (PRIME COAT) TON	AGGREGATE (PRIME COAT) TON	SHOULDER RUMBLE STRIPS, 8" FOOT
STA TO STA									
0+00.00	TO 1+52.00	LT	13.12	34	10	37	0.2	0.1	129.50
1+52.00	TO 17+15.00	LT	134.88	347	98	383	2.0	1.2	1529.50
17+15.00	TO 46+90.00	LT	256.73	661	187	729	3.7	2.3	2942.00
46+90.00	TO 53+15.00	LT	53.94	139	39	153	0.8	0.5	575.00
53+15.00	TO 89+85.00	LT	316.71	816	231	899	4.6	2.9	3642.00
0+00.00	TO 3+75.00	RT	32.36	83	24	92	0.5	0.3	362.00
3+75.00	TO 4+92.00	RT	10.10	26	7	29	0.1	0.1	79.50
4+92.00	TO 31+90.00	RT	232.83	600	170	661	3.4	2.1	2661.50
31+90.00	TO 43+23.00	RT	97.77	252	71	278	1.4	0.9	1110.00
43+23.00	TO 53+70.00	RT	90.35	233	66	257	1.3	0.8	1024.50
53+70.00	TO 89+85.00	RT	311.96	803	228	886	4.5	2.8	3603.50
<b>TOTAL</b>			<b>1550</b>	<b>3993</b>	<b>1132</b>	<b>4403</b>	<b>22.5</b>	<b>14</b>	<b>17659</b>

## RAISED FLECTIVE PAVEMENT MARKERS

LOCATION	RAISED REFLECTIVE PAVEMENT MARKER REMOVAL		RAISED REFLECTIVE PAVEMENT MARKER	
	(AMBER) EACH	225	(AMBER) EACH	225
00+00.00 TO 89+85.00		225		225
<b>TOTAL</b>	<b>225</b>		<b>225</b>	

NOTE:  
THESE ITEMS ARE FOR THE REFLECTORS ONLY.

NOT TO SCALE

## SCHEDULE OF QUANTITIES

F.A.P. ROUTE 327 (US 50)  
SECTION (20,21)-J  
CLINTON COUNTY

TOTAL SHEETS	SHEET NO.
25	11
CONTRACT NO. 76G67	

## GUARDRAIL REMOVAL

LOCATION			LT/RT	GUARDRAIL REMOVAL FOOT
12+15.00	TO	13+17.00	LT	102
14+14.00	TO	16+81.25	LT	267
17+46.00	TO	19+62.00	LT	216
19+96.00	TO	21+14.00	LT	118
24+68.00	TO	27+20.00	LT	252
56+89.00	TO	58+78.00	LT	189
73+33.00	TO	74+59.00	LT	126
18+45.00	TO	19+45.00	RT	100
19+84.00	TO	20+89.00	RT	105
24+15.00	TO	25+42.00	RT	127
56+77.00	TO	57+71.00	RT	94
72+82.00	TO	74+09.00	RT	127
<b>TOTAL</b>				<b>1823</b>

## DRIVEWAY PAVEMENT

LOCATION		WIDTH	DRIVEWAY PAVEMENT REMOVAL	AGGREGATE FOR TEMPORARY ACCESS	AGGREGATE WEDGE SHOULDER, TYPE B
STA	RT/LT		SQ YD	TON	TON
1+52.00	LT	45	15.00	15	
3+75.00	RT	26			1
4+92.00	RT	49	16.33	16	
17+15.00	LT	22	7.33	8	
31+90.00	RT	24			1
43+23.00	RT	22			1
46+90.00	LT	44			2
53+15.00	LT	56	18.67	19	
53+70.00	RT	23			1
<b>TOTAL</b>			<b>57</b>	<b>58</b>	<b>5</b>

NOT TO SCALE

### SCHEDULE OF QUANTITIES

F.A.P. ROUTE 327 (US 50)  
SECTION (20,21)-J  
CLINTON COUNTY

PLOT DATE: 10/21/2013

\*\*DATE\*\*  
 10/21/2013  
 c:\p\work\purdot\veedmore\p\d0351106\d876g67-sht-pl.dgn

TOTAL SHEETS	SHEET NO.
25	12
CONTRACT NO. 76667	

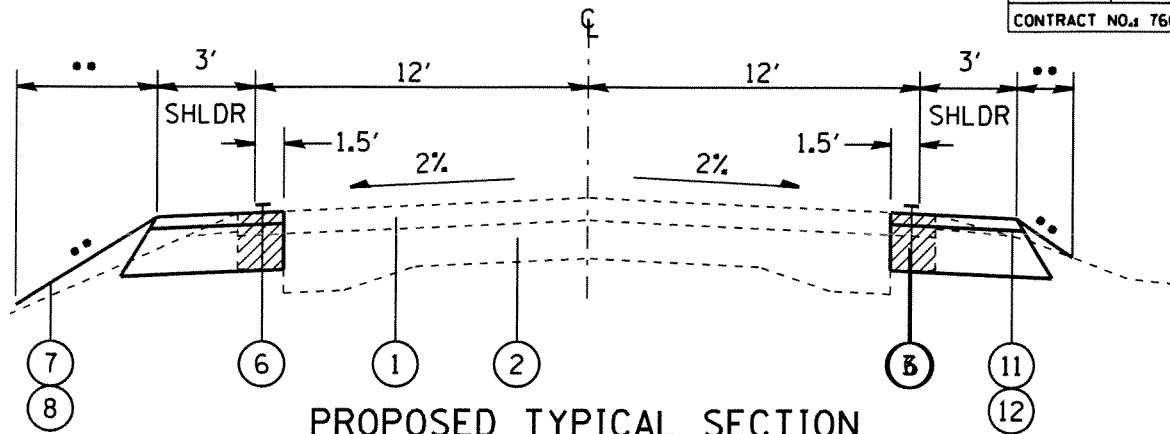

**PROPOSED TYPICAL SECTION**

EXCEPT ADJACENT TO GUARDRAIL  
SEE GUARDRAIL SCHEDULE FOR STATIONS

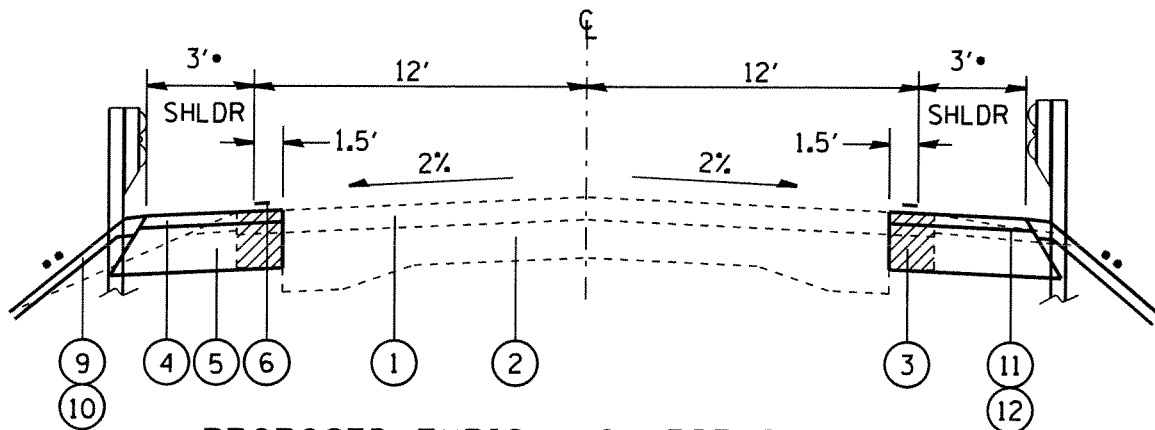

**PROPOSED TYPICAL GUARDRAIL SECTION**

SEE GUARDRAIL SCHEDULE FOR STATIONS  
AND DIMENSIONS

**LEGEND**

- ① EXISTING HMA OVERLAY (4 1/2" MIN.)
- ② EXISTING P.C.C. PAVEMENT (9-6-9)
- ③ EXISTING HOT-MIX ASPHALT BASE COURSE WIDENING-6"
- ④ PROPOSED HOT-MIX ASPHALT SURFACE COURSE, MIX "D", N90, 2 1/4"
- ⑤ PROPOSED HOT-MIX ASPHALT BINDER COURSE, IL-19.0 FG, N90, 8 3/4"
- ⑥ PROPOSED PAINT PAVEMENT MARKING  
- LINE 4" (WHITE EDGELINE)
- ⑦ PROPOSED SEEDING, CLASS 2A & FERTILIZER NUTRIENTS
- ⑧ PROPOSED MULCH, METHOD 2
- ⑨ PROPOSED STONE RIPRAP CL A3
- ⑩ PROPOSED FILTER FABRIC
- ⑪ PROPOSED BITUMINOUS MATERIALS (PRIME COAT)
- ⑫ PROPOSED AGGREGATE (PRIME COAT)



= PAVEMENT REMOVAL  
CONSISTS OF 1.5' EXISTING WIDENING  
AND 0.5' OF SAFETY SHOULDER.  
EXACT THICKNESS IS UNKNOWN, BUT  
IS ASSUMED TO BE LESS THAN OR  
EQUAL TO PROPOSED HMA SURFACE  
AND BINDER.

- 1' OVER CROSS ROAD CULVERTS
- SEE DETAILS, SHEETS \*16-\*19

**TYPICAL SECTIONS**

F.A.P. ROUTE 327 (US 50)  
SECTION (20,21)-J  
CLINTON COUNTY

PLOT DATE: 10/21/2013

\*\*DATE\*\*  
 10/21/2013  
 c:\p\work\p\dot\wedmore\p\0351108\d876667-sh-t-pln.dgn

TOTAL SHEETS	SHEET NO.
25	13
CONTRACT NO. 76G67	

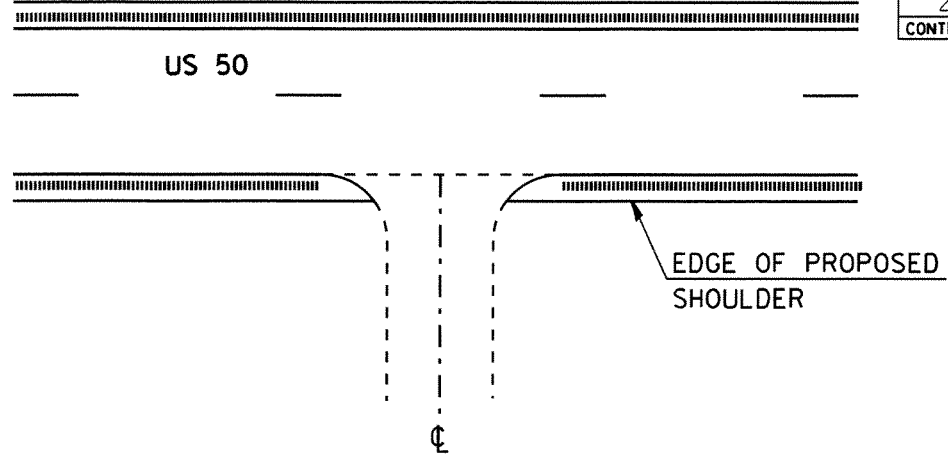

**SIDE ROAD DETAIL**  
AT HOT-MIX ASPHALT AND CONCRETE SIDE ROADS

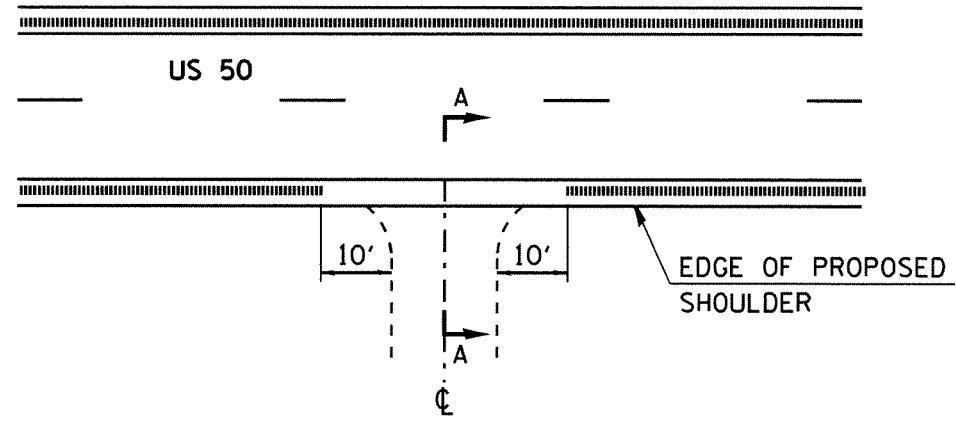

**ENTRANCE DETAIL**  
AT AGGREGATE ENTRANCES

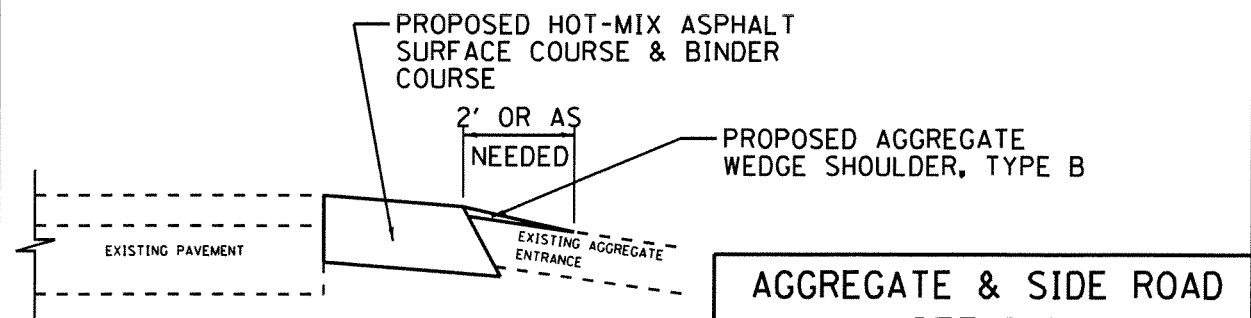

**SECTION A-A**

**AGGREGATE & SIDE ROAD  
DETAILS**

F.A.P. ROUTE 327 (US 50)  
SECTION (20,21)-J  
CLINTON COUNTY

\$\$\$\$DATE\$\$\$  
10/21/2013  
c:\pva\work\pva\dot\wedmore\p\0351108\4876\67-sht-pln.dgn

PLOT DATE: 10/21/2013

TOTAL SHEETS	SHEET NO.
25	14
CONTRACT NO. 76667	

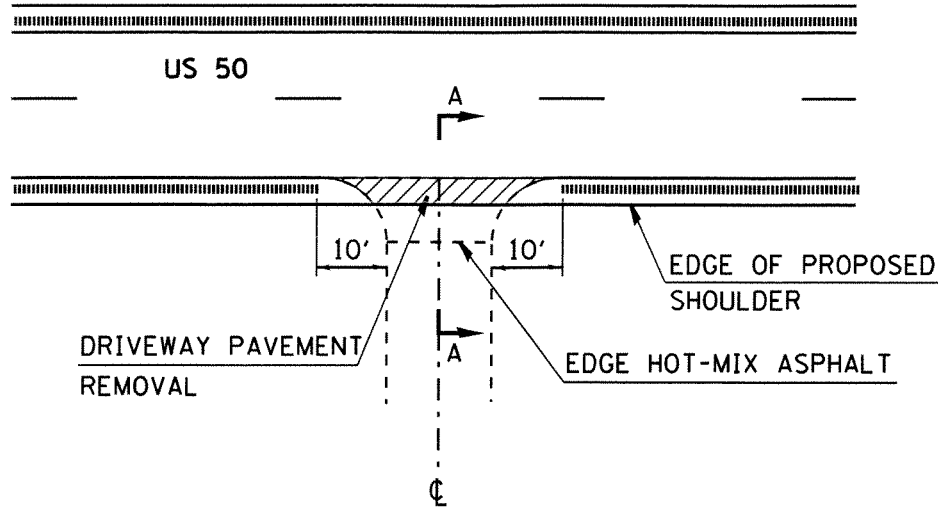

ENTRANCE DETAIL  
AT HOT-MIX ASPHALT ENTRANCES

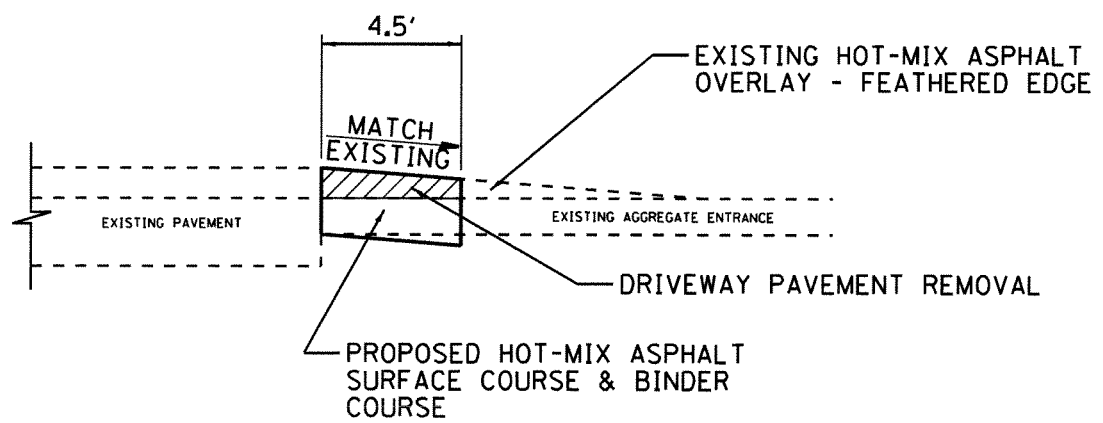

SECTION A-A

**HMA ENTRANCE DETAILS**

F.A.P. ROUTE 327 (US 50)  
SECTION (20,21)-J  
CLINTON COUNTY

PLOT DATE: 10/21/2013

\$\$\$DATE\$\$\$  
10/21/2013  
c:\p...acrk\p...dot\eedmore\p\d035\108\4876667-sh.t:pln.dgn

TOTAL SHEETS	SHEET NO.
25	15
CONTRACT NO. 7667	

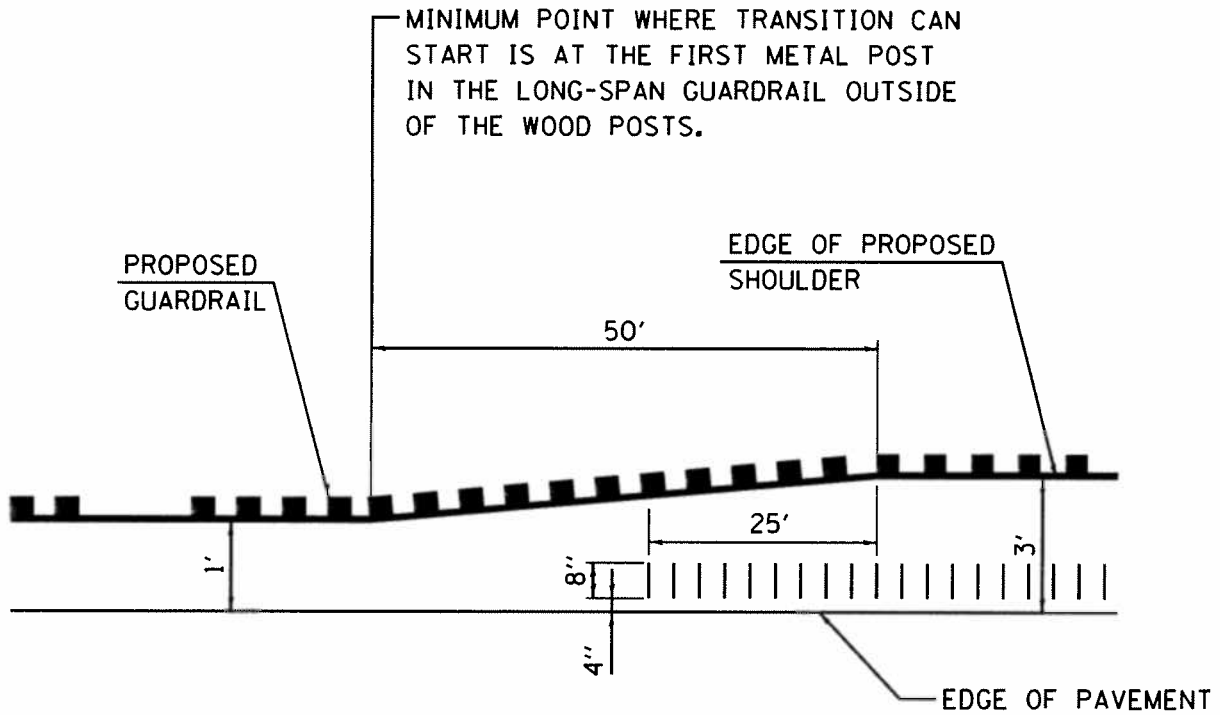

### SHOULDER TRANSITION DETAIL

FOR USE AT CROSSROAD CULVERTS  
TO BE DETERMINED BY THE ENGINEER

### MISCELLANEOUS DETAILS

F.A.P. ROUTE 327 (US 50)  
SECTION (20,21)-J  
CLINTON COUNTY

PLOT DATE: 10/21/2013

\*\*\*DATE\*\*  
10/21/2013  
c:\pe\_work\p1\dot\eedmore.jp\0351108\087667-sht-pln.dgn



TOTAL SHEETS	SHEET NO.
25	16
CONTRACT NO. 76067	

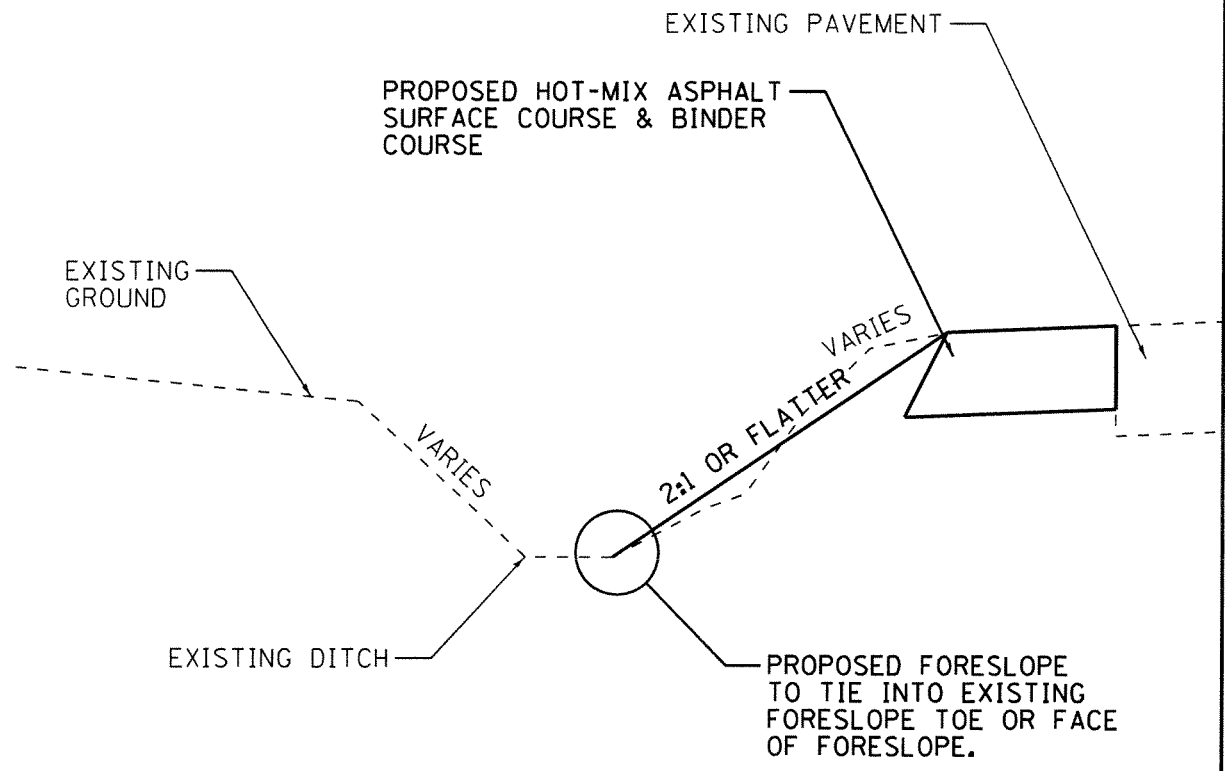

TYPICAL SLOPE GRADING DETAIL

**SLOPE GRADING DETAIL**

F.A.P. ROUTE 327 (US 50)  
SECTION (20,21)-J  
CLINTON COUNTY

PLOT DATE: 10/21/2013

DATE: 10/21/2013  
 c:\p\work\p\dot\wedmore\p\0351108\vd876s67-sht-pln.dgn

TOTAL SHEETS	SHEET NO.
25	17
CONTRACT NO. 76667	

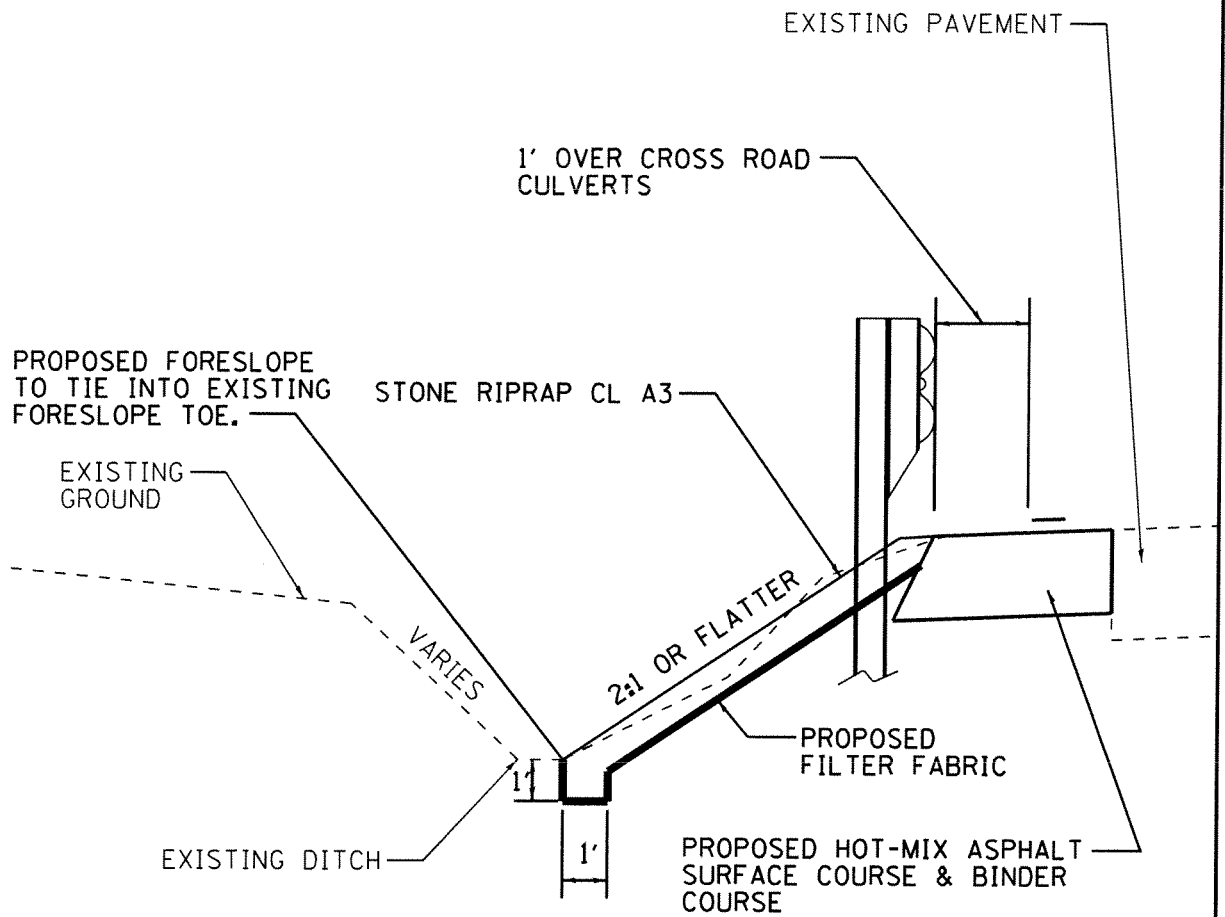

TYPICAL SLOPE CORRECTION DETAIL  
BEHIND GUARDRAIL

RIPRAP DETAILS

F.A.P. ROUTE 327 (US 50)  
SECTION (20,21)-J  
CLINTON COUNTY

PLOT DATE: 10/21/2013

\*\*DATE\*\*  
 10/21/2013  
 c1\pa\_work\p1\dot\weedmore\_ib\0351108\4876367-sht.plt.dgn

TOTAL SHEETS	SHEET NO.
25	18
CONTRACT NO. 76G67	

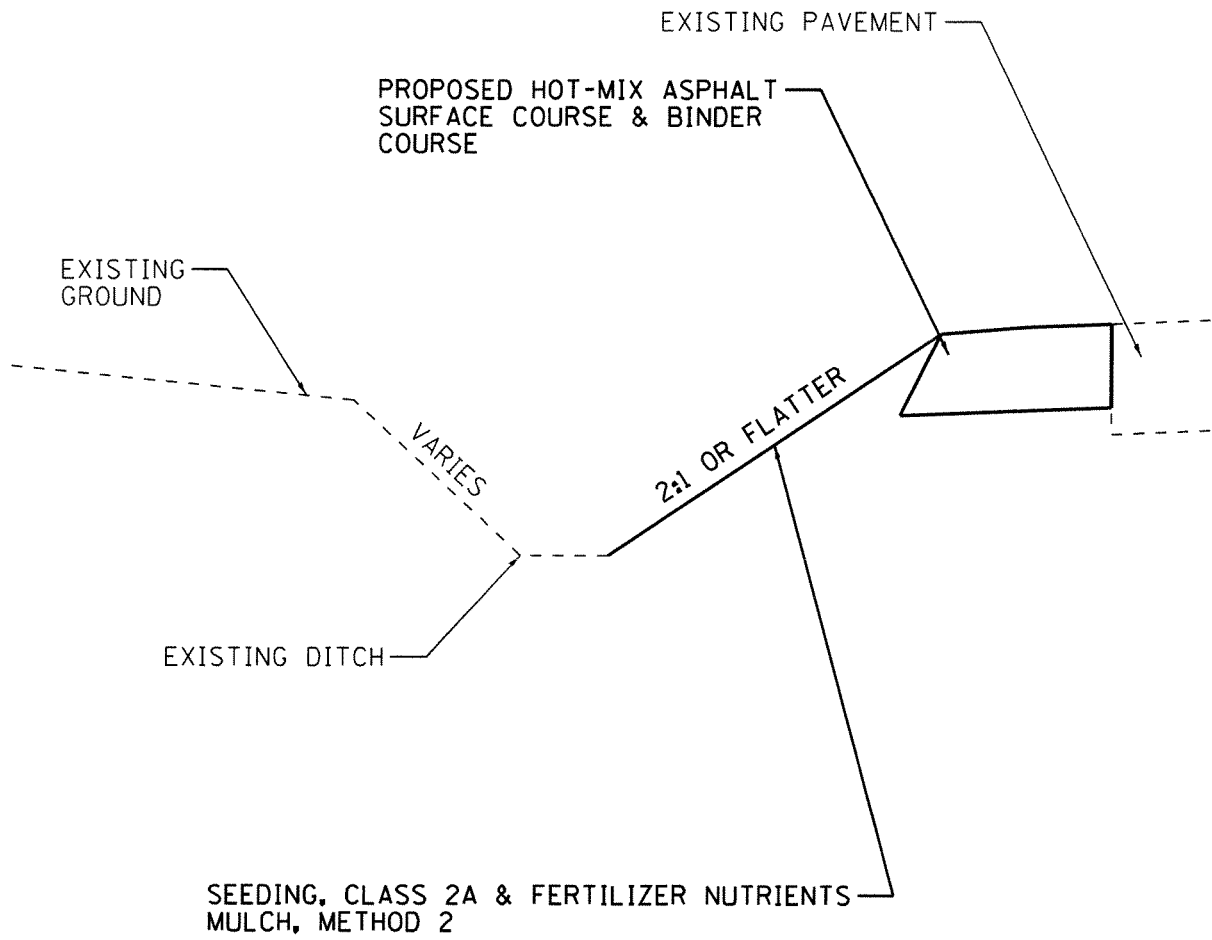

**NOTES:**

- ENGINEER SHALL DETERMINE LOCATIONS FOR DITCH CHECKS PER WORK AREA DISTURBED.

**SEEDING CONTROL  
DETAIL**

F.A.P. ROUTE 327 (US 50)  
SECTION (20,21)-J  
CLINTON COUNTY

PLOT DATE: 10/21/2013

s:\DATESS  
 10/21/2013  
 c:\pa...work\purdot\weedmore\p\d0351108\08\4876g67-sht:pln.dgn

TOTAL SHEETS	SHEET NO.
25	19
CONTRACT NO. 76667	

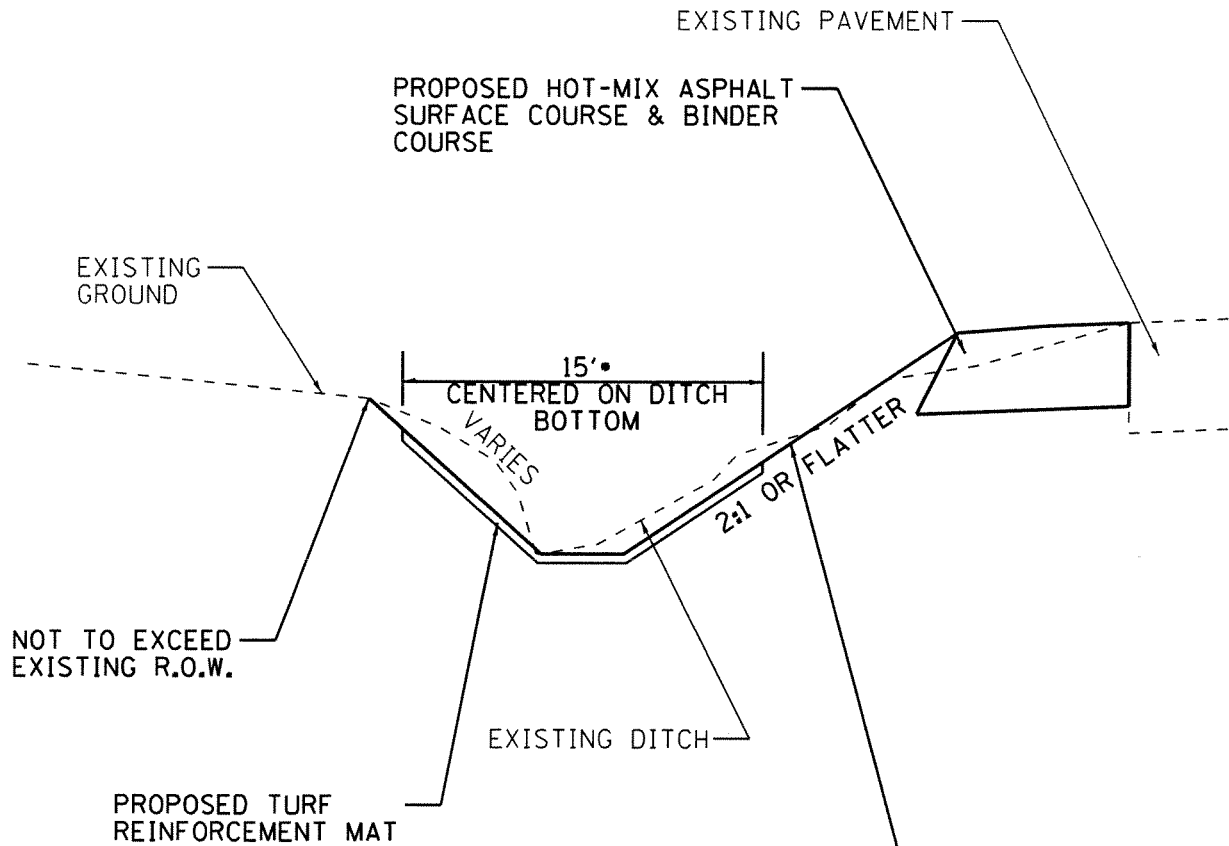

SCRAPING OF EXISTING DITCH TO CLEAR VEGETATION AND MAKE A UNIFORM SURFACE FOR THE SEED BED AND APPLICATION OF TURF REINFORCEMENT MAT. THE COST OF THIS WORK SHALL BE INCLUDED IN THE COST FOR TURF REINFORCEMENT MAT AND NO ADDITIONAL COMPENSATION WILL BE ALLOWED

- ACTUAL WIDTH AND PLACEMENT OF TURF REINFORCEMENT MAP TO BE DETERMINED BY THE ENGINEER.

### TURF REINFORCEMENT MAT DETAIL

F.A.P. ROUTE 327 (US 50)  
SECTION (20,21)-J  
CLINTON COUNTY

PLOT DATE: 10/21/2013

TOTAL SHEETS	SHEET NO.
25	20
CONTRACT NO. J 7667	

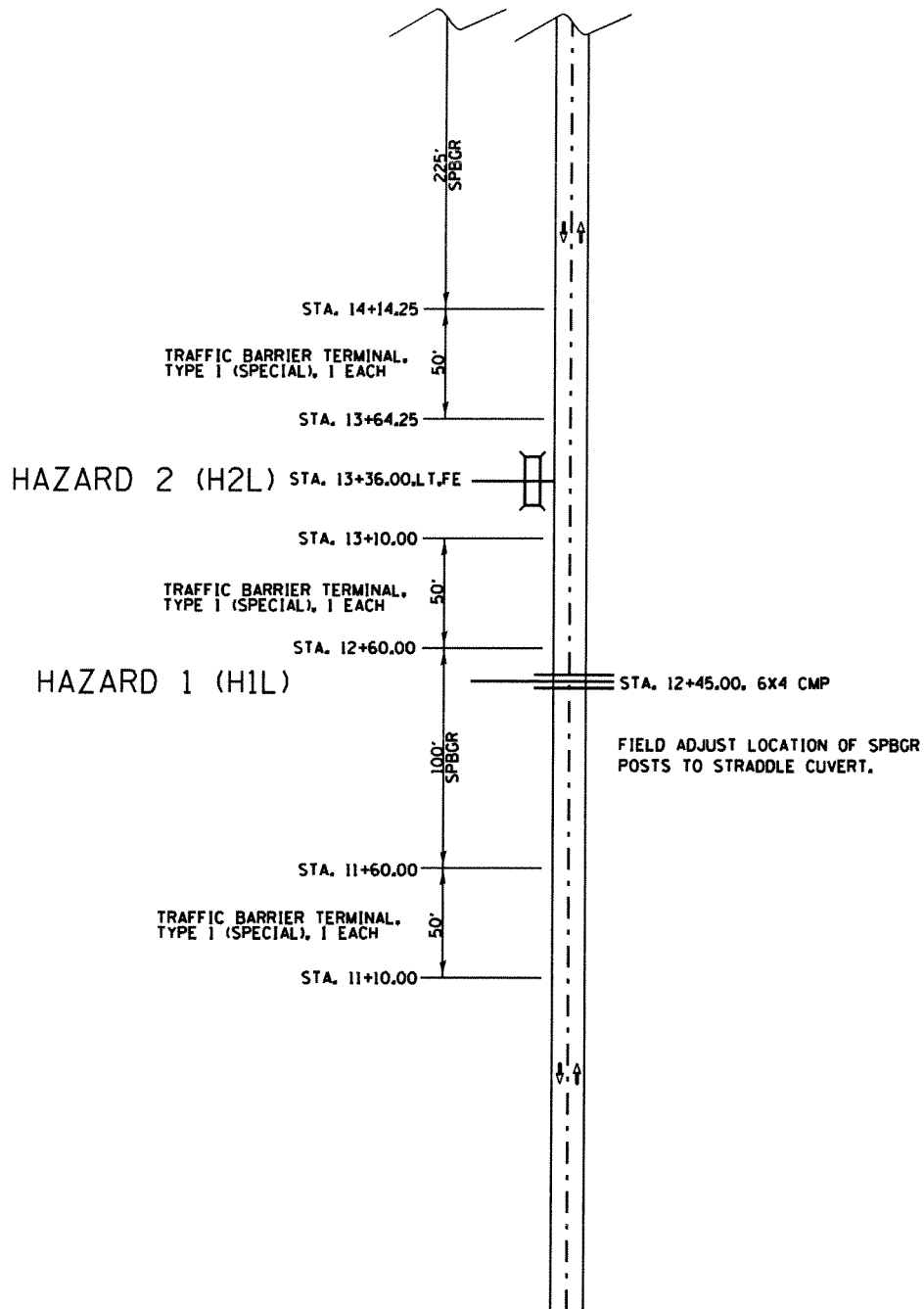
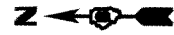

NOT TO SCALE

H1L & H2L GUARDRAIL  
LOCATION DETAIL

F.A.P. ROUTE 327 (US 50)  
SECTION (20,21)-J  
CLINTON COUNTY

PLOT DATE: 10/21/2013

DATE: 10/21/2013  
C:\pwork\p1\dot\eedmore\p\035\108\487667-sht-pln.dgn

TOTAL SHEETS	SHEET NO.
25	21
CONTRACT NO. 76G67	

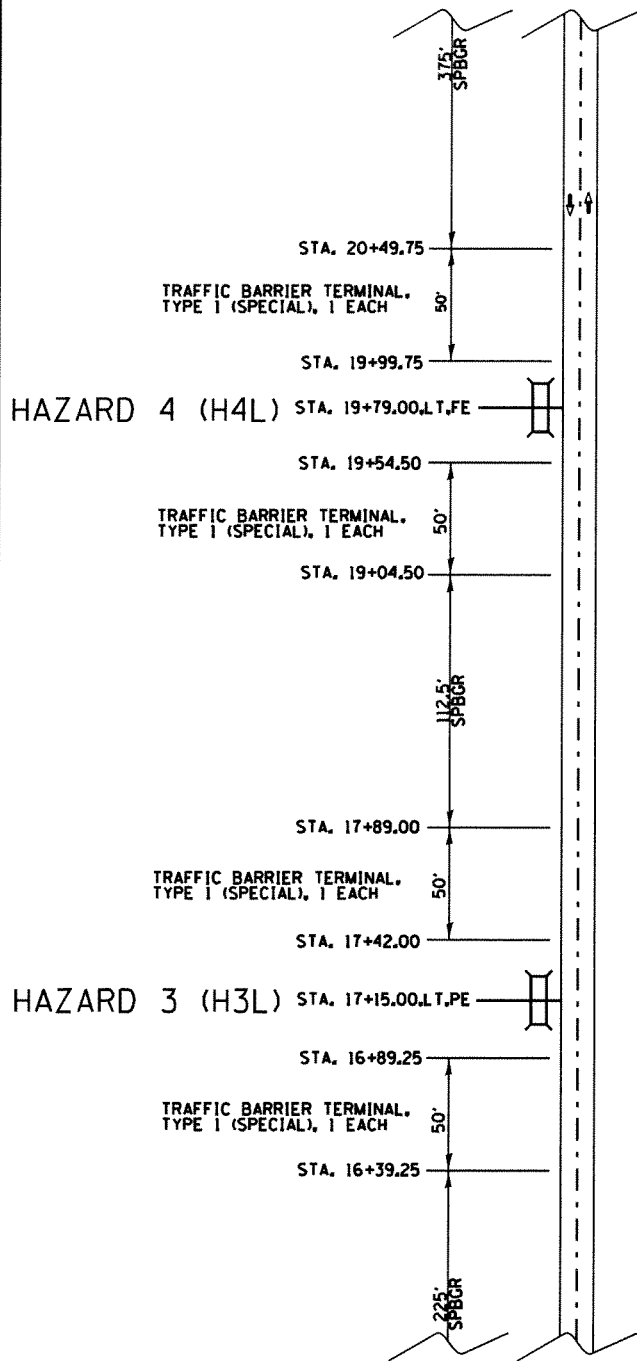
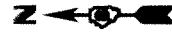

NOT TO SCALE

H3L & H4L GUARDRAIL  
LOCATION DETAIL

F.A.P. ROUTE 327 (US 50)  
SECTION (20,21)-J  
CLINTON COUNTY

PLOT DATE: 10/21/2013

\$\$\$\$DATE\$\$\$\$  
10/21/2013  
c:\p\...work\p\dot\weedmore\p\d0351\08\vd876g67-ah:pl.n.dgn

TOTAL SHEETS	SHEET NO.
25	22
CONTRACT NO. 76G67	

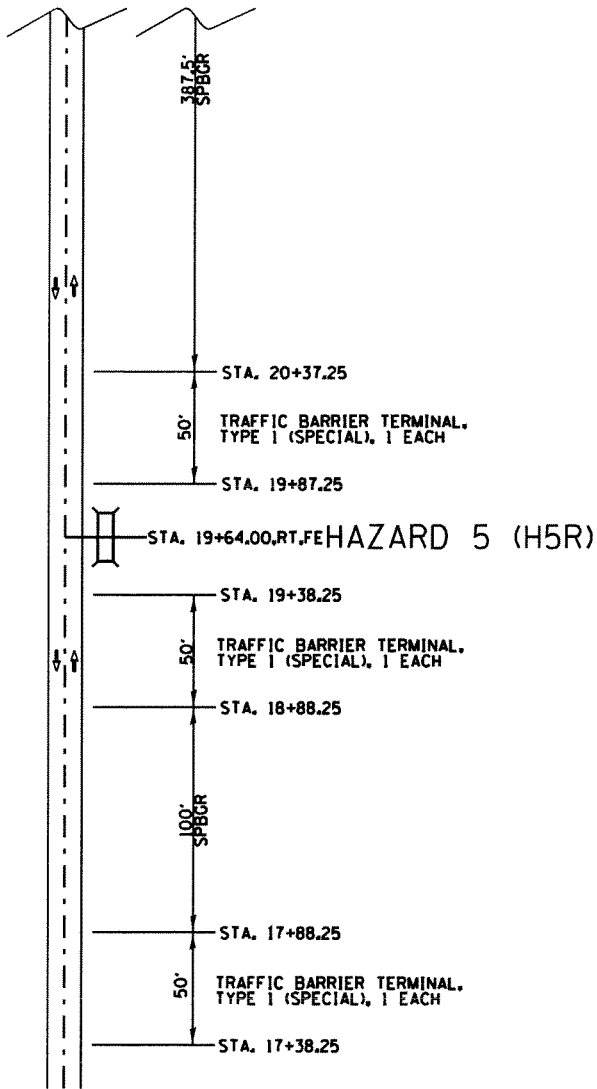

NOT TO SCALE

H5R GUARDRAIL  
LOCATION DETAIL

F.A.P. ROUTE 327 (US 50)  
SECTION (20,21)-J  
CLINTON COUNTY

PLOT DATE: 10/21/2013

\$\$\$\$DATE\$\$  
10/21/2013  
c:\p...work\p...dot\weedmore.jp\d0351106\d875g67-ah:pln.dgn

TOTAL SHEETS	SHEET NO.
25	23
CONTRACT NO. 76667	

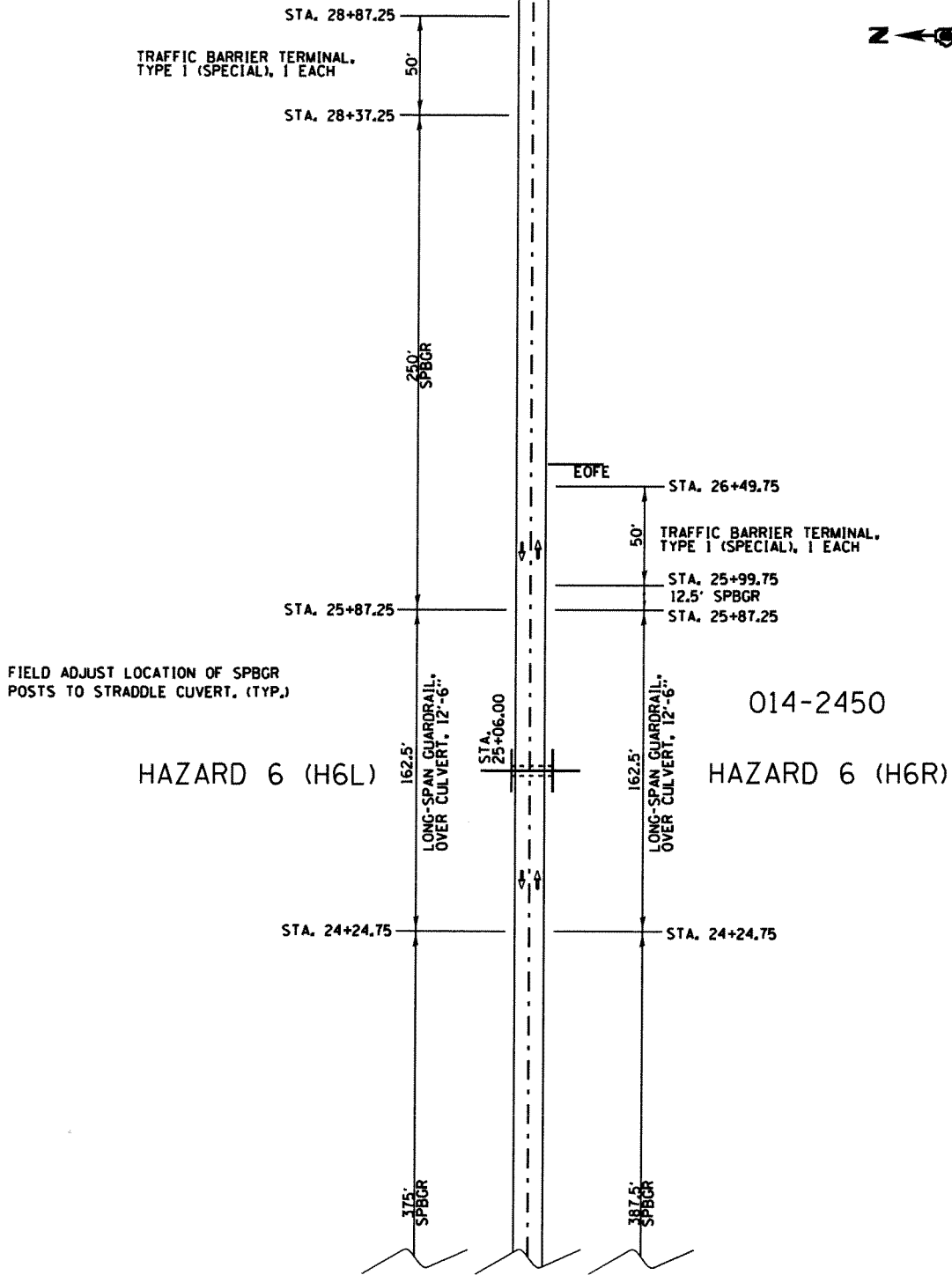

NOT TO SCALE

**H6 GUARDRAIL  
LOCATION DETAIL**

F.A.P. ROUTE 327 (US 50)  
SECTION (20,21)-J  
CLINTON COUNTY

PLLOT DATE: 10/21/2013

DATE: 10/21/2013  
C:\pwork\pwork\road\2013\108\876667-shr-pln.dgn



TOTAL SHEETS	SHEET NO.
25	24
CONTRACT NO. 76G67	

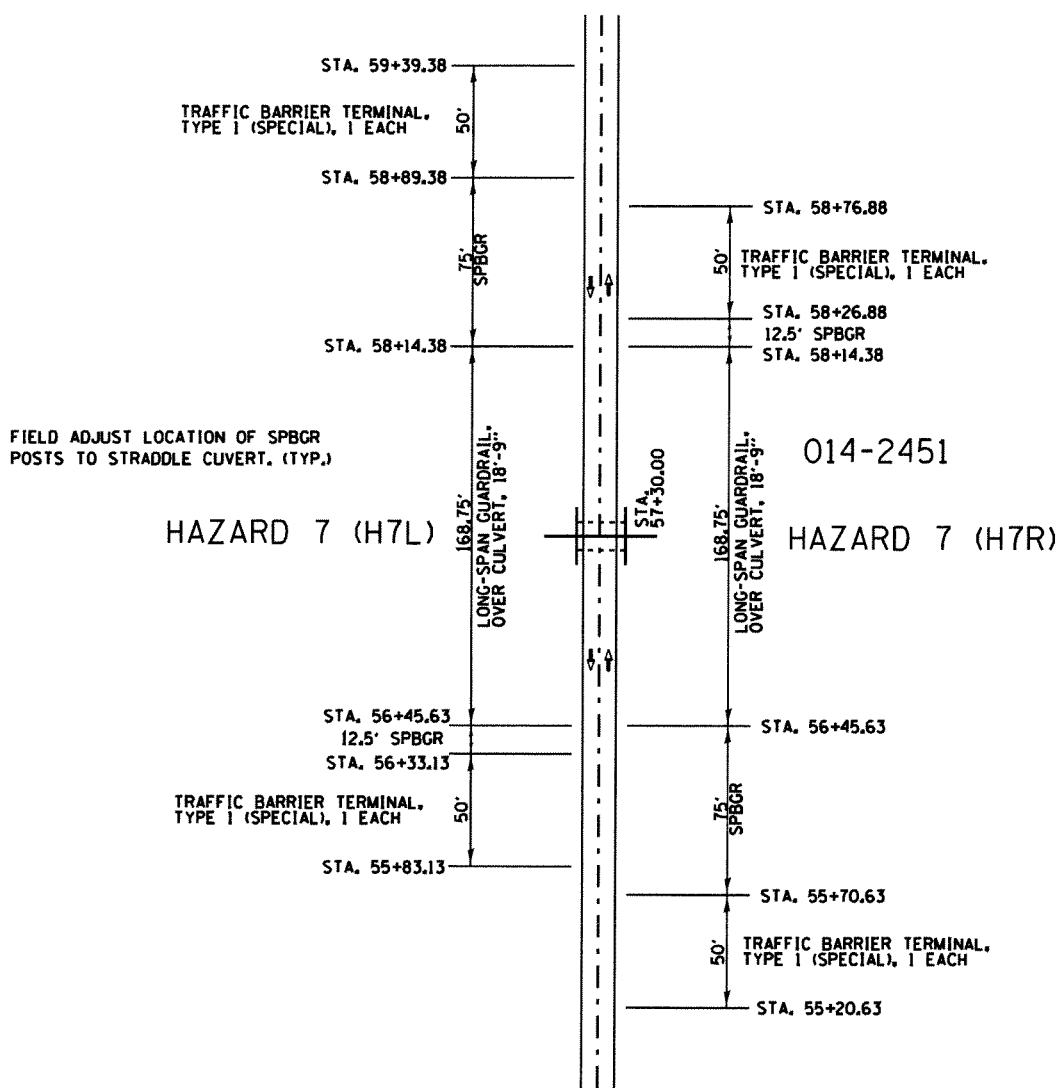

NOT TO SCALE

**H6 GUARDRAIL  
LOCATION DETAIL**

F.A.P. ROUTE 327 (US 50)  
SECTION (20,21)-J  
CLINTON COUNTY

PLOT DATE: 10/21/2013

\*\*DATE\*\*  
 10/21/2013  
 c:\pwworkspace\pwworkspace\10876867-shl-plot.dgn

TOTAL SHEETS	SHEET NO.
25	25
CONTRACT NO. 76G67	

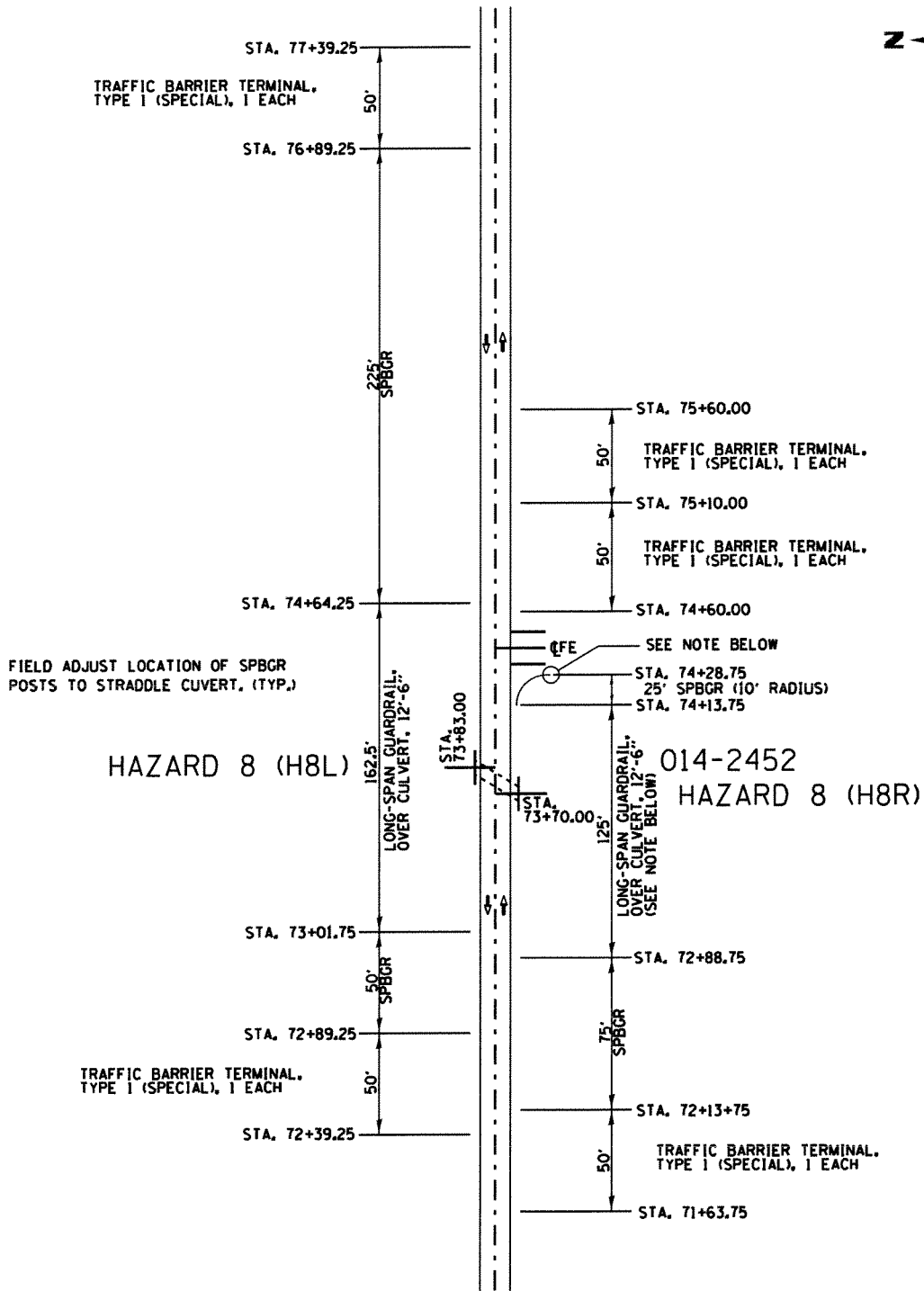
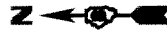

NOT TO SCALE

## H8 GUARDRAIL LOCATION DETAIL

F.A.P. ROUTE 327 (US 50)  
SECTION (20,21)-J  
CLINTON COUNTY

NOTE:  
THE LAST THREE (3) SECTIONS OF GUARDRAIL ON THE EAST END OF THE STANDARD LONG-SPAN SECTION ARE BEING REPLACED WITH TWO (2) SECTIONS OF RADIUS, TO BE PAID FOR AS STANDARD SPBGR. AN END SECTION IS TO BE PLACED ON THE LAST SECTION OF RADIUS PER STANDARD 630001. THE COST TO BE INCLUDED WITH THE LAST SECTION.

PLOT DATE: 10/21/2013

DATE: 10/21/2013  
C:\p\...serk\p\dot\veedmore\p\d0351108\d876g67-sht-plot.dgn

## REQUIRED CONTRACT PROVISIONS FEDERAL-AID CONSTRUCTION CONTRACTS

- I. General
- II. Nondiscrimination
- III. Nonsegregated Facilities
- IV. Davis-Bacon and Related Act Provisions
- V. Contract Work Hours and Safety Standards Act Provisions
- VI. Subletting or Assigning the Contract
- VII. Safety: Accident Prevention
- VIII. False Statements Concerning Highway Projects
- IX. Implementation of Clean Air Act and Federal Water Pollution Control Act
- X. Compliance with Governmentwide Suspension and Debarment Requirements
- XI. Certification Regarding Use of Contract Funds for Lobbying

### ATTACHMENTS

A. Employment and Materials Preference for Appalachian Development Highway System or Appalachian Local Access Road Contracts (included in Appalachian contracts only)

#### I. GENERAL

1. Form FHWA-1273 must be physically incorporated in each construction contract funded under Title 23 (excluding emergency contracts solely intended for debris removal). The contractor (or subcontractor) must insert this form in each subcontract and further require its inclusion in all lower tier subcontracts (excluding purchase orders, rental agreements and other agreements for supplies or services).

The applicable requirements of Form FHWA-1273 are incorporated by reference for work done under any purchase order, rental agreement or agreement for other services. The prime contractor shall be responsible for compliance by any subcontractor, lower-tier subcontractor or service provider.

Form FHWA-1273 must be included in all Federal-aid design-build contracts, in all subcontracts and in lower tier subcontracts (excluding subcontracts for design services, purchase orders, rental agreements and other agreements for supplies or services). The design-builder shall be responsible for compliance by any subcontractor, lower-tier subcontractor or service provider.

Contracting agencies may reference Form FHWA-1273 in bid proposal or request for proposal documents, however, the Form FHWA-1273 must be physically incorporated (not referenced) in all contracts, subcontracts and lower-tier subcontracts (excluding purchase orders, rental agreements and other agreements for supplies or services related to a construction contract).

2. Subject to the applicability criteria noted in the following sections, these contract provisions shall apply to all work performed on the contract by the contractor's own organization and with the assistance of workers under the contractor's immediate superintendence and to all work performed on the contract by piecework, station work, or by subcontract.

3. A breach of any of the stipulations contained in these Required Contract Provisions may be sufficient grounds for withholding of progress payments, withholding of final payment, termination of the contract, suspension / debarment or any other action determined to be appropriate by the contracting agency and FHWA.

4. Selection of Labor: During the performance of this contract, the contractor shall not use convict labor for any purpose within the limits of a construction project on a Federal-aid highway unless it is labor performed by convicts who are on parole, supervised release, or probation. The term Federal-aid highway does not include roadways functionally classified as local roads or rural minor collectors.

#### II. NONDISCRIMINATION

The provisions of this section related to 23 CFR Part 230 are applicable to all Federal-aid construction contracts and to all related construction subcontracts of \$10,000 or more. The provisions of 23 CFR Part 230 are not applicable to material supply, engineering, or architectural service contracts.

In addition, the contractor and all subcontractors must comply with the following policies: Executive Order 11246, 41 CFR 60, 29 CFR 1625-1627, Title 23 USC Section 140, the Rehabilitation Act of 1973, as amended (29 USC 794), Title VI of the Civil Rights Act of 1964, as amended, and related regulations including 49 CFR Parts 21, 26 and 27; and 23 CFR Parts 200, 230, and 633.

The contractor and all subcontractors must comply with: the requirements of the Equal Opportunity Clause in 41 CFR 60-1.4(b) and, for all construction contracts exceeding \$10,000, the Standard Federal Equal Employment Opportunity Construction Contract Specifications in 41 CFR 60-4.3.

Note: The U.S. Department of Labor has exclusive authority to determine compliance with Executive Order 11246 and the policies of the Secretary of Labor including 41 CFR 60, and 29 CFR 1625-1627. The contracting agency and the FHWA have the authority and the responsibility to ensure compliance with Title 23 USC Section 140, the Rehabilitation Act of 1973, as amended (29 USC 794), and Title VI of the Civil Rights Act of 1964, as amended, and related regulations including 49 CFR Parts 21, 26 and 27; and 23 CFR Parts 200, 230, and 633.

The following provision is adopted from 23 CFR 230, Appendix A, with appropriate revisions to conform to the U.S. Department of Labor (US DOL) and FHWA requirements.

**1. Equal Employment Opportunity:** Equal employment opportunity (EEO) requirements not to discriminate and to take affirmative action to assure equal opportunity as set forth under laws, executive orders, rules, regulations (28 CFR 35, 29 CFR 1630, 29 CFR 1625-1627, 41 CFR 60 and 49 CFR 27) and orders of the Secretary of Labor as modified by the provisions prescribed herein, and imposed pursuant to 23 U.S.C. 140 shall constitute the EEO and specific affirmative action standards for the contractor's project activities under this contract. The provisions of the Americans with Disabilities Act of 1990 (42 U.S.C. 12101 et seq.) set forth under 28 CFR 35 and 29 CFR 1630 are incorporated by reference in this contract. In the execution of this contract, the contractor agrees to comply with the following minimum specific requirement activities of EEO:

a. The contractor will work with the contracting agency and the Federal Government to ensure that it has made every good faith effort to provide equal opportunity with respect to all of its terms and conditions of employment and in their review of activities under the contract.

b. The contractor will accept as its operating policy the following statement:

"It is the policy of this Company to assure that applicants are employed, and that employees are treated during employment, without regard to their race, religion, sex, color, national origin, age or disability. Such action shall include: employment, upgrading, demotion, or transfer; recruitment or recruitment advertising; layoff or termination; rates of pay or other forms of compensation; and selection for training, including apprenticeship, pre-apprenticeship, and/or on-the-job training."

**2. EEO Officer:** The contractor will designate and make known to the contracting officers an EEO Officer who will have the responsibility for and must be capable of effectively administering and promoting an active EEO program and who must be assigned adequate authority and responsibility to do so.

**3. Dissemination of Policy:** All members of the contractor's staff who are authorized to hire, supervise, promote, and discharge employees, or who recommend such action, or who are substantially involved in such action, will be made fully cognizant of, and will implement, the contractor's EEO policy and contractual responsibilities to provide EEO in each grade and classification of employment. To ensure that the above agreement will be met, the following actions will be taken as a minimum:

a. Periodic meetings of supervisory and personnel office employees will be conducted before the start of work and then not less often than once every six months, at which time the contractor's EEO policy and its implementation will be reviewed and explained. The meetings will be conducted by the EEO Officer.

b. All new supervisory or personnel office employees will be given a thorough indoctrination by the EEO Officer, covering all major aspects of the contractor's EEO obligations within thirty days following their reporting for duty with the contractor.

c. All personnel who are engaged in direct recruitment for the project will be instructed by the EEO Officer in the contractor's procedures for locating and hiring minorities and women.

d. Notices and posters setting forth the contractor's EEO policy will be placed in areas readily accessible to employees, applicants for employment and potential employees.

e. The contractor's EEO policy and the procedures to implement such policy will be brought to the attention of employees by means of meetings, employee handbooks, or other appropriate means.

**4. Recruitment:** When advertising for employees, the contractor will include in all advertisements for employees the notation: "An Equal Opportunity Employer." All such advertisements will be placed in publications having a large circulation among minorities and women in the area from which the project work force would normally be derived.

a. The contractor will, unless precluded by a valid bargaining agreement, conduct systematic and direct recruitment through public and private employee referral sources likely to yield qualified minorities and women. To meet this requirement, the contractor will identify sources of potential minority group employees, and establish with such identified sources procedures whereby minority and women applicants may be referred to the contractor for employment consideration.

b. In the event the contractor has a valid bargaining agreement providing for exclusive hiring hall referrals, the contractor is expected to observe the provisions of that agreement to the extent that the system meets the contractor's compliance with EEO contract provisions. Where implementation of such an agreement has the effect of discriminating against minorities or women, or obligates the contractor to do the same, such implementation violates Federal nondiscrimination provisions.

c. The contractor will encourage its present employees to refer minorities and women as applicants for employment. Information and procedures with regard to referring such applicants will be discussed with employees.

**5. Personnel Actions:** Wages, working conditions, and employee benefits shall be established and administered, and personnel actions of every type, including hiring, upgrading, promotion, transfer, demotion, layoff, and termination, shall be taken without regard to race, color, religion, sex, national origin, age or disability. The following procedures shall be followed:

a. The contractor will conduct periodic inspections of project sites to insure that working conditions and employee facilities do not indicate discriminatory treatment of project site personnel.

b. The contractor will periodically evaluate the spread of wages paid within each classification to determine any evidence of discriminatory wage practices.

c. The contractor will periodically review selected personnel actions in depth to determine whether there is evidence of discrimination. Where evidence is found, the contractor will promptly take corrective action. If

the review indicates that the discrimination may extend beyond the actions reviewed, such corrective action shall include all affected persons.

d. The contractor will promptly investigate all complaints of alleged discrimination made to the contractor in connection with its obligations under this contract, will attempt to resolve such complaints, and will take appropriate corrective action within a reasonable time. If the investigation indicates that the discrimination may affect persons other than the complainant, such corrective action shall include such other persons. Upon completion of each investigation, the contractor will inform every complainant of all of their avenues of appeal.

#### **6. Training and Promotion:**

a. The contractor will assist in locating, qualifying, and increasing the skills of minorities and women who are applicants for employment or current employees. Such efforts should be aimed at developing full journey level status employees in the type of trade or job classification involved.

b. Consistent with the contractor's work force requirements and as permissible under Federal and State regulations, the contractor shall make full use of training programs, i.e., apprenticeship, and on-the-job training programs for the geographical area of contract performance. In the event a special provision for training is provided under this contract, this subparagraph will be superseded as indicated in the special provision. The contracting agency may reserve training positions for persons who receive welfare assistance in accordance with 23 U.S.C. 140(a).

c. The contractor will advise employees and applicants for employment of available training programs and entrance requirements for each.

d. The contractor will periodically review the training and promotion potential of employees who are minorities and women and will encourage eligible employees to apply for such training and promotion.

**7. Unions:** If the contractor relies in whole or in part upon unions as a source of employees, the contractor will use good faith efforts to obtain the cooperation of such unions to increase opportunities for minorities and women. Actions by the contractor, either directly or through a contractor's association acting as agent, will include the procedures set forth below:

a. The contractor will use good faith efforts to develop, in cooperation with the unions, joint training programs aimed toward qualifying more minorities and women for membership in the unions and increasing the skills of minorities and women so that they may qualify for higher paying employment.

b. The contractor will use good faith efforts to incorporate an EEO clause into each union agreement to the end that such union will be contractually bound to refer applicants without regard to their race, color, religion, sex, national origin, age or disability.

c. The contractor is to obtain information as to the referral practices and policies of the labor union except that to the extent such information is within the exclusive possession of the labor union and such labor union refuses to furnish such information to the contractor, the contractor shall so certify to the contracting agency and shall set forth what efforts have been made to obtain such information.

d. In the event the union is unable to provide the contractor with a reasonable flow of referrals within the time limit set forth in the collective bargaining agreement, the contractor will, through independent recruitment efforts, fill the employment vacancies without regard to race, color, religion, sex, national origin, age or disability; making full efforts to obtain qualified and/or qualifiable minorities and women. The failure of a union to provide sufficient referrals (even though it is obligated to provide exclusive referrals under the terms of a collective bargaining agreement) does not relieve the contractor from the requirements of this paragraph. In the event the union referral practice prevents the contractor from meeting the obligations pursuant to Executive Order 11246, as amended, and these special provisions, such contractor shall immediately notify the contracting agency.

**8. Reasonable Accommodation for Applicants / Employees with Disabilities:** The contractor must be familiar with the requirements for and comply with the Americans with Disabilities Act and all rules and regulations established there under. Employers must provide reasonable accommodation in all employment activities unless to do so would cause an undue hardship.

**9. Selection of Subcontractors, Procurement of Materials and Leasing of Equipment:** The contractor shall not discriminate on the grounds of race, color, religion, sex, national origin, age or disability in the selection and retention of subcontractors, including procurement of materials and leases of equipment. The contractor shall take all necessary and reasonable steps to ensure nondiscrimination in the administration of this contract.

a. The contractor shall notify all potential subcontractors and suppliers and lessors of their EEO obligations under this contract.

b. The contractor will use good faith efforts to ensure subcontractor compliance with their EEO obligations.

#### **10. Assurance Required by 49 CFR 26.13(b):**

a. The requirements of 49 CFR Part 26 and the State DOT's U.S. DOT-approved DBE program are incorporated by reference.

b. The contractor or subcontractor shall not discriminate on the basis of race, color, national origin, or sex in the performance of this contract. The contractor shall carry out applicable requirements of 49 CFR Part 26 in the award and administration of DOT-assisted contracts. Failure by the contractor to carry out these requirements is a material breach of this contract, which may result in the termination of this contract or such other remedy as the contracting agency deems appropriate.

**11. Records and Reports:** The contractor shall keep such records as necessary to document compliance with the EEO requirements. Such records shall be retained for a period of three years following the date of the final payment to the contractor for all contract work and shall be available at reasonable times and places for inspection by authorized representatives of the contracting agency and the FHWA.

a. The records kept by the contractor shall document the following:

(1) The number and work hours of minority and non-minority group members and women employed in each work classification on the project;

(2) The progress and efforts being made in cooperation with unions, when applicable, to increase employment opportunities for minorities and women; and

(3) The progress and efforts being made in locating, hiring, training, qualifying, and upgrading minorities and women;

b. The contractors and subcontractors will submit an annual report to the contracting agency each July for the duration of the project, indicating the number of minority, women, and non-minority group employees currently engaged in each work classification required by the contract work. This information is to be reported on [Form FHWA-1391](#). The staffing data should represent the project work force on board in all or any part of the last payroll period preceding the end of July. If on-the-job training is being required by special provision, the contractor will be required to collect and report training data. The employment data should reflect the work force on board during all or any part of the last payroll period preceding the end of July.

#### **III. NONSEGREGATED FACILITIES**

This provision is applicable to all Federal-aid construction contracts and to all related construction subcontracts of \$10,000 or more.

The contractor must ensure that facilities provided for employees are provided in such a manner that segregation on the basis of race, color,

religion, sex, or national origin cannot result. The contractor may neither require such segregated use by written or oral policies nor tolerate such use by employee custom. The contractor's obligation extends further to ensure that its employees are not assigned to perform their services at any location, under the contractor's control, where the facilities are segregated. The term "facilities" includes waiting rooms, work areas, restaurants and other eating areas, time clocks, restrooms, washrooms, locker rooms, and other storage or dressing areas, parking lots, drinking fountains, recreation or entertainment areas, transportation, and housing provided for employees. The contractor shall provide separate or single-user restrooms and necessary dressing or sleeping areas to assure privacy between sexes.

#### **IV. Davis-Bacon and Related Act Provisions**

This section is applicable to all Federal-aid construction projects exceeding \$2,000 and to all related subcontracts and lower-tier subcontracts (regardless of subcontract size). The requirements apply to all projects located within the right-of-way of a roadway that is functionally classified as Federal-aid highway. This excludes roadways functionally classified as local roads or rural minor collectors, which are exempt. Contracting agencies may elect to apply these requirements to other projects.

The following provisions are from the U.S. Department of Labor regulations in 29 CFR 5.5 "Contract provisions and related matters" with minor revisions to conform to the FHWA-1273 format and FHWA program requirements.

##### **1. Minimum wages**

a. All laborers and mechanics employed or working upon the site of the work, will be paid unconditionally and not less often than once a week, and without subsequent deduction or rebate on any account (except such payroll deductions as are permitted by regulations issued by the Secretary of Labor under the Copeland Act (29 CFR part 3)), the full amount of wages and bona fide fringe benefits (or cash equivalents thereof) due at time of payment computed at rates not less than those contained in the wage determination of the Secretary of Labor which is attached hereto and made a part hereof, regardless of any contractual relationship which may be alleged to exist between the contractor and such laborers and mechanics.

Contributions made or costs reasonably anticipated for bona fide fringe benefits under section 1(b)(2) of the Davis-Bacon Act on behalf of laborers or mechanics are considered wages paid to such laborers or mechanics, subject to the provisions of paragraph 1.d. of this section; also, regular contributions made or costs incurred for more than a weekly period (but not less often than quarterly) under plans, funds, or programs which cover the particular weekly period, are deemed to be constructively made or incurred during such weekly period. Such laborers and mechanics shall be paid the appropriate wage rate and fringe benefits on the wage determination for the classification of work actually performed, without regard to skill, except as provided in 29 CFR 5.5(a)(4). Laborers or mechanics performing work in more than one classification may be compensated at the rate specified for each classification for the time actually worked therein: Provided, That the employer's payroll records accurately set forth the time spent in each classification in which work is performed. The wage determination (including any additional classification and wage rates conformed under paragraph 1.b. of this section) and the Davis-Bacon poster (WH-1321) shall be posted at all times by the contractor and its subcontractors at the site of the work in a prominent and accessible place where it can be easily seen by the workers.

b.(1) The contracting officer shall require that any class of laborers or mechanics, including helpers, which is not listed in the wage determination and which is to be employed under the contract shall be classified in conformance with the wage determination. The contracting officer shall approve an additional classification and wage rate and fringe benefits therefore only when the following criteria have been met:

(i) The work to be performed by the classification requested is not performed by a classification in the wage determination; and

(ii) The classification is utilized in the area by the construction industry; and

(iii) The proposed wage rate, including any bona fide fringe benefits, bears a reasonable relationship to the wage rates contained in the wage determination.

(2) If the contractor and the laborers and mechanics to be employed in the classification (if known), or their representatives, and the contracting officer agree on the classification and wage rate (including the amount designated for fringe benefits where appropriate), a report of the action taken shall be sent by the contracting officer to the Administrator of the Wage and Hour Division, Employment Standards Administration, U.S. Department of Labor, Washington, DC 20210. The Administrator, or an authorized representative, will approve, modify, or disapprove every additional classification action within 30 days of receipt and so advise the contracting officer or will notify the contracting officer within the 30-day period that additional time is necessary.

(3) In the event the contractor, the laborers or mechanics to be employed in the classification or their representatives, and the contracting officer do not agree on the proposed classification and wage rate (including the amount designated for fringe benefits, where appropriate), the contracting officer shall refer the questions, including the views of all interested parties and the recommendation of the contracting officer, to the Wage and Hour Administrator for determination. The Wage and Hour Administrator, or an authorized representative, will issue a determination within 30 days of receipt and so advise the contracting officer or will notify the contracting officer within the 30-day period that additional time is necessary.

(4) The wage rate (including fringe benefits where appropriate) determined pursuant to paragraphs 1.b.(2) or 1.b.(3) of this section, shall be paid to all workers performing work in the classification under this contract from the first day on which work is performed in the classification.

c. Whenever the minimum wage rate prescribed in the contract for a class of laborers or mechanics includes a fringe benefit which is not expressed as an hourly rate, the contractor shall either pay the benefit as stated in the wage determination or shall pay another bona fide fringe benefit or an hourly cash equivalent thereof.

d. If the contractor does not make payments to a trustee or other third person, the contractor may consider as part of the wages of any laborer or mechanic the amount of any costs reasonably anticipated in providing bona fide fringe benefits under a plan or program. Provided, That the Secretary of Labor has found, upon the written request of the contractor, that the applicable standards of the Davis-Bacon Act have been met. The Secretary of Labor may require the contractor to set aside in a separate account assets for the meeting of obligations under the plan or program.

## 2. Withholding

The contracting agency shall upon its own action or upon written request of an authorized representative of the Department of Labor, withhold or cause to be withheld from the contractor under this contract, or any other Federal contract with the same prime contractor, or any other federally-assisted contract subject to Davis-Bacon prevailing wage requirements, which is held by the same prime contractor, so much of the accrued payments or advances as may be considered necessary to pay laborers and mechanics, including apprentices, trainees, and helpers, employed by the contractor or any subcontractor the full amount of wages required by the contract. In the event of failure to pay any laborer or mechanic, including any apprentice, trainee, or helper, employed or working on the site of the work, all or part of the wages required by the contract, the contracting agency may, after written notice to the contractor, take such

action as may be necessary to cause the suspension of any further payment, advance, or guarantee of funds until such violations have ceased.

## 3. Payrolls and basic records

a. Payrolls and basic records relating thereto shall be maintained by the contractor during the course of the work and preserved for a period of three years thereafter for all laborers and mechanics working at the site of the work. Such records shall contain the name, address, and social security number of each such worker, his or her correct classification, hourly rates of wages paid (including rates of contributions or costs anticipated for bona fide fringe benefits or cash equivalents thereof of the types described in section 1(b)(2)(B) of the Davis-Bacon Act), daily and weekly number of hours worked, deductions made and actual wages paid. Whenever the Secretary of Labor has found under 29 CFR 5.5(a)(1)(iv) that the wages of any laborer or mechanic include the amount of any costs reasonably anticipated in providing benefits under a plan or program described in section 1(b)(2)(B) of the Davis-Bacon Act, the contractor shall maintain records which show that the commitment to provide such benefits is enforceable, that the plan or program is financially responsible, and that the plan or program has been communicated in writing to the laborers or mechanics affected, and records which show the costs anticipated or the actual cost incurred in providing such benefits. Contractors employing apprentices or trainees under approved programs shall maintain written evidence of the registration of apprenticeship programs and certification of trainee programs, the registration of the apprentices and trainees, and the ratios and wage rates prescribed in the applicable programs.

b. (1) The contractor shall submit weekly for each week in which any contract work is performed a copy of all payrolls to the contracting agency. The payrolls submitted shall set out accurately and completely all of the information required to be maintained under 29 CFR 5.5(a)(3)(i), except that full social security numbers and home addresses shall not be included on weekly transmittals. Instead the payrolls shall only need to include an individually identifying number for each employee (e.g., the last four digits of the employee's social security number). The required weekly payroll information may be submitted in any form desired. Optional Form WH-347 is available for this purpose from the Wage and Hour Division Web site at <http://www.dol.gov/esa/whd/forms/wh347instr.htm> or its successor site. The prime contractor is responsible for the submission of copies of payrolls by all subcontractors. Contractors and subcontractors shall maintain the full social security number and current address of each covered worker, and shall provide them upon request to the contracting agency for transmission to the State DOT, the FHWA or the Wage and Hour Division of the Department of Labor for purposes of an investigation or audit of compliance with prevailing wage requirements. It is not a violation of this section for a prime contractor to require a subcontractor to provide addresses and social security numbers to the prime contractor for its own records, without weekly submission to the contracting agency..

(2) Each payroll submitted shall be accompanied by a "Statement of Compliance," signed by the contractor or subcontractor or his or her agent who pays or supervises the payment of the persons employed under the contract and shall certify the following:

(i) That the payroll for the payroll period contains the information required to be provided under §5.5 (a)(3)(ii) of Regulations, 29 CFR part 5, the appropriate information is being maintained under §5.5 (a)(3)(i) of Regulations, 29 CFR part 5, and that such information is correct and complete;

(ii) That each laborer or mechanic (including each helper, apprentice, and trainee) employed on the contract during the payroll period has been paid the full weekly wages earned, without rebate, either directly or indirectly, and that no deductions have been made either directly or indirectly from the full wages earned, other than permissible deductions as set forth in Regulations, 29 CFR part 3;

(iii) That each laborer or mechanic has been paid not less than the applicable wage rates and fringe benefits or cash equivalents for the classification of work performed, as specified in the applicable wage determination incorporated into the contract.

(3) The weekly submission of a properly executed certification set forth on the reverse side of Optional Form WH-347 shall satisfy the requirement for submission of the "Statement of Compliance" required by paragraph 3.b.(2) of this section.

(4) The falsification of any of the above certifications may subject the contractor or subcontractor to civil or criminal prosecution under section 1001 of title 18 and section 231 of title 31 of the United States Code.

c. The contractor or subcontractor shall make the records required under paragraph 3.a. of this section available for inspection, copying, or transcription by authorized representatives of the contracting agency, the State DOT, the FHWA, or the Department of Labor, and shall permit such representatives to interview employees during working hours on the job. If the contractor or subcontractor fails to submit the required records or to make them available, the FHWA may, after written notice to the contractor, the contracting agency or the State DOT, take such action as may be necessary to cause the suspension of any further payment, advance, or guarantee of funds. Furthermore, failure to submit the required records upon request or to make such records available may be grounds for debarment action pursuant to 29 CFR 5.12.

#### 4. Apprentices and trainees

##### a. Apprentices (programs of the USDOL).

Apprentices will be permitted to work at less than the predetermined rate for the work they performed when they are employed pursuant to and individually registered in a bona fide apprenticeship program registered with the U.S. Department of Labor, Employment and Training Administration, Office of Apprenticeship Training, Employer and Labor Services, or with a State Apprenticeship Agency recognized by the Office, or if a person is employed in his or her first 90 days of probationary employment as an apprentice in such an apprenticeship program, who is not individually registered in the program, but who has been certified by the Office of Apprenticeship Training, Employer and Labor Services or a State Apprenticeship Agency (where appropriate) to be eligible for probationary employment as an apprentice.

The allowable ratio of apprentices to journeymen on the job site in any craft classification shall not be greater than the ratio permitted to the contractor as to the entire work force under the registered program. Any worker listed on a payroll at an apprentice wage rate, who is not registered or otherwise employed as stated above, shall be paid not less than the applicable wage rate on the wage determination for the classification of work actually performed. In addition, any apprentice performing work on the job site in excess of the ratio permitted under the registered program shall be paid not less than the applicable wage rate on the wage determination for the work actually performed. Where a contractor is performing construction on a project in a locality other than that in which its program is registered, the ratios and wage rates (expressed in percentages of the journeyman's hourly rate) specified in the contractor's or subcontractor's registered program shall be observed.

Every apprentice must be paid at not less than the rate specified in the registered program for the apprentice's level of progress, expressed as a percentage of the journeymen hourly rate specified in the applicable wage determination. Apprentices shall be paid fringe benefits in accordance with the provisions of the apprenticeship program. If the apprenticeship program does not specify fringe benefits, apprentices must be paid the full amount of fringe benefits listed on the wage determination for the applicable classification. If the Administrator determines that a different practice prevails for the applicable apprentice classification, fringes shall be paid in accordance with that determination.

In the event the Office of Apprenticeship Training, Employer and Labor Services, or a State Apprenticeship Agency recognized by the Office, withdraws approval of an apprenticeship program, the contractor will no longer be permitted to utilize apprentices at less than the applicable predetermined rate for the work performed until an acceptable program is approved.

##### b. Trainees (programs of the USDOL).

Except as provided in 29 CFR 5.16, trainees will not be permitted to work at less than the predetermined rate for the work performed unless they are employed pursuant to and individually registered in a program which has received prior approval, evidenced by formal certification by the U.S. Department of Labor, Employment and Training Administration.

The ratio of trainees to journeymen on the job site shall not be greater than permitted under the plan approved by the Employment and Training Administration.

Every trainee must be paid at not less than the rate specified in the approved program for the trainee's level of progress, expressed as a percentage of the journeyman hourly rate specified in the applicable wage determination. Trainees shall be paid fringe benefits in accordance with the provisions of the trainee program. If the trainee program does not mention fringe benefits, trainees shall be paid the full amount of fringe benefits listed on the wage determination unless the Administrator of the Wage and Hour Division determines that there is an apprenticeship program associated with the corresponding journeyman wage rate on the wage determination which provides for less than full fringe benefits for apprentices. Any employee listed on the payroll at a trainee rate who is not registered and participating in a training plan approved by the Employment and Training Administration shall be paid not less than the applicable wage rate on the wage determination for the classification of work actually performed. In addition, any trainee performing work on the job site in excess of the ratio permitted under the registered program shall be paid not less than the applicable wage rate on the wage determination for the work actually performed.

In the event the Employment and Training Administration withdraws approval of a training program, the contractor will no longer be permitted to utilize trainees at less than the applicable predetermined rate for the work performed until an acceptable program is approved.

c. Equal employment opportunity. The utilization of apprentices, trainees and journeymen under this part shall be in conformity with the equal employment opportunity requirements of Executive Order 11246, as amended, and 29 CFR part 30.

##### d. Apprentices and Trainees (programs of the U.S. DOT).

Apprentices and trainees working under apprenticeship and skill training programs which have been certified by the Secretary of Transportation as promoting EEO in connection with Federal-aid highway construction programs are not subject to the requirements of paragraph 4 of this Section IV. The straight time hourly wage rates for apprentices and trainees under such programs will be established by the particular programs. The ratio of apprentices and trainees to journeymen shall not be greater than permitted by the terms of the particular program.

**5. Compliance with Copeland Act requirements.** The contractor shall comply with the requirements of 29 CFR part 3, which are incorporated by reference in this contract.

**6. Subcontracts.** The contractor or subcontractor shall insert Form FHWA-1273 in any subcontracts and also require the subcontractors to include Form FHWA-1273 in any lower tier subcontracts. The prime contractor shall be responsible for the compliance by any subcontractor or lower tier subcontractor with all the contract clauses in 29 CFR 5.5.

**7. Contract termination: debarment.** A breach of the contract clauses in 29 CFR 5.5 may be grounds for termination of the contract, and for

debarment as a contractor and a subcontractor as provided in 29 CFR 5.12.

**8. Compliance with Davis-Bacon and Related Act requirements.** All rulings and interpretations of the Davis-Bacon and Related Acts contained in 29 CFR parts 1, 3, and 5 are herein incorporated by reference in this contract.

**9. Disputes concerning labor standards.** Disputes arising out of the labor standards provisions of this contract shall not be subject to the general disputes clause of this contract. Such disputes shall be resolved in accordance with the procedures of the Department of Labor set forth in 29 CFR parts 5, 6, and 7. Disputes within the meaning of this clause include disputes between the contractor (or any of its subcontractors) and the contracting agency, the U.S. Department of Labor, or the employees or their representatives.

#### **10. Certification of eligibility.**

a. By entering into this contract, the contractor certifies that neither it (nor he or she) nor any person or firm who has an interest in the contractor's firm is a person or firm ineligible to be awarded Government contracts by virtue of section 3(a) of the Davis-Bacon Act or 29 CFR 5.12(a)(1).

b. No part of this contract shall be subcontracted to any person or firm ineligible for award of a Government contract by virtue of section 3(a) of the Davis-Bacon Act or 29 CFR 5.12(a)(1).

c. The penalty for making false statements is prescribed in the U.S. Criminal Code, 18 U.S.C. 1001.

#### **V. CONTRACT WORK HOURS AND SAFETY STANDARDS ACT**

The following clauses apply to any Federal-aid construction contract in an amount in excess of \$100,000 and subject to the overtime provisions of the Contract Work Hours and Safety Standards Act. These clauses shall be inserted in addition to the clauses required by 29 CFR 5.5(a) or 29 CFR 4.6. As used in this paragraph, the terms laborers and mechanics include watchmen and guards.

**1. Overtime requirements.** No contractor or subcontractor contracting for any part of the contract work which may require or involve the employment of laborers or mechanics shall require or permit any such laborer or mechanic in any workweek in which he or she is employed on such work to work in excess of forty hours in such workweek unless such laborer or mechanic receives compensation at a rate not less than one and one-half times the basic rate of pay for all hours worked in excess of forty hours in such workweek.

**2. Violation; liability for unpaid wages; liquidated damages.** In the event of any violation of the clause set forth in paragraph (1.) of this section, the contractor and any subcontractor responsible therefor shall be liable for the unpaid wages. In addition, such contractor and subcontractor shall be liable to the United States (in the case of work done under contract for the District of Columbia or a territory, to such District or to such territory), for liquidated damages. Such liquidated damages shall be computed with respect to each individual laborer or mechanic, including watchmen and guards, employed in violation of the clause set forth in paragraph (1.) of this section, in the sum of \$10 for each calendar day on which such individual was required or permitted to work in excess of the standard workweek of forty hours without payment of the overtime wages required by the clause set forth in paragraph (1.) of this section.

**3. Withholding for unpaid wages and liquidated damages.** The FHWA or the contacting agency shall upon its own action or upon written request of an authorized representative of the Department of Labor withhold or cause to be withheld, from any moneys payable on account of work performed by the contractor or subcontractor under any such

contract or any other Federal contract with the same prime contractor, or any other federally-assisted contract subject to the Contract Work Hours and Safety Standards Act, which is held by the same prime contractor, such sums as may be determined to be necessary to satisfy any liabilities of such contractor or subcontractor for unpaid wages and liquidated damages as provided in the clause set forth in paragraph (2.) of this section.

**4. Subcontracts.** The contractor or subcontractor shall insert in any subcontracts the clauses set forth in paragraph (1.) through (4.) of this section and also a clause requiring the subcontractors to include these clauses in any lower tier subcontracts. The prime contractor shall be responsible for compliance by any subcontractor or lower tier subcontractor with the clauses set forth in paragraphs (1.) through (4.) of this section.

#### **VI. SUBLETTING OR ASSIGNING THE CONTRACT**

This provision is applicable to all Federal-aid construction contracts on the National Highway System.

1. The contractor shall perform with its own organization contract work amounting to not less than 30 percent (or a greater percentage if specified elsewhere in the contract) of the total original contract price, excluding any specialty items designated by the contracting agency. Specialty items may be performed by subcontract and the amount of any such specialty items performed may be deducted from the total original contract price before computing the amount of work required to be performed by the contractor's own organization (23 CFR 635.116).

a. The term "perform work with its own organization" refers to workers employed or leased by the prime contractor, and equipment owned or rented by the prime contractor, with or without operators. Such term does not include employees or equipment of a subcontractor or lower tier subcontractor, agents of the prime contractor, or any other assignees. The term may include payments for the costs of hiring leased employees from an employee leasing firm meeting all relevant Federal and State regulatory requirements. Leased employees may only be included in this term if the prime contractor meets all of the following conditions:

(1) the prime contractor maintains control over the supervision of the day-to-day activities of the leased employees;

(2) the prime contractor remains responsible for the quality of the work of the leased employees;

(3) the prime contractor retains all power to accept or exclude individual employees from work on the project; and

(4) the prime contractor remains ultimately responsible for the payment of predetermined minimum wages, the submission of payrolls, statements of compliance and all other Federal regulatory requirements.

b. "Specialty Items" shall be construed to be limited to work that requires highly specialized knowledge, abilities, or equipment not ordinarily available in the type of contracting organizations qualified and expected to bid or propose on the contract as a whole and in general are to be limited to minor components of the overall contract.

2. The contract amount upon which the requirements set forth in paragraph (1) of Section VI is computed includes the cost of material and manufactured products which are to be purchased or produced by the contractor under the contract provisions.

3. The contractor shall furnish (a) a competent superintendent or supervisor who is employed by the firm, has full authority to direct performance of the work in accordance with the contract requirements, and is in charge of all construction operations (regardless of who performs the work) and (b) such other of its own organizational resources (supervision, management, and engineering services) as the contracting officer determines is necessary to assure the performance of the contract.



4. No portion of the contract shall be sublet, assigned or otherwise disposed of except with the written consent of the contracting officer, or authorized representative, and such consent when given shall not be construed to relieve the contractor of any responsibility for the fulfillment of the contract. Written consent will be given only after the contracting agency has assured that each subcontract is evidenced in writing and that it contains all pertinent provisions and requirements of the prime contract.

5. The 30% self-performance requirement of paragraph (1) is not applicable to design-build contracts; however, contracting agencies may establish their own self-performance requirements.

## **VII. SAFETY: ACCIDENT PREVENTION**

This provision is applicable to all Federal-aid construction contracts and to all related subcontracts.

1. In the performance of this contract the contractor shall comply with all applicable Federal, State, and local laws governing safety, health, and sanitation (23 CFR 635). The contractor shall provide all safeguards, safety devices and protective equipment and take any other needed actions as it determines, or as the contracting officer may determine, to be reasonably necessary to protect the life and health of employees on the job and the safety of the public and to protect property in connection with the performance of the work covered by the contract.

2. It is a condition of this contract, and shall be made a condition of each subcontract, which the contractor enters into pursuant to this contract, that the contractor and any subcontractor shall not permit any employee, in performance of the contract, to work in surroundings or under conditions which are unsanitary, hazardous or dangerous to his/her health or safety, as determined under construction safety and health standards (29 CFR 1926) promulgated by the Secretary of Labor, in accordance with Section 107 of the Contract Work Hours and Safety Standards Act (40 U.S.C. 3704).

3. Pursuant to 29 CFR 1926.3, it is a condition of this contract that the Secretary of Labor or authorized representative thereof, shall have right of entry to any site of contract performance to inspect or investigate the matter of compliance with the construction safety and health standards and to carry out the duties of the Secretary under Section 107 of the Contract Work Hours and Safety Standards Act (40 U.S.C.3704).

## **VIII. FALSE STATEMENTS CONCERNING HIGHWAY PROJECTS**

This provision is applicable to all Federal-aid construction contracts and to all related subcontracts.

In order to assure high quality and durable construction in conformity with approved plans and specifications and a high degree of reliability on statements and representations made by engineers, contractors, suppliers, and workers on Federal-aid highway projects, it is essential that all persons concerned with the project perform their functions as carefully, thoroughly, and honestly as possible. Willful falsification, distortion, or misrepresentation with respect to any facts related to the project is a violation of Federal law. To prevent any misunderstanding regarding the seriousness of these and similar acts, Form FHWA-1022 shall be posted on each Federal-aid highway project (23 CFR 635) in one or more places where it is readily available to all persons concerned with the project:

18 U.S.C. 1020 reads as follows:

"Whoever, being an officer, agent, or employee of the United States, or of any State or Territory, or whoever, whether a person, association, firm, or corporation, knowingly makes any false statement, false representation, or false report as to the character, quality, quantity, or cost of the material used or to be used, or the quantity or quality of the work performed or to be performed, or the cost thereof in connection with the submission of plans, maps, specifications, contracts, or costs of construction on any highway or related project submitted for approval to the Secretary of Transportation; or

Whoever knowingly makes any false statement, false representation, false report or false claim with respect to the character, quality, quantity, or cost of any work performed or to be performed, or materials furnished or to be furnished, in connection with the construction of any highway or related project approved by the Secretary of Transportation; or

Whoever knowingly makes any false statement or false representation as to material fact in any statement, certificate, or report submitted pursuant to provisions of the Federal-aid Roads Act approved July 1, 1916, (39 Stat. 355), as amended and supplemented;

Shall be fined under this title or imprisoned not more than 5 years or both."

## **IX. IMPLEMENTATION OF CLEAN AIR ACT AND FEDERAL WATER POLLUTION CONTROL ACT**

This provision is applicable to all Federal-aid construction contracts and to all related subcontracts.

By submission of this bid/proposal or the execution of this contract, or subcontract, as appropriate, the bidder, proposer, Federal-aid construction contractor, or subcontractor, as appropriate, will be deemed to have stipulated as follows:

1. That any person who is or will be utilized in the performance of this contract is not prohibited from receiving an award due to a violation of Section 508 of the Clean Water Act or Section 306 of the Clean Air Act.

2. That the contractor agrees to include or cause to be included the requirements of paragraph (1) of this Section X in every subcontract, and further agrees to take such action as the contracting agency may direct as a means of enforcing such requirements.

## **X. CERTIFICATION REGARDING DEBARMENT, SUSPENSION, INELIGIBILITY AND VOLUNTARY EXCLUSION**

This provision is applicable to all Federal-aid construction contracts, design-build contracts, subcontracts, lower-tier subcontracts, purchase orders, lease agreements, consultant contracts or any other covered transaction requiring FHWA approval or that is estimated to cost \$25,000 or more – as defined in 2 CFR Parts 180 and 1200.

### **1. Instructions for Certification – First Tier Participants:**

a. By signing and submitting this proposal, the prospective first tier participant is providing the certification set out below.

b. The inability of a person to provide the certification set out below will not necessarily result in denial of participation in this covered transaction. The prospective first tier participant shall submit an explanation of why it cannot provide the certification set out below. The certification or explanation will be considered in connection with the department or agency's determination whether to enter into this transaction. However, failure of the prospective first tier participant to furnish a certification or an explanation shall disqualify such a person from participation in this transaction.

c. The certification in this clause is a material representation of fact upon which reliance was placed when the contracting agency determined to enter into this transaction. If it is later determined that the prospective participant knowingly rendered an erroneous certification, in addition to other remedies available to the Federal Government, the contracting agency may terminate this transaction for cause of default.

d. The prospective first tier participant shall provide immediate written notice to the contracting agency to whom this proposal is submitted if any time the prospective first tier participant learns that its certification was erroneous when submitted or has become erroneous by reason of changed circumstances.

e. The terms "covered transaction," "debarred," "suspended," "ineligible," "participant," "person," "principal," and "voluntarily excluded,"

as used in this clause, are defined in 2 CFR Parts 180 and 1200. "First Tier Covered Transactions" refers to any covered transaction between a grantee or subgrantee of Federal funds and a participant (such as the prime or general contract). "Lower Tier Covered Transactions" refers to any covered transaction under a First Tier Covered Transaction (such as subcontracts). "First Tier Participant" refers to the participant who has entered into a covered transaction with a grantee or subgrantee of Federal funds (such as the prime or general contractor). "Lower Tier Participant" refers any participant who has entered into a covered transaction with a First Tier Participant or other Lower Tier Participants (such as subcontractors and suppliers).

f. The prospective first tier participant agrees by submitting this proposal that, should the proposed covered transaction be entered into, it shall not knowingly enter into any lower tier covered transaction with a person who is debarred, suspended, declared ineligible, or voluntarily excluded from participation in this covered transaction, unless authorized by the department or agency entering into this transaction.

g. The prospective first tier participant further agrees by submitting this proposal that it will include the clause titled "Certification Regarding Debarment, Suspension, Ineligibility and Voluntary Exclusion-Lower Tier Covered Transactions," provided by the department or contracting agency, entering into this covered transaction, without modification, in all lower tier covered transactions and in all solicitations for lower tier covered transactions exceeding the \$25,000 threshold.

h. A participant in a covered transaction may rely upon a certification of a prospective participant in a lower tier covered transaction that is not debarred, suspended, ineligible, or voluntarily excluded from the covered transaction, unless it knows that the certification is erroneous. A participant is responsible for ensuring that its principals are not suspended, debarred, or otherwise ineligible to participate in covered transactions. To verify the eligibility of its principals, as well as the eligibility of any lower tier prospective participants, each participant may, but is not required to, check the Excluded Parties List System website (<https://www.epls.gov/>), which is compiled by the General Services Administration.

i. Nothing contained in the foregoing shall be construed to require the establishment of a system of records in order to render in good faith the certification required by this clause. The knowledge and information of the prospective participant is not required to exceed that which is normally possessed by a prudent person in the ordinary course of business dealings.

j. Except for transactions authorized under paragraph (f) of these instructions, if a participant in a covered transaction knowingly enters into a lower tier covered transaction with a person who is suspended, debarred, ineligible, or voluntarily excluded from participation in this transaction, in addition to other remedies available to the Federal Government, the department or agency may terminate this transaction for cause or default.

\* \* \* \* \*

## **2. Certification Regarding Debarment, Suspension, Ineligibility and Voluntary Exclusion – First Tier Participants:**

a. The prospective first tier participant certifies to the best of its knowledge and belief, that it and its principals:

(1) Are not presently debarred, suspended, proposed for debarment, declared ineligible, or voluntarily excluded from participating in covered transactions by any Federal department or agency;

(2) Have not within a three-year period preceding this proposal been convicted of or had a civil judgment rendered against them for commission of fraud or a criminal offense in connection with obtaining, attempting to obtain, or performing a public (Federal, State or local) transaction or contract under a public transaction; violation of Federal or State antitrust statutes or commission of embezzlement, theft, forgery, bribery, falsification or destruction of records, making false statements, or receiving stolen property;

(3) Are not presently indicted for or otherwise criminally or civilly charged by a governmental entity (Federal, State or local) with

commission of any of the offenses enumerated in paragraph (a)(2) of this certification; and

(4) Have not within a three-year period preceding this application/proposal had one or more public transactions (Federal, State or local) terminated for cause or default.

b. Where the prospective participant is unable to certify to any of the statements in this certification, such prospective participant shall attach an explanation to this proposal.

### **2. Instructions for Certification - Lower Tier Participants:**

(Applicable to all subcontracts, purchase orders and other lower tier transactions requiring prior FHWA approval or estimated to cost \$25,000 or more - 2 CFR Parts 180 and 1200)

a. By signing and submitting this proposal, the prospective lower tier is providing the certification set out below.

b. The certification in this clause is a material representation of fact upon which reliance was placed when this transaction was entered into. If it is later determined that the prospective lower tier participant knowingly rendered an erroneous certification, in addition to other remedies available to the Federal Government, the department, or agency with which this transaction originated may pursue available remedies, including suspension and/or debarment.

c. The prospective lower tier participant shall provide immediate written notice to the person to which this proposal is submitted if at any time the prospective lower tier participant learns that its certification was erroneous by reason of changed circumstances.

d. The terms "covered transaction," "debarred," "suspended," "ineligible," "participant," "person," "principal," and "voluntarily excluded," as used in this clause, are defined in 2 CFR Parts 180 and 1200. You may contact the person to which this proposal is submitted for assistance in obtaining a copy of those regulations. "First Tier Covered Transactions" refers to any covered transaction between a grantee or subgrantee of Federal funds and a participant (such as the prime or general contract). "Lower Tier Covered Transactions" refers to any covered transaction under a First Tier Covered Transaction (such as subcontracts). "First Tier Participant" refers to the participant who has entered into a covered transaction with a grantee or subgrantee of Federal funds (such as the prime or general contractor). "Lower Tier Participant" refers any participant who has entered into a covered transaction with a First Tier Participant or other Lower Tier Participants (such as subcontractors and suppliers).

e. The prospective lower tier participant agrees by submitting this proposal that, should the proposed covered transaction be entered into, it shall not knowingly enter into any lower tier covered transaction with a person who is debarred, suspended, declared ineligible, or voluntarily excluded from participation in this covered transaction, unless authorized by the department or agency with which this transaction originated.

f. The prospective lower tier participant further agrees by submitting this proposal that it will include this clause titled "Certification Regarding Debarment, Suspension, Ineligibility and Voluntary Exclusion-Lower Tier Covered Transaction," without modification, in all lower tier covered transactions and in all solicitations for lower tier covered transactions exceeding the \$25,000 threshold.

g. A participant in a covered transaction may rely upon a certification of a prospective participant in a lower tier covered transaction that is not debarred, suspended, ineligible, or voluntarily excluded from the covered transaction, unless it knows that the certification is erroneous. A participant is responsible for ensuring that its principals are not suspended, debarred, or otherwise ineligible to participate in covered transactions. To verify the eligibility of its principals, as well as the eligibility of any lower tier prospective participants, each participant may, but is not required to, check the Excluded Parties List System website (<https://www.epls.gov/>), which is compiled by the General Services Administration.

h. Nothing contained in the foregoing shall be construed to require establishment of a system of records in order to render in good faith the

certification required by this clause. The knowledge and information of participant is not required to exceed that which is normally possessed by a prudent person in the ordinary course of business dealings.

i. Except for transactions authorized under paragraph e of these instructions, if a participant in a covered transaction knowingly enters into a lower tier covered transaction with a person who is suspended, debarred, ineligible, or voluntarily excluded from participation in this transaction, in addition to other remedies available to the Federal Government, the department or agency with which this transaction originated may pursue available remedies, including suspension and/or debarment.

\* \* \* \* \*

**Certification Regarding Debarment, Suspension, Ineligibility and Voluntary Exclusion--Lower Tier Participants:**

1. The prospective lower tier participant certifies, by submission of this proposal, that neither it nor its principals is presently debarred, suspended, proposed for debarment, declared ineligible, or voluntarily excluded from participating in covered transactions by any Federal department or agency.

2. Where the prospective lower tier participant is unable to certify to any of the statements in this certification, such prospective participant shall attach an explanation to this proposal.

\* \* \* \* \*

**XI. CERTIFICATION REGARDING USE OF CONTRACT FUNDS FOR LOBBYING**

This provision is applicable to all Federal-aid construction contracts and to all related subcontracts which exceed \$100,000 (49 CFR 20).

1. The prospective participant certifies, by signing and submitting this bid or proposal, to the best of his or her knowledge and belief, that:

a. No Federal appropriated funds have been paid or will be paid, by or on behalf of the undersigned, to any person for influencing or attempting to influence an officer or employee of any Federal agency, a Member of Congress, an officer or employee of Congress, or an employee of a Member of Congress in connection with the awarding of any Federal contract, the making of any Federal grant, the making of any Federal loan, the entering into of any cooperative agreement, and the extension, continuation, renewal, amendment, or modification of any Federal contract, grant, loan, or cooperative agreement.

b. If any funds other than Federal appropriated funds have been paid or will be paid to any person for influencing or attempting to influence an officer or employee of any Federal agency, a Member of Congress, an officer or employee of Congress, or an employee of a Member of Congress in connection with this Federal contract, grant, loan, or cooperative agreement, the undersigned shall complete and submit Standard Form-LLL, "Disclosure Form to Report Lobbying," in accordance with its instructions.

2. This certification is a material representation of fact upon which reliance was placed when this transaction was made or entered into. Submission of this certification is a prerequisite for making or entering into this transaction imposed by 31 U.S.C. 1352. Any person who fails to file the required certification shall be subject to a civil penalty of not less than \$10,000 and not more than \$100,000 for each such failure.

3. The prospective participant also agrees by submitting its bid or proposal that the participant shall require that the language of this certification be included in all lower tier subcontracts, which exceed \$100,000 and that all such recipients shall certify and disclose accordingly.

**MINIMUM WAGES FOR FEDERAL AND FEDERALLY  
ASSISTED CONSTRUCTION CONTRACTS**

This project is funded, in part, with Federal-aid funds and, as such, is subject to the provisions of the Davis-Bacon Act of March 3, 1931, as amended (46 Sta. 1494, as amended, 40 U.S.C. 276a) and of other Federal statutes referred to in a 29 CFR Part 1, Appendix A, as well as such additional statutes as may from time to time be enacted containing provisions for the payment of wages determined to be prevailing by the Secretary of Labor in accordance with the Davis-Bacon Act and pursuant to the provisions of 29 CFR Part 1. The prevailing rates and fringe benefits shown in the General Wage Determination Decisions issued by the U.S. Department of Labor shall, in accordance with the provisions of the foregoing statutes, constitute the minimum wages payable on Federal and federally assisted construction projects to laborers and mechanics of the specified classes engaged on contract work of the character and in the localities described therein.

General Wage Determination Decisions, modifications and supersedes decisions thereto are to be used in accordance with the provisions of 29 CFR Parts 1 and 5. Accordingly, the applicable decision, together with any modifications issued, must be made a part of every contract for performance of the described work within the geographic area indicated as required by an applicable DBRA Federal prevailing wage law and 29 CFR Part 5. The wage rates and fringe benefits contained in the General Wage Determination Decision shall be the minimum paid by contractors and subcontractors to laborers and mechanics.

**NOTICE**

The most current **General Wage Determination Decisions** (wage rates) are available on the IDOT web site. They are located on the Letting and Bidding page at <http://www.dot.state.il.us/desenv/delett.html>.

In addition, ten (10) days prior to the letting, the applicable Federal wage rates will be e-mailed to subscribers. It is recommended that all contractors subscribe to the Federal Wage Rates List or the Contractor's Packet through IDOT's subscription service.

PLEASE NOTE: if you have already subscribed to the Contractor's Packet you will automatically receive the Federal Wage Rates.

The instructions for subscribing are at <http://www.dot.state.il.us/desenv/subsc.html>.

If you have any questions concerning the wage rates, please contact IDOT's Chief Contract Official at 217-782-7806.