

STATE OF ILLINOIS  
DEPARTMENT OF TRANSPORTATION

F.A. RTE.	SECTION	COUNTY	TOTAL SHEETS	SHEET NO.
VAR.	D2 BC 2025-02	VARIOUS	18	1
		ILLINOIS	CONTRACT NO. 64T35	

FOR INDEX OF SHEETS, SEE SHEET NO. 2  
FOR STATE STANDARDS, SEE SHEET NO. 2

# PROPOSED HIGHWAY PLANS

VARIOUS ROUTES  
SECTION D2 BC 2025-02  
PROJECT:  
TYPE of IMPROVEMENT: BRIDGE WASHING

## VARIOUS COUNTIES

C-92-085-24

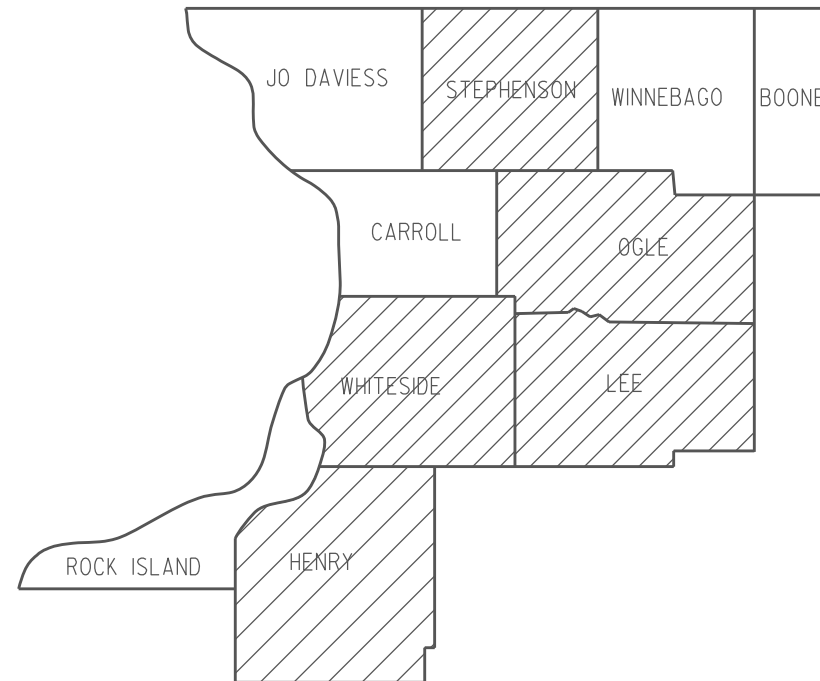

LOCATION OF SECTION INDICATED THUS: - [Hatched Box]

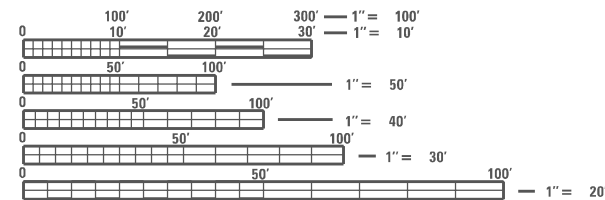

FULL SIZE PLANS HAVE BEEN PREPARED USING STANDARD ENGINEERING SCALES, REDUCED SIZED PLANS WILL NOT CONFORM TO STANDARD SCALES. IN MAKING MEASUREMENTS ON REDUCED PLANS, THE ABOVE SCALES MAY BE USED.

J.U.L.I.E.  
JOINT UTILITY LOCATION INFORMATION FOR EXCAVATION  
1-800-892-0123  
OR 811

PROJECT ENGINEER: DAVID DOSS (815) 284-5416  
PROJECT MANAGER: DERRICK LOPEZ (815) 284-5398

CONTRACT NO. 64T35

D-92-007-25

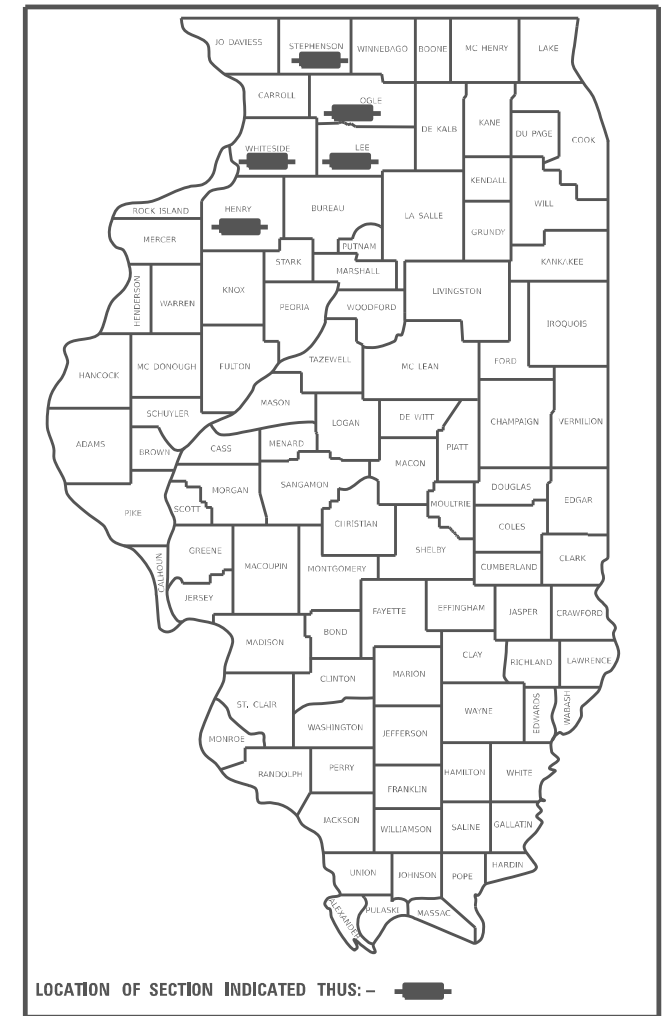

LOCATION OF SECTION INDICATED THUS: - [Black Rectangle]

STATE OF ILLINOIS  
DEPARTMENT OF TRANSPORTATION

SUBMITTED October 1 2024  
*Julia Thompson*  
REGIONAL ENGINEER

December 6, 2024  
*Scott A. Elk*  
ENGINEER OF DESIGN AND ENVIRONMENT

December 6, 2024  
*Gemma J. Gunn*  
DIRECTOR OF HIGHWAYS PROJECT IMPLEMENTATION 13

PRINTED BY THE AUTHORITY  
OF THE STATE OF ILLINOIS

# INDEX OF SHEETS

- 1 COVER SHEET
- 2 INDEX OF SHEETS & STATE STANDARDS
- 3 SUMMARY OF QUANTITIES
- 4 SCHEDULE OF QUANTITIES
- 5 LOCATION MAP HENRY COUNTY
- 6 LOCATION MAP LEE COUNTY
- 7 LOCATION MAP OGLE COUNTY
- 8 LOCATION MAP STEPHENSON COUNTY
- 9 LOCATION MAP WHITESIDE COUNTY
- 10-13 WORK ZONE SIGN DETAILS (DIST STD 34.1)
- 14 URBAN LANE INSIDE CLOSURE, MULTILANE, 2-WAY, WITH MOUNTABLE MEDIAN (DIST STD 35.1)
- 15-18 TRAFFIC CONTROL FOR TRANSITION AREAS (DIST STD 38.1)

# STATE STANDARDS

- 701006-05 OFF-ROAD OPERATIONS, 2L, 2W, 15'(4.5m) TO 24" (600mm) FROM PAVEMENT EDGE
- 701101-05 OFF-ROAD OPERATIONS, MULTILANE, 15'(4.5m) TO 24"(600mm) FROM PAVEMENT EDGE
- 701201-05 LANE CLOSURE, 2L, 2W, DAY ONLY, FOR SPEEDS,  $\geq$  45 MPH
- 701301-04 LANE CLOSURE, 2L, 2W, SHORT TIME OPERATIONS
- 701400-12 APPROACH TO LANE CLOSURE, FREEWAY/EXPRESSWAY
- 701406-13 LANE CLOSURE, FREEWAY/EXPRESSWAY, DAY OPERATIONS ONLY
- 701606-10 URBAN SINGLE LANE CLOSURE, MULTILANE, 2W WITH MOUNTABLE MEDIAN
- 701901-10 TRAFFIC CONTROL DEVICES
- 720011-01 METAL POSTS FOR SIGNS, MARKERS AND DELINEATORS
- 728001-01 TELESCOPING STEEL SIGN SUPPORT
- 729001-01 APPLICATIONS OF TYPES A & B METAL POSTS (FOR SIGNS & MARKERS)

MODEL: D:\buit...  
 FILE: M:\buit...

USER NAME = David.Doss	DESIGNED -	REVISED -	<b>STATE OF ILLINOIS DEPARTMENT OF TRANSPORTATION</b>	<b>INDEX OF SHEETS &amp; STATE STANDARDS</b>	F.A. RTE.	SECTION	COUNTY	TOTAL SHEETS	SHEET NO.	
PLOT SCALE = \$SCALE\$	DRAWN -	REVISED -			VAR.	D2 BC 2025-02	VARIOUS	18	2	
PLOT DATE = 6/24/2024	CHECKED -	REVISED -			CONTRACT NO. 64T35					
	DATE -	REVISED -			ILLINOIS FED. AID PROJECT					
				SCALE:	SHEET	OF	SHEETS	STA.	TO STA.	

# SUMMARY OF QUANTITIES

Paycode	Description	Units	0047 100% STATE	Total
59200101	BRIDGE WASHING NO. 1	EACH	1	1
59200102	BRIDGE WASHING NO. 2	EACH	1	1
59200103	BRIDGE WASHING NO. 3	EACH	1	1
59200104	BRIDGE WASHING NO. 4	EACH	1	1
59200105	BRIDGE WASHING NO. 5	EACH	1	1
59200106	BRIDGE WASHING NO. 6	EACH	1	1
59200107	BRIDGE WASHING NO. 7	EACH	1	1
59200108	BRIDGE WASHING NO. 8	EACH	1	1
67100100	MOBILIZATION	L SUM	1	1
70100450	TRAFFIC CONTROL AND PROTECTION, STANDARD 701201	L SUM	1	1
70102625	TRAFFIC CONTROL AND PROTECTION, STANDARD 701606	L SUM	1	1
70100700	TRAFFIC CONTROL AND PROTECTION, STANDARD 701406	L SUM	1	1

MODEL: D:\b\air\...  
 FILE: M:\a\...  
 MODEL: D:\b\air\...  
 FILE: M:\a\...

USER NAME = David.Doss	DESIGNED -	REVISED -	<b>STATE OF ILLINOIS DEPARTMENT OF TRANSPORTATION</b>	<b>SUMMARY OF QUANTITIES</b>				F.A. RTE.	SECTION	COUNTY	TOTAL SHEETS	SHEET NO.			
PLOT SCALE = \$SCALE\$	DRAWN -	REVISED -		SCALE:	SHEET	OF	SHEETS	STA.	TO	STA.	VAR.	D2 BC 2025-02	VARIOUS	18	3
PLOT DATE = 6/24/2024	CHECKED -	REVISED -		CONTRACT NO. 64T35											
	DATE -	REVISED -		ILLINOIS   FED. AID PROJECT											

# SCHEDULE OF QUANTITIES

Pay Item	Project Location	SN	Facility Carried	Feature Crossed	Bridge Location	Traffic Control
BRIDGE WASHING NO. 1	1	037-0149	IL 92	Rock River	1.0 MI East of Joslin	701201
BRIDGE WASHING NO. 2	2	052-0063	IL 2	Rock River	South edge of Grand Detour	701201
BRIDGE WASHING NO. 3	3	071-0066	IL 251	IL 38, C&NW RR, BN RR	In Rochelle	701606 DIST STD 35.1
BRIDGE WASHING NO. 4	4	071-0088	IL 64	Rock River	East of IL 2 in Oregon	701606 DIST STD 35.1 DIST STD 38.1
BRIDGE WASHING NO. 5	5	089-0042	US ROUTE 20	Pecatonica River	NE of Freeport	701400 701406
BRIDGE WASHING NO. 6		089-0081	US ROUTE 20 WB	Pecatonica River	NE of Freeport	701400 701406
BRIDGE WASHING NO. 7	6	098-0034	US RT 30	Rock River	1 Mi East of JCT IL 2, 1.5 Mi West of Rock Falls	701201
BRIDGE WASHING NO. 8	7	098-0115	IL 40	Rock River	Between Sterling and Rock Falls	701606 DIST STD 35.1

MODEL: Default  
 FILE: \\a:\fileserver\fileserver\dot\dot\cas\District\_2\ORD\Project\Operations\Bridges\_Section\Bridges\_Washing\Contract\2025\January\_Letter\64T35-Sub-Cover.dgn

USER NAME = David.Doss	DESIGNED -	REVISED -
	DRAWN -	REVISED -
PLOT SCALE = 1/4"=1'	CHECKED -	REVISED -
PLOT DATE = 6/24/2024	DATE -	REVISED -

**STATE OF ILLINOIS**  
**DEPARTMENT OF TRANSPORTATION**

**SCHEDULE OF QUANTITIES**

SCALE:      SHEET      OF      SHEETS      STA.      TO STA.

F.A. RTE.	SECTION	COUNTY	TOTAL SHEETS	SHEET NO.
VAR.	D2 BC 2025-02	VARIOUS	18	4
			CONTRACT NO. 64T35	
ILLINOIS FED. AID PROJECT				

# HENRY COUNTY



LOCATION 1  
SN 037-0149  
BRIDGE WASHING NO. 1



MODEL: Default  
 FILE: \\dot-cw-beafray.com\FW\DOT\Documents\DOT\_0\_csr\District\_2\08D\_projects\Operations\Bridges\_Section\Bridges\_Washing\_Contract\2025\January\_Letter\64T35\_Bridge\_Washing\_1\various\_locations\_1\CADD\64T35-sht-cover.dgn

USER NAME = David.Doss	DESIGNED -	REVISED -
PLOT SCALE = \$SCALE\$	DRAWN -	REVISED -
PLOT DATE = 6/24/2024	CHECKED -	REVISED -
	DATE -	REVISED -

STATE OF ILLINOIS  
DEPARTMENT OF TRANSPORTATION

HENRY COUNTY  
LOCATION MAP

SCALE: SHEET OF SHEETS STA. TO STA.

F.A. RTE.	SECTION	COUNTY	TOTAL SHEETS	SHEET NO.
VAR.	D2 BC 2025-02	VARIOUS	18	5
			CONTRACT NO. 64T35	
ILLINOIS FED. AID PROJECT				

# LEE COUNTY



LOCATION 2  
SN 052-0063 BRIDGE WASHING NO. 2

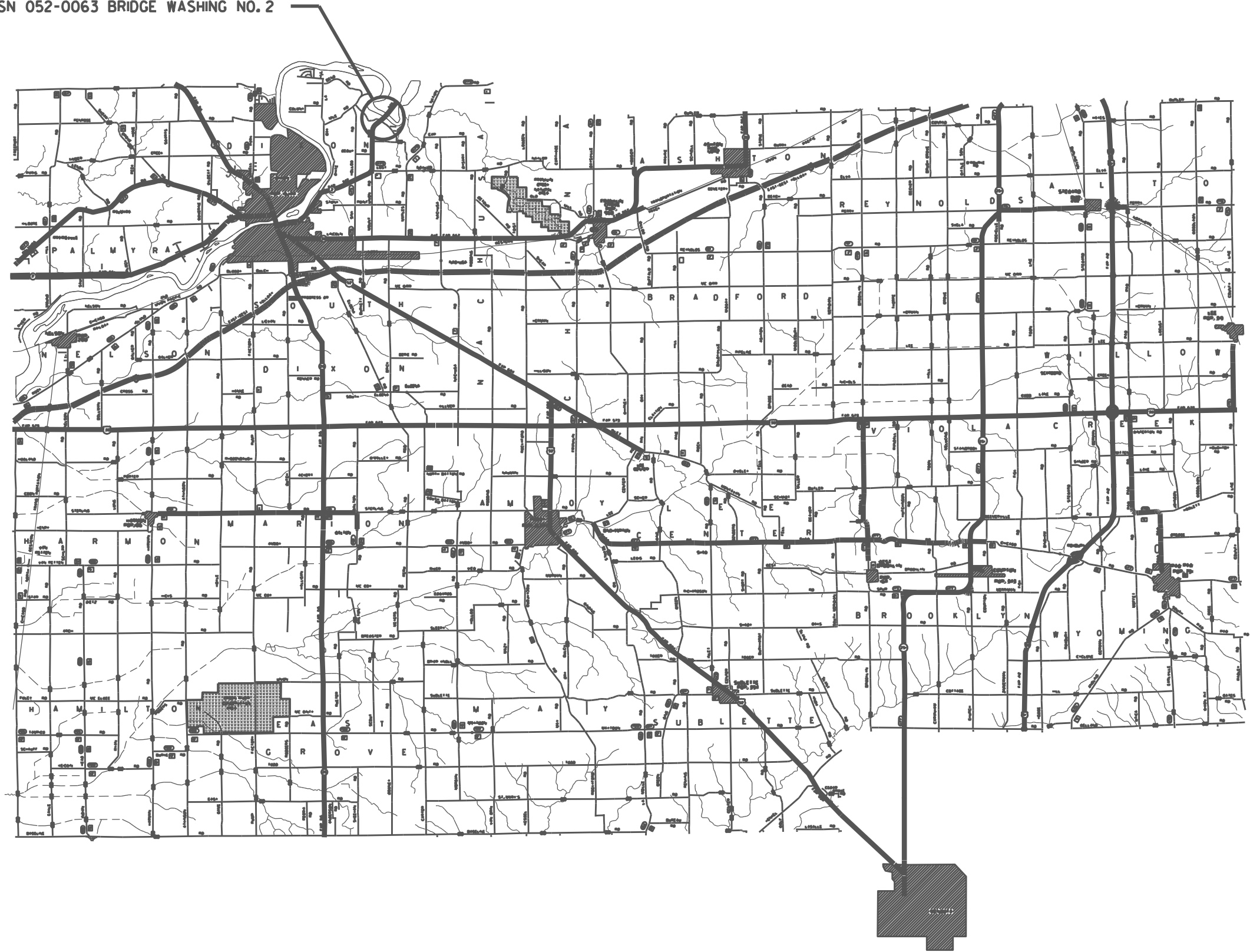

MODEL: Default  
 FILE NAME: \\dot-cw-beadwy.com\P\DOT\Documents\DOT\_0\_cas\District\_2\08D\_projects\Operations\Bridges\_Section\Bridges\_Washing\_Sn052-0063\_Bridge\_Washing\_2\_Various\_Location\_2\CADD\64T35-01-Cover.dgn

USER NAME = David.Doss	DESIGNED -	REVISED -
PLOT SCALE = \$SCALES	DRAWN -	REVISED -
PLOT DATE = 6/24/2024	CHECKED -	REVISED -
	DATE -	REVISED -

STATE OF ILLINOIS  
DEPARTMENT OF TRANSPORTATION

LEE COUNTY LOCATION MAP			
SCALE:	SHEET	OF SHEETS	STA. TO STA.

F.A. RTE.	SECTION	COUNTY	TOTAL SHEETS	SHEET NO.
VAR.	D2 BC 2025-02	VARIOUS	18	6
CONTRACT NO. 64T35				
ILLINOIS FED. AID PROJECT				

# OGLE COUNTY

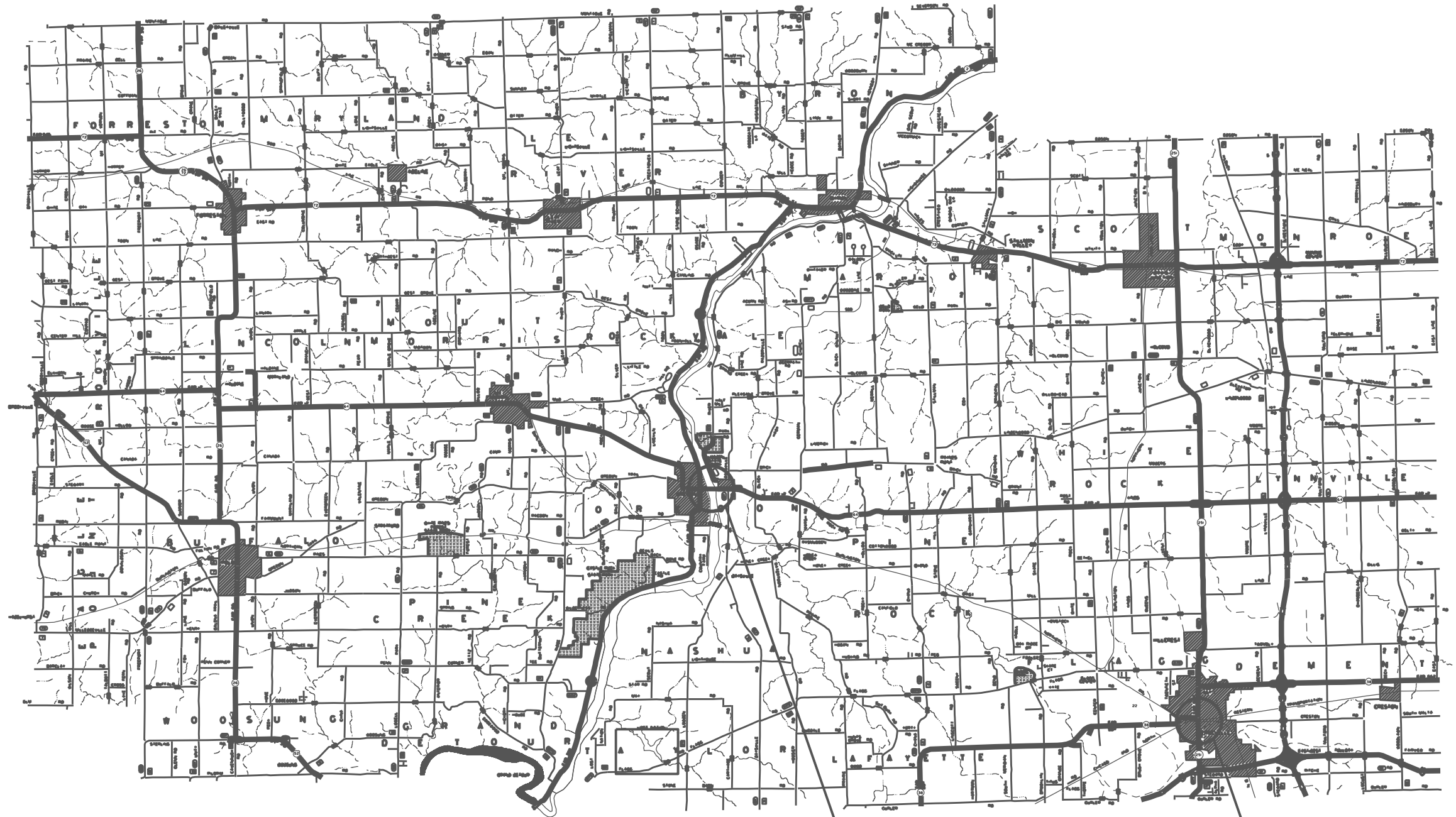

LOCATION 4  
SN 071-0088  
BRIDGE WASHING NO. 4

LOCATION 3  
SN 071-0066  
BRIDGE WASHING NO. 3

MODEL: Default  
 FILE: \\dot-cw-beadley.com\P\DOT\Documents\DOT\_0\_cas\District\_2\080\_Projects\Operations\Bridges\_Section\Bridges\_Section\Bridges\_Section\071-0088-04\071-0088-04.dwg  
 CONTRACT: 2025\January Letter\64T35-01.dwg  
 DATE: 6/24/2024

USER NAME = David.Doss	DESIGNED -	REVISED -
	DRAWN -	REVISED -
PLOT SCALE = 5/8"=1'	CHECKED -	REVISED -
PLOT DATE = 6/24/2024	DATE -	REVISED -

**STATE OF ILLINOIS  
DEPARTMENT OF TRANSPORTATION**

**OGLE COUNTY  
LOCATION MAP**

SCALE: SHEET OF SHEETS STA. TO STA.

F.A. RTE.	SECTION	COUNTY	TOTAL SHEETS	SHEET NO.
VAR.	D2 BC 2025-02	VARIOUS	18	7
CONTRACT NO. 64T35				
ILLINOIS FED. AID PROJECT				

# STEPHENSON COUNTY

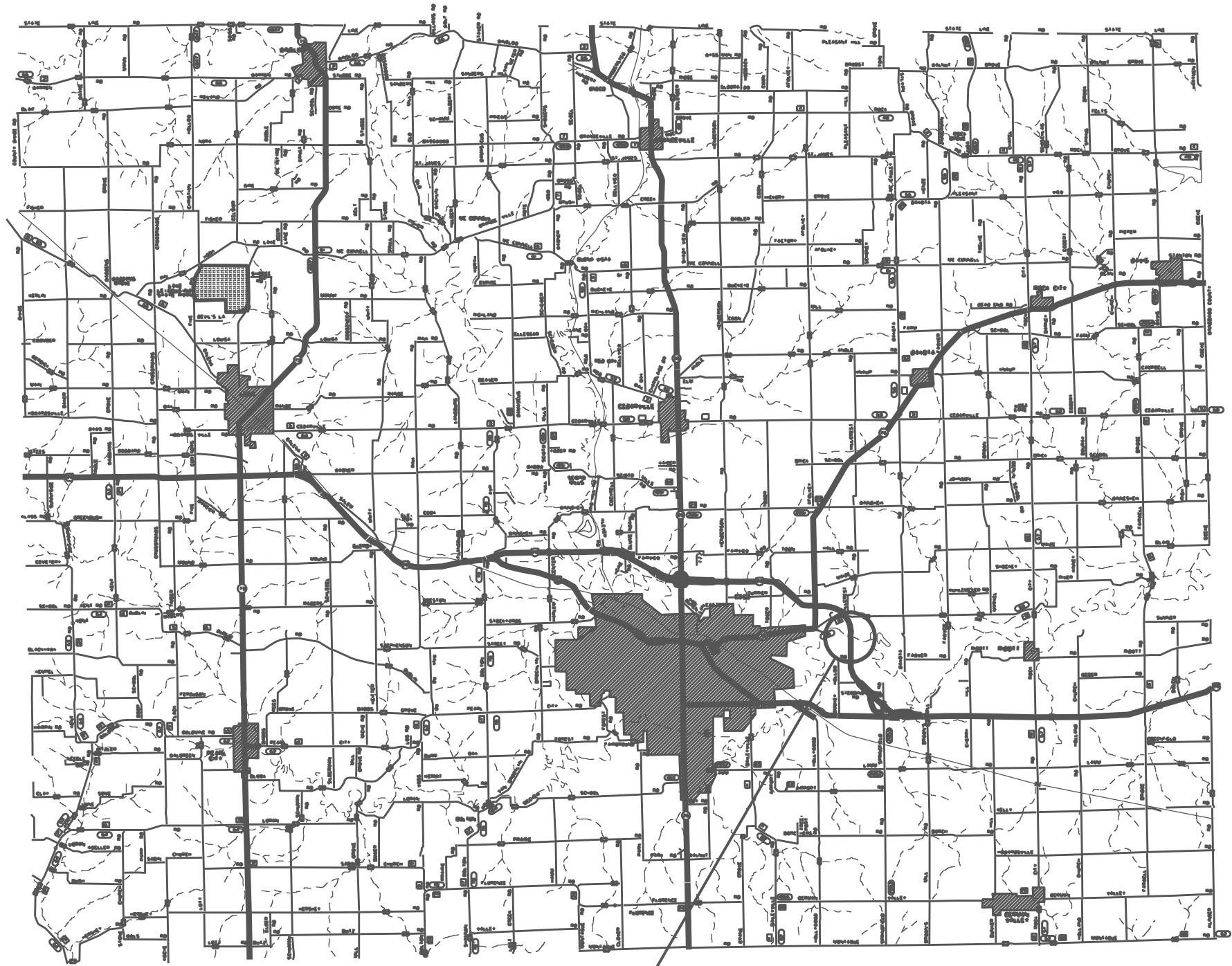

LOCATION 5  
 SN 089-0081 BRIDGE WASHING NO. 6  
 SN 089-0042 BRIDGE WASHING NO. 5

MODEL: Default  
 FILE NAME: s:\dot\documents\DOT\_0\_cas\District\_2\08D\_projects\Operations\Bridges\_Section\Bridges\_Location\Letter\64T35\_Bridge\_Washing\_at\_various\_locations\_@IACADD64T35-shr-cover.dgn

USER NAME = David.Doss	DESIGNED -	REVISED -
	DRAWN -	REVISED -
PLOT SCALE = \$SCALE\$	CHECKED -	REVISED -
PLOT DATE = 6/24/2024	DATE -	REVISED -

**STATE OF ILLINOIS**  
**DEPARTMENT OF TRANSPORTATION**

**STEPHENSON COUNTY**  
**LOCATION MAP**

SCALE:      SHEET      OF      SHEETS      STA.      TO      STA.

F.A. RTE.	SECTION	COUNTY	TOTAL SHEETS	SHEET NO.
VAR.	D2 BC 2025-02	VARIOUS	18	8
			CONTRACT NO. 64T35	
ILLINOIS FED. AID PROJECT				



# WHITESIDE COUNTY

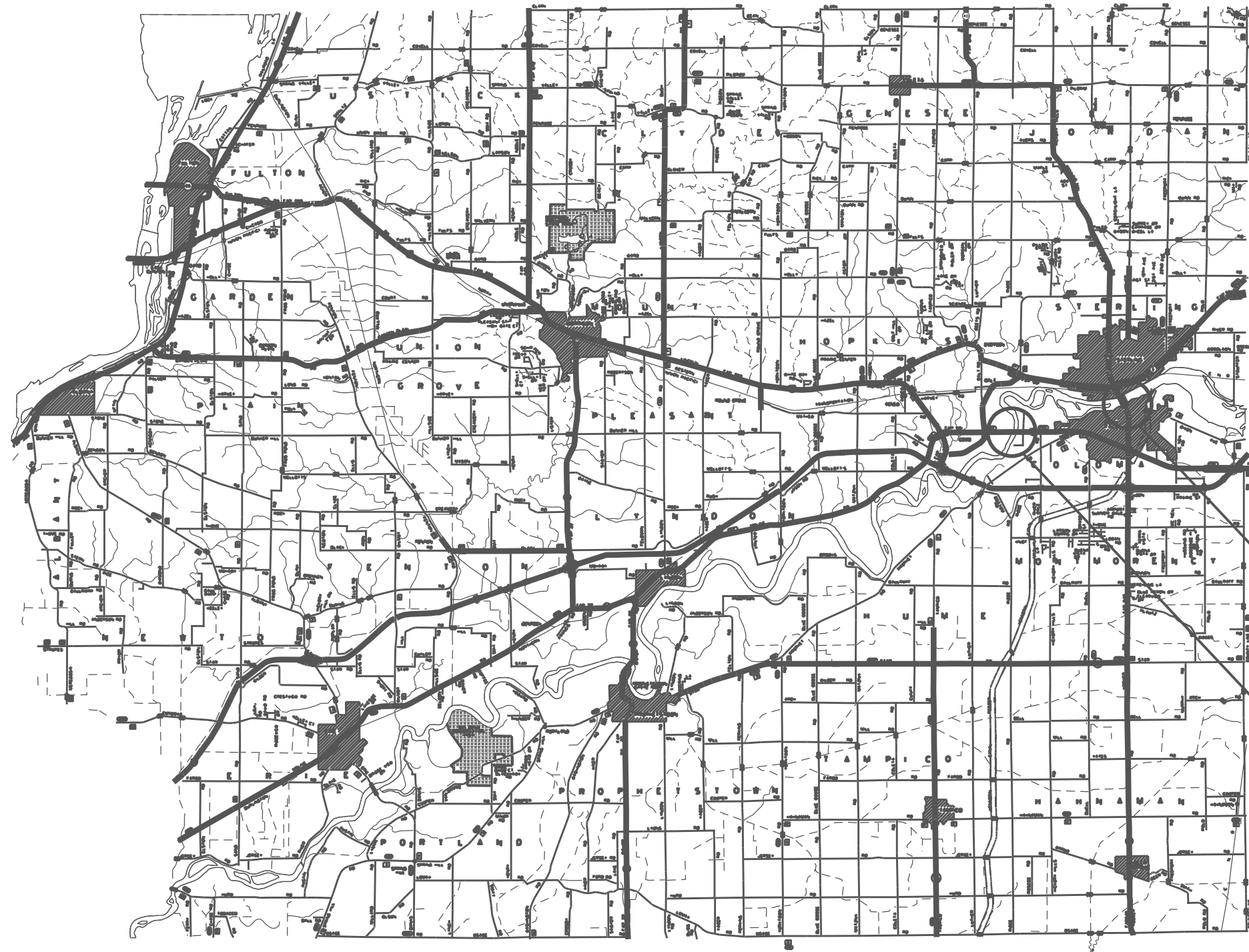

LOCATION 7  
SN 098-0115  
BRIDGE WASHING NO. 8

LOCATION 6  
SN 098-0034  
BRIDGE WASHING NO. 7

MODEL: Default  
 FILE NAME: \\dot-cw-beadley.com\P\DOT\Documents\DOT\_0\_cas\District\_2\080\_Projects\Operations\Bridges\_Section\Bridges\_Washing\_Contract\2025\January\_Letter\64T35\_Location\_6\CAADD64T35-shr-cover.dgn

USER NAME = David.Doss	DESIGNED -	REVISED -
	DRAWN -	REVISED -
PLOT SCALE = \$SCALE\$	CHECKED -	REVISED -
PLOT DATE = 6/24/2024	DATE -	REVISED -

STATE OF ILLINOIS  
DEPARTMENT OF TRANSPORTATION

WHITESIDE COUNTY  
LOCATION MAP

SCALE: SHEET OF SHEETS STA. TO STA.

F.A. RTE.	SECTION	COUNTY	TOTAL SHEETS	SHEET NO.
VAR.	D2 BC 2025-02	VARIOUS	18	9
			CONTRACT NO. 64T35	
ILLINOIS FED. AID PROJECT				

# WORK ZONE SIGN DETAILS

**ILLINOIS STANDARD G20-I100**

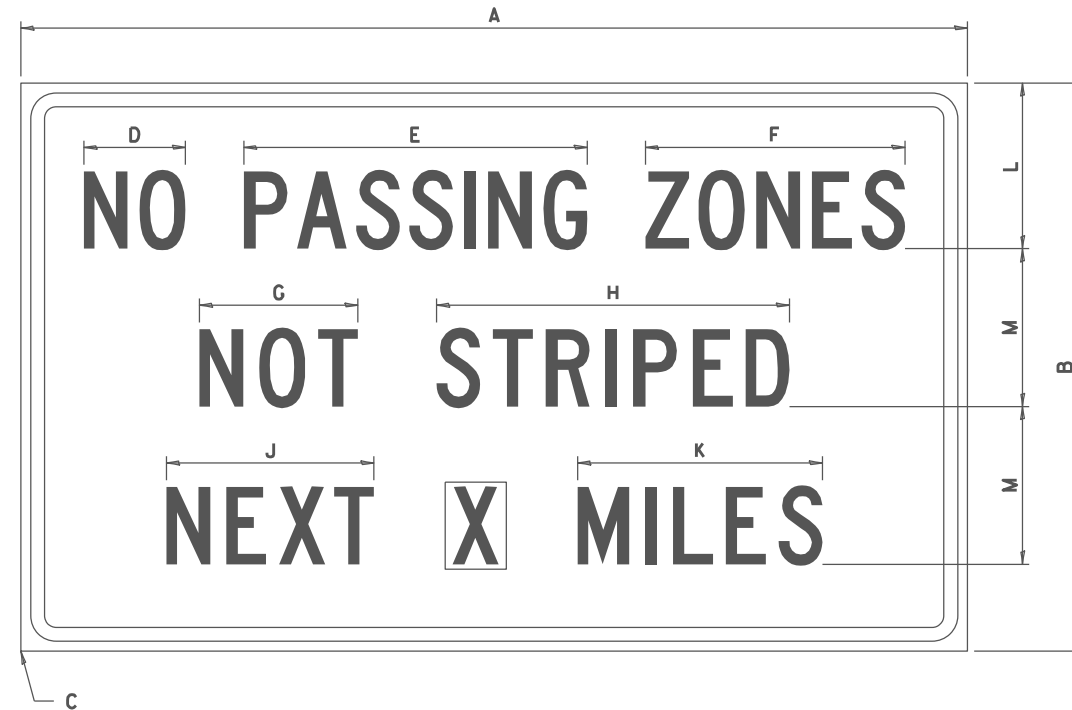

COLOR LEGEND AND BORDER BACKGROUND BLACK ORANGE NON-REFLECTORIZED REFLECTORIZED

SIGN SIZE	DIMENSIONS											
	A	B	C	D	E	F	G	H	J	K	L	M
60 x 36	60.00	36.00	2.25	6.4	21.80	16.40	10.00	22.40	13.20	15.50	10.50	10.00

SIGN SIZE	SERIES BY LINE			MARGIN	BORDER
	1	2	3		
60 x 36	5C	5C	5C	0.625	0.875

Sign not to scale

**GENERAL NOTES**

All work to furnish and install these signs shall be included in the cost of the specified traffic control standards and shall not be paid separately.

All Illinois Standard signs shall conform to the latest edition of the "Illinois Standard Highway Signs Book" in effect on the date of invitation for bids.

Signs shall meet the applicable portions of Sections 701 and 720 of the Standard Specifications.

All dimensions are in inches unless otherwise noted.

**ILLINOIS STANDARD W8-I107**

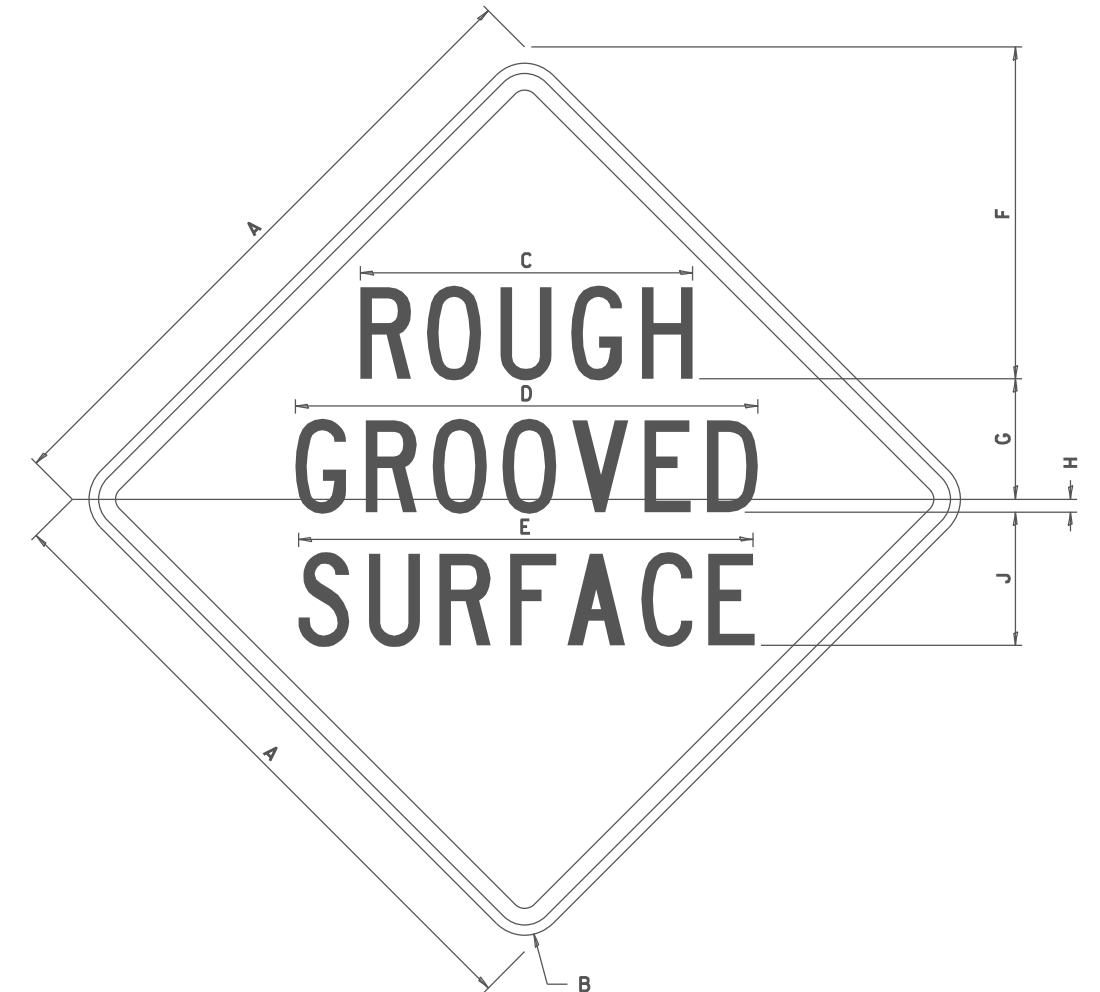

COLOR LEGEND AND BORDER BACKGROUND BLACK ORANGE NON-REFLECTORIZED REFLECTORIZED

SIGN SIZE	DIMENSIONS									
	A	B	C	D	E	F	G	H	J	
48 x 48	48.00	3.00	25.00	34.80	34.20	24.94	9.00	1.00	10.00	

SIGN SIZE	SERIES BY LINE			MARGIN	BORDER
	1	2	3		
48 x 48	7C	7C	7C	1.250	0.750

Sign not to scale

FILE NAME =	USER NAME = David.Doss	DESIGNED -	REVISED - 3-02-16	STATE OF ILLINOIS DEPARTMENT OF TRANSPORTATION	REGION 2 / DISTRICT 2 STANDARD				F.A. RTE.	SECTION	COUNTY	TOTAL SHEETS	SHEET NO.
pw://idot-pw.bentley.com/PWIDOT/Documents/IDOT Offices/District 2/ORD Projects/Operations/Bridge Section/Bridge Washing Contract/January Letting/64135 Bridge Washing at various locations (64135) (1).dgn		DRAWN	REVISED		SCALE:	SHEET NO. OF	SHEETS	STA. TO STA.	VAR.	D2 BC 2025-02	VARIOUS	18	10
		CHECKED	REVISED						CONTRACT NO. 64135				
		DATE	REVISED						FED. ROAD DIST. NO. ILLINOIS FED. AID PROJECT				

# WORK ZONE SIGN DETAILS

## ILLINOIS STANDARD W12-I102

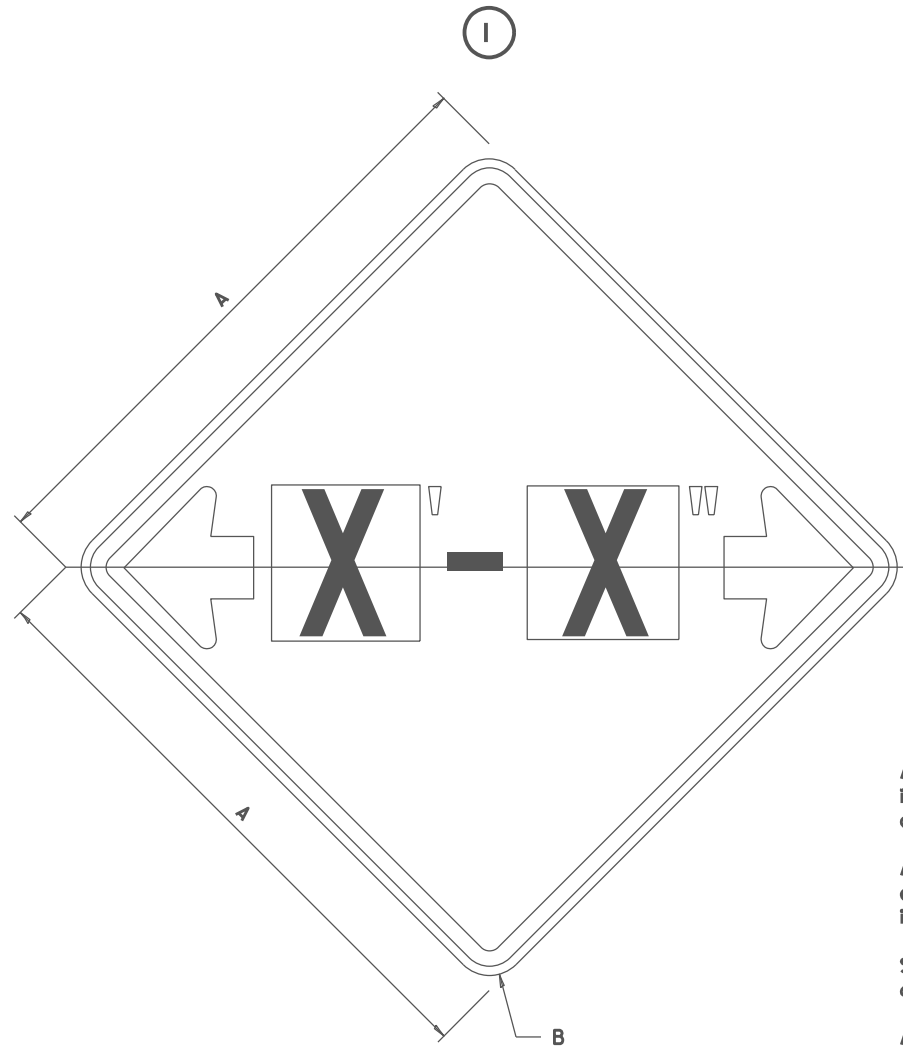

### GENERAL NOTES

All work to furnish and install these signs shall be included in the cost of the specified traffic control standards and shall not be paid separately.

All Illinois Standard signs shall conform to the latest edition of the "Illinois Standard Highway Signs Book" in effect on the date of invitation for bids.

Signs shall meet the applicable portions of Sections 701 and 720 of the Standard Specifications.

All dimensions are in inches unless otherwise noted.

COLOR	LEGEND AND BORDER BACKGROUND	BLACK FL ORANGE	NON-REFLECTORIZED REFLECTORIZED

SIGN SIZE	DIMENSIONS	
	A	B
48 x 48	48.00	3.00

① Illinois Standard signs W12-I102 and W12-I103 shall be used as described in the special provisions.

SIGN SIZE	SERIES BY LINE	MARGIN	BORDER
	I		
48 x 48	I2C	0.750	1.250

Sign not to scale

## ILLINOIS STANDARD W12-I103

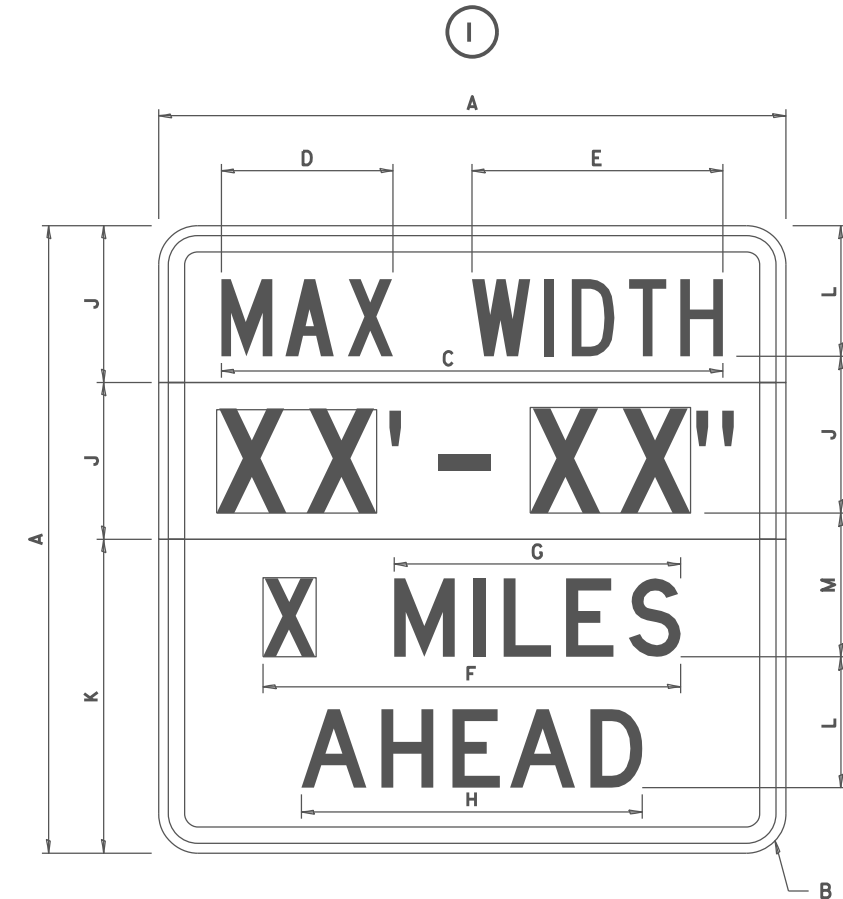

COLOR	LEGEND AND BORDER BACKGROUND (WIDTH)	BLACK WHITE FL ORANGE	NON-REFLECTORIZED REFLECTORIZED REFLECTORIZED

SIGN SIZE	DIMENSIONS											
	A	B	C	D	E	F	G	H	J	K	L	M
48 x 48	48.00	3.00	38.40	13.20	19.20	32.00	22.00	26.20	12.00	24.00	10.00	11.00

SIGN SIZE	SERIES BY LINE				MARGIN	BORDER
	1	2	3	4		
48 x 48	6C	8D	6D	6D	0.750	1.250

Sign not to scale

XX'-XX" WIDTH AND X MILES ARE VARIABLE TOP AND BOTTOM OF BACKGROUND WHITE

FILE NAME :	USER NAME = David.Doss	DESIGNED -	REVISED - 3-02-16	STATE OF ILLINOIS DEPARTMENT OF TRANSPORTATION	REGION 2 / DISTRICT 2 STANDARD			F.A. RTE.	SECTION	COUNTY	TOTAL SHEETS	SHEET NO.
pw://idot-pw.bentley.com/PWIDOT/Documents/IDOT Offices/District 2/ORD Projects/Operations/Bridge Section/Bridge Washing Contract/January Letting/64135 Bridge Washing at various locations (S&P) 3-16-16.dwg	DRAWN	REVISION	REVISION		VAR.	D2 BC 2025-02	VARIOUS	18	II			
PLOT SCALE = #SCALE#	CHECKED -	REVISION	REVISION		CONTRACT NO. 64135							
PLOT DATE = 6/24/2024	DATE -	REVISION	REVISION		SCALE:	SHEET NO. OF SHEETS	STA. TO STA.	FED. ROAD DIST. NO.	ILLINOIS FED. AID PROJECT			

# WORK ZONE SIGN DETAILS

## STOP LINE SIGN FOR TEMPORARY SIGNALS

### ROAD CLOSED TO OVERSIZED LOADS



COLOR	LEGEND AND BORDER BACKGROUND	BLACK ORANGE	NON-REFLECTORIZED REFLECTORIZED
-------	------------------------------	--------------	---------------------------------

Permit Loads - Loads Over 13 Feet; 3.0' Radius, 1.3' Border;  
 [NO OVERSIZE -] D; [OVERWEIGHT LOADS] D 85% spacing; [XX MILES AHEAD] D;  
 Table of letter and object lefts.

N	O	O	V	E	R	S	I	Z	E	-
11.7	18.1	30.0	36.2	42.8	48.4	54.4	60.7	63.5	69.5	80.8

O	V	E	R	W	E	I	G	H	T	L	O	A	D	S
2.6	8.6	15.0	20.4	26.2	33.4	38.8	41.3	47.4	53.2	64.5	69.9	75.9	82.9	88.7

X	X	M	I	L	E	S	A	H	E	A	D
7.6	13.6	25.3	32.3	35.1	40.6	46.2	57.9	65.1	71.4	76.6	83.7

Sign not to scale

COLOR	LEGEND AND BORDER BACKGROUND	BLACK WHITE	NON-REFLECTORIZED REFLECTORIZED
-------	------------------------------	-------------	---------------------------------

SIGN SIZE	SERIES BY LINE		
	1	2	3
24 x 24	4C	4C	4C

Sign not to scale

### GENERAL NOTES

All work to furnish and install these signs shall be included in the cost of the specified traffic control standards and shall not be paid separately.

All Illinois Standard signs shall conform to the latest edition of the "Illinois Standard Highway Signs Book" in effect on the date of invitation for bids.

Signs shall meet the applicable portions of Sections 701 and 720 of the Standard Specifications.

All dimensions are in inches unless otherwise noted.

FILE NAME =	USER NAME = David.Doss	DESIGNED -	REVISED - 3-02-16	STATE OF ILLINOIS DEPARTMENT OF TRANSPORTATION	REGION 2 / DISTRICT 2 STANDARD	F.A. RTE.	SECTION	COUNTY	TOTAL SHEETS	SHEET NO.
pw://idot-pw.bentley.com/PWIDOT/Documents/IDOT Offices/District 2/ORD Projects/Operations/Bridge Section/Bridge Washing Contract/January Letting/64135 Bridge Washing at various locations (S&P) (64135).dgn	DRAWN	REVISION	VAR.			D2 BC 2025-02	VARIOUS	18	12	
PLOT SCALE = #SCALE#	CHECKED -	REVISED -	CONTRACT NO. 64135							
PLOT DATE = 6/24/2024	DATE -	REVISED -	SCALE:	SHEET NO. OF SHEETS	STA. TO STA.	FED. ROAD DIST. NO.	ILLINOIS FED. AID PROJECT			

**ENTRANCE SIGN FOR USE  
WITH TEMPORARY SIGNALS**

**WORK ZONE SIGN DETAILS**

②

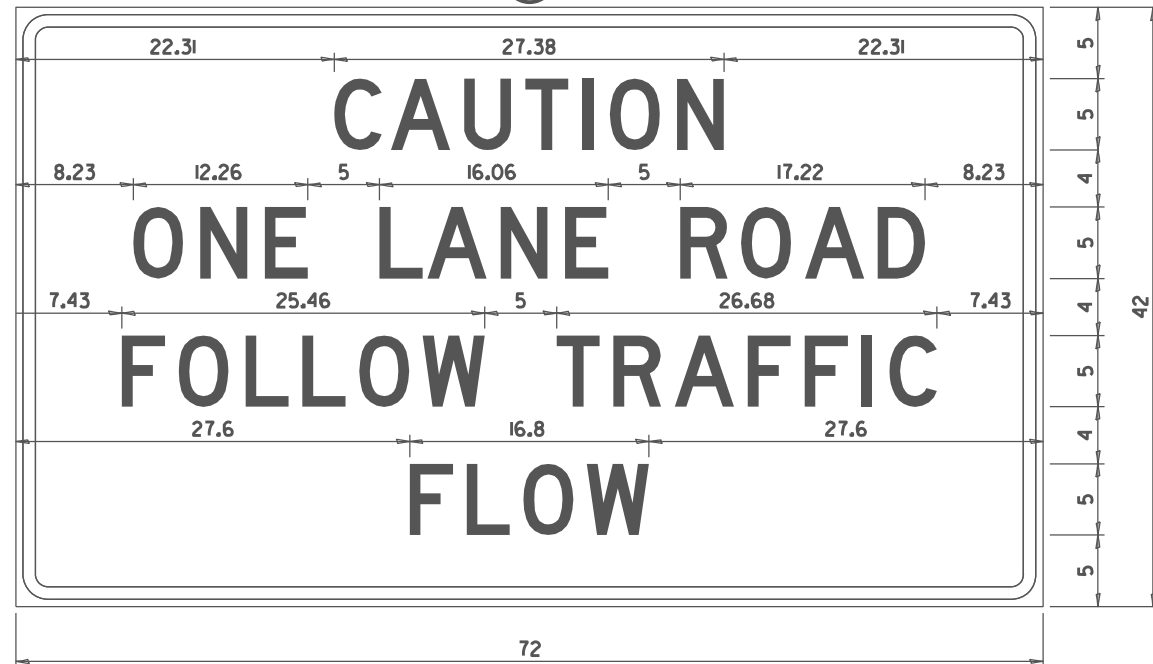

COLOR LEGEND AND BORDER BACKGROUND BLACK ORANGE NON-REFLECTORIZED REFLECTORIZED

2.25" Radius, 0.88" Border, 0.50" Indent;  
[CAUTION] D; [ONE LANE ROAD] D;  
[FOLLOW TRAFFIC] D; [FLOW] D

② This sign shall be installed at entrances located between the temporary signals as shown in the staging plans.

**Table Of Widths And Spaces**

22.31	C	3.36	0.62	A	4.18	0.94	U	3.36	0.94	T	3.04	0.94	I	0.78	1.17	O	3.52	1.17	N	3.36	22.31
-------	---	------	------	---	------	------	---	------	------	---	------	------	---	------	------	---	------	------	---	------	-------

8.23	O	3.51	1.17	N	3.36	1.18	E	3.04
------	---	------	------	---	------	------	---	------

5.00	L	3.05	0.31	A	4.18	0.94	N	3.36	1.17	E	3.05
------	---	------	------	---	------	------	---	------	------	---	------

5.00	R	3.36	0.93	O	3.52	0.94	A	4.18	0.93	D	3.36	8.23
------	---	------	------	---	------	------	---	------	------	---	------	------

7.43	F	3.04	0.94	O	3.52	1.17	L	3.04	0.94	L	3.05	0.94	O	3.51	0.94	W	4.37
------	---	------	------	---	------	------	---	------	------	---	------	------	---	------	------	---	------

5.00	T	3.05	0.94	R	3.36	0.94	A	4.18	0.93	F	3.05	0.94	F	3.04	0.94	I	0.78	1.18	C	3.35	7.43
------	---	------	------	---	------	------	---	------	------	---	------	------	---	------	------	---	------	------	---	------	------

27.60	F	3.05	0.94	L	3.04	0.94	O	3.52	0.93	W	4.38	27.60
-------	---	------	------	---	------	------	---	------	------	---	------	-------

Sign not to scale

**GENERAL NOTES**

All work to furnish and install these signs shall be included in the cost of the specified traffic control standards and shall not be paid separately.

All Illinois Standard signs shall conform to the latest edition of the "Illinois Standard Highway Signs Book" in effect on the date of invitation for bids.

Signs shall meet the applicable portions of Sections 701 and 720 of the Standard Specifications.

All dimensions are in inches unless otherwise noted.

**STAY IN YOUR LANE**

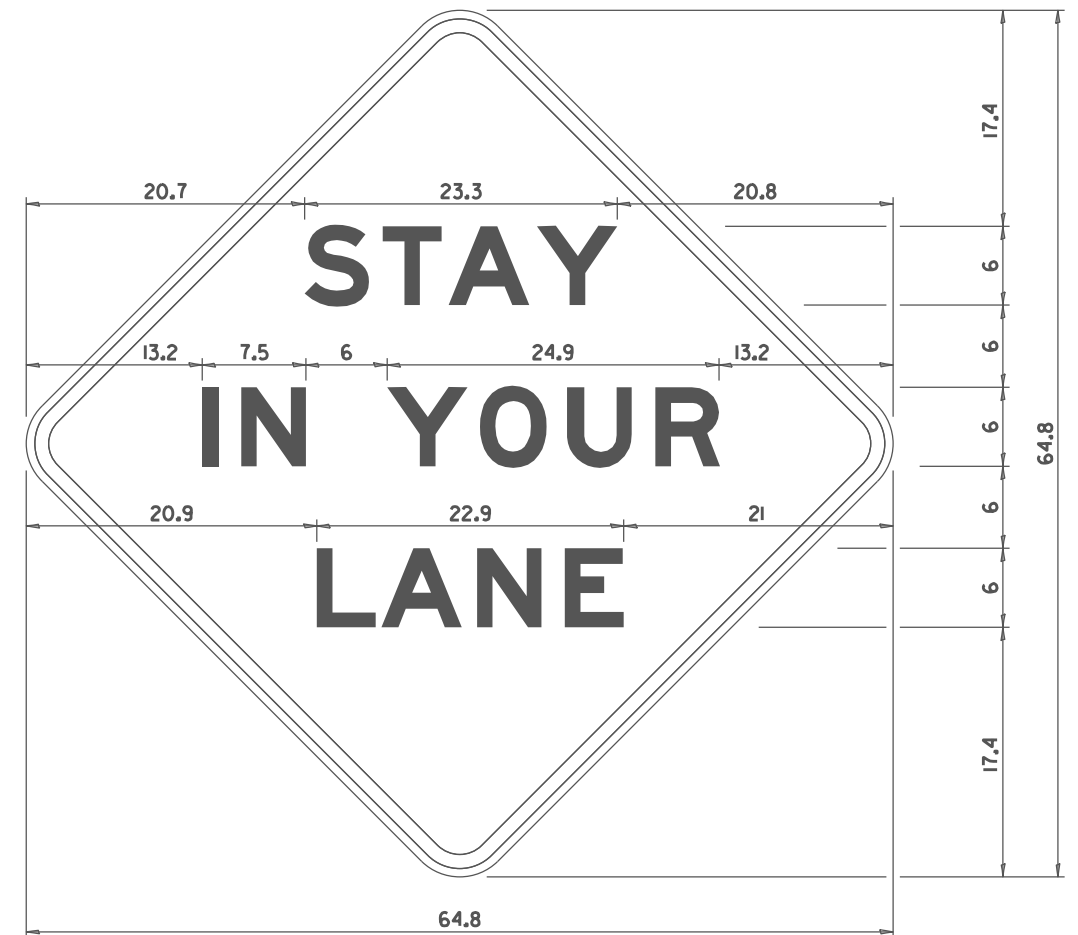

COLOR LEGEND AND BORDER BACKGROUND BLACK ORANGE NON-REFLECTORIZED REFLECTORIZED

48.0" across sides 3.8" Radius, 1.0" Border, 0.6" Indent;  
"STAY" E Mod; "IN YOUR" E Mod; "LANE" E Mod;

**Table of Letter and Object Lefts**

S	T	A	Y
20.7	26.8	31.6	38.0

I	N	Y	O	U	R
13.2	15.9	26.7	33.9	40.5	46.8

L	A	N	E
20.9	25.8	33.1	39.4

Sign not to scale

FILE NAME =	USER NAME = David.Doss	DESIGNED =	REVISED = 3-02-16	STATE OF ILLINOIS DEPARTMENT OF TRANSPORTATION	REGION 2 / DISTRICT 2 STANDARD	F.A. RTE.	SECTION	COUNTY	TOTAL SHEETS	SHEET NO.
pw:/idot-pw/bentley.com/PWIDOT/Documents/IDOT Offices/District 2/ORD Projects/Operations/Bridge Section/Bridge Washing Contract/January Letting/64135 Bridge Washing at various locations (S&T) 64135-1.c	DRAWN =	REVISION =	VAR.			D2 BC 2025-02	VARIOUS	18	13	
PLOT SCALE = #SCALE#	CHECKED =	REVISED =	CONTRACT NO. 64135							
PLOT DATE = 6/24/2024	DATE =	REVISED =	SCALE:			SHEET NO. OF SHEETS	STA. TO STA.	FED. ROAD DIST. NO.	ILLINOIS FED. AID PROJECT	

# URBAN LANE INSIDE CLOSURE, MULTILANE, 2-WAY, WITH MOUNTABLE MEDIAN

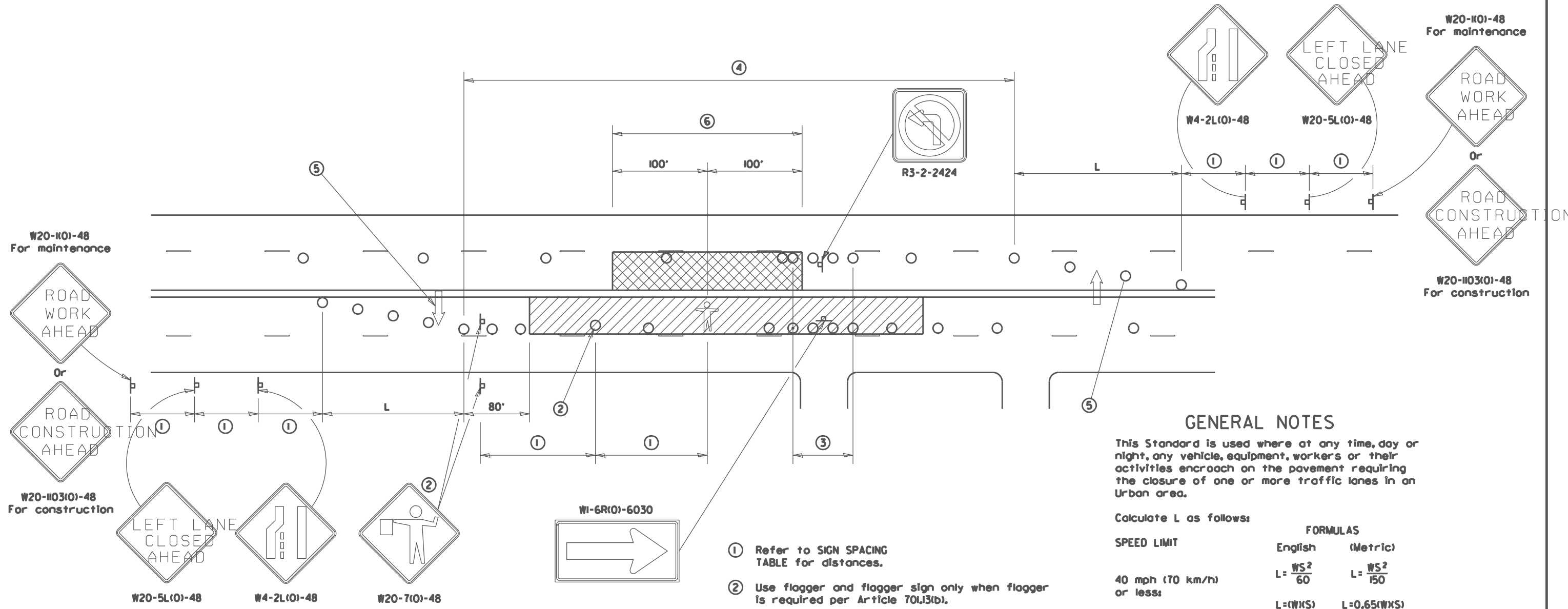

## GENERAL NOTES

This Standard is used where at any time, day or night, any vehicle, equipment, workers or their activities encroach on the pavement requiring the closure of one or more traffic lanes in an Urban area.

Calculate L as follows:

SPEED LIMIT

FORMULAS

SPEED LIMIT	English	(Metric)
40 mph (70 km/h) or less:	$L = \frac{WS^2}{60}$	$L = \frac{WS^2}{150}$
45 mph (80 km/h) or greater:	$L = (W)(S)$	$L = 0.65(W)(S)$

W = Width of offset in feet (meters).

S = Normal posted speed mph (km/h).

All dimensions are in inches (millimeters) unless otherwise shown.

Lane closures in the opposite direction shall be removed when no workers are present.

Cones or reflectorized cones shall not be used during hours of darkness.

This Traffic Control detail shall be included in the cost of Traffic Control and Protection Standard 701606.

## SYMBOLS

- WORK AREA
- CLOSED LANE
- ARROW BOARD
- SIGN ON PORTABLE OR PERMANENT SUPPORT
- CONE, DRUM OR BARRICADE
- FLAGGER WITH TRAFFIC CONTROL SIGN.
- WORKER ON FOOT

SIGN SPACING	
Posted Speed	Sign Spacing
55	500' (150 m)
50-45	350' (100 m)
<45	200' (60 m)

- ① Refer to SIGN SPACING TABLE for distances.
- ② Use flagger and flagger sign only when flagger is required per Article 701.13(b).
- ③ Devices at 10' centers from edge of radius return to edge of radius return when left turns are prohibited due to actively working in the intersection.
- ④ Cones at 20' (6 m) centers for 250' (75 m). Additional cones may be placed at 40' (12 m) centers. When drums or Type I or Type II barricades are used, the interval between devices may be doubled (excluding devices in intersections).
- ⑤ Cones, drums or barricades at 20' (6 m) centers in taper.
- ⑥ No equipment, materials, vehicles, or other hazards are allowed in the closed lane in the opposite direction within 100' of a worker on foot.

# TRAFFIC CONTROL FOR TRANSITION AREAS

## CASE 1

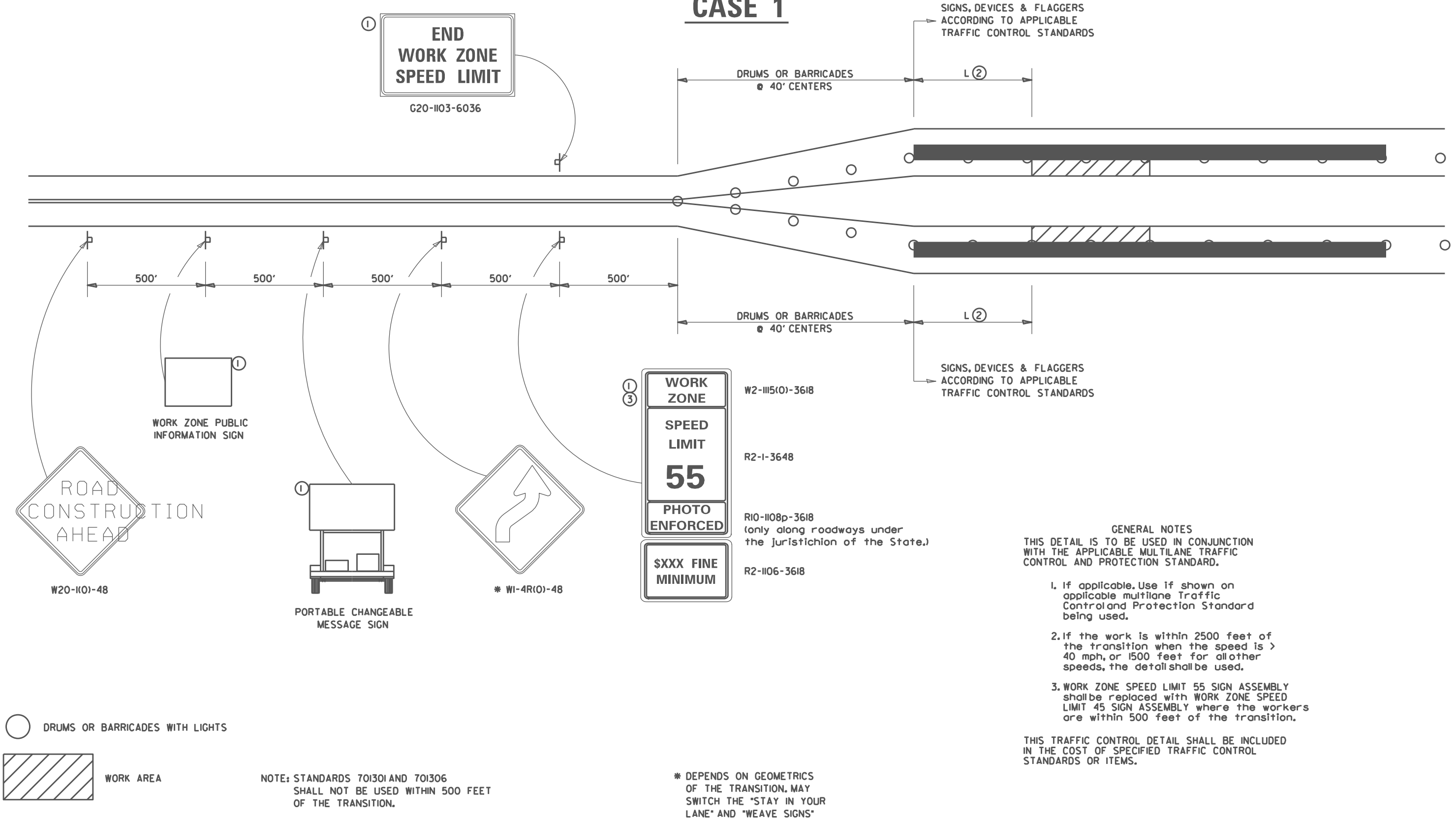

FILE NAME =	USER NAME = David.Doss	DESIGNED -	REVISED - 4-20-17	STATE OF ILLINOIS DEPARTMENT OF TRANSPORTATION	REGION 2 / DISTRICT 2 STANDARD			F.A. RTE.	SECTION	COUNTY	TOTAL SHEETS	SHEET NO.		
pw:/idot-pw.bentley.com/PWIDOT/Documents/IDOT Offices/District 2/ORD Projects/Operations/Bridge Section/Bridge Washing Control/January 2016/64135 Bridge Washing at various locations (64135) - c		DRAWN	REVISED - 1-16-16		SCALE:	SHEET NO.	OF SHEETS	STA.	TO STA.	VAR.	D2 BC 2025-02	VARIOUS	18	15
		CHECKED -	REVISED - 8-27-13		CONTRACT NO. 64135			FED. ROAD DIST. NO.	ILLINOIS	FED. AID PROJECT				
		DATE -	REVISED - 1-16-13											

# TRAFFIC CONTROL FOR TRANSITION AREAS

## CASE 2

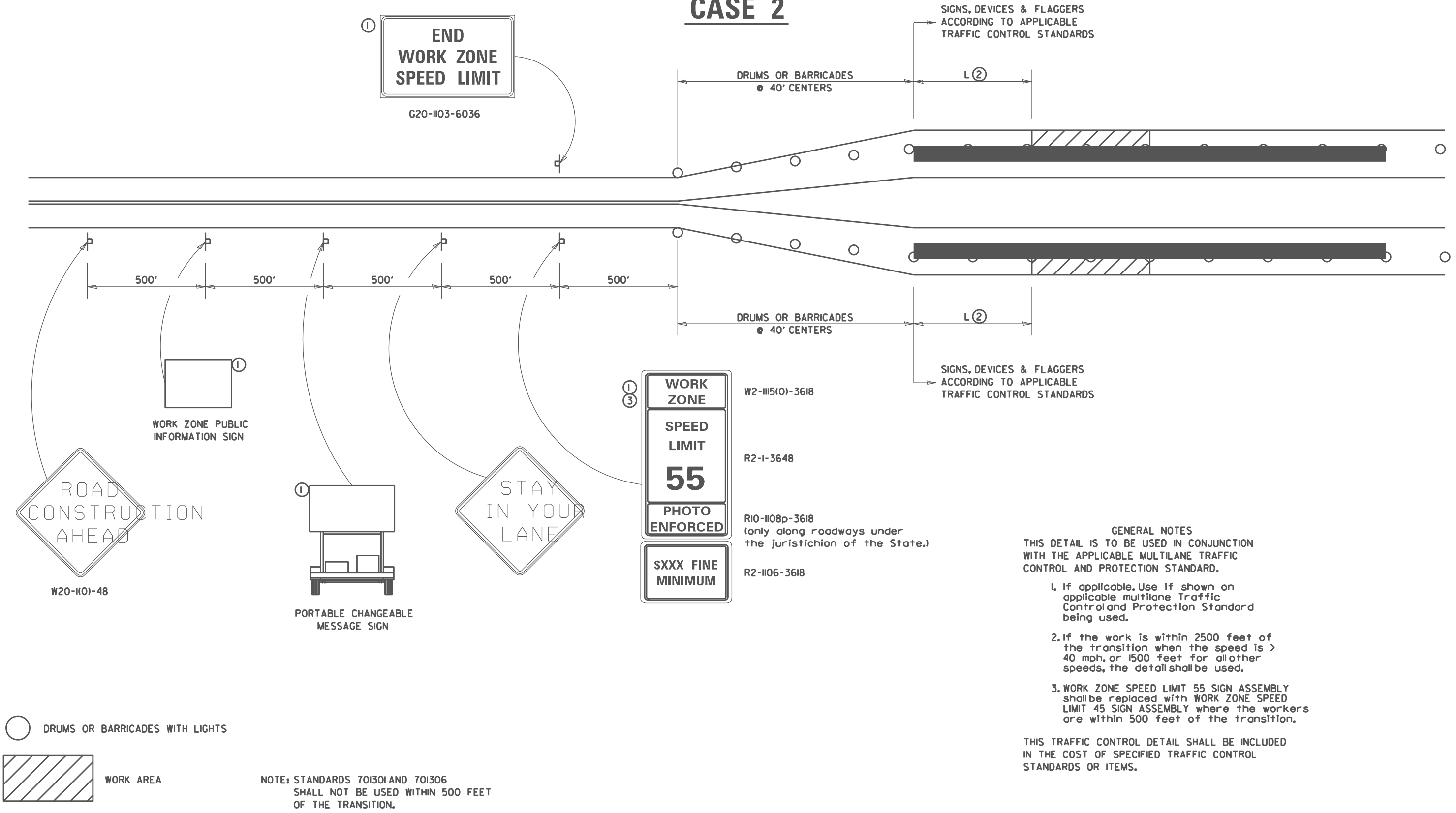

- GENERAL NOTES**
- THIS DETAIL IS TO BE USED IN CONJUNCTION WITH THE APPLICABLE MULTILANE TRAFFIC CONTROL AND PROTECTION STANDARD.
1. If applicable, use if shown on applicable multilane Traffic Control and Protection Standard being used.
  2. If the work is within 2500 feet of the transition when the speed is > 40 mph, or 1500 feet for all other speeds, the detail shall be used.
  3. WORK ZONE SPEED LIMIT 55 SIGN ASSEMBLY shall be replaced with WORK ZONE SPEED LIMIT 45 SIGN ASSEMBLY where the workers are within 500 feet of the transition.

THIS TRAFFIC CONTROL DETAIL SHALL BE INCLUDED IN THE COST OF SPECIFIED TRAFFIC CONTROL STANDARDS OR ITEMS.

FILE NAME =	USER NAME = David.Doss	DESIGNED -	REVISED - 4-20-17	STATE OF ILLINOIS DEPARTMENT OF TRANSPORTATION	REGION 2 / DISTRICT 2 STANDARD			F.A. RTE.	SECTION	COUNTY	TOTAL SHEETS	SHEET NO.		
pw:/idot-pw.bentley.com/PWIDOT/Documents/IDOT Offices/District 2/ORD Projects/Operations/Bridge Section/Bridge Washing Cont...		DRAWN	REVISED - 1-16-13		SCALE:	SHEET NO. OF	SHEETS	STA.	TO STA.	VAR.	D2 BC 2025-02	VARIOUS	18	16
		CHECKED	REVISED - 8-27-13		CONTRACT NO. 64135									
		DATE	REVISED - 1-16-13		FED. ROAD DIST. NO. ILLINOIS FED. AID PROJECT									



# TRAFFIC CONTROL FOR TRANSITION AREAS

## CASE 3

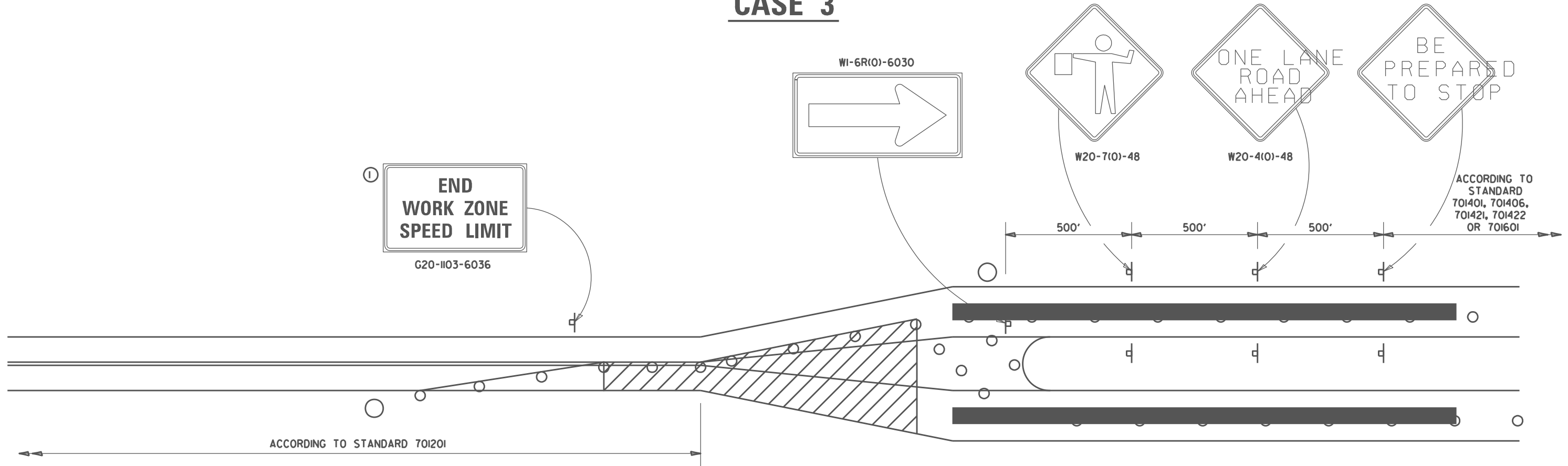

**GENERAL NOTES**

THIS DETAIL IS TO BE USED IN CONJUNCTION WITH THE APPLICABLE MULTILANE TRAFFIC CONTROL AND PROTECTION STANDARD.

1. If applicable, Use if shown on applicable multilane Traffic Control and Protection Standard being used.
2. If the work is within 2500 feet of the transition when the speed is > 40 mph, or 1500 feet for all other speeds, the detail shall be used.
3. WORK ZONE SPEED LIMIT 55 SIGN ASSEMBLY shall be replaced with WORK ZONE SPEED LIMIT 45 SIGN ASSEMBLY where the workers are within 500 feet of the transition.

THIS TRAFFIC CONTROL DETAIL SHALL BE INCLUDED IN THE COST OF SPECIFIED TRAFFIC CONTROL STANDARDS OR ITEMS.

- FLAGGER WITH TRAFFIC CONTROL SIGN
- DRUMS OR BARRICADES WITH LIGHTS
- WORK AREA

NOTE: STANDARDS 701301 AND 701306 SHALL NOT BE USED WITHIN 500 FEET OF THE TRANSITION.

FILE NAME =	USER NAME = David.Doss	DESIGNED -	REVISED - 4-20-17	STATE OF ILLINOIS DEPARTMENT OF TRANSPORTATION	REGION 2 / DISTRICT 2 STANDARD			F.A. RTE.	SECTION	COUNTY	TOTAL SHEETS	SHEET NO.	
DRAWN -					SCALE:				VAR.	D2 BC 2025-02	VARIOUS	18	17
PLOT SCALE = #SCALE#					SHEET NO. OF SHEETS STA. TO STA.				CONTRACT NO. 64135				
PLOT DATE = 6/24/2024				DATE				FED. ROAD DIST. NO. ILLINOIS FED. AID PROJECT					

# TRAFFIC CONTROL FOR TRANSITION AREAS

## CASE 4

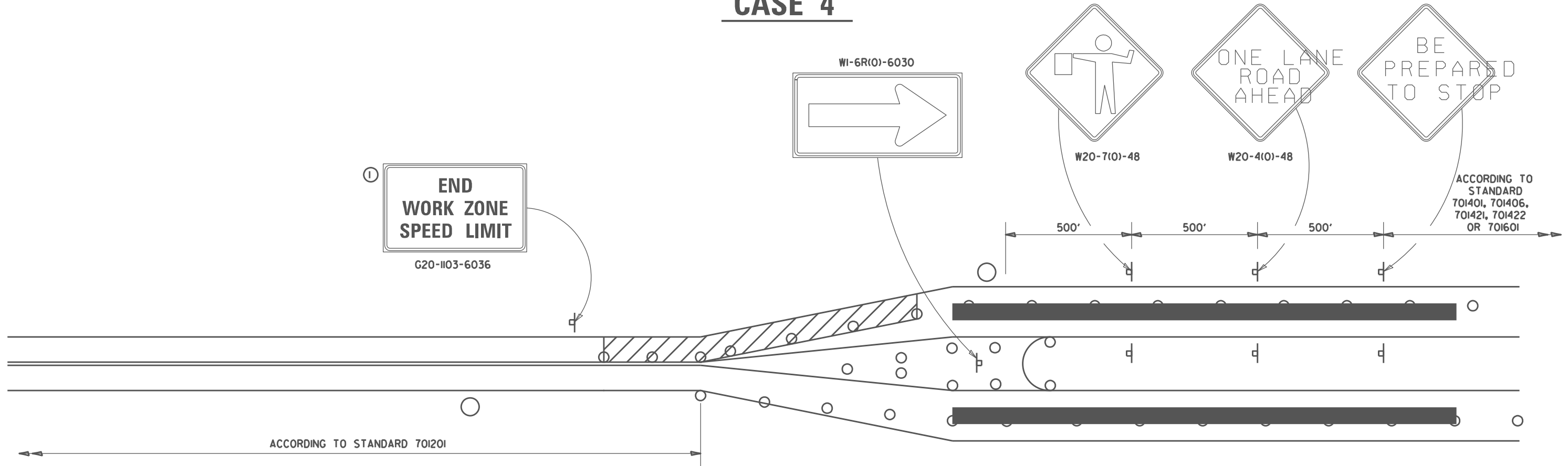

**GENERAL NOTES**

THIS DETAIL IS TO BE USED IN CONJUNCTION WITH THE APPLICABLE MULTILANE TRAFFIC CONTROL AND PROTECTION STANDARD.

1. If applicable, Use if shown on applicable multilane Traffic Control and Protection Standard being used.
2. If the work is within 2500 feet of the transition when the speed is > 40 mph, or 1500 feet for all other speeds, the detail shall be used.
3. WORK ZONE SPEED LIMIT 55 SIGN ASSEMBLY shall be replaced with WORK ZONE SPEED LIMIT 45 SIGN ASSEMBLY where the workers are within 500 feet of the transition.

THIS TRAFFIC CONTROL DETAIL SHALL BE INCLUDED IN THE COST OF SPECIFIED TRAFFIC CONTROL STANDARDS OR ITEMS.

- FLAGGER WITH TRAFFIC CONTROL SIGN
- DRUMS OR BARRICADES WITH LIGHTS
- WORK AREA

NOTE: STANDARDS 701301 AND 701306 SHALL NOT BE USED WITHIN 500 FEET OF THE TRANSITION.

FILE NAME :	USER NAME = David.Doss	DESIGNED -	REVISED - 4-20-17	STATE OF ILLINOIS DEPARTMENT OF TRANSPORTATION	REGION 2 / DISTRICT 2 STANDARD	F.A. RTE.	SECTION	COUNTY	TOTAL SHEETS	SHEET NO.	
		DRAWN	REVISED - 1-10-16				VAR.	D2 BC 2025-02	VARIOUS	18	18
		CHECKED -	REVISED - 8-27-13				CONTRACT NO. 64135				
		DATE	REVISED - 3-05-12			SCALE:	SHEET NO. OF	SHEETS	STA.	TO STA.	FED. ROAD DIST. NO.