

F.A.P. RTE.	SECTION	COUNTY	TOTAL SHEETS	SHEET NO.
336	112 R-N-1	MCHENRY	31	1

STATE OF ILLINOIS
DEPARTMENT OF TRANSPORTATION
DIVISION OF HIGHWAYS

**PROPOSED
HIGHWAY PLANS**

F.A.P. 336 : ILL ROUTE 31
AT CRYSTAL LAKE AVENUE
SECTION: 112 R-N-1

**TRAFFIC SIGNAL MODERNIZATION, MEDIAN BARRIER, RESURFACING (3P)
MCHENRY COUNTY
PROJECT: ACHSIP-0336(046)
C-91-034-08**

FOR INDEX OF SHEETS, SEE SHEET NO. 2

PROJECT LOCATED IN
THE CITY OF CRYSTAL LAKE

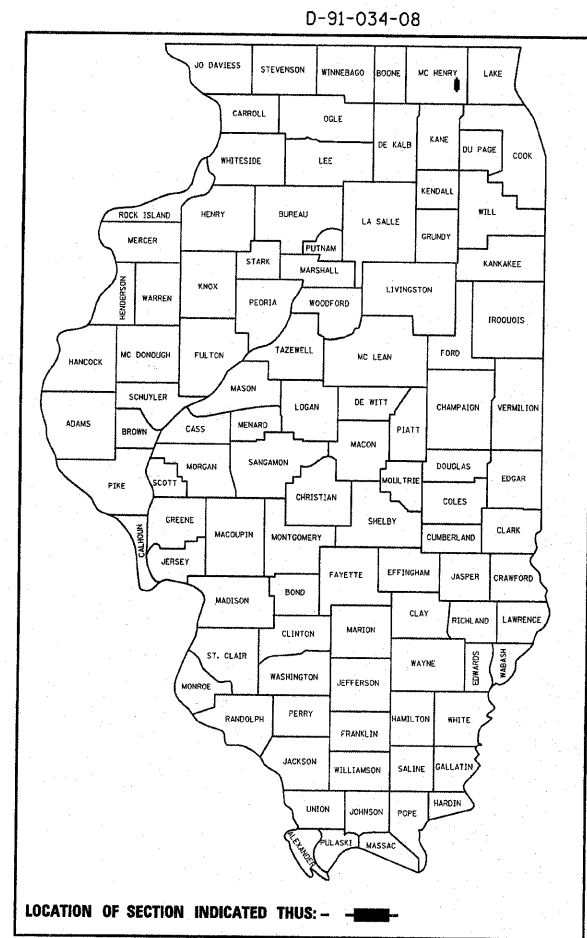

DISTRICT 1 DESIGN PLAN PREPARATION ENGINEER: KEN ENG / LONG TRAN (847) 705-4240

**IL 31
PROJECT ENDS
STATION 21+59**

**CRYSTAL LAKE AVENUE
PROJECT BEGINS
STATION 7+92**

**IL 31
PROJECT BEGINS
STATION 9+23**

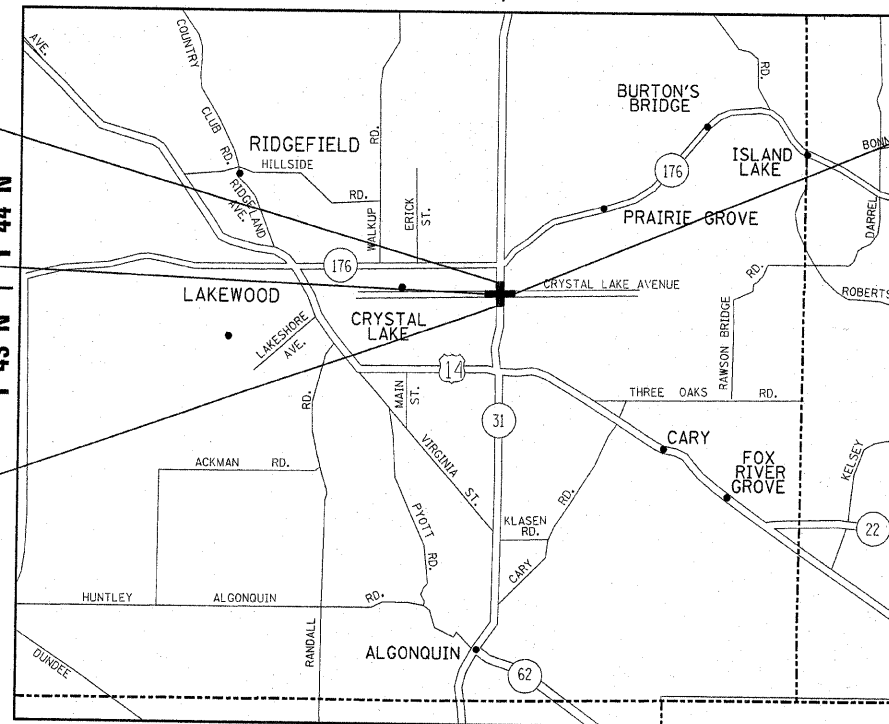

**CRYSTAL LAKE AVENUE
PROJECT ENDS
STATION 21+82**

TRAFFIC DATA
2005 ADT = 31,000
POSTED SPEED LIMIT = 40 MPH



**MAP SCALE
NOT TO SCALE**

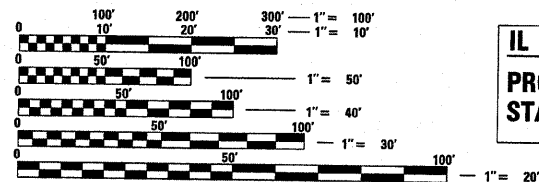

FULL SIZE PLANS HAVE BEEN PREPARED USING STANDARD ENGINEERING SCALES. REDUCED SIZED PLANS WILL NOT CONFORM TO STANDARD SCALES. IN MAKING MEASUREMENTS ON REDUCED PLANS, THE ABOVE SCALES MAY BE USED.

J.U.L.I.E.
JOINT UTILITY LOCATION INFORMATION FOR EXCAVATION
1-800-892-0123

CONTRACT NO. 60D52

ALGONQUIN AND NUNDA TOWNSHIPS

(IL 31) GROSS & NET LENGTH OF PROJECT = 1,237 LINEAL FEET = 0.23 MILE
(CRYSTAL LAKE AVENUE) GROSS & NET LENGTH OF PROJECT = 1,390 LINEAL FEET = 0.26 MILE

STATE OF ILLINOIS
DEPARTMENT OF TRANSPORTATION
DIVISION OF HIGHWAYS

SUBMITTED October 25, 2007

Diane O'Keefe
DEPUTY DIRECTOR OF HIGHWAYS, REGION ENGINEER
December 7, 2007

Eric E. Haran
ENGINEER OF DESIGN AND ENVIRONMENT
December 7, 2007

Christine M. Reed
DIRECTOR OF HIGHWAYS, CHIEF ENGINEER

**PRINTED BY THE AUTHORITY
OF THE STATE OF ILLINOIS**

INDEX OF SHEETS

STATE STANDARDS

GENERAL NOTES

<u>DESCRIPTION</u>	<u>STANDARD NO.</u>	<u>DESCRIPTION</u>
2 INDEX OF SHEETS, STATE STANDARDS, PLAN NOTES AND MIXTURE REQUIREMENTS	000001-05	STANDARD SYMBOLS, ABBREVIATIONS AND PATTERNS
3 - 4 SUMMARY OF QUANTITIES	442201-03	CLASS C AND D PATCHES
5 - 7 TYPICAL SECTIONS	606301-03	PC CONCRETE ISLANDS AND MEDIANS
8 - 11 ROADWAY AND PAVEMENT MARKING PLANS	701501-04	URBAN LANE CLOSURE, 2L, 2W, UNDIVIDED
12 - 20 TRAFFIC SIGNAL PLANS	701601-05	URBAN LANE CLOSURE MULTILANE 1W OR 2W WITH NONTRAVERSABLE MEDIAN
21 DETAILS FOR FRAMES AND LIDS ADJUSTMENT WITH MILLING	701701-05	URBAN LANE CLOSURE MULTILANE INTERSECTION
22 PAVEMENT PATCHING FOR HMA SURFACED PAVEMENT	701901	TRAFFIC CONTROL DEVICES
23 CURB OR CURB AND GUTTER REMOVAL AND REPLACEMENT		
24 BUTT JOINT AND HMA TAPER DETAILS		
25 TRAFFIC CONTROL AND PROTECTION FOR SIDE ROADS, INTERSECTIONS, AND DRIVEWAYS		
26 TYPICAL APPLICATIONS RAISED REFLECTIVE PAVEMENT MARKERS (SNOW-PLOW RESISTANT)		
27 DISTRICT ONE TYPICAL PAVEMENT MARKINGS		
28 TRAFFIC CONTROL AND PROTECTION AT TURN BAYS (TO REMAIN OPEN TO TRAFFIC)		
29 PAVEMENT MARKING LETTERS AND SYMBOLS FOR TRAFFIC STAGING		
30 ARTERIAL ROAD INFORMATION SIGN		
31 DISTRICT ONE DETECTOR LOOP INSTALLATION DETAILS FOR ROADWAY RESURFACING		

BEFORE STARTING ANY EXCAVATION, THE CONTRACTOR SHALL CALL "JULIE" AT 800-892-0123 FOR FIELD LOCATIONS OF BURIED ELECTRIC, TELEPHONE AND GAS FACILITIES. (48 HOUR NOTIFICATION IS REQUIRED)

THE CONTRACTOR SHALL COORDINATE CONSTRUCTION ACTIVITIES WITH UTILITY COMPANIES AND THE CITY OF CRYSTAL LAKE.

THE CONTRACTOR SHALL CONTACT THE DISTRICT ONE TRAFFIC CONTROL SUPERVISOR AT (847) 705-4470 A MINIMUM OF 72 HOURS PRIOR TO BEGINNING WORK.

THE CONTRACTOR WILL NOT BE ALLOWED TO SET UP A YARD OR FIELD OFFICE ON STATE PROPERTY WITHOUT WRITTEN PERMISSION FROM THE DEPARTMENT.

BUTT JOINTS WILL BE INSTALLED AT THE ENDS OF ALL RESURFACING (WHERE RESURFACING MEETS EXISTING PAVEMENT), IN ACCORDANCE WITH THE "BUTT JOINT AND HOT-MIX ASPHALT TAPER DETAILS" SHEETS INCLUDED IN THE PLANS, UNLESS OTHERWISE SPECIFIED.

THE RESIDENT ENGINEER SHALL CONTACT MS. DEBBIE HANLON AREA TRAFFIC FIELD ENGINEER AT (847) 438-2300 A MINIMUM OF 2 WEEKS PRIOR TO PLACEMENT OF PERMANENT PAVEMENT MARKING.

10 FEET (3 METERS) TRANSITION SHALL BE USED TO MATCH PROPOSED CURB AND GUTTER TO EXISTING CURB AND GUTTERS AND MEDIANS ITEMS OF WORK TO EXISTING CURBS AND GUTTERS AND MEDIANS IN THE FIELD, UNLESS OTHERWISE SHOWN. THE TRANSITION SHALL BE PAID FOR AT THE CONTRACT UNIT PRICE FOR THE PROPOSED ITEMS OR WORK SPECIFIED.

WHEN MILLED PAVEMENT IS OPEN TO TRAFFIC THE MAXIMUM GRADE DIFFERENTIAL BETWEEN PASSES OF THE MILLING MACHINE SHALL NOT EXCEED 1 1/2 INCHES (40MM) WHERE THE SPEED LIMIT IS 45 MPH (80 KM/H) OR LESS AND 1 INCH (25 MM) WHERE THE SPEED LIMIT IS GREATER THAN 45 MPH (80 KM/H). WITH WRITTEN APPROVAL FROM THE ENGINEER, A MAXIMUM GRADE DIFFERENTIAL OF 3 INCHES (75 MM) MAY BE ALLOWED IF THE EDGE OF THE MILLING IS SLOPED A MINIMUM 1:3 (V:H).

FILE NAME = c:\projects\dl03488\design.ae.dgn	USER NAME = osmanhm	DESIGNED -	REVISED -	STATE OF ILLINOIS DEPARTMENT OF TRANSPORTATION	IL 31 INDEX OF SHEETS, STATE STANDARDS & GENERAL NOTES	F.A.P. RTE. 336	SECTION 112 R-N-1	COUNTY McHenry	TOTAL SHEETS 31	SHEET NO. 2	
	PLOT SCALE = 50.0000' / IN.	DRAWN -	REVISED -			SCALE:	SHEET NO. OF SHEETS	STA.	TO STA.	FED. ROAD DIST. NO.	ILLINOIS FED. AID PROJECT
	PLOT DATE = 10/25/2007	CHECKED -	REVISED -			CONTRACT NO. 60D52					
		DATE -	REVISED -								

F.A.P. RTE.	SECTION	COUNTY	TOTAL SHEETS	SHEET NO.
336	112 R-N-1	McHenry	31	3
FED. ROAD DIST. NO. 1		ILLINOIS	HIGHWAY PROJECT	

SUMMARY OF QUANTITIES			CONSTRUCTION TYPE CODE						
CODE NO	ITEM	UNIT	TOTAL QUANTITIES	90% FED 10% STATE 1000-2A	90% FED 10% STATE Y031-1F				
* X0325890	REOPTIMIZE TRAFFIC SIGNAL SYSTEM LEVEL 1	EACH	1		1				
X0325891	IMPACT ATTENUATORS (FULLY REDIRECTIVE, RESETTABLE), TEST LEVEL 2	EACH	1	1					
20200100	EARTH EXCAVATION	CU YD	259	259					
31101400	SUB-BASE GRANULAR MATERIAL, TYPE B 6"	SQ YD	844	844					
35300600	PORTLAND CEMENT CONCRETE BASE COURSE 11"	SQ YD	844	844					
40300200	BITUMINOUS MATERIALS (PRIME COAT)	TON	6	6					
40600300	AGGREGATE (PRIME COAT)	TON	31	31					
40600400	MIXTURE FOR CRACKS, JOINTS, AND FLANGWAYS	TON	5	5					
40600635	LEVELING BINDER (MACHINE METHOD), N70	TON	655	655					
40600895	CONSTRUCTING TEST STRIP	EACH	2	2					
40600982	HOT-MIX ASPHALT SURFACE REMOVAL - BUTT JOINT	SQ YD	155	155					
40603340	HOT-MIX ASPHALT SURFACE COURSE, MIX "D", N70	TON	613	613					
40603595	POLYMERIZED HOT-MIX ASPHALT SURFACE COURSE, MIX "F", N90	TON	814	814					
42001300	PROTECTIVE COAT	SQ YD	834	834					
44000158	HOT-MIX ASPHALT SURFACE REMOVAL, 2 1/4"	SQ YD	8301	8301					
44000159	HOT-MIX ASPHALT SURFACE REMOVAL, 2 1/2"	SQ YD	7300	7300					
44000500	COMBINATION CURB AND GUTTER REMOVAL	FOOT	972	972					
44001700	COMBINATION CONCRETE CURB AND GUTTER REMOVAL AND REPLACEMENT	FOOT	1050	1050					
44003100	MEDIAN REMOVAL	SQ FT	13790	13790					
44201777	CLASS D PATCHES, TYPE II, 11 INCH	SQ YD	129	129					
44300200	STRIP REFLECTIVE CRACK CONTROL TREATMENT	FOOT	10998	10998					
48102100	AGGREGATE WEDGE SHOULDER, TYPE B	TON	40	40					
60619600	CONCRETE MEDIAN, TYPE SB-6.12	SQ FT	10232	10232					
63200310	GUARDRAIL REMOVAL	FOOT	30	30					
67000400	ENGINEER'S FIELD OFFICE, TYPE A	CAL MO	6	6					
67100100	MOBILIZATION	L SUM	1	1					

SUMMARY OF QUANTITIES			CONSTRUCTION TYPE CODE						
CODE NO	ITEM	UNIT	TOTAL QUANTITIES	90% FED 10% STATE 1000-2A	90% FED 10% STATE Y031-1F				
70102620	TRAFFIC CONTROL AND PROTECTION, STANDARD 701501	L SUM	1	1					
70102630	TRAFFIC CONTROL AND PROTECTION, STANDARD 701601	L SUM	1	1					
70102635	TRAFFIC CONTROL AND PROTECTION, STANDARD 701701	L SUM	1	1					
70300100	SHORT-TERM PAVEMENT MARKING	FOOT	1140	1140					
70300210	TEMPORARY PAVEMENT MARKING - LETTERS AND SYMBOLS	SQ FT	510	510					
70300220	TEMPORARY PAVEMENT MARKING - LINE 4"	FOOT	5450	5450					
70300240	TEMPORARY PAVEMENT MARKING - LINE 6"	FOOT	1107	1107					
70301000	WORK ZONE PAVEMENT MARKING REMOVAL	SQ FT	380	380					
* 78000100	THERMOPLASTIC PAVEMENT MARKING - LETTERS AND SYMBOLS	SQ FT	510	510					
* 78000200	THERMOPLASTIC PAVEMENT MARKING - LINE 4"	FOOT	5450	5450					
* 78000400	THERMOPLASTIC PAVEMENT MARKING - LINE 6"	FOOT	1107	1107					
* 78000650	THERMOPLASTIC PAVEMENT MARKING - LINE 24"	FOOT	167	167					
* 78100100	RAISED REFLECTIVE PAVEMENT MARKER	EACH	66	66					
78300200	RAISED REFLECTIVE PAVEMENT MARKER REMOVAL	EACH	66	66					
81000600	CONDUIT IN TRENCH, 2" DIA., GALVANIZED STEEL	FOOT	490		490				
81000700	CONDUIT IN TRENCH, 2 1/2" DIA., GALVANIZED STEEL	FOOT	41		41				
81001100	CONDUIT IN TRENCH, 5" DIA., GALVANIZED STEEL	FOOT	10		10				
* 81018500	CONDUIT PUSHED, 2" DIA., GALVANIZED STEEL	FOOT	95		95				
81018900	CONDUIT PUSHED, 4" DIA., GALVANIZED STEEL	FOOT	430		430				
81400100	HANDHOLE	EACH	5		5				
81400200	HEAVY-DUTY HANDHOLE	EACH	2		2				
81400300	DOUBLE HANDHOLE	EACH	1		1				

* SPECIALTY ITEM

REVISIONS	
NAME	DATE

ILLINOIS DEPARTMENT OF TRANSPORTATION
SUMMARY OF QUANTITIES
ILL 31 @ CRYSTAL LAKE AVENUE

10/25/2007
 publicworks\10103098\ill31@crystal_ave.dwg

F.A.P. RTE.	SECTION	COUNTY	TOTAL SHEETS	SHEET NO.
336	112 R-N-1	McHenry	31	4
FED. ROAD DIST. NO. 1		ILLINOIS	HIGHWAY PROJECT	

SUMMARY OF QUANTITIES			TOTAL QUANTITIES	CONSTRUCTION TYPE CODE					
CODE NO	ITEM	UNIT		90% FED 10% STATE 1000-2A	90% FED 10% STATE Y031-1F				
81900200	TRENCH AND BACKFILL FOR ELECTRICAL WORK	FOOT	541		541				
85000200	MAINTENANCE OF EXISTING TRAFFIC SIGNAL INSTALLATION	EACH	1		1				
85700205	FULL-ACTUATED CONTROLLER AND TYPE IV CABINET, SPECIAL	EACH	1		1				
85900100	TRANSCEIVER	EACH	1		1				
87301225	ELECTRIC CABLE IN CONDUIT, SIGNAL NO. 14 3C	FOOT	300		300				
87301245	ELECTRIC CABLE IN CONDUIT, SIGNAL NO. 14 5C	FOOT	768		768				
87301255	ELECTRIC CABLE IN CONDUIT, SIGNAL NO. 14 7C	FOOT	3459		3459				
87301305	ELECTRIC CABLE IN CONDUIT, LEAD-IN, NO. 14 1 PAIR	FOOT	1718		1718				
87301805	ELECTRIC CABLE IN CONDUIT, SERVICE, NO. 6 2 C	FOOT	25		25				
87502520	TRAFFIC SIGNAL POST, GALVANIZED STEEL 18 FT.	EACH	4		4				
87700250	STEEL MAST ARM ASSEMBLY AND POLE, 42 FT.	EACH	4		4				
87800150	CONCRETE FOUNDATION, TYPE C	FOOT	4		4				
87800415	CONCRETE FOUNDATION, TYPE E 36-INCH DIAMETER	FOOT	60		60				
87900200	DRILL EXISTING HANDHOLE	EACH	2		2				
88030020	SIGNAL HEAD, LED, 1-FACE, 3-SECTION, MAST-ARM MOUNTED	EACH	4		4				
88030100	SIGNAL HEAD, LED, 1-FACE, 5-SECTION, BRACKET MOUNTED	EACH	4		4				
88030110	SIGNAL HEAD, LED, 1-FACE, 5-SECTION, MAST-ARM MOUNTED	EACH	4		4				
88200210	TRAFFIC SIGNAL BACKPLATE, LOUVERED, ALUMINUM	EACH	8		8				
88500100	INDUCTIVE LOOP DETECTOR	EACH	12		12				
89000100	TEMPORARY TRAFFIC SIGNAL INSTALLATION	EACH	1		1				
89502300	REMOVE ELECTRIC CABLE FROM CONDUIT	FOOT	2785		2785				
89502375	REMOVE EXISTING TRAFFIC SIGNAL EQUIPMENT	EACH	1		1				
89502380	REMOVE EXISTING HANDHOLE	EACH	8		8				

SUMMARY OF QUANTITIES			TOTAL QUANTITIES	CONSTRUCTION TYPE CODE					
CODE NO	ITEM	UNIT		90% FED 10% STATE 1000-2A	90% FED 10% STATE Y031-1F				
* 89502385	REMOVE EXISTING CONCRETE FOUNDATION	EACH	9		9				
* X0322256	TEMPORARY INFORMATION SIGNING	SQ FT	103	103					
* X0322925	ELECTRIC CABLE IN CONDUIT, TRACER, NO. 14 1C	FOOT	2785		2785				
X4420156	CLASS D PATCHES, TYPE II, 15 1/4 INCH	SQ YD	193	193					
X8050015	SERVICE INSTALLATION - POLE MOUNTED	EACH	1		1				
X8620020	UNINTERRUPTIBLE POWER SUPPLY	EACH	1		1				
* X8710020	FIBER OPTIC CABLE IN CONDUIT, NO. 62.5/125, MM12F SM12F	FOOT	2785		2785				
* X8730250	ELECTRIC CABLE IN CONDUIT NO. 20 3/C, TWISTED, SHIELDED	FOOT	300		300				
* Z0018500	DRAINAGE STRUCTURES TO BE CLEANED	EACH	11	11					

* SPECIALTY ITEM
NP = NON-PARTICIPATING

REVISIONS	
NAME	DATE

ILLINOIS DEPARTMENT OF TRANSPORTATION
SUMMARY OF QUANTITIES
ILL 31 @ CRYSTAL LAKE AVENUE

10/25/2007

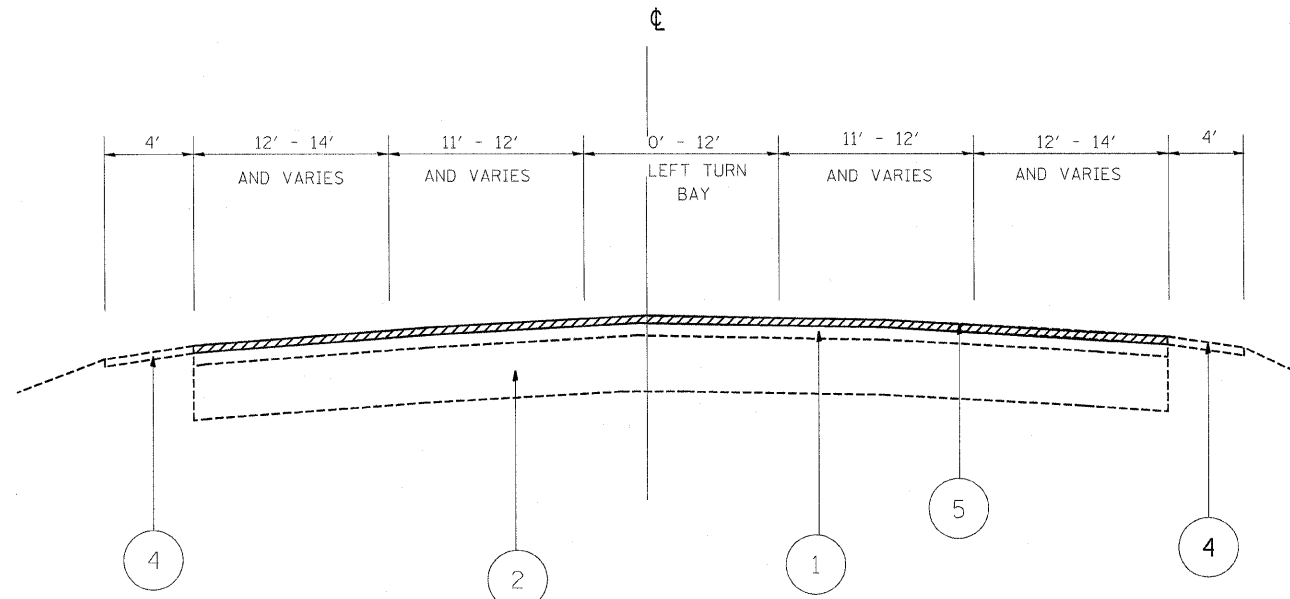

CRYSTAL LAKE AVENUE
EXISTING TYPICAL SECTION
 STA. 7+92 TO STA. 13+48

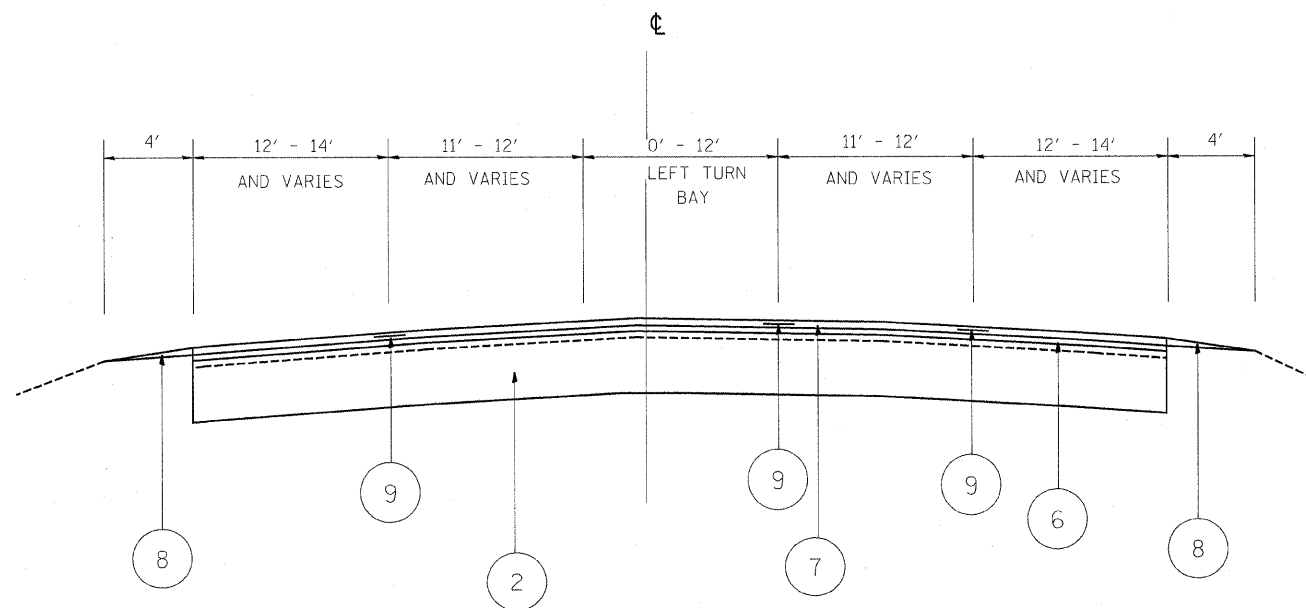

CRYSTAL LAKE AVENUE
PROPOSED TYPICAL SECTION
 STA. 13+48 TO STA. 21+82

- LEGEND
- ① EXISTING HOT-MIX ASPHALT SURFACE, 3" ±
 - ② EXISTING HOT-MIX ASPHALT BASE COURSE, 8" ±
 - ③ EXISTING CONCRETE CURB AND GUTTER, TYPE B-6.24
 - ④ EXISTING AGGREGATE SHOULDERS
 - ⑤ PROPOSED HOT MIX ASPHALT SURFACE REMOVAL, 2 1/4"
 - ⑥ PROPOSED LEVELING BINDER (MACHINE METHOD), N70, 3/4"
 - ⑦ PROPOSED HOT MIX ASPHALT SURFACE COURSE, MIX "D", N70, 1 1/2"
 - ⑧ PROPOSED AGGREGATE WEDGE SHOULDER TYPE B
 - ⑨ PROPOSED STRIP REFLECTIVE CRACK CONTROL

FILE NAME = c:\projects\dl03400\design\aa.dgn	USER NAME = berksl	DESIGNED -	REVISED -
		DRAWN -	REVISED -
	PLOT SCALE = 50.0000' / IN.	CHECKED -	REVISED -
	PLOT DATE = 11/7/2007	DATE -	REVISED -

STATE OF ILLINOIS
DEPARTMENT OF TRANSPORTATION

IL. ROUTE 31 @ CRYSTAL LAKE AVENUE
 EXISTING AND PROPOSED TYPICAL CROSS SECTIONS

F.A. RTE. = 336	SECTION = 112 R-N-1	COUNTY = McHenry	TOTAL SHEETS = 31	SHEET NO. = 5
SCALE: SHEET NO. OF SHEETS STA. TO STA.			FED. ROAD DIST. NO. 1 ILLINOIS FED. AID PROJECT	
CONTRACT NO. 60D52				

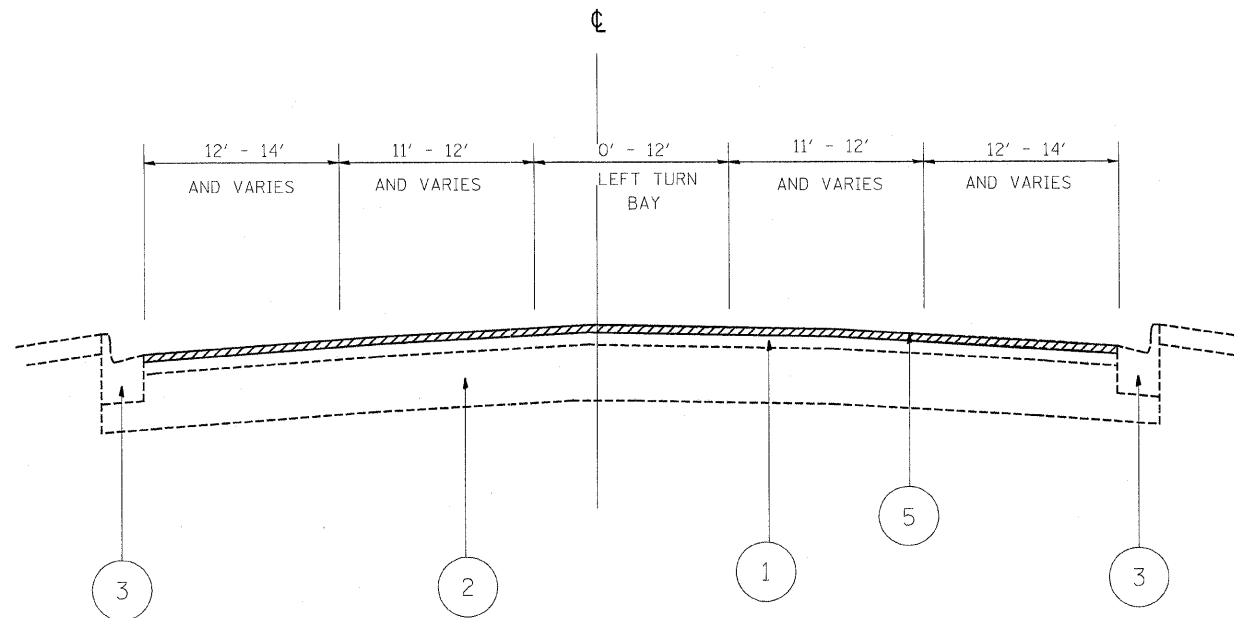

CRYSTAL LAKE AVENUE
 EXISTING TYPICAL SECTION
 STA. 13+48 TO STA. 21+82

- LEGEND
- 1 EXISTING HOT-MIX ASPHALT SURFACE, 3" ±
 - 2 EXISTING HOT-MIX ASPHALT BASE COURSE, 8" ±
 - 3 EXISTING CONCRETE CURB AND GUTTER, TYPE B-6.24
 - 4 EXISTING AGGREGATE SHOULDERS
 - 5 PROPOSED HOT MIX ASPHALT SURFACE REMOVAL, 2 1/4"
 - 6 PROPOSED LEVELING BINDER (MACHINE METHOD), N70, 3/4"
 - 7 PROPOSED HOT MIX ASPHALT SURFACE COURSE, MIX "D", N70, 1 1/2"
 - 8 PROPOSED AGGREGATE WEDGE SHOULDER TYPE B
 - 9 PROPOSED STRIP REFLECTIVE CRACK CONTROL

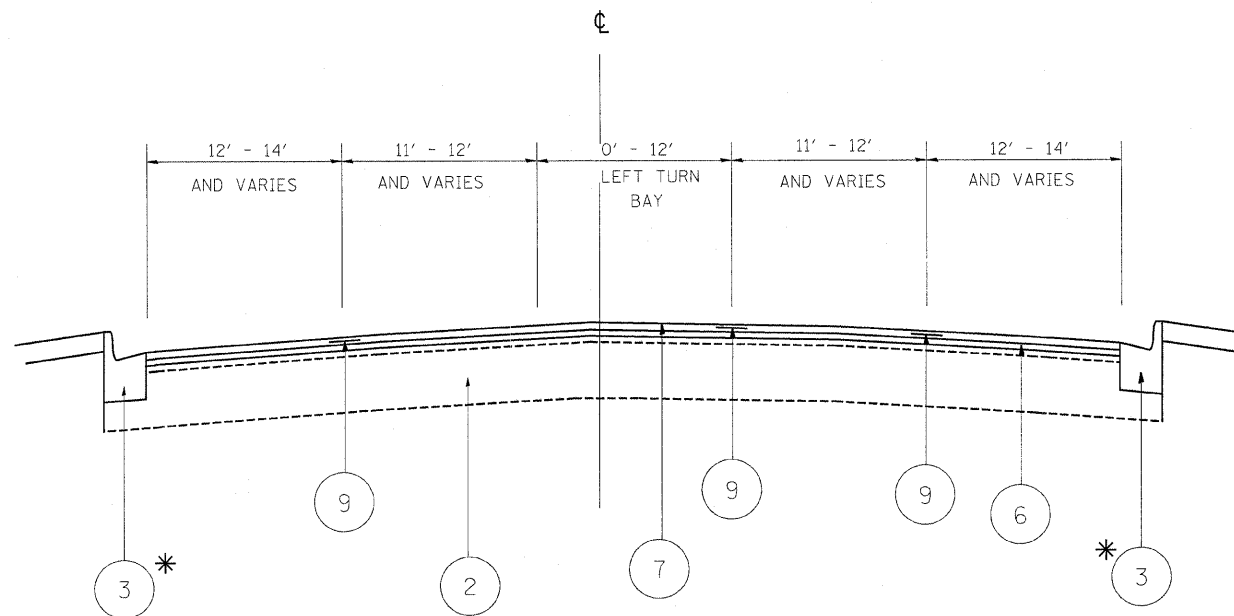

CRYSTAL LAKE AVENUE
 PROPOSED TYPICAL SECTION
 STA. 13+48 TO STA. 21+82

* CURB AND GUTTER AND
 SIDEWALK LOCATIONS TO BE DETERMINE
 BY R.E.

HOT-MIX ASPHALT MIXTURE REQUIREMENTS		
MIXTURE TYPE	AC TYPE	AIR VOIDS(%)
IL 31 - PAVEMENT RESURFACING (MAINLINE)		
POLYMERIZED HOT-MIX ASPHALT SURFACE COURSE, MIX "F", N90	SBS/SBR PG 70-22	4% @ 90 GYR.
LEVELING BINDER (MM) N70	PG 64-22*	4% @ 70 GYR.
CRYSTAL LAKE AVENUE - PAVEMENT RESURFACING		
HOT-MIX ASPHALT SURFACE COURSE, MIX "D", N70	PG 64-22*	4% @ 70 GYR.
LEVELING BINDER (MM), N70	PG 64-22*	4% @ 70 GYR.
PATCHING		
CLASS D PATCHES TYPE II, 11" & 15 1/4", (BINDER IL-19 mm)	PG 64-22*	4% @ 70 GYR.
HMA REPLACEMENT OVER PATCHES (HMA BINDER IL-19 mm)	PG 64-22*	4% @ 70 GYR.

* WHEN RAP EXCEEDS 20%, THE NEW ASPHALT BINDER IN THE MIX SHALL BE PG 58-22.
 NOTE: THE UNIT WEIGHT USED TO CALCULATE ALL HOT-MIX ASPHALT SURFACE MIXTURE
 QUANTITIES IS 112 LBS/SQ YD/IN.

FILE NAME =	USER NAME = banks1	DESIGNED -	REVISED -
ai\projects\dl03408\design\aa.dgn		DRAWN -	REVISED -
		CHECKED -	REVISED -
		DATE -	REVISED -

STATE OF ILLINOIS
 DEPARTMENT OF TRANSPORTATION

IL. ROUTE 31 @ CRYSTAL LAKE AVENUE
 EXISTING AND PROPOSED TYPICAL CROSS SECTIONS

F.A.P. RTE.	SECTION	COUNTY	TOTAL SHEETS	SHEET NO.
336	112 R-N-1	McHenry	31	6
FED. ROAD DIST. NO.			ILLINOIS FED. AID PROJECT	
			CONTRACT NO. 60D52	

SCALE: SHEET NO. OF SHEETS STA. TO STA.

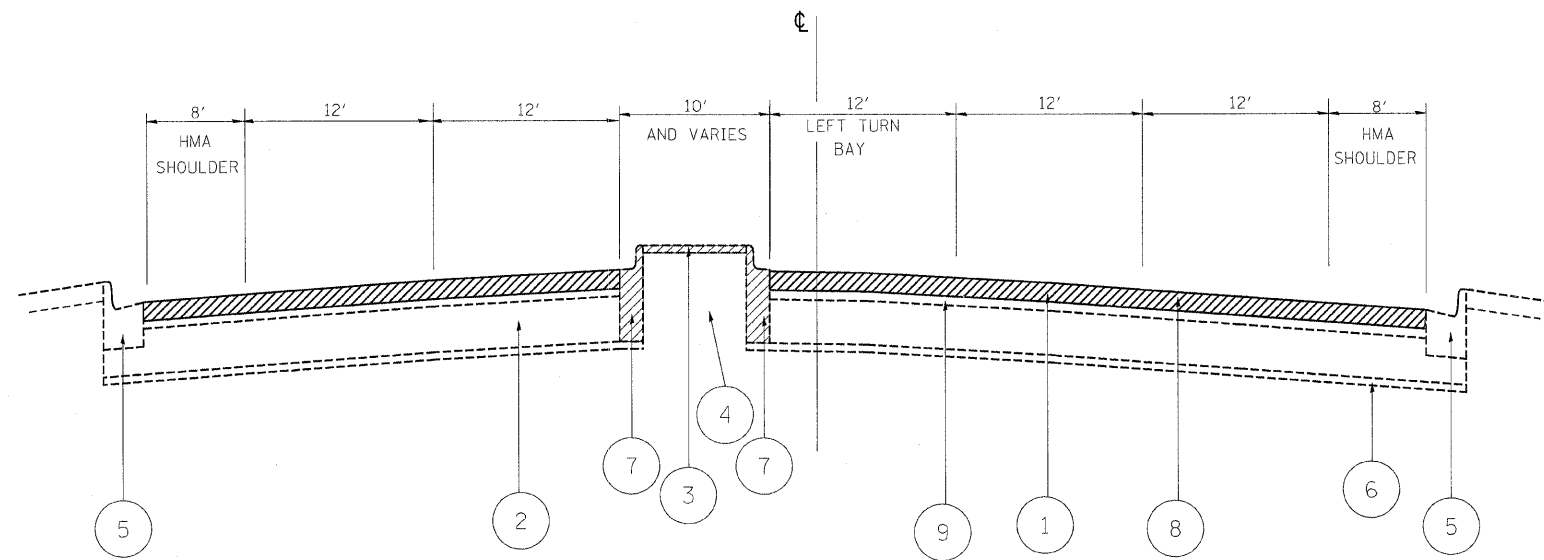

IL 31
 EXISTING TYPICAL SECTION
 STA. 9+22 TO STA. 20+58

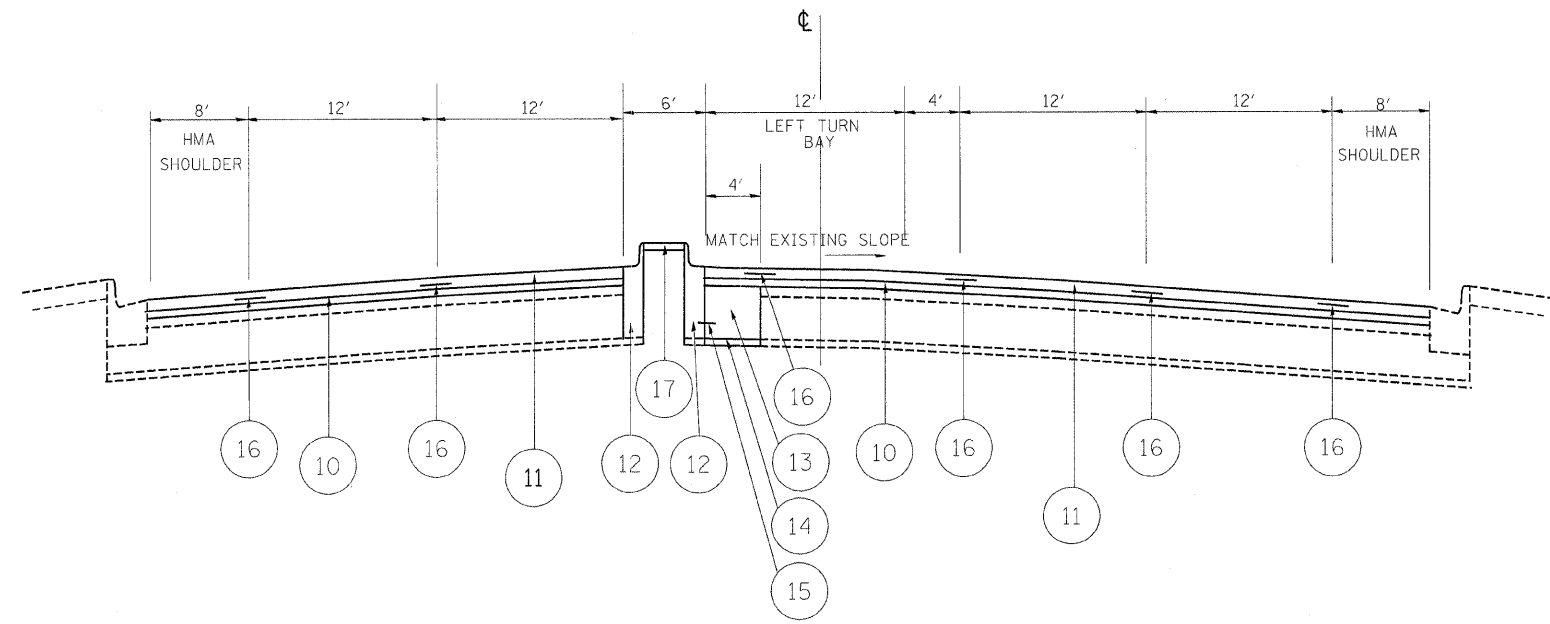

IL 31
 PROPOSED TYPICAL SECTION
 STA. 9+22 TO STA. 20+58

- LEGEND
- 1 EXISTING HOT-MIX ASPHALT SURFACE COURSE, 4 1/4" ±
 - 2 EXISTING HOT MIX ASPHALT BASE COURSE, 11" ±
 - 3 EXISTING P.C.C. MEDIAN
 - 4 EXISTING COMPACTED EARTH
 - 5 EXISTING CONCRETE CURB AND GUTTER, TYPE B-6.24
 - 6 EXISTING SUB-BASE GRANULAR MATERIAL
 - 7 EXISTING CURB AND GUTTER TO BE REMOVED
 - 8 PROPOSED HOT MIX ASPHALT SURFACE REMOVAL, 2 1/2"
 - 9 EXISTING HOT MIX ASPHALT OVERLAY AFTER MILLING
 - 10 PROPOSED LEVELING BINDER (MACHINE METHOD), N70 (3/4")
 - 11 PROPOSED POLYMERIZED HOT MIX ASPHALT SURFACE COURSE MIX "F", N90 1 3/4"
 - 12 PROPOSED CURB AND GUTTER SB-6.12
 - 13 PROPOSED P.C.C. BASE COURSE WIDENING, 11"
 - 14 PROPOSED SUB-BASE GRANULAR MATERIAL, TYPE B, 6"
 - 15 PROPOSED DRILL AND GROUT #6 TIE BAR, SHAPE (24" C-C), EPOXY COATED, DEFORMED. COST INCLUDED IN CONCRETE CURB AND GUTTER, TYPE SB-6.12 PAY ITEM
 - 16 PROPOSED STRIP REFLECTIVE CRACK CONTROL
 - 17 PROPOSED P.C.C. MEDIAN SB-6.12

FILE NAME = c:\projects\dl\03408\design\aa.dgn	USER NAME = banks1	DESIGNED -	REVISED -	STATE OF ILLINOIS DEPARTMENT OF TRANSPORTATION	IL. ROUTE 31 @ CRYSTAL LAKE AVENUE EXISTING AND PROPOSED TYPICAL CROSS SECTIONS				F.A.P. RTE. 336	SECTION 112 R-N-1	COUNTY McHenry	TOTAL SHEETS 31	SHEET NO. 7
PLOT SCALE = 50,0000' / IN.	CHECKED -	REVISED -	SCALE:						SHEET NO.	OF	SHEETS	STA.	TO STA.
PLOT DATE = 10/25/2007	DATE -	REVISED -											
CONTRACT NO. 60D52													

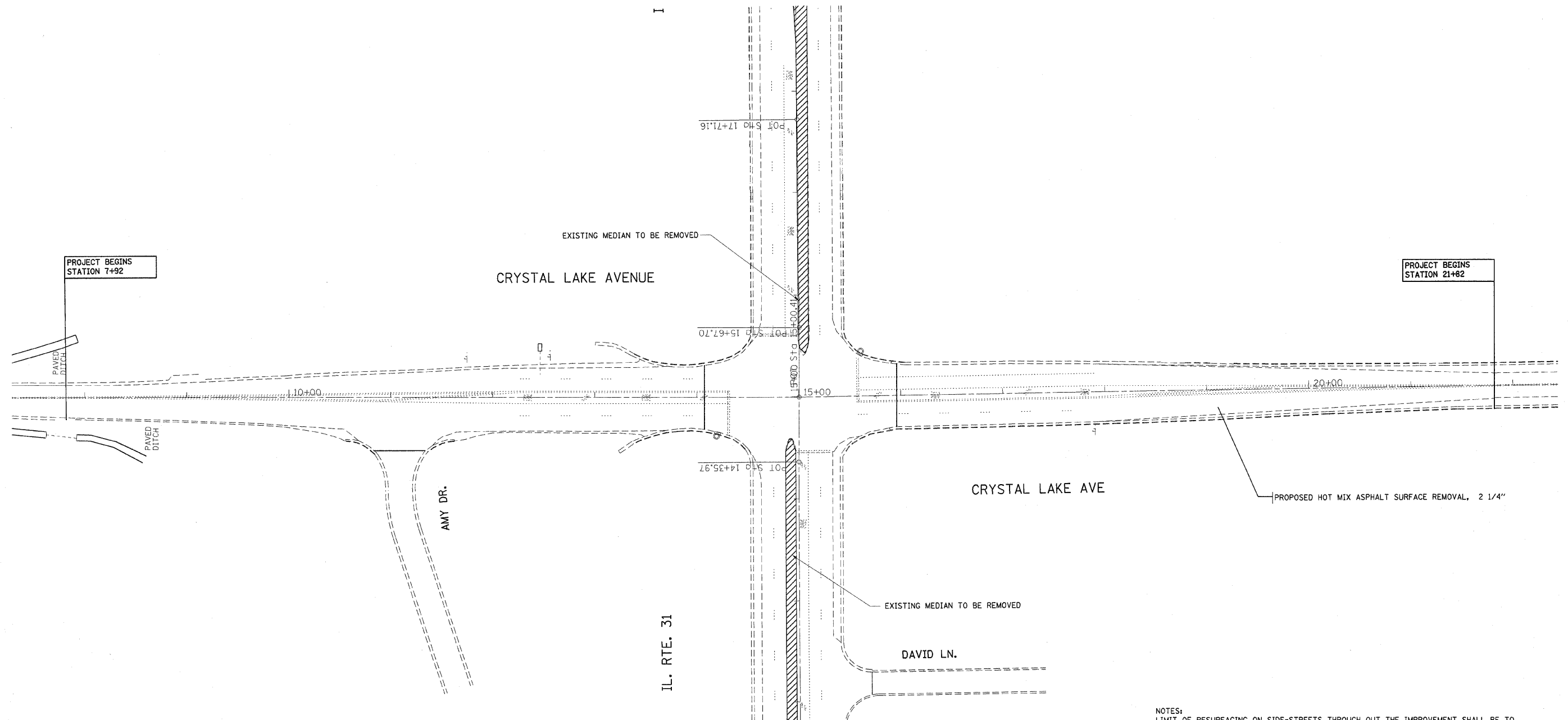
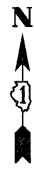

NOTES:
 LIMIT OF RESURFACING ON SIDE-STREETS THROUGH OUT THE IMPROVEMENT SHALL BE TO THE RADIUS OF RETURN OR AS DIRECTED BY THE ENGINEER

ALL FINAL PAVEMENT MARKINGS SHALL BE THERMOPLASTIC (OF THE EXTRUDED TYPE) AND SHOULD BE PLACED IN ACCORDANCE WITH "DISTRICT ONE TYPICAL PAVEMENT MARKINGS" DETAIL, (TC-13).

ALL RAISED REFLECTIVE PAVEMENT MARKINGS SHALL BE PLACED IN ACCORDANCE WITH THE DISTRICT ONE "TYPICAL APPLICATIONS RAISED REFLECTIVE PAVEMENT MARKER DETAIL," (TC-11).

FILE NAME = a:\projects\03408\design_aa.dgn	USER NAME = banks1	DESIGNED -	REVISED -
		DRAWN -	REVISED -
		CHECKED -	REVISED -
		DATE -	REVISED -

**STATE OF ILLINOIS
 DEPARTMENT OF TRANSPORTATION**

**IL. ROUTE 31@ CRYSTAL LAKE AVENUE
 EXISTING ROADWAY AND PAVEMENT MARKING PLANS**

SCALE: SHEET NO. OF SHEETS STA. TO STA.

F.A.P. RTE.	SECTION	COUNTY	TOTAL SHEETS	SHEET NO.
336	112 R-N-1	McHenry	31	8
FED. ROAD DIST. NO. ILLINOIS FED. AID PROJECT			CONTRACT NO. 60D52	

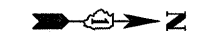
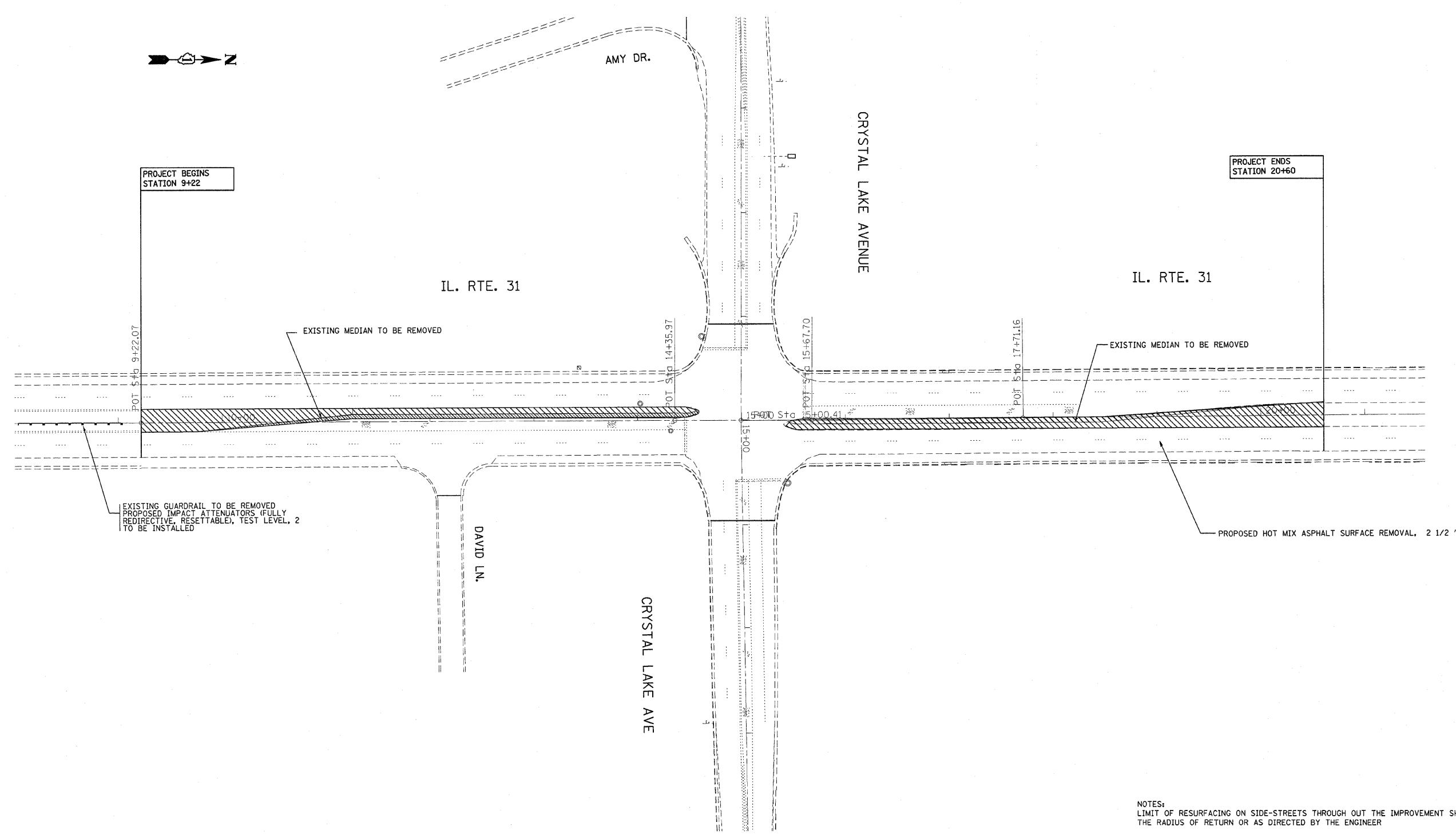

PROJECT BEGINS
STATION 9+22

PROJECT ENDS
STATION 20+60

IL. RTE. 31

IL. RTE. 31

CRYSTAL LAKE AVENUE

AMY DR.

DAVID LN.

CRYSTAL LAKE AVE

EXISTING GUARDRAIL TO BE REMOVED
PROPOSED IMPACT ATTENUATORS (FULLY
REDIRECTIVE, RESETTABLE), TEST LEVEL, 2
TO BE INSTALLED

EXISTING MEDIAN TO BE REMOVED

EXISTING MEDIAN TO BE REMOVED

PROPOSED HOT MIX ASPHALT SURFACE REMOVAL, 2 1/2 "

NOTES:
LIMIT OF RESURFACING ON SIDE-STREETS THROUGH OUT THE IMPROVEMENT SHALL BE TO THE RADIUS OF RETURN OR AS DIRECTED BY THE ENGINEER

ALL FINAL PAVEMENT MARKINGS SHALL BE THERMOPLASTIC (OF THE EXTRUDED TYPE) AND SHOULD BE PLACED IN ACCORDANCE WITH "DISTRICT ONE TYPICAL PAVEMENT MARKINGS" DETAIL, (TC-13).

ALL RAISED REFLECTIVE PAVEMENT MARKINGS SHALL BE PLACED IN ACCORDANCE WITH THE DISTRICT ONE "TYPICAL APPLICATIONS RAISED REFLECTIVE PAVEMENT MARKER DETAIL," (TC-11).

FILE NAME = c:\projeots\dl03488\design_00.dgn	USER NAME = banks1	DESIGNED -	REVISED -	STATE OF ILLINOIS DEPARTMENT OF TRANSPORTATION	IL. ROUTE 31@ CRYSTAL LAKE AVENUE EXISTING ROADWAY AND PAVEMENT MARKING PLANS	F.A.P. RTE.	SECTION	COUNTY	TOTAL SHEETS	SHEET NO.
	PLLOT SCALE = 50,0000 ' / IN.	DRAWN -	REVISED -			336	112 R-N-1	McHenry	31	9
PLLOT DATE = 11/7/2007	CHECKED -	REVISED -	CONTRACT NO. 60D52							
	DATE -	REVISED -	FED. ROAD DIST. NO. ILLINOIS FED. AID PROJECT							
						SCALE:	SHEET NO. OF SHEETS	STA. TO STA.		

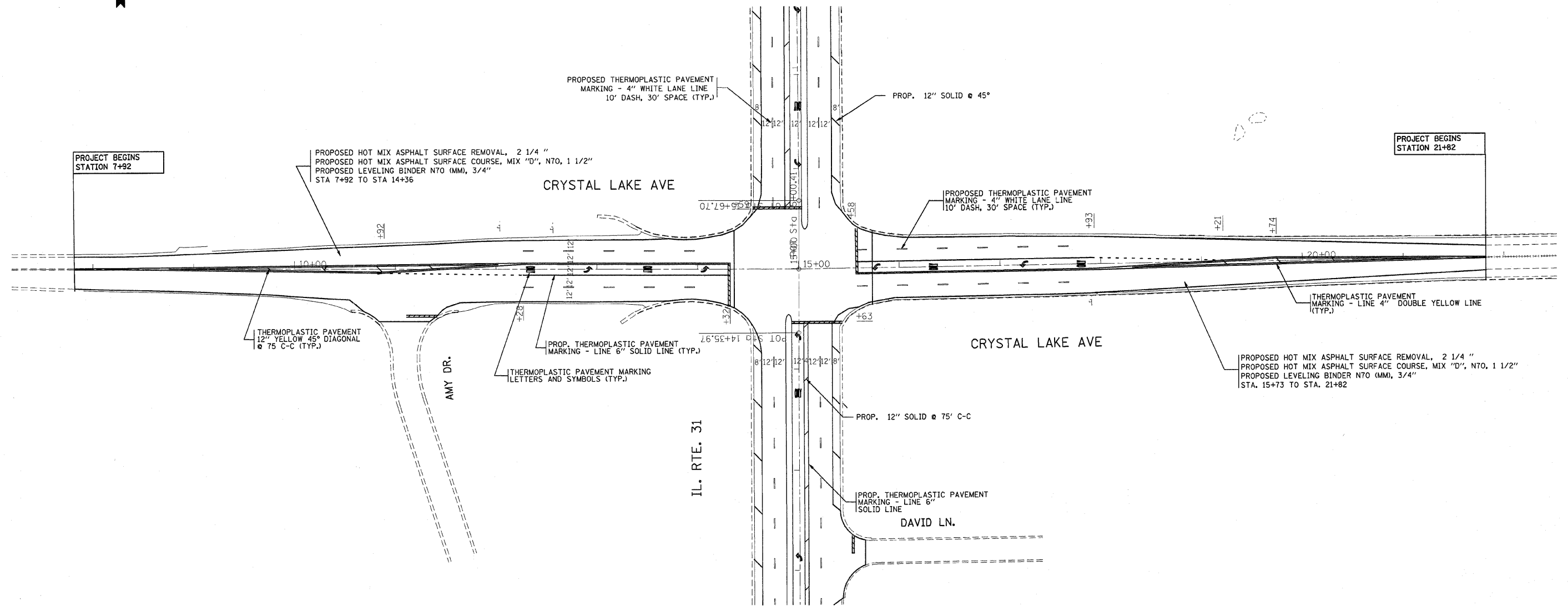

FILE NAME = c:\projects\103408\design\00.dgn	USER NAME = banks1	DESIGNED -	REVISED -
		DRAWN -	REVISED -
		CHECKED -	REVISED -
		DATE -	REVISED -
PLOT SCALE = 50.0000' / IN.			
PLOT DATE = 11/7/2007			

**STATE OF ILLINOIS
 DEPARTMENT OF TRANSPORTATION**

**IL. ROUTE 31@ CRYSTAL LAKE AVENUE
 PROPOSED ROADWAY AND PAVEMENT MARKING PLANS**

SCALE: SHEET NO. OF SHEETS STA. TO STA.

F.A.P. RTE.	SECTION	COUNTY	TOTAL SHEETS	SHEET NO.
336	112 R-N-1	McHenry	31	10
FED. ROAD DIST. NO. ILLINOIS FED. AID PROJECT			CONTRACT NO. 60D52	

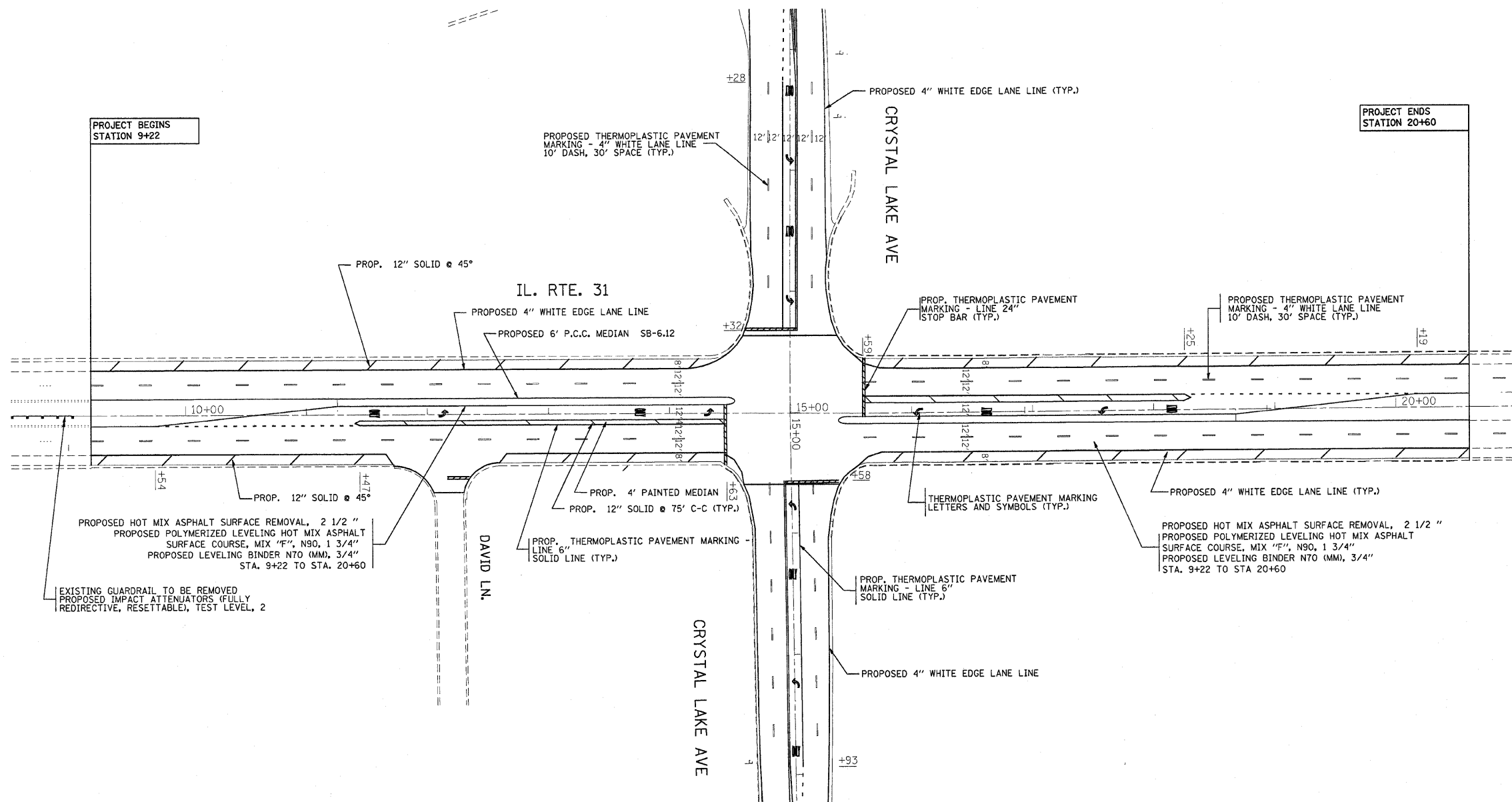

NOTES:
 LIMIT OF RESURFACING ON SIDE-STREETS THROUGH OUT THE IMPROVEMENT SHALL BE TO THE RADIUS OF RETURN OR AS DIRECTED BY THE ENGINEER

ALL FINAL PAVEMENT MARKINGS SHALL BE THERMOPLASTIC (OF THE EXTRUDED TYPE) AND SHOULD BE PLACED IN ACCORDANCE WITH "DISTRICT ONE TYPICAL PAVEMENT MARKINGS" DETAIL, (TC-13).

ALL RAISED REFLECTIVE PAVEMENT MARKINGS SHALL BE PLACED IN ACCORDANCE WITH THE DISTRICT ONE "TYPICAL APPLICATIONS RAISED REFLECTIVE PAVEMENT MARKER DETAIL," (TC-11).

FILE NAME = c:\projects\103408\design.aadgn	USER NAME = banks1	DESIGNED -	REVISED -	STATE OF ILLINOIS DEPARTMENT OF TRANSPORTATION	IL. ROUTE 31@ CRYSTAL LAKE AVENUE PROPOSED ROADWAY AND PAVEMENT MARKING PLANS			F.A.P. RTE. 336	SECTION 112 R-N-1	COUNTY McHENRY	TOTAL SHEETS 31	SHEET NO. 11
PLOT SCALE = 50.0000' / IN.	CHECKED -	REVISED -	REVISED -					SCALE: SHEET NO. OF SHEETS STA. TO STA.			CONTRACT NO. 60D52	
PLOT DATE = 11/7/2007	DATE -	REVISED -	REVISED -					FED. ROAD DIST. NO. ILLINOIS FED. AID PROJECT				

NOTES FOR TEMPORARY TRAFFIC SIGNALS

1. ALL CONTROL EQUIPMENT INCLUDING EMERGENCY PRE-EMPTION AND COMMUNICATION DEVICES FOR THE TEMPORARY TRAFFIC SIGNAL(S) SHALL BE FURNISHED BY THE CONTRACTOR.
2. ONLY CONTROLLERS SUPPLIED BY ONE OF THE DISTRICT APPROVED CLOSED LOOP EQUIPMENT MANUFACTURERS WILL BE APPROVED FOR USE AT TEMPORARY SIGNAL LOCATIONS. ALL CONTROLLERS USED FOR TEMPORARY TRAFFIC SIGNALS SHALL BE FULLY ACTUATED NEMA MICROPROCESSOR BASED WITH RS232 DATA ENTRY PORTS COMPATIBLE WITH EXISTING MONITORING SOFTWARE APPROVED BY IDOT DISTRICT 1, INSTALLED IN A NEMA TS1 OR TS2 CABINET. ONLY ONE BRAND OF CONTROLLER WILL BE ACCEPTED FOR ANY ONE CONTRACT.
3. ALL TRAFFIC SIGNAL SECTIONS AND PEDESTRIAN SIGNAL SECTIONS SHALL BE 12" (300mm). HEADS SHALL BE PLACED AS INDICATED ON THE TEMPORARY TRAFFIC SIGNAL PLANS OR AS DIRECTED BY THE ENGINEER. THE CONTRACTOR SHALL FURNISH ENOUGH CABLE SLACK TO RELOCATE HEADS TO ANY POSITION ON THE SPAN WIRE OR AT LOCATIONS ILLUSTRATED ON THE PLANS FOR CONSTRUCTION STAGING. THE TEMPORARY TRAFFIC SIGNAL SHALL REMAIN IN OPERATION DURING ALL SIGNAL HEAD RELOCATIONS. EACH TEMPORARY TRAFFIC SIGNAL HEAD SHALL HAVE ITS OWN CABLE FROM THE CONTROLLER CABINET TO THE SIGNAL HEAD.
4. ALL EXISTING STREET NAME AND INTERSECTION REGULATORY SIGNS SHALL BE REMOVED FROM EXISTING POLES, RELOCATED AND SECURELY FASTENED TO THE SIGNAL SPAN WIRE OR WOOD POLE AS DIRECTED BY THE ENGINEER.
5. ANY TEMPORARY SIGNAL WITHIN AN EXISTING CLOSED LOOP TRAFFIC SIGNAL SYSTEM SHALL BE INTERCONNECTED TO THAT SYSTEM USING SIMILAR BRAND CONTROL EQUIPMENT.
6. THE TEMPORARY TRAFFIC SIGNAL SHALL HAVE THE SIGNAL HEAD DISPLAYS, SIGNAL HEAD PLACEMENTS AND CONTROLLER PHASING MATCH THE EXISTING TRAFFIC SIGNAL, AT THE TIME OF THE TURN ON, IF NO TRAFFIC STAGING IS IN PLACE OR WILL NOT BE STAGED ON THE DAY OF THE TURN ON.

TEMPORARY TRAFFIC SIGNAL LEGEND

- | | | | |
|---|--|----|---|
| ← | TEMPORARY TRAFFIC SIGNAL HEAD SPAN WIRE MOUNTED ORIGINAL LOCATION | ⊙ | PEDESTRIAN PUSHBUTTON DETECTOR |
| ↖ | TEMPORARY TRAFFIC SIGNAL HEAD SPAN WIRE MOUNTED SECONDARY LOCATION | ⊕ | EMERGENCY VEHICLE LIGHT DETECTOR |
| ⊗ | TEMPORARY WOOD POLE (CLASS 5 OR BETTER) 45 FOOT (13.7m) MINIMUM | □ | CONFIRMATION BEACON |
| ⊠ | TEMPORARY CONTROLLER CABINET | UD | VEHICLE DETECTOR, INDUCTION LOOP |
| — | TEMPORARY SPAN WIRE, TETHER WIRE, AND CABLE | — | UNIT DUCT |
| ⊠ | TEMPORARY SERVICE INSTALLATION | — | G.S. CONDUIT IN TRENCH (T) OR PUSHED (P) |
| ⊠ | TEMPORARY PEDESTRIAN SIGNAL HEAD, BRACKET MOUNTED | ■ | HANDHOLE |
| ⊠ | MICROWAVE VEHICLE SENSOR | ■ | HEAVY DUTY HANDHOLE |
| | | CT | COMMON TRENCH |
| | | ⊠ | ILLUMINATED SIGN, FIBER OPTIC "NO LEFT TURN" |
| | | ⊠ | ILLUMINATED SIGN, FIBER OPTIC "NO RIGHT TURN" |
| | | ⋈ | DOWN GUY |

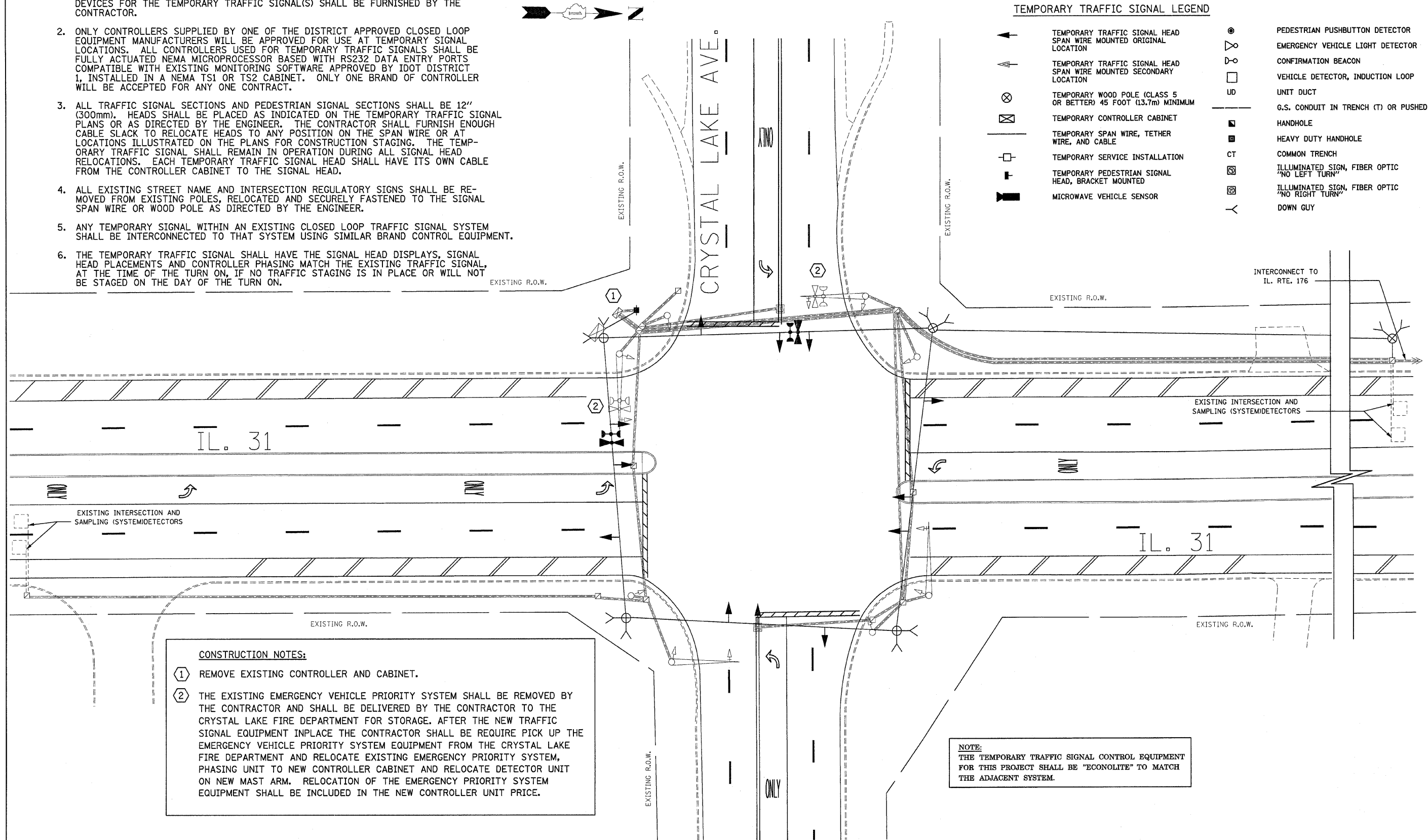

CONSTRUCTION NOTES:

① REMOVE EXISTING CONTROLLER AND CABINET.

② THE EXISTING EMERGENCY VEHICLE PRIORITY SYSTEM SHALL BE REMOVED BY THE CONTRACTOR AND SHALL BE DELIVERED BY THE CONTRACTOR TO THE CRYSTAL LAKE FIRE DEPARTMENT FOR STORAGE. AFTER THE NEW TRAFFIC SIGNAL EQUIPMENT INPLACE THE CONTRACTOR SHALL BE REQUIRE PICK UP THE EMERGENCY VEHICLE PRIORITY SYSTEM EQUIPMENT FROM THE CRYSTAL LAKE FIRE DEPARTMENT AND RELOCATE EXISTING EMERGENCY PRIORITY SYSTEM, PHASING UNIT TO NEW CONTROLLER CABINET AND RELOCATE DETECTOR UNIT ON NEW MAST ARM. RELOCATION OF THE EMERGENCY PRIORITY SYSTEM EQUIPMENT SHALL BE INCLUDED IN THE NEW CONTROLLER UNIT PRICE.

NOTE:
THE TEMPORARY TRAFFIC SIGNAL CONTROL EQUIPMENT FOR THIS PROJECT SHALL BE "ECONOLITE" TO MATCH THE ADJACENT SYSTEM.

FILE NAME = c:\projects\103488\traffic.dgn	USER NAME = nguyenam	DESIGNED - SN	REVISED -
		DRAWN - SN	REVISED -
		CHECKED - DAD	REVISED -
		DATE - OCT. 5, 2007	REVISED -

STATE OF ILLINOIS
DEPARTMENT OF TRANSPORTATION

TEMPORARY TRAFFIC SIGNAL INSTALLATION & REMOVE EXISTING TRAFFIC SIGNAL EQUIPMENT			
IL.31 @ CRYSTAL LAKE AVE.			
SCALE:	SHEET NO.	OF SHEETS	STA. TO STA.

F.A.P. RTE. 336	SECTION 112 R-N-1	COUNTY MCHENRY	TOTAL SHEETS 31	SHEET NO. 12
FED. ROAD DIST. NO. 1 ILLINOIS FED. AID PROJECT			CONTRACT NO. 60D52	

CONTROLLER SEQUENCE

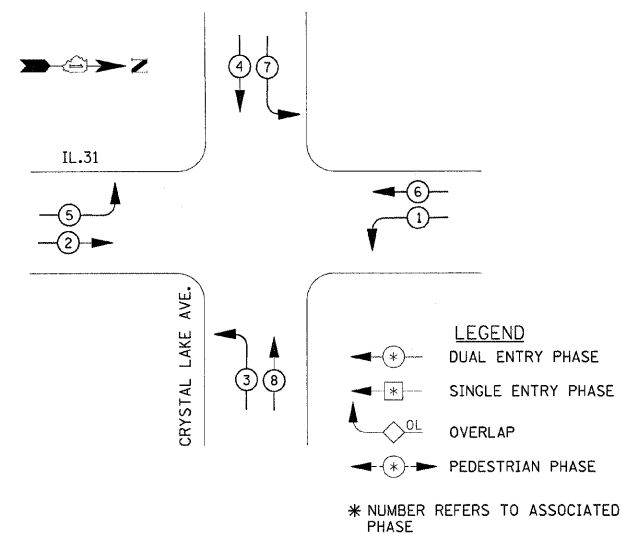

TEMPORARY PHASE DESIGNATION DIAGRAM

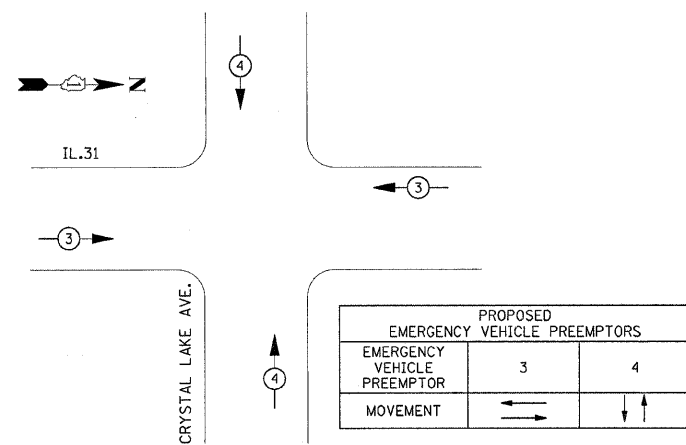

TEMPORARY EMERGENCY VEHICLE PREEMPTION SEQUENCE

TEMPORARY CABLE DIAGRAM LEGEND

- R TEMPORARY TRAFFIC SIGNAL SECTION OR PEDESTRIAN SIGNAL SECTION 12" (300mm)
- ⊠ TEMPORARY CONTROLLER CABINET
- ⊕ TEMPORARY SERVICE INSTALLATION
- 5 INDICATES NUMBER OF CONDUCTORS IN CABLE. ALL CONDUCTORS TO BE NUMBER 14 AWG WIRE UNLESS OTHERWISE NOTED
- EMERGENCY VEHICLE LIGHT DETECTOR
- CONFIRMATION BEACON
- VEHICLE DETECTOR, INDUCTION LOOP
- PEDESTRIAN PUSHBUTTON DETECTOR
- ⊞ 12" (300mm) PEDESTRIAN SIGNAL SECTION
- MICROWAVE VEHICLE SENSOR

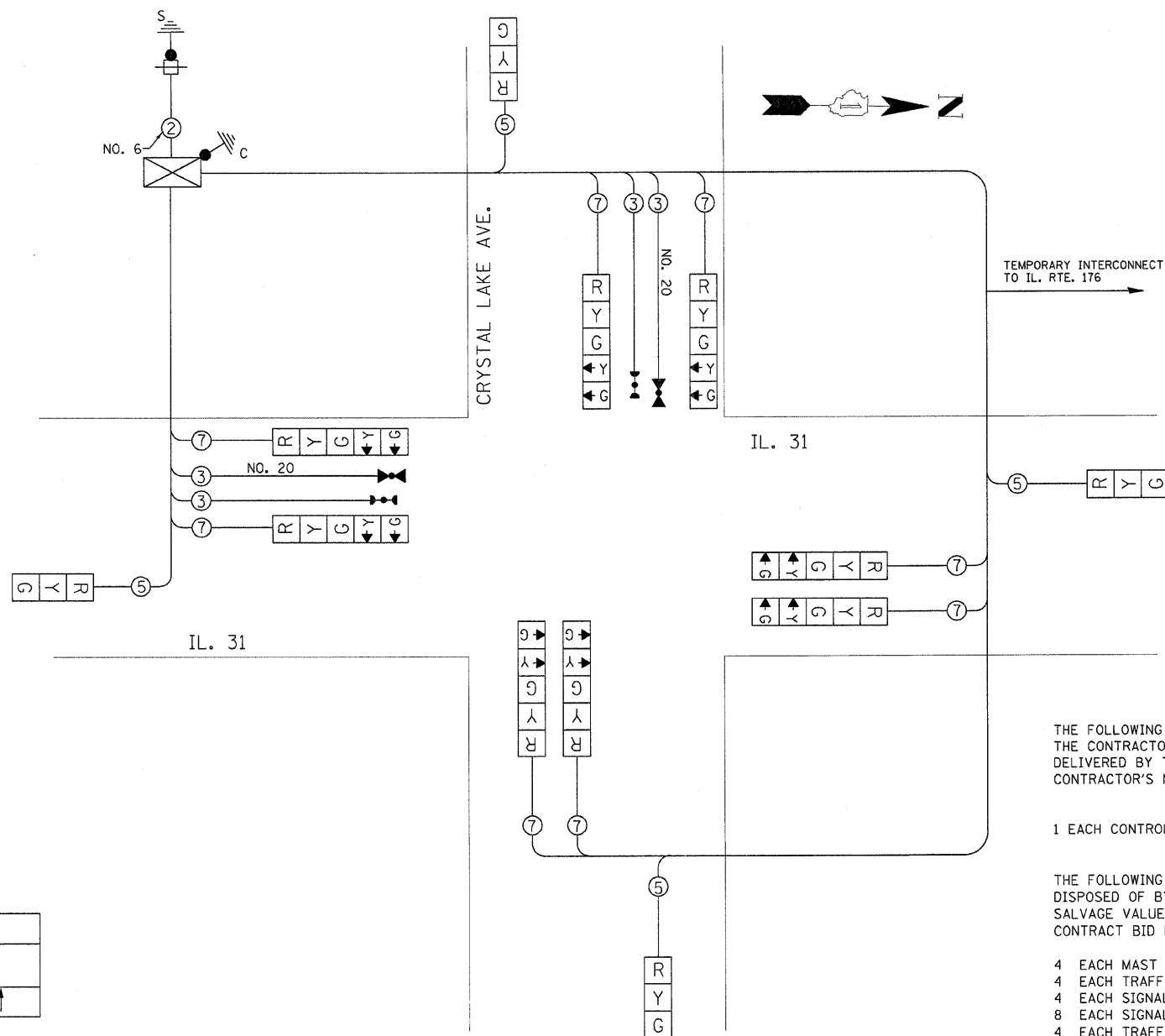

TEMPORARY CABLE PLAN

THE FOLLOWING EXISTING TRAFFIC SIGNAL EQUIPMENT SHALL BE REMOVED BY THE CONTRACTOR, SHALL REMAIN THE PROPERTY OF THE STATE AND SHALL BE DELIVERED BY THE CONTRACTOR TO THE STATE'S TRAFFIC SIGNAL MAINTENANCE CONTRACTOR'S MAIN FACILITY AS PER THE TRAFFIC SIGNAL SPECIFICATIONS.

1 EACH CONTROLLER AND CABINET COMPLETE

THE FOLLOWING ITEMS SHALL BE REMOVED BY THE CONTRACTOR AND SHALL BE DISPOSED OF BY THEM OUTSIDE THE RIGHT-OF-WAY AT THEIR EXPENSE. THE SALVAGE VALUE OF THE REMOVED EQUIPMENT SHALL BE REFLECTED IN THE CONTRACT BID PRICE.

- 4 EACH MAST ARM ASSEMBLY AND POLE, ALUMINUM
- 4 EACH TRAFFIC SIGNAL POST
- 4 EACH SIGNAL HEAD, 1-FACE 3-SECTION
- 8 EACH SIGNAL HEAD, 1-FACE 5-SECTION
- 4 EACH TRAFFIC SIGNAL BACKPLATE
- 1 EACH SERVICE INSTALLATION

SCHEDULE OF QUANTITIES

ITEM	UNIT	QUANTITY
REMOVE EXISTING TRAFFIC SIGNAL EQUIPMENT	EACH	1
REMOVE EXISTING CONCRETE FOUNDATION	EACH	9
REMOVE EXISTING HANDHOLE	EACH	8
TEMPORARY TRAFFIC SIGNAL INSTALLATION	EACH	1

FOUNDATION (DEPTH)	(FT.) (m)	CABLE SLACK	(FT.) (m)	VERTICAL	(FT.) (m)
TYPE A - POST	4 (1.2)	HANDHOLE	6.5 (2.0)	ALL FOUNDATIONS	3.5 (1.0)
D - FOUNDATION	4 (1.2)	DOUBLE HANDHOLE	13 (4.0)	MAST ARM (L) POLE	20' + L - 2' = (6m+L-0.6m)=
C - M. ARM POLE		SIGNAL POST	2 (0.6)	BRACKET MOUNTED	13 (4.0)
24" (600mm)	10 (3.0)	CONTROLLER CAB.	1 (0.5)	PED. PUSHBUTTON	4 (1.2)
30" (750mm)	15 (4.6)	FIBER OPTIC	13 (4.0)	ELECTRIC SERVICE	13.5 (4.1)
		ELECTRIC SERVICE	1 (0.5)	SERVICE TO GROUND	13.5 (4.1)
		GROUND CABLE	1 (0.5)	POST MOUNTED	6 (1.8)

NOTE:
THE TEMPORARY TRAFFIC SIGNAL CONTROL EQUIPMENT FOR THIS PROJECT SHALL BE "ECONOLITE" TO MATCH THE ADJACENT SYSTEM.

I.D.O.T. TRAFFIC SIGNAL INSTALLATION ELECTRICAL SERVICE REQUIREMENTS					TOTAL WATTAGE
TYPE	NO. LAMPS	WATTAGE INCAND.	WATTAGE LED	% OPERATION	
SIGNAL (RED)	12	135	17	0.50	102.00
(YELLOW)	12	135	25	0.25	75.00
(GREEN)	12	135	15	0.25	45.00
ARROW	16	135	12	0.10	19.20
PED. SIGNAL		90	25	1.00	
CONTROLLER	1	100	100	1.00	100.00
ILLUM. SIGN		84		0.05	
FLASHER				0.50	
ENERGY COSTS TO: ILLINOIS DEPARTMENT OF TRANSPORTATION, 201 WEST CENTER COURT, SCHAMBURG, ILLINOIS 60196-1096					TOTAL = 341.20
ENERGY SUPPLY CONTACT: PHONE: 847) 816-5248, COMPANY: COMED					
FILE NAME =	USER NAME =	DESIGNED - SN	REVISED -		
PROJECTS\dl03408\traffic.dgn	nguyenam	DRAWN - SN	REVISED -		
		CHECKED - DAD	REVISED -		
		DATE - OCT. 5, 2007	REVISED -		

STATE OF ILLINOIS DEPARTMENT OF TRANSPORTATION

TEMPORARY CABLE PLAN AND TEMPORARY PHASE DESIGNATION DIAGRAM
IL.31 @ CRYSTAL LAKE AVE.

F.A.P. RTE.	SECTION	COUNTY	TOTAL SHEETS	SHEET NO.
336	112 R-N-1	MCHENRY	31	13
SCALE: SHEET NO. OF SHEETS STA. TO STA.			CONTRACT NO. 60D52	
FED. ROAD DIST. NO. 1 ILLINOIS FED. AID PROJECT				

TRAFFIC SIGNAL LEGEND

	PROPOSED	EXISTING		PROPOSED	EXISTING
CONTROLLER	[Symbol]	[Symbol]	PEDESTRIAN PUSHBUTTON DETECTOR	[Symbol]	[Symbol]
SERVICE INSTALLATION	[Symbol]	[Symbol]	DETECTOR LOOP	[Symbol]	[Symbol]
SIGNAL HEAD	[Symbol]	[Symbol]	CAST IRON JUNCTION BOX	[Symbol]	[Symbol]
SIGNAL HEAD WITH BACKPLATE	[Symbol]	[Symbol]	EMERGENCY VEHICLE SYSTEM DETECTOR	[Symbol]	[Symbol]
SIGNAL HEAD, PEDESTRIAN	[Symbol]	[Symbol]	CONFIRMATION BEACON	[Symbol]	[Symbol]
SIGNAL POST	[Symbol]	[Symbol]	SIGNAL HEAD OPTICALLY PROGRAMMED	[Symbol]	[Symbol]
MAST ARM ASSEMBLY AND POLE, STEEL	[Symbol]	[Symbol]	CONDUIT SPLICE	[Symbol]	[Symbol]
MAST ARM ASSEMBLY AND POLE, ALUMINUM	[Symbol]	[Symbol]	WOOD POLE	[Symbol]	[Symbol]
COMMON TRENCH	CT	[Symbol]	RACEWAY FOR MAGNETIC DETECTOR, TYPE I OR TYPE II	[Symbol]	[Symbol]
UNIT DUCT	UD	[Symbol]	VEHICLE DETECTOR, NON COMPENSATED MAGNETIC TYPE	[Symbol]	[Symbol]
HANDHOLE	[Symbol]	[Symbol]	RAILROAD CONTROL CABINET	[Symbol]	[Symbol]
HEAVY DUTY HANDHOLE	[Symbol]	[Symbol]	ILLUMINATED SIGN, FIBER OPTIC "NO LEFT TURN"	[Symbol]	[Symbol]
DOUBLE HANDHOLE	[Symbol]	[Symbol]	ILLUMINATED SIGN, FIBER OPTIC "NO RIGHT TURN"	[Symbol]	[Symbol]
G.S. CONDUIT IN TRENCH OR PUSHED	[Symbol]	[Symbol]	TELEPHONE CONNECTION	[Symbol]	[Symbol]
UN-INTERRUPTIBLE POWER SUPPLY (UPS)	[Symbol]	[Symbol]			

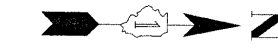

CONSTRUCTION NOTES:

INSTALL NEW CONTROLLER AND TYPE IV CABINET (SPECIAL). RELOCATE EXISTING EMERGENCY VEHICLE PRIORITY SYSTEM, PHASING UNIT TO NEW CONTROLLER CABINET AND RELOCATE DETECTOR UNIT ON NEW MAST ARM. RELOCATION OF THE EMERGENCY PRIORITY SYSTEM EQUIPMENT SHALL BE INCLUDED IN THE NEW CONTROLLER UNIT PRICE.

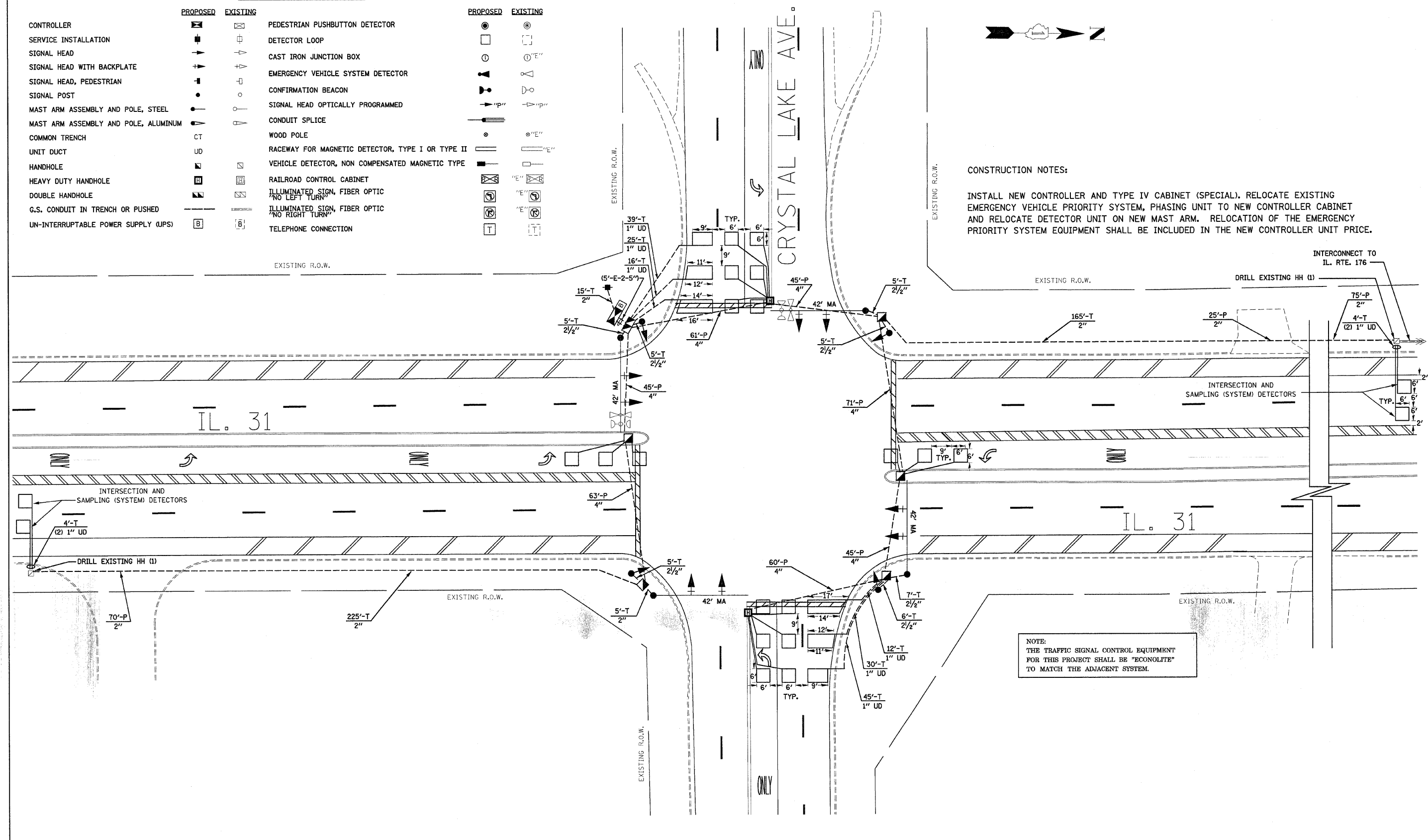

FILE NAME = e:\projects\103408\tr\aff\10.dgn	USER NAME = nguyenm	DESIGNED - SN	REVISED -	STATE OF ILLINOIS DEPARTMENT OF TRANSPORTATION	TRAFFIC SIGNAL INSTALLATION IL.31 @ CRYSTAL LAKE AVE.		F.A.P. RTE. 336	SECTION 112 R-N-1	COUNTY McHENRY	TOTAL SHEETS 31	SHEET NO. 11	
	PLOT SCALE = 20,000 1/ IN.	CHECKED - DAD	REVISED -		SCALE:	SHEET NO. OF	SHEETS	STA.	TO STA.	CONTRACT NO. 60052		
	PLOT DATE = 10/9/2007	DATE - OCT. 5, 2007	REVISED -		FED. ROAD DIST. NO. 1 [ILLINOIS] FED. AID PROJECT							

CONTROLLER SEQUENCE

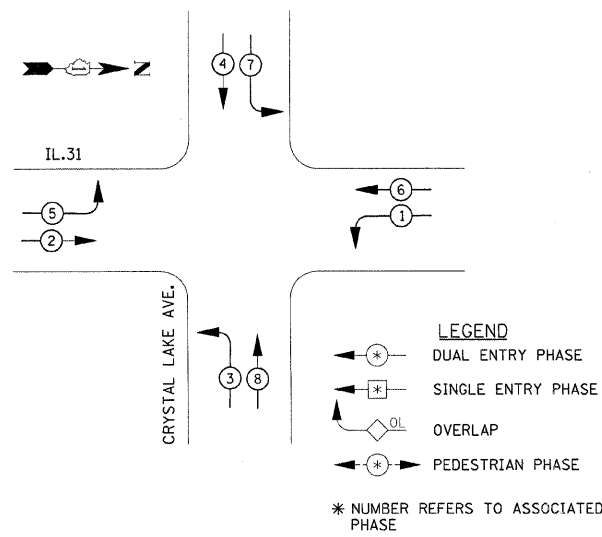

PHASE DESIGNATION DIAGRAM

EMERGENCY VEHICLE PREEMPTION SEQUENCE

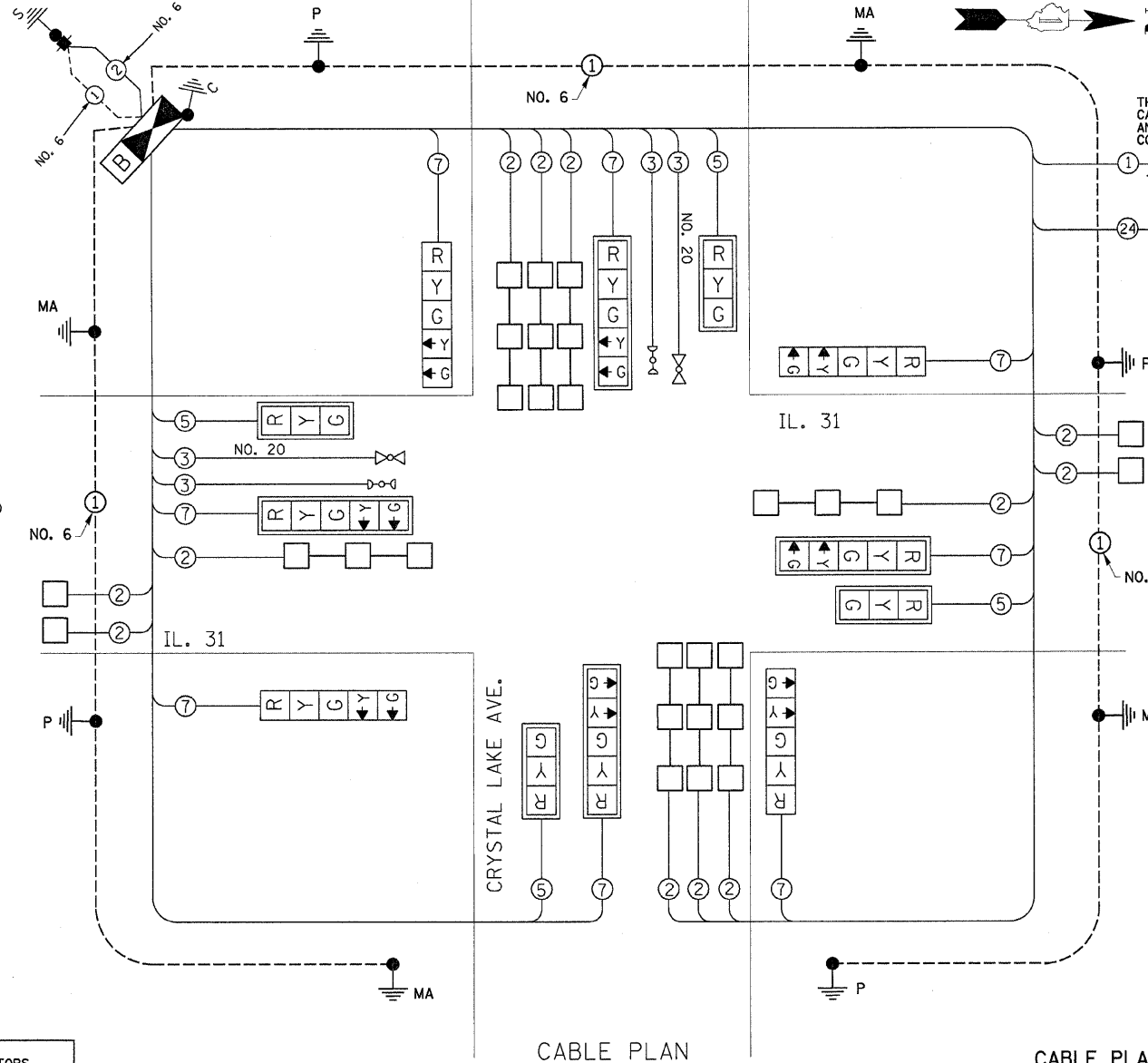
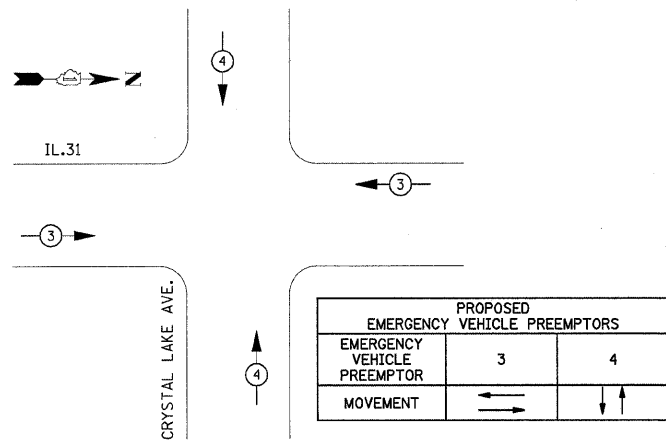

CABLE PLAN

CABLE PLAN LEGEND

EXISTING	PROPOSED	EXISTING	PROPOSED	DESCRIPTION
Ⓛ	Ⓛ	Ⓛ	Ⓛ	GROUND CABLE IN CONDUIT NO. 6 SOLID COPPER (GREEN)
Ⓜ	Ⓜ	Ⓜ	Ⓜ	FIBER OPTIC CABLE IN CONDUIT NO. 62.5/125 MM12F SM12F
Ⓡ	Ⓡ	Ⓡ	Ⓡ	SIGNAL FACE WITH BACKPLATE, "P" INDICATES PROGRAMMED HEAD
Ⓢ	Ⓢ	Ⓢ	Ⓢ	RAILROAD CONTROL CABINET
Ⓣ	Ⓣ	Ⓣ	Ⓣ	ILLUMINATED SIGN "NO LEFT TURN"
Ⓤ	Ⓤ	Ⓤ	Ⓤ	ILLUMINATED SIGN "NO RIGHT TURN"
Ⓥ	Ⓥ	Ⓥ	Ⓥ	GROUND ROD AT HANDHOLE (H), DOUBLE HANDHOLE (H), OR CONTROLLER (C)
Ⓦ	Ⓦ	Ⓦ	Ⓦ	GROUND ROD AT POST (P), OR MAST ARM POLE (MA)
Ⓧ	Ⓧ	Ⓧ	Ⓧ	GROUND ROD AT ELECTRIC SERVICE INSTALLATION
Ⓨ	Ⓨ	Ⓨ	Ⓨ	UN-INTERRUPTIBLE POWER SUPPLY (UPS)

SCHEDULE OF QUANTITIES

ITEM	UNIT	QUANTITY
SERVICE INSTALLATION, POLE MOUNT	EACH	1
CONDUIT IN TRENCH, 2" DIA., GALVANIZED STEEL	FOOT	490
CONDUIT IN TRENCH, 2 1/2" DIA., GALVANIZED STEEL	FOOT	41
CONDUIT IN TRENCH, 5" DIA., GALVANIZED STEEL	FOOT	10
CONDUIT PUSHED, 2" DIA., GALVANIZED STEEL	FOOT	95
CONDUIT PUSHED, 4" DIA., GALVANIZED STEEL	FOOT	430
HANDHOLE	EACH	5
HEAVY DUTY HANDHOLE	EACH	2
DOUBLE HANDHOLE	EACH	1
TRENCH AND BACKFILL FOR ELECTRICAL WORK	FOOT	541
FULL-ACTUATED CONTROLLER AND TYPE IV CABINET (SPECIAL)	EACH	1
ELECTRIC CABLE IN CONDUIT NO.20 3C, TWISTED, SHIELDED	FOOT	300
ELECTRIC CABLE IN CONDUIT, SIGNAL, NO.14, 3C	FOOT	300
ELECTRIC CABLE IN CONDUIT, SIGNAL, NO.14, 5C	FOOT	768
ELECTRIC CABLE IN CONDUIT, SIGNAL, NO.14, 7C	FOOT	3459
ELECTRIC CABLE IN CONDUIT, LEAD-IN, NO.14, 1 PAIR	FOOT	1718
ELECTRIC CABLE IN CONDUIT, SERVICE, NO.6, 2C	FOOT	25
ELECTRIC CABLE IN CONDUIT, GROUNDING, NO.6, 1C	FOOT	420
DRILL EXISTING HANDHOLE	EACH	2
STEEL MAST ARM ASSEMBLY AND POLE, 42 FT.	EACH	4
CONCRETE FOUNDATION, TYPE C	FOOT	4
CONCRETE FOUNDATION, TYPE E, 36-INCH DIAMETER	FOOT	60
SIGNAL HEAD, L.E.D., 1-FACE, 3-SECTION, MAST ARM MOUNTED	EACH	4
SIGNAL HEAD, L.E.D., 1-FACE, 5-SECTION, BRACKET MOUNTED	EACH	4
SIGNAL HEAD, L.E.D., 1-FACE, 5-SECTION, MAST ARM MOUNTED	EACH	4
TRAFFIC SIGNAL BACKPLATE, LOUVERED, ALUMINUM	EACH	8
INDUCTIVE LOOP DETECTOR	EACH	12
DETECTOR LOOP, TYPE 1	FOOT	918
TRANSCEIVER - FIBER OPTIC	EACH	1
UN-INTERRUPTIBLE POWER SUPPLY	EACH	1

I.D.O.T. TRAFFIC SIGNAL INSTALLATION ELECTRICAL SERVICE REQUIREMENTS					TOTAL WATTAGE
TYPE	NO. LAMPS	WATTAGE (INCAND.)	WATTAGE (LED)	% OPERATION	
SIGNAL (RED)	12	135	17	0.50	102.00
(YELLOW)	12	135	25	0.25	75.00
(GREEN)	12	135	15	0.25	45.00
ARROW	16	135	12	0.10	19.20
PED. SIGNAL		90	25	1.00	
CONTROLLER	1	100	100	1.00	100.00
ILLUM. SIGN		84		0.05	
FLASHER				0.50	
ENERGY COSTS TO:				TOTAL =	341.20
ILLINOIS DEPARTMENT OF TRANSPORTATION 201 WEST CENTER COURT SCHAUMBURG, ILLINOIS 60196-1096					
ENERGY SUPPLY CONTACT: PHONE: 847) 816-5248 COMPANY: COMED					

FOUNDATION (DEPTH)	(FT.) (m)	CABLE SLACK	(FT.) (m)	VERTICAL	(FT.) (m)
TYPE A - POST	4 (1.2)	HANDHOLE	6.5 (2.0)	ALL FOUNDATIONS	3.5 (1.0)
D - FOUNDATION	4 (1.2)	DOUBLE HANDHOLE	13 (4.0)	MAST ARM (L) POLE	20' + L - 2 = (6m+L-0.6m)=
C - M. ARM POLE		SIGNAL POST	2 (1.0)		
24" (600mm)	10 (3.0)	CONTROLLER CAB.	1 (0.5)	BRACKET MOUNTED	13 (4.0)
30" (750mm)	15 (4.6)	FIBER OPTIC	13 (4.0)	PED. PUSHBUTTON	4 (1.2)
		ELECTRIC SERVICE	1 (0.5)	ELECTRIC SERVICE	13.5 (4.1)
		GROUND CABLE	1 (0.5)	SERVICE TO GROUND	13.5 (4.1)
				POST MOUNTED	6 (1.8)

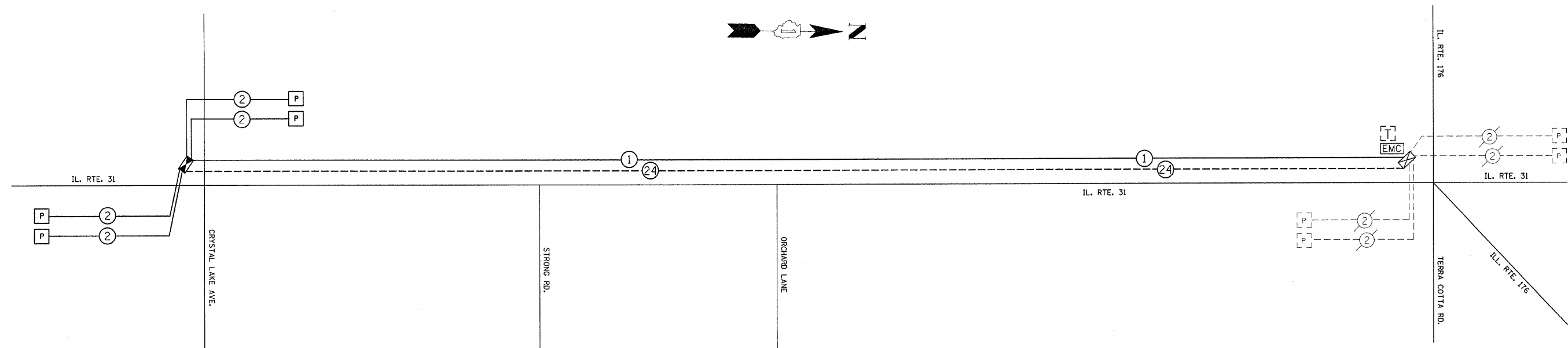

SCHEDULE OF QUANTITIES

ITEM	UNIT	QUANTITY
ELECTRIC CABLE IN CONDUIT, TRACER, NO.14 1C	FOOT	2785
FIBER OPTIC CABLE IN CONDUIT, NO.62.5 / 125, MM12F SM12F	FOOT	2785
REMOVE ELECTRIC CABLE FROM CONDUIT	FOOT	2785
RE-OPTIMIZE TRAFFIC SIGNAL SYSTEM - LEVEL I	EACH	1

INTERCONNECT SCHEMATIC LEGEND

EXISTING INTERSECTION CONTROLLER		PROPOSED SAMPLING (SYSTEM) PREFORMED DETECTORS	
PROPOSED INTERSECTION CONTROLLER		EXISTING FIBER OPTIC CABLE IN CONDUIT, NO. 62.5/125, MM12F SM12F	
EXISTING MASTER CONTROLLER		PROPOSED FIBER OPTIC CABLE IN CONDUIT, NO. 62.5/125, MM12F SM12F	
PROPOSED MASTER CONTROLLER		EXISTING INTERCONNECT CABLE - NO. 62.5/125 12F FIBER OPTIC CABLE	
MASTER MASTER CONTROLLER		PROPOSED INTERCONNECT CABLE - NO. 62.5/125 12F FIBER OPTIC CABLE	
EXISTING INTERSECTION & SAMPLING (SYSTEM) DETECTORS		EXISTING INTERCONNECT CABLE - NO. 18 3 PAIR TWISTED, SHIELDED	
PROPOSED INTERSECTION & SAMPLING (SYSTEM) DETECTORS		PROPOSED INTERCONNECT CABLE - NO. 18 3 PAIR TWISTED, SHIELDED	
EXISTING INTERSECTION LOOP DETECTORS		EXISTING LOOP DETECTOR CABLE 2/C TWISTED, SHIELDED	
PROPOSED SAMPLING (SYSTEM) DETECTORS		PROPOSED LOOP DETECTOR CABLE 2/C TWISTED, SHIELDED	
EXISTING SAMPLING (SYSTEM) DETECTORS		EXISTING ELECTRIC CABLE, 1/C NO. 10	
PROPOSED SAMPLING (SYSTEM) DETECTORS		PROPOSED ELECTRIC CABLE, 1/C NO. 14	
EXISTING SAMPLING (SYSTEM) DETECTORS, PROPOSED INTERSECTION AND SAMPLING (SYSTEM) DETECTORS.		EXISTING TELEPHONE CONNECTION	
EXISTING SAMPLING (SYSTEM) DETECTORS, PROPOSED SAMPLING (SYSTEM) DETECTORS.		PROPOSED TELEPHONE CONNECTION	
EXISTING PREFORMED INTERSECTION & SAMPLING (SYSTEM) DETECTORS			
PROPOSED PREFORMED INTERSECTION & SAMPLING (SYSTEM) DETECTORS			
EXISTING SAMPLING (SYSTEM) PREFORMED DETECTORS			

**FOR
INFORMATION
ONLY**

F.A.P. RTE.	SECTION	COUNTY	TOTAL SHEETS	SHEET NO.
336	112 R-N-1	MOHENEY	31	17
STA.	TO STA.			
FED. ROAD DIST. NO.	ILLINOIS	FED. AID PROJECT		
● 336/ILL. 31 C-91-349-96				

TRAFFIC SIGNAL LEGEND

PROPOSED	EXISTING	PROPOSED	EXISTING

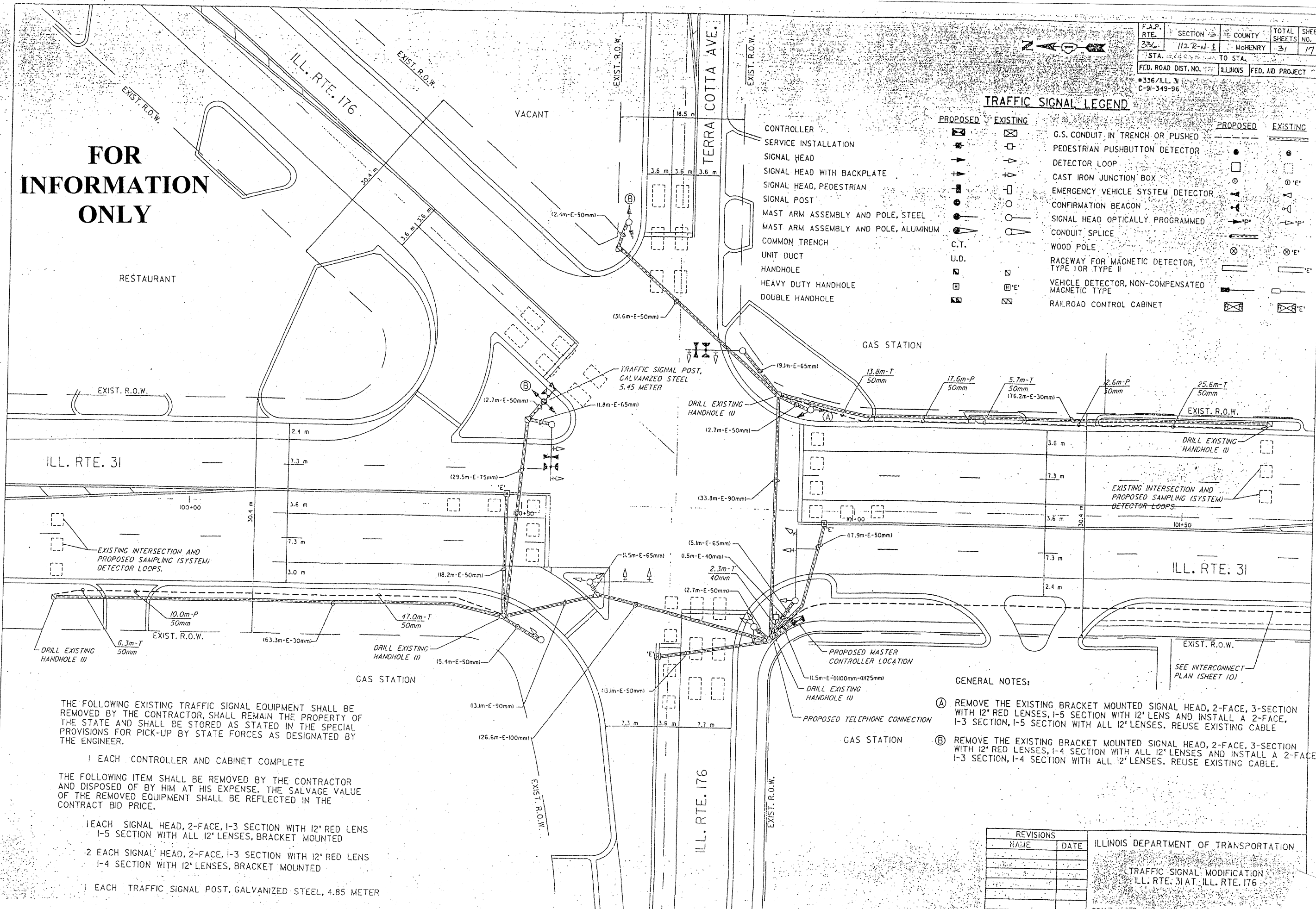

THE FOLLOWING EXISTING TRAFFIC SIGNAL EQUIPMENT SHALL BE REMOVED BY THE CONTRACTOR, SHALL REMAIN THE PROPERTY OF THE STATE AND SHALL BE STORED AS STATED IN THE SPECIAL PROVISIONS FOR PICK-UP BY STATE FORCES AS DESIGNATED BY THE ENGINEER.

1 EACH CONTROLLER AND CABINET COMPLETE

THE FOLLOWING ITEM SHALL BE REMOVED BY THE CONTRACTOR AND DISPOSED OF BY HIM AT HIS EXPENSE. THE SALVAGE VALUE OF THE REMOVED EQUIPMENT SHALL BE REFLECTED IN THE CONTRACT BID PRICE.

1 EACH SIGNAL HEAD, 2-FACE, 1-3 SECTION WITH 12" RED LENS
1-5 SECTION WITH ALL 12" LENSES, BRACKET MOUNTED

2 EACH SIGNAL HEAD, 2-FACE, 1-3 SECTION WITH 12" RED LENS
1-4 SECTION WITH 12" LENSES, BRACKET MOUNTED

1 EACH TRAFFIC SIGNAL POST, GALVANIZED STEEL, 4.85 METER

GENERAL NOTES:

- Ⓐ REMOVE THE EXISTING BRACKET MOUNTED SIGNAL HEAD, 2-FACE, 3-SECTION WITH 12" RED LENSES, 1-5 SECTION WITH 12" LENS AND INSTALL A 2-FACE, 1-3 SECTION, 1-5 SECTION WITH ALL 12" LENSES. REUSE EXISTING CABLE
- Ⓑ REMOVE THE EXISTING BRACKET MOUNTED SIGNAL HEAD, 2-FACE, 3-SECTION WITH 12" RED LENSES, 1-4 SECTION WITH ALL 12" LENSES AND INSTALL A 2-FACE, 1-3 SECTION, 1-4 SECTION WITH ALL 12" LENSES. REUSE EXISTING CABLE.

REVISIONS	
NAME	DATE

ILLINOIS DEPARTMENT OF TRANSPORTATION
TRAFFIC SIGNAL MODIFICATION
ILL. RTE. 31 AT ILL. RTE. 176
SCALE: 1" = 30'
DRAWN BY: GW3
DESIGNED BY: JSD

F.A.P. RTE.	SECTION	COUNTY	TOTAL SHEETS	SHEET NO.
336	112 R-N-1	McHENRY	31	18
STA.		TO STA.		
FED. ROAD DIST. NO.		ILLINOIS	FED. AID PROJECT	
*336/ILL. 31 C-91-349-96				

CABLE PLAN LEGEND

- | EXISTING | PROPOSED | |
|----------|----------|---|
| | | 8' TRAFFIC SIGNAL SECTION |
| | | 12' TRAFFIC SIGNAL SECTION |
| | | 12' PEDESTRIAN SIGNAL SECTION |
| | | 12' PEDESTRIAN SIGNAL SECTION |
| | | CONTROLLER CABINET |
| | | SERVICE INSTALLATION |
| | | VEHICLE DETECTOR, INDUCTION LOOP |
| | | MAGNETIC DETECTOR |
| | | EMERGENCY VEHICLE LIGHT DETECTOR |
| | | CONFIRMATION BEACON |
| | | PUSHBUTTON DETECTOR |
| | | DENOTES NUMBER OF CONDUCTORS.
ALL CABLE NO. 14 EXCEPT AS INDICATED.
ALL LOOP DETECTOR CABLE TO BE SHIELDED. |
| | | SIGNAL FACE WITH BACKPLATE.
'P' INDICATES PROGRAMMED HEAD |

NOTE:
THIS SHEET IS TO SHOW THE NEW FIBER OPTIC CABLE INSTALLATION ONLY. OTHERWISE THIS IS FOR INFORMATION ONLY.

SCHEDULE OF QUANTITIES

ITEM	UNIT	QUANTITY
MAINTENANCE OF EXISTING TRAFFIC SIGNAL INSTALLATION	EACH	1

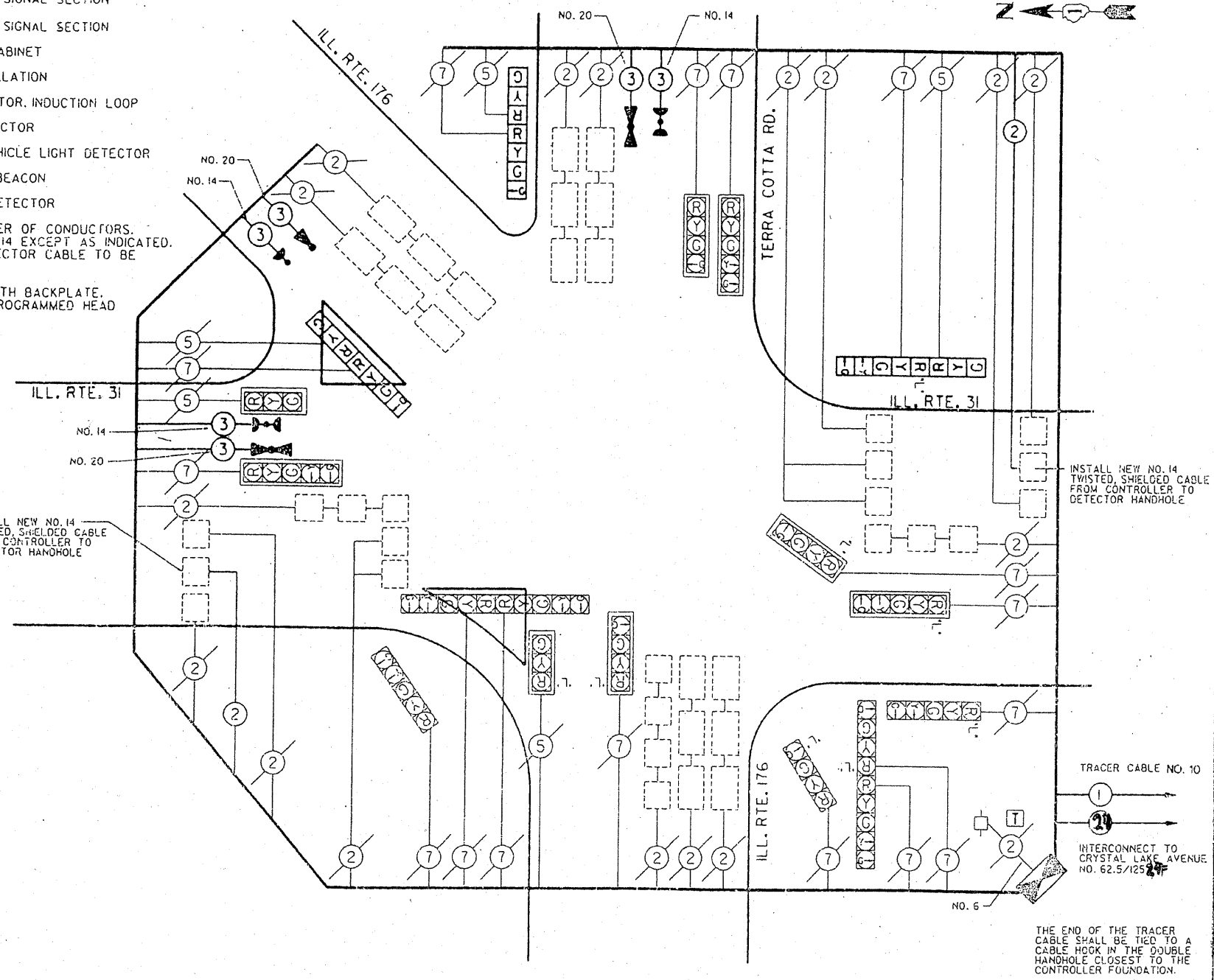

CABLE PLAN

REVISIONS		ILLINOIS DEPARTMENT OF TRANSPORTATION
NAME	DATE	
		SCHEDULE OF QUANTITIES, CABLE PLAN AND ILL. RTE. 31 AT ILL. RTE. 176

DATE: _____ DESIGNED BY: JRD

F.A.P. RTE.	SECTION	COUNTY	TOTAL SHEETS	SHEET NO.
336	112 R-N-1	MCHEERY	31	19
STA. 100+00		TO STA. 103+50		
FED. ROAD DIST. NO.	ILLINOIS	FED. AID PROJECT		

*336/LL-31
C-91-349-96



INTERCONNECT PLAN LEGEND

	PROPOSED	EXISTING
CONTROLLER		
HANDHOLE		
DOUBLE HANDHOLE		
G.S. CONDUIT IN TRENCH OR PUSHED		
DETECTOR LOOP		
COMMON TRENCH	C.T.	
UNIT DUCT	U.D.	
SYSTEM	S	
INTERSECTION	IP	I

NOTE:
ALL DISTURBED GROUND AREAS CAUSED BY THE INSTALLATION OF THE TRAFFIC SIGNAL HANDHOLES, CONDUIT RUNS AND TRENCHING SHALL BE RESTORED IN ACCORDANCE WITH ARTICLE 211 AND ARTICLE 232 OF THE STANDARD SPECIFICATIONS FOR ROAD AND BRIDGE CONSTRUCTION, ADOPTED JAN. 1, 1997.
THE TYPE OF RESTORATION SHALL BE TOPSOIL, 4 INCHES (100mm) AND SODDING, SALT TOLERANT.
THIS WORK SHALL NOT BE PAID FOR DIRECTLY, BUT SHALL BE CONSIDERED AS INCIDENTAL TO THE COST OF THE RELATED TRAFFIC SIGNAL PAY ITEMS.

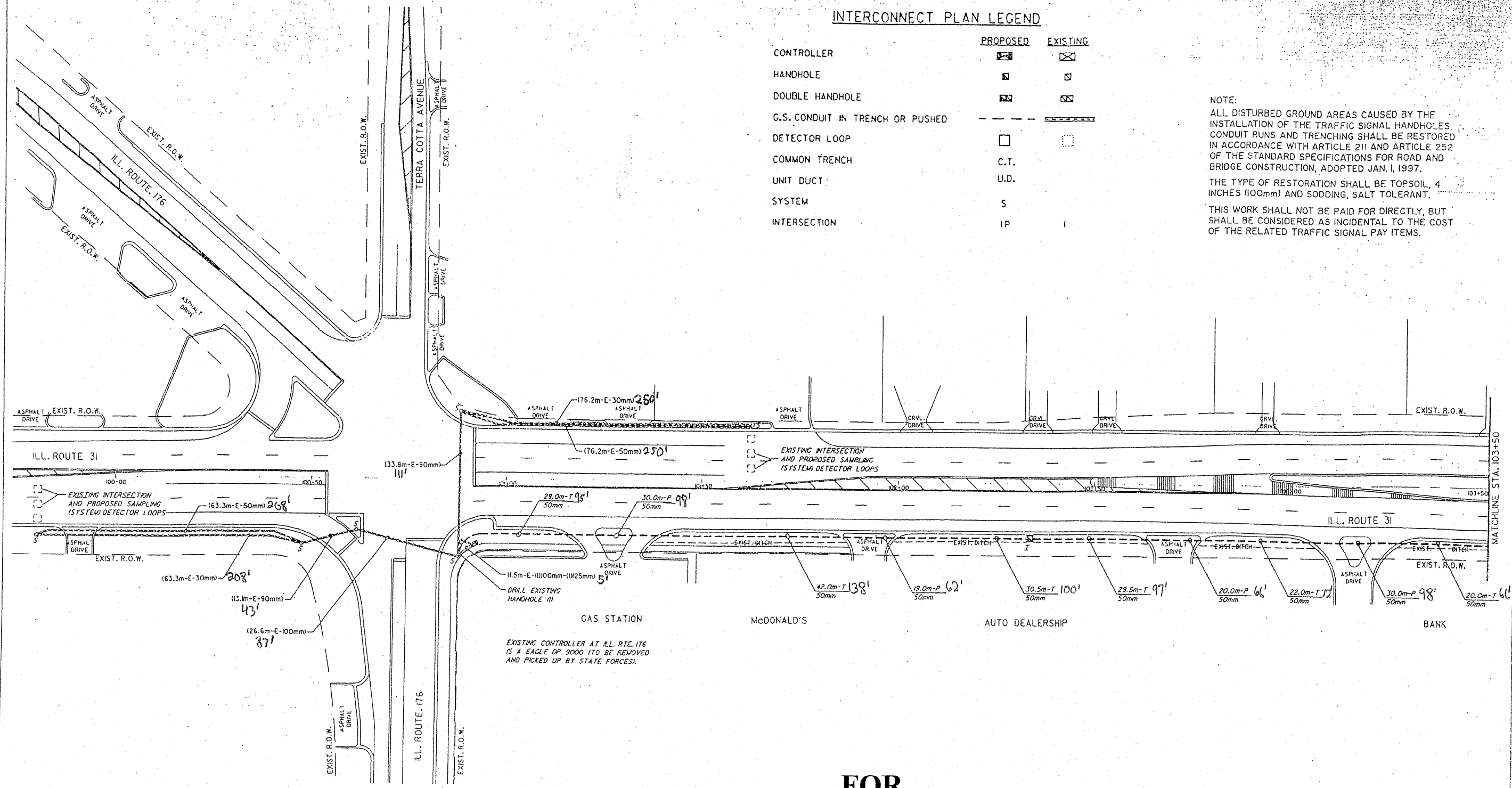

**FOR
INFORMATION
ONLY**

REVISIONS		ILLINOIS DEPARTMENT OF TRANSPORTATION
NAME	DATE	
		INTERCONNECT PLAN ILL. RTE. 31 STA. 100+00 TO STA. 103+50 SCALE: 1:500 DATE: 3-11-97 DESIGNED BY: JRD

F.A.P. RTE.	SECTION	COUNTY	TOTAL SHEETS	SHEET NO.
336	112 R-1	McHENRY	31	20
STA. 103+50		TO STA. 110+00		
FED. ROAD DIST. NO.		ILLINOIS	FED. AID PROJECT	
*336/ILL. 31 C-91-349-96				

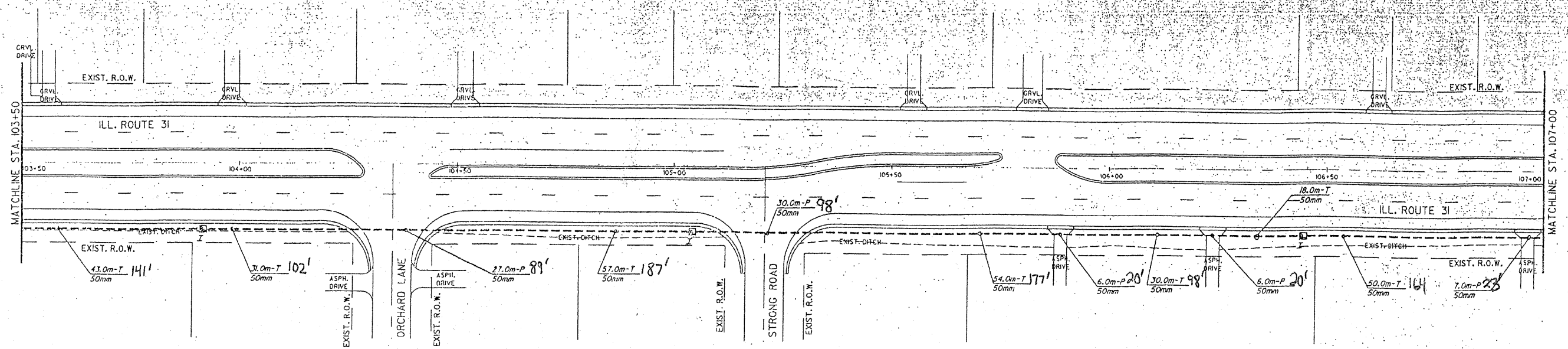
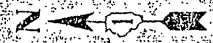

**FOR
INFORMATION
ONLY**

INTERCONNECT PLAN LEGEND

	PROPOSED	EXISTING
CONTROLLER		
HANDHOLE		
DOUBLE HANDHOLE		
G.S. CONDUIT IN TRENCH OR PUSHED		
DETECTOR LOOP		
COMMON TRENCH	C.T.	
UNIT DUCT	U.D.	
SYSTEM	S	
INTERSECTION	IP	

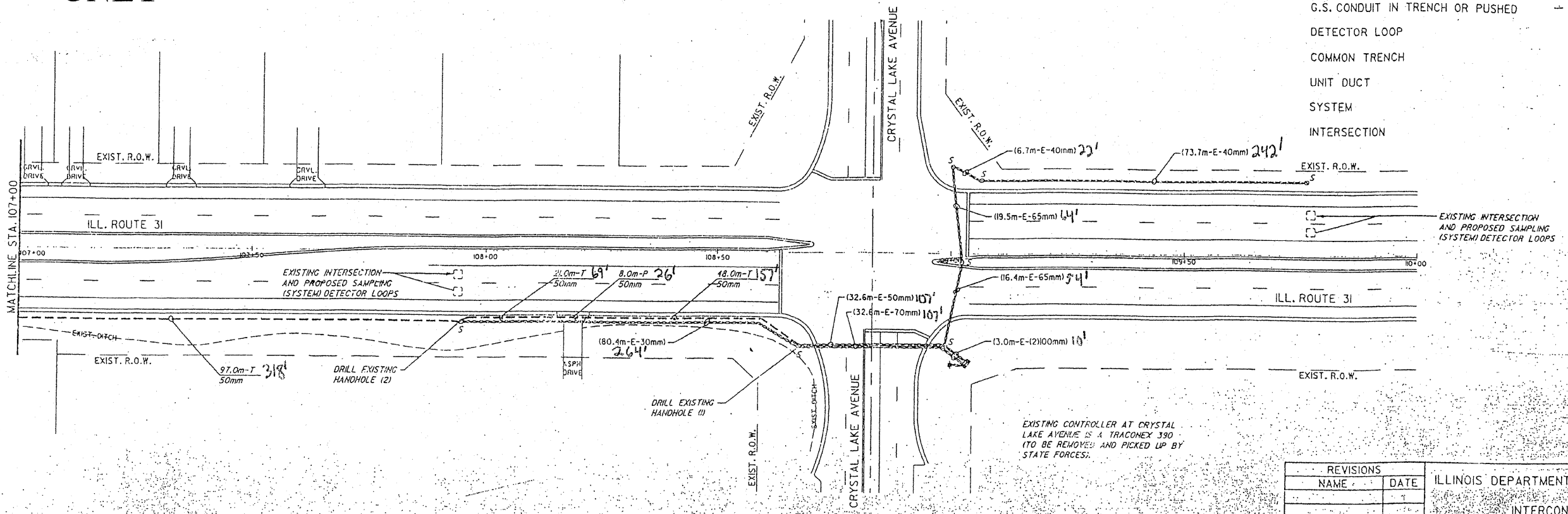

REVISIONS	
NAME	DATE

ILLINOIS DEPARTMENT OF TRANSPORTATION
 INTERCONNECT PLAN
 ILL. RTE. 31
 STA. 103+50 TO STA. 110+00
 SCALE: 1:500
 DATE: 5-11-97 DESIGNED BY: JRD

F.A. RTE.	SECTION	COUNTY	TOTAL SHEETS	SHEET NO.
336	112 R-1-1	McHenry	31	21
STA.		TO STA.		
FED. ROAD DIST. NO. 1 ILLINOIS FED. AID PROJECT				

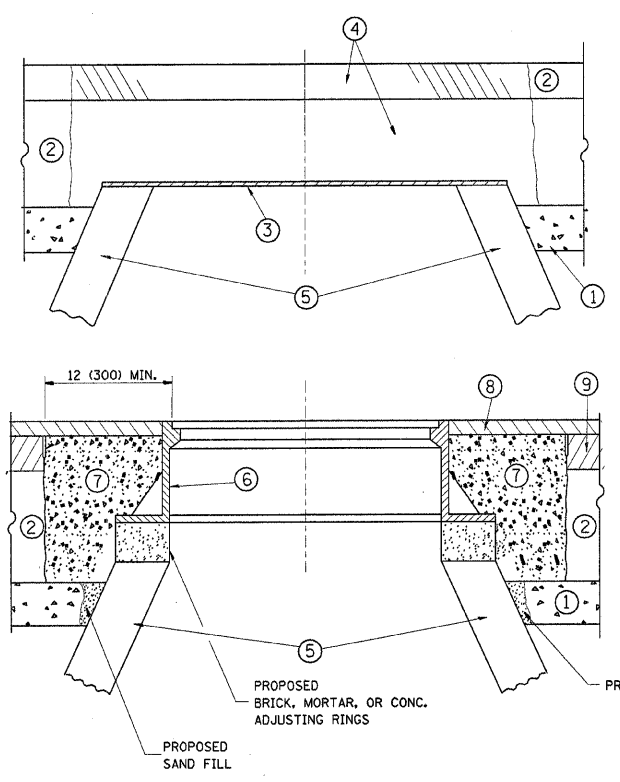

CONSTRUCTION PROCEDURES

STAGE 1 (BEFORE PAVEMENT MILLING)

- A) REMOVE A MINIMUM OF 12 (300) OF THE PAVEMENT FROM AROUND THE STRUCTURE.
- B) REMOVE THE EXISTING FRAME AND LID FROM THE STRUCTURE.
- C) COVER THE STRUCTURE OPENING WITH A 36 (900) DIAMETER METAL PLATE.
- D) BACKFILL WITH CRUSHED STONE AND A MINIMUM 1 1/2 (40) THICK HMA SURFACE MIX APPROVED BY THE ENGINEER.

STAGE 2 (AFTER PAVEMENT MILLING)

- A) REMOVE THE HMA SURFACE MIX AND CRUSHED STONE.
- B) INSTALL THE FRAME AND LID; ADJUST THE FRAME TO ITS FINAL SURFACE ELEVATION.
- C) THE SURROUNDING SPACE SHALL BE FILLED WITH CLASS S1 CONCRETE, OR HMA SURFACE COURSE OR HMA BINDER COURSE TO THE ELEVATION OF THE SURFACE OF THE EXISTING BASE COURSE OR THE BINDER COURSE.

THE PROCEDURE EXPLAINED ABOVE SHALL CONFORM TO THE APPLICABLE PORTIONS OF SECTIONS 353, 406, 602, AND 603 OF THE STANDARD SPECIFICATIONS.

LEGEND

- ① SUB-BASE GRANULAR MATERIAL
- ② EXISTING PAVEMENT
- ③ 36 (900) DIAMETER METAL PLATE
- ④ PROPOSED CRUSHED STONE AND HMA SURFACE MIX
- ⑤ EXISTING STRUCTURE
- ⑥ FRAME AND LID (SEE NOTES)
- ⑦ CLASS S1 CONCRETE, HMA SURFACE COURSE OR HMA BINDER COURSE
- ⑧ PROPOSED HMA SURFACE COURSE
- ⑨ PROPOSED HMA BINDER COURSE

NOTES:

EXISTING BROKEN FRAMES AND LIDS SHALL BE REMOVED AND DISPOSED OF BY THE CONTRACTOR AND SHALL BE REPLACED AS DIRECTED BY THE ENGINEER. REPLACEMENT FRAMES AND LIDS WILL BE PAID FOR IN ACCORDANCE WITH ARTICLE 109.04 OF THE STANDARD SPECIFICATIONS UNLESS A SEPARATE PAY ITEM HAS BEEN PROVIDED.

IF THE EXISTING LIDS ARE OPEN, THE FRAME WILL BE ADJUSTED TO THE ELEVATION OF THE MILLED PAVEMENT SURFACE PRIOR TO THE MILLING OPERATION. THE FRAME WILL NOT BE REMOVED AND COVERED BY THE METAL PLATE.

CITY OF CHICAGO CASTINGS ARE THE PROPERTY OF THE CITY AND THE CONTRACTOR SHALL NOTIFY THE CITY FOR REMOVAL AND DISPOSITION OF THE CASTINGS.

THE METAL PLATE USED TO COVER THE STRUCTURE SHALL REMAIN THE PROPERTY OF THE CONTRACTOR.

WHEN STRUCTURES ARE TO BE ADJUSTED OR RECONSTRUCTED, THE LOWERING AND RAISING OF THE FRAMES AND LIDS WILL NOT BE PAID FOR SEPARATELY BUT WILL BE INCLUDED IN THE COST OF THE CORRESPONDING PAY ITEM.

LOCATION OF STRUCTURES:

THE CONTRACTOR WILL BE REQUIRED TO KEEP A RECORD OF THE LOCATIONS OF THE BURIED STRUCTURES ACCORDING TO THE STATION AND DISTANCE LEFT OR RIGHT OF THE CENTERLINE OF PAVEMENT. UPON COMPLETION OF THE WORK, THE CONTRACTOR WILL DELIVER THE RECORD TO THE ENGINEER.

BASIS OF PAYMENT: THIS WORK WILL BE PAID FOR AT THE CONTRACT UNIT PRICE PER EACH FOR "FRAMES AND LIDS TO BE ADJUSTED, SPECIAL"

NEW FRAMES AND LIDS, WHEN SPECIFIED, WILL BE PAID FOR SEPARATELY.

DETAILS FOR FRAMES AND LIDS ADJUSTMENT WITH MILLING

ALL DIMENSIONS ARE IN INCHES (MILLIMETERS) UNLESS OTHERWISE SHOWN

REVISIONS	
NAME	DATE
R. SHAH	10/25/94
R. SHAH	01/30/95
R. SHAH	03/10/95
A. ABBAS	03/21/97
R. WIEDEMAN	05/14/04
R. BORO	01/01/07

ILLINOIS DEPARTMENT OF TRANSPORTATION
DETAILS FOR FRAMES AND LIDS ADJUSTMENT WITH MILLING

SCALE: VERT. NONE
HORIZ.

DRAWN BY
CHECKED BY
BD600-03 (BD-8)

PLOT DATE = 10/25/2007
PLOT SCALE = 52.9411' / IN.
USER NAME = smhkh1

F.A. RTE.	SECTION	COUNTY	TOTAL SHEETS	SHEET NO.
336	112 R-1-1	McHenry	31	22
STA.		TO STA.		
FED. ROAD DIST. NO. 1 ILLINOIS FED. AID PROJECT				

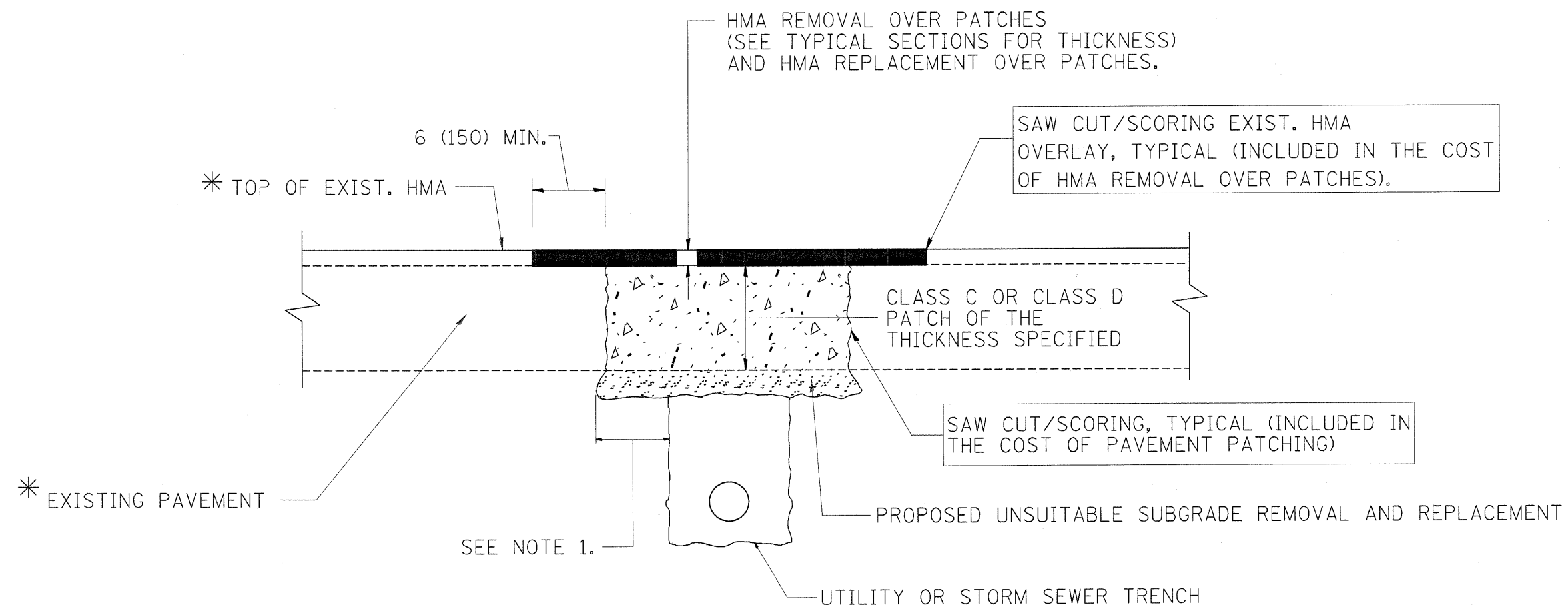

* SEE TYPICAL SECTIONS FOR THICKNESS AND MATERIALS

NOTES:

1. THE WIDTH OF THE FULL DEPTH PATCH OVER A TRENCH SHALL BE 12 (300) WIDER ON EACH SIDE OF THE TRENCH.
2. FOR METHOD OF MEASUREMENT AND BASIS OF PAYMENT, SEE RECURRING SPECIAL PROVISION "PATCHING WITH HOT-MIX ASPHALT OVERLAY REMOVAL".

SEQUENCE OF CONSTRUCTION

1. REMOVE THE EXISTING HMA MATERIAL OVER THE AREA TO BE PATCHED.
2. REMOVE AND REPLACE FULL DEPTH PATCHES
3. REPLACE HMA MATERIAL OVER THE AREA TO BE PATCHED.

ALL DIMENSIONS ARE IN INCHES (MILLIMETERS) UNLESS OTHERWISE SHOWN.

REVISIONS	
NAME	DATE
R. SHAH	10/25/94
R. SHAH	01/14/95
R. SHAH	03/23/95
R. SHAH	04/24/95
A. HOUSEH	03/15/96
A. ABBAS	03/21/97
A. ABBAS	01/20/98
ART ABBAS	04/27/98
R. BORO	01/01/07
R. BORO	09/04/07

ILLINOIS DEPARTMENT OF TRANSPORTATION

PAVEMENT PATCHING FOR HMA SURFACED PAVEMENT

SCALE: VERT. NONE
HORIZ.

DRAWN BY

CHECKED BY

BD400-04 (BD-22)

PLOT DATE = 10/25/2007
FILE NAME = M:\data\bd400-04.dgn
PLOT SCALE = 5/16" = 1' / IN.
USER NAME = bantel

F.A.P. RTE.	SECTION	COUNTY	TOTAL SHEETS	SHEET NO.
336	112 R-N-1	McHenry	31	23
STA. TO STA.		FED. ROAD DIST. NO. 1 ILLINOIS FED. AID PROJECT		

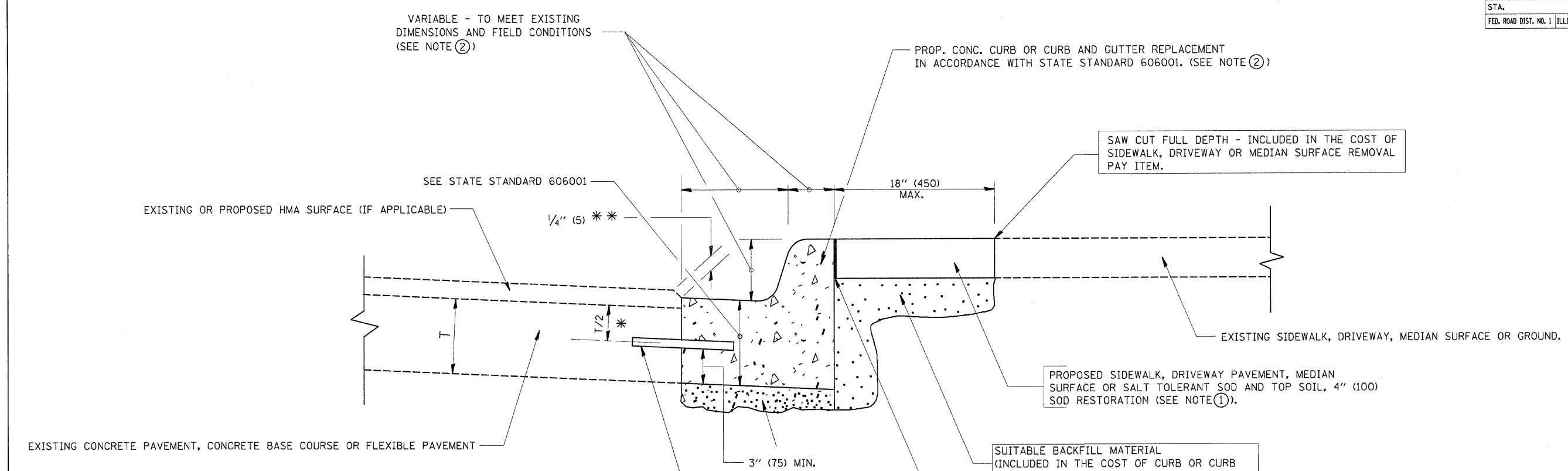

- * 3" (75) MINIMUM FROM TOP AND BOTTOM OF THE CONCRETE PAVEMENT OR BASE COURSE.
- * * IF THE FINAL SURFACE OF THE PAVEMENT IS CONCRETE, THE GUTTER IS TO BE FLUSH WITH THE PAVEMENT.

- NOTE: ① SIDEWALK, DRIVEWAY PAVEMENT OR MEDIAN SURFACE SHALL BE SIMILAR TO THE MATERIAL BEING REMOVED AND WILL BE PAID FOR SEPARATELY.
- SALT TOLERANT SOD AND TOP SOIL, 4" (100) RESTORATION WILL NOT BE PAID FOR SEPARATELY, BUT SHALL BE INCLUDED IN THE COST OF CURB OR CURB AND GUTTER REMOVAL AND REPLACEMENT.
- ② CURB OR CURB AND GUTTER REPLACEMENT SHALL MATCH THE SHAPE OF THE EXISTING CURB OR CURB AND GUTTER UNLESS OTHERWISE SPECIFIED.
- ③ FOR CURB OR CURB AND GUTTER REMOVAL AND REPLACEMENT ADJACENT TO FLEXIBLE PAVEMENT DELETE EPOXY COATED TIE BARS.
- ④ LONGITUDINAL BARS, IF ENCOUNTERED IN THE EXISTING CURB OR CURB AND GUTTER, ARE NOT TO BE REPLACED. CUTTING AND REMOVING LONGITUDINAL BARS SHALL BE INCLUDED IN THE COST OF CURB OR CURB AND GUTTER REMOVAL AND REPLACEMENT.
- ⑤ THE COST OF HMA SURFACE REMOVAL IN THE EXISTING GUTTER FLAG SHALL BE INCLUDED IN THE COST OF THE CURB AND GUTTER REMOVAL AND REPLACEMENT.
- ⑥ THE REMOVAL AND REPLACEMENT OF THE EXISTING CURB OR CURB AND GUTTER SHALL BE DONE IN ACCORDANCE WITH THE APPLICABLE PORTIONS OF SECTION 440 AND 606 OF THE STANDARD SPECIFICATIONS.
- ⑦ THE LOCATIONS OF REMOVAL AND REPLACEMENT OF EXISTING CURB OR CURB AND GUTTER SHALL BE DETERMINED BY THE RESIDENT ENGINEER AT THE TIME OF CONSTRUCTION.

UNSUITABLE SUB-BASE MATERIAL TO BE REMOVED, IF DIRECTED BY THE ENGINEER, SHALL BE REPLACED WITH EITHER SUB-BASE GRANULAR MATERIAL, TYPE B OR ADDITIONAL THICKNESS OF CONCRETE.

REMOVAL AND REPLACEMENT 4" (100) OR LESS IS INCLUDED IN THE COST OF CURB OR CURB AND GUTTER REMOVAL AND REPLACEMENT.

REMOVAL AND REPLACEMENT IN EXCESS OF 4" (100) WILL BE PAID FOR IN ACCORDANCE WITH ARTICLE 109.04 OF THE STANDARD SPECIFICATIONS.

PROPOSED #6 (20) EPOXY COATED TIE BARS 24" (600) LONG AT 24" (600) CENTERS WILL NOT BE PAID FOR SEPARATELY. DELETE EPOXY COATED TIE BARS IF EXISTING TIE BARS ARE USUABLE AS DETERMINED BY THE ENGINEER. (SEE NOTE 3).

BASIS OF PAYMENT:
 THIS WORK WILL BE PAID FOR AT THE CONTRACT UNIT PRICE PER FOOT (METER) FOR "CURB REMOVAL AND REPLACEMENT" OR "COMBINATION CONCRETE CURB AND GUTTER REMOVAL AND REPLACEMENT".

ALL DIMENSIONS ARE IN INCHES (MILLIMETERS) UNLESS OTHERWISE SHOWN.

REVISIONS	
NAME	DATE
A. HOUSEH	03/11/94
R. SHAH	02/24/95
R. SHAH	03/02/95
R. SHAH	08/19/96
R. SHAH	09/12/96
R. SHAH	09/19/96
R. SHAH	10/03/96
A. ABBAS	03/21/97
M. GOMEZ	01/22/01
R. BORO	01/01/07

ILLINOIS DEPARTMENT OF TRANSPORTATION
 CURB OR CURB AND GUTTER REMOVAL AND REPLACEMENT

SCALE: VERT. NONE
 HORIZ. _____
 DRAWN BY _____
 CHECKED BY _____
 BD600-06 (BD-24)

CURB OR CURB AND GUTTER REMOVAL AND REPLACEMENT

PLOT DATE = 10/25/2007
 FILE NAME = W:\data\bd600-06.dgn
 USER = BORO / JN.
 USER NAME = BORO

F.A.P. RTE.	SECTION	COUNTY	TOTAL SHEETS	SHEET NO.
336	112 R-N-1	McHenry	31	24
STA. TO STA.		FED. ROAD DIST. NO. 1 ILLINOIS FED. AID PROJECT		

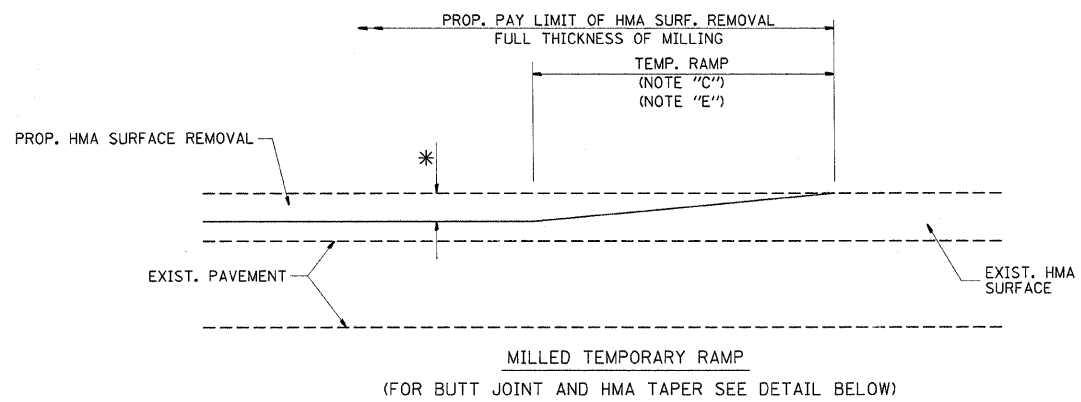

OPTION 1

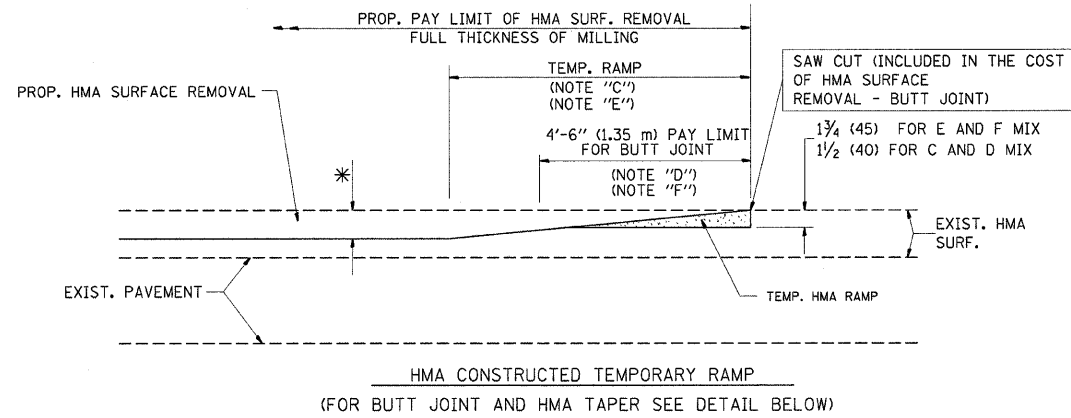

OPTION 2
TYPICAL TEMPORARY RAMP

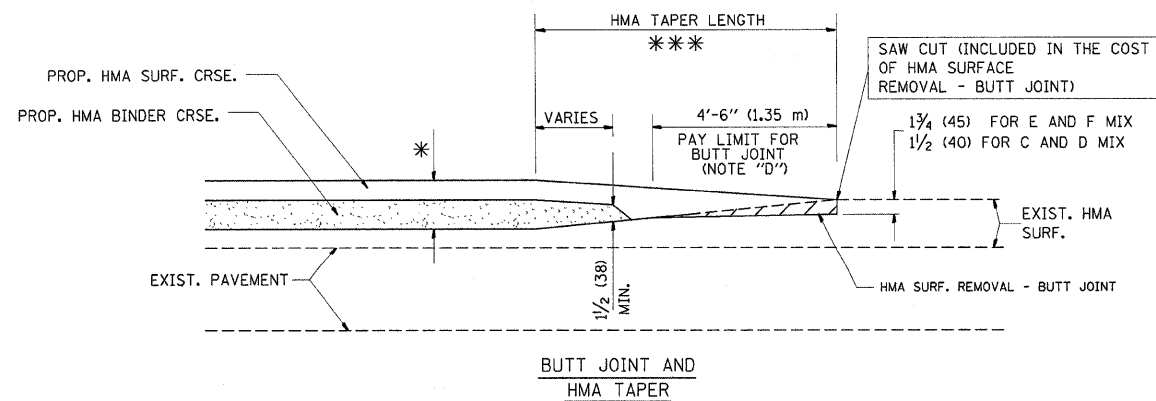

TYPICAL BUTT JOINT AND HMA TAPER
FOR MILLING AND RESURFACING

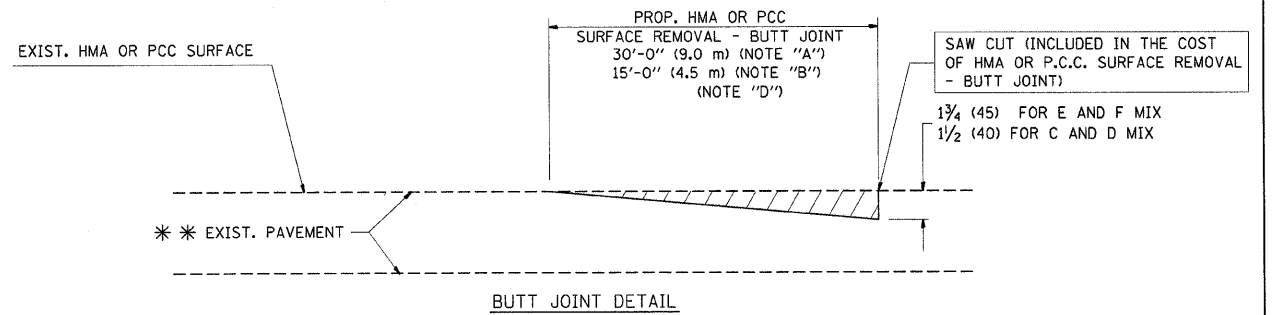

BUTT JOINT DETAIL

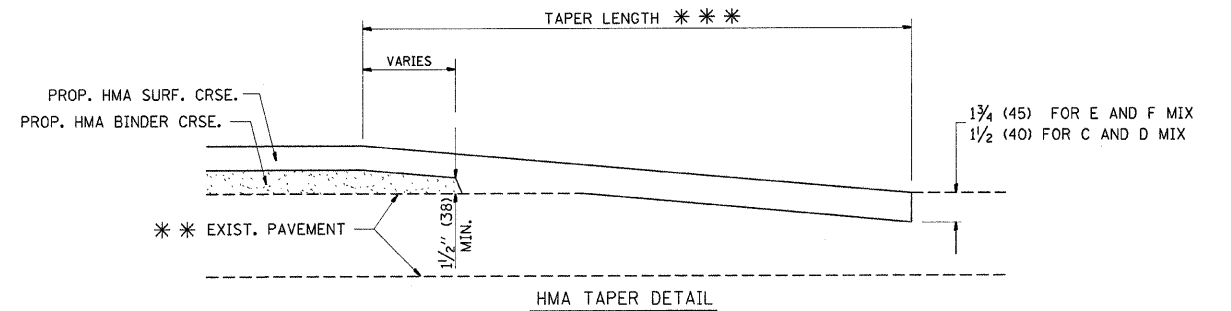

TYPICAL BUTT JOINT AND HMA TAPER
FOR RESURFACING ONLY

*** PC CONCRETE, HMA OR HMA RESURFACED PAVEMENT.

NOTES

- A: MAINLINE ROADWAYS AND MAJOR SIDE ROADS.
- B: MINOR SIDE ROADS.
- C: THE TEMP. RAMP SHALL BE CONSTRUCTED IMMEDIATELY UPON REMOVAL OF THE EXISTING HMA SURFACE.
- D: THE BUTT JOINT SHALL BE CONSTRUCTED IMMEDIATELY PRIOR TO PLACING THE PROPOSED HMA COURSES.
- E: TAPER THE TEMP. RAMP AT A RATE OF 3'-0" (900 mm) PER 1 INCH (25 mm) OF MILLING THICKNESS.
- F: INSTALLATION AND REMOVAL OF THE 4'-6" (1.35 m) TEMP. RAMP IS INCLUDED IN COST OF HMA SURFACE REMOVAL - BUTT JOINT
- G: SEE ARTICLE 406.08 AND 406.14 OF THE STANDARD SPECIFICATIONS FOR "HMA AND/OR PCC SURFACE REMOVAL, BUTT JOINT".
- * SEE TYPICAL SECTIONS FOR MILLING THICKNESS.
- *** 20'-0" (6.1 m) PER 1 (25) RESURFACING (NOTE "A")
10'-0" (3.0 m) PER 1 (25) RESURFACING (NOTE "B")

ALL DIMENSIONS ARE IN INCHES (MILLIMETERS) UNLESS OTHERWISE SHOWN.

BASIS OF PAYMENT:

THE BUTT JOINT WILL BE PAID FOR AT THE CONTRACT UNIT PRICE PER SQUARE YARD (SQUARE METER) FOR "HOT-MIX ASPHALT SURFACE REMOVAL - BUTT JOINT" OR FOR "PORTLAND CEMENT CONCRETE SURFACE REMOVAL - BUTT JOINT".

REVISIONS	
NAME	DATE
M. DE YONG	6-13-90
M. DE YONG	7-3-90
M. DE YONG	3-27-92
R. SHAH	09/09/94
R. SHAH	10/25/94
A. ABBAS	03/21/97
M. GOMEZ	04/06/01
R. BORO	01/01/07

ILLINOIS DEPARTMENT OF TRANSPORTATION

BUTT JOINT AND
HMA TAPER
DETAILS

SCALE: VERT. NONE
HORIZ.

DRAWN BY
CHECKED BY

BD400-05 (VI-BD32)

F.A.P. RTE.	SECTION	COUNTY	TOTAL SHEETS	SHEET NO.
33c	112 R-N-1	McHenry	31	25
STA.		TO STA.		
FED. ROAD DIST. NO.	ILLINOIS	FED. AID PROJECT		

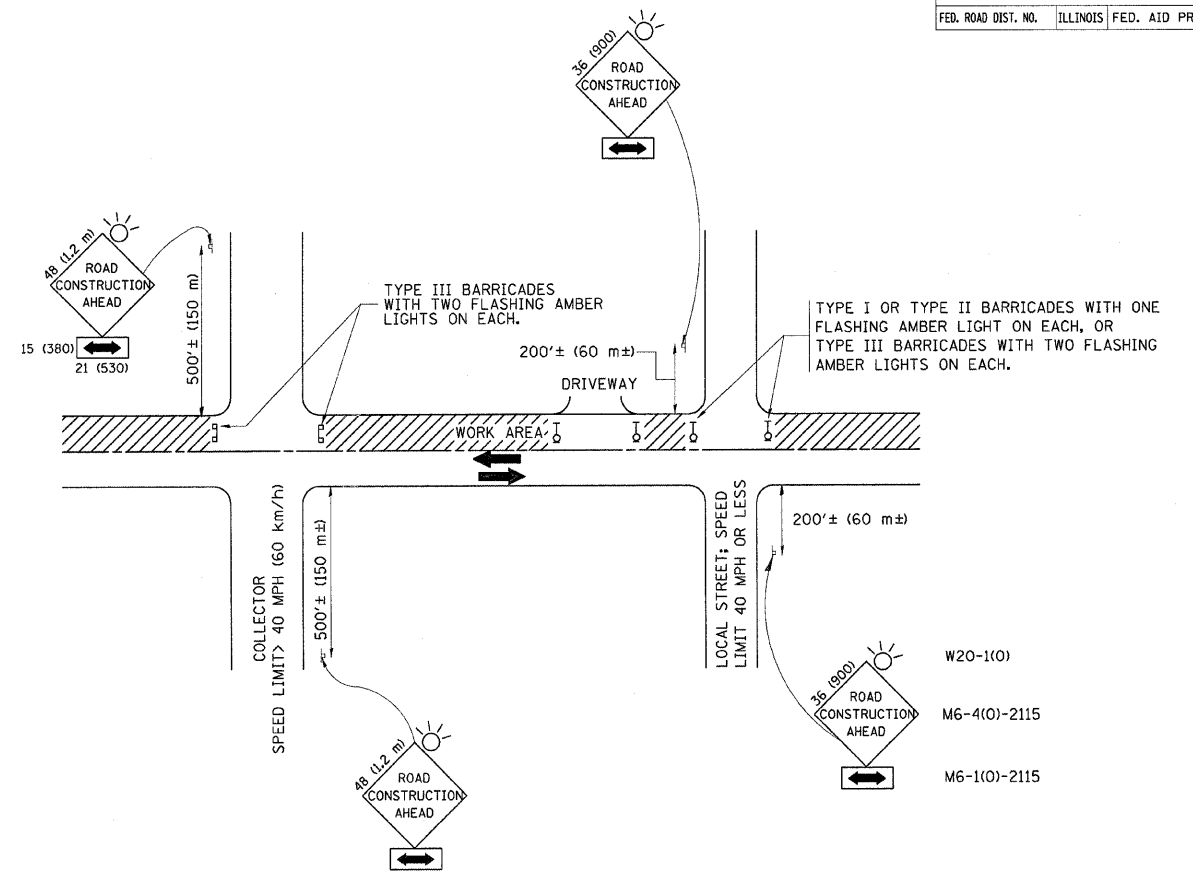

TRAFFIC CONTROL AND PROTECTION FOR SIDE ROADS, INTERSECTIONS, AND DRIVEWAYS

NOTES:

- A. FOR NO LANE RESTRICTION ON THE SIDE ROAD OR DRIVEWAYS
 - 1. SIDE ROAD WITH A SPEED LIMIT OF 40 MPH (60 km/h) OR LESS AS SHOWN ON THE DRAWING AND AS DIRECTED BY THE ENGINEER:
 - a) ONE ROAD CONSTRUCTION AHEAD SIGN 36 x 36 (900x900) WITH A FLASHER AND FLAG MOUNTED ON IT APPROXIMATELY 200' (60 m) IN ADVANCE OF THE MAIN ROUTE.
 - b) THE CLOSED PORTION OF THE MAIN ROUTE SHALL BE PROTECTED BY BLOCKING WITH TYPE I, TYPE II OR TYPE III BARRICADES, 1/3 OF THE CROSS SECTION OF THE CLOSED PORTION.
 - 2. SIDE ROAD WITH A SPEED LIMIT GREATER THAN 40 MPH (60 km/h) AS SHOWN ON THE DRAWING AND AS DIRECTED BY THE ENGINEER:
 - a) ONE ROAD CONSTRUCTION AHEAD SIGN 48 x 48 (1.2 m x 1.2 m) WITH A FLASHER MOUNTED ON IT APPROXIMATELY 500' (150 m) IN ADVANCE OF THE MAIN ROUTE.
 - b) THE CLOSED PORTION OF THE MAIN ROUTE SHALL BE PROTECTED BY BLOCKING WITH TYPE III BARRICADES, 1/2 OF THE CROSS SECTION OF THE CLOSED PORTION.
 - 3. WHEN THE SIDE ROAD LIES BETWEEN THE BEGINNING OF THE MAINLINE SIGNING AND THE WORK ZONE, A SINGLE HEADED ARROW (M6-1) SHALL BE USED IN LIEU OF THE DOUBLE HEADED ARROW (M6-4).
- B. FOR A LANE CLOSURE ON A SIDE ROAD OR DRIVEWAY:
 - USE APPLICABLE PORTIONS OF THE TYPICAL APPLICATION OF TRAFFIC CONTROL DEVICES (STD. 701501, STD. 701606 OR THE APPROPRIATE STANDARD). THE SPACING OF SIGNS AND BARRICADES SHALL BE ADJUSTED FOR FIELD CONDITIONS AS DIRECTED BY THE ENGINEER. THE DIRECTIONAL ARROW SHALL BE COVERED OR REMOVED WHEN NO LONGER CONSISTENT WITH THE SIDE ROAD LANE CLOSURE.
 - C. ADVANCE WARNING SIGNS ARE TO BE OMITTED ON DRIVEWAY UNLESS OTHERWISE NOTED.
 - D. THE TRAFFIC CONTROL AND PROTECTION FOR SIDE ROADS, INTERSECTIONS, AND DRIVEWAYS SHALL BE INCIDENTAL TO THE COST OF SPECIFIED TRAFFIC CONTROL STANDARDS OR ITEMS.

All dimensions are in millimeters (inches) unless otherwise shown.

REVISIONS	
NAME	DATE
LHA	6/89
T. RAMMACHER	09/08/94
J. OBERLE	10/18/95
A. HOUSEH	03/06/96
A. HOUSEH	10/15/96
T. RAMMACHER	01/06/00

ILLINOIS DEPARTMENT OF TRANSPORTATION
 TRAFFIC CONTROL AND PROTECTION FOR SIDE ROADS, INTERSECTIONS, AND DRIVEWAYS

SCALE: NONE
 DRAWN BY
 CHECKED BY
 TC-10

PLOT DATE = 10/25/2007
 FILE NAME = W:\projects\6052\plan\TC-10.dgn
 USER NAME = borick

F.A.P. RTE.	SECTION	COUNTY	TOTAL SHEETS	SHEET NO.
<i>336</i>	<i>112 R-N-1</i>	<i>McHenry</i>	<i>31</i>	<i>26</i>
STA.	TO STA.			
FED. ROAD DIST. NO.	ILLINOIS FED. AID PROJECT			

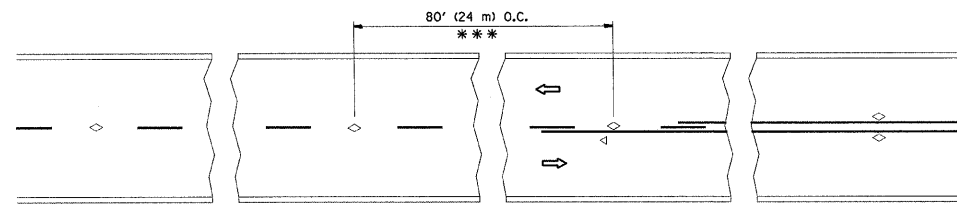

*** REDUCE TO 40' (12 m) O.C. ON CURVES WITH POSTED OR ADVISORY SPEED 45 M.P.H. (70 km/h) OR LESS.

TWO-LANE/TWO-WAY

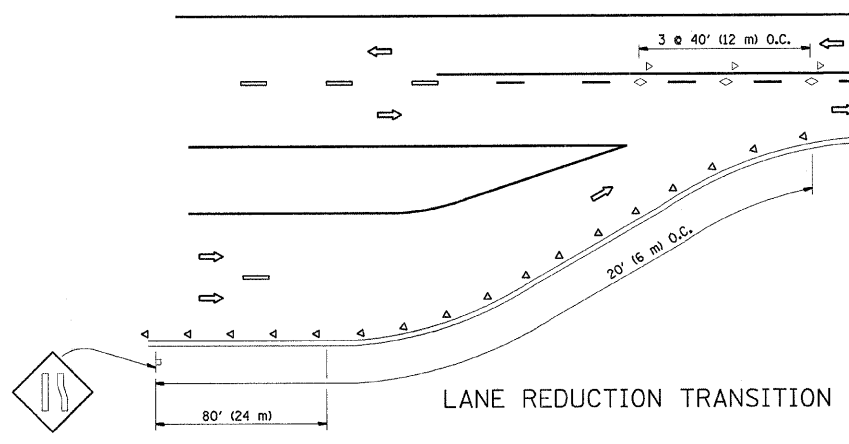

LANE REDUCTION TRANSITION

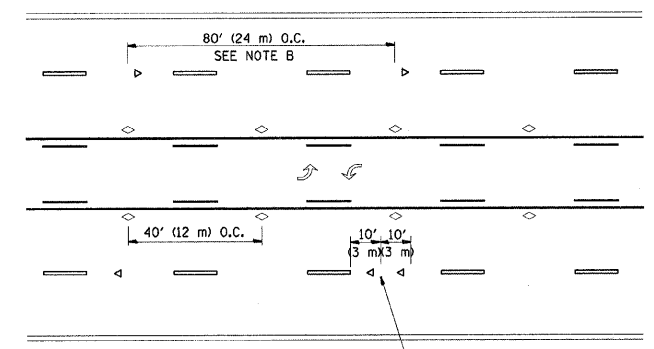

TWO-WAY LEFT TURN

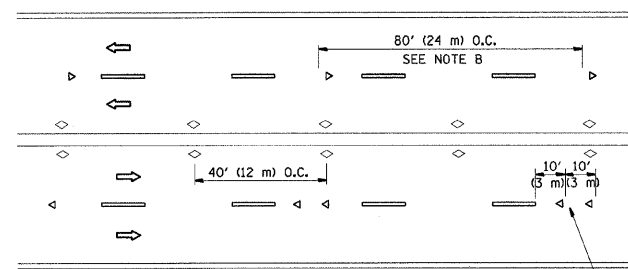

MULTI-LANE/UNDIVIDED

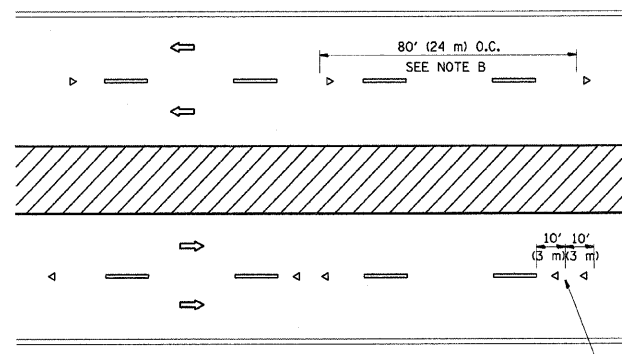

MULTI-LANE/DIVIDED

GENERAL NOTES

1. MARKERS USED WITH DASHED LINES SHALL BE CENTERED IN THE GAP BETWEEN SEGMENTS.
2. MARKERS USED ADJACENT TO SOLID LINES SHALL BE OFFSET 2 TO 3 (50 TO 75) TOWARD TRAFFIC AS SHOWN.
3. MARKERS THROUGH TANGENTS LESS THAN 500' (150 m) IN LENGTH BETWEEN CURVES SHALL BE INSTALLED AT THE LESSER OF THE TWO CURVE SPACINGS.

SYMBOLS

- YELLOW STRIPE
- WHITE STRIPE
- ◁ ONE-WAY AMBER MARKER
- ◁ ONE-WAY CRYSTAL MARKER (W/O)
- ◇ TWO-WAY AMBER MARKER

LANE MARKER NOTES

- A. USE DOUBLE LANE LINE MARKERS SPACED AS SHOWN.
- B. REDUCE TO 40' (12 m) O.C. ON CURVES WHERE ADVISORY SPEEDS ARE 10 M.P.H (20 km/h) LOWER THAN POSTED SPEEDS.

DESIGN NOTES

1. DOUBLE LANE LINE MARKERS SHALL BE USED UNLESS SPECIFIED OTHERWISE.
2. EXCEPT AS SHOWN ON THE LANE REDUCTION TRANSITION AND FREEWAY EXIT RAMP DETAIL, MARKERS ARE NOT TO BE SPECIFIED ON RIGHT EDGE LINES.
3. THE EXACT MARKER LIMITS, SPACING, AND COLOR SHOULD BE INCLUDED IN THE PLANS.
4. MARKERS SHOULD NOT BE USED ALONGSIDE CURBS EXCEPT FOR EXTREMELY SHORT SECTIONS OF CURBS WHERE NOT MORE THAN TWO MARKERS WOULD BE INVOLVED.

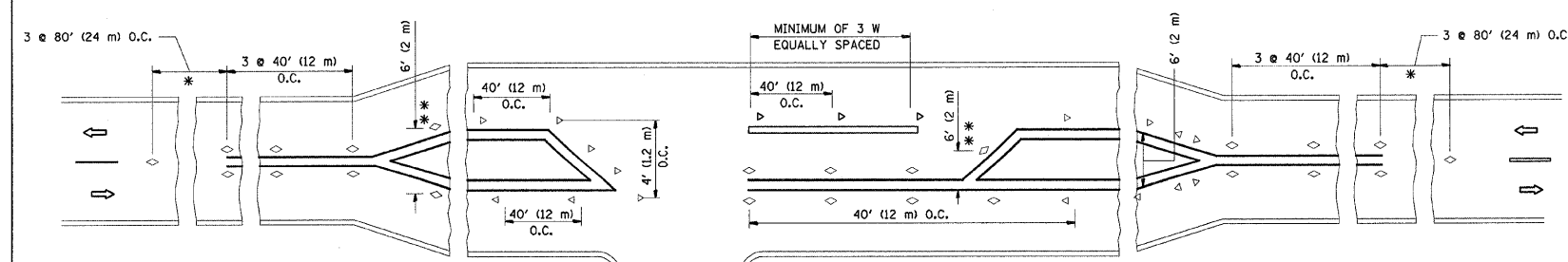

LEFT TURN

* SEE TWO-LANE/TWO-WAY WHERE MARKERS CONTINUE
 ** WHERE THE MEDIAN WIDTH IS 6' (2 m) OR LESS USE TWO-WAY MARKERS.

All dimensions are in inches (millimeters) unless otherwise shown.

REVISIONS	
NAME	DATE
T. RAMMACHER	09-19-94
T. RAMMACHER	03-12-99
T. RAMMACHER	01-06-00

ILLINOIS DEPARTMENT OF TRANSPORTATION
 TYPICAL APPLICATIONS
 RAISED REFLECTIVE PAVEMENT
 MARKERS (SNOW-PLOW RESISTANT)

SCALE: NONE
 DRAWN BY CADD
 CHECKED BY TC-11

PLOT DATE = 10/25/2007
 PLOT SCALE = 1/8" = 1'-0"
 USER NAME = bmkhal

F.A.P. RTE.	SECTION	COUNTY	TOTAL SHEETS	SHEET NO.
336	112 R-1-1	McHenry	31	27
STA.	TO STA.			
FED. ROAD DIST. NO.	ILLINOIS FED. AID PROJECT			

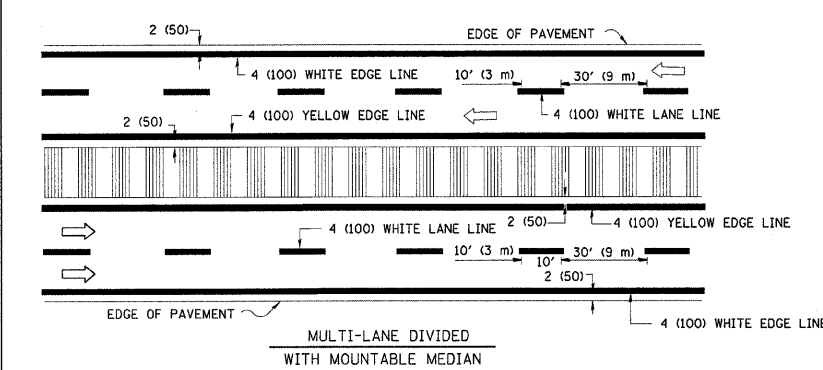
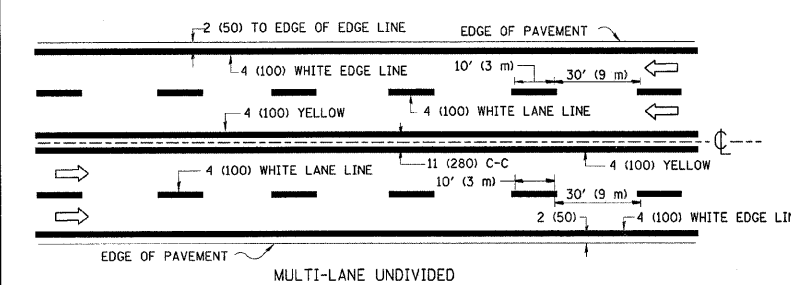
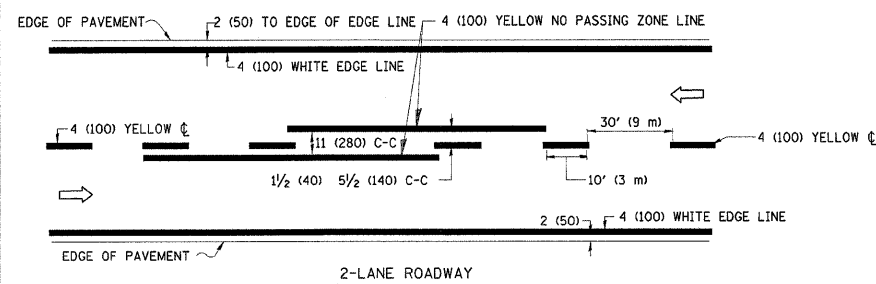

NOTE: MEDIANS WITH BARRIER CURB DO NOT REQUIRE AN EDGE LINE

TYPICAL LANE AND EDGE LINE MARKING

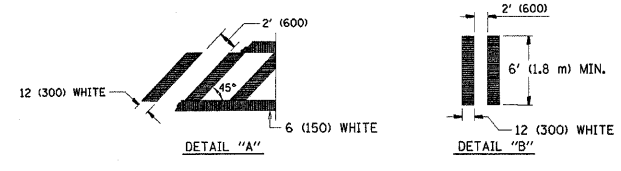
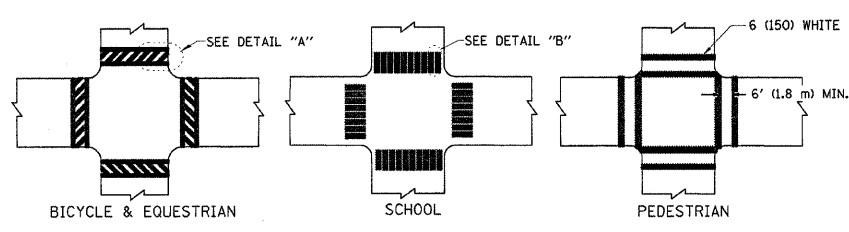

TYPICAL CROSSWALK MARKING

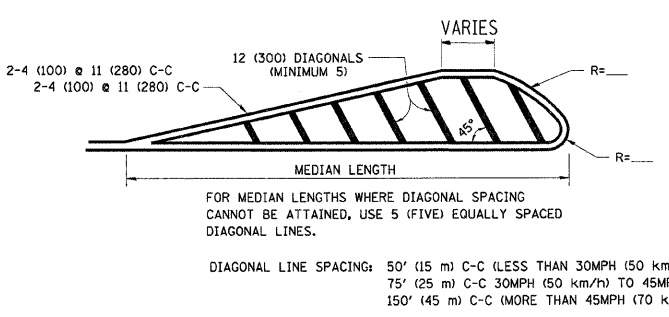
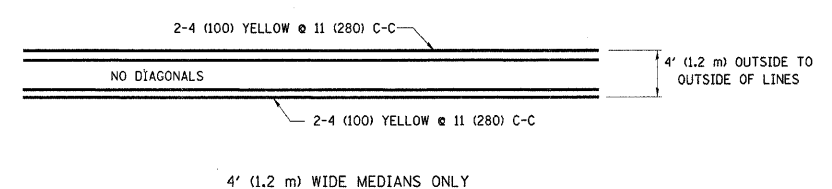

DIAGONAL LINE SPACING: 50' (15 m) C-C (LESS THAN 30MPH (50 km/h))
75' (25 m) C-C 30MPH (50 km/h) TO 45MPH (70 km/h)
150' (45 m) C-C (MORE THAN 45MPH (70 km/h))

MEDIANS OVER 4' (1.2 m) WIDE

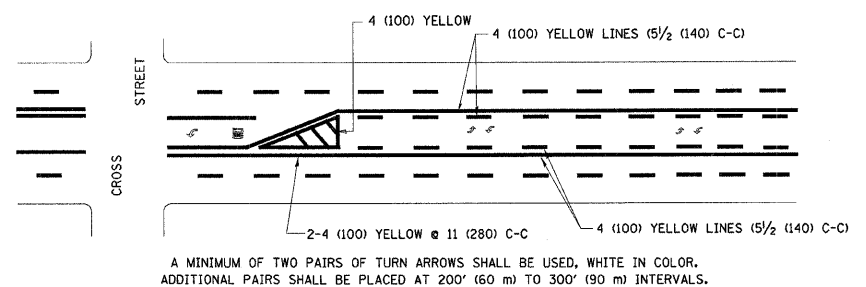

A MINIMUM OF TWO PAIRS OF TURN ARROWS SHALL BE USED, WHITE IN COLOR. ADDITIONAL PAIRS SHALL BE PLACED AT 200' (60 m) TO 300' (90 m) INTERVALS.

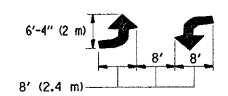

MEDIAN WITH TWO-WAY LEFT TURN LANE

TYPICAL PAINTED MEDIAN MARKING

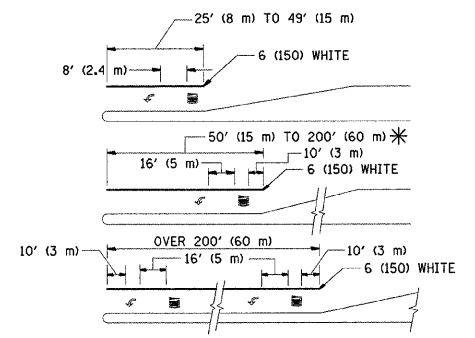

FULL SIZE LETTERS 8' (2.4 m) AND ARROWS SHALL BE USED. AREA = 15.6 SQ. FT. (1.5 m²) ONLY AREA = 20.8 SQ. FT. (1.9 m²)

* TURN LANES IN EXCESS OF 400' (120 m) IN LENGTH MAY HAVE AN ADDITIONAL SET OF ARROW - "ONLY" INSTALLED MIDWAY BETWEEN THE OTHER TWO SETS OF ARROW - "ONLY".

TYPICAL LEFT (OR RIGHT) TURN LANE

TYPICAL TURN LANE MARKING

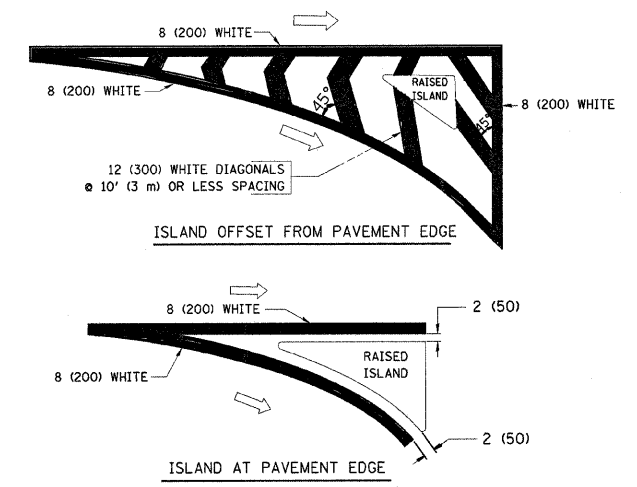

TYPICAL ISLAND MARKING

TYPE OF MARKING	WIDTH OF LINE	PATTERN	COLOR	SPACING / REMARKS
CENTERLINE ON 2 LANE PAVEMENT	4 (100)	SKIP-DASH	YELLOW	10' (3 m) LINE WITH 30' (9 m) SPACE
CENTERLINE ON MULTI-LANE UNDIVIDED PAVEMENT	2 @ 4 (100)	SOLID	YELLOW	11 (280) C-C
NO PASSING ZONE LINES FOR ONE DIRECTION FOR BOTH DIRECTIONS	4 (100) 2 @ 4 (100)	SOLID SOLID	YELLOW YELLOW	5/2 (140) C-C FROM SKIP-DASH CENTERLINE 11 (280) C-C OMIT SKIP-DASH CENTERLINE BETWEEN
LANE LINES	4 (100) 5 (125) ON FREEWAYS	SKIP-DASH SKIP-DASH	WHITE WHITE	10' (3 m) LINE WITH 30' (9 m) SPACE
DOTTED LINES (EXTENSIONS OF CENTER, LANE OR TURN LANE MARKINGS)	SAME AS LINE BEING EXTENDED	SKIP-DASH	SAME AS LINE BEING EXTENDED	2' (600) LINE WITH 6' (1.8 m) SPACE
EDGE LINES	4 (100)	SOLID	YELLOW-LEFT WHITE-RIGHT	OUTLINE MOUNTABLE MEDIANS IN YELLOW; EDGE LINES ARE NOT USED NEXT TO BARRIER CURB
TURN LANE MARKINGS	6 (150) LINE; FULL SIZE LETTERS & SYMBOLS (8' (2.4m))	SOLID	WHITE	SEE TYPICAL TURN LANE MARKING DETAIL
TWO WAY LEFT TURN MARKING	2 @ 4 (100) EACH DIRECTION 8' (2.4m) LEFT ARROW	SKIP-DASH AND SOLID IN PAIRS	YELLOW WHITE	10' (3 m) LINE WITH 30' (9 m) SPACE FOR SKIP-DASH; 5/2 (140) C-C BETWEEN SOLID LINE AND SKIP-DASH LINE SEE TYPICAL TWO-WAY LEFT TURN MARKING DETAIL
CROSSWALK LINES (PEDESTRIAN) A. DIAGONALS (BIKE & EQUESTRIAN) B. LONGITUDINAL BARS (SCHOOL)	2 @ 6 (150) 12 (300) @ 45° 12 (300) @ 90°	SOLID SOLID SOLID	WHITE WHITE WHITE	NOT LESS THAN 6' (1.8 m) APART 2' (600) APART 2' (600) APART SEE TYPICAL CROSSWALK MARKING DETAILS.
STOP LINES	24 (600)	SOLID	WHITE	PLACE 4' (1.2 m) IN ADVANCE OF AND PARALLEL TO CROSSWALK, IF PRESENT. OTHERWISE, PLACE AT DESIRED STOPPING POINT, PARALLEL TO CROSSROAD CENTERLINE, WHERE POSSIBLE
PAINTED MEDIANS	2 @ 4 (100) WITH 12 (300) DIAGONALS @ 45° NO DIAGONALS USED FOR 4' (1.2 m) WIDE MEDIANS	SOLID	YELLOW; TWO WAY TRAFFIC WHITE; ONE WAY TRAFFIC	11 (280) C-C FOR THE DOUBLE LINE SEE TYPICAL PAINTED MEDIAN MARKING.
GORE MARKING AND CHANNELIZING LINES	8 (200) WITH 12 (300) DIAGONALS @ 45°	SOLID	WHITE	DIAGONALS: 15' (4.5 m) C-C (LESS THAN 30MPH (50 km/h)) 20' (6 m) C-C 30MPH (50 km/h) TO 45MPH (70 km/h) 30' (9 m) C-C (OVER 45MPH (70 km/h))
RAILROAD CROSSING	24 (600) TRANSVERSE LINES; "RR" IS 6' (1.8 m) LETTERS; 16 (400) LINE FOR "X"	SOLID	WHITE	SEE STATE STANDARD 780001 AREA OF: "R"=3.6 SQ. FT. (0.33 m ²) EACH "X"=54.0 SQ. FT. (5.0 m ²)
SHOULDER DIAGONALS	12 (300) @ 45°	SOLID	WHITE - RIGHT YELLOW - LEFT	50' (15 m) C-C (LESS THAN 30MPH (50 km/h)) 75' (25 m) C-C (30 MPH (50 km/h) TO 45MPH (70 km/h)) 150' (45 m) C-C (OVER 45MPH (70 km/h))

FOR FURTHER DETAILS ON PAVEMENT MARKING REFER TO STANDARD SPECIFICATIONS FOR ROAD AND BRIDGE CONSTRUCTION AND STATE STANDARD 780001.

All dimensions are in inches (millimeters) unless otherwise shown.

REVISIONS	
NAME	DATE
EVERS	03-19-90
T. RAMMACHER	10-27-94
ALEX HOUSEH	10-09-96
ALEX HOUSEH	10-17-96
T. RAMMACHER	01-06-00

ILLINOIS DEPARTMENT OF TRANSPORTATION

DISTRICT ONE
TYPICAL PAVEMENT MARKINGS

SCALE: NONE

DRAWN BY CAD
CHECKED BY
TC-13

DATE = 10/25/2007
PLOT SCALE = 1/8" = 1'-0"
USER NAME = bmkv1

F.A. RTE.	SECTION	COUNTY	TOTAL SHEETS	SHEET NO.
336	112 R-N-1	McHenry	31	28
STA.		TO STA.		
FED. ROAD DIST. NO.	ILLINOIS	FED. AID PROJECT		

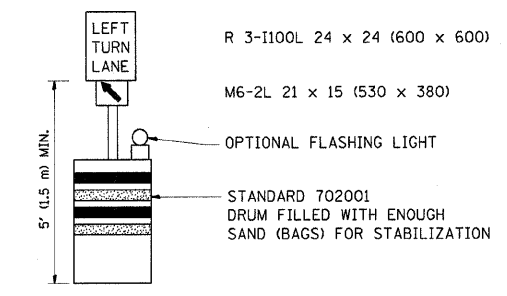
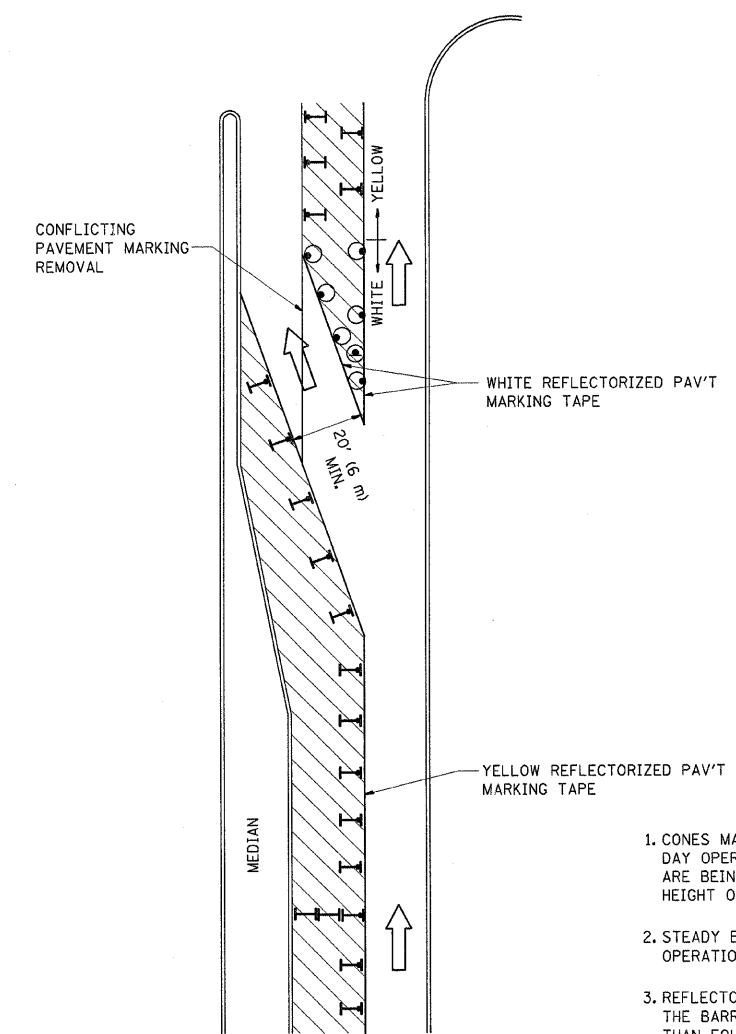







GENERAL NOTES

- CONES MAY BE SUBSTITUTED FOR BARRICADES OR DRUMS AT HALF THE SPACING DURING DAY OPERATIONS. CONES SHALL BE A MINIMUM OF 28 (710) IN HEIGHT. WHEN CONES ARE BEING USED, THE "LEFT TURN LANE" SIGN MAY BE SKID MOUNTED AT A MINIMUM HEIGHT OF 5' (1.5 m).
- STEADY BURNING LIGHTS WILL NOT BE REQUIRED ON BARRICADES OR DRUMS FOR DAY OPERATIONS. ALL LIGHTS SHALL BE MONODIRECTIONAL.
- REFLECTORIZED TEMPORARY PAVEMENT MARKING TAPE SHALL BE PLACED THROUGHOUT THE BARRICADED AREA OF EACH TURN BAY WHERE THE CLOSURE TIME IS GREATER THAN FOURTEEN DAYS.
- THIS APPLICATION ALSO APPLIES WHEN WORK IS BEING PERFORMED IN THE RIGHT LANE(S) AND THE RIGHT TURN BAY IS TO REMAIN OPEN. UNDER THIS CONDITION, "RIGHT TURN LANE" R3-100 24 x 24 (600 x 600) AND M6-2R 21 x 15 (530 x 380) SHALL BE USED.
- THESE CONTROLS SHALL SUPPLEMENT MAINLINE TRAFFIC CONTROL FOR LANE CLOSURES.
- LONGITUDINAL DIMENSIONS MAY BE ADJUSTED TO FIT FIELD CONDITIONS.
- FORM BT 725 IS REQUIRED.
- TRAFFIC CONTROL AND PROTECTION AT TURN BAYS (TO REMAIN OPEN TO TRAFFIC) SHALL BE INCLUDED IN THE COST SPECIFIED TRAFFIC CONTROL STANDARDS OR ITEMS.

All dimensions are in inches (millimeters) unless otherwise shown.

LEGEND

-  WORK AREA
-  LANE OPEN TO TRAFFIC
-  TYPE I OR II BARRICADE WITH STEADY BURN LIGHT
-  DRUM WITH STEADY BURN LIGHT
-  DRUM WITH SIGN (WITH OPTIONAL FLASHING LIGHT) SEE DETAIL
-  TYPE I OR II CHECK BARRICADE WITH FLASHING LIGHT

REVISIONS	
NAME	DATE
T. RAMMACHER	09/08/94
A. HOUSEH	11/07/95
A. HOUSEH	10/12/96
T. RAMMACHER	01/06/00

ILLINOIS DEPARTMENT OF TRANSPORTATION
**TRAFFIC CONTROL AND PROTECTION
 AT TURN BAYS
 (TO REMAIN OPEN TO TRAFFIC)**

SCALE: NONE

DRAWN BY
 CHECKED BY LHA
 TC-14

PLOT DATE = 10/25/2007
 PLOT SCALE = 1/8" = 1'-0"
 USER NAME = bmk14

F.A.P. RTE.	SECTION	COUNTY	TOTAL SHEETS	SHEET NO.
336	112 R-N-1	McHenry	31	29
STA. TO STA.				
FED. ROAD DIST. NO.		ILLINOIS FED. AID PROJECT		

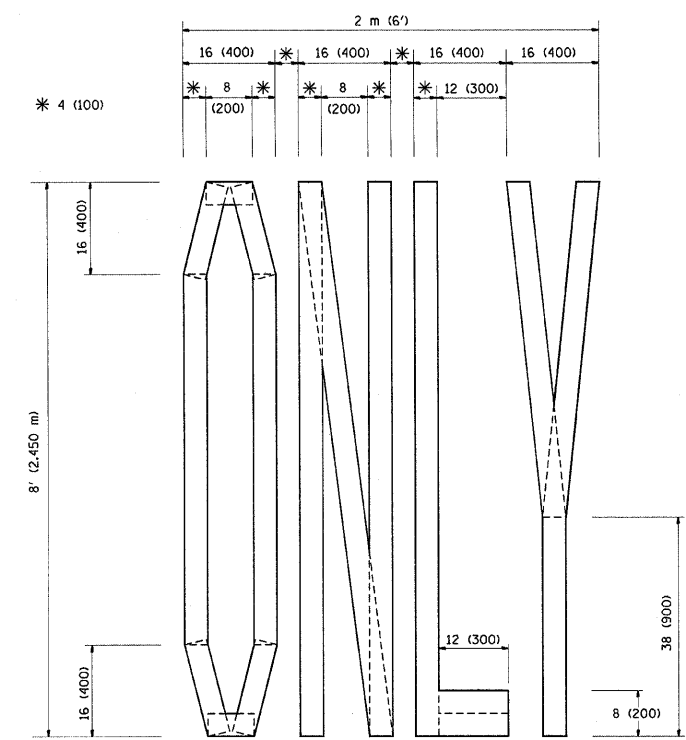

QUANTITY
 4 (100) LINE = 64.1 ft. (19.7 m)
 21.1 sq. ft. (1.97 sq. m)

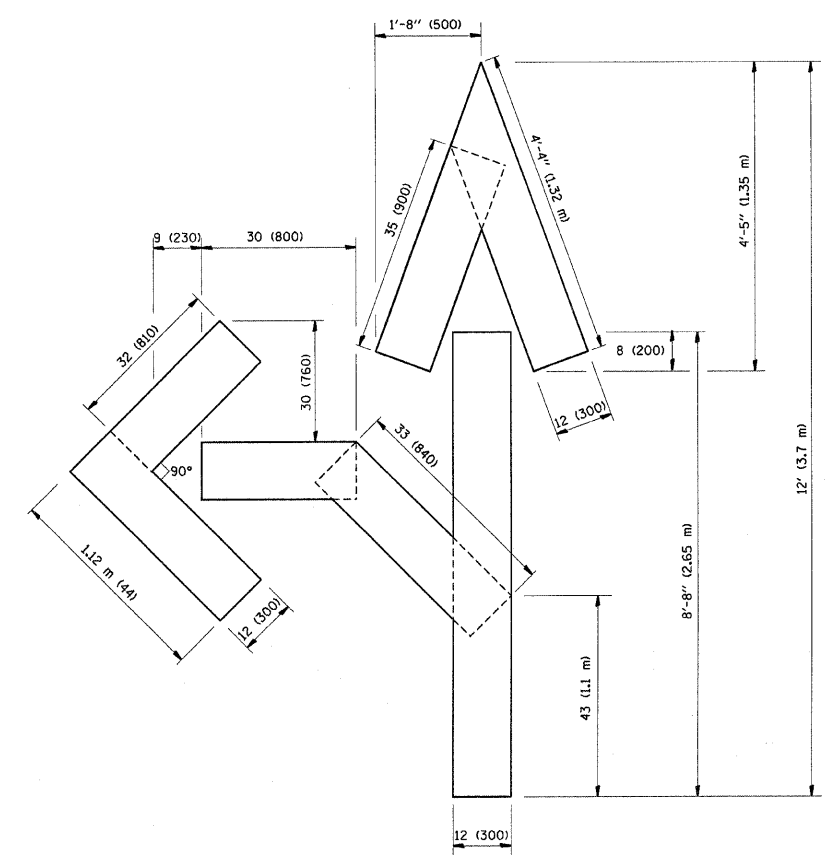

QUANTITY
 4 (100) LINE = 82.5 ft. (25.3 m)
 27.5 sq. ft. (2.53 sq. m)

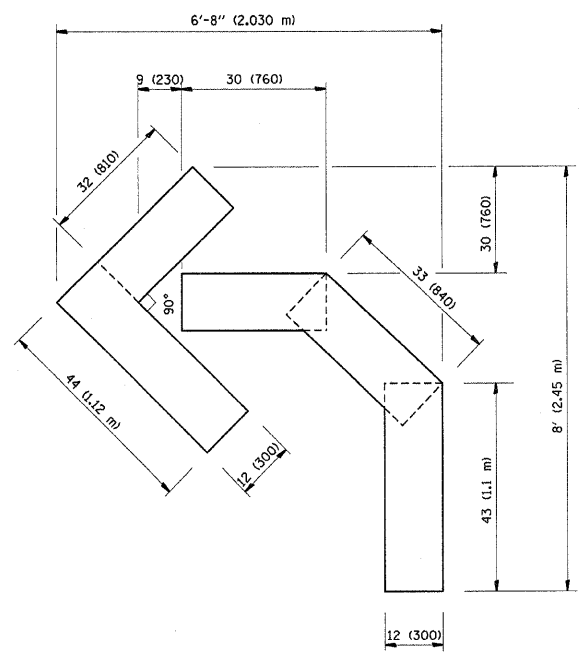

QUANTITY
 4 (100) LINE = 45.5 ft. (13.9 m)
 15.2 sq. ft. (1.39 sq. m)

All dimensions are in Inches (millimeters) unless otherwise shown.

REVISIONS	
NAME	DATE
T. RAMMACHER	09/18/94
J. OBERLE	06/01/96
T. RAMMACHER	06/05/96
T. RAMMACHER	11/04/97
T. RAMMACHER	03/02/98
E. GOMEZ	08/28/00

ILLINOIS DEPARTMENT OF TRANSPORTATION

PAVEMENT MARKING
 LETTERS AND SYMBOLS
 FOR TRAFFIC STAGING

SCALE: NONE
 DRAWN BY CADD
 CHECKED BY

PLOT DATE = 10/25/2007
 PLOT SCALE = 80/9411 / IN.
 USER NAME = bankal

F.A. #	SECTION	COUNTY	TOTAL SHEETS	SHEET NO.
33L	112 R-1	McHenry	31	30
STA.		TO STA.		
FED. ROAD DIST. NO.		ILLINOIS FED. AID PROJECT		

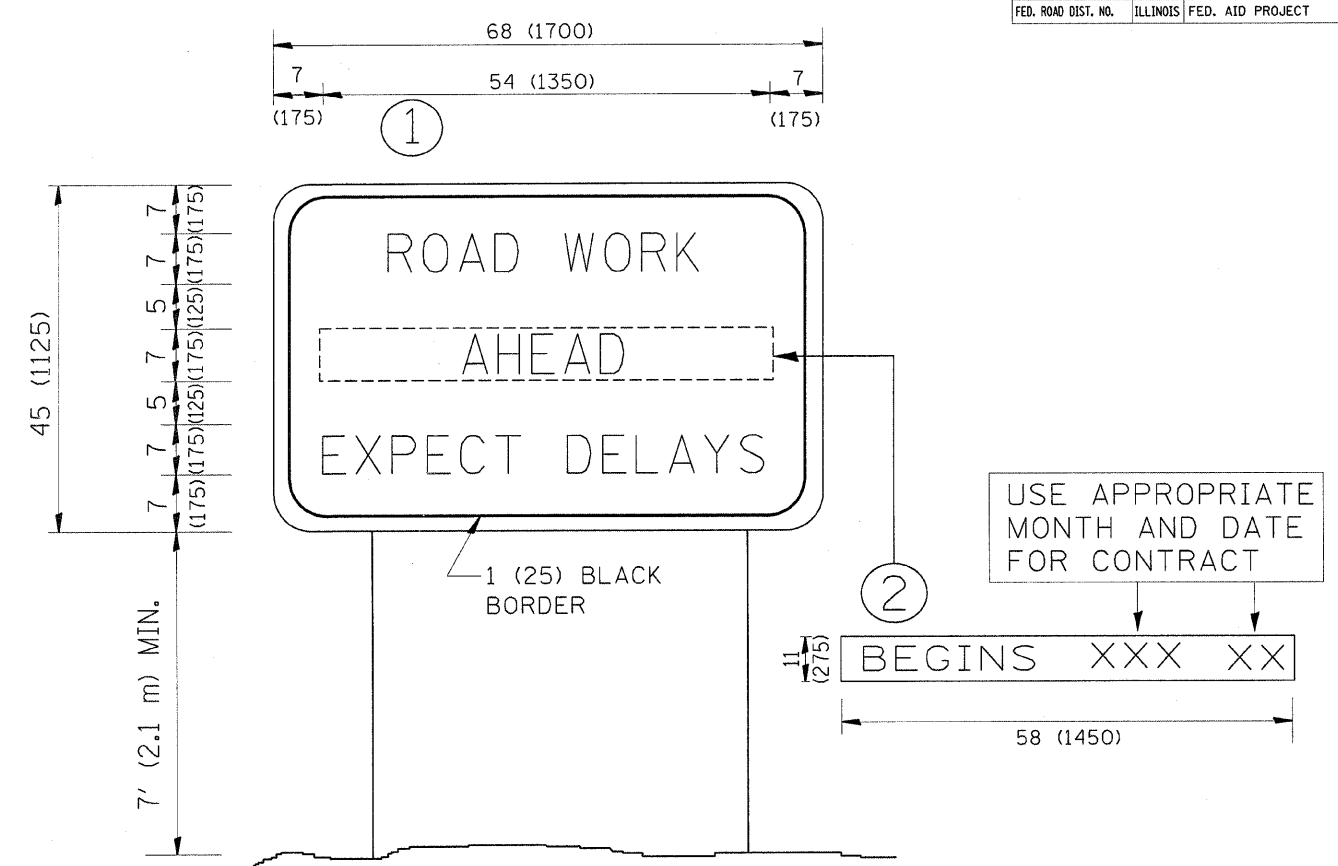

NOTES:

1. USE BLACK LETTERING ON ORANGE BACKGROUND.
2. ERECT SIGNS IN ADVANCE OF THE LOCATION FOR THE "ROAD CONSTRUCTION AHEAD" SIGN AT LOCATIONS AS DIRECTED BY THE ENGINEER.
3. ERECT SIGN ① WITH INSTALLED PANEL ② ONE WEEK PRIOR TO THE START OF CONSTRUCTION.
4. REMOVE PANEL ② SOON AFTER THE START OF CONSTRUCTION.
5. SEE SPECIAL PROVISION FOR "TEMPORARY INFORMATION SIGNING" FOR ADDITIONAL INFORMATION.
6. ONE SIGN ASSEMBLY EQUALS 25.70 SQ. FT. (2.3 SQ. M.)
7. SHALL BE PAID FOR AS TEMPORARY INFORMATION SIGNING.

ALL DIMENSIONS ARE IN INCHES (MILLIMETERS) UNLESS OTHERWISE SHOWN.

REVISIONS	
NAME	DATE
R. MIRS	9-15-97
R. MIRS	12-11-97
T. RAMMACHER	2-2-99
C. JUCIUS	1-31-07

ILLINOIS DEPARTMENT OF TRANSPORTATION
ARTERIAL ROAD INFORMATION SIGN
 SCALE: NONE
 DRAWN BY DESIGN
 CHECKED BY
 TC22

PLOT DATE = 10/25/2007
 PLOT SCALE = 82.941 / IN.
 USER NAME = barhal

