

STATE OF ILLINOIS
DEPARTMENT OF TRANSPORTATION

F.A.P. ROUTE NO.	SECTION	COUNTY	TOTAL SHEETS	SHEET NO.
786	109 BR	La Salle	351	197
FED. ROAD DIST. NO. 7	ILLINOIS	FED. AID PROJECT		

Contract #66607

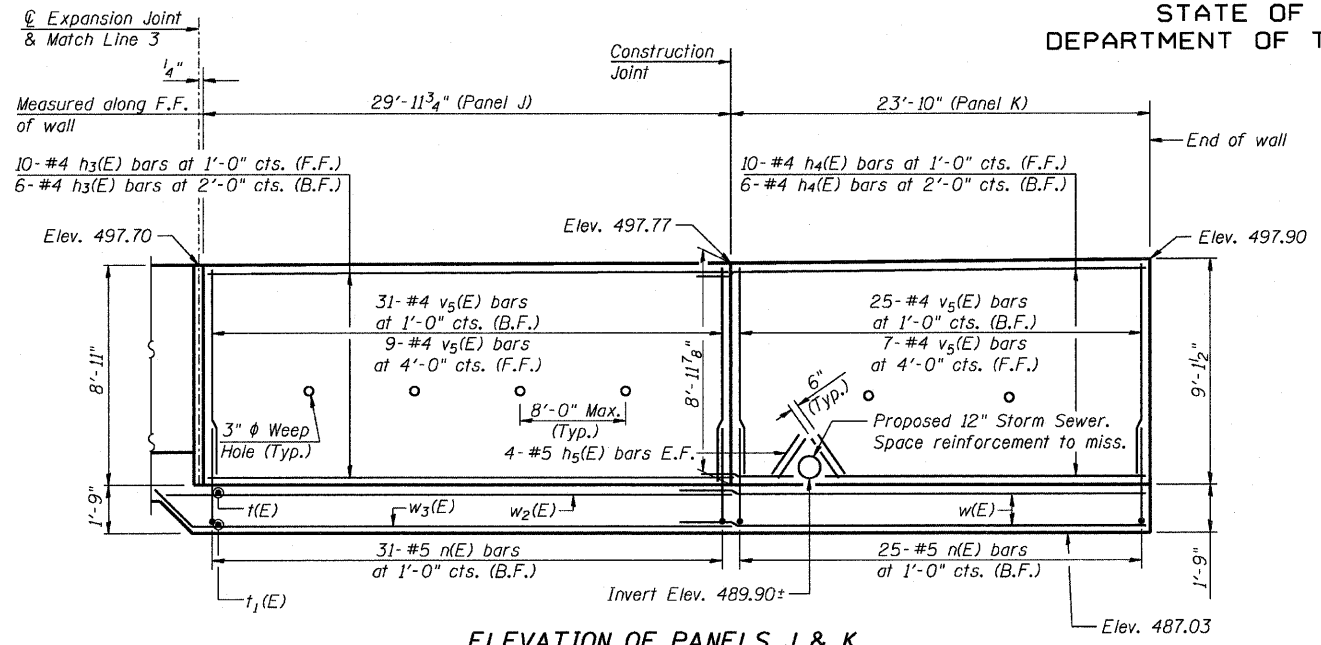

ELEVATION OF PANELS J & K
(Front Face of Wall)

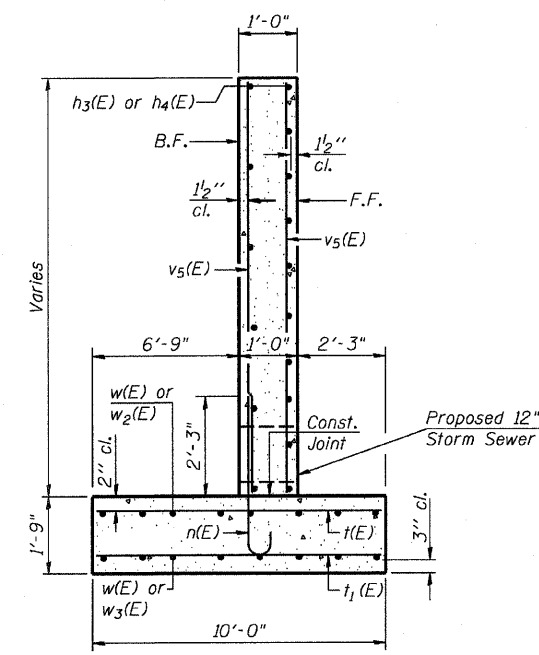

SECTION THRU WALL

BAR LIST

Bar	No.	Size	Length	Shape
h(E)	14	#4	17'-7"	—
h ₁ (E)	14	#4	19'-8"	—
h ₂ (E)	69	#4	31'-8"	—
h ₃ (E)	44	#4	29'-8"	—
h ₄ (E)	16	#4	25'-6"	—
h ₅ (E)	8	#5	3'-0"	—
n(E)	311	#5	4'-3"	—
t(E)	302	#5	9'-8"	—
t ₁ (E)	302	#4	9'-8"	—
v(E)	25	#4	7'-9"	—
v ₁ (E)	40	#4	7'-5"	—
v ₂ (E)	120	#4	7'-3"	—
v ₃ (E)	25	#4	7'-7"	—
v ₄ (E)	120	#4	7'-1"	—
v ₅ (E)	72	#4	8'-8"	—
w(E)	176	#5	26'-8"	—
w ₁ (E)	8	#5	5'-0"	L
w ₂ (E)	8	#5	31'-6"	—
w ₃ (E)	8	#5	33'-9"	—

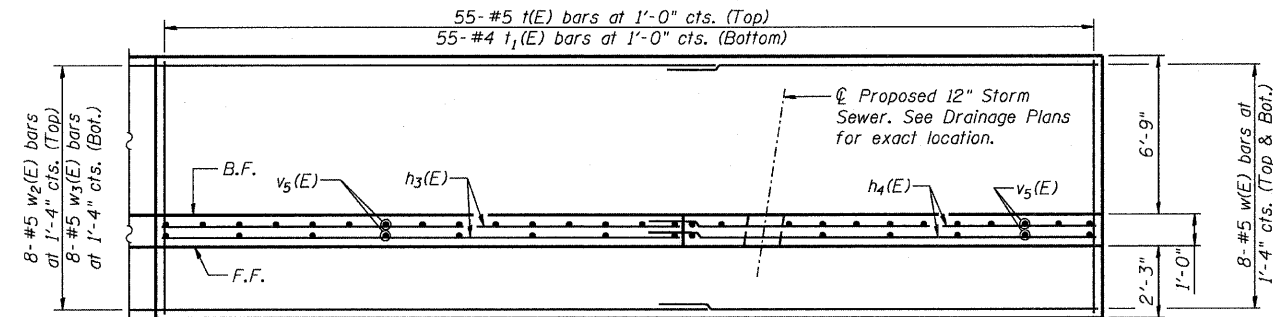
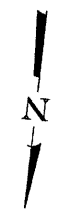

FOOTING PLAN OF PANELS J & K

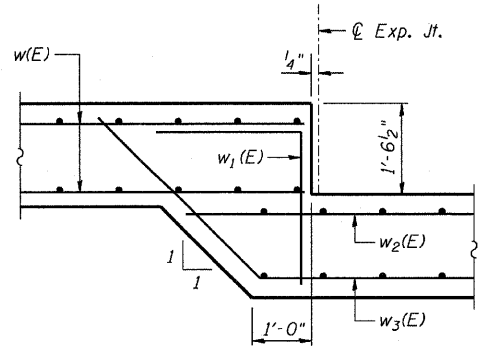

FOOTING STEP DETAIL

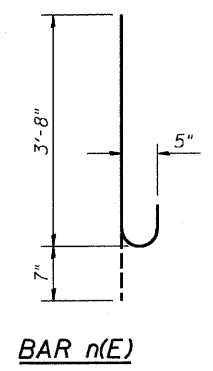
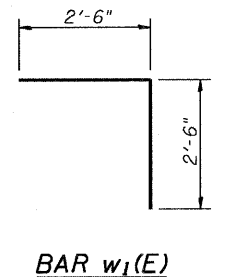
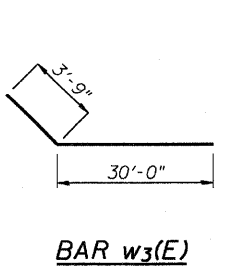

MIN BAR LAP
#4 Bars= 1'-8"
#5 Bars= 2'-2"

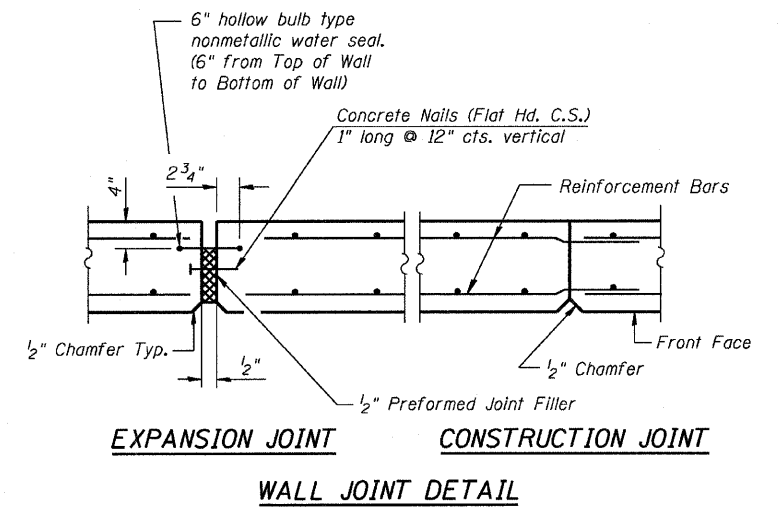

DESIGNED	JVR
CHECKED	DLS
DRAWN	JVR
CHECKED	DLS

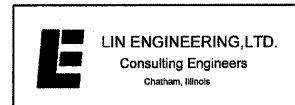

PANELS J & K
RETAINING WALL
RIVER ROAD
SECTION 109 BR
LA SALLE COUNTY