

F.A.P. RTE.	SECTION	COUNTY	TOTAL SHEETS	SHEET NO.
313	(7B)BR	HENDERSON	68	37
STA.		TO STA.		
FED. ROAD DIST. NO.	ILLINOIS	FED. AID PROJECT		

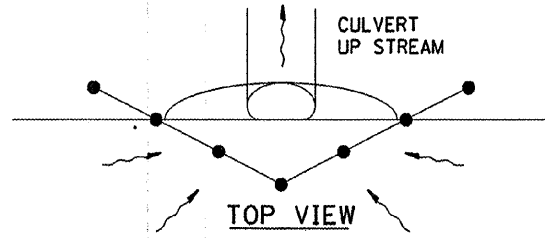

UPSTREAM PIPE CULVERT EROSION CONTROL

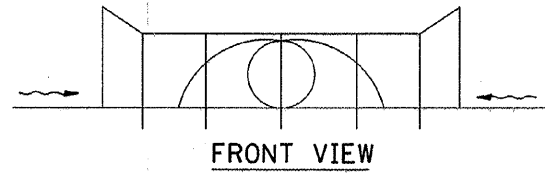
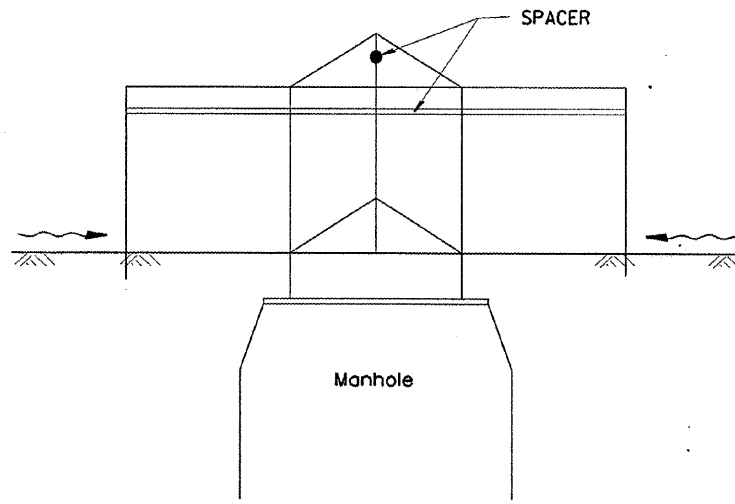

SIDE VIEW  
A-A

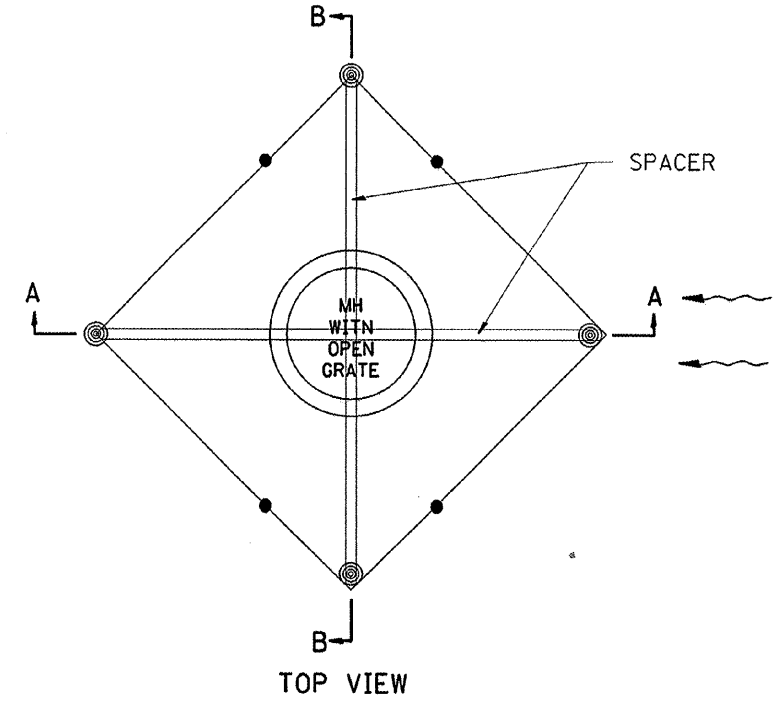

TOP VIEW

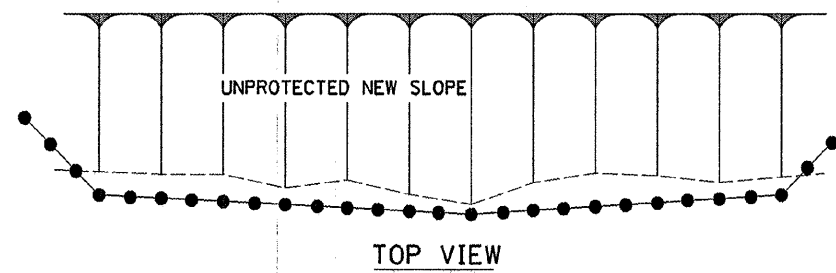

UNPROTECTED NEW SLOPE

TOP VIEW

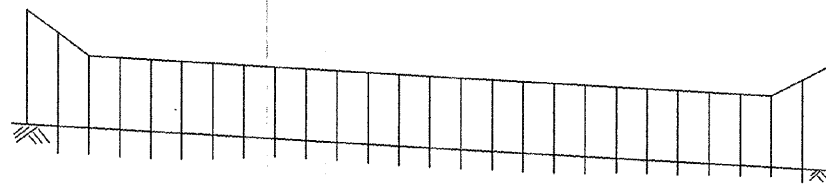

FRONT VIEW

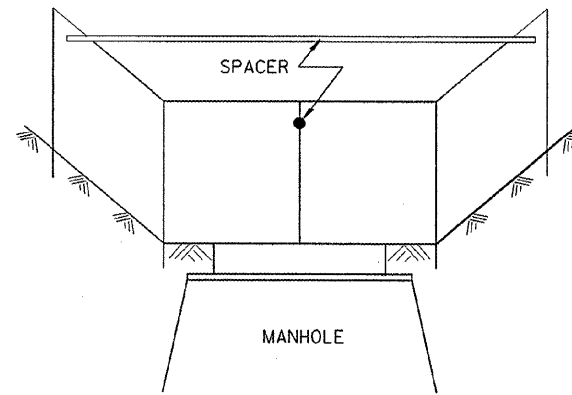

Front View  
B-B

EROSION CONTROL  
AT  
OPEN GRATE MAN HOLE

**GENERAL NOTES:**

1. This work shall be performed in accordance with Sections 280 & 1081, of the Standard Specifications.
2. Additional Timber or Metal Post shall be installed, as needed.

All dimensions are in inches (millimeters) unless otherwise noted.

ILLINOIS DEPARTMENT OF TRANSPORTATION

SPECIAL DETAIL SHEET

TYPICAL APPLICATION  
OF  
SILT FILTER FENCE

CADD DETAIL 280001-D4 DRAWN BY CADD  
SCALE: NOT DRAWN TO SCALE CHECKED BY

DATE	REVISIONS	BY
1-1-97	RENUM. A-12.05, NEW REVISION BOX	T.P.
5-11-03	ELIMINATED SILT FENCE DITCH CHECK	M.M.A.

Designer NOTES:  
 1. Designer to modify this Special Detail sheet, as needed, for inclusion in plans.  
 2. Include Highway Standard 280001 "TEMPORARY EROSION CONTROL SYSTEM."