

If you plan to submit a bid directly to the Department of Transportation

PREQUALIFICATION

Any contractor who desires to become pre-qualified to bid on work advertised by IDOT must submit the properly completed pre-qualification forms to the Bureau of Construction no later than 4:30 p.m. prevailing time twenty-one days prior to the letting of interest. This pre-qualification requirement applies to first time contractors, contractors renewing expired ratings, contractors maintaining continuous pre-qualification or contractors requesting revised ratings. To be eligible to bid, existing pre-qualification ratings must be effective through the date of letting.

REQUESTS FOR AUTHORIZATION TO BID

Contractors downloading and/or ordering CD-ROM's and are wanting to bid on items included in a particular letting must submit the properly completed "Request for Authorization to Bid/or Not For Bid Status" (BDE 124INT) and the ORIGINAL, signed and notarized, "Affidavit of Availability" (BC 57) to the proper office no later than 4:30 p.m. prevailing time, three (3) days prior to the letting date.

WHO CAN BID ?

Bids will be accepted from only those companies that request and receive written **Authorization to Bid** from IDOT's Central Bureau of Construction.

WHAT CONSTITUTES WRITTEN AUTHORIZATION TO BID? When a prospective prime bidder submits a "Request for Authorization to Bid/or Not For Bid Status" (BDE 124INT) he/she must indicate at that time which items are being requested For Bidding purposes. Only those items requested For Bidding will be analyzed. After the request has been analyzed, the bidder will be issued a **Proposal Denial and/or Authorization Form**, approved by the Central Bureau of Construction, that indicates which items have been approved For Bidding. If **Authorization to Bid** cannot be approved, the **Proposal Denial and/or Authorization Form** will indicate the reason for denial.

ABOUT AUTHORIZATION TO BID: Firms that have not received an authorization form within a reasonable time of complete and correct original document submittal should contact the department as to status. This is critical in the week before the letting. These documents must be received three days before the letting date. Firms unsure as to authorization status should call the Prequalification Section of the Bureau of Construction at the number listed at the end of these instructions.

ADDENDA AND REVISIONS: It is the contractor's responsibility to determine which, if any, addenda or revisions pertain to any project they may be bidding. Failure to incorporate all relevant addenda or revisions may cause the bid to be declared unacceptable.

Each addendum will be placed with the contract number. Addenda and revisions will also be placed on the Addendum/Revision Checklist and each subscription service subscriber will be notified by e-mail of each addendum and revision issued.

The Internet is the Department's primary way of doing business. The subscription server e-mails are an added courtesy the Department provides. It is suggested that bidder check IDOT's website <http://www.dot.il.gov/desenv/delett.html> before submitting final bid information.

IDOT is not responsible for any e-mail related failures.

Addenda Questions may be directed to the Contracts Office at (217)782-7806 or D&Econtracts@dot.il.gov

Technical Questions about downloading these files may be directed to Tim Garman (217)524-1642 or garmantr@dot.il.gov.

WHAT MUST BE INCLUDED WHEN BIDS ARE SUBMITTED?: Bidders need not return the entire proposal when bids are submitted. That portion of the proposal that must be returned includes the following:

1. All documents from the Proposal Cover Sheet through the Proposal Bid Bond
2. Other special documentation and/or information that may be required by the contract special provisions

All proposal documents, including Proposal Guaranty Checks or Proposal Bid Bonds, should be stapled together to prevent loss when bids are processed by IDOT personnel.

ABOUT SUBMITTING BIDS: It is recommended that bidders deliver bids in person to insure they arrive at the proper location prior to the time specified for the receipt of bids. Any bid received at the place of letting after the time specified will not be accepted.

WHO SHOULD BE CALLED IF ASSISTANCE IS NEEDED?

Questions Regarding	Call
Prequalification and/or Authorization to Bid	(217)782-3413
Preparation and submittal of bids	(217)782-7806
Mailing of plans and proposals	(217)782-7806
Electronic plans and proposals	(217)524-1642

ADDENDUMS AND REVISIONS TO THE PROPOSAL FORMS

Planholders should verify that they have received and incorporated the addendum and/or revision prior to submitting their bid. Failure by the bidder to include an addendum could result in a bid being rejected as irregular.

101

RETURN WITH BID

Proposal Submitted By
Name
Address
City

Letting January 18, 2008

BIDDERS NEED NOT RETURN THE ENTIRE PROPOSAL
(See instructions inside front cover)

NOTICE TO PROSPECTIVE BIDDERS

This proposal can be used for bidding purposes by only those companies that request and receive written AUTHORIZATION TO BID from IDOT's Central Bureau of Construction.
(SEE INSTRUCTIONS ON THE INSIDE OF COVER)

Notice To Bidders, Specifications, Proposal, Contract and Contract Bond



**Illinois Department
of Transportation**

Springfield, Illinois 62764

Contract No. 68781
HENDERSON-WARREN Counties
Section D4 MISC. SIGNAL WORK 2008-4
District 4 Construction Funds
Route FAP 313/310

PLEASE MARK THE APPROPRIATE BOX BELOW:

- A Bid Bond is included.
- A Cashier's Check or a Certified Check is included.

Prepared by

S

Checked by

(Printed by authority of the State of Illinois)

INSTRUCTIONS

ABOUT IDOT PROPOSALS: All proposals issued by IDOT are potential bidding proposals. Each proposal contains all Certifications and Affidavits, a Proposal Signature Sheet and a Proposal Bid Bond required for Prime Contractors to submit a bid after written **Authorization to Bid** has been issued by IDOT's Central Bureau of Construction.

WHO CAN BID?: Bids will be accepted from only those companies that request and receive written **Authorization to Bid** from IDOT's Central Bureau of Construction. To request authorization, a potential bidder must complete and submit Part B of the Request for Authorization to Bid/or Not For Bid Status form (BDE 124 INT) and submit an original Affidavit of Availability (BC 57).

WHAT CONSTITUTES WRITTEN AUTHORIZATION TO BID?: When a prospective prime bidder submits a "Request for Proposal Forms and Plans" he/she must indicate at that time which items are being requested For Bidding purposes. Only those items requested For Bidding will be analyzed. After the request has been analyzed, the bidder will be issued a **Proposal Denial and/or Authorization Form**, approved by the Central Bureau of Construction, that indicates which items have been approved For Bidding. If **Authorization to Bid** cannot be approved, the **Proposal Denial and/or Authorization Form** will indicate the reason for denial. If a contractor has requested to bid but has not received a **Proposal Denial and/or Authorization Form**, they should contact the Central Bureau of Construction in advance of the letting date.

WHAT MUST BE INCLUDED WHEN BIDS ARE SUBMITTED?: Bidders need not return the entire proposal when bids are submitted. That portion of the proposal that must be returned includes the following:

1. All documents from the Proposal Cover Sheet through the Proposal Bid Bond
2. Other special documentation and/or information that may be required by the contract special provisions

All proposal documents, including Proposal Guaranty Checks or Proposal Bid Bonds, should be stapled together to prevent loss when bids are processed by IDOT personnel.

ABOUT SUBMITTING BIDS: It is recommended that bidders deliver bids in person to insure they arrive at the proper location prior to the time specified for the receipt of bids. Any bid received at the place of letting after the time specified will not be accepted.

WHO SHOULD BE CALLED IF ASSISTANCE IS NEEDED?

Questions Regarding	Call
Prequalification and/or Authorization to Bid	217/782-3413
Preparation and submittal of bids	217/782-7806
Mailing of CD-ROMS	217/782-7806

RETURN WITH BID



PROPOSAL

TO THE DEPARTMENT OF TRANSPORTATION

1. Proposal of _____

Taxpayer Identification Number (Mandatory) _____ a

for the improvement identified and advertised for bids in the Invitation for Bids as:

**Contract No. 68781
HENDERSON-WARREN Counties
Section D4 MISC. SIGNAL WORK 2008-4
Route FAP 313/310
District 4 Construction Funds**

This project consists of installing detector loops and updating existing traffic signal installations in accordance with NEC requirements located at the intersection of U.S. Route 34 and Carman Road in Henderson County and at the intersections of U.S. Route 34 and U.S. Route 67 and U.S. Route 34 and 11th Street in Warren County.

2. The undersigned bidder will furnish all labor, material and equipment to complete the above described project in a good and workmanlike manner as provided in the contract documents provided by the Department of Transportation. This proposal will become part of the contract and the terms and conditions contained in the contract documents shall govern performance and payments.

RETURN WITH BID

- 3. **ASSURANCE OF EXAMINATION AND INSPECTION/WAIVER.** The undersigned further declares that he/she has carefully examined the proposal, plans, specifications, form of contract and contract bond, and special provisions, and that he/she has inspected in detail the site of the proposed work, and that he/she has familiarized themselves with all of the local conditions affecting the contract and the detailed requirements of construction, and understands that in making this proposal he/she waives all right to plead any misunderstanding regarding the same.
- 4. **EXECUTION OF CONTRACT AND CONTRACT BOND.** The undersigned further agrees to execute a contract for this work and present the same to the department within fifteen (15) days after the contract has been mailed to him/her. The undersigned further agrees that he/she and his/her surety will execute and present within fifteen (15) days after the contract has been mailed to him/her contract bond satisfactory to and in the form prescribed by the Department of Transportation, in the penal sum of the full amount of the contract, guaranteeing the faithful performance of the work in accordance with the terms of the contract.
- 5. **PROPOSAL GUARANTY.** Accompanying this proposal is either a bid bond on the department form, executed by a corporate surety company satisfactory to the department, or a proposal guaranty check consisting of a bank cashier's check or a properly certified check for not less than 5 per cent of the amount bid or for the amount specified in the following schedule:

<u>Amount of Bid</u>		<u>Proposal Guaranty</u>	<u>Amount of Bid</u>		<u>Proposal Guaranty</u>	
Up to	\$5,000	\$150	\$2,000,000	to	\$3,000,000	\$100,000
\$5,000	to \$10,000	\$300	\$3,000,000	to	\$5,000,000	\$150,000
\$10,000	to \$50,000	\$1,000	\$5,000,000	to	\$7,500,000	\$250,000
\$50,000	to \$100,000	\$3,000	\$7,500,000	to	\$10,000,000	\$400,000
\$100,000	to \$150,000	\$5,000	\$10,000,000	to	\$15,000,000	\$500,000
\$150,000	to \$250,000	\$7,500	\$15,000,000	to	\$20,000,000	\$600,000
\$250,000	to \$500,000	\$12,500	\$20,000,000	to	\$25,000,000	\$700,000
\$500,000	to \$1,000,000	\$25,000	\$25,000,000	to	\$30,000,000	\$800,000
\$1,000,000	to \$1,500,000	\$50,000	\$30,000,000	to	\$35,000,000	\$900,000
\$1,500,000	to \$2,000,000	\$75,000	over	to	\$35,000,000	\$1,000,000

Bank cashier's checks or properly certified checks accompanying proposals shall be made payable to the Treasurer, State of Illinois, when the state is awarding authority; the county treasurer, when a county is the awarding authority; or the city, village, or town treasurer, when a city, village, or town is the awarding authority.

If a combination bid is submitted, the proposal guaranties which accompany the individual proposals making up the combination will be considered as also covering the combination bid.

The amount of the proposal guaranty check is _____ \$(_____). If this proposal is accepted and the undersigned shall fail to execute a contract bond as required herein, it is hereby agreed that the amount of the proposal guaranty shall become the property of the State of Illinois, and shall be considered as payment of damages due to delay and other causes suffered by the State because of the failure to execute said contract and contract bond; otherwise, the bid bond shall become void or the proposal guaranty check shall be returned to the undersigned.

Attach Cashier's Check or Certified Check Here	
In the event that one proposal guaranty check is intended to cover two or more proposals, the amount must be equal to the sum of the proposal guaranties which would be required for each individual proposal. If the guaranty check is placed in another proposal, state below where it may be found.	
The proposal guaranty check will be found in the proposal for:	Item _____
	Section No. _____
	County _____

Mark the proposal cover sheet as to the type of proposal guaranty submitted. BD 354 (Rev. 11/2001)

RETURN WITH BID

6. **COMBINATION BIDS.** The undersigned further agrees that if awarded the contract for the sections contained in the following combination, he/she will perform the work in accordance with the requirements of each individual proposal comprising the combination bid specified in the schedule below, and that the combination bid shall be prorated against each section in proportion to the bid submitted for the same. If an error is found to exist in the gross sum bid for one or more of the individual sections included in a combination, the combination bid shall be corrected as provided in the specifications.

When a combination bid is submitted, the schedule below must be completed in each proposal comprising the combination.

If alternate bids are submitted for one or more of the sections comprising the combination, a combination bid must be submitted for each alternate.

Schedule of Combination Bids

Combination No.	Sections Included in Combination	Combination Bid	
		Dollars	Cents

7. **SCHEDULE OF PRICES.** The undersigned bidder submits herewith, in accordance with the rules and instructions, a schedule of prices for the items of work for which bids are sought. The unit prices bid are in U.S. dollars and cents, and all extensions and summations have been made. The bidder understands that the quantities appearing in the bid schedule are approximate and are provided for the purpose of obtaining a gross sum for the comparison of bids. If there is an error in the extension of the unit prices, the unit prices shall govern. Payment to the contractor awarded the contract will be made only for actual quantities of work performed and accepted or materials furnished according to the contract. The scheduled quantities of work to be done and materials to be furnished may be increased, decreased or omitted as provided elsewhere in the contract.

8. **CERTIFICATE OF AUTHORITY.** The undersigned bidder, if a business organized under the laws of another State, assures the Department that it will furnish a copy of its certificate of authority to do business in the State of Illinois with the return of the executed contract and bond. Failure to furnish the certificate within the time provided for execution of an awarded contract may be cause for cancellation of the award and forfeiture of the proposal guaranty to the State.

ILLINOIS DEPARTMENT OF TRANSPORTATION
 SCHEDULE OF PRICES
 CONTRACT
 NUMBER - 68781

State Job # - C-94-020-08
 PPS NBR - 4-00001-0802
 County Name - HENDERSON- -
 Code - 71 - -
 District - 4 - -
 Section Number - D4 MISC. SIGNAL WORK 2008-4

Project Number

Route
 FAP 313/
 310

Item Number	Pay Item Description	Unit of Measure	Quantity	x	Unit Price	=	Total Price
XX005703	REMOV EX TS EQUIP SPL	L SUM	1.000				
X0324134	BATT BACKUP SYS/CABNT	EACH	3.000				
X8730027	ELCBL C GROUND 6 1C	FOOT	824.000				
67100100	MOBILIZATION	L SUM	1.000				
70100310	TRAF CONT-PROT 701421	L SUM	1.000				
70102635	TR CONT & PROT 701701	L SUM	1.000				
87301515	ELCBL C LEAD 18 3PR	FOOT	978.000				
88500100	INDUCTIVE LOOP DETECT	EACH	7.000				
88600100	DET LOOP T1	FOOT	1,138.000				

CONTRACT NUMBER

68781

THIS IS THE TOTAL BID

\$ _____

NOTES:

1. Each PAY ITEM should have a UNIT PRICE and a TOTAL PRICE.
2. The UNIT PRICE shall govern if no TOTAL PRICE is shown or if there is a discrepancy between the product of the UNIT PRICE multiplied by the QUANTITY.
3. If a UNIT PRICE is omitted, the TOTAL PRICE will be divided by the QUANTITY in order to establish a UNIT PRICE.
4. A bid may be declared UNACCEPTABLE if neither a unit price nor a total price is shown.

RETURN WITH BID

STATE REQUIRED ETHICAL STANDARDS GOVERNING CONTRACT PROCUREMENT: ASSURANCES, CERTIFICATIONS AND DISCLOSURES

I. GENERAL

A. Article 50 of the Illinois Procurement Code establishes the duty of all State chief procurement officers, State purchasing officers, and their designees to maximize the value of the expenditure of public moneys in procuring goods, services, and contracts for the State of Illinois and to act in a manner that maintains the integrity and public trust of State government. In discharging this duty, they are charged by law to use all available information, reasonable efforts, and reasonable actions to protect, safeguard, and maintain the procurement process of the State of Illinois.

B. In order to comply with the provisions of Article 50 and to carry out the duty established therein, all bidders are to adhere to ethical standards established for the procurement process, and to make such assurances, disclosures and certifications required by law. By execution of the Proposal Signature Sheet, the bidder indicates that each of the mandated assurances has been read and understood, that each certification is made and understood, and that each disclosure requirement has been understood and completed.

C. In addition to all other remedies provided by law, failure to comply with any assurance, failure to make any disclosure or the making of a false certification shall be grounds for termination of the contract and the suspension or debarment of the bidder.

II. ASSURANCES

A. The assurances hereinafter made by the bidder are each a material representation of fact upon which reliance is placed should the Department enter into the contract with the bidder. The Department may terminate the contract if it is later determined that the bidder rendered a false or erroneous assurance, and the surety providing the performance bond shall be responsible for the completion of the contract.

B. Felons

1. The Illinois Procurement Code provides:

Section 50-10. Felons. Unless otherwise provided, no person or business convicted of a felony shall do business with the State of Illinois or any state agency from the date of conviction until 5 years after the date of completion of the sentence for that felony, unless no person held responsible by a prosecutorial office for the facts upon which the conviction was based continues to have any involvement with the business.

2. The bidder assures the Department that the award and execution of the contract would not cause a violation of Section 50-10.

C. Conflicts of Interest

1. The Illinois Procurement Code provides in pertinent part:

Section 50-13. Conflicts of Interest.

(a) Prohibition. It is unlawful for any person holding an elective office in this State, holding a seat in the General Assembly, or appointed to or employed in any of the offices or agencies of state government and who receives compensation for such employment in excess of 60% of the salary of the Governor of the State of Illinois, or who is an officer or employee of the Capital Development Board or the Illinois Toll Highway Authority, or who is the spouse or minor child of any such person to have or acquire any contract, or any direct pecuniary interest in any contract therein, whether for stationery, printing, paper, or any services, materials, or supplies, that will be wholly or partially satisfied by the payment of funds appropriated by the General Assembly of the State of Illinois or in any contract of the Capital Development Board or the Illinois Toll Highway authority.

(b) Interests. It is unlawful for any firm, partnership, association or corporation, in which any person listed in subsection (a) is entitled to receive (i) more than 7 1/2% of the total distributable income or (ii) an amount in excess of the salary of the Governor, to have or acquire any such contract or direct pecuniary interest therein.

(c) Combined interests. It is unlawful for any firm, partnership, association, or corporation, in which any person listed in subsection (a) together with his or her spouse or minor children is entitled to receive (i) more than 15%, in the aggregate, of the total distributable income or (ii) an amount in excess of 2 times the salary of the Governor, to have or acquire any such contract or direct pecuniary interest therein.

(d) Securities. Nothing in this Section invalidates the provisions of any bond or other security previously offered or to be offered for sale or sold by or for the State of Illinois.

(e) Prior interests. This Section does not affect the validity of any contract made between the State and an officer or employee of the State or member of the General Assembly, his or her spouse, minor child or any combination of those persons if that contract was in existence before his or her election or employment as an officer, member, or employee. The contract is voidable, however, if it cannot be completed within 365 days after the officer, member, or employee takes office or is employed.

The current salary of the Governor is \$171,000.00. Sixty percent of the salary is \$102,600.00.

RETURN WITH BID

2. The bidder assures the Department that the award and execution of the contract would not cause a violation of Section 50-13, or that an effective exemption has been issued by the Board of Ethics to any individual subject to the Section 50-13 prohibitions pursuant to the provisions of Section 50-20 of the Code and Executive Order Number 3 (1998). Information concerning the exemption process is available from the Department upon request.

D. Negotiations

1. The Illinois Procurement Code provides in pertinent part:

Section 50-15. Negotiations.

(a) It is unlawful for any person employed in or on a continual contractual relationship with any of the offices or agencies of State government to participate in contract negotiations on behalf of that office or agency with any firm, partnership, association, or corporation with whom that person has a contract for future employment or is negotiating concerning possible future employment.

2. The bidder assures the Department that the award and execution of the contract would not cause a violation of Section 50-15, and that the bidder has no knowledge of any facts relevant to the kinds of acts prohibited therein.

E. Inducements

1. The Illinois Procurement Code provides:

Section 50-25. Inducement. Any person who offers or pays any money or other valuable thing to any person to induce him or her not to bid for a State contract or as recompense for not having bid on a State contract is guilty of a Class 4 felony. Any person who accepts any money or other valuable thing for not bidding for a State contract or who withholds a bid in consideration of the promise for the payment of money or other valuable thing is guilty of a Class 4 felony.

2. The bidder assures the Department that the award and execution of the contract would not cause a violation of Section 50-25, and that the bidder has no knowledge of any facts relevant to the kinds of acts prohibited therein.

F. Revolving Door Prohibition

1. The Illinois Procurement Code provides:

Section 50-30. Revolving door prohibition. Chief procurement officers, associate procurement officers, State purchasing officers, their designees whose principal duties are directly related to State procurement, and executive officers confirmed by the Senate are expressly prohibited for a period of 2 years after terminating an affected position from engaging in any procurement activity relating to the State agency most recently employing them in an affected position for a period of at least 6 months. The prohibition includes, but is not limited to: lobbying the procurement process; specifying; bidding; proposing bid, proposal, or contract documents; on their own behalf or on behalf of any firm, partnership, association, or corporation. This Section applies only to persons who terminate an affected position on or after January 15, 1999.

2. The bidder assures the Department that the award and execution of the contract would not cause a violation of Section 50-30, and that the bidder has no knowledge of any facts relevant to the kinds of acts prohibited therein.

G. Reporting Anticompetitive Practices

1. The Illinois Procurement Code provides:

Section 50-40. Reporting anticompetitive practices. When, for any reason, any vendor, bidder, contractor, chief procurement officer, State purchasing officer, designee, elected official, or State employee suspects collusion or other anticompetitive practice among any bidders, offerors, contractors, proposers, or employees of the State, a notice of the relevant facts shall be transmitted to the Attorney General and the chief procurement officer.

2. The bidder assures the Department that it has not failed to report any relevant facts concerning the practices addressed in Section 50-40 which may involve the contract for which the bid is submitted.

H. Confidentiality

1. The Illinois Procurement Code provides:

Section 50-45. Confidentiality. Any chief procurement officer, State purchasing officer, designee, or executive officer who willfully uses or allows the use of specifications, competitive bid documents, proprietary competitive information, proposals, contracts, or selection information to compromise the fairness or integrity of the procurement, bidding, or contract process shall be subject to immediate dismissal, regardless of the Personnel code, any contract, or any collective bargaining agreement, and may in addition be subject to criminal prosecution.

2. The bidder assures the Department that it has no knowledge of any fact relevant to the practices addressed in Section 50-45 which may involve the contract for which the bid is submitted.

RETURN WITH BID

I. Insider Information

1. The Illinois Procurement Act provides:

Section 50-50. Insider information. It is unlawful for any current or former elected or appointed State official or State employee to knowingly use confidential information available only by virtue of that office or employment for actual or anticipated gain for themselves or another person.

2. The bidder assures the Department that it has no knowledge of any facts relevant to the practices addressed in Section 50-50 which may involve the contract for which the bid is submitted.

III. CERTIFICATIONS

A. The certifications hereinafter made by the bidder are each a material representation of fact upon which reliance is placed should the Department enter into the contract with the bidder. The Department may terminate the contract if it is later determined that the bidder rendered a false or erroneous certification, and the surety providing the performance bond shall be responsible for completion of the contract.

B. Bribery

1. The Illinois Procurement Code provides:

Section 50-5. Bribery.

(a) Prohibition. No person or business shall be awarded a contract or subcontract under this Code who:

(1) has been convicted under the laws of Illinois or any other state of bribery or attempting to bribe an officer or employee of the State of Illinois or any other state in that officer's or employee's official capacity; or

(2) has made an admission of guilt of that conduct that is a matter of record but has not been prosecuted for that conduct.

(b) Businesses. No business shall be barred from contracting with any unit of State or local government as a result of a conviction under this Section of any employee or agent of the business if the employee or agent is no longer employed by the business and:

(1) the business has been finally adjudicated not guilty; or

(2) the business demonstrates to the governmental entity with which it seeks to contract, and that entity finds that the commission of the offense was not authorized, requested, commanded, or performed by a director, officer, or high managerial agent on behalf of the business as provided in paragraph (2) of subsection (a) of Section 5-4 of the Criminal Code of 1961.

(c) Conduct on behalf of business. For purposes of this Section, when an official, agent, or employee of a business committed the bribery or attempted bribery on behalf of the business and in accordance with the direction or authorization of a responsible official of the business, the business shall be chargeable with the conduct.

(d) Certification. Every bid submitted to and contract executed by the State shall contain a certification by the contractor that the contractor is not barred from being awarded a contract or subcontract under this Section. A contractor who makes a false statement, material to the certification, commits a Class 3 felony.

2. The bidder certifies that it is not barred from being awarded a contract under Section 50.5.

C. Educational Loan

1. Section 3 of the Educational Loan Default Act provides:

§ 3. No State agency shall contract with an individual for goods or services if that individual is in default, as defined in Section 2 of this Act, on an educational loan. Any contract used by any State agency shall include a statement certifying that the individual is not in default on an educational loan as provided in this Section.

2. The bidder, if an individual as opposed to a corporation, partnership or other form of business organization, certifies that the bidder is not in default on an educational loan as provided in Section 3 of the Act.

D. Bid-Rigging/Bid Rotating

1. Section 33E-11 of the Criminal Code of 1961 provides:

§ 33E-11. (a) Every bid submitted to and public contract executed pursuant to such bid by the State or a unit of local government shall contain a certification by the prime contractor that the prime contractor is not barred from contracting with any unit of State or local government as a result of a violation of either Section 33E-3 or 33E-4 of this Article. The State and units of local government shall provide the appropriate forms for such certification.

RETURN WITH BID

(b) A contractor who makes a false statement, material to the certification, commits a Class 3 felony.

A violation of Section 33E-3 would be represented by a conviction of the crime of bid-rigging which, in addition to Class 3 felony sentencing, provides that any person convicted of this offense or any similar offense of any state or the United States which contains the same elements as this offense shall be barred for 5 years from the date of conviction from contracting with any unit of State or local government. No corporation shall be barred from contracting with any unit of State or local government as a result of a conviction under this Section of any employee or agent of such corporation if the employee so convicted is no longer employed by the corporation and: (1) it has been finally adjudicated not guilty or (2) if it demonstrates to the governmental entity with which it seeks to contract and that entity finds that the commission of the offense was neither authorized, requested, commanded, nor performed by a director, officer or a high managerial agent in behalf of the corporation.

A violation of Section 33E-4 would be represented by a conviction of the crime of bid-rotating which, in addition to Class 2 felony sentencing, provides that any person convicted of this offense or any similar offense of any state or the United States which contains the same elements as this offense shall be permanently barred from contracting with any unit of State or local government. No corporation shall be barred from contracting with any unit of State or local government as a result of a conviction under this Section of any employee or agent of such corporation if the employee so convicted is no longer employed by the corporation and: (1) it has been finally adjudicated not guilty or (2) if it demonstrates to the governmental entity with which it seeks to contract and that entity finds that the commission of the offense was neither authorized, requested, commanded, nor performed by a director, officer or a high managerial agent in behalf of the corporation.

2. The bidder certifies that it is not barred from contracting with the Department by reason of a violation of either Section 33E-3 or Section 33E-4.

E. International Anti-Boycott

1. Section 5 of the International Anti-Boycott Certification Act provides:

§ 5. State contracts. Every contract entered into by the State of Illinois for the manufacture, furnishing, or purchasing of supplies, material, or equipment or for the furnishing of work, labor, or services, in an amount exceeding the threshold for small purchases according to the purchasing laws of this State or \$10,000.00, whichever is less, shall contain certification, as a material condition of the contract, by which the contractor agrees that neither the contractor nor any substantially-owned affiliated company is participating or shall participate in an international boycott in violation of the provisions of the U.S. Export Administration Act of 1979 or the regulations of the U.S. Department of Commerce promulgated under that Act.

2. The bidder makes the certification set forth in Section 5 of the Act.

F. Drug Free Workplace

1. The Illinois "Drug Free Workplace Act" applies to this contract and it is necessary to comply with the provisions of the "Act" if the contractor is a corporation, partnership, or other entity (including a sole proprietorship) which has 25 or more employees.

2. The bidder certifies that if awarded a contract in excess of \$5,000 it will provide a drug free workplace by:

(a) Publishing a statement notifying employees that the unlawful manufacture, distribution, dispensation, possession or use of a controlled substance, including cannabis, is prohibited in the contractor's workplace; specifying the actions that will be taken against employees for violations of such prohibition; and notifying the employee that, as a condition of employment on such contract, the employee shall abide by the terms of the statement, and notify the employer of any criminal drug statute conviction for a violation occurring in the workplace no later than five (5) days after such conviction.

(b) Establishing a drug free awareness program to inform employees about the dangers of drug abuse in the workplace; the contractor's policy of maintaining a drug free workplace; any available drug counseling, rehabilitation, and employee assistance programs; and the penalties that may be imposed upon employees for drug violations.

(c) Providing a copy of the statement required by subparagraph (1) to each employee engaged in the performance of the contract and to post the statement in a prominent place in the workplace.

(d) Notifying the Department within ten (10) days after receiving notice from an employee or otherwise receiving actual notice of the conviction of an employee for a violation of any criminal drug statute occurring in the workplace.

(e) Imposing or requiring, within 30 days after receiving notice from an employee of a conviction or actual notice of such a conviction, an appropriate personnel action, up to and including termination, or the satisfactory participation in a drug abuse assistance or rehabilitation program approved by a federal, state or local health, law enforcement or other appropriate agency.

(f) Assisting employees in selecting a course of action in the event drug counseling, treatment, and rehabilitation is required and indicating that a trained referral team is in place.

(g) Making a good faith effort to continue to maintain a drug free workplace through implementation of the actions and efforts stated in this certification.

G. Debt Delinquency

1. The Illinois Procurement Code provides:

Section 50-11 and 50-12. Debt Delinquency.

The contractor or bidder certifies that it, or any affiliate, is not barred from being awarded a contract under 30 ILCS 500. Section 50-11 prohibits a person from entering into a contract with a State agency if it knows or should know that it, or any affiliate, is delinquent in the payment of any debt to the State as defined by the Debt Collection Board. Section 50-12 prohibits a person from entering into a contract with a State agency if it, or any affiliate, has failed to collect and remit Illinois Use Tax on all sales of tangible personal property into the State of Illinois in accordance with the provisions of the Illinois Use Tax Act. The contractor further acknowledges that the contracting State agency may declare the contract void if this certification is false or if the contractor, or any affiliate, is determined to be delinquent in the payment of any debt to the State during the term of the contract.

H. Sarbanes-Oxley Act of 2002

1. The Illinois Procurement Code provides:

Section 50-60(c).

The contractor certifies in accordance with 30 ILCS 500/50-10.5 that no officer, director, partner or other managerial agent of the contracting business has been convicted of a felony under the Sarbanes-Oxley Act of 2002 or a Class 3 or Class 2 felony under the Illinois Securities Law of 1953 for a period of five years prior to the date of the bid or contract. The contractor acknowledges that the contracting agency shall declare the contract void if this certification is false.

I. Addenda

The contractor or bidder certifies that all relevant addenda have been incorporated in to this contract. Failure to do so may cause the bid to be declared unacceptable.

J. Section 42 of the Environmental Protection Act

The contractor certifies in accordance with 30 ILCS 500/50-12 that the bidder or contractor is not barred from being awarded a contract under this Section which prohibits the bidding on or entering into contracts with the State of Illinois or a State agency by a person or business found by a court or the Pollution Control Board to have committed a willful or knowing violation of Section 42 of the Environmental Protection Act for a period of five years from the date of the order. The contractor acknowledges that the contracting agency may declare the contract void if this certification is false.

K. Apprenticeship and Training Certification (Does not apply to federal aid projects)

In accordance with the provisions of Section 30-22 (6) of the Illinois Procurement Code, the bidder certifies that it is a participant, either as an individual or as part of a group program, in the approved apprenticeship and training programs applicable to each type of work or craft that the bidder will perform with its own forces. The bidder further certifies for work that will be performed by subcontract that each of its subcontractors submitted for approval either (a) is, at the time of such bid, participating in an approved, applicable apprenticeship and training program; or (b) will, prior to commencement of performance of work pursuant to this contract, begin participation in an approved apprenticeship and training program applicable to the work of the subcontract. The Department, at any time before or after award, may require the production of a copy of each applicable Certificate of Registration issued by the United States Department of Labor evidencing such participation by the contractor and any or all of its subcontractors. Applicable apprenticeship and training programs are those that have been approved and registered with the United States Department of Labor. The bidder shall list in the space below, the official name of the program sponsor holding the Certificate of Registration for all of the types of work or crafts in which the bidder is a participant and that will be performed with the bidder's forces. Types of work or craft work that will be subcontracted shall be included and listed as subcontract work. The list shall also indicate any type of work or craft job category that does not have an applicable apprenticeship or training program. **The bidder is responsible for making a complete report and shall make certain that each type of work or craft job category that will be utilized on the project as reported on the Construction Employee Workforce Projection (Form BC-1256) and returned with the bid is accounted for and listed.**

The requirements of this certification and disclosure are a material part of the contract, and the contractor shall require this certification provision to be included in all approved subcontracts. In order to fulfill this requirement, it shall not be necessary that an applicable program sponsor be currently taking or that it will take applications for apprenticeship, training or employment during the performance of the work of this contract.

L. Executive Order Number 1 (2007) Regarding Lobbying on Government Procurements

The bidder hereby warrants and certifies that they have complied and will comply with the requirements set forth in this Order. The requirements of this warrant and certification are a material part of the contract, and the contractor shall require this warrant and certification provision to be included in all approved subcontracts.

M. Disclosure of Business Operations in Iran

Public Act 95-0616 provides that each bid, offer, or proposal submitted for a State contract shall include a disclosure of whether or not the Company acting as the bidder, offeror, or proposing entity, or any of its corporate parents or subsidiaries, within the 24 months before submission of the bid, offer, or proposal had business operations that involved contracts with or provision of supplies or services to the Government of Iran, companies in which the Government of Iran has any direct or indirect equity share, consortiums or projects commissioned by the Government of Iran, or companies involved in consortiums or projects commissioned by the Government of Iran and either of the following conditions apply:

- (1) More than 10% of the Company's revenues produced in or assets located in Iran involve oil-related activities or mineral-extraction activities; less than 75% of the Company's revenues produced in or assets located in Iran involve contracts with or provision of oil-related or mineral-extraction products or services to the Government of Iran or a project or consortium created exclusively by that government; and the Company has failed to take substantial action.
- (2) The Company has, on or after August 5, 1996, made an investment of \$20 million or more, or any combination of investments of at least \$10 million each that in the aggregate equals or exceeds \$20 million in any 12-month period, which directly or significantly contributes to the enhancement of Iran's ability to develop petroleum resources of Iran.

The terms "Business operations", "Company", "Mineral-extraction activities", "Oil-related activities", "Petroleum resources", and "Substantial action" are all defined in the Act.

Failure to make the disclosure required by the Act shall cause the bid, offer or proposal to be considered not responsive. The disclosure will be considered when evaluating the bid, offer, or proposal or awarding the contract. The name of each Company disclosed as doing business or having done business in Iran will be provided to the State Comptroller.

Check the appropriate statement:

Company has no business operations in Iran to disclose.

Company has business operations in Iran as disclosed the attached document.

TO BE RETURNED WITH BID

IV. DISCLOSURES

A. The disclosures hereinafter made by the bidder are each a material representation of fact upon which reliance is placed should the Department enter into the contract with the bidder. The Department may terminate the contract if it is later determined that the bidder rendered a false or erroneous disclosure, and the surety providing the performance bond shall be responsible for completion of the contract.

B. Financial Interests and Conflicts of Interest

1. Section 50-35 of the Illinois Procurement Code provides that all bids of more than \$10,000 shall be accompanied by disclosure of the financial interests of the bidder. This disclosed information for the successful bidder, will be maintained as public information subject to release by request pursuant to the Freedom of Information Act.

The financial interests to be disclosed shall include ownership or distributive income share that is in excess of 5%, or an amount greater than 60% of the annual salary of the Governor, of the bidding entity or its parent entity, whichever is less, unless the contractor or bidder is a publicly traded entity subject to Federal 10K reporting, in which case it may submit its 10K disclosure in place of the prescribed disclosure. If a bidder is a privately held entity that is exempt from Federal 10K reporting, but has more than 400 shareholders, it may submit the information that Federal 10K companies are required to report, and list the names of any person or entity holding any ownership share that is in excess of 5%. The disclosure shall include the names, addresses, and dollar or proportionate share of ownership of each person making the disclosure, their instrument of ownership or beneficial relationship, and notice of any potential conflict of interest resulting from the current ownership or beneficial interest of each person making the disclosure having any of the relationships identified in Section 50-35 and on the disclosure form.

In addition, all disclosures shall indicate any other current or pending contracts, proposals, leases, or other ongoing procurement relationships the bidding entity has with any other unit of state government and shall clearly identify the unit and the contract, proposal, lease, or other relationship.

2. Disclosure Forms. Disclosure Form A is attached for use concerning the individuals meeting the above ownership or distributive share requirements. Subject individuals should be covered each by one form. In addition, a second form (Disclosure Form B) provides for the disclosure of current or pending procurement relationships with other (non-IDOT) state agencies. **The forms must be included with each bid or incorporated by reference.**

C. Disclosure Form Instructions

Form A: For bidders that have previously submitted the information requested in Form A

The Department has retained the Form A disclosures submitted by all bidders responding to these requirements for the April 24, 1998 or any subsequent letting conducted by the Department. The bidder has the option of submitting the information again or the bidder may check the following certification statement indicating that the information previously submitted by the bidder is, as of the date of submission, current and accurate. Before checking this certification, the bidder should carefully review its prior submissions to ensure the Certification is correct. If the Bidder checks the Certification, the Bidder should proceed to Form B instructions.

CERTIFICATION STATEMENT

I have determined that the Form A disclosure information previously submitted is current and accurate, and all forms are hereby incorporated by reference in this bid. Any necessary additional forms or amendments to previously submitted forms are attached to this bid.

(Bidding Company)



Signature of Authorized Representative

Date

Form A: For bidders who have NOT previously submitted the information requested in Form A

If the bidder is a publicly traded entity subject to Federal 10K reporting, the 10K Report may be submitted to meet the requirements of Form A. If a bidder is a privately held entity that is exempt from Federal 10K reporting, but has more than 400 shareholders, it may submit the information that Federal 10K companies are required to report, and list the names of any person or entity holding any ownership share that is in excess of 5%. If a bidder is not subject to Federal 10K reporting, the bidder must determine if any individuals are required by law to complete a financial disclosure form. To do this, the bidder should answer each of the following questions. A "YES" answer indicates Form A must be completed. If the answer to each of the following questions is "NO", then the NOT APPLICABLE STATEMENT on the second page of Form A must be signed and dated by a person that is authorized to execute contracts for the bidding company. Note: These questions are for assistance only and are not required to be completed.

1. Does anyone in your organization have a direct or beneficial ownership share of greater than 5% of the bidding entity or parent entity? YES ___ NO ___
2. Does anyone in your organization have a direct or beneficial ownership share of less than 5%, but which has a value greater than \$102,600.00? YES ___ NO ___
3. Does anyone in your organization receive more than \$102,600.00 of the bidding entity's or parent entity's distributive income? (Note: Distributive income is, for these purposes, any type of distribution of profits. An annual salary is not distributive income.) YES ___ NO ___
4. Does anyone in your organization receive greater than 5% of the bidding entity's or parent entity's total distributive income, but which is less than \$102,600.00? YES ___ NO ___

(Note: Only one set of forms needs to be completed per person per bid even if a specific individual would require a yes answer to more than one question.)

A "YES" answer to any of these questions requires the completion of Form A. The bidder must determine each individual in the bidding entity or the bidding entity's parent company that would cause the questions to be answered "Yes". Each form must be signed and dated by a person that is authorized to execute contracts for your organization. **Photocopied or stamped signatures are not acceptable.** The person signing can be, but does not have to be, the person for which the form is being completed. The bidder is responsible for the accuracy of any information provided.

If the answer to each of the above questions is "NO", then the NOT APPLICABLE STATEMENT on page 2 of Form A must be signed and dated by a person that is authorized to execute contracts for your company.

Form B: Identifying Other Contracts & Procurement Related Information Disclosure Form B must be completed for each bid submitted by the bidding entity. Note: *Checking the NOT APPLICABLE STATEMENT on Form A does not allow the bidder to ignore Form B. Form B must be completed, checked, and dated or the bidder may be considered nonresponsive and the bid will not be accepted.*

The Bidder shall identify, by checking Yes or No on Form B, whether it has any pending contracts (including leases), bids, proposals, or other ongoing procurement relationship with any other (non-IDOT) State of Illinois agency. If "No" is checked, the bidder only needs to complete the check box on the bottom of Form B. If "Yes" is checked, the bidder must do one of the following:

Option I: If the bidder did not submit an Affidavit of Availability to obtain authorization to bid, the bidder must list all non-IDOT State of Illinois agency pending contracts, leases, bids, proposals, and other ongoing procurement relationships. These items may be listed on Form B or on an attached sheet(s). Do not include IDOT contracts. Contracts with cities, counties, villages, etc. are not considered State of Illinois agency contracts and are not to be included. Contracts with other State of Illinois agencies such as the Department of Natural Resources or the Capital Development Board must be included. Bidders who submit Affidavits of Availability are suggested to use Option II.

Option II: If the bidder is required and has submitted an Affidavit of Availability in order to obtain authorization to bid, the bidder may write or type "See Affidavit of Availability" which indicates that the Affidavit of Availability is incorporated by reference and includes all non-IDOT State of Illinois agency pending contracts, leases, bids, proposals, and other ongoing procurement relationships. For any contracts that are not covered by the Affidavit of Availability, the bidder must identify them on Form B or on an attached sheet(s). These might be such things as leases.

D. Bidders Submitting More Than One Bid

Bidders submitting multiple bids may submit one set of forms consisting of all required Form A disclosures and one Form B for use with all bids. Please indicate in the space provided below the bid item that contains the original disclosure forms and the bid items which incorporate the forms by reference.

- The bid submitted for letting item _____ contains the Form A disclosures or Certification Statement and the Form B disclosures. The following letting items incorporate the said forms by reference:

**ILLINOIS DEPARTMENT
OF TRANSPORTATION**

**Form A
Financial Information &
Potential Conflicts of Interest
Disclosure**

Contractor Name		
Legal Address		
City, State, Zip		
Telephone Number	Email Address	Fax Number (if available)

Disclosure of the information contained in this Form is required by the Section 50-35 of the Illinois Procurement Code (30 ILCS 500). Vendors desiring to enter into a contract with the State of Illinois must disclose the financial information and potential conflict of interest information as specified in this Disclosure Form. This information shall become part of the publicly available contract file. This Form A must be completed for bids in excess of \$10,000, and for all open-ended contracts. **A publicly traded company may submit a 10K disclosure (or equivalent if applicable) in satisfaction of the requirements set forth in Form A. See Disclosure Form Instructions.**

DISCLOSURE OF FINANCIAL INFORMATION

1. Disclosure of Financial Information. The individual named below has an interest in the BIDDER (or its parent) in terms of ownership or distributive income share in excess of 5%, or an interest which has a value of more than \$102,600.00 (60% of the Governor's salary as of 7/1/07). **(Make copies of this form as necessary and attach a separate Disclosure Form A for each individual meeting these requirements)**

FOR INDIVIDUAL (type or print information)

NAME: _____

ADDRESS _____

Type of ownership/distributable income share:

stock _____ sole proprietorship _____ Partnership _____ other: (explain on separate sheet):
% or \$ value of ownership/distributable income share: _____

2. Disclosure of Potential Conflicts of Interest. Check "Yes" or "No" to indicate which, if any, of the following potential conflict of interest relationships apply. If the answer to any question is "Yes", please attach additional pages and describe.

(a) State employment, currently or in the previous 3 years, including contractual employment of services. Yes ___ No ___

If your answer is yes, please answer each of the following questions.

1. Are you currently an officer or employee of either the Capitol Development Board or the Illinois Toll Highway Authority? Yes ___ No ___

2. Are you currently appointed to or employed by any agency of the State of Illinois? If you are currently appointed to or employed by any agency of the State of Illinois, and your annual salary exceeds \$102,600.00, (60% of the Governor's salary as of 7/1/07) provide the name the State agency for which you are employed and your annual salary. _____

RETURN WITH BID/OFFER

- 3. If you are currently appointed to or employed by any agency of the State of Illinois, and your annual salary exceeds \$102,600.00, (60% of the Governor's salary as of 7/1/07) are you entitled to receive (i) more than 7 1/2% of the total distributable income of your firm, partnership, association or corporation, or (ii) an amount in excess of the salary of the Governor? Yes ___ No ___
- 4. If you are currently appointed to or employed by any agency of the State of Illinois, and your annual salary exceeds \$102,600.00, (60% of the Governor's salary as of 7/1/07) are you and your spouse or minor children entitled to receive (i) more than 15 % in the aggregate of the total distributable income of your firm, partnership, association or corporation, or (ii) an amount in excess of 2 times the salary of the Governor? Yes ___ No ___

(b) State employment of spouse, father, mother, son, or daughter, including contractual employment services in the previous 2 years.

Yes ___ No ___

If your answer is yes, please answer each of the following questions.

- 1. Is your spouse or any minor children currently an officer or employee of the Capitol Development Board or the Illinois Toll Highway Authority? Yes ___ No ___
- 2. Is your spouse or any minor children currently appointed to or employed by any agency of the State of Illinois? If your spouse or minor children is/are currently appointed to or employed by any agency of the State of Illinois, and his/her annual salary exceeds \$102,600.00, (60 % of the Governor's salary as of 7/1/07) provide the name of your spouse and/or minor children, the name of the State agency for which he/she is employed and his/her annual salary. _____

- 3. If your spouse or any minor children is/are currently appointed to or employed by any agency of the State of Illinois, and his/her annual salary exceeds \$102,600.00, (60% of the salary of the Governor as of 7/1/07) are you entitled to receive (i) more then 71/2% of the total distributable income of your firm, partnership, association or corporation, or (ii) an amount in excess of the salary of the Governor? Yes ___ No ___
- 4. If your spouse or any minor children are currently appointed to or employed by any agency of the State of Illinois, and his/her annual salary exceeds \$102,600.00, (60% of the Governor's salary as of 7/1/07) are you and your spouse or minor children entitled to receive (i) more than 15 % in the aggregate of the total distributable income of your firm, partnership, association or corporation, or (ii) an amount in excess of 2 times the salary of the Governor? Yes ___ No ___

(c) Elective status; the holding of elective office of the State of Illinois, the government of the United States, any unit of local government authorized by the Constitution of the State of Illinois or the statutes of the State of Illinois currently or in the previous 3 years.

Yes ___ No ___

(d) Relationship to anyone holding elective office currently or in the previous 2 years; spouse, father, mother, son, or daughter.

Yes ___ No ___

(e) Appointive office; the holding of any appointive government office of the State of Illinois, the United States of America, or any unit of local government authorized by the Constitution of the State of Illinois or the statutes of the State of Illinois, which office entitles the holder to compensation in excess of the expenses incurred in the discharge of that office currently or in the previous 3 years.

Yes ___ No ___

(f) Relationship to anyone holding appointive office currently or in the previous 2 years; spouse, father, mother, son, or daughter.

Yes ___ No ___

(g) Employment, currently or in the previous 3 years, as or by any registered lobbyist of the State government.

Yes ___ No ___

RETURN WITH BID/OFFER

(h) Relationship to anyone who is or was a registered lobbyist in the previous 2 years; spouse, father, mother, son, or daughter. Yes ___ No ___

(i) Compensated employment, currently or in the previous 3 years, by any registered election or reelection committee registered with the Secretary of State or any county clerk of the State of Illinois, or any political action committee registered with either the Secretary of State or the Federal Board of Elections. Yes ___ No ___

(j) Relationship to anyone; spouse, father, mother, son, or daughter; who was a compensated employee in the last 2 years by any registered election or re-election committee registered with the Secretary of State or any county clerk of the State of Illinois, or any political action committee registered with either the Secretary of State or the Federal Board of Elections. Yes ___ No ___

APPLICABLE STATEMENT

This Disclosure Form A is submitted on behalf of the INDIVIDUAL named on previous page.

Completed by: _____ Date _____
Signature of Individual or Authorized Representative

NOT APPLICABLE STATEMENT

I have determined that no individuals associated with this organization meet the criteria that would require the completion of this Form A.

This Disclosure Form A is submitted on behalf of the CONTRACTOR listed on the previous page.

_____ Date _____
Signature of Authorized Representative

RETURN WITH BID/OFFER

ILLINOIS DEPARTMENT
OF TRANSPORTATION

Form B
Other Contracts &
Procurement Related Information
Disclosure

Contractor Name		
Legal Address		
City, State, Zip		
Telephone Number	Email Address	Fax Number (if available)

Disclosure of the information contained in this Form is required by the Section 50-35 of the Illinois Procurement Act (30 ILCS 500). This information shall become part of the publicly available contract file. This Form B must be completed for bids in excess of \$10,000, and for all open-ended contracts.

DISCLOSURE OF OTHER CONTRACTS AND PROCUREMENT RELATED INFORMATION

1. Identifying Other Contracts & Procurement Related Information. The BIDDER shall identify whether it has any pending contracts (including leases), bids, proposals, or other ongoing procurement relationship with any other State of Illinois agency: Yes ___ No ___

If "No" is checked, the bidder only needs to complete the signature box on the bottom of this page.

2. If "Yes" is checked. Identify each such relationship by showing State of Illinois agency name and other descriptive information such as bid or project number (attach additional pages as necessary). SEE DISCLOSURE FORM INSTRUCTIONS:

THE FOLLOWING STATEMENT MUST BE CHECKED

<input type="checkbox"/>	_____	_____
	Signature of Authorized Representative	Date

RETURN WITH BID

SPECIAL NOTICE TO CONTRACTORS

The following requirements of the Illinois Department of Human Rights' Rules and Regulations are applicable to bidders on all construction contracts advertised by the Illinois Department of Transportation:

CONSTRUCTION EMPLOYEE UTILIZATION PROJECTION

- (a) All bidders on construction contracts shall complete and submit, along with and as part of their bids, a Bidder's Employee Utilization Form (Form BC-1256) setting forth a projection and breakdown of the total workforce intended to be hired and/or allocated to such contract work by the bidder including a projection of minority and female employee utilization in all job classifications on the contract project.
- (b) The Department of Transportation shall review the Employee Utilization Form, and workforce projections contained therein, of the contract awardee to determine if such projections reflect an underutilization of minority persons and/or women in any job classification in accordance with the Equal Employment Opportunity Clause and Section 7.2 of the Illinois Department of Human Rights' Rules and Regulations for Public Contracts adopted as amended on September 17, 1980. If it is determined that the contract awardee's projections reflect an underutilization of minority persons and/or women in any job classification, it shall be advised in writing of the manner in which it is underutilizing and such awardee shall be considered to be in breach of the contract unless, prior to commencement of work on the contract project, it submits revised satisfactory projections or an acceptable written affirmative action plan to correct such underutilization including a specific timetable geared to the completion stages of the contract.
- (c) The Department of Transportation shall provide to the Department of Human Rights a copy of the contract awardee's Employee Utilization Form, a copy of any required written affirmative action plan, and any written correspondence related thereto. The Department of Human Rights may review and revise any action taken by the Department of Transportation with respect to these requirements.

RETURN WITH BID



Contract No. 68781
HENDERSON-WARREN Counties
Section D4 MISC. SIGNAL WORK 2008-4
Route FAP 313/310
District 4 Construction Funds

PART I. IDENTIFICATION

Dept. Human Rights # _____ Duration of Project: _____
 Name of Bidder: _____

PART II. WORKFORCE PROJECTION

A. The undersigned bidder has analyzed minority group and female populations, unemployment rates and availability of workers for the location in which this contract work is to be performed, and for the locations from which the bidder recruits employees, and hereby submits the following workforce projection including a projection for minority and female employee utilization in all job categories in the workforce to be allocated to this contract:

TABLE A

TOTAL Workforce Projection for Contract												
JOB CATEGORIES	TOTAL EMPLOYEES		MINORITY EMPLOYEES						TRAINEES			
			BLACK		HISPANIC		*OTHER MINOR.		APPRENTICES		ON THE JOB TRAINEES	
	M	F	M	F	M	F	M	F	M	F	M	F
OFFICIALS (MANAGERS)												
SUPERVISORS												
FOREMEN												
CLERICAL EQUIPMENT OPERATORS												
MECHANICS												
TRUCK DRIVERS												
IRONWORKERS												
CARPENTERS												
CEMENT MASONS												
ELECTRICIANS												
PIPEFITTERS, PLUMBERS												
PAINTERS												
LABORERS, SEMI-SKILLED												
LABORERS, UNSKILLED												
TOTAL												

TABLE B

CURRENT EMPLOYEES TO BE ASSIGNED TO CONTRACT					
TOTAL EMPLOYEES			MINORITY EMPLOYEES		
M	F		M	F	

TABLE C

TOTAL Training Projection for Contract								
EMPLOYEES IN TRAINING	TOTAL EMPLOYEES		BLACK		HISPANIC		*OTHER MINOR.	
	M	F	M	F	M	F	M	F
APPRENTICES								
ON THE JOB TRAINEES								

FOR DEPARTMENT USE ONLY

*Other minorities are defined as Asians (A) or Native Americans (N).
 Please specify race of each employee shown in Other Minorities column.
Note: See instructions on the next page

RETURN WITH BID

**Contract No. 68781
HENDERSON-WARREN Counties
Section D4 MISC. SIGNAL WORK 2008-4
Route FAP 313/310
District 4 Construction Funds**

PART II. WORKFORCE PROJECTION - continued

B. Included in "Total Employees" under Table A is the total number of **new hires** that would be employed in the event the undersigned bidder is awarded this contract.

The undersigned bidder projects that: (number) _____ new hires would be recruited from the area in which the contract project is located; and/or (number) _____ new hires would be recruited from the area in which the bidder's principal office or base of operation is located.

C. Included in "Total Employees" under Table A is a projection of numbers of persons to be employed directly by the undersigned bidder as well as a projection of numbers of persons to be employed by subcontractors.

The undersigned bidder estimates that (number) _____ persons will be directly employed by the prime contractor and that (number) _____ persons will be employed by subcontractors.

PART III. AFFIRMATIVE ACTION PLAN

A. The undersigned bidder understands and agrees that in the event the foregoing minority and female employee utilization projection included under **PART II** is determined to be an underutilization of minority persons or women in any job category, and in the event that the undersigned bidder is awarded this contract, he/she will, prior to commencement of work, develop and submit a written Affirmative Action Plan including a specific timetable (geared to the completion stages of the contract) whereby deficiencies in minority and/or female employee utilization are corrected. Such Affirmative Action Plan will be subject to approval by the contracting agency and the **Department of Human Rights**.

B. The undersigned bidder understands and agrees that the minority and female employee utilization projection submitted herein, and the goals and timetable included under an Affirmative Action Plan if required, are deemed to be part of the contract specifications.

Company _____ Telephone Number _____

Address _____

NOTICE REGARDING SIGNATURE

The Bidder's signature on the Proposal Signature Sheet will constitute the signing of this form. The following signature block needs to be completed only if revisions are required.

Signature: _____ Title: _____ Date: _____

- Instructions: All tables must include subcontractor personnel in addition to prime contractor personnel.
- Table A - Include both the number of employees that would be hired to perform the contract work and the total number currently employed (Table B) that will be allocated to contract work, and include all apprentices and on-the-job trainees. The "Total Employees" column should include all employees including all minorities, apprentices and on-the-job trainees to be employed on the contract work.
- Table B - Include all employees currently employed that will be allocated to the contract work including any apprentices and on-the-job trainees currently employed.
- Table C - Indicate the racial breakdown of the total apprentices and on-the-job trainees shown in Table A.

RETURN WITH BID

**Contract No. 68781
HENDERSON-WARREN Counties
Section D4 MISC. SIGNAL WORK 2008-4
Route FAP 313/310
District 4 Construction Funds**

PROPOSAL SIGNATURE SHEET

The undersigned bidder hereby makes and submits this bid on the subject Proposal, thereby assuring the Department that all requirements of the Invitation for Bids and rules of the Department have been met, that there is no misunderstanding of the requirements of paragraph 3 of this Proposal, and that the contract will be executed in accordance with the rules of the Department if an award is made on this bid.

Firm Name _____
(IF AN INDIVIDUAL) Signature of Owner _____
Business Address _____

Firm Name _____
By _____
(IF A CO-PARTNERSHIP) Business Address _____

Name and Address of All Members of the Firm:

Corporate Name _____
By _____
Signature of Authorized Representative _____
Typed or printed name and title of Authorized Representative _____
(IF A CORPORATION) Attest _____
Signature _____
(IF A JOINT VENTURE, USE THIS SECTION
FOR THE MANAGING PARTY AND THE
SECOND PARTY SHOULD SIGN BELOW) Business Address _____

Corporate Name _____
By _____
Signature of Authorized Representative _____
Typed or printed name and title of Authorized Representative _____
(IF A JOINT VENTURE) Attest _____
Signature _____
Business Address _____

If more than two parties are in the joint venture, please attach an additional signature sheet.



RETURN WITH BID

Division of Highways
Proposal Bid Bond
(Effective November 1, 1992)

Item No.
Letting Date

KNOW ALL MEN BY THESE PRESENTS, That We
as PRINCIPAL, and

held jointly, severally and firmly bound unto the STATE OF ILLINOIS in the penal sum of 5 percent of the total bid price, or for the amount specified in Article 102.09 of the "Standard Specifications for Road and Bridge Construction" in effect on the date of invitation for bids, whichever is the lesser sum, well and truly to be paid unto said STATE OF ILLINOIS, for the payment of which we bind ourselves, our heirs, executors, administrators, successors and assigns.

THE CONDITION OF THE FOREGOING OBLIGATION IS SUCH, That Whereas, the PRINCIPAL has submitted a bid proposal to the STATE OF ILLINOIS, acting through the Department of Transportation, for the improvement designated by the Transportation Bulletin Item Number and Letting Date indicated above.

NOW, THEREFORE, if the Department shall accept the bid proposal of the PRINCIPAL; and if the PRINCIPAL shall, within the time and as specified in the bidding and contract documents, submit a DBE Utilization Plan that is accepted and approved by the Department; and if, after award by the Department, the PRINCIPAL shall enter into a contract in accordance with the terms of the bidding and contract documents including evidence of the required insurance coverages and providing such bond as specified with good and sufficient surety for the faithful performance of such contract and for the prompt payment of labor and material furnished in the prosecution thereof; or if, in the event of the failure of the PRINCIPAL to make the required DBE submission or to enter into such contract and to give the specified bond, the PRINCIPAL pays to the Department the difference not to exceed the penalty hereof between the amount specified in the bid proposal and such larger amount for which the Department may contract with another party to perform the work covered by said bid proposal, then this obligation shall be null and void, otherwise, it shall remain in full force and effect.

IN THE EVENT the Department determines the PRINCIPAL has failed to comply with any requirement as set forth in the preceding paragraph, then Surety shall pay the penal sum to the Department within fifteen (15) days of written demand therefor. If Surety does not make full payment within such period of time, the Department may bring an action to collect the amount owed. Surety is liable to the Department for all its expenses, including attorney's fees, incurred in any litigation in which it prevails either in whole or in part.

In TESTIMONY WHEREOF, the said PRINCIPAL and the said SURETY have caused this instrument to be signed by their respective officers this day of A.D.,

PRINCIPAL SURETY
(Company Name) (Company Name)
By: (Signature & Title) By: (Signature of Attorney-in-Fact)

Notary Certification for Principal and Surety

STATE OF ILLINOIS,
COUNTY OF

I, a Notary Public in and for said County, do hereby certify that
and

(Insert names of individuals signing on behalf of PRINCIPAL & SURETY)

who are each personally known to me to be the same persons whose names are subscribed to the foregoing instrument on behalf of PRINCIPAL and SURETY, appeared before me this day in person and acknowledged respectively, that they signed and delivered said instrument as their free and voluntary act for the uses and purposes therein set forth.

Given under my hand and notarial seal this day of, A.D.

My commission expires
Notary Public

In lieu of completing the above section of the Proposal Bid Form, the Principal may file an Electronic Bid Bond. By signing below the Principal is ensuring the identified electronic bid bond has been executed and the Principal and Surety are firmly bound unto the State of Illinois under the conditions of the bid bond as shown above.

Electronic Bid Bond ID# Company/Bidder Name Signature and Title

PROPOSAL ENVELOPE



PROPOSALS

for construction work advertised for bids by the
Illinois Department of Transportation

Item No.	Item No.	Item No.

Submitted By:

Name:
Address:
Phone No.

Bidders should use an IDOT proposal envelope or affix this form to the front of a 10" x 13" envelope for the submittal of bids. If proposals are mailed, they should be enclosed in a second or outer envelope addressed to:

Engineer of Design and Environment - Room 326
Illinois Department of Transportation
2300 South Dirksen Parkway
Springfield, Illinois 62764

NOTICE

Individual bids, including Bid Bond and/or supplemental information if required, should be securely stapled.

CONTRACTOR OFFICE COPY OF CONTRACT SPECIFICATIONS

NOTICE

None of the following material needs to be returned with the bid package unless the special provisions require documentation and/or other information to be submitted.

**Contract No. 68781
HENDERSON-WARREN Counties
Section D4 MISC. SIGNAL WORK 2008-4
Route FAP 313/310
District 4 Construction Funds**



Illinois Department of Transportation



NOTICE TO BIDDERS

- 1. TIME AND PLACE OF OPENING BIDS.** Sealed proposals for the improvement described herein will be received by the Department of Transportation at the Harry R. Hanley Building, 2300 South Dirksen Parkway, in Springfield, Illinois until 10:00 o'clock a.m., January 18, 2008. All bids will be gathered, sorted, publicly opened and read in the auditorium at the Department of Transportation's Harry R. Hanley Building shortly after the 10:00 a.m. cut off time.
- 2. DESCRIPTION OF WORK.** The proposed improvement is identified and advertised for bids in the Invitation for Bids as:

**Contract No. 68781
HENDERSON-WARREN Counties
Section D4 MISC. SIGNAL WORK 2008-4
Route FAP 313/310
District 4 Construction Funds**

This project consists of installing detector loops and updating existing traffic signal installations in accordance with NEC requirements located at the intersection of U.S. Route 34 and Carman Road in Henderson County and at the intersections of U.S. Route 34 and U.S. Route 67 and U.S. Route 34 and 11th Street in Warren County.

- 3. INSTRUCTIONS TO BIDDERS.** (a) This Notice, the invitation for bids, proposal and letter of award shall, together with all other documents in accordance with Article 101.09 of the Standard Specifications for Road and Bridge Construction, become part of the contract. Bidders are cautioned to read and examine carefully all documents, to make all required inspections, and to inquire or seek explanation of the same prior to submission of a bid.

(b) State law, and, if the work is to be paid wholly or in part with Federal-aid funds, Federal law requires the bidder to make various certifications as a part of the proposal and contract. By execution and submission of the proposal, the bidder makes the certification contained therein. A false or fraudulent certification shall, in addition to all other remedies provided by law, be a breach of contract and may result in termination of the contract.
- 4. AWARD CRITERIA AND REJECTION OF BIDS.** This contract will be awarded to the lowest responsive and responsible bidder considering conformity with the terms and conditions established by the Department in the rules, Invitation for Bids and contract documents. The issuance of plans and proposal forms for bidding based upon a prequalification rating shall not be the sole determinant of responsibility. The Department reserves the right to determine responsibility at the time of award, to reject any or all proposals, to readvertise the proposed improvement, and to waive technicalities.

By Order of the
Illinois Department of Transportation

Milton R. Sees, Secretary

BD 351 (Rev. 01/2003)

INDEX
FOR
SUPPLEMENTAL SPECIFICATIONS
AND RECURRING SPECIAL PROVISIONS

Adopted January 1, 2008

This index contains a listing of SUPPLEMENTAL SPECIFICATIONS and frequently used RECURRING SPECIAL PROVISIONS.

ERRATA Standard Specifications for Road and Bridge Construction (Adopted 1-1-07) (Revised 1-1-08)

SUPPLEMENTAL SPECIFICATIONS

<u>Std. Spec. Sec.</u>	<u>Page No.</u>
205 Embankment	1
251 Mulch	2
253 Planting Woody Plants	3
280 Temporary Erosion Control	5
443 Reflective Crack Control Treatment	6
502 Excavation for Structures	9
503 Concrete Structures	10
505 Steel Structures	11
540 Box Culverts	12
633 Removing and Reerecting Guardrail and Terminals	13
672 Sealing Abandoned Water Wells	14
701 Work Zone Traffic Control and Protection	15
838 Breakaway Devices	16
1004 Coarse Aggregates	17
1020 Portland Cement Concrete	18
1022 Concrete Curing Materials	20
1042 Precast Concrete Products	21
1062 Reflective Crack Control System	22
1069 Pole and Tower	24
1081 Materials for Planting	27
1083 Elastomeric Bearings	29
1102 Hot-Mix Asphalt Equipment	30

RECURRING SPECIAL PROVISIONS

The following RECURRING SPECIAL PROVISIONS indicated by an "X" are applicable to this contract and are included by reference:

<u>CHECK SHEET #</u>	<u>PAGE NO.</u>
1	31
2	33
3 X	34
4 X	44
5 X	49
6	54
7	55
8	56
9	57
10	60
11	63
12	65
13	69
14	71
15	72
16	74
17	75
18	77
19	78
20	79
21	83
22	85
23	87
24	89
25	90
26	91
27	92
28	93
29	94
30	100
31	108

TABLE OF CONTENTS

LOCATION OF PROJECT	1
DESCRIPTION OF PROJECT	1
LOCATION OF UNDERGROUND STATE MAINTAINED FACILITIES.....	1
CONTRACT GUARANTEE	2
INDUCTIVE LOOP DETECTOR	2
BATTERY BACKUP SYSTEM WITH CABINET.....	3
ELECTRIC CABLE IN CONDUIT, GROUNDING, NO. 6 1C.....	11
REMOVE EXISTING TRAFFIC SIGNAL EQUIPMENT, SPECIAL	12
TRAFFIC CONTROL PLAN	13
EQUIPMENT RENTAL RATES (BDE)	13
PAYMENTS TO SUBCONTRACTORS (BDE).....	14
REFLECTIVE SHEETING ON CHANNELIZING DEVICES (BDE)	15
SUBCONTRACTOR MOBILIZATION PAYMENTS (BDE)	16
TRAFFIC SIGNAL GROUNDING (BDE).....	17
WORKING DAYS (BDE)	18

STATE OF ILLINOIS

SPECIAL PROVISIONS

The following Special Provisions supplement the "Standard Specifications for Road and Bridge Construction," adopted January 1, 2007, the latest edition of the "Manual on Uniform Traffic Control Devices for Streets and Highways," and the "Manual of Test Procedures for Materials" in effect on the date of invitation for bids, and the Supplemental Specifications and Recurring Special Provisions indicated on the Check Sheet included herein which apply to and govern the construction of FAP Routes 313 and 310 (US 34 & US 67), Section D4 Misc Signal Work 2008-4 in Henderson and Warren Counties and in case of conflict with any part or parts of said Specifications, the said Special Provisions shall take precedence and shall govern.

LOCATION OF PROJECT

This project improvement is located at the following intersections:

Henderson County

Gulfport: US Route 34 and Carman Road.

Warren County

Monmouth: US Route 34 and US Route 67, US Route 34 and 11th Street.

DESCRIPTION OF PROJECT

This project consists of installing detector loops, detector loop lead-in cable, battery back-up systems, inductive loop detectors, grounding existing traffic signal facilities in accordance with NEC requirements, and performing all other collateral work required to complete the improvement for this project in Henderson and Warren Counties.

LOCATION OF UNDERGROUND STATE MAINTAINED FACILITIES

The Contractor shall be responsible for locating all existing IDOT electrical facilities prior to performing any work at his/her own expense if required. The Contractor shall also be liable for any damage to facilities resulting from inaccurate locating. The Contractor may obtain, on request, plans of existing electrical facilities from the Department.

The Contractor shall also be responsible for locating and providing protection for facilities during all phases of construction. If at any time, the facilities are damaged, the Contractor shall immediately notify the Department and make all necessary arrangements for repair to the satisfaction of the Engineer. This work shall be included in the contract bid price and no additional compensation will be allowed.

CONTRACT GUARANTEE

The Contractor shall guarantee all electrical equipment, apparatus, materials, and workmanship provided under the contract for a period of six (6) months after the date of final inspection according to Article 801.07.

All instruction sheets required to be furnished by the manufacturer for materials and supplies and for operations shall be delivered to the Engineer prior to the acceptance of the project, with the following warranties and guarantees:

1. The manufacturer's standard written warranty for each piece of electrical equipment or apparatus furnished under the contract.
2. The Contractor's written guarantee that, for a period of six (6) months after the date of final inspection of the project, all necessary repairs to or replacement of said warranted equipment, or apparatus shall be made by the Contractor at no cost to the Department.
3. The Contractor's written guarantee for satisfactory operation of all electrical systems furnished and constructed under the contract for a period of 6 months after final inspection of the project.

INDUCTIVE LOOP DETECTOR

This work shall be in accordance with Sections 885 and 1079 of the Standard Specifications except as modified herein.

The detector amplifier shall be equipped with an LCD display that is capable of displaying the loop frequency and inductance and shall conform to the following specifications:

- Custom LCD displays complete status and function settings of the detector.
- All functions are programmable from the front panel LCD "Menu" - no removing of detector to change function settings.
- LCD displays loop frequency, loop inductance, & - L/L% values.
- LCD displays the accumulated number of loop failure incidents since the detector was last reset - helps diagnose intermittent systems.
- LCD bar graph displays loop inductance change to verify ideal sensitivity level setting.
- Selectable "Continuous-CALL" and "Channel-Off" to aid system troubleshooting.
- 8 loop frequencies and 9 levels of sensitivity.
- 2 Selectable modes of operation: Presence or Pulse.
- 255 second CALL Delay and 25.5 second Extension timers.
- 999 second Max. Presence Timer. NEMA TS 2 Status Output.
- EOG (end of green) reset synchronization for Max. Presence timer.
- Super bright LEDs indicate vehicle detection or loop failure.
- Environmentally sealed push button switches to insure trouble-free service.
- Phase Green (Delay Override) input.

The detector amplifier shall be equipped with relay or solid state outputs to ensure that the detectors fail in a constant call mode.

The RENO A&E Model C-1200 Series and EDI Oracle Series are currently approved for use within the District.

Basis of Payment: This work shall be paid for at the contract unit price each for INDUCTIVE LOOP DETECTOR which price shall be payment in full for all labor, equipment, and materials required to supply and install the inductive loop detector described above, complete.

BATTERY BACKUP SYSTEM WITH CABINET

Effective: August 27, 2003

Revised: April 4, 2007

The following models of Battery Backup Systems are approved for use within District Four:

Alpha Novus XFM 1100
Techpower Development M-E XL 1000

The Contractor shall be responsible for providing Battery Backup Systems that are sized appropriately for the intersection load. The total system load shall not exceed the manufacturer's specifications.

The battery backup systems will be installed in existing signal cabinets. The cost of performing all cabinet modifications required for installation shall be included in the bid price for the battery backup system. The cabinet modifications shall consist of, but not be limited to the following items:

- The cabinet light, ventilation fans, heater strips, and service receptacle shall be rewired to a separate circuit that will not be powered by the battery backup system.
- A hole of sufficient size for the cables will be drilled into the side of the cabinet to accommodate the battery backup system cables and harnesses from the BBS cabinet. The hole shall be free of sharp edges and equipped with a plastic or rubber grommet. Any relocating of existing panels or components that are required for BBS cabinet mounting will be included in this pay item. There will be no additional compensation allowed for moving or rearranging the cabinet shelves and traffic signal components.
- Installing the manual by-pass switch in the existing controller cabinet.
- All other modifications required for the installation of the battery backup system and cabinet.

All proposed cabinet modifications shall be subject to the approval of the Engineer. The Contractor shall provide a set of modified prints for each location.

GENERAL REQUIREMENTS: The Battery Back-up System (BBS) shall include, but not be limited to the following: inverter/charger, power transfer relay, batteries, battery cabinet, a separate manually operated non-electronic bypass switch and all necessary hardware and

interconnect wiring. The BBS shall provide reliable emergency power to a traffic signal in the event of a power failure or interruption. The transfer from utility power to battery power and vice versa shall not interfere with the normal operation of traffic controller, conflict monitor/malfunction management unit or any other peripheral devices within the traffic controller assembly.

The BBS shall provide power for full run-time operation for an "LED-only" intersection (all colors red, yellow, and green) or flashing mode operation for an intersection using Red LED's. As the battery reserve capacity reaches 50%, the intersection shall automatically be placed in all-red flash. The BBS shall allow the controller to automatically resume normal operation after the power has been restored. The BBS shall log an alarm in the controller for each time it is activated.

All Battery Backup Systems shall include four batteries.

The BBS shall be designed for outdoor applications, and shall meet the environmental requirements of, "NEMA Standards Publication No. TS 2 – Traffic Controller Assemblies," or applicable successor NEMA specifications, except as modified herein.

The BBS shall conform to the following specifications:

1.1 OPERATION

- 1.1 The BBS shall be on line and provide voltage regulation and power conditioning when utilizing utility power.
 - 1.1.1 The BBS shall provide a minimum two (2) hours of full run-time operation and four (4) hours all-red flash operation for an "LED-only" intersection (minimum 700W/1000VA active output capacity, with 80% minimum inverter efficiency).
- 1.19 The BBS shall be equipped with an integrated safety switch that will interrupt inverter output power in the event of a cabinet knockdown. The safety switch may be either internal to the inverter/charger or externally mounted inside of the BBS cabinet. The safety switch shall be designed to interrupt output power in the event that the charger/inverter is tilted more than twenty degrees on any axis. The switch shall be mechanically latching to ensure that power is not automatically restored to the BBS until the charger/inverter has been "reset". The switch shall also be resettable and reusable unless it has been physically damaged.
- 1.2 The maximum transfer time from loss of utility power to switchover to battery backed inverter power shall be 150 milli-seconds.
- 1.3 The BBS shall provide the user with four (4) sets of normally open (NO) and normally closed (NC) single-pole double-throw (SPDT) relay contact closures, available on a panel-mounted terminal block, rated at a minimum 120V/1A, and labeled so as to identify each contact. For typical configuration, see the plan detail sheet.

- 1.3.1 A first set of NO and NC contact closures shall be energized whenever the unit switches to battery power. Contact shall be labeled or marked "On Batt."
- 1.3.2 The second set of NO and NC contact closures shall be energized whenever the battery approaches approximately 40% of remaining useful capacity. Contact shall be labeled or marked "Low Batt."
- 1.3.3 The third set of NO and NC contact closures shall be energized two (2) hours after the unit switches to battery power. Contact shall be labeled or marked "Timer."
- 1.3.4 The fourth set of NO and NC contact closures shall be energized in the event of inverter/charger failure, battery failure or complete battery discharge. Contact shall be labeled or marked "BBS Fail or Status."
- 1.3.5 A surge suppression unit shall be provided for the output power if available as an option by the BBS manufacturer.
- 1.4 Operating temperature for both the inverter/power transfer relay and manual bypass switch shall be -37°C to $+74^{\circ}\text{C}$.
- 1.5 The Power Transfer Relay shall be rated at 240VAC/30AMPS minimum and Manual Bypass Switch shall be rated at 240VAC/20 amps, minimum.
- 1.55 The manual bypass switch shall be wired to provide power to the BBS when the switch is set to manual bypass.
- 1.6 The BBS shall use a temperature-compensated battery charging system. The charging system shall compensate over a range of 2.5 – 4.0 mV/ $^{\circ}\text{C}$ per cell.
- 1.6.1 The temperature sensor shall be external to the inverter/charger unit. The temperature sensor shall come with 2 meters (6'6") of wire.
- 1.7 Batteries shall not be recharged when battery temperature exceeds $50^{\circ}\text{C} \pm 3^{\circ}\text{C}$.
- 1.8 BBS shall bypass the utility line power whenever the utility line voltage is outside of the following voltage range: 100VAC to 130VAC ($\pm 2\text{VAC}$).
- 1.9 When utilizing battery power, the BBS output voltage shall be between 110 VAC and 125 VAC, pure sine wave output, $\pm 3\%$ THD, 60Hz $\pm 3\text{Hz}$.
- 1.10 BBS shall be compatible with Illinois DOT's traffic controller assemblies utilizing NEMA TS 1 or NEMA TS 2 controllers and cabinet components for full time operation.
- 1.11 When the utility line power has been restored at above 105 VAC ± 2 VAC for more than 30 seconds, the BBS shall dropout of battery backup mode and return to utility line mode.

- 1.12 When the utility line power has been restored at below 125VAC \pm 2 VAC for more than 30 seconds, the BBS shall dropout of battery backup mode and return to utility line mode.
- 1.13 BBS shall be equipped to prevent a malfunction feedback to the cabinet or from feeding back to the utility service.
- 1.14 In the event of inverter/charger failure, battery failure or complete battery discharge, the power transfer relay shall revert to the NC state, where utility line power is reconnected to the cabinet. The BBS shall always revert back to utility line power and shall be designed to revert back to utility line power in the event of a BBS fault condition.
- 1.15 Recharge time for the battery, from "protective low-cutoff" to 80% or more of full battery charge capacity, shall not exceed twenty (20) hours.
- 1.16 When the intersection is in battery operation, the BBS shall bypass all internal cabinet lights, ventilation fans, heater strips, and service receptacles.
- 1.17 The manual bypass switch shall be wired to provide power to the BBS when the switch is set to manual bypass.
- 1.18 A blue LED indicator light shall be mounted on the front of the traffic signal cabinet or on the side of the BBS cabinet facing traffic and shall turn on to indicate when the cabinet power has been disrupted and the BBS is in operation. The light shall be a minimum 1" diameter, be viewable from the driving lanes, and shall be large enough and visible enough to be seen from 200 ft. away.
- 1.19 All 36-volt and 48-volt systems shall include an external component that monitors battery charging to ensure that every battery in the string is fully charged. The device shall compensate for the effects of adding a new battery to an existing battery system by ensuring that the charge voltage is spread equally across all batteries. All cables, harnesses, cards, and other components that are required to provide the functionality described above shall be included in the unit bid price for the battery backup system. The following products are currently approved for use within District 4: Alpha Technologies: AlphaGuard with Charge Management Technology Module and Approved Equivalent.
- 1.20 The BBS shall be equipped with an integrated safety switch that will interrupt inverter output power in the event of a cabinet knockdown. The safety switch may be either internal to the inverter/charger or externally mounted inside of the BBS cabinet. The safety switch shall be designed to interrupt output power in the event that the charger/inverter is tilted more than twenty degrees on any axis. The switch shall be mechanically latching to ensure that power is not automatically restored to the BBS until the charger/inverter has been "reset". The switch shall also be resettable and reusable unless it has been physically damaged.

2.0 MOUNTING AND CONFIGURATION

2.1 GENERAL

2.1.1 Inverter/Charger Unit shall be rack or shelf-mounted.

2.1.2 (Reserved).

2.1.3 All interconnect wiring provided between Power Transfer Relay, Bypass Switch and Cabinet Terminal Service Block shall be no greater than two (2) meters (6'6") of #10 AWG wire.

2.1.4 Relay contact wiring provided for each set of NO/NC relay contact closure terminals shall be #18 AWG wire.

2.1.5 All necessary hardware for mounting (shelf angles, rack, etc) shall be included in the bid price of the BBS. The swing-trays shall be screwed to the Type IV or Type V NEMA cabinets using continuous stainless steel or aluminum piano hinge. All bolts/fasteners and washers shall meet the following requirements:

2.3 EXTERNAL BATTERY CABINET

2.3.1 The external cabinet shall be a rated NEMA Type 3R Cabinet.

2.3.2 Inverter/Charger and Power Transfer Relay shall be installed inside the external battery cabinet and the manually operated Bypass Switch shall be installed inside the existing Traffic Signal Cabinet.

2.3.3 Batteries shall be housed in the external cabinet which shall be NEMA Standard rated cabinet mounted to the side of the Type IV or Type V Cabinet (see plan sheets for details). This external battery cabinet shall conform to the IDOT Standard Specifications for traffic signal cabinets for the construction and finish of the cabinet.

2.3.4 The external battery cabinet shall mount to the Type IV or Type V NEMA Cabinet with a minimum of four (4) bolts to the satisfaction of the Engineer.

2.3.5 The dimensions of the external battery cabinet shall be 25" (L) x 16" (W) x 41" (H) and installed in accordance with the plan sheet cabinet detail and this specification.

2.3.6 The cabinet shall include heater mats for each battery shelf and/or battery. If the BBS charger/inverter does not have facilities to accommodate heater mat connections, thermostatically controlled heater mats shall be provided with the system. The heater mat thermostat shall be a separate thermostat (from the ventilation fan thermostat) and be adjustable from 0°F to 32°F for heater mat turn-on.

2.3.6 A warning sticker shall be placed on the outside of the cabinet indicating that there is an Uninterruptible Power Supply inside the cabinet.

- 2.3.7 The external battery cabinet shall be ventilated through the use of louvered vents (2), filters, and one thermostatically controlled fan as per NEMA TS 2 Specifications. The cabinet shall include a cleanable or replaceable cabinet filter.
- 2.3.8 External battery cabinet fan shall be AC operated from the same line output of the Manual Bypass Switch that supplies power to the Type IV or Type V Cabinet.
- 2.3.9 The BBS with external battery cabinet shall come with all bolts, conduits and bushings, gaskets, shelves, and hardware needed for mounting. The external battery cabinet shall have a hinged door opening to the entire cabinet. The cabinet shall include a bottom constructed from the same material as the cabinet.
- 2.3.10 The external cabinet shall be equipped with a power receptacle to accommodate the inverter/charger. The receptacle shall be wired to the line output of the manual bypass switch.

3.1 MAINTENANCE, DISPLAYS, CONTROLS AND DIAGNOSTICS

- 3.2 The BBS shall include a display and /or meter to indicate current battery charge status and conditions.
- 3.3 The BBS shall have lightning surge protection compliant with IEEE/ANSI C.62.41.
- 3.4 The BBS shall be equipped with an integral system to prevent battery from destructive discharge and overcharge.
- 3.5 The BBS and batteries shall be easily replaced with all needed hardware and shall not require any special tools for installation.
- 3.6 The BBS shall be equipped with an RS-232 port.
- 3.7 The BBS shall include a resettable front-panel event counter display to indicate the number of times the BBS was activated and a front-panel hour meter to display the total number of hours the unit has operated on battery power.
- 3.8 Manufacturer shall include two (2) sets of equipment lists, operation and maintenance manuals, and board-level schematic and wiring diagrams of the BBS, and the battery data sheets. Manufacturer shall include any software needed to monitor, diagnose, and operate the BBS. The manufacturer shall include any required cables to connect to a laptop computer.
- 3.8 The BBS shall include a data cable for the serial connection to the RS232 port and diagnostic software if it is available as an option with the unit.
- 3.9 Two copies of the owner/maintenance manuals shall be provided with the BBS.

4.1 BATTERY SYSTEM

- 4.2 Individual batteries shall be 12V type and shall be easily replaced and commercially available off the shelf.
- 4.3 The batteries shall be premium gel type with a five-year (5) full replacement warranty.
- 4.4 Batteries used for BBS shall consist of a minimum of four (4) to eight (8) batteries with a cumulative minimum rated capacity of 240 amp-hours.
- 4.5 Batteries shall be deep cycle, completely sealed, silver alloy VRLA (Valve Regulated Lead Acid) requiring no maintenance with maximum run time.
- 4.6 Batteries shall be certified by the manufacturer to operate over a temperature range of – 40°C to +71°C.
- 4.7 The batteries shall be provided with appropriate interconnect wiring and corrosion-resistant mounting trays and/or brackets appropriate for the cabinet into which they will be installed.
- 4.8 Batteries shall indicate maximum recharge data and recharging cycles.
- 4.9 Battery interconnect wiring shall be via modular harness. Batteries shall be shipped with positive and negative terminals pre-wired with red and black cabling that terminates into a typical power-pole style connector. Harness shall be equipped with mating power-pole style connectors for batteries and a single, insulated plug-in style connection to inverter/charger unit. Harness shall allow batteries to be quickly and easily connected in any order and shall be keyed and wired to ensure proper polarity and circuit configuration.
- 4.9 Battery terminals shall be covered and insulated so as to prevent accidental shorting.

5.0 QUALITY ASSURANCE

- 5.1 BBS shall be manufactured in accordance with a manufacturer quality assurance (QA) program. The QA program shall include two types of quality assurance: (1) Design quality assurance and (2) Production quality assurance. The production quality assurance shall include statistically controlled routine tests to ensure minimum performance levels of BBS units built to meet this specification and a documented process of how problems are to be resolved.
- 5.2 QA process and test results documentation shall be kept on file for a minimum period of seven years.
- 5.3.1 Battery Backup System designs not satisfying design qualification testing and the production quality assurance testing performance requirements described below shall not be labeled, advertised, or sold as conforming to this specification.

5.4 DESIGN QUALIFICATION TESTING

The manufacturer, or an independent testing lab hired by the manufacturer, shall perform design Qualification Testing on new BBS designs, and when a major design change has been implemented on an existing design. A major design change is defined as a design change (electrical or physical) which changes any of the performance characteristics of the system, or results in a different circuit configuration.

5.4.1 Burn In. The sample systems shall be energized for a minimum of five (5) hours, with full load of 700 watts, at temperatures of +74°C and -37°C., excluding batteries, before performing any design qualification testing.

5.4.2 Any failure of the BBS, which renders the unit non-compliant with the specification after burn-in, shall be cause for rejection.

5.4.3 For Operational Testing, all specifications may be measured including, but not limited to:

5.4.3.1 Run time while in battery backup mode, at full load.

5.4.3.2 Proper operation of all relay contact closures (“On-Batt”, “Low-Batt”, “Timer” and “BBS-Fail”).

5.4.3.3 Inverter output voltage, frequency, harmonic distortion, and efficiency, when in battery backup mode.

5.4.3.4 All utility mode – battery backup mode transfer voltage levels. See BBS Spec 1.8, 1.11 and 1.12.

5.4.3.5 Power transfer time from loss of utility power to switchover to battery backed inverter power.

5.4.3.6 Backfeed voltage to utility when in battery backup mode.

5.4.3.7 IEEE/ANSI C.62.41 compliance.

5.4.3.8 Battery charging time.

5.4.5.9 Event counter and runtime meter accuracy.

5.5 PRODUCTION QUALITY CONTROL TESTING

5.5.1 Production Quality Control tests shall consist of all of the above listed tests and shall be performed on each new system prior to shipment. Failure to meet requirements of any of these tests shall be cause for rejection. The manufacturer shall retain test results for seven years.

5.5.2 Each BBS shall be given a minimum 100-hour burn-in period to catch any premature failures.

5.5.3 Each system shall be visually inspected for any exterior physical damage or assembly anomalies. Any defects shall be cause for rejection.

6.0 WARRANTY

Manufacturers shall provide a minimum two-year (2) factory-repair warranty for parts and labor on the BBS from date of acceptance by the State. Batteries shall be warranted for full replacement for five (5) years from date of purchase. The warranty shall be included in the total bid price of the BBS.

The Contractor shall furnish a warranty certificate for each Battery Backup System that includes the equipment description and details, serial numbers, effective dates, and the details of the warranty regarding materials and labor. The warranty period shall begin on the date of installation and the warranty certificate shall reflect this date.

Basis of Payment: The above work will be paid for at the contract unit price each for BATTERY BACKUP SYSTEM WITH CABINET shall be payment in full for all labor, materials, and equipment required to provide, install, and test the battery backup system described above, complete.

DETECTOR LOOP, TYPE I

This work shall be in accordance with Sections 886 and 1079 of the Standard Specifications except as modified herein.

All detector loops shall utilize a separate pair of lead-ins and a Type II splice shall be used for all detector lead-ins.

All proposed detector loops shall be cut in the existing surface. The riser area shall be chipped out and filled with epoxy.

The Contractor shall locate and clean out the existing detector loop risers, conduit, and handholes.

Basis of Payment: The above work will be paid for at the contract unit price per foot for DETECTOR LOOP, TYPE I and shall be payment in full for all labor, materials, and equipment required to perform the work and install the detector loops described above.

ELECTRIC CABLE IN CONDUIT, GROUNDING, NO. 6 1C

This work shall be in accordance with the applicable Articles of Sections 807, 817 and 1066 of the Standard Specifications with the following modifications:

This work shall consist of furnishing and installing a grounding wire to connect all traffic signal handholes (lids and rings), mast arm assemblies, posts, light poles, cabinets and exposed metallic conduits. The proposed ground wire shall be an insulated #6 XLP green copper conductor. This wire shall be bonded to all items and their associated ground rods utilizing mechanical lugs and bolts. This wire may be made continuous by splicing in the adjacent handholes with compression lugs. Split bolts shall not be allowed.

The grounding wire shall be bonded to the grounded conductor at the service disconnect per the NEC.

When the lighting system is supplied by the same source as the signals, the lighting ground conductor may be utilized to provide the required signal equipment ground. All signal poles that are part of a lighting system shall be considered grounded as required by this provision.

All clamps, hardware, and other materials required shall be included in the bid price.

Basis of Payment: This work will be paid for at the contract unit price per foot for ELECTRIC CABLE IN CONDUIT, GROUNDING, NO. 6 1C which price shall be payment in full for all labor, materials, and equipment required to provide the grounding system described above.

REMOVE EXISTING TRAFFIC SIGNAL EQUIPMENT, SPECIAL

This work shall be in accordance with Section 895 of the Standard Specifications except as modified herein.

The Contractor shall remove the following items:

Removal Items	US 34 & Carman Rd.
Video Detection Camera Complete	4
Video Detection System Complete (Inside Existing Controller Cabinet)	1
Battery Backup Unit Complete (Inside Existing Controller Cabinet)	1
Video Detection Cable	ALL

The above list should represent an accurate listing of removal items, however, it is the Contractor's responsibility to verify all quantities prior to bidding. There will be no additional compensation.

The Contractor shall deliver the video detection and battery backup equipment to the IDOT Traffic Building located at 1025 West Detweiller Drive, Peoria, Illinois. The point of contact is Paul Grant at (309) 671-4474.

The Contractor shall dispose of the batteries and electric cable in accordance with all applicable regulations off of the right-of-way and reflect the salvage value of this equipment in the unit bid price for this pay item.

Basis of Payment: The above work will be paid for at the contract unit price lump sum for REMOVE EXISTING TRAFFIC SIGNAL EQUIPMENT, SPECIAL and shall be payment in full for removing and transporting the equipment described above, complete. No additional compensation will be allowed.

TRAFFIC CONTROL PLAN

Effective October 26, 2007

Traffic control shall be in accordance with the applicable sections of the "Standard Specifications for Road and Bridge Construction," the applicable guidelines contained in the "Illinois Manual on Uniform Traffic Control Devices for Streets and Highways," these Special Provisions, and any special details and Highway Standards contained herein and in the plans.

Special attention is called to Section 701 and Articles 107.09 and 107.14 of the "Standard Specifications for Road and Bridge Construction" and the following Highway Standards relating to traffic control:

701001 701006 701101 701106 701421 701426 701701 702001

Traffic shall be maintained on the associated roadways at all times during the construction of the lighting system. All lane closures shall be made during off-peak traffic hours, defined as time periods from 8:30 a.m. to 3:30 p.m. and 5:30 p.m. to 7:00 a.m. The Contractor shall notify the Engineer forty-eight (48) hours before the time of a planned closure. The exact time and duration of all lane closures, however, shall be as determined by the Engineer.

All traffic control devices shall be furnished, erected, maintained, and removed by the Contractor in accordance with the Standard Specifications. Where possible, all post-mounted signs shall be placed a minimum of two feet (2') (0.6 m) beyond the curb or edge of shoulder. Proposed sign spacing may be modified as approved by the Engineer in order to meet existing field conditions or to prevent obstruction of the motorist's view of permanent signing.

In the event that the Contractor needs to place an intersection into flash for an extended amount of time, a minimum of two stop signs per approach shall be erected. The cost of providing these stop signs shall be included in the bid price for the contract.

EQUIPMENT RENTAL RATES (BDE)

Effective: August 2, 2007

Revised: January 2, 2008

Replace the second and third paragraphs of Article 105.07(b)(4)a. of the Standard Specifications with the following:

"Equipment idled which cannot be used on other work, and which is authorized to standby on the project site by the Engineer, will be paid for according to Article 109.04(b)(4)."

Replace Article 109.04(b)(4) of the Standard Specifications with the following:

“(4) Equipment. Equipment used for extra work shall be authorized by the Engineer. The equipment shall be specifically described, be of suitable size and capacity for the work to be performed, and be in good operating condition. For such equipment, the Contractor will be paid as follows.

- a. Contractor Owned Equipment. Contractor owned equipment will be paid for by the hour using the applicable FHWA hourly rate from the “Equipment Watch Rental Rate Blue Book” (Blue Book) in effect when the force account work begins. The FHWA hourly rate is calculated as follows.

$$\text{FHWA hourly rate} = (\text{monthly rate}/176) \times (\text{model year adj.}) \times (\text{Illinois adj.}) + \text{EOC}$$

Where: EOC = Estimated Operating Costs per hour (from the Blue Book)

The time allowed will be the actual time the equipment is operating on the extra work. For the time required to move the equipment to and from the site of the extra work and any authorized idle (standby) time, payment will be made at the following hourly rate: $0.5 \times (\text{FHWA hourly rate} - \text{EOC})$.

All time allowed shall fall within the working hours authorized for the extra work.

The rates above include the cost of fuel, oil, lubrication, supplies, small tools, necessary attachments, repairs, overhaul and maintenance of any kind, depreciation, storage, overhead, profits, insurance, and all incidentals. The rates do not include labor.

The Contractor shall submit to the Engineer sufficient information for each piece of equipment and its attachments to enable the Engineer to determine the proper equipment category. If a rate is not established in the Blue Book for a particular piece of equipment, the Engineer will establish a rate for that piece of equipment that is consistent with its cost and use in the industry.

- b. Rented Equipment. Whenever it is necessary for the Contractor to rent equipment to perform extra work, the rental and transportation costs of the equipment plus five percent for overhead will be paid. In no case shall the rental rates exceed those of established distributors or equipment rental agencies.

All prices shall be agreed to in writing before the equipment is used.”

PAYMENTS TO SUBCONTRACTORS (BDE)

Effective: June 1, 2000

Revised: January 1, 2006

Federal regulations found at 49 CFR §26.29 mandate the Department to establish a contract clause to require Contractors to pay subcontractors for satisfactory performance of their subcontracts and to set the time for such payments.

State law also addresses the timing of payments to be made to subcontractors and material suppliers. Section 7 of the Prompt Payment Act, 30 ILCS 540/7, requires that when a Contractor receives any payment from the Department, the Contractor shall make corresponding, proportional payments to each subcontractor and material supplier performing work or supplying material within 15 calendar days after receipt of the Department payment. Section 7 of the Act further provides that interest in the amount of two percent per month, in addition to the payment due, shall be paid to any subcontractor or material supplier by the Contractor if the payment required by the Act is withheld or delayed without reasonable cause. The Act also provides that the time for payment required and the calculation of any interest due applies to transactions between subcontractors and lower-tier subcontractors and material suppliers throughout the contracting chain.

This Special Provision establishes the required federal contract clause, and adopts the 15 calendar day requirement of the State Prompt Payment Act for purposes of compliance with the federal regulation regarding payments to subcontractors. This contract is subject to the following payment obligations.

When progress payments are made to the Contractor according to Article 109.07 of the Standard Specifications, the Contractor shall make a corresponding payment to each subcontractor and material supplier in proportion to the work satisfactorily completed by each subcontractor and for the material supplied to perform any work of the contract. The proportionate amount of partial payment due to each subcontractor and material supplier throughout the contracting chain shall be determined by the quantities measured or otherwise determined as eligible for payment by the Department and included in the progress payment to the Contractor. Subcontractors and material suppliers shall be paid by the Contractor within 15 calendar days after the receipt of payment from the Department. The Contractor shall not hold retainage from the subcontractors. These obligations shall also apply to any payments made by subcontractors and material suppliers to their subcontractors and material suppliers; and to all payments made to lower tier subcontractors and material suppliers throughout the contracting chain. Any payment or portion of a payment subject to this provision may only be withheld from the subcontractor or material supplier to whom it is due for reasonable cause.

This Special Provision does not create any rights in favor of any subcontractor or material supplier against the State or authorize any cause of action against the State on account of any payment, nonpayment, delayed payment, or interest claimed by application of the State Prompt Payment Act. The Department will not approve any delay or postponement of the 15 day requirement except for reasonable cause shown after notice and hearing pursuant to Section 7(b) of the State Prompt Payment Act. State law creates other and additional remedies available to any subcontractor or material supplier, regardless of tier, who has not been paid for work properly performed or material furnished. These remedies are a lien against public funds set forth in Section 23(c) of the Mechanics Lien Act, 770 ILCS 60/23(c), and a recovery on the Contractor's payment bond according to the Public Construction Bond Act, 30 ILCS 550.

REFLECTIVE SHEETING ON CHANNELIZING DEVICES (BDE)

Effective: April 1, 2007

Revise the seventh paragraph of Article 1106.02 of the Standard Specifications to read:

“At the time of manufacturing, the retroreflective prismatic sheeting used on channelizing devices shall meet or exceed the initial minimum coefficient of retroreflection as specified in the following table. Measurements shall be conducted according to ASTM E 810, without averaging. Sheeting used on cones, drums and flexible delineators shall be reboundable as tested according to ASTM D 4956. Prestriped sheeting for rigid substrates on barricades shall be white and orange.

Initial Minimum Coefficient of Retroreflection candelas/foot candle/sq ft (candelas/lux/sq m) of material				
Observation Angle (deg.)	Entrance Angle (deg.)	White	Orange	Fluorescent Orange
0.2	-4	365	160	150
0.2	+30	175	80	70
0.5	-4	245	100	95
0.5	+30	100	50	40”

Revise the first sentence of the first paragraph of Article 1106.02(c) of the Standard Specifications to read:

“Barricades and vertical panels shall have alternating white and orange stripes sloping downward at 45 degrees toward the side on which traffic will pass.”

Revise the third sentence of the first paragraph of Article 1106.02(d) of the Standard Specifications to read:

“The bottom panels shall be 8 x 24 in. (200 x 600 mm) with alternating white and orange stripes sloping downward at 45 degrees toward the side on which traffic will pass.”

SUBCONTRACTOR MOBILIZATION PAYMENTS (BDE)

Effective: April 2, 2005

To account for the preparatory work and operations necessary for the movement of subcontractor personnel, equipment, supplies, and incidentals to the project site and for all other work or operations that must be performed or costs incurred when beginning work approved for subcontracting in accordance with Article 108.01 of the Standard Specifications, the Contractor shall make a mobilization payment to each subcontractor.

This mobilization payment shall be made at least 14 days prior to the subcontractor starting work. The amount paid shall be equal to 3 percent of the amount of the subcontract reported on form BC 260A submitted for the approval of the subcontractor’s work.

This provision shall be incorporated directly or by reference into each subcontract approved by the Department.

TRAFFIC SIGNAL GROUNDING (BDE)

Effective: April 1, 2006

Revised: January 1, 2007

Revise Article 873.02 of the Standard Specifications to read:

“873.02 Materials. Materials shall be according to the following.

Item	Article/Section
(a) Electric Cable – Signal, Lead-in, Communication, Service, and Equipment Grounding Conductor	1076.04
(b) Electrical Raceway Materials	1088.01”

Revise Article 873.04 of the Standard Specifications to read:

“873.04 Grounding System. All traffic signal circuits shall include an equipment grounding conductor according to Article 801.04. The equipment grounding conductor shall consist of a continuous, green, insulated conductor Type XLP, No. 6 AWG, stranded copper installed in raceways and bonded to each metal enclosure (handhole, post, mast arm pole, signal cabinet, etc.). All clamps shall be bronze or copper, UL approved.

A grounding cable with connectors shall be installed between each handhole cover and frame. The grounding cable shall be looped over cable hooks installed in the handholes and 5 ft (1.5 m) of extra cable shall be provided between the frame and cover.

All equipment grounding conductors shall terminate at the ground bus in the controller cabinet. The neutral conductor and the equipment grounding conductor shall be connected in the service installation. At no other point in the traffic signal system shall the neutral and equipment grounding conductors be connected.”

Revise Article 873.05 of the Standard Specifications to read:

“873.05 Method of Measurement. Electric cable will be measured for payment in feet (meters) in place. The length of measurement shall be the distance horizontally and vertically measured between the changes in direction, including cables in mast arms, mast arm poles, signal posts, and extra cable length as specified in Article 873.03. The vertical cable length shall be measured according to the following schedule.

Location	Cable Length
Foundation (signal post, mast arm pole, controller cabinet)	3 ft (1 m)
Mast Arm Pole (mast arm mounted signal head)	20 ft (6 m)
Mast Arm Pole (bracket mounted signal head attached to mast arm pole)	13 ft (4 m)
Signal Post (bracket or post mounted signal head)	13 ft (4 m)
Pedestrian Push Button	6 ft (2 m)”

Add the following Article to Section 873 of the Standard Specifications:

“873.06 Basis of Payment. This work will be paid for at the contract unit price per foot (meter) for ELECTRIC CABLE, of the method of installation (IN TRENCH, IN CONDUIT, or AERIAL SUSPENDED), of the type, size, and number of conductors specified.

The type specified will indicate the method of installation and whether the electric cable is Service, Signal, Lead-in, Communication, or Equipment Grounding Conductor.”

Revise the heading of Article 1076.04 of the Standard Specifications to read:

“1076.04 Electric Cable – Signal, Lead-in, Communication, Service, and Equipment Grounding Conductor.”

Add the following paragraph to the end of Article 1076.04 of the Standard Specifications:

“(e) Equipment Grounding Conductor. The cross linked polyethylene (XLP) insulated conductor shall be according to Articles 1066.02 and 1066.03. The stranded copper conductor shall be No. 6 AWG and the insulation color shall be green.”

WORKING DAYS (BDE)

Effective: January 1, 2002

The Contractor shall complete the work within 15 working days.

INDEX OF SHEETS

1. COVER SHEET
2. COMMITMENTS AND NOTES
3. SUMMARY OF QUANTITIES
4. SCHEDULE OF QUANTITIES
5. TRAFFIC CONTROL DETAIL
6. PROP. SIGNAL DETAILS
7. US 34 & CARMAN RD.
8. PROP. CABLE DIAGRAM
9. US 34 & CARMAN RD.
10. PROP. SIGNAL DETAILS
11. US 34 & US 67
12. PROP. SIGNAL DETAILS
13. US 34 & 11TH
14. BATTERY BACKUP SYSTEM
15. CABINET DETAIL
16. BATTERY BACKUP SYSTEM
17. CABINET WIRING DIAGRAM
18. BATTERY BACKUP SYSTEM
19. BLOCK DIAGRAM
20. BATTERY BACKUP SYSTEM
21. BYPASS SWITCH DIAGRAM

STATE OF ILLINOIS
DEPARTMENT OF TRANSPORTATION
DIVISION OF HIGHWAYS
FAP 313 (US 34)
FAP 310 (US 67)
SECTION D4 MISC. SIGNAL WORK 2008-4
HENDERSON-WARREN COUNTIES
C-94-020-08

SHEET 1 OF 13
 D-94-019-08

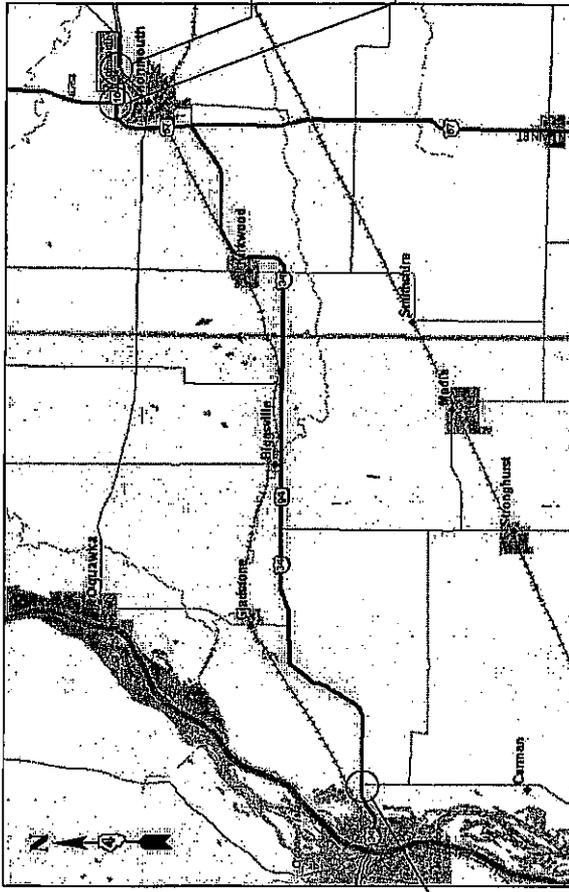

US 34 & 11TH ST.
 (MONMOUTH)

US 34 & US 67
 (MONMOUTH)

US 34 & CARMAN RD.
 (HENDERSON COUNTY)

STANDARDS

701001-01	701701-05
701006-02	702001
701101-01	873001-01
701426-02	886001
701301-02	886006

701421-01

LOCATION OF IMPROVEMENT

INTERSECTION OF US 34 & CARMAN RD. IN HENDERSON COUNTY;
 INTERSECTIONS OF US 34 & US 67 AND US 34 & 11TH ST. IN THE CITY OF MONMOUTH IN WARREN COUNTY.

CONTRACT NO. 68781
 CATALOG NO. 033713-000

DESCRIPTION OF WORK

THIS PROJECT CONSISTS OF INSTALLING DETECTOR LOOPS, DETECTOR LOOP LEAD-IN CABLE, BATTERY BACKUP SYSTEMS, INDUCTIVE LOOP DETECTORS, GROUNDING EXISTING TRAFFIC SIGNAL INSTALLATIONS, AND ALL OTHER WORK REQUIRED TO COMPLETE THE IMPROVEMENTS.

JULI.E. 1-800-892-0123
 JOINT UTILITY LOCATION INFORMATION FOR EXCAVATION

STATE OF ILLINOIS
DEPARTMENT OF TRANSPORTATION
DIVISION OF HIGHWAYS
 SUBMITTED October 26, 2007
J.E. Coane wsl
 DEPUTY DIRECTOR OF HIGHWAYS REGION ENGINEER

PRINTED BY THE AUTHORITY
 OF THE STATE OF ILLINOIS

COMMITMENTS

NO COMMITMENTS WERE MADE IN CONJUNCTION WITH THIS PROJECT.

ROUTE		SECTION	COUNTY	SHEET	
MKD.	DESIG.			HENDERSON	TOTAL
US 34	FAP 313	D4 MISC SIGNAL WORK 2008-4	HENDERSON	13	2
US 67	FAP 310		WARREN		

CONSTRUCTION NOTES

THE EXISTING TRAFFIC SIGNALS SHALL REMAIN IN OPERATION DURING THE INSTALLATION OF THE PROPOSED TRAFFIC SIGNALS.

ANY MAINTENANCE OF EXISTING TRAFFIC SIGNALS SHALL BE CONSIDERED EXTRA WORK IN ACCORDANCE WITH ARTICLE 109.04 OF THE STANDARD SPECIFICATIONS.

THE LOCATION OF ALL UTILITIES AND PRIVATELY OWNED FACILITIES SHALL BE FIELD VERIFIED BY THE CONTRACTOR PRIOR TO THE INSTALLATION OF ANY COMPONENTS.

THE CONTRACTOR SHALL BE RESPONSIBLE FOR LOCATING ALL EXISTING AND PROPOSED STATE OWNED TRAFFIC SIGNAL AND LIGHTING FACILITIES.

ELECTRICAL WORK SHALL CONFORM WITH NATIONAL, STATE, AND LOCAL CODES.

ALL PROPOSED AND EXISTING TRAFFIC SIGNAL MAST ARMS, POSTS, HANDHOLES (LIDS, RINGS, FRAMES), CONTROLLER CABINETS, PHOTOCELL RELAYS, AND METALLIC CONDUITS SHALL BE GROUNDED IN ACCORDANCE WITH NEC REQUIREMENTS. THIS WORK WILL BE PAID FOR AS ELECTRIC CABLE IN CONDUIT, GROUNDING, NO. 6, 1/C.

ALL SURPLUS MATERIALS SHALL BE DISPOSED OF IN ACCORDANCE WITH ARTICLE 202.03 OF THE STANDARD SPECIFICATIONS.

THE CABINET FAN, SERVICE RECEPTACLE, HEATER STRIP, AND CABINET LIGHTS SHALL BE EXCLUDED FROM THE BATTERY BACKUP SYSTEM OPERATION.

THE CONTRACTOR SHALL FURNISH A WARRANTY CERTIFICATE FOR EACH BATTERY BACKUP THAT INCLUDES THE EQUIPMENT DESCRIPTION AND DETAILS, SERIAL NUMBERS, EFFECTIVE DATES, AND THE DETAILS OF THE MATERIAL WARRANTY FOR EACH WARRANTY ITEM.

THE PROPOSED DETECTOR LOOPS SHALL BE CUT IN THE EXISTING PAVEMENT.

THE #18 3-PAIR TWISTED/SHIELDED CABLE SHALL HAVE THE SAME SLACK AS OTHER SIGNAL CABLE AND WILL BE MEASURED FOR PAYMENT.

EACH DETECTOR LOOP SHALL UTILIZE A SEPARATE PAIR OF LEAD-INS.

A TYPE II SPLICE SHALL BE USED FOR ALL DETECTOR LEAD-INS.

LEAD-IN CABLE SHALL BE CONTINUOUS FROM THE TYPE II SPLICE LOCATED IN THE CONCRETE HANDHOLE TO THE CONTROLLER CABINET. NO SPLICES WILL BE ALLOWED.

ALL DETECTOR LOOPS SHALL BE INSTALLED IN THE CENTER OF THEIR RESPECTIVE TRAVEL LANES. THE ENGINEER OF TRAFFIC SHALL BE NOTIFIED FOR VERIFICATION OF DETECTOR PLACEMENT BEFORE INSTALLATION.

THE CONTRACTOR SHALL LOCATE AND REMOVE ALL DEBRIS FROM THE EXISTING DETECTOR LOOP LEAD-IN CONDUITS AND HANDHOLES. THIS WORK SHALL BE INCLUDED IN THE BID PRICE FOR DETECTOR LOOP, TYPE II.

AFTER REMOVAL OF THE VIDEO DETECTION CAMERAS, THE CONTRACTOR SHALL COVER ALL HOLES IN THE MAST ARM USING AN APPLICABLE ASSEMBLY (WITH SEALANT AND STAINLESS OR GALVANIZED STEEL COVER PLATES) TO THE SATISFACTION OF THE ENGINEER. ALL COVERED HOLES SHALL BE SEALED WATER TIGHT AND AIR TIGHT. THIS WORK SHALL BE INCLUDED IN THE BID PRICE FOR REMOVE EXISTING TRAFFIC SIGNAL EQUIPMENT, SPECIAL.

COMMITMENTS AND NOTES

ROUTE		SECTION		COUNTY		SHEET	
MKD.	DESIG.	D4 MISC SIGNAL WORK 2008-4		HENDERSON		TOTAL	
US 34	FAP 313			WARREN		13	
US 67	FAP 310					3	

SUMMARY OF QUANTITIES		HENDERSON CTY.		WARREN CTY.		
		CONST. TYPE CODE	CONST. TYPE CODE	CONST. TYPE CODE	CONST. TYPE CODE	
CODE NUMBER	ITEM DESCRIPTION	UNIT	TOTAL QTY	Y031-1F 1 00% STATE 0% CITY RURAL US 34 & CARMAN	Y031-1 F 1 00% STATE 0% CITY URBAN (US 34 & US 67)	Y031-1 F 90% STATE 10% CITY URBAN (US 34 & 11TH)
67100100	MOBILIZATION	L-SUM	1.0	0.6	0.2	0.2
70100310	TRAFFIC CONTROL AND PROTECTION, STANDARD 701421	L-SUM	1.0	1.0		
70102635	TRAFFIC CONTROL AND PROTECTION, STANDARD 701701	L-SUM	1.0	0.6	0.2	0.2
87301515	ELECTRIC CABLE IN CONDUIT, LEAD-IN, NO. 18 3 PAIR	FOOT	978.0	978.0		
88500100	INDUCTIVE LOOP DETECTOR	EACH	7.0	7.0		
88600100	DETECTOR LOOP, TYPE I	FOOT	1138.0	1138.0		
X0324134	BATTERY BACKUP SYSTEM WITH CABINET	EACH	3.0	1.0	1.0	1.0
X8730027	ELECTRIC CABLE IN CONDUIT, GROUNDING, NO. 6 1C	FOOT	824.0	234.0	227.5	362.5
XX005703	REMOVE EXISTING TRAFFIC SIGNAL EQUIPMENT, SPECIAL	L-SUM	1.0	1.0		

SUMMARY OF QUANTITIES	
-----------------------	--

ROUTE		SECTION	COUNTY	SHEET
MKD.	DESIG.	D4 MISC SIGNAL	HENDERSON	TOTAL
US 34	FAP 313	WORK 2008-4	WARREN	13
US 67	FAP 310			4

ROUTE		SECTION	COUNTY	SHEET
MKD.	DESIG.	D4 MISC SIGNAL	HENDERSON	TOTAL
US 34	FAP 313	WORK 2008-4	WARREN	13
US 67	FAP 310			4
SCHEDULE OF QUANTITIES				
ITEM DESCRIPTION	UNIT	TOTAL QTY	HENDERSON CTY.	WARREN CTY.
MOBILIZATION	L SUM	1.0	US 34 & CARMAN TRAFFIC SIGNALS	US 34 & 11TH TRAFFIC SIGNALS
TRAFFIC CONTROL AND PROTECTION, STANDARD 701421	L SUM	1.0	0.6	0.2
TRAFFIC CONTROL AND PROTECTION, STANDARD 701701	L SUM	1.0	0.6	0.2
ELECTRIC CABLE IN CONDUIT, LEAD-IN, NO. 18 3 PAIR	FOOT	978.0	978.0	
INDUCTIVE LOOP DETECTOR	EACH	7.0	7.0	
DETECTOR LOOP, TYPE J	FOOT	1138.0	1138.0	
BATTERY BACKUP SYSTEM WITH CABINET	EACH	3.0	1.0	1.0
ELECTRIC CABLE IN CONDUIT, GROUNDING, NO. 6 1C	FOOT	824.0	234.0	227.5
REMOVE EXISTING TRAFFIC SIGNAL EQUIPMENT, SPECIAL	L SUM	1.0	1.0	
			234.0	362.5

SCHEDULE OF QUANTITIES

ROUTE		SECTION	COUNTY	SHEET
MKD.	DESIG.	D4 MISC SIGNAL WORK 2008-4	HENDERSON WARREN	TOTAL
US 34	FAP 313			13
US 67	FAP 310			5

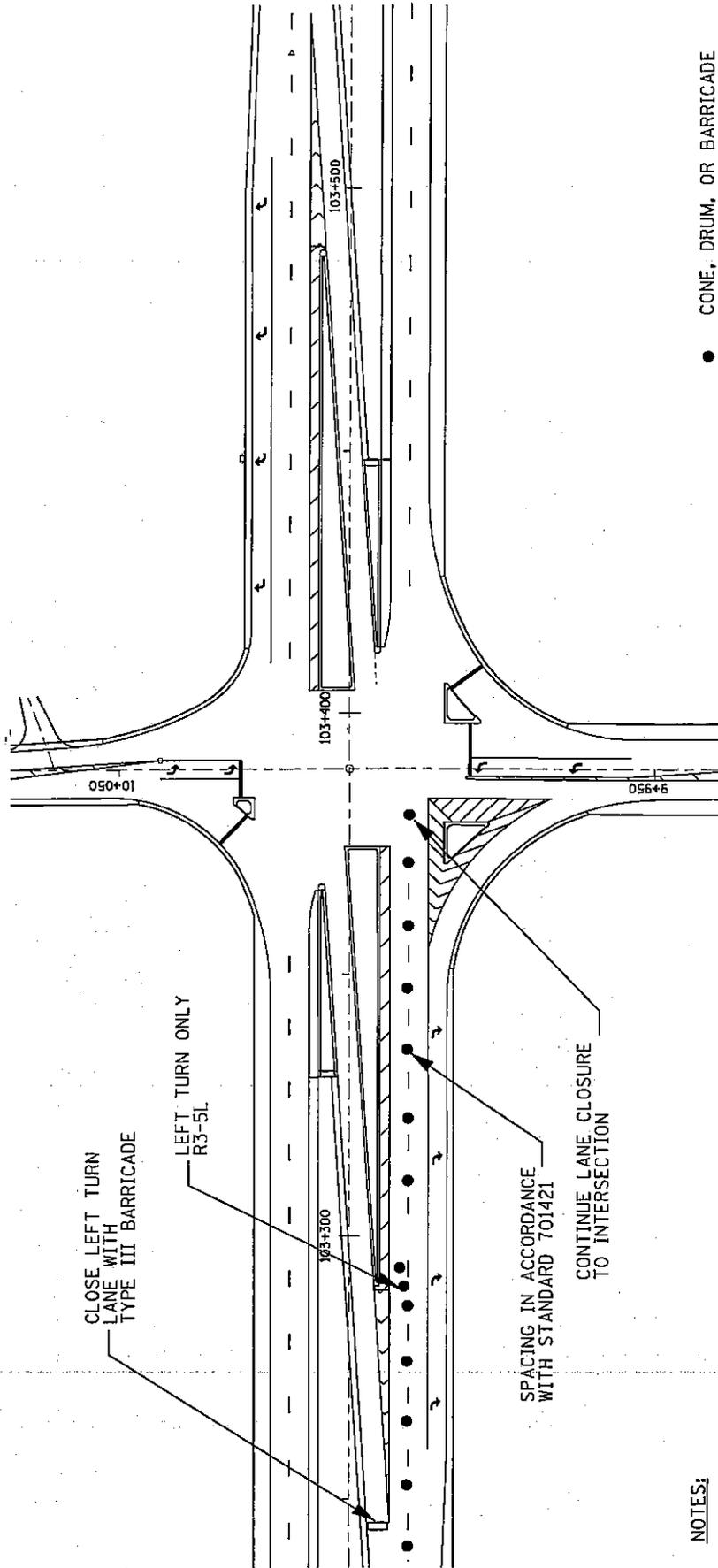

NOTES:

1. LANE CLOSURE PER TRAFFIC CONTROL AND PROTECTION STANDARD 701421.
2. TYPICAL BURIED LEFT TURN LANE CLOSURE SHOWN. ONLY ONE LEFT LANE SHALL BE CLOSED AT A TIME.
3. ALL LABOR, EQUIPMENT, AND MATERIALS REQUIRED TO COMPLY WITH THESE REQUIREMENTS SHALL BE INCLUDED IN THE BID PRICE FOR TRAFFIC CONTROL AND PROTECTION, STANDARD 701421.

● CONE, DRUM, OR BARRICADE

TRAFFIC CONTROL DETAIL
US 34 & CARMAN RD.
HENDERSON COUNTY

ROUTE		SECTION	COUNTY	SHEET
MKD.	DESIG.	D4 MISC SIGNAL WORK 2008-4	HENDERSON WARREN	TOTAL NO.
US 34	FAP 313			13
US 67	FAP 310			6

ITEM DESCRIPTION	UNIT	QUANTITY
ELECTRIC CABLE IN CONDUIT, GROUNDING, NO. 6 1C	FOOT	362.5
BATTERY BACKUP SYSTEM WITH CABINET	EACH	1

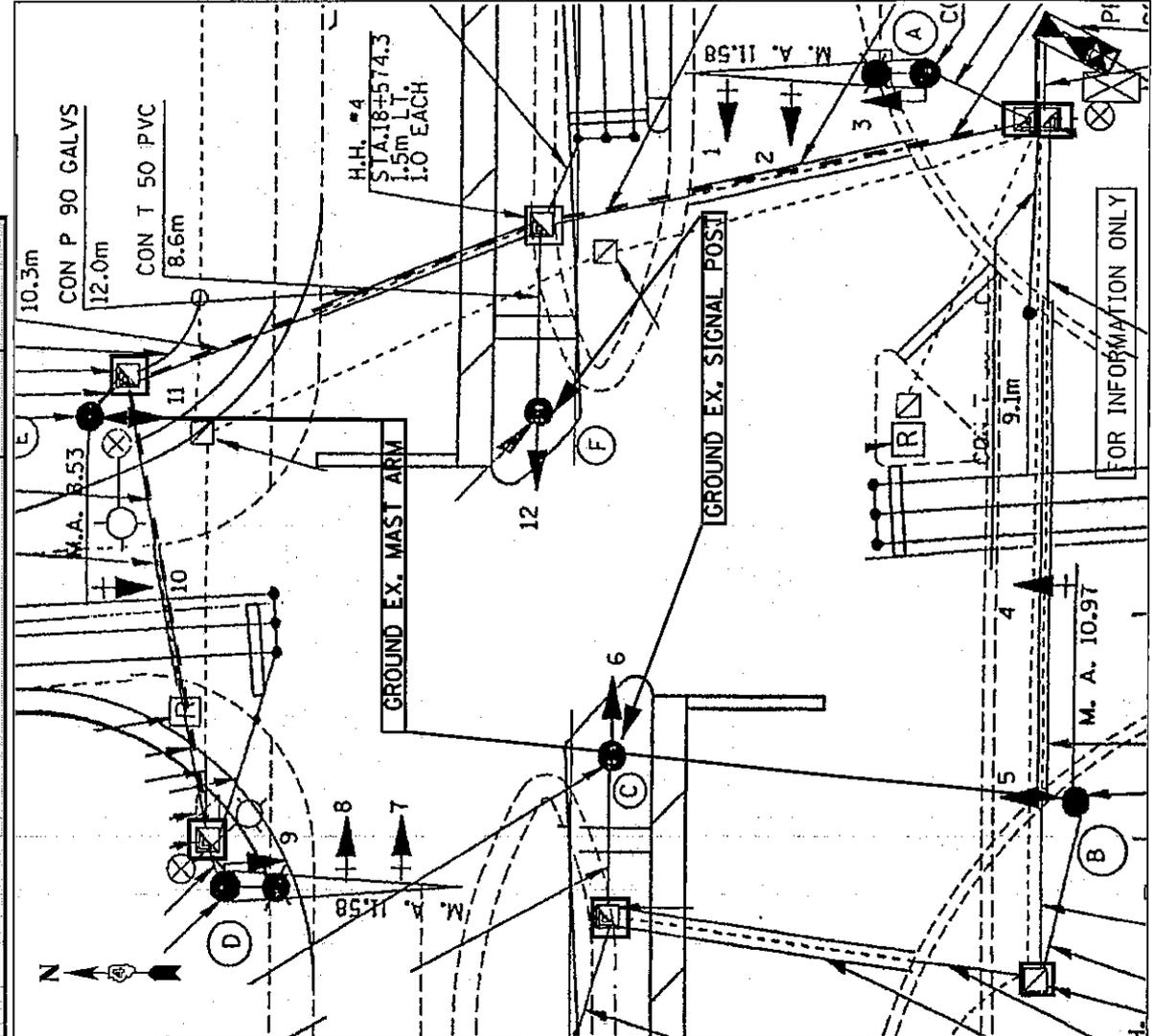

LEGEND:

- - EX. SYSTEM GROUND
- EX. HANDHOLE TO BE GROUNDED

NOT TO SCALE

US 34 & 11TH ST.
TRAFFIC SIGNALS
MONMOUTH
WARREN COUNTY

ROUTE		SECTION		COUNTY		SHEET	
MKD.	DESIG.	D4 MISC SIGNAL WORK 2008-4		HENDERSON	TOTAL	NO.	
US 34	FAP 313			WARREN	13	7	
US 67	FAP 310						

ITEM DESCRIPTION	UNIT	QUANTITY
ELECTRIC CABLE IN CONDUIT, GROUNDING, NO. 6 1C	FOOT	227.5
BATTERY BACKUP SYSTEM WITH CABINET	EACH	1

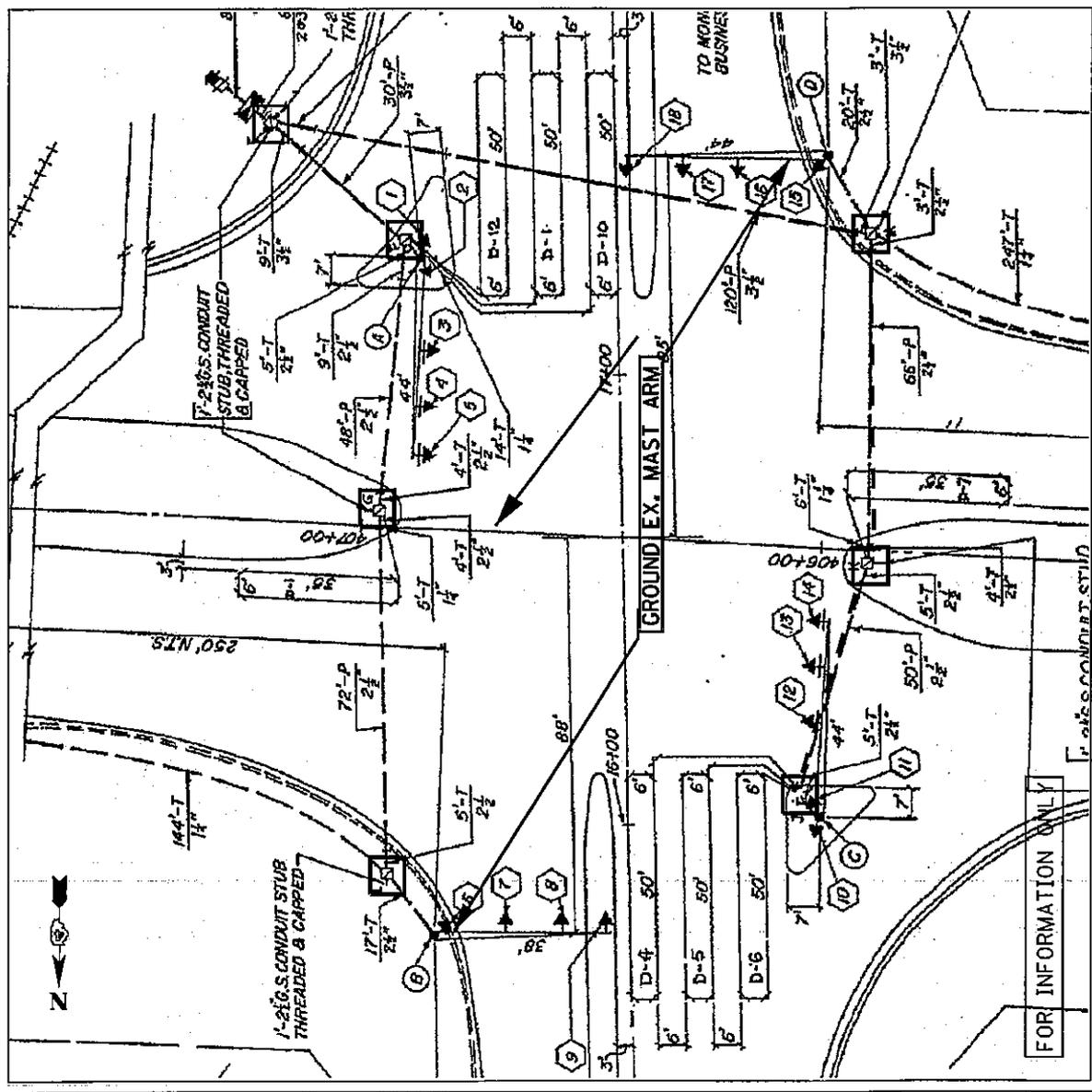

LEGEND

- - EX. SYSTEM GROUND
- EX. HANDHOLE TO BE GROUNDED

NOT TO SCALE

US 34 & US 67
TRAFFIC SIGNALS
MONMOUTH
WARREN COUNTY

FOR INFORMATION ONLY

ROUTE		SECTION	COUNTY	SHEET
MKD.	DESIG.	D4 MISC SIGNAL WORK 2008-4	HENDERSON	TOTAL
US 34	FAP 313		WARREN	13
US 67	FAP 310			8

ITEM DESCRIPTION	UNIT	QUANTITY
ELECTRIC CABLE IN CONDUIT, LEAD-IN, NO. 18-3 PAIR	FOOT	978
INDUCTIVE LOOP DETECTOR	EACH	7
DETECTOR LOOP, TYPE I	FOOT	1138
BATTERY BACKUP SYSTEM WITH CABINET	EACH	1
ELECTRIC CABLE IN CONDUIT, GROUNDING, NO. 6-1C	FOOT	234
REMOVE EXISTING TRAFFIC SIGNAL EQUIPMENT, SPECIAL	L SUM	1

REMOVE EXISTING TRAFFIC SIGNAL EQUIPMENT SPECIAL - 1.0 LSUM
(INCLUDES ALL ITEMS LISTED BELOW)

- THE FOLLOWING TRAFFIC SIGNAL EQUIPMENT SHALL BE REMOVED AND DELIVERED BY THE CONTRACTOR TO THE IDOT TRAFFIC BUILDING, 1025 W. DETWEILLER DR., PEORIA, IL. THE POINT OF CONTACT IS PAUL GRANT AT (309) 671-4474.
 - 4 EACH VIDEO DETECTION CAMERAS (AND SYSTEM) COMPLETE
1 EACH BATTERY BACKUP SYSTEM COMPLETE (LOCATED IN EX. CABINET)
 - THE FOLLOWING ITEMS SHALL BE REMOVED AND DISPOSED OF BY THE CONTRACTOR OFF THE RIGHT-OF-WAY. THE SALVAGE VALUE OF THIS EQUIPMENT SHALL BE REFLECTED IN THE UNIT BID PRICE FOR REMOVE EXISTING TRAFFIC SIGNAL EQUIPMENT.
- BATTERIES (FROM BATTERY BACKUP SYSTEM)
ALL ELECTRICAL CABLE (USED FOR VIDEO DETECTION SYSTEM)

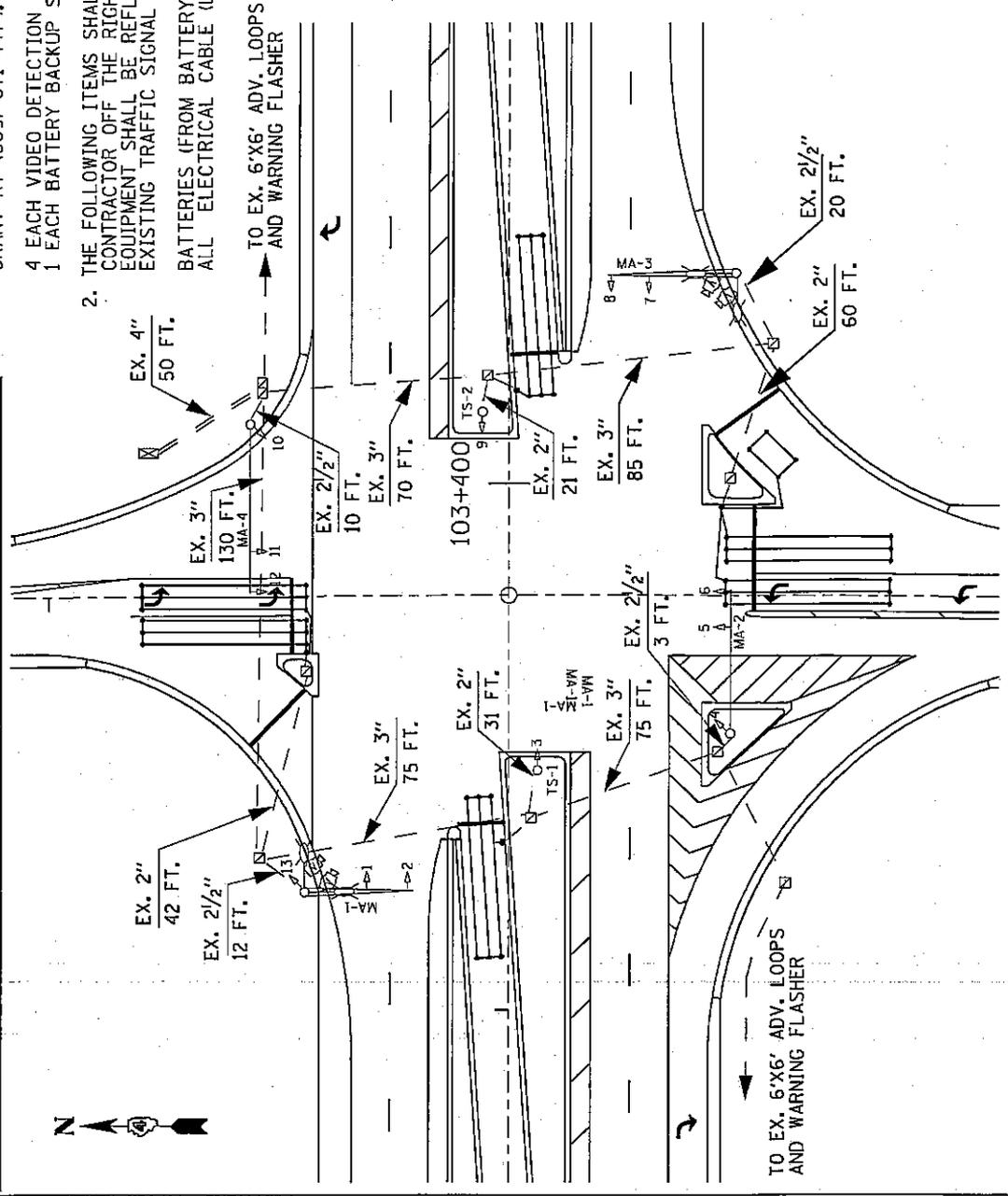

TRAFFIC SIGNAL LEGEND

- EX. HANDHOLE
- EX. TRAFFIC SIGNAL POST
- EX. CONDUIT
- EX. SIGNAL CONTROLLER
- EX. TRAFFIC SIGNAL HEAD
- EX. TRAFFIC SIGNAL HEAD W/ BACKPLATE
- EX. LUMINAIRE
- EX. STL COMB MAST ARM ASSEMBLY
- EX. STL MAST ARM ASSEMBLY AND POLE
- PROP. DETECTOR LOOP (6' X 50' QUAD)
- PROP. DETECTOR LOOP (6' X 20')

NOT TO SCALE

US 34 & CARMAN RD.
TRAFFIC SIGNALS
GULFPORT
HENDERSON COUNTY

ALL MAST ARMS, CONTROLLER CABINETS, AND EXISTING HANDHOLES (EXCEPT ADVANCED LOOP HANDHOLES) ARE TO BE GROUNDED IN ACCORDANCE WITH NEC REQUIREMENTS. THIS WORK WILL BE PAID FOR AS "ELECTRIC CABLE IN CONDUIT, #6, 1/C, GROUNDING."

ROUTE		SECTION		COUNTY		SHEET	
MKD.	DESIG.	D4 MISC SIGNAL WORK 2008-4	HENDERSON	WARREN	TOTAL	NO.	
US 34	FAP 313				13	9	
US 67	FAP 310						

EXISTING PHASE DIAGRAM

NAME OF INTERSECTION: US 34 & CARMAN RD.
 EXISTING CONTROLLER: FULL ACTUATED CONTROLLER
 TYPE IV CABINET TS-2 BACKPANEL AND FACILITIES

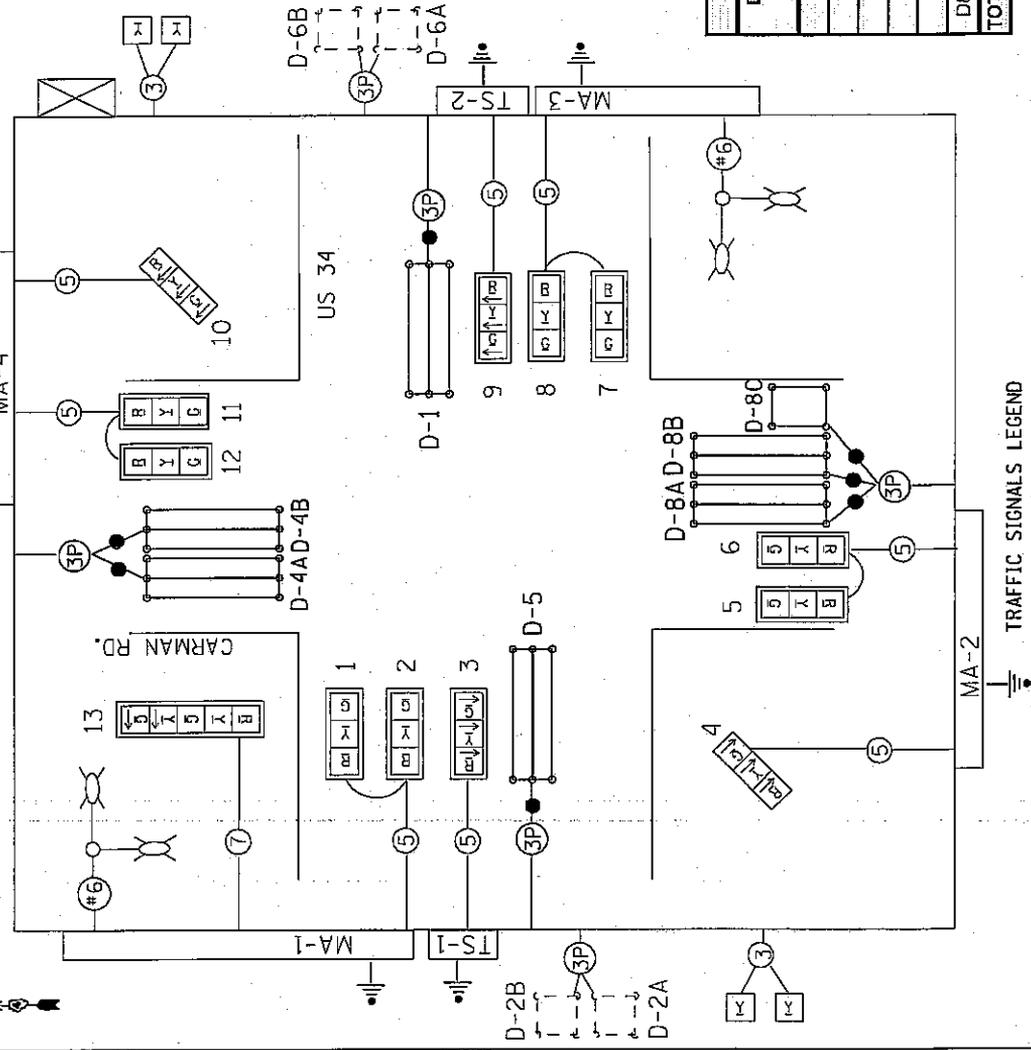
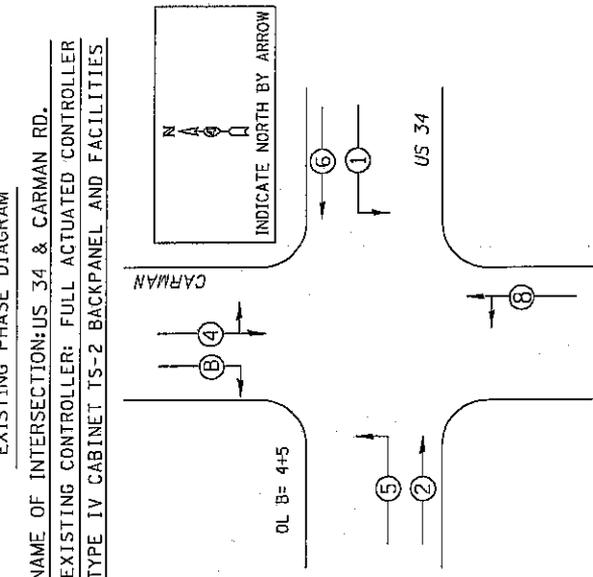

- TRAFFIC SIGNALS LEGEND
- EX. DETECTOR LOOP (6'x6')
 - EX. 3 SEC. SIGNAL HEAD W/BACKPLATE
 - 5/C NO. 14 SIGNAL CABLE
 - 3/C NO. 12 SIGNAL CABLE
 - EX. #18 3-PR DETECTOR LOOP CABLE
 - EX. CONTROLLER (SIGNAL)
 - PROP. DETECTOR LOOP (6'x50')
 - PROP. SYSTEM GROUND (#6 1/C)
 - PROP. TYPE II SPLICE
 - PROP. #18 3-PR DET LOOP CABLE

DETECTOR ASSIGNMENT SCHEDULE			
DETECTOR LOOP	ASSIGNED PHASE	NO. OF CHANNELS REQUIRED	LOOP STATUS
D1	1	1	PROP. 6'X50' QUAD
D2-A, D2-B	2		EX. 6'X6'
D4A, D4B	4	2	PROP. 6'X50' QUADS
D5	5	1	PROP. 6'X50' QUAD
D6-A, D6-B	6		EX. 6'X6'
D8A, D8B, D8C	8	3	PROP. 6'X50' QUADS, 6'X20'
TOTAL NUMBER OF CHANNELS REQUIRED:			7

CABLE AND PHASE DIAGRAMS
 US 34 & CARMAN RD.
 GULFPORT

ROUTE		SECTION	COUNTY	SHEET
MKD.	DESIG.	D4 MISC SIGNAL WORK 2008-4	HENDERSON WARREN	TOTAL 13
US 34	FAP 313			
US 67	FAP 310			

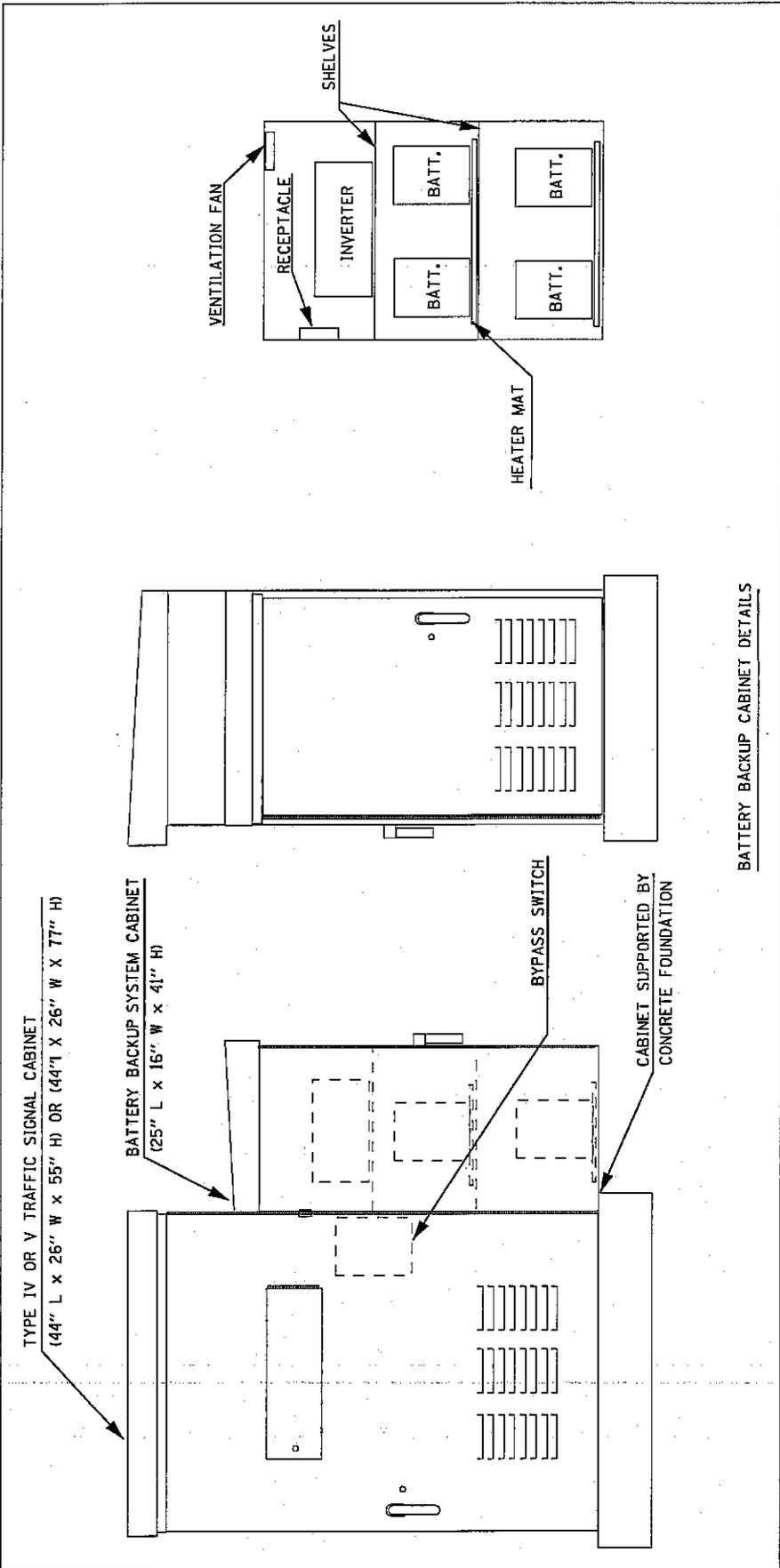

BATTERY BACKUP CABINET DETAILS

NOTES

1. THE BATTERY BACKUP SYSTEM CABINET SHALL BE A NEMA TYPE 3R CABINET WITH MINIMUM OUTSIDE DIMENSIONS OF 41" (H) X 25" (W) X 16" (D). THE CABINET SHALL BE EQUIPPED WITH A THREE POINT LATCHING MECHANISM, TWO SHELVES, THERMOSTATICALLY CONTROLLED VENTILATION FAN, AND A POWER RECEPTACLE. THE CABINET SHALL BE MOUNTED TO THE SIDE OF THE EXISTING TYPE IV CABINET WITH THE BOTTOM OF THE CABINET SUPPORTED BY THE CONCRETE FOUNDATION.
2. ALL CABINET LIGHTS, HEATER STRIPS, VENTILATION FANS, AND SERVICE RECEPTACLES SHALL BE BYPASSED WHEN THE BATTERY BACKUP UNIT IS OPERATING IN BATTERY MODE.
3. THE BATTERY BACKUP UNITS CONTACTS SHALL BE WIRED TO PROVIDE LOCAL CONTROLLER ALARMS (AS AVAILABLE IN THE EXISTING CABINETS).
4. THE BYPASS SWITCH SHALL BE INSTALLED IN THE TYPE IV CABINET.

BATTERY BACKUP SYSTEM
CABINET DETAILS

ROUTE		SECTION	COUNTY	SHEET
MKD.	DESIG.	D4 MISC SIGNAL	HENDERSON	TOTAL
US 34	FAP 313	WORK 2008-4	WARREN	13
US 67	FAP 310			11

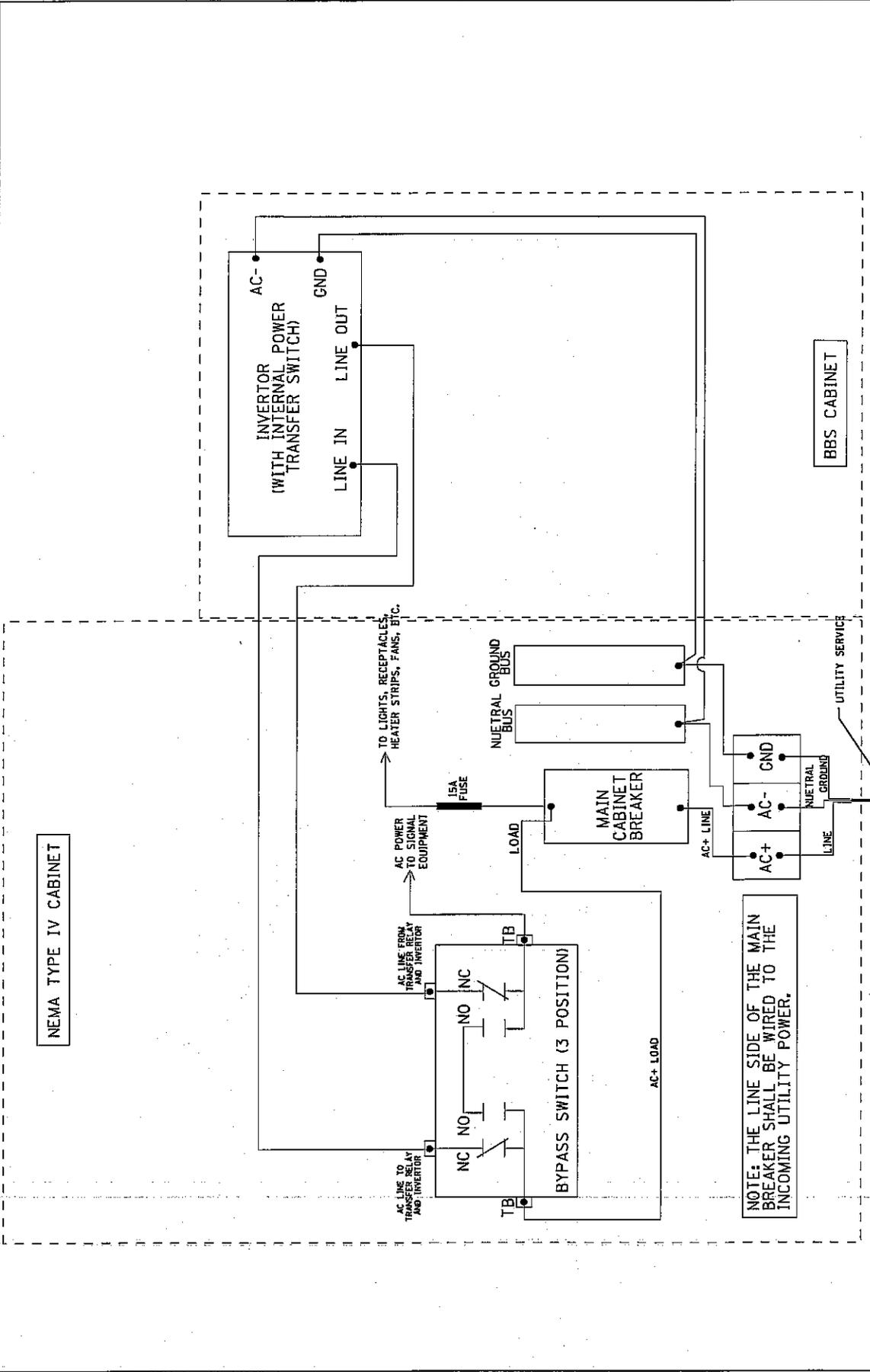

NEMA TYPE IV CABINET

BBS CABINET

NOTE: THE LINE SIDE OF THE MAIN BREAKER SHALL BE WIRED TO THE INCOMING UTILITY POWER.

BATTERY BACKUP SYSTEM
CABINET WIRING DIAGRAM

ROUTE		SECTION	COUNTY	SHEET
MKD.	DESIG.	D4 MISC SIGNAL WORK 2008-4	HENDERSON WARREN	TOTAL
US 34	FAP 313			13
US 67	FAP 310			12

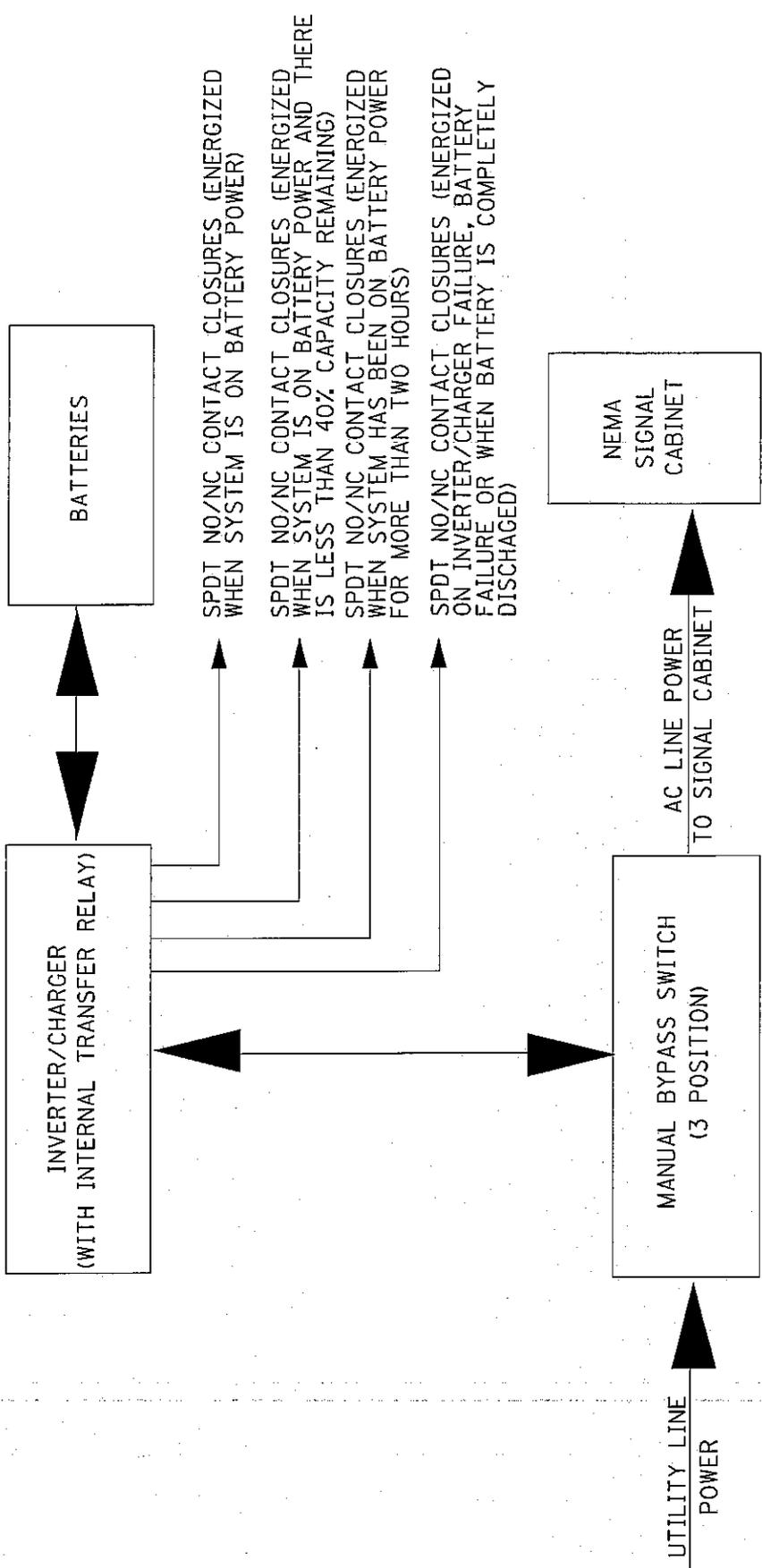

BATTERY BACKUP SYSTEM
BLOCK DIAGRAM

ROUTE		SECTION	COUNTY	SHEET
MKD.	DESIG.	D4 MISC SIGNAL WORK 2008-4	HENDERSON WARREN	TOTAL
US 34	FAP 313			13
US 67	FAP 310			13

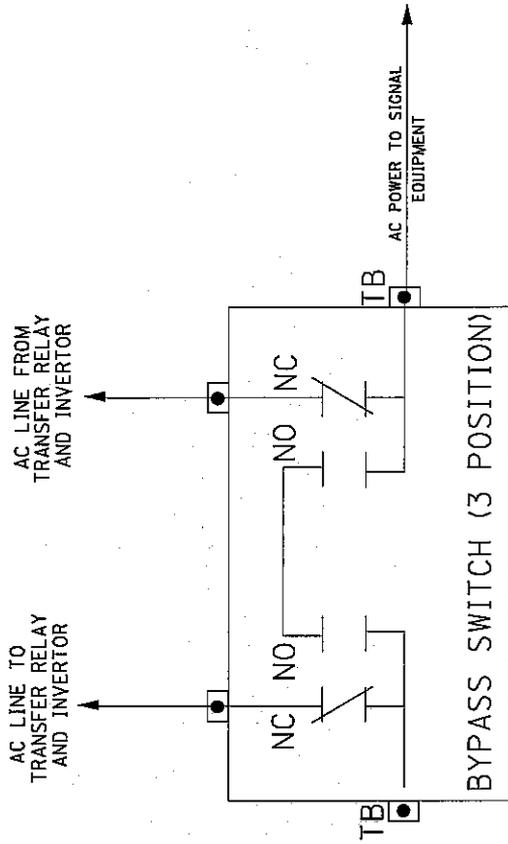

NOTES:

1. TB - #8 TERMINAL BLOCKS
2. NO - NORMALLY OPEN
3. NC - NORMALLY CLOSED
4. NO/NC CONTACTS SHALL ALL TOGGLE SIMULTANEOUSLY WITH A SINGLE MANUALLY OPERATED SWITCH.
5. THE MANUAL BYPASS SWITCH SHALL ONLY SWITCH LINE POWER. THE NEUTRAL AND EQUIPMENT GROUND SHALL NOT BE SWITCHED AND SHALL BE CONNECTED TO THE NEMA CABINET BUSES.

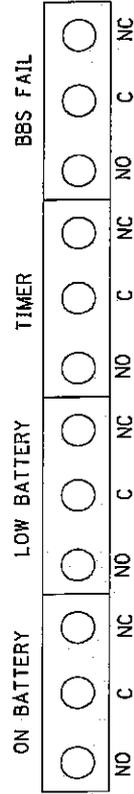

NO/NC CONTACTS MAY SHARE OR USE SEPARATE COMMONS.

BATTERY BACKUP SYSTEM
BYPASS SWITCH DIAGRAM

ILLINOIS DEPARTMENT OF LABOR
PREVAILING WAGES FOR
HENDERSON AND WARREN COUNTIES
EFFECTIVE DECEMBER 2007

The Prevailing rates of wages are included in the Contract proposals which are subject to Check Sheet #5 of the Supplemental Specifications and Recurring Special Provisions. The rates have been ascertained and certified by the Illinois Department of Labor for the locality in which the work is to be performed and for each craft or type of work or mechanic needed to execute the work of the Contract. As required by Prevailing Wage Act (820 ILCS 130/0.01, et seq.) and Check Sheet #5 of the Contract, not less than the rates of wages ascertained by the Illinois Department of Labor and as revised during the performance of a Contract shall be paid to all laborers, workers and mechanics performing work under the Contract. Post the scale of wages in a prominent and easily accessible place at the site of work.

If the Illinois Department of Labor revises the prevailing rates of wages to be paid as listed in the specification of rates, the contractor shall post the revised rates of wages and shall pay not less than the revised rates of wages. Current wage rate information shall be obtained by visiting the Illinois Department of Labor web site at <http://www.state.il.us/agency/idol/> or by calling 312-793-2814. It is the responsibility of the contractor to review the rates applicable to the work of the contract at regular intervals in order to insure the timely payment of current rates. Provision of this information to the contractor by means of the Illinois Department of Labor web site satisfies the notification of revisions by the Department to the contractor pursuant to the Act, and the contractor agrees that no additional notice is required. The contractor shall notify each of its subcontractors of the revised rates of wages.

Henderson County Prevailing Wage for December 2007

Trade Name	RG	TYP	C	Base	FRMAN	*M-F>8	OSA	OSH	H/W	Pensn	Vac	Trng
=====	==	==	=	=====	=====	=====	==	==	=====	=====	=====	=====
ASBESTOS ABT-GEN		BLD		24.040	24.790	1.5	1.5	2.0	6.540	6.900	0.000	0.600
ASBESTOS ABT-GEN		HWY		23.640	24.140	1.5	1.5	2.0	6.540	6.500	0.000	0.700
ASBESTOS ABT-MEC		BLD		18.750	19.750	1.5	1.5	2.0	4.750	2.000	0.000	0.000
BOILERMAKER		BLD		30.970	33.970	2.0	2.0	2.0	8.270	7.740	0.000	0.300
BRICK MASON		BLD		27.020	28.520	1.5	1.5	2.0	6.250	7.350	0.000	0.420
CARPENTER		BLD		25.750	27.040	1.5	1.5	2.0	5.700	5.360	0.000	0.400
CARPENTER		HWY		26.060	27.810	1.5	1.5	2.0	5.860	7.260	0.000	0.400
CEMENT MASON		BLD		22.800	23.800	1.5	1.5	2.0	5.200	8.080	0.000	0.150
CEMENT MASON		HWY		23.060	24.060	1.5	1.5	2.0	5.300	5.800	0.000	0.500
CERAMIC TILE FNSHER		BLD		24.910	0.000	1.5	1.5	2.0	6.250	7.350	0.000	0.420
ELECTRIC PWR EQMT OP		ALL		30.750	0.000	1.5	1.5	2.0	4.750	8.610	0.000	0.000
ELECTRIC PWR GRNDMAN		ALL		21.090	0.000	1.5	1.5	2.0	4.750	5.905	0.000	0.000
ELECTRIC PWR LINEMAN		ALL		34.160	36.350	1.5	1.5	2.0	4.750	9.560	0.000	0.000
ELECTRIC PWR TRK DRV		ALL		22.130	0.000	1.5	1.5	2.0	4.750	6.200	0.000	0.000
ELECTRICIAN		BLD		27.040	29.040	1.5	1.5	2.0	5.150	7.460	0.000	0.250
ELECTRONIC SYS TECH		BLD		24.830	26.330	1.5	1.5	2.0	5.150	6.145	0.000	0.250
ELEVATOR CONSTRUCTOR		BLD		34.190	38.460	2.0	2.0	2.0	8.275	6.060	2.050	0.000
GLAZIER		BLD		21.280	22.560	1.5	1.5	2.0	5.300	4.150	0.000	0.250
HT/FROST INSULATOR		BLD		25.860	27.060	1.5	1.5	2.0	4.800	7.500	0.000	0.000
IRON WORKER		ALL		22.000	23.250	1.5	1.5	2.0	5.760	7.790	0.000	0.260
LABORER		BLD		23.040	23.790	1.5	1.5	2.0	6.540	6.900	0.000	0.600
LABORER		HWY		22.640	23.140	1.5	1.5	2.0	6.540	6.500	0.000	0.600
LABORER, SKILLED		BLD		23.040	23.790	1.5	1.5	2.0	6.540	6.900	0.000	0.600
LABORER, SKILLED		HWY		22.940	23.440	1.5	1.5	2.0	6.540	6.500	0.000	0.600
LATHER		BLD		25.750	27.040	1.5	1.5	2.0	5.700	5.360	0.000	0.400
MACHINIST		BLD		38.390	40.390	2.0	2.0	2.0	4.880	6.550	2.650	0.000
MARBLE FINISHERS		BLD		24.910	0.000	1.5	1.5	2.0	6.250	7.350	0.000	0.420
MARBLE MASON		BLD		26.520	27.770	1.5	1.5	2.0	6.250	7.350	0.000	0.420
MILLWRIGHT		BLD		26.500	28.200	1.5	1.5	2.0	5.550	8.670	0.000	0.560
MILLWRIGHT		HWY		19.330	20.580	1.5	1.5	2.0	1.550	2.000	0.000	0.000
OPERATING ENGINEER		BLD	1	28.510	31.510	1.5	1.5	2.0	6.250	9.000	0.000	1.000
OPERATING ENGINEER		BLD	2	26.530	31.510	1.5	1.5	2.0	6.250	9.000	0.000	1.000
OPERATING ENGINEER		BLD	3	25.090	31.510	1.5	1.5	2.0	6.250	9.000	0.000	1.000
OPERATING ENGINEER		HWY	1	29.110	32.110	1.5	1.5	2.0	6.250	9.000	0.000	1.000
OPERATING ENGINEER		HWY	2	26.730	32.110	1.5	1.5	2.0	6.250	9.000	0.000	1.000
OPERATING ENGINEER		HWY	3	22.790	32.110	1.5	1.5	2.0	6.250	9.000	0.000	1.000
PAINTER		ALL		24.270	25.270	1.5	1.5	1.5	4.700	4.850	0.000	0.600
PAINTER OVER 30FT		ALL		25.520	26.520	1.5	1.5	1.5	4.700	4.850	0.000	0.600
PAINTER PWR EQMT		ALL		24.770	25.770	1.5	1.5	1.5	4.700	4.850	0.000	0.600
PILEDRIVER		BLD		25.750	27.040	1.5	1.5	2.0	5.700	5.360	0.000	0.400
PILEDRIVER		HWY		26.060	27.810	1.5	1.5	2.0	5.860	7.260	0.000	0.400
PIPEFITTER		ALL		31.080	34.190	1.5	1.5	2.0	4.950	8.460	0.000	0.550
PLASTERER		BLD		26.000	27.560	1.5	1.5	2.0	4.000	5.000	0.000	0.250
PLUMBER		ALL		31.080	34.190	1.5	1.5	2.0	4.950	8.460	0.000	0.550
ROOFER		BLD		22.850	24.100	1.5	1.5	2.0	5.840	4.870	0.000	0.190
SHEETMETAL WORKER		BLD		24.350	25.960	1.5	1.5	2.0	6.540	7.420	0.000	0.380
SPRINKLER FITTER		BLD		31.240	33.240	1.5	1.5	2.0	6.500	5.350	0.000	0.250
STONE MASON		BLD		27.020	28.520	1.5	1.5	2.0	6.250	7.350	0.000	0.420
TERRAZZO FINISHER		BLD		24.910	0.000	1.5	1.5	2.0	6.250	7.350	0.000	0.420
TERRAZZO MASON		BLD		26.520	27.770	1.5	1.5	2.0	6.250	7.350	0.000	0.420
TILE LAYER		BLD		25.750	27.040	1.5	1.5	2.0	5.700	5.360	0.000	0.400
TILE MASON		BLD		26.520	27.770	1.5	1.5	2.0	6.250	7.350	0.000	0.420
TRUCK DRIVER		ALL	1	26.655	0.000	1.5	1.5	2.0	7.900	3.550	0.000	0.000
TRUCK DRIVER		ALL	2	27.055	0.000	1.5	1.5	2.0	7.900	3.550	0.000	0.000
TRUCK DRIVER		ALL	3	27.255	0.000	1.5	1.5	2.0	7.900	3.550	0.000	0.000
TRUCK DRIVER		ALL	4	27.505	0.000	1.5	1.5	2.0	7.900	3.550	0.000	0.000
TRUCK DRIVER		ALL	5	28.255	0.000	1.5	1.5	2.0	7.900	3.550	0.000	0.000
TRUCK DRIVER		O&C	1	21.320	0.000	1.5	1.5	2.0	7.900	3.550	0.000	0.000

TRUCK DRIVER	O&C 2	21.640	0.000	1.5	1.5	2.0	7.900	3.550	0.000	0.000
TRUCK DRIVER	O&C 3	21.800	0.000	1.5	1.5	2.0	7.900	3.550	0.000	0.000
TRUCK DRIVER	O&C 4	22.000	0.000	1.5	1.5	2.0	7.900	3.550	0.000	0.000
TRUCK DRIVER	O&C 5	22.600	0.000	1.5	1.5	2.0	7.900	3.550	0.000	0.000
TUCKPOINTER	BLD	27.020	28.520	1.5	1.5	2.0	6.250	7.350	0.000	0.420

Legend :

M-F>8 (Overtime is required for any hour greater than 8 worked each day, Monday through Friday.)

OSA (Overtime is required for every hour worked on Saturday)

OSH (Overtime is required for every hour worked on Sunday and Holidays)

H/W (Health & Welfare Insurance)

Pensn (Pension)

Vac (Vacation)

Trng (Training)

Explanations

HENDERSON COUNTY

The following list is considered as those days for which holiday rates of wages for work performed apply: New Years Day, Memorial/Decoration Day, Fourth of July, Labor Day, Veterans Day, Thanksgiving Day, Christmas Day. Generally, any of these holidays which fall on a Sunday is celebrated on the following Monday. This then makes work performed on that Monday payable at the appropriate overtime rate for holiday pay. Common practice in a given local may alter certain days of celebration such as the day after Thanksgiving for Veterans Day. If in doubt, please check with IDOL.

Oil and chip resealing (O&C) means the application of road oils and liquid asphalt to coat an existing road surface, followed by application of aggregate chips or gravel to coated surface, and subsequent rolling of material to seal the surface.

EXPLANATION OF CLASSES

ASBESTOS - GENERAL - removal of asbestos material/mold and hazardous materials from any place in a building, including mechanical systems where those mechanical systems are to be removed. This includes the removal of asbestos materials/mold and hazardous materials from ductwork or pipes in a building when the building is to be demolished at the time or at some close future date.

ASBESTOS - MECHANICAL - removal of asbestos material from mechanical systems, such as pipes, ducts, and boilers, where the mechanical systems are to remain.

CERAMIC TILE FINISHER, MARBLE FINISHER, TERRAZZO FINISHER

Assisting, helping or supporting the tile, marble and terrazzo mechanic by performing their historic and traditional work assignments required to complete the proper installation of the work covered by

said crafts. The term "Ceramic" is used for naming the classification only and is in no way a limitation of the product handled. Ceramic takes into consideration most hard tiles.

ELECTRONIC SYSTEMS TECHNICIAN

Installation, service and maintenance of low-voltage systems which utilizes the transmission and/or transference of voice, sound, vision, or digital for commercial, education, security and entertainment purposes for the following: TV monitoring and surveillance, background/foreground music, intercom and telephone interconnect, field programming, inventory control systems, microwave transmission, multi-media, multiplex, radio page, school, intercom and sound burglar alarms and low voltage master clock systems.

Excluded from this classification are energy management systems, life safety systems, supervisory controls and data acquisition systems not intrinsic with the above listed systems, fire alarm systems, nurse call systems and raceways exceeding fifteen feet in length.

LABORER, SKILLED - BUILDING

The skilled laborer building (BLD) classification shall encompass the following types of work, irrespective of the site of the work: tending of carpenters in unloading, handling, stockpiling and distribution operations, also other building crafts, mixing, handling, and conveying of all materials used by masons, plasterers and other building construction crafts, whether done by hand or by any process. The drying of plastering when done by salamander heat, and the cleaning and clearing of all debris. All work pertaining to and in preparation of asbestos abatement and removal. The building of scaffolding and staging for masons and plasterers. The excavations for buildings and all other construction, digging, of trenches, piers, foundations and holes, digging, lagging, sheeting, cribbing, bracing and propping of foundations, holes, caissons, cofferdams, and dikes, the setting of all guidelines for machine or hand excavation and subgrading. The mixing, handling, conveying, pouring, vibrating, gunniting and otherwise applying of concrete, whether by hand or other method of concrete for any walls, foundations, floors, or for other construction concrete sealant men. The wrecking, stripping, dismantling, and handling of concrete forms and false work, and the building of centers for fireproofing purposes. Boring machine, gas, electric or air in preparation for shoving pipe, telephone cable, and so forth, under highways, roads, streets and alleys. All hand and power operating cross cut saws when used for clearing. All work in compressed air construction. All work on acetylene burners in salvaging. The blocking and tamping of concrete. The laying of sewer tile and conduit, and pre-cast materials. The assembling and dismantling of all jacks and sectional scaffolding, including elevator construction and running of slip form jacks. The work of drill running and blasting, including wagon drills. The wrecking, stripping, dismantling, cleaning, moving and oiling of forms. The cutting off of concrete piles. The loading, unloading, handling and carrying to place of installation of all rods, (and materials for use in reinforcing) concrete and the hoisting of same and all signaling where hoist is used in this type of construction coming under the jurisdiction of the Laborers' Union. And, all other labor work not awarded to any other craft. Mortar mixers, kettlemen and carrier of hot stuff, tool crib men, watchmen (Laborer), firemen or salamander tenders, flagmen, deck hands, installation and maintenance of temporary gas-fired heating units, gravel box men, dumpmen and spotters, fencing Laborers, cleaning lumber, pit men, material checkers, dispatchers, unloading explosives, asphalt plant laborers,

writer of scale tickets, fireproofing laborers, janitors, asbestos abatement and removal laborers, handling of materials treated with oil, creosote, chloride, asphalt, and/or foreign material harmful to skin or clothing, Laborers with de-watering systems, gunnite nozzle men, laborers tending masons with hot material or where foreign materials are used, Laborers handling masterplate or similar materials, laser beam operator, concrete burning machine operator, material selector men working with firebrick or combustible material, dynamite men, track laborers, cement handlers, chloride handlers, the unloading and laborers with steel workers and re-bars, concrete workers (wet), luteman, asphalt raker, curb asphalt machine operator, ready mix scalemen, permanent, portable or temporary plant drilling machine operator, plaster tenders, underpinning and shoring of buildings, fire watch, signaling of all power equipment, to include trucks excavating equipment, etc., tree topper or trimmer when in connection to construction, tunnel helpers in free air, batch dumpers, kettle and tar men, tank cleaners, plastic installers, scaffold workers, motorized buggies or motorized unit used for wet concrete or handling of building materials, sewer workers, rod and chain men, vibrator operators, mortar mixer operator, cement silica, clay, fly ash, lime and plasters, handlers (bulk or bag), cofferdam workers, on concrete paving, placing, cutting and tying of reinforcing, deck hand, dredge hand and shore laborers, bankmen on floating plant, asphalt workers with machine & layers, grade checker, power tools, caisson workers, lead man on sewer work, welders, cutters, burners and torch men, chain saw operators, paving breaker, jackhammer and drill operator, layout man and/or drainage tile layer, steel form setters -- street and highway, air tamping hammerman, signal man on crane, concrete saw operator, screen man on asphalt pavers, front end man on chip spreader, multiple concrete duct -- lead man.

LABORER, SKILLED - HIGHWAY

The skilled laborer heavy and highway (HWY) classification shall encompass the following types of work, irrespective of the site of the work: handling of materials treated with oil, creosote, asphalt and/or any foreign materials harmful to skin or clothing, track laborers, chloride handlers, the unloading and loading with steel workers and re-bars, concrete workers (wet), tunnel helpers in free air, batch dumpers, mason tenders, kettle and tar men, plastic installers, scaffold workers, motorized buggies or motorized unit used for wet concrete or handling of building materials, laborers with de-watering systems, sewer workers plus depth, rod and chainmen, vibrator operators, mortar mixer operators, cement silica, clay, fly ash, lime and plasters, handlers (bulk or bag), cofferdam workers plus depth, on concrete paving, placing, cutting and tying or reinforcing, deck hand, dredge hand shore laborers, bankmen on floating plant, asphalt workers with machine, and layers, grade checker, power tools, stripping of all concrete forms excluding paving forms, dumpmen and spotters, when necessary, caisson workers plus depth, gunnite nozzle men, welders, cutters, burners and torchmen, chain saw operators, paving breaker, jackhammer and drill operators, layout man and/or drainage tile layer, steel form setters - street and highway, air tamping hammerman, signal man on crane, concrete saw operator, screedman on asphalt pavers, front end man on chip spreader, multiple concrete duct, luteman, asphalt raker, curb asphalt machine operator, ready mix scalemen (portable or temporary plant), laser beam operator, concrete burning machine operator, and coring machine operator.

TRUCK DRIVER - BUILDING, HEAVY AND HIGHWAY CONSTRUCTION

Class 1. Drivers on 2 axle trucks hauling less than 9 ton. Air compressor and welding machines and brooms, including those pulled by separate units, truck driver helpers, warehouse employees, mechanic

helpers, greasers and tiremen, pickup trucks when hauling materials, tools, or workers to and from and on-the-job site, and fork lifts up to 6,000 lb. capacity.

Class 2. Two or three axle trucks hauling more than 9 ton but hauling less than 16 ton. A-frame winch trucks, hydrolift trucks, vactor trucks or similar equipment when used for transportation purposes. Fork lifts over 6,000 lb. capacity, winch trucks, four axle combination units, and ticket writers.

Class 3. Two, three or four axle trucks hauling 16 ton or more. Drivers on water pulls, articulated dump trucks, mechanics and working forepersons, and dispatchers. Five axle or more combination units.

Class 4. Low Boy and Oil Distributors.

Class 5. Drivers who require special protective clothing while employed on hazardous waste work.

TRUCK DRIVER - OIL AND CHIP RESEALING ONLY.

This shall encompass laborers, workers and mechanics who drive contractor or subcontractor owned, leased, or hired pickup, dump, service, or oil distributor trucks. The work includes transporting materials and equipment (including but not limited to, oils, aggregate supplies, parts, machinery and tools) to or from the job site; distributing oil or liquid asphalt and aggregate; stock piling material when in connection with the actual oil and chip contract. The Truck Driver (Oil & Chip Resealing) wage classification does not include supplier delivered materials.

OPERATING ENGINEERS - BUILDING

Class 1. Cranes; Overhead Cranes; Gradall; All Cherry Pickers; Mechanics; Central Concrete Mixing Plant Operator; Road Pavers (27E - Dual Drum - Tri Batchers); Blacktop Plant Operators and Plant Engineers; 3 Drum Hoist; Derricks; Hydro Cranes; Shovels; Skimmer Scoops; Koehring Scooper; Drag Lines; Backhoe; Derrick Boats; Pile Drivers and Skid Rigs; Clamshells; Locomotive Cranes; Dredge (all types) Motor Patrol; Power Blades - Dumore - Elevating and similar types; Tower Cranes (Crawler-Mobile) and Stationary; Crane-type Backfiller; Drott Yumbo and similar types considered as Cranes; Caisson Rigs; Dozer; Tournadozer; Work Boats; Ross Carrier; Helicopter; Tournapulls - all and similar types; Scoops (all sizes); Pushcats; Endloaders (all types); Asphalt Surfacing Machine; Slip Form Paver; Rock Crusher; Heavy Equipment Greaser; CMI, CMI Belt Placer, Auto Grade & 3 Track and similar types; Side Booms; Multiple Unit Earth Movers; Creter Crane; Trench Machine; Pump-crete-Belt Crete-Squeeze Cretes-Screw-type Pumps and Gypsum; Bulker & Pump - Operator will clean; Formless Finishing Machine; Flaherty Spreader or similar types; Screed Man on Laydown Machine; Wheel Tractors (industrial or Farm-type w/Dozer-Hoe-Endloader or other attachments); F.W.D. & Similar Types; Vermeer Concrete Saw.

Class 2. Dinkeys; Power Launches; PH One-pass Soil Cement Machine (and similar types); Pugmill with Pump; Backfillers; Euclid Loader; Forklifts; Jeeps w/Ditching Machine or other attachments; Tuneluger; Automatic Cement and Gravel Batching Plants; Mobile Drills (Soil Testing) and similar types; Gurries and Similar Types; (1) and (2) Drum Hoists (Buck Hoist and Similar Types); Chicago Boom; Boring Machine & Pipe Jacking Machine; Hydro Boom; Dewatering System; Straw Blower; Hydro Seeder; Assistant Heavy Equipment Greaser on Spread;

Tractors (Track type) without Power Unit pulling Rollers; Rollers on Asphalt -- Brick Macadam; Concrete Breakers; Concrete Spreaders; Mule Pulling Rollers; Center Stripper; Cement Finishing Machines & CMI Texture & Reel Curing Machines; Cement Finishing Machine; Barber Green or similar loaders; Vibro Tamper (All similar types) Self-propelled; Winch or Boom Truck; Mechanical Bull Floats; Mixers over 3 Bag to 27E; Tractor pulling Power Blade or Elevating Grader; Porter Rex Rail; Clary Screed; Truck Type Hoptoe Oilers; Fireman; Spray Machine on Paving; Curb Machines; Truck Crane Oilers; Oil Distributor; Truck-Mounted Saws.

Class 3. Air Compressor; Power Subgrader; Straight Tractor; Trac Air without attachments; Herman Nelson Heater, Dravo, Warner, Silent Glo, and similar types; Roller: Five (5) Ton and under on Earth or Gravel; Form Grader; Crawler Crane & Skid Rig Oilers; Freight Elevators - permanently installed; Pump; Light Plant; Generator; Conveyor (1) or (2) - Operator will clean; Welding Machine; Mixer (3) Bag and Under (Standard Capacity with skip); Bulk Cement Plant; Oiler on Central Concrete Mixing Plant.

OPERATING ENGINEERS - HEAVY AND HIGHWAY CONSTRUCTION

Class 1. Cranes; Hydro Crane; Shovels; Crane Type Backfiller; Tower Cranes - Mobile & Crawler & Stationary; Derricks & Hoists (3 Drum); Draglines; Drott Yumbo & similar types considered as Cranes; Back Hoe; Derrick Boats; Pile Driver and Skid Rigs; Clam Shell; Locomotive - Cranes; Road Pavers - Single Drum - Dual Drum - Tri Batcher; Motor Patrols & Power Blades - Dumore - Elevating & Similar Types; Mechanics; Central Concrete Mixing Plant Operator; Asphalt Batch Plant Operators and Plant Engineers; Gradall; Caisson Rigs; Skimmer Scoop - Koering Scooper; Dredges (all types); Hoptoe; All Cherry Pickers; Work Boat; Ross Carrier; Helicopter; Dozer; Tournadozer; Tournapulls - all and similar types; Multiple Unit Earth Movers; Scoops (all sizes); Pushcats; Endloaders (all types); Asphalt Surfacing Machine; Slip Form Paver; Rock Crusher; Heavy Equipment Greaser (top greaser on spread); CMI, Auto Grade, CMI Belt Placer & 3 Track and similar types; Side Booms; Starting Engineer on Pipeline; Asphalt Heater & Planer Combination (used to plane streets); Wheel Tractors (with dozer, hoe or endloader attachments); F.W.D. and Similar types; Blaw Knox Spreader and Similar types; Trench Machines; Pump Crete - Belt Crete - Squeeze Crete - screw type pumps and gypsum (operator will clean); Formless Finishing Machines; Flaherty Spreader or similar types; Screed Man on Laydown Machine; Vermeer Concrete Saw.

Class 2. Bulker & Pump; Power Launches; Boring Machine & Pipe Jacking Machine; Dinkeys; P-H One Pass Soil Cement Machines and similar types; Wheel Tractors (Industry or farm type - other); Back Fillers; Euclid Loader; Fork Lifts; Jeep w/Ditching Machine or other attachments; Tunneluger; Automatic Cement & Gravel Batching Plants; Mobile Drills - Soil Testing and similar types; Pugmill with pump; All (1) and (2) Drum Hoists; Dewatering System; Straw Blower; Hydro-Seeder; Boring Machine; Hydro-Boom; Bump Grinders (self-propelled); Assistant Heavy Equipment Greaser; Apsco Spreader; Tractors (track-type) without Power Units Pulling Rollers on Asphalt - Brick or Macadam; Concrete Breakers; Concrete Spreaders; Cement Strippers; Cement Finishing Machines & CMI Texture & Reel Curing Machines; Vibro-Tampers (all similar types self-propelled); Mechanical Bull Floats; Self-propelled Concrete Saws; Mixers-over three (3) bags to 27E; Winch and Boom Trucks; Tractor Pulling Power Blade or Elevating Grader; Porter Rex Rail; Clary Screed; Mule Pulling Rollers; Pugmill without Pump; Barber Greene or similar Loaders; Track Type Tractor w/Power Unit attached (minimum); Fireman; Spray Machine on Paving; Curb Machines; Paved Ditch Machine; Power Broom;

Self-Propelled Conveyors; Power Subgrader; Oil Distributor; Straight Tractor; Truck Crane Oiler; Truck Type Oilers; Directional boring machine; Horizontal directional drill.

Class 3. Straight framed articulating end dump vehicle and Truck mounted vac unit (separately powered); Trac Air Machine (without attachments); Herman Nelson Heater, Dravo Warner, Silent Glo & similar types; Rollers - five ton and under on earth and gravel; Form Graders; Pumps; Light Plant; Generator; Air Compressor (1) or (2); Conveyor; Welding Machine; Mixer - 3 bags and under; Bulk Cement Plant; Oilers.

Other Classifications of Work:

For definitions of classifications not otherwise set out, the Department generally has on file such definitions which are available. If a task to be performed is not subject to one of the classifications of pay set out, the Department will upon being contacted state which neighboring county has such a classification and provide such rate, such rate being deemed to exist by reference in this document. If no neighboring county rate applies to the task, the Department shall undertake a special determination, such special determination being then deemed to have existed under this determination. If a project requires these, or any classification not listed, please contact IDOL at 618/993-7271 for wage rates or clarifications.

LANDSCAPING

Landscaping work falls under the existing classifications for laborer, operating engineer and truck driver. The work performed by landscape plantsman and landscape laborer is covered by the existing classification of laborer. The work performed by landscape operators (regardless of equipment used or its size) is covered by the classifications of operating engineer. The work performed by landscape truck drivers (regardless of size of truck driven) is covered by the classifications of truck driver.

Warren County Prevailing Wage for December 2007

Trade Name	RG	TYP	C	Base	FRMAN	*M-F>8	OSA	OSH	H/W	Pensn	Vac	Trng
=====	==	==	=	=====	=====	=====	==	==	=====	=====	=====	=====
ASBESTOS ABT-GEN		BLD		24.040	24.790	1.5	1.5	2.0	6.540	6.900	0.000	0.600
ASBESTOS ABT-GEN		HWY		23.640	24.140	1.5	1.5	2.0	6.540	6.500	0.000	0.700
ASBESTOS ABT-MEC		BLD		18.750	19.750	1.5	1.5	2.0	4.750	2.000	0.000	0.000
BOILERMAKER		BLD		30.970	33.970	2.0	2.0	2.0	8.270	7.740	0.000	0.300
BRICK MASON		BLD		27.020	28.520	1.5	1.5	2.0	6.250	7.350	0.000	0.420
CARPENTER		BLD		26.730	28.730	1.5	1.5	2.0	6.750	8.000	0.000	0.320
CARPENTER		HWY		27.860	29.860	1.5	1.5	2.0	6.750	8.000	0.000	0.320
CEMENT MASON		ALL		24.560	25.060	1.5	1.5	2.0	5.050	5.500	0.000	0.400
CERAMIC TILE FNSHER		BLD		24.910	0.000	1.5	1.5	2.0	6.250	7.350	0.000	0.420
ELECTRIC PWR EQMT OP		ALL		30.750	0.000	1.5	1.5	2.0	4.750	8.610	0.000	0.000
ELECTRIC PWR GRNDMAN		ALL		21.090	0.000	1.5	1.5	2.0	4.750	5.905	0.000	0.000
ELECTRIC PWR LINEMAN		ALL		34.160	36.350	1.5	1.5	2.0	4.750	9.560	0.000	0.000
ELECTRIC PWR TRK DRV		ALL		22.130	0.000	1.5	1.5	2.0	4.750	6.200	0.000	0.000
ELECTRICIAN		BLD		27.040	29.040	1.5	1.5	2.0	5.150	7.460	0.000	0.250
ELECTRONIC SYS TECH		BLD		24.830	26.330	1.5	1.5	2.0	5.150	6.145	0.000	0.250
ELEVATOR CONSTRUCTOR		BLD		34.190	38.460	2.0	2.0	2.0	8.275	6.060	2.050	0.000
GLAZIER		BLD		21.280	22.560	1.5	1.5	2.0	5.300	4.150	0.000	0.250
HT/FROST INSULATOR		BLD		25.860	27.060	1.5	1.5	2.0	4.800	7.500	0.000	0.000
IRON WORKER		ALL		22.000	23.250	1.5	1.5	2.0	5.760	7.790	0.000	0.260
LABORER		BLD		23.040	23.790	1.5	1.5	2.0	6.540	6.900	0.000	0.600
LABORER		HWY		22.640	23.140	1.5	1.5	2.0	6.540	6.500	0.000	0.600
LABORER, SKILLED		BLD		23.040	23.790	1.5	1.5	2.0	6.540	6.900	0.000	0.600
LABORER, SKILLED		HWY		22.940	23.440	1.5	1.5	2.0	6.540	6.500	0.000	0.600
LATHER		BLD		26.730	28.730	1.5	1.5	2.0	6.750	8.000	0.000	0.320
MACHINIST		BLD		38.390	40.390	2.0	2.0	2.0	4.880	6.550	2.650	0.000
MARBLE FINISHERS		BLD		24.910	0.000	1.5	1.5	2.0	6.250	7.350	0.000	0.420
MARBLE MASON		BLD		26.520	27.770	1.5	1.5	2.0	6.250	7.350	0.000	0.420
MILLWRIGHT		BLD		27.180	29.180	1.5	1.5	2.0	6.750	7.850	0.000	0.320
MILLWRIGHT		HWY		28.410	30.410	1.5	1.5	2.0	6.750	7.950	0.000	0.320
OPERATING ENGINEER		BLD	1	28.510	31.510	1.5	1.5	2.0	6.250	9.000	0.000	1.000
OPERATING ENGINEER		BLD	2	26.530	31.510	1.5	1.5	2.0	6.250	9.000	0.000	1.000
OPERATING ENGINEER		BLD	3	25.090	31.510	1.5	1.5	2.0	6.250	9.000	0.000	1.000
OPERATING ENGINEER		HWY	1	29.110	32.110	1.5	1.5	2.0	6.250	9.000	0.000	1.000
OPERATING ENGINEER		HWY	2	26.730	32.110	1.5	1.5	2.0	6.250	9.000	0.000	1.000
OPERATING ENGINEER		HWY	3	22.790	32.110	1.5	1.5	2.0	6.250	9.000	0.000	1.000
PAINTER		ALL		24.270	25.270	1.5	1.5	1.5	4.700	4.850	0.000	0.600
PAINTER OVER 30FT		ALL		25.520	26.520	1.5	1.5	1.5	4.700	4.850	0.000	0.600
PAINTER PWR EQMT		ALL		24.770	25.770	1.5	1.5	1.5	4.700	4.850	0.000	0.600
PILEDRIVER		BLD		27.230	29.230	1.5	1.5	2.0	6.750	8.000	0.000	0.320
PILEDRIVER		HWY		28.860	30.860	1.5	1.5	2.0	6.750	8.000	0.000	0.320
PIPEFITTER		ALL		31.080	34.190	1.5	1.5	2.0	4.950	8.460	0.000	0.550
PLASTERER		BLD		24.490	25.740	1.5	1.5	2.0	5.490	10.24	0.000	0.500
PLUMBER		ALL		31.080	34.190	1.5	1.5	2.0	4.950	8.460	0.000	0.550
ROOFER		BLD		22.850	24.100	1.5	1.5	2.0	5.840	4.870	0.000	0.190
SHEETMETAL WORKER		BLD		27.660	29.420	1.5	1.5	2.0	6.540	7.900	0.000	0.380
SPRINKLER FITTER		BLD		31.240	33.240	1.5	1.5	2.0	6.500	5.350	0.000	0.250
STONE MASON		BLD		27.020	28.520	1.5	1.5	2.0	6.250	7.350	0.000	0.420
TERRAZZO FINISHER		BLD		24.910	0.000	1.5	1.5	2.0	6.250	7.350	0.000	0.420
TERRAZZO MASON		BLD		26.520	27.770	1.5	1.5	2.0	6.250	7.350	0.000	0.420
TILE MASON		BLD		26.520	27.770	1.5	1.5	2.0	6.250	7.350	0.000	0.420
TRUCK DRIVER		ALL	1	26.655	0.000	1.5	1.5	2.0	7.900	3.550	0.000	0.000
TRUCK DRIVER		ALL	2	27.055	0.000	1.5	1.5	2.0	7.900	3.550	0.000	0.000
TRUCK DRIVER		ALL	3	27.255	0.000	1.5	1.5	2.0	7.900	3.550	0.000	0.000
TRUCK DRIVER		ALL	4	27.505	0.000	1.5	1.5	2.0	7.900	3.550	0.000	0.000
TRUCK DRIVER		ALL	5	28.255	0.000	1.5	1.5	2.0	7.900	3.550	0.000	0.000
TRUCK DRIVER		O&C	1	21.320	0.000	1.5	1.5	2.0	7.900	3.550	0.000	0.000
TRUCK DRIVER		O&C	2	21.640	0.000	1.5	1.5	2.0	7.900	3.550	0.000	0.000
TRUCK DRIVER		O&C	3	21.800	0.000	1.5	1.5	2.0	7.900	3.550	0.000	0.000

TRUCK DRIVER	O&C 4	22.000	0.000	1.5	1.5	2.0	7.900	3.550	0.000	0.000
TRUCK DRIVER	O&C 5	22.600	0.000	1.5	1.5	2.0	7.900	3.550	0.000	0.000
TUCKPINTER	BLD	27.020	28.520	1.5	1.5	2.0	6.250	7.350	0.000	0.420

Legend:

M-F>8 (Overtime is required for any hour greater than 8 worked each day, Monday through Friday.)

OSA (Overtime is required for every hour worked on Saturday)

OSH (Overtime is required for every hour worked on Sunday and Holidays)

H/W (Health & Welfare Insurance)

Pensn (Pension)

Vac (Vacation)

Trng (Training)

Explanations

WARREN COUNTY

The following list is considered as those days for which holiday rates of wages for work performed apply: New Years Day, Memorial/Decoration Day, Fourth of July, Labor Day, Veterans Day, Thanksgiving Day, Christmas Day. Generally, any of these holidays which fall on a Sunday is celebrated on the following Monday. This then makes work performed on that Monday payable at the appropriate overtime rate for holiday pay. Common practice in a given local may alter certain days of celebration such as the day after Thanksgiving for Veterans Day. If in doubt, please check with IDOL.

Oil and chip resealing (O&C) means the application of road oils and liquid asphalt to coat an existing road surface, followed by application of aggregate chips or gravel to coated surface, and subsequent rolling of material to seal the surface.

EXPLANATION OF CLASSES

ASBESTOS - GENERAL - removal of asbestos material/mold and hazardous materials from any place in a building, including mechanical systems where those mechanical systems are to be removed. This includes the removal of asbestos materials/mold and hazardous materials from ductwork or pipes in a building when the building is to be demolished at the time or at some close future date.

ASBESTOS - MECHANICAL - removal of asbestos material from mechanical systems, such as pipes, ducts, and boilers, where the mechanical systems are to remain.

CERAMIC TILE FINISHER, MARBLE FINISHER, TERRAZZO FINISHER

Assisting, helping or supporting the tile, marble and terrazzo mechanic by performing their historic and traditional work assignments required to complete the proper installation of the work covered by said crafts. The term "Ceramic" is used for naming the classification only and is in no way a limitation of the product handled. Ceramic

takes into consideration most hard tiles.

ELECTRONIC SYSTEMS TECHNICIAN

Installation, service and maintenance of low-voltage systems which utilizes the transmission and/or transference of voice, sound, vision, or digital for commercial, education, security and entertainment purposes for the following: TV monitoring and surveillance, background/foreground music, intercom and telephone interconnect, field programming, inventory control systems, microwave transmission, multi-media, multiplex, radio page, school, intercom and sound burglar alarms and low voltage master clock systems.

Excluded from this classification are energy management systems, life safety systems, supervisory controls and data acquisition systems not intrinsic with the above listed systems, fire alarm systems, nurse call systems and raceways exceeding fifteen feet in length.

LABORER, SKILLED - BUILDING

The skilled laborer building (BLD) classification shall encompass the following types of work, irrespective of the site of the work: tending of carpenters in unloading, handling, stockpiling and distribution operations, also other building crafts, mixing, handling, and conveying of all materials used by masons, plasterers and other building construction crafts, whether done by hand or by any process. The drying of plastering when done by salamander heat, and the cleaning and clearing of all debris. All work pertaining to and in preparation of asbestos abatement and removal. The building of scaffolding and staging for masons and plasterers. The excavations for buildings and all other construction, digging, of trenches, piers, foundations and holes, digging, lagging, sheeting, cribbing, bracing and propping of foundations, holes, caissons, cofferdams, and dikes, the setting of all guidelines for machine or hand excavation and subgrading. The mixing, handling, conveying, pouring, vibrating, gunniting and otherwise applying of concrete, whether by hand or other method of concrete for any walls, foundations, floors, or for other construction concrete sealant men. The wrecking, stripping, dismantling, and handling of concrete forms and false work, and the building of centers for fireproofing purposes. Boring machine, gas, electric or air in preparation for shoving pipe, telephone cable, and so forth, under highways, roads, streets and alleys. All hand and power operating cross cut saws when used for clearing. All work in compressed air construction. All work on acetylene burners in salvaging. The blocking and tamping of concrete. The laying of sewer tile and conduit, and pre-cast materials. The assembling and dismantling of all jacks and sectional scaffolding, including elevator construction and running of slip form jacks. The work of drill running and blasting, including wagon drills. The wrecking, stripping, dismantling, cleaning, moving and oiling of forms. The cutting off of concrete piles. The loading, unloading, handling and carrying to place of installation of all rods, (and materials for use in reinforcing) concrete and the hoisting of same and all signaling where hoist is used in this type of construction coming under the jurisdiction of the Laborers' Union. And, all other labor work not awarded to any other craft. Mortar mixers, kettlemen and carrier of hot stuff, tool crib men, watchmen (Laborer), firemen or salamander tenders, flagmen, deck hands, installation and maintenance of temporary gas-fired heating units, gravel box men, dumpmen and spotters, fencing Laborers, cleaning lumber, pit men, material checkers, dispatchers, unloading explosives, asphalt plant laborers, writer of scale tickets, fireproofing laborers, janitors, asbestos abatement and removal laborers, handling of materials treated with

oil, creosote, chloride, asphalt, and/or foreign material harmful to skin or clothing, Laborers with de-watering systems, gunnite nozzle men, laborers tending masons with hot material or where foreign materials are used, Laborers handling masterplate or similar materials, laser beam operator, concrete burning machine operator, material selector men working with firebrick or combustible material, dynamite men, track laborers, cement handlers, chloride handlers, the unloading and laborers with steel workers and re-bars, concrete workers (wet), luteman, asphalt raker, curb asphalt machine operator, ready mix scalemen, permanent, portable or temporary plant drilling machine operator, plaster tenders, underpinning and shoring of buildings, fire watch, signaling of all power equipment, to include trucks excavating equipment, etc., tree topper or trimmer when in connection to construction, tunnel helpers in free air, batch dumpers, kettle and tar men, tank cleaners, plastic installers, scaffold workers, motorized buggies or motorized unit used for wet concrete or handling of building materials, sewer workers, rod and chain men, vibrator operators, mortar mixer operator, cement silica, clay, fly ash, lime and plasters, handlers (bulk or bag), cofferdam workers, on concrete paving, placing, cutting and tying of reinforcing, deck hand, dredge hand and shore laborers, bankmen on floating plant, asphalt workers with machine & layers, grade checker, power tools, caisson workers, lead man on sewer work, welders, cutters, burners and torch men, chain saw operators, paving breaker, jackhammer and drill operator, layout man and/or drainage tile layer, steel form setters -- street and highway, air tamping hammerman, signal man on crane, concrete saw operator, screen man on asphalt pavers, front end man on chip spreader, multiple concrete duct -- lead man.

LABORER, SKILLED - HIGHWAY

The skilled laborer heavy and highway (HWY) classification shall encompass the following types of work, irrespective of the site of the work: handling of materials treated with oil, creosote, asphalt and/or any foreign materials harmful to skin or clothing, track laborers, chloride handlers, the unloading and loading with steel workers and re-bars, concrete workers (wet), tunnel helpers in free air, batch dumpers, mason tenders, kettle and tar men, plastic installers, scaffold workers, motorized buggies or motorized unit used for wet concrete or handling of building materials, laborers with de-watering systems, sewer workers plus depth, rod and chainmen, vibrator operators, mortar mixer operators, cement silica, clay, fly ash, lime and plasters, handlers (bulk or bag), cofferdam workers plus depth, on concrete paving, placing, cutting and tying or reinforcing, deck hand, dredge hand shore laborers, bankmen on floating plant, asphalt workers with machine, and layers, grade checker, power tools, stripping of all concrete forms excluding paving forms, dumpmen and spotters, when necessary, caisson workers plus depth, gunnite nozzle men, welders, cutters, burners and torchmen, chain saw operators, paving breaker, jackhammer and drill operators, layout man and/or drainage tile layer, steel form setters - street and highway, air tamping hammerman, signal man on crane, concrete saw operator, screedman on asphalt pavers, front end man on chip spreader, multiple concrete duct, luteman, asphalt raker, curb asphalt machine operator, ready mix scalemen (portable or temporary plant), laser beam operator, concrete burning machine operator, and coring machine operator.

TRUCK DRIVER - BUILDING, HEAVY AND HIGHWAY CONSTRUCTION

Class 1. Drivers on 2 axle trucks hauling less than 9 ton. Air compressor and welding machines and brooms, including those pulled by separate units, truck driver helpers, warehouse employees, mechanic helpers, greasers and tiremen, pickup trucks when hauling materials, tools, or workers to and from and on-the-job site, and fork lifts up

to 6,000 lb. capacity.

Class 2. Two or three axle trucks hauling more than 9 ton but hauling less than 16 ton. A-frame winch trucks, hydrolift trucks, vactor trucks or similar equipment when used for transportation purposes. Fork lifts over 6,000 lb. capacity, winch trucks, four axle combination units, and ticket writers.

Class 3. Two, three or four axle trucks hauling 16 ton or more. Drivers on water pulls, articulated dump trucks, mechanics and working forepersons, and dispatchers. Five axle or more combination units.

Class 4. Low Boy and Oil Distributors.

Class 5. Drivers who require special protective clothing while employed on hazardous waste work.

TRUCK DRIVER - OIL AND CHIP RESEALING ONLY.

This shall encompass laborers, workers and mechanics who drive contractor or subcontractor owned, leased, or hired pickup, dump, service, or oil distributor trucks. The work includes transporting materials and equipment (including but not limited to, oils, aggregate supplies, parts, machinery and tools) to or from the job site; distributing oil or liquid asphalt and aggregate; stock piling material when in connection with the actual oil and chip contract. The Truck Driver (Oil & Chip Resealing) wage classification does not include supplier delivered materials.

OPERATING ENGINEERS - BUILDING

Class 1. Cranes; Overhead Cranes; Gradall; All Cherry Pickers; Mechanics; Central Concrete Mixing Plant Operator; Road Pavers (27E - Dual Drum - Tri Batchers); Blacktop Plant Operators and Plant Engineers; 3 Drum Hoist; Derricks; Hydro Cranes; Shovels; Skimmer Scoops; Koehring Scooper; Drag Lines; Backhoe; Derrick Boats; Pile Drivers and Skid Rigs; Clamshells; Locomotive Cranes; Dredge (all types) Motor Patrol; Power Blades - Dumore - Elevating and similar types; Tower Cranes (Crawler-Mobile) and Stationary; Crane-type Backfiller; Drott Yumbo and similar types considered as Cranes; Caisson Rigs; Dozer; Tournadozer; Work Boats; Ross Carrier; Helicopter; Tournapulls - all and similar types; Scoops (all sizes); Pushcats; Endloaders (all types); Asphalt Surfacing Machine; Slip Form Paver; Rock Crusher; Heavy Equipment Greaser; CMI, CMI Belt Placer, Auto Grade & 3 Track and similar types; Side Booms; Multiple Unit Earth Movers; Creter Crane; Trench Machine; Pump-crete-Belt Crete-Squeeze Cretes-Screw-type Pumps and Gypsum; Bulker & Pump - Operator will clean; Formless Finishing Machine; Flaherty Spreader or similar types; Screed Man on Laydown Machine; Wheel Tractors (industrial or Farm-type w/Dozer-Hoe-Endloader or other attachments); F.W.D. & Similar Types; Vermeer Concrete Saw.

Class 2. Dinkeys; Power Launches; PH One-pass Soil Cement Machine (and similar types); Pugmill with Pump; Backfillers; Euclid Loader; Forklifts; Jeeps w/Ditching Machine or other attachments; Tuneluger; Automatic Cement and Gravel Batching Plants; Mobile Drills (Soil Testing) and similar types; Gurries and Similar Types; (1) and (2) Drum Hoists (Buck Hoist and Similar Types); Chicago Boom; Boring Machine & Pipe Jacking Machine; Hydro Boom; Dewatering System; Straw Blower; Hydro Seeder; Assistant Heavy Equipment Greaser on Spread; Tractors (Track type) without Power Unit pulling Rollers; Rollers on Asphalt -- Brick Macadem; Concrete Breakers; Concrete Spreaders; Mule

Pulling Rollers; Center Stripper; Cement Finishing Machines & CMI Texture & Reel Curing Machines; Cement Finishing Machine; Barber Green or similar loaders; Vibro Tamper (All similar types) Self-propelled; Winch or Boom Truck; Mechanical Bull Floats; Mixers over 3 Bag to 27E; Tractor pulling Power Blade or Elevating Grader; Porter Rex Rail; Clary Screed; Truck Type Hoptoe Oilers; Fireman; Spray Machine on Paving; Curb Machines; Truck Crane Oilers; Oil Distributor; Truck-Mounted Saws.

Class 3. Air Compressor; Power Subgrader; Straight Tractor; Trac Air without attachments; Herman Nelson Heater, Dravo, Warner, Silent Glo, and similar types; Roller: Five (5) Ton and under on Earth or Gravel; Form Grader; Crawler Crane & Skid Rig Oilers; Freight Elevators - permanently installed; Pump; Light Plant; Generator; Conveyor (1) or (2) - Operator will clean; Welding Machine; Mixer (3) Bag and Under (Standard Capacity with skip); Bulk Cement Plant; Oiler on Central Concrete Mixing Plant.

OPERATING ENGINEERS - HEAVY AND HIGHWAY CONSTRUCTION

Class 1. Cranes; Hydro Crane; Shovels; Crane Type Backfiller; Tower Cranes - Mobile & Crawler & Stationary; Derricks & Hoists (3 Drum); Draglines; Drott Yumbo & similar types considered as Cranes; Back Hoe; Derrick Boats; Pile Driver and Skid Rigs; Clam Shell; Locomotive - Cranes; Road Pavers - Single Drum - Dual Drum - Tri Batcher; Motor Patrols & Power Blades - Dumore - Elevating & Similar Types; Mechanics; Central Concrete Mixing Plant Operator; Asphalt Batch Plant Operators and Plant Engineers; Gradall; Caisson Rigs; Skimmer Scoop - Koering Scooper; Dredges (all types); Hoptoe; All Cherry Pickers; Work Boat; Ross Carrier; Helicopter; Dozer; Tournadozer; Tournapulls - all and similar types; Multiple Unit Earth Movers; Scoops (all sizes); Pushcats; Endloaders (all types); Asphalt Surfacing Machine; Slip Form Paver; Rock Crusher; Heavy Equipment Greaser (top greaser on spread); CMI, Auto Grade, CMI Belt Placer & 3 Track and similar types; Side Booms; Starting Engineer on Pipeline; Asphalt Heater & Planer Combination (used to plane streets); Wheel Tractors (with dozer, hoe or endloader attachments); F.W.D. and Similar types; Blaw Knox Spreader and Similar types; Trench Machines; Pump Crete - Belt Crete - Squeeze Crete - screw type pumps and gypsum (operator will clean); Formless Finishing Machines; Flaherty Spreader or similar types; Screed Man on Laydown Machine; Vermeer Concrete Saw.

Class 2. Bulker & Pump; Power Launches; Boring Machine & Pipe Jacking Machine; Dinkeys; P-H One Pass Soil Cement Machines and similar types; Wheel Tractors (Industry or farm type - other); Back Fillers; Euclid Loader; Fork Lifts; Jeep w/Ditching Machine or other attachments; Tunneluger; Automatic Cement & Gravel Batching Plants; Mobile Drills - Soil Testing and similar types; Pugmill with pump; All (1) and (2) Drum Hoists; Dewatering System; Straw Blower; Hydro-Seeder; Boring Machine; Hydro-Boom; Bump Grinders (self-propelled); Assistant Heavy Equipment Greaser; Apsco Spreader; Tractors (track-type) without Power Units Pulling Rollers on Asphalt - Brick or Macadam; Concrete Breakers; Concrete Spreaders; Cement Strippers; Cement Finishing Machines & CMI Texture & Reel Curing Machines; Vibro-Tampers (all similar types self-propelled); Mechanical Bull Floats; Self-propelled Concrete Saws; Mixers-over three (3) bags to 27E; Winch and Boom Trucks; Tractor Pulling Power Blade or Elevating Grader; Porter Rex Rail; Clary Screed; Mule Pulling Rollers; Pugmill without Pump; Barber Greene or similar Loaders; Track Type Tractor w/Power Unit attached (minimum); Fireman; Spray Machine on Paving; Curb Machines; Paved Ditch Machine; Power Broom; Self-Propelled Conveyors; Power Subgrader; Oil Distributor; Straight Tractor; Truck Crane Oiler; Truck Type Oilers; Directional boring

machine; Horizontal directional drill.

Class 3. Straight framed articulating end pump vehicles and Truck mounted vac unit (separately powered); Trac Air Machine (without attachments); Herman Nelson Heater, Dravo Warner, Silent Glo & similar types; Rollers - five ton and under on earth and gravel; Form Graders; Pumps; Light Plant; Generator; Air Compressor (1) or (2); Conveyor; Welding Machine; Mixer - 3 bags and under; Bulk Cement Plant; Oilers.

Other Classifications of Work:

For definitions of classifications not otherwise set out, the Department generally has on file such definitions which are available. If a task to be performed is not subject to one of the classifications of pay set out, the Department will upon being contacted state which neighboring county has such a classification and provide such rate, such rate being deemed to exist by reference in this document. If no neighboring county rate applies to the task, the Department shall undertake a special determination, such special determination being then deemed to have existed under this determination. If a project requires these, or any classification not listed, please contact IDOL at 618/993-7271 for wage rates or clarifications.

LANDSCAPING

Landscaping work falls under the existing classifications for laborer, operating engineer and truck driver. The work performed by landscape plantsman and landscape laborer is covered by the existing classification of laborer. The work performed by landscape operators (regardless of equipment used or its size) is covered by the classifications of operating engineer. The work performed by landscape truck drivers (regardless of size of truck driven) is covered by the classifications of truck driver.