

STATE OF ILLINOIS DEPARTMENT OF TRANSPORTATION

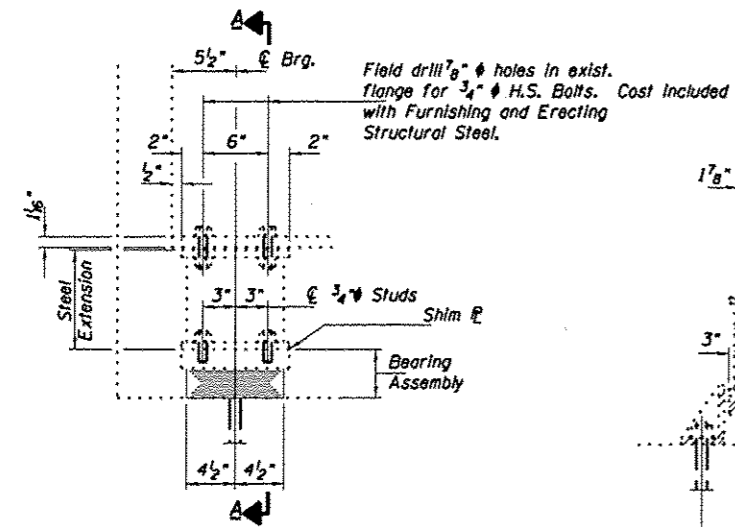

ELEVATION AT ABUTMENT

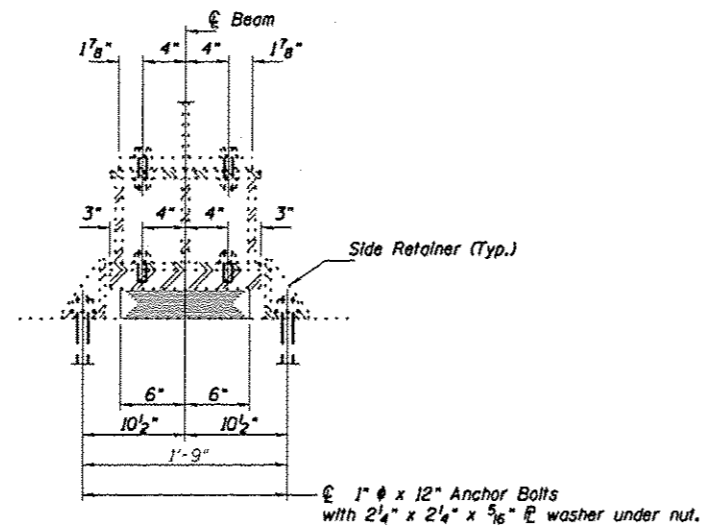

SECTION A-A

Notes:
 Anchor bolts shall be ASTM F1554 all-thread (or an Engineer-approved alternate material) of the grade(s) and diameter(s) specified. ASTM A307 Grade C anchor bolts may be used in lieu of ASTM F1554 Grade 36 (Fy=36ksi). The corresponding specified grade of AASHTO M314 anchor bolts may be used in lieu of ASTM F1554.
 Drilled and set anchor bolts shall be installed according to Article 521.06 of the Standard Specifications.
 Side retainers and other steel members required for the bearing assembly shall be included in the cost of Elastomeric Bearing Assembly, Type I.
 The minimum jack capacity required is 50 Tons.
 Existing diaphragm removal and reinstallation may be required to facilitate drilling holes, cost to be included with "Jack and Remove Existing Bearings".
 Prior to ordering any material, the Contractor shall verify in the field all bearing height and shim thickness dimensions.
 The structural steel plates of the Bearing Assembly shall conform to the requirements of AASHTO M 270 Grade - 50.
 Two 1/8 in. adjusting shims shall be provided for each bearing in addition to all other plates or shims and placed as shown on bearing details.
 New steel extensions, connection bolts and Shim R's are included in "Furnishing and Erecting Structural Steel".

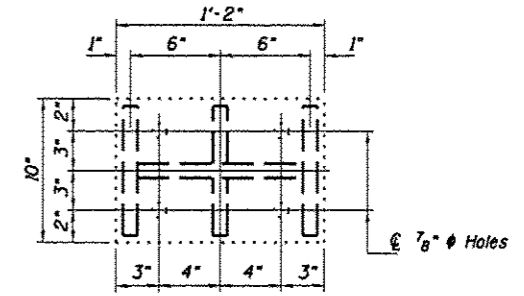

PLAN TOP AND BOTTOM PLATE

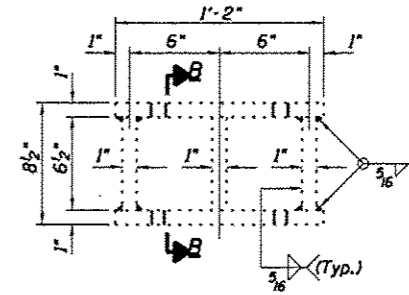

STEEL EXTENSION DETAIL

TYPE I ELASTOMERIC EXP. BRG.

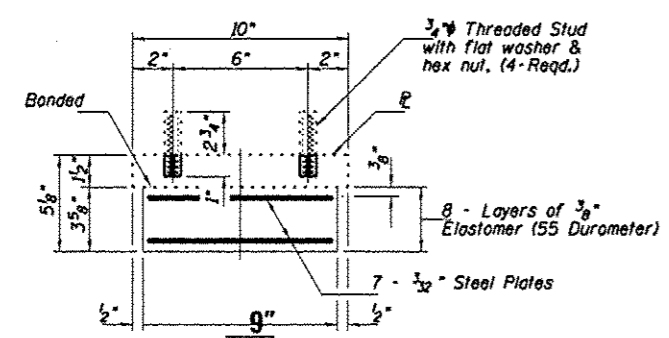

BEARING ASSEMBLY

Note:
Shim plates shall not be placed under Bearing Assembly.

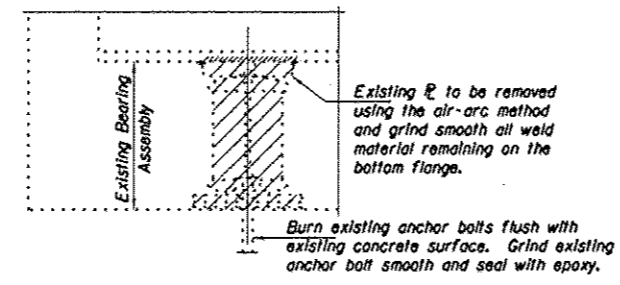

EXISTING BEARING REMOVAL DETAIL

Cost included with Jack and Remove Existing Bearings.

BEAM REACTIONS

R _P	(K)	23.8
R _L	(K)	37
Imp.	(K)	10
R (Total)	(K)	70.8

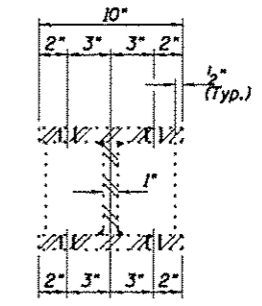

SECTION B-B

BILL OF MATERIAL

Item	Unit	Total
Elastomeric Bearing Assembly Type I	Each	6
Jack and Remove Existing Bearings	Each	6
Anchor Bolts, 1"	Each	12

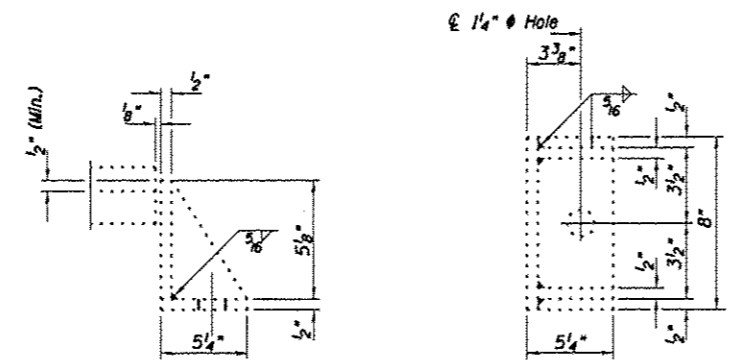

SIDE RETAINER

Equivalent rolled angle with stiffeners will be allowed in lieu of welded plates.

FOR INFORMATION ONLY
 BEARING DETAILS - EAST ABUTMENT
 ILL 13 W.B. OVER MUD CREEK
 JACKSON COUNTY
 SN 039-0050

BRIDGE REPAIRS FOR SN 039-0050