

F.A.P. RTE. 324	SECTION 23 B-2-I	COUNTY MCHENRY	TOTAL SHEETS 12	SHEET NO. 12
STA. TO STA.		ILLINOIS FED. AID PROJECT		

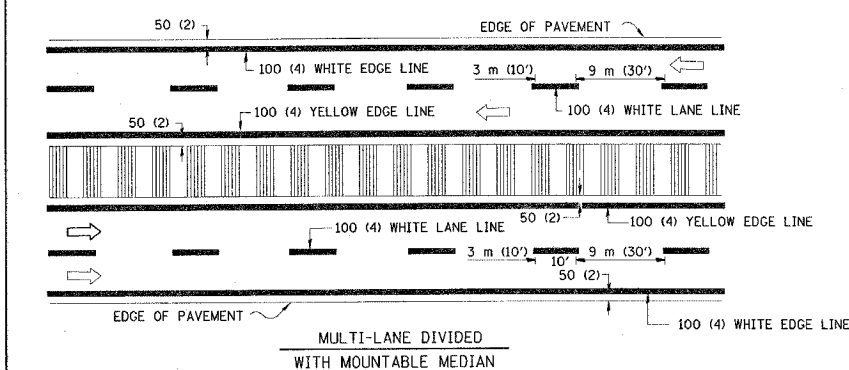

NOTE: MEDIANS WITH BARRIER CURB DO NOT REQUIRE AN EDGE LINE

TYPICAL LANE AND EDGE LINE MARKING

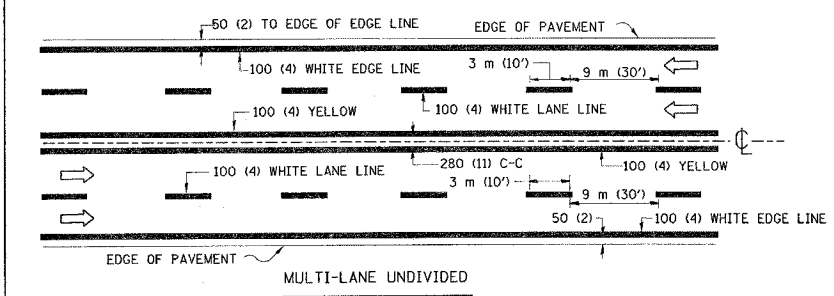
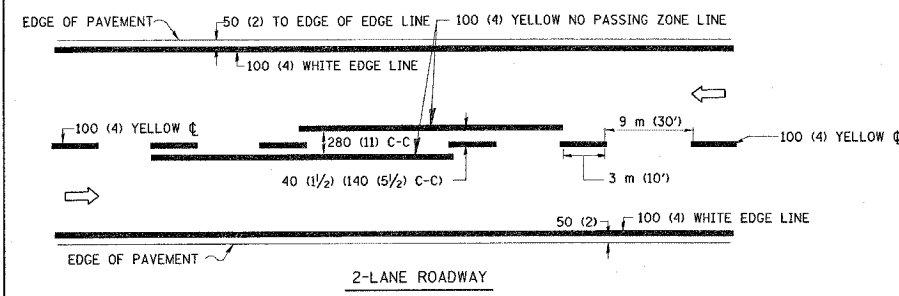
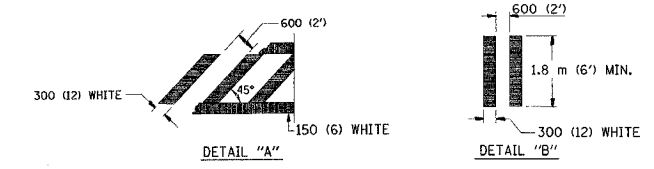
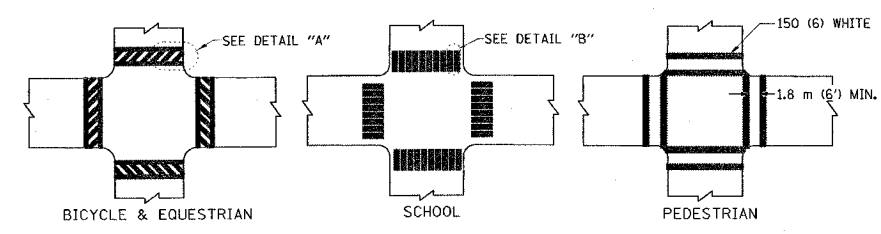

TYPICAL CROSSWALK MARKING

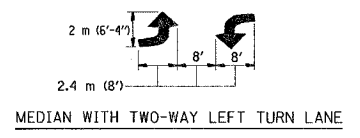
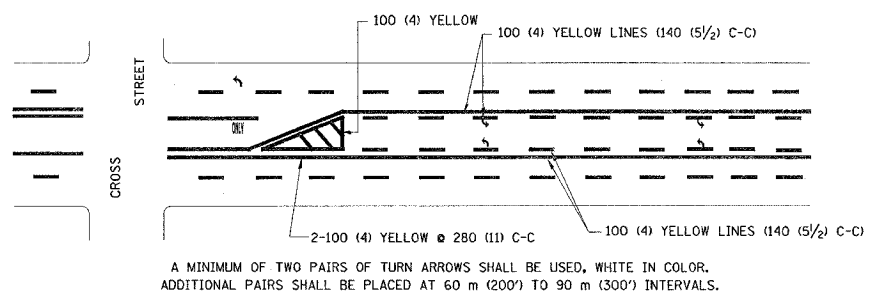
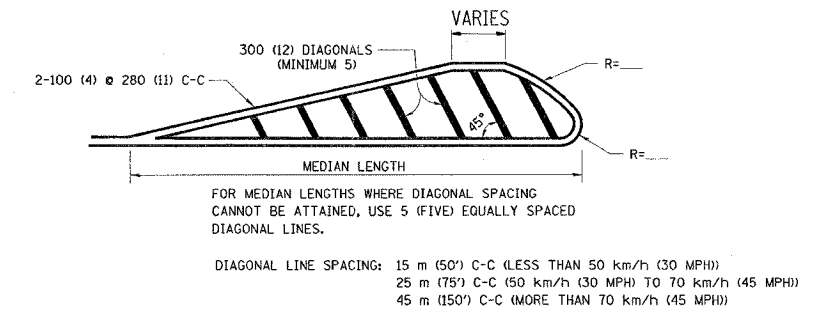
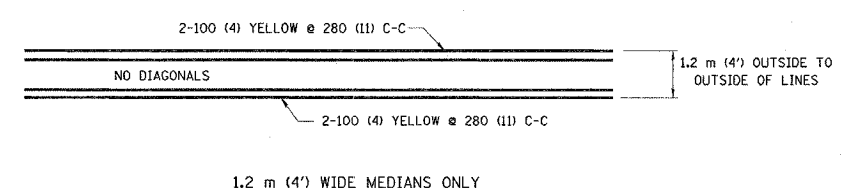

TYPICAL PAINTED MEDIAN MARKING

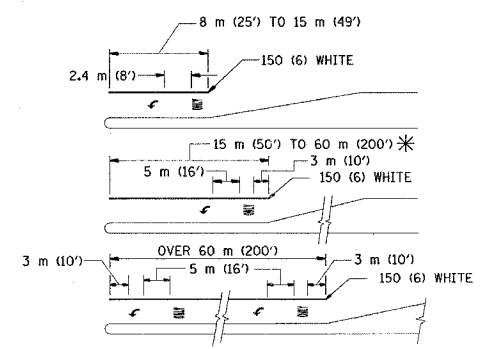

FULL SIZE LETTERS 2.4 m (8') AND ARROWS SHALL BE USED.  
AREA = 1.5 m<sup>2</sup> (15.6 SQ. FT.) ONLY AREA = 1.9 m<sup>2</sup> (20.8 SQ. FT.)  
\* TURN LANES IN EXCESS OF 120 m (400') IN LENGTH MAY HAVE AN ADDITIONAL SET OF ARROW - "ONLY" INSTALLED MIDWAY BETWEEN THE OTHER TWO SETS OF ARROW - "ONLY".

TYPICAL TURN LANE MARKING

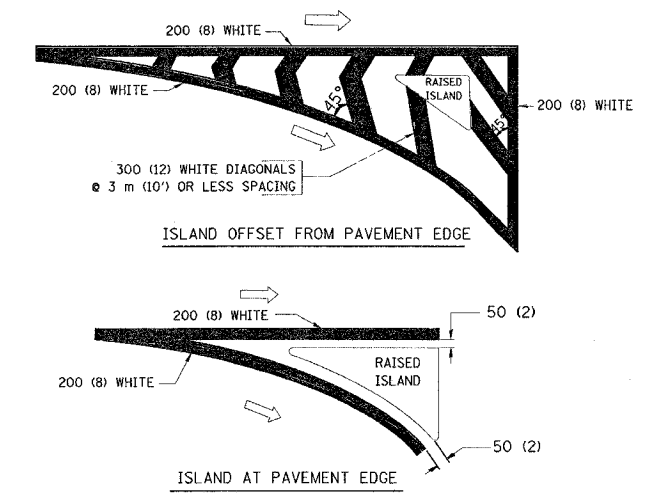

TYPICAL ISLAND MARKING

TYPE OF MARKING	WIDTH OF LINE	PATTERN	COLOR	SPACING / REMARKS
CENTERLINE ON 2 LANE PAVEMENT	100 (4)	SKIP-DASH	YELLOW	3 m (10') LINE WITH 9 m (30') SPACE
CENTERLINE ON MULTI-LANE UNDIVIDED PAVEMENT	2 @ 100 (4)	SOLID	YELLOW	280 (11) C-C
NO PASSING ZONE LINES: FOR ONE DIRECTION FOR BOTH DIRECTIONS	100 (4) 2 @ 100 (4)	SOLID SOLID	YELLOW YELLOW	140 (5 1/2) C-C FROM SKIP-DASH CENTERLINE 280 (11) C-C OMIT SKIP-DASH CENTERLINE BETWEEN
LANE LINES	100 (4) 125 (5) ON FREEWAYS	SKIP-DASH SKIP-DASH	WHITE WHITE	3 m (10') LINE WITH 9 m (30') SPACE
DOTTED LINES (EXTENSIONS OF CENTER, LANE OR TURN LANE MARKINGS)	SAME AS LINE BEING EXTENDED	SKIP-DASH	SAME AS LINE BEING EXTENDED	600 (2') LINE WITH 1.8 m (6') SPACE
EDGE LINES	100 (4)	SOLID	YELLOW-LEFT WHITE-RIGHT	OUTLINE MOUNTABLE MEDIANS IN YELLOW; EDGE LINES ARE NOT USED NEXT TO BARRIER CURB
TURN LANE MARKINGS	150 (6) LINE; FULL SIZE LETTERS & SYMBOLS (2.4 m (8'))	SOLID	WHITE	SEE TYPICAL TURN LANE MARKING DETAIL
TWO WAY LEFT TURN MARKING	2 @ 100 (4) EACH DIRECTION 2.4 m (8') LEFT ARROW	SKIP-DASH AND SOLID IN PAIRS	YELLOW WHITE	3 m (10') LINE WITH 9 m (30') SPACE FOR SKIP-DASH; 140 (5 1/2) C-C BETWEEN SOLID LINE AND SKIP-DASH LINE SEE TYPICAL TWO-WAY LEFT TURN MARKING DETAIL
CROSSWALK LINES (PEDESTRIAN) A. DIAGONALS (BIKE & EQUESTRIAN) B. LONGITUDINAL BARS (SCHOOL)	2 @ 150 (6) 300 (12) @ 45° 300 (12) @ 90°	SOLID SOLID SOLID	WHITE WHITE WHITE	NOT LESS THAN 1.8 m (6') APART 600 (2') APART 600 (2') APART SEE TYPICAL CROSSWALK MARKING DETAILS.
STOP LINES	600 (24)	SOLID	WHITE	PLACE 1.2 m (4') IN ADVANCE OF AND PARALLEL TO CROSSWALK, IF PRESENT. OTHERWISE, PLACE AT DESIRED STOPPING POINT, PARALLEL TO CROSSROAD CENTERLINE, WHERE POSSIBLE
PAINTED MEDIANS	2 @ 100 (4) WITH 300 (12) DIAGONALS @ 45° NO DIAGONALS USED FOR 1.2 m (4') WIDE MEDIANS	SOLID	YELLOW; TWO WAY TRAFFIC WHITE; ONE WAY TRAFFIC	280 (11) C-C FOR THE DOUBLE LINE SEE TYPICAL PAINTED MEDIAN MARKING.
GORE MARKING AND CHANNELIZING LINES	200 (8) WITH 300 (12) DIAGONALS @ 45°	SOLID	WHITE	DIAGONALS: 4.5 m (15') C-C (LESS THAN 50 km/h (30 MPH)) 6 m (20') C-C (50 km/h (30 MPH) TO 70 km/h (45 MPH)) 9 m (30') C-C (OVER 70 km/h (45 MPH))
RAILROAD CROSSING	600 (24) TRANSVERSE LINES; "RR" IS 1.8 m (6') LETTERS; 400 (16) LINE FOR "X"	SOLID	WHITE	SEE STATE STANDARD 780001 AREA OF: "R"=0.33m <sup>2</sup> (3.6 SQ. FT.) EACH "X"=5.0 m <sup>2</sup> (54.0 SQ. FT.)
SHOULDER DIAGONALS	300 (12) @ 45°	SOLID	WHITE - RIGHT YELLOW - LEFT	15 m (50') C-C (LESS THAN 50 km/h (30 MPH)) 25 m (75') C-C (50 km/h (30 MPH) TO 70 km/h (45 MPH)) 45 m (150') C-C (OVER 70 km/h (45 MPH))

FOR FURTHER DETAILS ON PAVEMENT MARKING REFER TO STANDARD SPECIFICATIONS FOR ROAD AND BRIDGE CONSTRUCTION AND STATE STANDARD 780001.

All dimensions are in millimeters (inches) unless otherwise shown.

REVISIONS	
NAME	DATE
EVERS	03-19-90
T. RAMMACHER	10-27-94
ALEX HOUSEH	10-09-96
ALEX HOUSEH	10-17-96
T. RAMMACHER	01-06-00

ILLINOIS DEPARTMENT OF TRANSPORTATION  
DISTRICT ONE  
TYPICAL PAVEMENT MARKINGS

SCALE: NONE  
DATE: 11/3/2006  
DRAWN BY CADD  
CHECKED BY  
TC-13  
REVISION DATE: 01/06/00

DATE = 11/3/2006  
PLOT SCALE = 50:1  
USER NAME = enser19