

107

Letting January 19, 2018

Notice to Bidders, Specifications and Proposal



**Illinois Department
of Transportation**

Springfield, Illinois 62764

**Contract No. 87681
LIVINGSTON County
Section 13-00052-01-HP (Dwight)
Route DWIGHT REG. (Center / Depot)
Project TE-00D3(098)
District 3 Construction Funds**

Plans Included
Herein

Prepared by

Checked by

F

(Printed by authority of the State of Illinois)



NOTICE TO BIDDERS

- 1. TIME AND PLACE OF OPENING BIDS.** Electronic bids are to be submitted to the electronic bidding system (iCX-Integrated Contractors Exchange). All bids must be submitted to the iCX system prior to 10:00 a.m. January 19, 2018 at which time the bids will be publicly opened from the iCX SecureVault.
- 2. DESCRIPTION OF WORK.** The proposed improvement is identified and advertised for bids in the Invitation for Bids as:

**Contract No. 87681
LIVINGSTON County
Section 13-00052-01-HP (Dwight)
Project TE-00D3(098)
Route DWIGHT REG. (Center / Depot)
District 3 Construction Funds**

Cleaning and repainting of the soffit, fascia, and exterior wood parts, and cleaning and tuck pointing on the historic Dwight train depot in the Village of Dwight.

- 3. INSTRUCTIONS TO BIDDERS.** (a) This Notice, the invitation for bids, proposal and letter of award shall, together with all other documents in accordance with Article 101.09 of the Standard Specifications for Road and Bridge Construction, become part of the contract. Bidders are cautioned to read and examine carefully all documents, to make all required inspections, and to inquire or seek explanation of the same prior to submission of a bid.

(b) State law, and, if the work is to be paid wholly or in part with Federal-aid funds, Federal law requires the bidder to make various certifications as a part of the proposal and contract. By execution and submission of the proposal, the bidder makes the certification contained therein. A false or fraudulent certification shall, in addition to all other remedies provided by law, be a breach of contract and may result in termination of the contract.
- 4. AWARD CRITERIA AND REJECTION OF BIDS.** This contract will be awarded to the lowest responsive and responsible bidder considering conformity with the terms and conditions established by the Department in the rules, Invitation for Bids and contract documents. The issuance of plans and proposal forms for bidding based upon a prequalification rating shall not be the sole determinant of responsibility. The Department reserves the right to determine responsibility at the time of award, to reject any or all proposals, to readvertise the proposed improvement, and to waive technicalities.

By Order of the
Illinois Department of Transportation

Randall S. Blankenhorn,
Secretary

INDEX
FOR
SUPPLEMENTAL SPECIFICATIONS
AND RECURRING SPECIAL PROVISIONS

Adopted January 1, 2018

This index contains a listing of SUPPLEMENTAL SPECIFICATIONS, frequently used RECURRING SPECIAL PROVISIONS, and LOCAL ROADS AND STREETS RECURRING SPECIAL PROVISIONS.

ERRATA Standard Specifications for Road and Bridge Construction
(Adopted 4-1-16) (Revised 1-1-18)

SUPPLEMENTAL SPECIFICATIONS

<u>Std. Spec. Sec.</u>	<u>Page No.</u>
106 Control of Materials.....	1
403 Bituminous Surface Treatment (Class A-1, A-2, A-3)	2
404 Micro-Surfacing and Slurry Sealing	3
405 Cape Seal	14
420 Portland Cement Concrete Pavement	24
442 Pavement Patching.....	26
502 Excavation for Structures.....	27
503 Concrete Structures.....	29
504 Precast Concrete Structures.....	32
542 Pipe Culverts.....	33
586 Sand Backfill for Vaulted Abutments	34
630 Steel Plate Beam Guardrail	36
631 Traffic Barrier Terminals	39
670 Engineer's Field Office and Laboratory	40
701 Work Zone Traffic Control and Protection	41
704 Temporary Concrete Barrier	42
781 Raised Reflective Pavement Markers	44
888 Pedestrian Push-Button.....	45
1003 Fine Aggregates	46
1004 Coarse Aggregates.....	47
1006 Metals	50
1020 Portland Cement Concrete	51
1050 Poured Joint Sealers	53
1069 Pole and Tower.....	55
1077 Post and Foundation.....	56
1096 Pavement Markers.....	57
1101 General Equipment.....	58
1102 Hot-Mix Asphalt Equipment.....	59
1103 Portland Cement Concrete Equipment.....	61
1106 Work Zone Traffic Control Devices.....	63

CHECK SHEET
FOR
RECURRING SPECIAL PROVISIONS

The following RECURRING SPECIAL PROVISIONS indicated by an "X" are applicable to this contract and are included by reference:

RECURRING SPECIAL PROVISIONS

CHECK SHEET #	<u>PAGE NO.</u>
1 X Additional State Requirements for Federal-Aid Construction Contracts	64
2 X Subletting of Contracts (Federal-Aid Contracts)	67
3 X EEO	68
4 Specific EEO Responsibilities Non Federal-Aid Contracts	78
5 Required Provisions - State Contracts	83
6 Asbestos Bearing Pad Removal	89
7 Asbestos Waterproofing Membrane and Asbestos HMA Surface Removal	90
8 Temporary Stream Crossings and In-Stream Work Pads	91
9 Construction Layout Stakes Except for Bridges	92
10 Construction Layout Stakes	95
11 Use of Geotextile Fabric for Railroad Crossing	98
12 Subsealing of Concrete Pavements	100
13 Hot-Mix Asphalt Surface Correction	104
14 Pavement and Shoulder Resurfacing	106
15 Patching with Hot-Mix Asphalt Overlay Removal	107
16 Polymer Concrete	109
17 PVC Pipeliner	111
18 Bicycle Racks	112
19 Temporary Portable Bridge Traffic Signals	114
20 Work Zone Public Information Signs	116
21 Nighttime Inspection of Roadway Lighting	117
22 English Substitution of Metric Bolts	118
23 Calcium Chloride Accelerator for Portland Cement Concrete	119
24 Quality Control of Concrete Mixtures at the Plant	120
25 Quality Control/Quality Assurance of Concrete Mixtures	128
26 Digital Terrain Modeling for Earthwork Calculations	144
27 Reserved	146
28 Preventive Maintenance – Bituminous Surface Treatment (A-1)	147
29 Reserved	153
30 Reserved	154
31 Reserved	155
32 Temporary Raised Pavement Markers	156
33 Restoring Bridge Approach Pavements Using High-Density Foam	157
34 Portland Cement Concrete Inlay or Overlay	160
35 Portland Cement Concrete Partial Depth Hot-Mix Asphalt Patching	164

CHECK SHEET
FOR
LOCAL ROADS AND STREETS RECURRING SPECIAL PROVISIONS

The following LOCAL ROADS AND STREETS RECURRING SPECIAL PROVISIONS indicated by an "X" are applicable to this contract and are included by reference:

LOCAL ROADS AND STREETS RECURRING SPECIAL PROVISIONS

<u>CHECK SHEET #</u>	<u>PAGE NO.</u>
LRS 1 Reserved	168
LRS 2 <input type="checkbox"/> Furnished Excavation	169
LRS 3 <input checked="" type="checkbox"/> Work Zone Traffic Control Surveillance	170
LRS 4 <input type="checkbox"/> Flaggers in Work Zones	171
LRS 5 <input type="checkbox"/> Contract Claims	172
LRS 6 <input type="checkbox"/> Bidding Requirements and Conditions for Contract Proposals	173
LRS 7 <input type="checkbox"/> Bidding Requirements and Conditions for Material Proposals	179
LRS 8 Reserved.	185
LRS 9 <input type="checkbox"/> Bituminous Surface Treatments	186
LRS 10 Reserved	187
LRS 11 <input type="checkbox"/> Employment Practices	188
LRS 12 <input type="checkbox"/> Wages of Employees on Public Works	190
LRS 13 <input type="checkbox"/> Selection of Labor	192
LRS 14 <input type="checkbox"/> Paving Brick and Concrete Paver Pavements and Sidewalks	193
LRS 15 <input type="checkbox"/> Partial Payments	196
LRS 16 <input type="checkbox"/> Protests on Local Lettings	197
LRS 17 <input type="checkbox"/> Substance Abuse Prevention Program.....	198
LRS 18 <input type="checkbox"/> Multigrade Cold Mix Asphalt	199

TABLE OF CONTENTS

LOCATION OF PROJECT	1
DESCRIPTION OF PROJECT.....	1
STATUS OF UTILITIES TO BE ADJUSTED.....	1
PROTECTION OF EXISTING FACILITIES.....	1
FURNISHED HARDWARE	2
HARDWARE RESTORATION.....	4
WOOD RESTORATION	6
MASONRY CLEANING AND TUCKPOINTING.....	10
PAINTING.....	15
ACCESS DOORS.....	24
LEAD TEST REPORTS.....	30
LR 107-4 INSURANCE	32

BDE SPECIAL PROVISIONS

The following special provisions indicated by an "X" are applicable to this contract. An * indicates a new or revised special provision for the letting.

<u>File Name</u>	<u>Pg.</u>		<u>Special Provision Title</u>	<u>Effective</u>	<u>Revised</u>
80099			Accessible Pedestrian Signals (APS)	April 1, 2003	Jan. 1, 2014
80382			Adjusting Frames and Grates	April 1, 2017	
80274			Aggregate Subgrade Improvement	April 1, 2012	April 1, 2016
80192			Automated Flagger Assistance Device	Jan. 1, 2008	
80173			Bituminous Materials Cost Adjustments	Nov. 2, 2006	Aug. 1, 2017
80241			Bridge Demolition Debris	July 1, 2009	
50261			Building Removal-Case I (Non-Friable and Friable Asbestos)	Sept. 1, 1990	April 1, 2010
50481			Building Removal-Case II (Non-Friable Asbestos)	Sept. 1, 1990	April 1, 2010
50491			Building Removal-Case III (Friable Asbestos)	Sept. 1, 1990	April 1, 2010
50531			Building Removal-Case IV (No Asbestos)	Sept. 1, 1990	April 1, 2010
80366			Butt Joints	July 1, 2016	
80386			Calcium Aluminate Cement for Class PP-5 Concrete Patching	Nov. 1, 2017	
* 80396			Class A and B Patching	Jan. 1, 2018	
80384	33	X	Compensable Delay Costs	June 2, 2017	
80198			Completion Date (via calendar days)	April 1, 2008	
80199			Completion Date (via calendar days) Plus Working Days	April 1, 2008	
80293			Concrete Box Culverts with Skews > 30 Degrees and Design Fills ≤ 5 Feet	April 1, 2012	July 1, 2016
80311			Concrete End Sections for Pipe Culverts	Jan. 1, 2013	April 1, 2016
80277			Concrete Mix Design – Department Provided	Jan. 1, 2012	April 1, 2016
80261			Construction Air Quality – Diesel Retrofit	June 1, 2010	Nov. 1, 2014
80387			Contrast Preformed Plastic Pavement Marking	Nov. 1, 2017	
80029	37	X	Disadvantaged Business Enterprise Participation	Sept. 1, 2000	July 2, 2016
* 80378			Dowel Bar Inserter	Jan. 1, 2017	Jan. 1, 2018
80388	48	X	Equipment Parking and Storage	Nov. 1, 2017	
80229			Fuel Cost Adjustment	April 1, 2009	Aug. 1, 2017
80304			Grooving for Recessed Pavement Markings	Nov. 1, 2012	Nov. 1, 2017
80246			Hot-Mix Asphalt – Density Testing of Longitudinal Joints	Jan. 1, 2010	April 1, 2016
* 80347			Hot-Mix Asphalt – Pay for Performance Using Percent Within Limits - Jobsite Sampling	Nov. 1, 2014	Jan. 1, 2018
80383			Hot-Mix Asphalt – Quality Control for Performance	April 1, 2017	Nov. 1, 2017
80376			Hot-Mix Asphalt – Tack Coat	Nov. 1, 2016	
* 80392	49	X	Lights on Barricades	Jan. 1, 2018	
80336			Longitudinal Joint and Crack Patching	April 1, 2014	April 1, 2016
* 80393			Manholes, Valve Vaults, and Flat Slab Tops	Jan. 1, 2018	
80045			Material Transfer Device	June 15, 1999	Aug. 1, 2014
* 80394			Metal Flared End Section for Pipe Culverts	Jan. 1, 2018	
80165			Moisture Cured Urethane Paint System	Nov. 1, 2006	Jan. 1, 2010
80349			Pavement Marking Blackout Tape	Nov. 1, 2014	April 1, 2016
80371			Pavement Marking Removal	July 1, 2016	
* 80390	51	X	Payments to Subcontractors	Nov. 2, 2017	
80377			Portable Changeable Message Signs	Nov. 1, 2016	April 1, 2017
80389			Portland Cement Concrete	Nov. 1, 2017	
80359			Portland Cement Concrete Bridge Deck Curing	April 1, 2015	Nov. 1, 2017
80385			Portland Cement Concrete Sidewalk	Aug. 1, 2017	
80300			Preformed Plastic Pavement Marking Type D - Inlaid	April 1, 2012	April 1, 2016
80328	52	X	Progress Payments	Nov. 2, 2013	
34261			Railroad Protective Liability Insurance	Dec. 1, 1986	Jan. 1, 2006
80157			Railroad Protective Liability Insurance (5 and 10)	Jan. 1, 2006	

<u>File Name</u>	<u>Pg.</u>	<u>Special Provision Title</u>	<u>Effective</u>	<u>Revised</u>
* 80306		Reclaimed Asphalt Pavement (RAP) and Reclaimed Asphalt Shingles (RAS)	Nov. 1, 2012	Jan. 1, 2018
* 80395		Sloped Metal End Section for Pipe Culverts	Jan. 1, 2018	
80340		Speed Display Trailer	April 2, 2014	Jan. 1, 2017
80127		Steel Cost Adjustment	April 2, 2014	Aug. 1, 2017
* 80391	53	X Subcontractor Mobilization Payments	Nov. 2, 2017	
80317		Surface Testing of Hot-Mix Asphalt Overlays	Jan. 1, 2013	April 1, 2016
80298		Temporary Pavement Marking (NOTE: This special provision was previously named "Pavement Marking Tape Type IV".)	April 1, 2012	April 1, 2017
20338		Training Special Provision	Oct. 15, 1975	
* 80318		Traversable Pipe Grate for Concrete End Sections (Note: This special provision was previously named "Traversable Pipe Grate".)	Jan. 1, 2013	Jan. 1, 2018
80288		Warm Mix Asphalt	Jan. 1, 2012	April 1, 2016
80302	54	X Weekly DBE Trucking Reports	June 2, 2012	April 2, 2015
80071	55	X Working Days	Jan. 1, 2002	

The following special provisions are in the 2018 Supplemental Specifications and Recurring Special Provisions.

<u>File Name</u>	<u>Special Provision Title</u>	<u>New Location</u>	<u>Effective</u>	<u>Revised</u>
80368	Light Tower	Article 1069.08	July 1, 2016	
80369	Mast Arm Assembly and Pole	Article 1077.03(a)(1)	July 1, 2016	
80338	Portland Cement Concrete Partial Depth Hot-Mix Asphalt Patching	Recurring CS #35	April 1, 2014	April 1, 2016
80379	Steel Plate Beam Guardrail	Articles 630.02, 630.05, 630.06, and 630.08	Jan. 1, 2017	
80381	Traffic Barrier Terminal, Type 1 Special	Article 631.04	Jan. 1, 2017	
80380	Tubular Markers	Articles 701.03, 701.15, 701.18, and 1106.02	Jan. 1, 2017	

DWIGHT REGIONAL TRANSPORTATION
CENTER/DEPOT REHABILITATION
SECTION 13-00052-01-HP
VILLAGE OF DWIGHT
LIVINGSTON COUNTY
CONTRACT 87681

STATE OF ILLINOIS
SPECIAL PROVISIONS

The following Special Provisions supplement the “Standard Specifications for Road and Bridge Construction, Adopted April 1, 2016”, the latest edition of the “Manual on Uniform Traffic Control Devices for Streets and Highways”, and the “Manual of Test Procedures for Materials” in effect on the date of invitation for bids, and the “Supplemental Specifications and Recurring Special Provisions” indicated on the Check Sheet included herein, which apply to and govern the construction of Dwight Regional Transportation Center/Depot Rehabilitation, Section 13-00052-01-HP, in Livingston County, and in case of conflict with any part, or parts, of said Specifications, the said Special Provisions shall take precedence and shall govern.

LOCATION OF PROJECT

This project is located at 119 W. Main Street, Dwight, Illinois 60420. The gross and net project square foot area is 8750 square feet.

DESCRIPTION OF PROJECT

The work consists of the cleaning and repainting of the soffit, fascia, and exterior wooden posts and cleaning and tuck pointing of the masonry on the historic Dwight train depot.

STATUS OF UTILITIES TO BE ADJUSTED

(Effective January 1, 2007; Revised January 24, 2011)

Name & Address of Utility	Type	Location	Estimated Date Relocation Complete
There are no known utilities within the project area			

The above represents the best information of the Department and is only included for the convenience of the bidder. The applicable provisions of Section 102 and Articles 105.07, 107.20, 107.37, 107.38, 107.39, 107.40, and 108.02 of the Standard Specifications for Road and Bridge Construction shall apply.

PROTECTION OF EXISTING FACILITIES

The CONTRACTOR shall be responsible to protect all existing facilities within the work area. At the request of the ENGINEER, the CONTRACTOR shall repair any damage caused during the course of work, remove debris, or return the existing facilities to a condition equivalent to the condition at the time of the notice to proceed. The cost of this work shall be incidental to the contract.

FURNISHED HARDWARE

Description. This work shall consist of furnishing and installing new window and door hardware where necessary to replace inoperable or missing hardware. The furnished hardware shall be a historically correct and accurate replica of the existing hardware.

General.

- A. New hinges, locksets and cylinders at new and existing doors.
- B. Door closers at all doors where indicated on schedule.
- C. New panic hardware at entry doors.
- D. Kickplates, Door Holders, Dome Stops and Wall Stops as necessary.
- E. Pulleys and counter weights for windows.

1.1 Submittals

- A. Hardware Schedule: Indicate locations of each type of hardware.
- B. Product Data: Provide data on specified hardware. Submit manufacturer's parts lists and templates.

1.2 Operation and Maintenance Data

- A. Submit operation and maintenance data for each furnished hardware type.
- B. Include data on operating hardware, lubrication requirements, and inspection procedures related to preventative maintenance.

1.3 Performance Requirements

- A. Intent: The Contractor shall furnish and install all hardware in correct operating condition. Corrective measures will be required for any work short of this intent.
- B. Furnish proper hardware for openings as necessary for historic restoration and minimum regulations for accessibility compliance.

DWIGHT REGIONAL TRANSPORTATION
CENTER/DEPOT REHABILITATION
SECTION 13-00052-01-HP
VILLAGE OF DWIGHT
LIVINGSTON COUNTY
CONTRACT 87681

- C. Ensure that doors are operable from room side at all times by pressing panic bar or turning lever without keys, special knowledge, or effort unless specifically noted otherwise.
- D. Ensure that windows are operable with minimal effort.

Products.

2.1 Manufacturers

The Contractor shall select hardware from manufacturers that are capable of providing historically accurate replicas or reconditioned historic hardware. The manufacturer shall intend that the hardware is for use in commercial applications.

2.2 Keying

- A. All replaced locksets shall be keyed to match existing adjacent existing locks as directed by the Engineer. The Contractor shall notify the Engineer when like keying will not be possible.
- B. The Engineer shall be provided with six (6) key sets.

Execution.

3.1 Examination

- A. Verify the need and availability of historically accurate furnished hardware. Notify the Engineer immediately of any instance when accurate replicas or reconditioned hardware is not available.
- B. Beginning of restoration means acceptance of existing conditions.

3.2 Installation

- A. Mounting heights for hardware from finished floor to center line of hardware item:
 - 1. Match common existing heights
 - 2. Exit Devices (Crossbar): 36-13/16 inches
- B. Adjust door closers so that opening effort does not exceed 5 pounds for interior doors and 8.5 pounds for exterior doors.

- C. Avoid marring or damaging hardware or adjacent work. Defaced screw heads and marred or imperfect hardware will not be acceptable.
- D. Clean and lubricate hardware and adjust for correct operation.

Basis of Payment. This work shall not be paid separately but shall be included in the cost of adjacent ACCESS DOOR.

HARDWARE RESTORATION

Description. This work shall consist of the removal, cataloging, cleaning, reconditioning, and reinstalling existing hardware.

General.

1.1 Submittals

- A. Work description: Submit a description of hardware restoration operations. Include details of cleaning and reconditioning procedures for each type of hardware.
- B. Materials list and product data: Submit a complete list of products proposed for work of this section. List materials by manufacturer's name and model number with copies of product data for each item.
- C. Samples: Submit one cleaned and reconditioned sample of each type of hardware to the Engineer. These samples will serve as quality standards for all hardware to be restored.
- D. Verification of Subcontractor qualifications as required by 1.2 below.

1.2 Quality Assurance

Qualifications of Hardware Restoration Subcontractor

1. Shall have a minimum of five (5) years experience in the restoration or manufacture of historic metal work.
2. Shall be able to show a minimum of two (2) different examples of completed jobs demonstrating historical accuracy, high quality detail and artistic skill.
3. All work shall be performed by skilled personnel with not less than five years documented experience similar projects.
4. All work shall be performed by personnel whose qualifications have been submitted.

1.3 Delivery, Storage and Handling

- A. Package hardware items individually; label and identify package with door or window location.
- D. Protect hardware from theft by cataloging and storing in secure area.

1.4 Maintenance Materials

- A. Provide the Engineer with recommended maintenance procedures for each type of reconditioned hardware.

Products.

2.1 Materials

- A. General:
 - 1. All pieces shall be the exact size and configuration of the original in length, width, and thickness.
 - 2. Surface finish shall match examples of historic pieces as approved by the Engineer.
 - 3. Where modifications to original trim are required to interface with modern lock sets or other apparatus, such changes must not destroy or cause distortions that would interfere with the artistic quality of the original pieces.
- B. Installation Screws: Re-use existing screws for installing hardware items, unless otherwise directed. Where missing, screws shall match existing in size and type.

2.2 Keys and Keying

Keying of restored locks shall be coordinated with the Engineer. Existing locks that require rekeying shall be rekeyed such that doors accessing similar areas are keyed the same.

Execution.

3.1 Restoration Procedures

- A. Dismantle hardware and clean using non-abrasive techniques. Original surface markings and textures shall be preserved and exposed.
- B. Replace existing springs in door hardware with new springs.

DWIGHT REGIONAL TRANSPORTATION
CENTER/DEPOT REHABILITATION
SECTION 13-00052-01-HP
VILLAGE OF DWIGHT
LIVINGSTON COUNTY
CONTRACT 87681

- C. Restore all hardware as required to a fully functional condition. Inspect all parts and straighten all bent pieces. Quality and workmanship shall match approved sample.
- D. Existing locksets will not be rekeyed typically. Inform the Engineer where locking mechanisms are inadequate and require modification. Care needs to be taken if new cylinders are required and if modifications to antique trim are needed for interfacing with modern lock sets of other apparatus is necessary. Such changes must not destroy or cause distortions that would interfere with the artistic quality of the original pieces.
- E. Reinstall hardware to locations where removed, as noted on plans, or as directed by the Engineer.

3.2 Protection

Protect finished installations until final acceptance of the work.

3.3 Clean-up

- A. Any unused salvaged original hardware shall be delivered to and remain the property of the Owner.
- B. Upon completion of hardware restoration, remove tools, equipment, and other unnecessary materials from site. Return adjacent area to the condition which existed prior to the start of work.

Basis of Payment. This work shall not be paid separately but shall be included in the cost of adjacent ACCESS DOOR.

WOOD RESTORATION

Description. This work shall consist of the repair of damaged, deteriorated, and defective exterior wood to eliminate functional and visual defects. Where the damage or deterioration is too extensive to properly repair the wood, it shall be replaced with new wood to match original.

General.

1.1 Section Includes

- A. Epoxy repair of deteriorated wood

1.3 Submittals

- A. Product Data:
 - 1. Wood epoxy consolidant, epoxy fill, and adhesive.
- B. Field Samples
 - 1. Epoxy consolidation.
 - 2. Epoxy fill.
 - 3. Adhesive repair.

1.4 Product Delivery, Storage, and Handling

- A. Protect wood from exposure to weather at all times.
 - 1. Stack wood sufficiently above the ground to avoid exposure to wet or damp surfaces.
 - 2. Cover wood with waterproof sheeting to protect against inclement weather.
- B. Store wood in a manner that allows air circulation within and around stacks.
- C. Deliver materials to the site in the original and unopened containers, bearing packing labels describing the material type, name, and any catalogue numbers. Delivered materials must be identical to approved samples.

1.5 Quality Assurance

The Contractor for work of this section must have a minimum of 5 years experience in the satisfactory completion of projects involving wood restoration including consolidation, fill, and replication of new elements.

Products.

2.1 Consolidation Materials

- A. Liquid Epoxy Consolidant for consolidation of decayed wood:
 - 1. Use a low strength, low viscosity, moisture insensitive epoxy with a low modulus of elasticity specifically designed and marketed for wood restoration.
 - 2. Subject to compliance with requirements, provide one of the following:
 - a. LiquidWood, Abatron Inc., 5501 95th Avenue, Kenosha, WI 53144
Tel: (262) 653 2000 Web: <http://www.abatron.com>

DWIGHT REGIONAL TRANSPORTATION
CENTER/DEPOT REHABILITATION
SECTION 13-00052-01-HP
VILLAGE OF DWIGHT
LIVINGSTON COUNTY
CONTRACT 87681

- b. Flexible Epoxy Consolidant 100, ConServ Epoxy, Housecraft Associates, 7 Goodale Rd., Newton, NJ 07860 Tel: (973) 579 1112
Web: <http://www.conservepoxy.com>
 - c. West System 105 Epoxy Resin with 205 Hardener, Gougeon Brothers Inc., 100 Patterson Ave., P.O. Box 908, Bay City, MI 48707. Tel: (989) 684 7286. Web: <http://www.westsystem.com>
- B. Epoxy Fill for patching and resurfacing voids in wooden members:
- 1. Use a moisture insensitive, putty consistency epoxy compound with a low modulus of elasticity and inert filler that is specifically designed and marketed for wood restoration, and which may be cut and worked with wood working tools after curing.
 - 2. Subject to compliance with requirements, provide one of the following:
 - a. WoodEpoxy, Abatron Inc., 5501 95th Avenue, Kenosha, WI 53144. Tel: (262) 653 2000. Web: <http://www.abatron.com>
 - b. Flexible Epoxy Patch 200, ConServ Epoxy, Housecraft Associates, 7 Goodale Rd., Newton, NJ 07860. Tel: (973) 579 1112. Web: <http://www.conservepoxy.com>
 - c. West System 105 Epoxy Resin with 407, Gougeon Brothers Inc., 100 Patterson Ave., P.O. Box 908, Bay City, MI 48707. Tel: (989) 684 7286. Web: <http://www.westsystem.com>

2.2 Other Materials

All other materials required for work of this Section shall be selected by the Contractor subject to the approval of the Engineer.

2.3 Finishes

Finishes shall be completed in accordance with the painting Special Provision.

2.4 Fabrication

- A. Match original wood species and grade. Fabricate architectural woodwork to match original profiles.
- B. Before proceeding with fabrication of woodwork required to be fitted to other construction, obtain measurements and verify dimensions.

Execution.

3.1 Verification of Conditions

- A. Prepare all existing painted surfaces, using methods described in the painting Special Provision.
- B. Prior to beginning work, examine all surfaces to be repaired by epoxy consolidation or resurfacing. Correct any defects in the substrate that will affect the proper execution, stability, or longevity of the epoxy repair work. Epoxy repairs with defects that mar the appearance of finished work or which is otherwise defective will be rejected.

3.2 Application of Epoxy

- A. Protection and Preparation
 - 1. Protect all surrounding areas prior to start of work.
 - 2. Wear protective clothing, goggles, gloves and barrier creams as recommended by the manufacturer and as may be required by governmental regulations.
 - 3. Do not begin epoxy consolidation and repair prior to approval of all submittals required by this section.
 - 4. Do not begin epoxy consolidation and repair prior to placement of all protective barriers.
- B. Epoxy Consolidation for decayed wood trim:
 - 1. Mixing: Use extreme care and follow manufacturer's written mixing and storage instructions for each product. If written instructions are not available or do not apply to the project conditions, consult the manufacturer's technical representative for specific written recommendations before proceeding with the work. Do not use products that have passed the manufacturer's shelf life.
 - 2. Prepare surface to be consolidated by removing all visible dirt and debris. To prevent leakage, temporarily plug large holes or cracks with modeling clay or wax. Surfaces should be dry before consolidation begins to achieve optimum results.
 - 3. Drill 1/8" diameter holes across the end grain at an oblique angle, staggered at approximately 2" intervals, in areas of wood deterioration.
 - 4. Pour epoxy resin into each area to be consolidated until the void has been filled. Top off voids as required as epoxy is absorbed into the wood. To avoid trapping air within the wood, work from one end of the piece to the other.

DWIGHT REGIONAL TRANSPORTATION
CENTER/DEPOT REHABILITATION
SECTION 13-00052-01-HP
VILLAGE OF DWIGHT
LIVINGSTON COUNTY
CONTRACT 87681

5. Cure time will vary according to ambient conditions. Follow manufacturer's instructions for curing. Protect consolidated areas from damage until fully cured.
- C. Epoxy Fill for patching and resurfacing deteriorated areas.
1. Use extreme care and follow manufacturer's written mixing and storage instructions for each product. If written instructions are not available or do not apply to the project conditions, consult the manufacturer's technical representative for specific written recommendations before proceeding with the work.
 2. Prepare surface by removing all dirt and debris. Surfaces must be clean and dry prior to repair.
 3. Fill voids, cracks, gouges and depressions with layers of epoxy at the locations indicated as directed by the Engineer. Slightly overfill holes to allow for sanding or planing of surface. Where surface build up is required to achieve positive drainage, apply additional layers of epoxy as necessary.
 4. After appropriate cure time, hand sand or plane surface until smooth to achieve original profile.
 5. Allow adequate curing time for consolidant before applying resurfacing compound.
 6. Protect resurfaced areas from damage until fully cured.
 7. Prime and paint as specified in the painting Special Provision.

Basis of Payment. Work under this specification will not be paid for separately but shall be included in the cost of the adjacent PAINTING, or ACCESS DOORS.

MASONRY CLEANING AND TUCKPOINTING

Description. This work shall consist of the tuckpointing and cleaning of the existing exterior masonry at locatoins as directed by the Engineer. This work shall be completed on the Dwight Train Depot and adjacent Freight Office. The CONTRACTOR shall refer to the schematic information provided in the Contract Documents.

The Contractor shall assume 25% of the joints shall require tuckpointing. Cleaning will only be required for the masonry in the vicinity of tuckpointed masonry. The Contractor shall further assume no brick or stone replacement will be required.

General Requirements.

1.1 Summary

- A. Section Includes: Mortar for re-pointing masonry joints at the existing exterior masonry joints.
- B. The new mortar must match the existing historic mortar in color, texture, and tooling.
- C. Masonry restoration work includes the following:
 - 1. Retuckpointing of masonry joints.
 - 2. Final cleaning of masonry.

1.2 Quality Assurance

Repointing: Prepare 2 sample areas of approximately 2 feet high by 2 feet wide for each type of repointing required, one for demonstrating methods and quality of workmanship expected in removal of mortar from joints and the other for demonstrating quality of materials and workmanship expected in pointing mortar joints appearance to adjacent existing joints. The intent of the new pointing work is to match cleaned existing mortar. Newly pointed areas should be consistent with existing adjacent mortar joints for color and texture.

1.3 Submittals

- A. Submit manufacturer's product data in accordance with the General Provisions.
- B. Samples:
 - 1. Submit two samples of mortar, illustrating mortar color and color range.
- C. Design Data:
 - 1. Submit design mix when Property specification of ASTM C270 is to be used, required environmental conditions, and admixture limitations.
- D. Test Reports:
 - 1. Submit reports on mortar indicating conformance of mortar to property requirements of ASTM C270 for aggregate ratio and water content and consistency.
 - 2. Submit reports on grout indicating conformance of grout to property requirements of ASTM C476.
- E. Manufacturer's Installation Instructions:
 - 1. Submit premix mortar manufacturer's installation instructions.

- F. Manufacturer's Certificate:
 - 1. Certify products meet or exceed specified requirements.

1.4 Conditions

- A. Do not repoint mortar joints or repair masonry unless air temperatures are between 40 deg. F and 90 deg. F and will remain so for at least 48 hours after completion of work.
- B. Prevent mortar used in repointing and repair work from staining faces of surrounding masonry and other surfaces.
- C. Protect sills, ledges, projections and pedestrians from mortar droppings.

1.5 Sequencing and Handling

- A. Conference:
 - 1. Convene a pre-installation conference with the Engineer to establish procedures to maintain optimum working conditions, coordinate this work with related and adjacent work, and discuss sequencing.
- B. Rake or cut out existing mortar joints as indicated to be repointed.

Products

2.1 Mortar and Masonry Grout

- A. As accurate replication mixes are difficult to formulate, the type and quantity of materials are essential to ensure on-site reproduction.
- B. Manufacturers:
 - 1. Blue Circle Cement.
 - 2. Lehigh Portland Cement.
 - 3. Quikrete Companies.
 - 4. Solomon Colors.

2.2 Components

- A. Portland Cement: ASTM C150, Type I, gray color; to match existing.
- B. Mortar Sand: ASTM C144, unless otherwise indicated.

DWIGHT REGIONAL TRANSPORTATION
CENTER/DEPOT REHABILITATION
SECTION 13-00052-01-HP
VILLAGE OF DWIGHT
LIVINGSTON COUNTY
CONTRACT 87681

1. Color: Provide natural sand; of color necessary to produce required mortar color.
 2. For the repointing mortar, provide sand with rounded edges.
 3. Match size, texture, and gradation of existing mortar and as closely as possible. Blend several sands, if necessary, to achieve suitable match.
- C. Mortar Aggregate:
1. ASTM C144, standard masonry type.
- D. Hydrated Lime:
1. ASTM C207, Type N.
- E. Quicklime:
1. ASTM C5, non-hydraulic type.
- F. Grout Aggregate:
1. ASTM C404, fine.
- G. Water:
1. Clean and potable.
- H. Mortar Color:
1. To match existing.
- I. Calcium chloride is not permitted.

1.3 Mortar Mixes

- A. Measurement and Mixing: Measure cementitious and aggregate material in a dry condition by volume or equivalent weight. Do not measure by shovel, use known measures. Mix materials in a clean mechanical mortar mixer. If color is required, mix in with dry material.
- B. Mixing Pointing Mortar: Thoroughly mix cementitious and aggregate, color if required, materials together before adding any water. Maintain mortar in the dampened condition for 1 to 2 hours. Add water in small portions until mortar of desired consistency is reached. Use mortar within 30 minutes of final mixing.

Execution.

3.1 Repointing Masonry

- A. Rake or grind out mortar joints not less than 1/2 inch in depth or less than that required to expose sound, unweathered mortar. Contractor shall show a satisfactory Quality Control Program and demonstrated ability of the operators to use tools without damage to masonry, or widening of joints. Quality Control Program shall include provisions for supervising performance and preventing damage due to worker fatigue.
- B. Rinse masonry joint surfaces with water to remove dust and mortar particles. Time application of rinsing so that at time of pointing, joint surfaces are damp but free of standing water. For best practices, if rinse water has dried, dampen masonry joint surfaces before pointing.
- C. Tuckpoint mortar joints as follows:
 - 1. Tuckpoint mortar joints starting at one end and working away from starting area (this will ensure mortar joints are fully packed and no voids, air pockets are in mortar).
 - 2. Once area is complete, final tool (strike) mortar joints in opposite direction ensuring mortar joints are fully packed and tool (strike) to final appearance. Joints shall match existing joints as closely as possible, unless otherwise directed by Engineer or Owner.
 - 3. Take care not to spread mortar over edges onto exposed masonry surfaces or to featheredge mortar. Remove excess mortar from edge of joint by brushing.

3.2 Field Quality Control

- A. Establishing Mortar Mix:
 - 1. In accordance with ASTM C270.
- B. Testing of Mortar Mix:
 - 1. In accordance with ASTM C780.
- C. Testing of Grout Mix:
 - 1. In accordance with ASTM C1019.

3.3 Final Cleaning

- A. After mortar is fully hardened, thoroughly clean exposed masonry surfaces of excess mortar and foreign matter; use wood scrapers, stiff-nylon or fiber brushes, and clean water, spray applied at low pressure.
 - 1. Do not use metal scrapers.
 - 2. Use appropriate products.
- B. Wash adjacent woodwork and other non-masonry surfaces. Use detergent and soft brushes or cloths.
- C. Clean masonry debris from roof; remove debris from gutters and downspouts. Rinse off roof and flush gutter and downspouts.
- D. Sweep and rake adjacent pavement and grounds to remove masonry debris. Where necessary, pressure wash surfaces to remove mortar, dust, dirt and stains.
- E. Use of muriatic acid for cleaning is prohibited.

Basis of Payment. This work shall be paid for at the Lump Sum price for MASONRY CLEANING AND TUCKPOINTING. This price shall include all necessary material, labor, and equipment required to remove unsuitable mortar, clean the joints repoint, and perform the final cleaning of the masonry and surrounding site. All protection, handling, and disposal of wastes generated shall be included in this price.

PAINTING

Description. This work shall consist of the cleaning and painting of the existing exterior surfaces including but not limited to soffits, fascia, canopy, ceiling, windows, doors, trim, and exterior wooden post. Where necessary the existing wood surfaces shall be restored to a condition such that surfaces will be suitable for repainting. This work shall be completed on the Dwight Train Depot and adjacent Freight Office. The CONTRACTOR shall refer to the schematic information provided in the Contract Documents.

Construction Requirements.

1.1 General Requirements

- A. The extent of Exterior Painting includes, but is not limited to the following:
 - 1. All work to conform to current OSHA and EPA standards for lead paint removal.

DWIGHT REGIONAL TRANSPORTATION
CENTER/DEPOT REHABILITATION
SECTION 13-00052-01-HP
VILLAGE OF DWIGHT
LIVINGSTON COUNTY
CONTRACT 87681

2. Assess substrate and determine if conditions require or may otherwise adversely impact the success of the project.
 3. Wash all surfaces to be painted using Engineer-approved solution.
 4. Scrape loose paint by hand; retain paint where directed by Engineer.
 5. Apply one coat of primer using method best suited for application; finish by brush. Caulk all joints or gaps 1/8" or less.
 6. Lightly sand rough or fuzzed areas by hand.
 7. Restore wood that has deteriorated such that it has become an unsuitable substrate for painting.
 8. Apply at least two finish coat of paint using method best suited for application; finish by brush. Ensure full coverage and uniform color by applying additional coats as required.
 9. Review areas indicating stains due to corrosion of hardware.
 10. Remove, label, assess, paint and reinstall items where directed.
- B. The intent of this work shall be to provide a very high quality, durable paint finish, while preventing any removal, destruction or adverse effects to the historic substrate.
- C. The work includes preparation and painting with a three coat system (prime and finish coating) of exterior exposed materials and surfaces of all exterior surfaces and finishes.
- D. Paint as used herein means all coating systems materials, including primers, emulsions, enamels, sealers, and other applied materials used as a primer or finish coating.
- E. A coat refers to an application of paint at the required millimeter thickness for each coating applied, as specified by the manufacturer.
- F. Paint all exposed surfaces whether or not colors are designated, except where the natural (unpainted) finish of the materials is obviously intended and specifically noted as a surface not to be painted. Where items or surfaces are not specifically mentioned, consult with Engineer for direction as these areas will likely be painted the same as adjacent areas or material.

1.2 Temporary Facilities and Construction Aids

- A. Temporary Facilities: Contractor is responsible for installation and maintenance of portable toilet; location to be determined with Owner prior to start of project. Portable toilet must be removed within one week following the accepted completion of the work.

DWIGHT REGIONAL TRANSPORTATION
CENTER/DEPOT REHABILITATION
SECTION 13-00052-01-HP
VILLAGE OF DWIGHT
LIVINGSTON COUNTY
CONTRACT 87681

- B. Scaffolding:
1. Contractor to set up OSHA approved staging if necessary at elevations as outlined in a pre-determined schedule. The schedule shall be subject to the approval of the Engineer.
 2. Scaffolding will remain in place until the accepted completion of the job or a specific portion of the job, and removed within one week of accepted completion of the work.
 3. Any holes made for attached scaffolding to the structure are to be filled and repaired in a method approved by the Engineer.
 4. Dumpster: Contractor to coordinate the installation and removal of construction dumpster for debris. Approved location of dumpster onsite to be determined by Engineer and Owner.

1.3 Project Management

- A. Documentation and Communication: Contractor shall create reports based on details uncovered during the Project work not already outlined in the specifications. Work shall be photographed by Contractor when Engineer is not on-site. Photographs shall be at least 300 dpi. Details and suggested repair options shall be photo documented and submitted to the Engineer for review.
- B. All uncovered work not determined to be part of the original contract shall be addressed by an on-site meeting with Engineer. No work requiring additional cost to the project shall be completed without prior approval by the Engineer/Owner.

1.4 Substitutions

Engineer's Approval Required: Do not substitute materials, equipment or methods unless such substitution has been specifically approved in writing for this work by the Engineer.

1.5 Submittals

- A. Paint Analysis: Prior to beginning work, the Contractor shall consult a paint analysis specialist. The paint analysis shall determine the earliest extant finish type and color based on the Munsell Color System. The color shall be selected based on the report and shall be approved by the Engineer. The cost of this work shall be included in the cost of PAINTING.
- B. Submit manufacturer's literature and data on any relevant materials.
- C. Submit manufacturer's warranty information.

DWIGHT REGIONAL TRANSPORTATION
CENTER/DEPOT REHABILITATION
SECTION 13-00052-01-HP
VILLAGE OF DWIGHT
LIVINGSTON COUNTY
CONTRACT 87681

- D. At project completion, a minimum of 1 quart of each type and color of paint/primer from the same production run (batch mix) used will be left, properly labeled and identified, and dated for Owner's later use in maintenance. Store where directed. Color formulas and vendor information for each color used will also be given to Owner for future reference.

1.6 Protection

- A. Perform all work that disturbs lead-containing paint (LCP), handle all material that involves lead-containing paint, and transport and dispose of all lead-containing paint and residue in compliance with all applicable federal, state, and local laws and regulations for identification, removal, labeling, handling, containerization, transportation, and disposal of lead-containing material. This includes compliance with all applicable regulations including, but not limited to, the following:
1. Illinois Environmental Protection Agency
 2. Illinois Department of Labor
 3. Illinois Department of Health
 4. Federal OSHA
 5. Federal Environmental Protection Agency
 6. Comply with requirements of governmental agencies having jurisdiction over this work, including compliance with volatile organic compounds/volatile organic solvent regulations and abrasive surface preparation.
- A report of LCP testing can be found as an appendix to these contract documents. The Contractor shall familiarize himself with this information and make appropriate accommodations for the handling of this material. All labor, material, and equipment necessary to handle LCP shall be included in the cost of Painting.
- B. Provide protection for roofs, entrances, windows, walls and landscape as necessary to prevent damage during entire course of work of this Section.
- C. Repair or replace to Engineer's satisfaction all building elements and materials damaged by weather resulting from openings that did not sufficiently exclude weather at no additional cost.
- D. Provide protective barriers to ensure the safety of visitors and site staff. Take all the safety of passersby near scaffolding and work areas. This includes setting up codes and safety tape as a barrier to block off areas as needed.
- E. Take all necessary precautions to protect all persons, whether engaged in work of this Section or not, from all hazards of any kind associated with the work of this Section.
- F. Take all necessary precautions to prevent fire and spread of fire.

DWIGHT REGIONAL TRANSPORTATION
CENTER/DEPOT REHABILITATION
SECTION 13-00052-01-HP
VILLAGE OF DWIGHT
LIVINGSTON COUNTY
CONTRACT 87681

- G. All MSDS are to be available and copies kept on-site until Project completion. All persons using materials are to be familiar with information contained within the documents and proper safety precautions are to be followed.

1.7 Quality Assurance

- A. General Painting Contractor shall be skilled and experienced in this type of painting and equipped to perform workmanship in accordance with industry standards, manufacturer's specifications and all applicable building codes. Employ only tradespeople experienced in painting.
- B. Materials: Obtain all paint from one manufacturer, at the same time, and from the same distributor to ensure homogeneity of manufacture and formula.
 - 1. All materials will be used according to manufacturer's specifications and standard industry practices.
 - 2. Contractor shall ensure that all project materials are protected from adverse weather during construction.
- C. Prior to beginning any work, evaluate substrate and notify Engineer of conditions which require repair or may otherwise adversely impact the success of the project.

1.8 Product Handling

- A. All products shall be stored and installed in a manner which upholds the manufacturer's warranty unless directed to do otherwise by the Engineer.
- B. All materials will be delivered to the site in their original containers bearing manufacturer's label and instructions.

1.9 Job Conditions

- A. Pre-Work Conference: Prior to the installation of any work, meet at the project site with the Contractor and the Engineer to discuss the project. Review foreseeable method and procedures related to the painting work, including but not necessarily limited to the following:
 - 1. Review project requirements (Specifications and other Contract Documents).
 - 2. Review required submittals.
 - 3. Review availability of materials, tradespeople, equipment and facilities needed to make progress and avoid delays.
 - 4. Review weather and forecasted weather conditions, and procedures for coping with unfavorable conditions, including the possibility of temporary coverings.

DWIGHT REGIONAL TRANSPORTATION
CENTER/DEPOT REHABILITATION
SECTION 13-00052-01-HP
VILLAGE OF DWIGHT
LIVINGSTON COUNTY
CONTRACT 87681

5. Review procedures needed for protection of the building during the remainder of the construction period.
 6. Review staging strategy if required.
 7. Verify all quantities, dimensions and materials in the field.
- B. Weather Condition Limitations: Proceed with work only when weather conditions will permit unrestricted use of materials, ensure quality control and ensure water will not enter the building envelope. All installation procedures must comply with standard construction practices and manufacturer's recommendations where applicable.
- C. Examination of Substrate: The Contractor must examine the substrate and other conditions within which the repairs are to be performed, and notify the Engineer of any unsatisfactory conditions. Do not proceed with any work until unsatisfactory conditions have been corrected in an acceptable manner and approved by the Engineer.

Products.

2.1 Materials

- A. Cleaning:
1. Perform preparation and cleaning procedures in accordance with coating manufacturer's instructions and as herein specified, for each substrate condition and paint type. Prior to full scale cleaning, use test panels to determine the effectiveness of cleaning methods is recommended.
 2. Clean surfaces to be painted before applying paint or surface treatments.
 - a. Do not use bleach by large scale spray application since bleach can cause significant damage to historic materials and surrounding landscape plantings. Surfaces shall be free of loose and peeling paint, or other foreign substances. Proper methods should be applied to capture lead paint chips during removal. Wash surfaces to be painted with mild detergents. Remove all dirt and other foreign matter prior to paint application using the gentlest method possible to achieve positive results. Do not use metal bristled brushes or high pressure water.
 - b. Remove Chalking Paint: Wash surfaces with solution of water and trisodium phosphate.
 - c. Mold and mildew can be effectively removed by washing with a solution of water and trisodium phosphate.

DWIGHT REGIONAL TRANSPORTATION
CENTER/DEPOT REHABILITATION
SECTION 13-00052-01-HP
VILLAGE OF DWIGHT
LIVINGSTON COUNTY
CONTRACT 87681

- B. Paint Removal: Mechanical: Scrape with hand tools all surfaces exhibiting areas of loose or peeling paint, and areas of adhesion failure.
- C. Wood Treatment:
 - 1. For painted surfaces, fill holes and imperfections in finish surfaces with putty wood-filler after priming. Follow manufacturer specifications as to specific applications of filler. Sandpaper smooth and profile as required when dried.
 - 2. Each coat shall be checked and any imperfections, faulty material, poor workmanship, etc. shall be corrected before applying succeeding coat.
- D. Primer: All primer shall be obtained from the same vendor at the same time.
- E. Caulk: Should caulk be necessary, it shall be latex based and approved by the Engineer. The cost of necessary caulk shall be included in the cost of painting.
- F. Finish Coat – Exterior:
 - 1. Manufacturers:
 - a. Sherwin-Williams
 - b. Behr
 - c. Benjamin Moore
 - d. Pratt & Lambert
 - e. Pittsburgh Paint
 - 2. Materials – Exterior Finish Coats: Semi-gloss acrylic enamel, factory-formulated, semi-gloss waterborne acrylic – latex enamel for exterior application.

Execution.

3.1 General Procedures

- A. Perform preparations and cleaning procedures in strict accordance with manufacturer's instructions and as herein specified, for each substrate condition. Progression of work from preparation to priming and painting shall proceed in a timely fashion so as to not allow time for bared, prepped, or primed, unfinished or incompletely finished substrate to dwell unnecessarily in the weather before receiving finish coats.
- B. Take all necessary precautions to protect building elements and finishes from damage by precipitation during work of this Section.
- C. Every effort shall be made to accommodate the reasonable needs of the site personnel in relation to scheduling.

DWIGHT REGIONAL TRANSPORTATION
CENTER/DEPOT REHABILITATION
SECTION 13-00052-01-HP
VILLAGE OF DWIGHT
LIVINGSTON COUNTY
CONTRACT 87681

- D. Every effort shall be made to protect any and all landscaping from harm.
- E. Do not apply material when temperature of surface and surrounding areas is below 50 degrees F, unless otherwise permitted by manufacturer's instructions.
- F. Do not apply paint in snow, rain, fog or mist; or when the relative humidity exceeds 85%; or to damp or wet surfaces. The moisture content of the surfaces to be painted must be 13% or less. Moisture content will be tested in several areas of each elevation prior to the application of any paint materials.
- G. All manufacturers' printed instructions are to be followed unless otherwise instructed in this document or by the Engineer.
- H. Perform all work that disturbs lead-containing paint, handle all material that involves lead-containing paint, and transport and dispose of all lead-containing paint and residue in compliance with all applicable federal, state and local laws and regulations for identification, removal, labeling, handling, containerization, transportation, and disposal of lead-containing material.
- I. All materials shall comply with fire safety standards. Take all necessary precautions to prevent fire and spread of fire.
- J. The site shall be kept clean and free of debris, paint chips, and all equipment; the work area shall be cleaned in an orderly fashion before work completion daily.

3.2 Evaluate Substrate

- A. Thoroughly assess substrate to determine if any carpentry repairs or wood restorations are necessary prior to beginning the painting project.
- B. Notify Engineer if repairs are suggested and identify all locations for review. Repairs that are deemed necessary shall be completed in accordance with the wood restoration specification. This work will not be paid separately, but shall be included in the cost of painting.
- C. Contractor should not perform any repairs prior to consultation with Engineer.

3.3 Priming

- A. Primer shall be compatible make and composition as finish paint. No substitutions will be accepted without written approval from Engineer.

DWIGHT REGIONAL TRANSPORTATION
CENTER/DEPOT REHABILITATION
SECTION 13-00052-01-HP
VILLAGE OF DWIGHT
LIVINGSTON COUNTY
CONTRACT 87681

- B. Apply primer in accordance with manufacturer's directions. Materials to be applied by method best suited for application: brush, roller, or spray.
- C. Apply each coat at not less than recommended spreading rate to provide the dry film millimeter thickness specified by the manufacturer for each paint coating.
- D. Allow at least 4-24 hours dry time (depending on manufacturer's specification) before proceeding with any additional paint application. Coating failure may result by application of additional paint over non-dry film.
- E. Apply additional coating where undercoats, stains, or other conditions show through paint film, until uniform finish color is achieved.
- F. Exposed nail heads to be spot primed with a rust inhibitor.
- G. New wood shall be primed on all sides (especially end grain) prior to installation or fabrication of structure.

3.4 Finish Paint

- A. Upon completion of previous treatments, inspect all surfaces prior to paint application. Lightly hand sand rough or fuzzed areas. Care should be taken not to expose substrate or re-priming will be necessary.
- B. Apply as specified in contract documents and according to manufacturer's directions; film thickness as per material specifications. Upon completion of coat, inspect all surfaces and allow to dry before applying a second coating.
- C. Apply additional paint coating where undercoats, stains, or other conditions show through paint film, until uniform finish color is achieved.

3.5 Clean-up

- A. Perform operations as to keep work areas and premises clean, and free from accumulation of scrap materials, debris and other surplus material (at the end of every workday).
- B. Remove all debris from site and dispose of properly in accordance with all EPA regulations. Recycle debris when possible.
- C. No materials or debris will be permitted to drop free, but shall be removed by use of material hoists, rubbish chutes, or other method approved by the Engineer.

DWIGHT REGIONAL TRANSPORTATION
CENTER/DEPOT REHABILITATION
SECTION 13-00052-01-HP
VILLAGE OF DWIGHT
LIVINGSTON COUNTY
CONTRACT 87681

- D. No materials or debris will be permitted to be passed through the finished exterior without proper protection in a manner approved by the Engineer.
- E. The landscape is to be left in as-found or better condition upon the completion of the project.

Basis of Payment. This work shall be paid for at the Lump Sum price for PAINTING. This price shall include all necessary material, labor, and equipment necessary to clean, restore and paint exterior painted surfaces as shown on the provided schematic. All protection, handling, and disposal of waste generated, including Lead Containing Paint, shall be included in this price.

ACCESS DOORS

Description. This work consists of the restoration and repair of the existing exterior wood doors and frames and replacement of non-wood door of the historic Dwight depot.

General.

1.1 Quality Assurance

- A. Contractor Qualifications: All work shall be performed by skilled Subcontractors having not less than five (5) years satisfactory experience in comparable wood door restoration including work on at least two (2) projects similar in scope and scale to this Project. Submit references with name of contact person and telephone number for the two (2) submitted similar projects. Only skilled workers who are familiar and experienced with the methods specified for consolidation, fill, and replication of new elements are to be used for wood door and frame restoration.
- B. At the preconstruction meeting submit qualifications and experience of all lead personnel scheduled for work on this project. List project manager or foreman's name and experience relative to this Project. All work shall be performed by persons whose qualifications have been submitted.

1.2 Submittals

- A. Shop Drawings - Submit shop drawings of all door assemblies requiring work. Show all details of types of materials, size of members, profiles, methods of securing and fastening members to adjacent work, and a complete schedule of work showing types, finishes, locations, and dimensions.
- B. Restoration and Installation
 - 1. Submit proposed methods for preparation, protection, installation, and finishing of all existing wood door assemblies to Architect for review prior

DWIGHT REGIONAL TRANSPORTATION
CENTER/DEPOT REHABILITATION
SECTION 13-00052-01-HP
VILLAGE OF DWIGHT
LIVINGSTON COUNTY
CONTRACT 87681

to commencement of work. Include detailed description of method, techniques, tools, and other pertinent information regarding repair and restoration of wood door assemblies.

2. Submit inventory of salvaged doors and door frame assemblies. Identify door type and specific location for installation.
- C. Replacement: The Contractor shall assume that two (2) doors will be deteriorated beyond salvage or historically inaccurate. The Contractor shall provide a historically accurate reproduction of the door in this instance. This work shall be paid as ACCESS DOORS.
- D. Field Samples: Prior to beginning work and after manufacturer's data and initial samples have been approved, prepare a mock-up field sample for wood door installation and repair, including wood dutchmen and epoxy repairs. The approved sample shall meet or exceed the level of craftsmanship as exhibited in the mock-up installation which will serve as a standard for acceptable technique and appearance for all wood doors.
- E. Paint Analysis: Prior to beginning work, the Contractor shall consult a paint analysis specialist. The paint analysis shall determine the earliest extant finish type and color based on the Munsell Color System. The color shall be selected based on the report and shall be approved by the Engineer. The cost of this work shall be included in the cost of ACCESS DOORS.

1.3 Product Delivery, Storage, and Handling

- A. Keep wood doors protected from exposure to weather at all times.
 1. Stack wood doors sufficiently above the ground to avoid exposure to wet or damp surfaces.
 2. Cover wood doors with temporary polyethylene or other similar waterproof sheeting.
- B. Store wood doors to provide for air circulation within and around stacks.
- C. Deliver materials to the site in protective packaging bearing labels as to cataloguing and type of material. Delivered materials shall be identical to approved samples.

1.4 Job Conditions

- A. Install doors and frames in an environment free of detrimental humidity. And construction activity.

Products.

2.1 Materials

- A. Adhesives
 - A. Exterior grade wood PVA Type III Glue with an ANSI/HPVA Type II water resistance.

- B. Paint Removers
 - 1. Chemical Paint removers are to comply with all local, state, and federal authorities having jurisdiction.
 - 2. The use of infrared stripping on site will be allowed.
 - 3. Mechanical stripping methods will be allowed if performed in compliance with EPA and OSHA regulations.
 - 4. No heat guns will be used on existing paint.

- C. Replacement wood materials
 - 1. Any wood replaced shall be done so with the same species as original making every effort to match the age, grain direction and growth rate of the piece it is replacing.

- D. Epoxies – liquid consolidant
 - 1. Liquid wood consolidant shall consist of a two-part, low-viscosity liquid epoxy designed for wood restoration. Design criteria standards and evaluations of acceptable alternates will be based on Abatron Liquid Wood.
 - 2. Acceptable Manufacturers:
 - a. Abatron, Inc
 - b. Advanced Repair Technology
 - c. Gougeon Brothers, Inc.
 - d. Polymeric Systems, Inc.
 - e. West System
 - f. Wood Care Systems

- E. Epoxies – Paste
 - 1. Epoxy paste shall consist of a two-part, thixotropic paste epoxy designed for wood restoration. Design criteria standards and evaluations of acceptable alternates will be based on Abatron WoodEpox.
 - 2. Acceptable Manufacturers:
 - a. Abatron, Inc.
 - b. Advanced Repair Technology
 - c. Gougeon Brothers, Inc
 - d. Polymeric Systems, Inc

DWIGHT REGIONAL TRANSPORTATION
CENTER/DEPOT REHABILITATION
SECTION 13-00052-01-HP
VILLAGE OF DWIGHT
LIVINGSTON COUNTY
CONTRACT 87681

- e. West System
 - f. Wood Care Systems
- F. Wood Preservative
- 1. Acceptable manufacturers and products include:
 - a. Nisus Corporation; Boracare
- G. Hardware
- 1. Replacement hardware shall match original in design, material, and finish. Acceptable Manufacturers include:
 - a. Ball and Ball
 - b. Bronze Craft Corporation
 - c. Craftsmen Hardware Co., LTD
 - d. Phelps Company Architectural Specialties
 - e. Sun Valley Bronze - Hailey, ID
- H. Finishes
- 1. Primer - Alkyd based Primer
 - 2. Finish - Latex Exterior
 - 3. Shop Finishing methods - Spray applied
 - 4. Colors shall be selected based on Paint Analysis Specialist Report and approved by the Engineer.

Execution.

3.1 Examination

- A. Prior to commencement of work, examine all doors indicated for repair and report to the Engineer any doors which in the Contractor's opinion require replacement rather than repair. Engineer to re-examine any such doors and to approve or disapprove any proposed revisions.
- B. All salvaged doors and frames to be stripped of paint and coatings. Installed salvaged material shall be free of excessive gouges. If salvaged material cannot be reinstalled, as approved by Engineer, contractor shall provide new material to match existing as specified at no additional compensation.

3.2 Preparation

- A. Remove all dirt and debris from frame and threshold.
- B. Remove hardware, catalog location of hardware for reinstallation.

DWIGHT REGIONAL TRANSPORTATION
CENTER/DEPOT REHABILITATION
SECTION 13-00052-01-HP
VILLAGE OF DWIGHT
LIVINGSTON COUNTY
CONTRACT 87681

- C. Remove all extraneous nails, staples, bolts, hooks, etc., from frame and door.
- D. Protect frame and opening from water damage. Dry all wood to moisture content below 17%.

3.3 Repair Procedures

- A. Tighten loose and open joints in frames to remain using waterproof glue and nails properly countersunk. Fill all joints without dismantling the frame and fill all other holes in wood with epoxy wood filler.
- B. Repairs larger than 1":
 - 1. Any holes in the finish surface over 1" in diameter should be filled with a wood dutchmen repair rather than filled with epoxy filler. All repairs will match surrounding profiles, texture, and coloring.
 - 2. Any areas of veneer delamination or severe weathering that cannot be repaired with consolidation and sanding shall be replaced as needed. Any such repairs must be approved by the Engineer prior to execution.
- C. Sand to smooth finish.
- D. Prepare surfaces, paint, and finish all exposed surfaces as specified.

3.4 Installation

- A. As indicated on door schedule, install rehabilitated original door hardware or new hardware.
- B. Install rehabilitated door assemblies level and plumb without warp or rack. Make joints tight and form joints to conceal shrinkage. Install work flush and tight to adjacent wood and plaster finishes. Any work that exhibits gaps larger than hairline will not be accepted.
- C. Adjust and lubricate all hardware to provide for smooth operation.
- D. All doors shall be in excellent operating condition at the conclusion of the work.
- E. Salvaged original doors not reinstalled remain the property of the Owner.
- F. Provide protective covering for installed doors and frames, which may only be removed at time of acceptance by the Engineer.

DWIGHT REGIONAL TRANSPORTATION
CENTER/DEPOT REHABILITATION
SECTION 13-00052-01-HP
VILLAGE OF DWIGHT
LIVINGSTON COUNTY
CONTRACT 87681

3.5 Clean-up

- A. Upon completion of wood door restoration, remove tools, equipment, and other unnecessary materials from site. Return adjacent area and surrounding property to the condition which existed prior to the start of work.
- B. Remove and legally dispose off-site all debris, rubbish, and other materials resulting from operations of this section.

Basis of Payment. This work shall be paid at the contract unit price per each for ACCESS DOORS. This price shall include the restoration of all existing exterior doors and where necessary replication of the era correct doors. The restoration and replication shall include all necessary restoration of existing hardware or furnishing of accurate replicas, painting, wood restoration, wood preservation, glass, removal, and reinstallation.



CAMPLIN

Environmental Services, Inc.

December 12, 2014

Christopher B. Burke Engineering, Ltd.
224 1/2 North Liberty St.
Morris, IL 60450

Attention: Ryan Hansen, PE
Construction Engineer

Subject: Lead Paint Testing
Dwight Train Depot

Dear Ryan,

On November 26, 2014, I obtained 4 samples of exterior paint at the Dwight Train Depot in Dwight, IL. Four paint chip samples were obtained from four different painted surfaces for analysis by ASTM D3335-85A "Standard Method to Test for Low Concentrations of Lead in Paint by Atomic Absorption Spectrophotometry" by an accredited Lab. This analytical method determines the percentage of lead by weight in paint. Paint with more than 0.5% lead by weight is considered a lead-based paint by the USEPA. Sample results are summarized as follows:

Sample #	Location/Description	Lead-Base Paint?
10L	Brown Exterior Column Paint	YES
11L	Yellow Window Paint	NO
12L	White Door Paint	NO
13L	Yellow Paint on Underside of Roof Deck	NO

The disturbance of lead-based paint on this building is not regulated by the Illinois Department of Public Health or EPA. OSHA worker protection rules would apply when the brown paint is disturbed.

The laboratory results are attached. Please let me know if you have any questions.

Cordially,

Jeff

Jeffery C. Camplin
USEPA Accredited Lead Risk Assessor

CERTIFICATE OF ANALYSIS

Client: Camplin Environmental 9575 W Higgins Rd, Ste 450 Rosemont II 60018	Report Date: 12/1/2014 Report Number: 351635 Project: Train Depot 11-26-14 Project No.: Dwight
---	---

LEAD PAINT SAMPLE ANALYSIS SUMMARY

<u>Lab No.</u>	<u>Client No.</u>	<u>Location / Description</u>	<u>Concentration Lead By Weight (%)</u>
5492876	10L	Brown Column Paint	0.66
5492877	11L	Yellow Window Paint	0.027
5492878	12L	White Door Paint	<0.0069
5492879	13L	Yellow Paint Underside	0.021

Accreditations:

NATIONAL LEAD LABORATORY ACCREDITATION PROGRAM (NLLAP)

AIHA-LAP, LLC No. 100188 NYSDOH-ELAP No. 11021

Analytical Methods: ASTM D3335-85A "Standard Method To Test For Low Concentrations Of Lead In Paint By Atomic Absorption Spectrophotometry"
 EPA SW846-(3050B:7000B) "Standard Method To Test For Low Concentrations Of Lead In Soils, Sludges and Sediments By AAS"

Comments: Regulatory limit is 0.5% lead by weight (EPA/HUD guidelines). Recommend multiple sampling for all samples less than regulatory limit for confirmation. All results are based on the samples as received at the lab. IATL assumes that appropriate sampling methods have been used and the data upon which these results are based have been accurately supplied by the client. Method Detection Limit (MDL) per EPA Method 40CFR Part 136 Appendix B. Reporting Limit (RL) based upon Lowest Standard Determined (LSD) in accordance with AIHA-ELLAP policies. LSD=0.2 ppm MDL=0.0044% by weight. RL= 0.010% by weight (based upon 100 mg sampled). * Insufficient sample provided to perform QC reanalysis (<200 mg) ** Not enough sample provided to analyze (<50 mg) *** Matrix / substrate interference possible. Sample results are not corrected for contamination by field or analytical blanks. This confidential report relates only to those item(s) tested and does not represent an endorsement by NIST-NVLAP, AIHA or any government agency. This report shall not be reproduced except in full, without written approval of the laboratory.

Date Received: 11/28/2014
Date Analyzed: 12/1/2014
Analyst: C. Shaffer

Approved By: 
 Frank E. Ehrenfeld, III
 Laboratory Director

State of Illinois
Department of Transportation
Bureau of Local Roads and Streets

SPECIAL PROVISION
FOR
INSURANCE

Effective: February 1, 2007
Revised: August 1, 2007

All references to Sections or Articles in this specification shall be construed to mean specific Section or Article of the Standard Specifications for Road and Bridge Construction, adopted by the Department of Transportation.

The Contractor shall name the following entities as additional insured under the Contractor's general liability insurance policy in accordance with Article 107.27:

The entities listed above and their officers, employees, and agents shall be indemnified and held harmless in accordance with Article 107.26.

COMPENSABLE DELAY COSTS (BDE)

Effective: June 2, 2017

Revise Article 107.40(b) of the Standard Specifications to read:

“(b) Compensation. Compensation will not be allowed for delays, inconveniences, or damages sustained by the Contractor from conflicts with facilities not meeting the above definition; or if a conflict with a utility in an unanticipated location does not cause a shutdown of the work or a documentable reduction in the rate of progress exceeding the limits set herein. The provisions of Article 104.03 notwithstanding, compensation for delays caused by a utility in an unanticipated location will be paid according to the provisions of this Article governing minor and major delays or reduced rate of production which are defined as follows.

- (1) Minor Delay. A minor delay occurs when the work in conflict with the utility in an unanticipated location is completely stopped for more than two hours, but not to exceed two weeks.
- (2) Major Delay. A major delay occurs when the work in conflict with the utility in an unanticipated location is completely stopped for more than two weeks.
- (3) Reduced Rate of Production Delay. A reduced rate of production delay occurs when the rate of production on the work in conflict with the utility in an unanticipated location decreases by more than 25 percent and lasts longer than seven calendar days.”

Revise Article 107.40(c) of the Standard Specifications to read:

“(c) Payment. Payment for Minor, Major, and Reduced Rate of Production Delays will be made as follows.

- (1) Minor Delay. Labor idled which cannot be used on other work will be paid for according to Article 109.04(b)(1) and (2) for the time between start of the delay and the minimum remaining hours in the work shift required by the prevailing practice in the area.

Equipment idled which cannot be used on other work, and which is authorized to standby on the project site by the Engineer, will be paid for according to Article 109.04(b)(4).

- (2) Major Delay. Labor will be the same as for a minor delay.

Equipment will be the same as for a minor delay, except Contractor-owned equipment will be limited to two weeks plus the cost of move-out to either the Contractor’s yard or another job and the cost to re-mobilize, whichever is less.

Rental equipment may be paid for longer than two weeks provided the Contractor presents adequate support to the Department (including lease agreement) to show retaining equipment on the job is the most economical course to follow and in the public interest.

- (3) Reduced Rate of Production Delay. The Contractor will be compensated for the reduced productivity for labor and equipment time in excess of the 25 percent threshold for that portion of the delay in excess of seven calendar days. Determination of compensation will be in accordance with Article 104.02, except labor and material additives will not be permitted.

Payment for escalated material costs, escalated labor costs, extended project overhead, and extended traffic control will be determined according to Article 109.13.”

Revise Article 108.04(b) of the Standard Specifications to read:

“(b) No working day will be charged under the following conditions.

- (1) When adverse weather prevents work on the controlling item.
- (2) When job conditions due to recent weather prevent work on the controlling item.
- (3) When conduct or lack of conduct by the Department or its consultants, representatives, officers, agents, or employees; delay by the Department in making the site available; or delay in furnishing any items required to be furnished to the Contractor by the Department prevents work on the controlling item.
- (4) When delays caused by utility or railroad adjustments prevent work on the controlling item.
- (5) When strikes, lock-outs, extraordinary delays in transportation, or inability to procure critical materials prevent work on the controlling item, as long as these delays are not due to any fault of the Contractor.
- (6) When any condition over which the Contractor has no control prevents work on the controlling item.”

Revise Article 109.09(f) of the Standard Specifications to read:

- “(f) Basis of Payment. After resolution of a claim in favor of the Contractor, any adjustment in time required for the work will be made according to Section 108. Any adjustment in the costs to be paid will be made for direct labor, direct materials, direct equipment, direct jobsite overhead, direct offsite overhead, and other direct costs allowed by the resolution. Adjustments in costs will not be made for interest charges, loss of anticipated profit, undocumented loss of efficiency, home office overhead and unabsorbed overhead

other than as allowed by Article 109.13, lost opportunity, preparation of claim expenses and other consequential indirect costs regardless of method of calculation.

The above Basis of Payment is an essential element of the contract and the claim cost recovery of the Contractor shall be so limited.”

Add the following to Section 109 of the Standard Specifications.

“109.13 Payment for Contract Delay. Compensation for escalated material costs, escalated labor costs, extended project overhead, and extended traffic control will be allowed when such costs result from a delay meeting the criteria in the following table.

Contract Type	Cause of Delay	Length of Delay
Working Days	Article 108.04(b)(3) or Article 108.04(b)(4)	No working days have been charged for two consecutive weeks.
Completion Date	Article 108.08(b)(1) or Article 108.08(b)(7)	The Contractor has been granted a minimum two week extension of contract time, according to Article 108.08.

Payment for each of the various costs will be according to the following.

- (a) Escalated Material and/or Labor Costs. When the delay causes work, which would have otherwise been completed, to be done after material and/or labor costs have increased, such increases will be paid. Payment for escalated material costs will be limited to the increased costs substantiated by documentation furnished by the Contractor. Payment for escalated labor costs will be limited to those items in Article 109.04(b)(1) and (2), except the 35 percent and 10 percent additives will not be permitted.
- (b) Extended Project Overhead. For the duration of the delay, payment for extended project overhead will be paid as follows.
 - (1) Direct Jobsite and Offsite Overhead. Payment for documented direct jobsite overhead and documented direct offsite overhead, including onsite supervisory and administrative personnel, will be allowed according to the following table.

Original Contract Amount	Supervisory and Administrative Personnel
Up to \$5,000,000	One Project Superintendent
Over \$ 5,000,000 - up to \$25,000,000	One Project Manager, One Project Superintendent or Engineer, and One Clerk
Over \$25,000,000 - up to \$50,000,000	One Project Manager, One Project Superintendent, One Engineer, and

	One Clerk
Over \$50,000,000	One Project Manager, Two Project Superintendents, One Engineer, and One Clerk

(2) Home Office and Unabsorbed Overhead. Payment for home office and unabsorbed overhead will be calculated as 8 percent of the total delay cost.

(c) Extended Traffic Control. Traffic control required for an extended period of time due to the delay will be paid. For working day contracts the payment will be made according to Article 109.04. For completion date contracts, an adjustment will be determined as follows.

Extended Traffic Control occurs between April 1 and November 30:

$$\text{ETCP Adjustment (\$)} = \text{TE} \times (\% / 100 \times \text{CUP} / \text{OCT})$$

Extended Traffic Control occurs between December 1 and March 31:

$$\text{ETCP Adjustment (\$)} = \text{TE} \times 1.5 (\% / 100 \times \text{CUP} / \text{OCT})$$

Where: TE = Duration of approved time extension in calendar days.

% = Percent maintenance for the traffic control, % (see table below).

CUP = Contract unit price for the traffic control pay item in place during the delay.

OCT = Original contract time in calendar days.

Original Contract Amount	Percent Maintenance
Up to \$2,000,000	65%
\$2,000,000 to \$10,000,000	75%
\$10,000,000 to \$20,000,000	85%
Over \$20,000,000	90%

When an ETCP adjustment is paid under this provision, an adjusted unit price as provided for in Article 701.20(a) for increase or decrease in the value of work by more than ten percent will not be paid.

Upon payment for a contract delay under this provision, the Contractor shall assign subrogation rights to the Department for the Department's efforts of recovery from any other party for monies paid by the Department as a result of any claim under this provision. The Contractor shall fully cooperate with the Department in its efforts to recover from another party any money paid to the Contractor for delay damages under this provision."

DISADVANTAGED BUSINESS ENTERPRISE PARTICIPATION (BDE)

Effective: September 1, 2000

Revised: July 2, 2016

FEDERAL OBLIGATION. The Department of Transportation, as a recipient of federal financial assistance, is required to take all necessary and reasonable steps to ensure nondiscrimination in the award and administration of contracts. Consequently, the federal regulatory provisions of 49 CFR Part 26 apply to this contract concerning the utilization of disadvantaged business enterprises. For the purposes of this Special Provision, a disadvantaged business enterprise (DBE) means a business certified by the Department in accordance with the requirements of 49 CFR Part 26 and listed in the Illinois Unified Certification Program (IL UCP) DBE Directory.

STATE OBLIGATION. This Special Provision will also be used by the Department to satisfy the requirements of the Business Enterprise for Minorities, Females, and Persons with Disabilities Act, 30 ILCS 575. When this Special Provision is used to satisfy state law requirements on 100 percent state-funded contracts, the federal government has no involvement in such contracts (not a federal-aid contract) and no responsibility to oversee the implementation of this Special Provision by the Department on those contracts. DBE participation on 100 percent state-funded contracts will not be credited toward fulfilling the Department's annual overall DBE goal required by the US Department of Transportation to comply with the federal DBE program requirements.

CONTRACTOR ASSURANCE. The Contractor makes the following assurance and agrees to include the assurance in each subcontract that the Contractor signs with a subcontractor.

The Contractor, subrecipient, or subcontractor shall not discriminate on the basis of race, color, national origin, or sex in the performance of this contract. The Contractor shall carry out applicable requirements of 49 CFR Part 26 in the award and administration of contracts funded in whole or in part with federal or state funds. Failure by the Contractor to carry out these requirements is a material breach of this contract, which may result in the termination of this contract or such other remedy as the recipient deems appropriate, which may include, but is not limited to:

- (a) Withholding progress payments;
- (b) Assessing sanctions;
- (c) Liquidated damages; and/or
- (d) Disqualifying the Contractor from future bidding as non-responsible.

OVERALL GOAL SET FOR THE DEPARTMENT. As a requirement of compliance with 49 CFR Part 26, the Department has set an overall goal for DBE participation in its federally assisted contracts. That goal applies to all federal-aid funds the Department will expend in its federally assisted contracts for the subject reporting fiscal year. The Department is required to make a

good faith effort to achieve the overall goal. The dollar amount paid to all approved DBE companies performing work called for in this contract is eligible to be credited toward fulfillment of the Department's overall goal.

CONTRACT GOAL TO BE ACHIEVED BY THE CONTRACTOR. This contract includes a specific DBE utilization goal established by the Department. The goal has been included because the Department has determined that the work of this contract has subcontracting opportunities that may be suitable for performance by DBE companies. The determination is based on an assessment of the type of work, the location of the work, and the availability of DBE companies to do a part of the work. The assessment indicates that, in the absence of unlawful discrimination, and in an arena of fair and open competition, DBE companies can be expected to perform 0.00% of the work. This percentage is set as the DBE participation goal for this contract. Consequently, in addition to the other award criteria established for this contract, the Department will only award this contract to a bidder who makes a good faith effort to meet this goal of DBE participation in the performance of the work. A bidder makes a good faith effort for award consideration if either of the following is done in accordance with the procedures set for in this Special Provision:

- (a) The bidder documents that enough DBE participation has been obtained to meet the goal or,
- (b) The bidder documents that a good faith effort has been made to meet the goal, even though the effort did not succeed in obtaining enough DBE participation to meet the goal.

DBE LOCATOR REFERENCES. Bidders shall consult the IL UCP DBE Directory as a reference source for DBE-certified companies. In addition, the Department maintains a letting and item specific DBE locator information system whereby DBE companies can register their interest in providing quotes on particular bid items advertised for letting. Information concerning DBE companies willing to quote work for particular contracts may be obtained by contacting the Department's Bureau of Small Business Enterprises at telephone number (217) 785-4611, or by visiting the Department's website at:

<http://www.idot.illinois.gov/doing-business/certifications/disadvantaged-business-enterprise-certification/il-ucp-directory/index>.

BIDDING PROCEDURES. Compliance with this Special Provision is required prior to the award of the contract and the failure of the low bidder to comply will render the bid not responsive.

In order to assure the timely award of the contract, the low bidder shall submit:

- (a) The bidder shall submit a DBE Utilization Plan on completed Department forms SBE 2025 and 2026.
 - (1) The final Utilization Plan must be submitted within five calendar days after the date of the letting in accordance with subsection (a)(2) of Bidding Procedures herein.

- (2) To meet the five day requirement, the bidder may send the Utilization Plan electronically by scanning and sending to DOT.DBE.UP@illinois.gov or faxing to (217) 785-1524. The subject line must include the bid Item Number and the Letting date. The Utilization Plan should be sent as one .pdf file, rather than multiple files and emails for the same Item Number. It is the responsibility of the bidder to obtain confirmation of email or fax delivery.

Alternatively, the Utilization Plan may be sent by certified mail or delivery service within the five calendar day period. If a question arises concerning the mailing date of a Utilization Plan, the mailing date will be established by the U.S. Postal Service postmark on the certified mail receipt from the U.S. Postal Service or the receipt issued by a delivery service when the Utilization Plan is received by the Department. It is the responsibility of the bidder to ensure the postmark or receipt date is affixed within the five days if the bidder intends to rely upon mailing or delivery to satisfy the submission day requirement. The Utilization Plan is to be submitted to:

Illinois Department of Transportation
Bureau of Small Business Enterprises
Contract Compliance Section
2300 South Dirksen Parkway, Room 319
Springfield, Illinois 62764

The Department will not accept a Utilization Plan if it does not meet the five day submittal requirement and the bid will be declared not responsive. In the event the bid is declared not responsive due to a failure to submit a Utilization Plan or failure to comply with the bidding procedures set forth herein, the Department may elect to cause the forfeiture of the penal sum of the bidder's proposal guaranty, and may deny authorization to bid the project if re-advertised for bids. The Department reserves the right to invite any other bidder to submit a Utilization Plan at any time for award consideration.

- (b) The Utilization Plan shall indicate that the bidder either has obtained sufficient DBE participation commitments to meet the contract goal or has not obtained enough DBE participation commitments in spite of a good faith effort to meet the goal. The Utilization Plan shall further provide the name, telephone number, and telefax number of a responsible official of the bidder designated for purposes of notification of Utilization Plan approval or disapproval under the procedures of this Special Provision.
- (c) The Utilization Plan shall include a DBE Participation Commitment Statement, Department form SBE 2025, for each DBE proposed for the performance of work to achieve the contract goal. For bidding purposes, submission of the completed SBE 2025 forms, signed by the DBEs and scanned or faxed to the bidder will be acceptable as long as the original is available and provided upon request. All elements of information indicated on the said form shall be provided, including but not limited to the following:

- (1) The names and addresses of DBE firms that will participate in the contract;
- (2) A description, including pay item numbers, of the work each DBE will perform;
- (3) The dollar amount of the participation of each DBE firm participating. The dollar amount of participation for identified work shall specifically state the quantity, unit price, and total subcontract price for the work to be completed by the DBE. If partial pay items are to be performed by the DBE, indicate the portion of each item, a unit price where appropriate and the subcontract price amount;
- (4) DBE Participation Commitment Statements, form SBE 2025, signed by the bidder and each participating DBE firm documenting the commitment to use the DBE subcontractors whose participation is submitted to meet the contract goal;
- (5) If the bidder is a joint venture comprised of DBE companies and non-DBE companies, the Utilization Plan must also include a clear identification of the portion of the work to be performed by the DBE partner(s); and,
- (6) If the contract goal is not met, evidence of good faith efforts; the documentation of good faith efforts must include copies of each DBE and non-DBE subcontractor quote submitted to the bidder when a non-DBE subcontractor is selected over a DBE for work on the contract.

GOOD FAITH EFFORT PROCEDURES. The contract will not be awarded until the Utilization Plan submitted by the apparent successful bidder is approved. All information submitted by the bidder must be complete, accurate and adequately document that enough DBE participation has been obtained or document that good faith efforts of the bidder, in the event enough DBE participation has not been obtained, before the Department will commit to the performance of the contract by the bidder. The Utilization Plan will be approved by the Department if the Utilization Plan documents sufficient commercially useful DBE work to meet the contract goal or the bidder submits sufficient documentation of a good faith effort to meet the contract goal pursuant to 49 CFR Part 26, Appendix A. The Utilization Plan will not be approved by the Department if the Utilization Plan does not document sufficient DBE participation to meet the contract goal unless the apparent successful bidder documented in the Utilization Plan that it made a good faith effort to meet the goal. This means that the bidder must show that all necessary and reasonable steps were taken to achieve the contract goal. Necessary and reasonable steps are those which, by their scope, intensity and appropriateness to the objective, could reasonably be expected to obtain sufficient DBE participation, even if they were not successful. The Department will consider the quality, quantity, and intensity of the kinds of efforts that the bidder has made. Mere *pro forma* efforts, in other words, efforts done as a matter of form, are not good faith efforts; rather, the bidder is expected to have taken genuine efforts that would be reasonably expected of a bidder actively and aggressively trying to obtain DBE participation sufficient to meet the contract goal.

- (a) The following is a list of types of action that the Department will consider as part of the evaluation of the bidder's good faith efforts to obtain participation. These listed factors

are not intended to be a mandatory checklist and are not intended to be exhaustive. Other factors or efforts brought to the attention of the Department may be relevant in appropriate cases, and will be considered by the Department.

- (1) Soliciting through all reasonable and available means (e.g. attendance at pre-bid meetings, advertising and/or written notices) the interest of all certified DBE companies that have the capability to perform the work of the contract. The bidder must solicit this interest within sufficient time to allow the DBE companies to respond to the solicitation. The bidder must determine with certainty if the DBE companies are interested by taking appropriate steps to follow up initial solicitations.
- (2) Selecting portions of the work to be performed by DBE companies in order to increase the likelihood that the DBE goals will be achieved. This includes, where appropriate, breaking out contract work items into economically feasible units to facilitate DBE participation, even when the prime Contractor might otherwise prefer to perform these work items with its own forces.
- (3) Providing interested DBE companies with adequate information about the plans, specifications, and requirements of the contract in a timely manner to assist them in responding to a solicitation.
- (4) a. Negotiating in good faith with interested DBE companies. It is the bidder's responsibility to make a portion of the work available to DBE subcontractors and suppliers and to select those portions of the work or material needs consistent with the available DBE subcontractors and suppliers, so as to facilitate DBE participation. Evidence of such negotiation includes the names, addresses, and telephone numbers of DBE companies that were considered; a description of the information provided regarding the plans and specifications for the work selected for subcontracting; and evidence as to why additional agreements could not be reached for DBE companies to perform the work.

b. A bidder using good business judgment would consider a number of factors in negotiating with subcontractors, including DBE subcontractors, and would take a firm's price and capabilities as well as contract goals into consideration. However, the fact that there may be some additional costs involved in finding and using DBE companies is not in itself sufficient reason for a bidder's failure to meet the contract DBE goal, as long as such costs are reasonable. Also the ability or desire of a bidder to perform the work of a contract with its own organization does not relieve the bidder of the responsibility to make good faith efforts. Bidders are not, however, required to accept higher quotes from DBE companies if the price difference is excessive or unreasonable. In accordance with subsection (c)(6) of the above Bidding Procedures, the documentation of good faith efforts must include copies of each DBE and non-DBE subcontractor quote submitted to the bidder when a non-DBE subcontractor was selected over a DBE for work on the contract.

- (5) Not rejecting DBE companies as being unqualified without sound reasons based on a thorough investigation of their capabilities. The bidder's standing within its industry, membership in specific groups, organizations, or associations and political or social affiliations (for example union vs. non-union employee status) are not legitimate causes for the rejection or non-solicitation of bids in the bidder's efforts to meet the project goal.
 - (6) Making efforts to assist interested DBE companies in obtaining bonding, lines of credit, or insurance as required by the recipient or Contractor.
 - (7) Making efforts to assist interested DBE companies in obtaining necessary equipment, supplies, materials, or related assistance or services.
 - (8) Effectively using the services of available minority/women community organizations; minority/women contractors' groups; local, state, and federal minority/women business assistance offices; and other organizations as allowed on a case-by-case basis to provide assistance in the recruitment and placement of DBE companies.
- (b) If the Department determines that the apparent successful bidder has made a good faith effort to secure the work commitment of DBE companies to meet the contract goal, the Department will award the contract provided that it is otherwise eligible for award. If the Department determines that the bidder has failed to meet the requirements of this Special Provision or that a good faith effort has not been made, the Department will notify the responsible company official designated in the Utilization Plan that the bid is not responsive. The notification shall include a statement of reasons for the determination. If the Utilization Plan is not approved because it is deficient as a technical matter, unless waived by the Department, the bidder will be notified and will be allowed no more than a five calendar day period in order to cure the deficiency.
- (c) The bidder may request administrative reconsideration of a determination adverse to the bidder within the five working days after the receipt of the notification date of the determination by delivering the request to the Department of Transportation, Bureau of Small Business Enterprises, Contract Compliance Section, 2300 South Dirksen Parkway, Room 319, Springfield, Illinois 62764 (Telefax: (217) 785-1524). Deposit of the request in the United States mail on or before the fifth business day shall not be deemed delivery. The determination shall become final if a request is not made and delivered. A request may provide additional written documentation or argument concerning the issues raised in the determination statement of reasons, provided the documentation and arguments address efforts made prior to submitting the bid. The request will be forwarded to the Department's Reconsideration Officer. The Reconsideration Officer will extend an opportunity to the bidder to meet in person in order to consider all issues of documentation and whether the bidder made a good faith effort to meet the goal. After the review by the Reconsideration Officer, the bidder will be sent a written decision within ten working days after receipt of the request for consideration, explaining the basis for finding that the bidder did or did not meet the goal or make adequate good faith efforts to do so. A final decision by the Reconsideration

Officer that a good faith effort was made shall approve the Utilization Plan submitted by the bidder and shall clear the contract for award. A final decision that a good faith effort was not made shall render the bid not responsive.

CALCULATING DBE PARTICIPATION. The Utilization Plan values represent work anticipated to be performed and paid for upon satisfactory completion. The Department is only able to count toward the achievement of the overall goal and the contract goal the value of payments made for the work actually performed by DBE companies. In addition, a DBE must perform a commercially useful function on the contract to be counted. A commercially useful function is generally performed when the DBE is responsible for the work and is carrying out its responsibilities by actually performing, managing, and supervising the work involved. The Department and Contractor are governed by the provisions of 49 CFR Part 26.55(c) on questions of commercially useful functions as it affects the work. Specific counting guidelines are provided in 49 CFR Part 26.55, the provisions of which govern over the summary contained herein.

- (a) DBE as the Contractor: 100 percent goal credit for that portion of the work performed by the DBE's own forces, including the cost of materials and supplies. Work that a DBE subcontracts to a non-DBE does not count toward the DBE goals.
- (b) DBE as a joint venture Contractor: 100 percent goal credit for that portion of the total dollar value of the contract equal to the distinct, clearly defined portion of the work performed by the DBE's own forces.
- (c) DBE as a subcontractor: 100 percent goal credit for the work of the subcontract performed by the DBE's own forces, including the cost of materials and supplies, excluding the purchase of materials and supplies or the lease of equipment by the DBE subcontractor from the prime Contractor or its affiliates. Work that a DBE subcontractor in turn subcontracts to a non-DBE does not count toward the DBE goal.
- (d) DBE as a trucker: 100 percent goal credit for trucking participation provided the DBE is responsible for the management and supervision of the entire trucking operation for which it is responsible. At least one truck owned, operated, licensed, and insured by the DBE must be used on the contract. Credit will be given for the following:
 - (1) The DBE may lease trucks from another DBE firm, including an owner-operator who is certified as a DBE. The DBE who leases trucks from another DBE receives credit for the total value of the transportation services the lessee DBE provides on the contract.
 - (2) The DBE may also lease trucks from a non-DBE firm, including from an owner-operator. The DBE who leases trucks from a non-DBE is entitled to credit only for the fee or commission is receives as a result of the lease arrangement.
- (e) DBE as a material supplier:

- (1) 60 percent goal credit for the cost of the materials or supplies purchased from a DBE regular dealer.
- (2) 100 percent goal credit for the cost of materials of supplies obtained from a DBE manufacturer.
- (3) 100 percent credit for the value of reasonable fees and commissions for the procurement of materials and supplies if not a DBE regular dealer or DBE manufacturer.

CONTRACT COMPLIANCE. Compliance with this Special Provision is an essential part of the contract. The Department is prohibited by federal regulations from crediting the participation of a DBE included in the Utilization Plan toward either the contract goal or the Department's overall goal until the amount to be applied toward the goals has been paid to the DBE. The following administrative procedures and remedies govern the compliance by the Contractor with the contractual obligations established by the Utilization Plan. After approval of the Utilization Plan and award of the contract, the Utilization Plan and individual DBE Participation Statements become part of the contract. If the Contractor did not succeed in obtaining enough DBE participation to achieve the advertised contract goal, and the Utilization Plan was approved and contract awarded based upon a determination of good faith, the total dollar value of DBE work calculated in the approved Utilization Plan as a percentage of the awarded contract value shall become the amended contract goal. All work indicated for performance by an approved DBE shall be performed, managed, and supervised by the DBE executing the DBE Participation Commitment Statement.

- (a) NO AMENDMENT. No amendment to the Utilization Plan may be made without prior written approval from the Department's Bureau of Small Business Enterprises. All requests for amendment to the Utilization Plan shall be submitted to the Department of Transportation, Bureau of Small Business Enterprises, Contract Compliance Section, 2300 South Dirksen Parkway, Room 319, Springfield, Illinois 62764. Telephone number (217) 785-4611. Telefax number (217) 785-1524.
- (b) CHANGES TO WORK. Any deviation from the DBE condition-of-award or contract plans, specifications, or special provisions must be approved, in writing, by the Department as provided elsewhere in the Contract. The Contractor shall notify affected DBEs in writing of any changes in the scope of work which result in a reduction in the dollar amount condition-of-award to the contract. Where the revision includes work committed to a new DBE subcontractor, not previously involved in the project, then a Request for Approval of Subcontractor, Department form BC 260A or AER 260A, must be signed and submitted. If the commitment of work is in the form of additional tasks assigned to an existing subcontract, then a new Request for Approval of Subcontractor shall not be required. However, the Contractor must document efforts to assure that the existing DBE subcontractor is capable of performing the additional work and has agreed in writing to the change.

- (c) SUBCONTRACT. The Contractor must provide DBE subcontracts to IDOT upon request. Subcontractors shall ensure that all lower tier subcontracts or agreements with DBEs to supply labor or materials be performed in accordance with this Special Provision.
- (d) ALTERNATIVE WORK METHODS. In addition to the above requirements for reductions in the condition of award, additional requirements apply to the two cases of Contractor-initiated work substitution proposals. Where the contract allows alternate work methods which serve to delete or create underruns in condition of award DBE work, and the Contractor selects that alternate method or, where the Contractor proposes a substitute work method or material that serves to diminish or delete work committed to a DBE and replace it with other work, then the Contractor must demonstrate one of the following:
- (1) That the replacement work will be performed by the same DBE (as long as the DBE is certified in the respective item of work) in a modification of the condition of award; or
 - (2) That the DBE is aware that its work will be deleted or will experience underruns and has agreed in writing to the change. If this occurs, the Contractor shall substitute other work of equivalent value to a certified DBE or provide documentation of good faith efforts to do so; or
 - (3) That the DBE is not capable of performing the replacement work or has declined to perform the work at a reasonable competitive price. If this occurs, the Contractor shall substitute other work of equivalent value to a certified DBE or provide documentation of good faith efforts to do so.
- (e) TERMINATION AND REPLACEMENT PROCEDURES. The Contractor shall not terminate or replace a DBE listed on the approved Utilization Plan, or perform with other forces work designated for a listed DBE except as provided in this Special Provision. The Contractor shall utilize the specific DBEs listed to perform the work and supply the materials for which each is listed unless the Contractor obtains the Department's written consent as provided in subsection (a) of this part. Unless Department consent is provided for termination of a DBE subcontractor, the Contractor shall not be entitled to any payment for work or material unless it is performed or supplied by the DBE in the Utilization Plan.

As stated above, the Contractor shall not terminate or replace a DBE subcontractor listed in the approved Utilization Plan without prior written consent. This includes, but is not limited to, instances in which the Contractor seeks to perform work originally designated for a DBE subcontractor with its own forces or those of an affiliate, a non-DBE firm, or with another DBE firm. Written consent will be granted only if the Bureau of Small Business Enterprises agrees, for reasons stated in its concurrence document, that the Contractor has good cause to terminate or replace the DBE firm. Before transmitting to the Bureau of Small Business Enterprises any request to terminate and/or substitute a DBE subcontractor, the Contractor shall give notice in writing to the DBE subcontractor,

with a copy to the Bureau, of its intent to request to terminate and/or substitute, and the reason for the request. The Contractor shall give the DBE five days to respond to the Contractor's notice. The DBE so notified shall advise the Bureau and the Contractor of the reasons, if any, why it objects to the proposed termination of its subcontract and why the Bureau should not approve the Contractor's action. If required in a particular case as a matter of public necessity, the Bureau may provide a response period shorter than five days.

For purposes of this paragraph, good cause includes the following circumstances:

- (1) The listed DBE subcontractor fails or refuses to execute a written contract;
- (2) The listed DBE subcontractor fails or refuses to perform the work of its subcontract in a way consistent with normal industry standards. Provided, however, that good cause does not exist if the failure or refusal of the DBE subcontractor to perform its work on the subcontract results from the bad faith or discriminatory action of the prime contractor;
- (3) The listed DBE subcontractor fails or refuses to meet the prime Contractor's reasonable, nondiscriminatory bond requirements;
- (4) The listed DBE subcontractor becomes bankrupt, insolvent, or exhibits credit unworthiness;
- (5) The listed DBE subcontractor is ineligible to work on public works projects because of suspension and debarment proceedings pursuant 2 CFR Parts 180, 215 and 1200 or applicable state law.
- (6) You have determined that the listed DBE subcontractor is not a responsible contractor;
- (7) The listed DBE subcontractor voluntarily withdraws from the projects and provides to you written notice of its withdrawal;
- (8) The listed DBE is ineligible to receive DBE credit for the type of work required;
- (9) A DBE owner dies or becomes disabled with the result that the listed DBE subcontractor is unable to complete its work on the contract;
- (10) Other documented good cause that compels the termination of the DBE subcontractor. Provided, that good cause does not exist if the prime Contractor seeks to terminate a DBE it relied upon to obtain the contract so that the prime Contractor can self-perform the work for which the DBE contractor was engaged or so that the prime Contractor can substitute another DBE or non-DBE contractor after contract award.

When a DBE is terminated, or fails to complete its work on the Contract for any reason the Contractor shall make a good faith effort to find another DBE to substitute for the original DBE to perform at least the same amount of work under the contract as the terminated DBE to the extent needed to meet the established Contract goal. The good faith efforts shall be documented by the Contractor. If the Department requests documentation under this provision, the Contractor shall submit the documentation within seven days, which may be extended for an additional seven days if necessary at the request of the Contractor. The Department shall provide a written determination to the Contractor stating whether or not good faith efforts have been demonstrated.

- (f) PAYMENT RECORDS. The Contractor shall maintain a record of payments for work performed to the DBE participants. The records shall be made available to the Department for inspection upon request. After the performance of the final item of work or delivery of material by a DBE and final payment therefore to the DBE by the Contractor, but not later than thirty calendar days after payment has been made by the Department to the Contractor for such work or material, the Contractor shall submit a DBE Payment Agreement on Department form SBE 2115 to the Resident Engineer. If full and final payment has not been made to the DBE, the DBE Payment Agreement shall indicate whether a disagreement as to the payment required exists between the Contractor and the DBE or if the Contractor believes that the work has not been satisfactorily completed. If the Contractor does not have the full amount of work indicated in the Utilization Plan performed by the DBE companies indicated in the Utilization Plan and after good faith efforts are reviewed, the Department may deduct from contract payments to the Contractor the amount of the goal not achieved as liquidated and ascertained damages. The Contractor may request an administrative reconsideration of any amount deducted as damages pursuant to subsection (h) of this part.
- (g) ENFORCEMENT. The Department reserves the right to withhold payment to the Contractor to enforce the provisions of this Special Provision. Final payment shall not be made on the contract until such time as the Contractor submits sufficient documentation demonstrating achievement of the goal in accordance with this Special Provision or after liquidated damages have been determined and collected.
- (h) RECONSIDERATION. Notwithstanding any other provision of the contract, including but not limited to Article 109.09 of the Standard Specifications, the Contractor may request administrative reconsideration of a decision to deduct the amount of the goal not achieved as liquidated damages. A request to reconsider shall be delivered to the Contract Compliance Section and shall be handled and considered in the same manner as set forth in paragraph (c) of "Good Faith Effort Procedures" of this Special Provision, except a final decision that a good faith effort was not made during contract performance to achieve the goal agreed to in the Utilization Plan shall be the final administrative decision of the Department. The result of the reconsideration process is not administratively appealable to the U.S. Department of Transportation.

EQUIPMENT PARKING AND STORAGE (BDE)

Effective: November 1, 2017

Replace the first paragraph of Article 701.11 of the Standard Specifications with the following.

“701.11 Equipment Parking and Storage. During working hours, all vehicles and/or nonoperating equipment which are parked, two hours or less, shall be parked at least 8 ft (2.5 m) from the open traffic lane. For other periods of time during working and for all nonworking hours, all vehicles, materials, and equipment shall be parked or stored as follows.

- (a) When the project has adequate right-of-way, vehicles, materials, and equipment shall be located a minimum of 30 ft (9 m) from the pavement.
- (b) When adequate right-of-way does not exist, vehicles, materials, and equipment shall be located a minimum of 15 ft (4.5 m) from the edge of any pavement open to traffic.
- (c) Behind temporary concrete barrier, vehicles, materials, and equipment shall be located a minimum of 24 in. (600 mm) behind free standing barrier or a minimum of 6 in. (150 mm) behind barrier that is either pinned or restrained according to Article 704.04. The 24 in. or 6 in. measurement shall be from the base of the non-traffic side of the barrier.
- (d) Behind other man-made or natural barriers meeting the approval of the Engineer.”

80388

LIGHTS ON BARRICADES (BDE)

Effective: January 1, 2018

Revise Article 701.16 of the Standard Specifications to read:

“701.16 Lights. Lights shall be used on devices as required in the plans, the traffic control plan, and the following table.

Circumstance	Lights Required
Daylight operations	None
First two warning signs on each approach to the work involving a nighttime lane closure and “ROUGH GROOVED SURFACE” (W8-I107) signs	Flashing mono-directional lights
Devices delineating isolated obstacles, excavations, or hazards at night (Does not apply to patching)	Flashing bi-directional lights
Devices delineating obstacles, excavations, or hazards exceeding 100 ft (30 m) in length at night (Does not apply to widening)	Steady burn bi-directional lights
Channelizing devices for nighttime lane closures on two-lane roads	None
Channelizing devices for nighttime lane closures on multi-lane roads	None
Channelizing devices for nighttime lane closures on multi-lane roads separating opposing directions of traffic	None
Channelizing devices for nighttime along lane shifts on multilane roads	Steady burn mono-directional lights
Channelizing devices for night time along lane shifts on two lane roads	Steady burn bi-directional lights
Devices in nighttime lane closure tapers on Standards 701316 and 701321	Steady burn bi-directional lights
Devices in nighttime lane closure tapers	Steady burn mono-directional lights
Devices delineating a widening trench	None
Devices delineating patches at night on roadways with an ADT less than 25,000	None
Devices delineating patches at night on roadways with an ADT of 25,000 or more	None

Batteries for the lights shall be replaced on a group basis at such times as may be specified by the Engineer.”

Delete the fourth sentence of the first paragraph of Article 701.17(c)(2) of the Standard Specifications.

Revise the first paragraph of Article 603.07 of the Standard Specifications to read:

“603.07 Protection Under Traffic. After the casting has been adjusted and Class SI concrete has been placed, the work shall be protected by a barricade for at least 72 hours.”

80392

PAYMENTS TO SUBCONTRACTORS (BDE)

Effective: November 2, 2017

Add the following to the end of the fourth paragraph of Article 109.11 of the Standard Specifications:

“If reasonable cause is asserted, written notice shall be provided to the applicable subcontractor and/or material supplier and the Engineer within five days of the Contractor receiving payment. The written notice shall identify the contract number, the subcontract or material purchase agreement, a detailed reason for refusal, the value of payment being withheld, and the specific remedial actions required of the subcontractor and/or material supplier so that payment can be made.”

80390

PROGRESS PAYMENTS (BDE)

Effective: November 2, 2013

Revise Article 109.07(a) of the Standard Specifications to read:

“(a) Progress Payments. At least once each month, the Engineer will make a written estimate of the quantity of work performed in accordance with the contract, and the value thereof at the contract unit prices. The amount of the estimate approved as due for payment will be vouchered by the Department and presented to the State Comptroller for payment. No amount less than \$1000.00 will be approved for payment other than the final payment.

Progress payments may be reduced by liens filed pursuant to Section 23(c) of the Mechanics' Lien Act, 770 ILCS 60/23(c).

If a Contractor or subcontractor has defaulted on a loan issued under the Department's Disadvantaged Business Revolving Loan Program (20 ILCS 2705/2705-610), progress payments may be reduced pursuant to the terms of that loan agreement. In such cases, the amount of the estimate related to the work performed by the Contractor or subcontractor, in default of the loan agreement, will be offset, in whole or in part, and vouchered by the Department to the Working Capital Revolving Fund or designated escrow account. Payment for the work shall be considered as issued and received by the Contractor or subcontractor on the date of the offset voucher. Further, the amount of the offset voucher shall be a credit against the Department's obligation to pay the Contractor, the Contractor's obligation to pay the subcontractor, and the Contractor's or subcontractor's total loan indebtedness to the Department. The offset shall continue until such time as the entire loan indebtedness is satisfied. The Department will notify the Contractor and Fund Control Agent in a timely manner of such offset. The Contractor or subcontractor shall not be entitled to additional payment in consideration of the offset.

The failure to perform any requirement, obligation, or term of the contract by the Contractor shall be reason for withholding any progress payments until the Department determines that compliance has been achieved.”

80328

SUBCONTRACTOR MOBILILATION PAYMENTS (BDE)

Effective: November 2, 2017

Replace the second paragraph of Article 109.12 of the Standard Specifications with the following:

“This mobilization payment shall be made at least 14 days prior to the subcontractor starting work. The amount paid shall be at the following percentage of the amount of the subcontract reported on form BC 260A submitted for the approval of the subcontractor’s work.

Value of Subcontract Reported on Form BC 260A	Mobilization Percentage
Less than \$10,000	25%
\$10,000 to less than \$20,000	20%
\$20,000 to less than \$40,000	18%
\$40,000 to less than \$60,000	16%
\$60,000 to less than \$80,000	14%
\$80,000 to less than \$100,000	12%
\$100,000 to less than \$250,000	10%
\$250,000 to less than \$500,000	9%
\$500,000 to \$750,000	8%
Over \$750,000	7%

80391

WEEKLY DBE TRUCKING REPORTS (BDE)

Effective: June 2, 2012

| Revised: April 2, 2015

| The Contractor shall submit a weekly report of Disadvantaged Business Enterprise (DBE) trucks hired by the Contractor or subcontractors (i.e. not owned by the Contractor or subcontractors) that are used for DBE goal credit.

| The report shall be submitted to the Engineer on Department form "SBE 723" within ten business days following the reporting period. The reporting period shall be Monday through Sunday for each week reportable trucking activities occur.

Any costs associated with providing weekly DBE trucking reports shall be considered as included in the contract unit prices bid for the various items of work involved and no additional compensation will be allowed.

80302

WORKING DAYS (BDE)

Effective: January 1, 2002

The Contractor shall complete the work within 40 working days.

80071

FED. AID RTE.	SECTION	COUNTY	TOTAL SHEETS	SHEET NO.
	13-00052-01-HP	LIVINGSTON	7	1
FEDERAL ROAD DISTRICT NO. 1 (ILLINOIS)		FEDERAL AID PROJECT		

STATE OF ILLINOIS
DEPARTMENT OF TRANSPORTATION
DIVISION OF HIGHWAYS
**PLAN FOR PROPOSED
FEDERAL AID HIGHWAY**

ILLINOIS TRANSPORTATION ENHANCEMENT
PROJECT FUNDS
ITEP #320015

DWIGHT REGIONAL TRANSPORTATION
CENTER/DEPOT REHABILITATION

VILLAGE OF DWIGHT

SECTION 13-00052-01-HP
PROJECT NO. TE-00D3(098)

PAINTING, DOORS, AND
TUCKPOINTING

LIVINGSTON COUNTY

JOB NO: C-93-092-17



PROJECT LOCATION

NOT TO SCALE

STATE OF ILLINOIS
DEPARTMENT OF TRANSPORTATION
DIVISION OF HIGHWAYS

APPROVED *[Signature]* 11/15/17
VILLAGE OF DWIGHT MAYOR

PASSED *[Signature]* 11/17/17
DISTRICT 3 ENGINEER OF LOCAL ROADS AND STREETS

RELEASING FOR BID
BASED ON LIMITED
REVIEW *[Signature]* 11/17/17
REGION 3 ENGINEER

INDEX OF SHEETS

- 1 COVER
- 2 SUMMARY OF QUANTITIES
- 3 NORTH AND SOUTH ELEVATIONS
- 4 WEST AND EAST ELEVATIONS
- 5 SHIPPING DEPOT ELEVATIONS
- 6 IDOT STANDARDS

HIGHWAY STANDARDS

701801-06 SIDEWALK CORNER OR CROSS WALK CLOSURE

J.U.L.I.E.
JOINT UTILITY LOCATION INFORMATION FOR EXCAVATION
1-800-892-0123
OR 811



[Signature] 11/14/17
ENGINEER

CASEY J. MCCOLLOM P.E.
ILLINOIS REGISTRATION NO. 062-059173
EXPIRATION DATE: 1/1/17

CHAMLIN & PERU MORRIS
ASSOCIATES, INC. ILLINOIS

Contract # 87691

SUMMARY OF QUANTITIES

			TYPE CODE
			0033
CODE NO.	ITEM	UNIT	QUANTITY
67100100	MOBILIZATION	L SUM	1
70102640	TRAFFIC CONTROL AND PROTECTION, STANDARD 701801	L SUM	1
X003022	MASONRY CLEANING & TUCKPOINTING	L SUM	1
X0327773	ACCESS DOORS	EACH	6
Z0036500	PAINTING	L SUM	1

* DENOTES SPECIAL PROVISION

VILLAGE OF DWIGHT

DWIGHT REGIONAL TRANSPORTATION CENTER/DEPOT REHABILITATION PROJECT

N.T.S.

NORTH & SOUTH ELEVATION

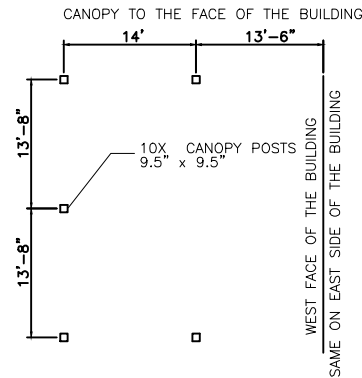
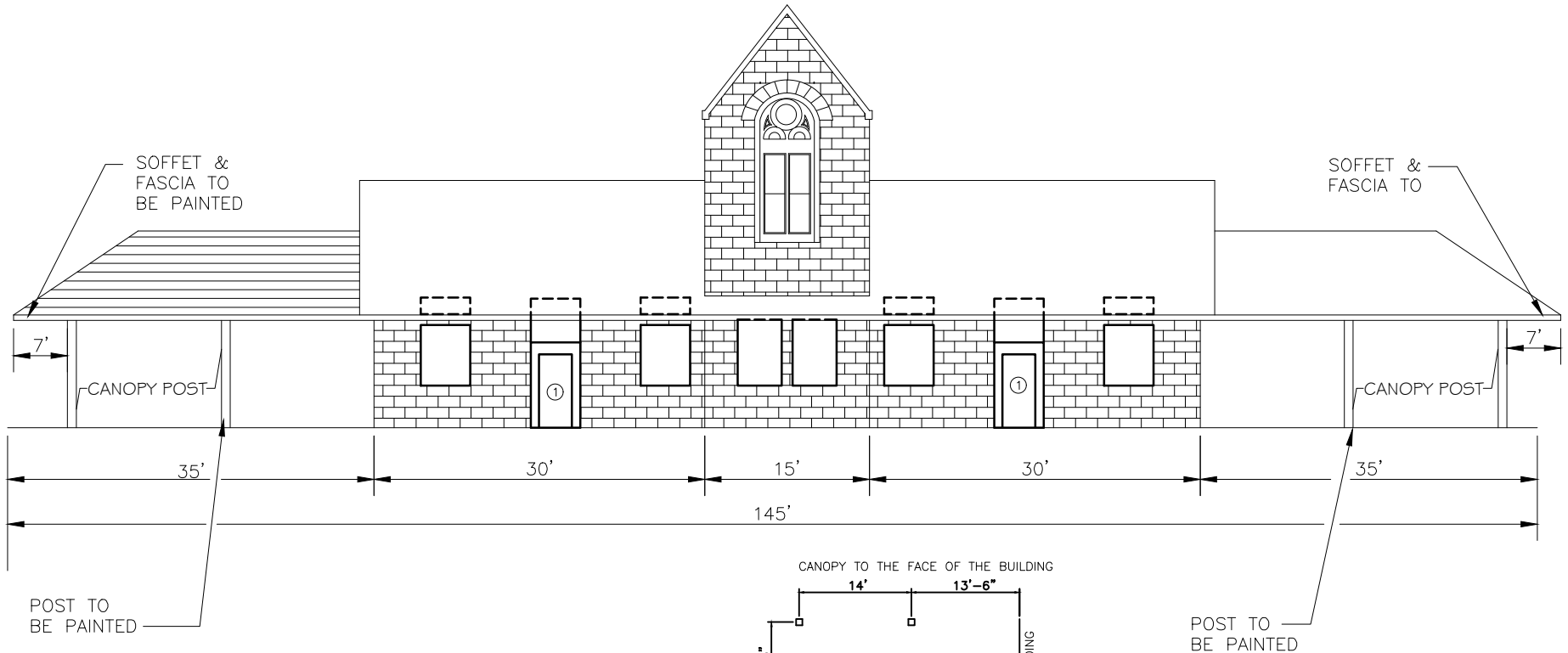

CANOPY POSTS LAYOUT
NOT TO SCALE

NOTES

- 1) ALL MORTAR JOINTS SHALL BE INSPECTED AND TUCKPOINTED AS REQUIRED. ALL MASONRY SHALL BE CLEANED FOLLOWING TUCKPOINTING.
- 2) ALL EXTERIOR PAINTED SURFACES SHALL BE REPAINTED IN ACCORDANCE WITH THE SPECIFICATIONS.

DOOR SCHEDULE

SIZE	TYPE	NORTH	SOUTH	TOTAL
① 4'-6" x 7'-9"	STANDARD DOOR	2	2	4
TOTAL				4

CHAMLIN
ASSOCIATES
PERU ILLINOIS MORRIS

SEC.: 13-00052-01-HP		LIVINGSTON COUNTY		DWIGHT DEPOT PAINTING, DOOR, & TUCKPOINTING PROJECT DEPOT NORTH & SOUTH ELEVATIONS	
DATE: 11/14/17	SHTS: 3 OF 5	DRAWN BY: KEH			

CHAMLIN & ASSOCIATES, INC. 2017
 Drawing Name: H:\JOB WORK\PROJECTS\2412-DWIGHT_TRANSPORTATION\WINDOWS RESTORATION.dwg Last Modified: Nov 13, 2017 - 4:48pm Plotted on: Nov 13, 2017 - 4:50pm by mick

VILLAGE OF DWIGHT
 DWIGHT REGIONAL
 TRANSPORTATION CENTER/DEPOT
 REHABILITATION PROJECT

N.T.S.

SOFFET &
 FASCIA TO
 BE PAINTED

WEST ELEVATION

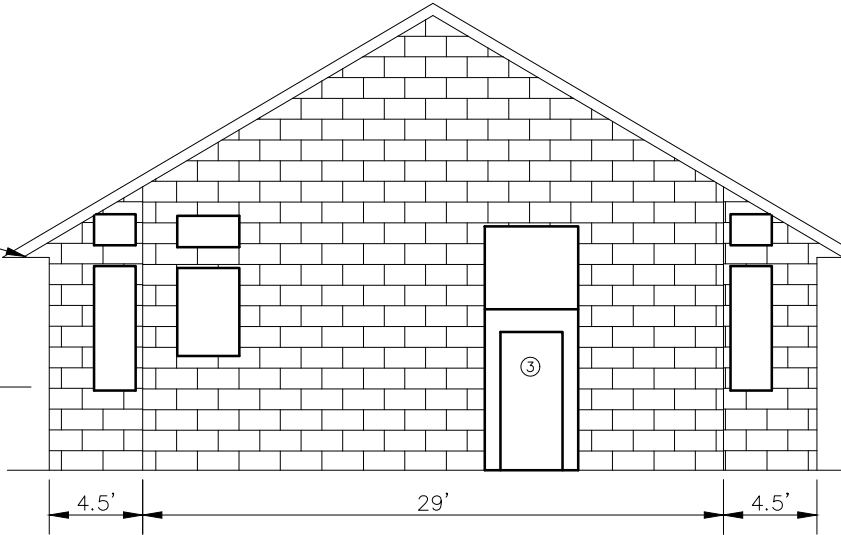

SOFFET &
 FASCIA TO
 BE PAINTED

NOTE:
 CANOPY OMITTED FROM EAST ELEVATION
 AND WEST ELEVATION VIEWS FOR WINDOW
 LOCATION CLARITY PURPOSES.

SOFFET &
 FASCIA TO
 BE PAINTED

EAST ELEVATION

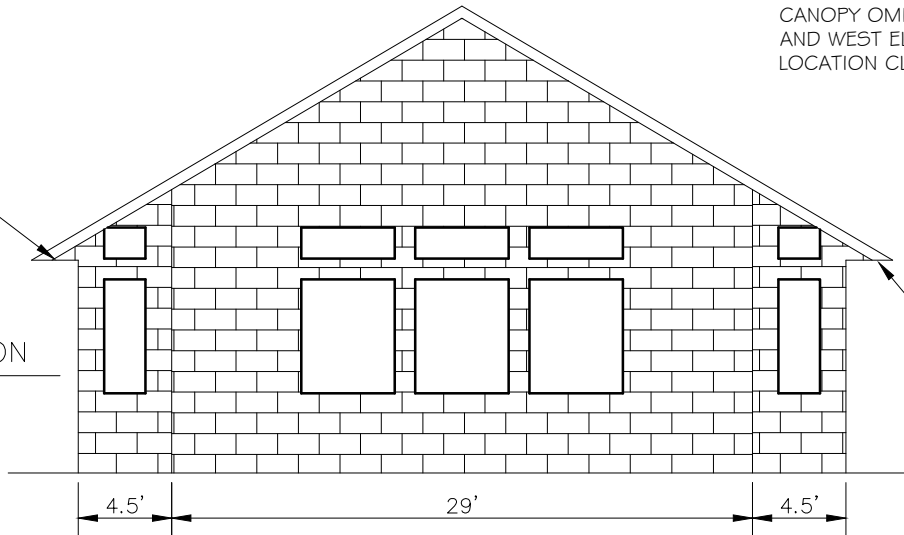

SOFFET &
 FASCIA TO
 BE PAINTED

NOTES

- 1) ALL MORTAR JOINTS SHALL BE INSPECTED AND TUCKPOINTED AS REQUIRED. ALL MASONRY SHALL BE CLEANED FOLLOWING TUCKPOINTING.
- 2) ALL EXTERIOR PAINTED SURFACES SHALL BE REPAINTED IN ACCORDANCE WITH THE SPECIFICATIONS.

DOOR SCHEDULE

SIZE	TYPE	EAST	WEST	TOTAL
① 4'-6" x 7'-9"	STANDARD DOOR	0	1	1
TOTAL				1

CHAMLIN
 ASSOCIATES
 PERU ILLINOIS MORRIS

SEC.: 13-00052-01-HP

LIVINGSTON
 COUNTY

DWIGHT DEPOT
 PAINTING, DOOR, & TUCKPOINTING PROJECT
 DEPOT EAST & WEST ELEVATIONS

DATE: 11/14/17

SHTS:
 4 OF 5

DRAWN BY:
 KEH

CHAMLIN & ASSOCIATES, INC. 2017
 Drawing Name: H:\AJOB\KORY\PROJECTS\2412-DWIGHT_TRANSPORTATION\WINDOWS_RESTORATION.dwg Last Modified: Nov 13, 2017 - 4:48pm Plotted on: Nov 13, 2017 - 4:50pm by: nickt

VILLAGE OF DWIGHT
 DWIGHT REGIONAL
 TRANSPORTATION CENTER/DEPOT
 REHABILITATION PROJECT

N.T.S.

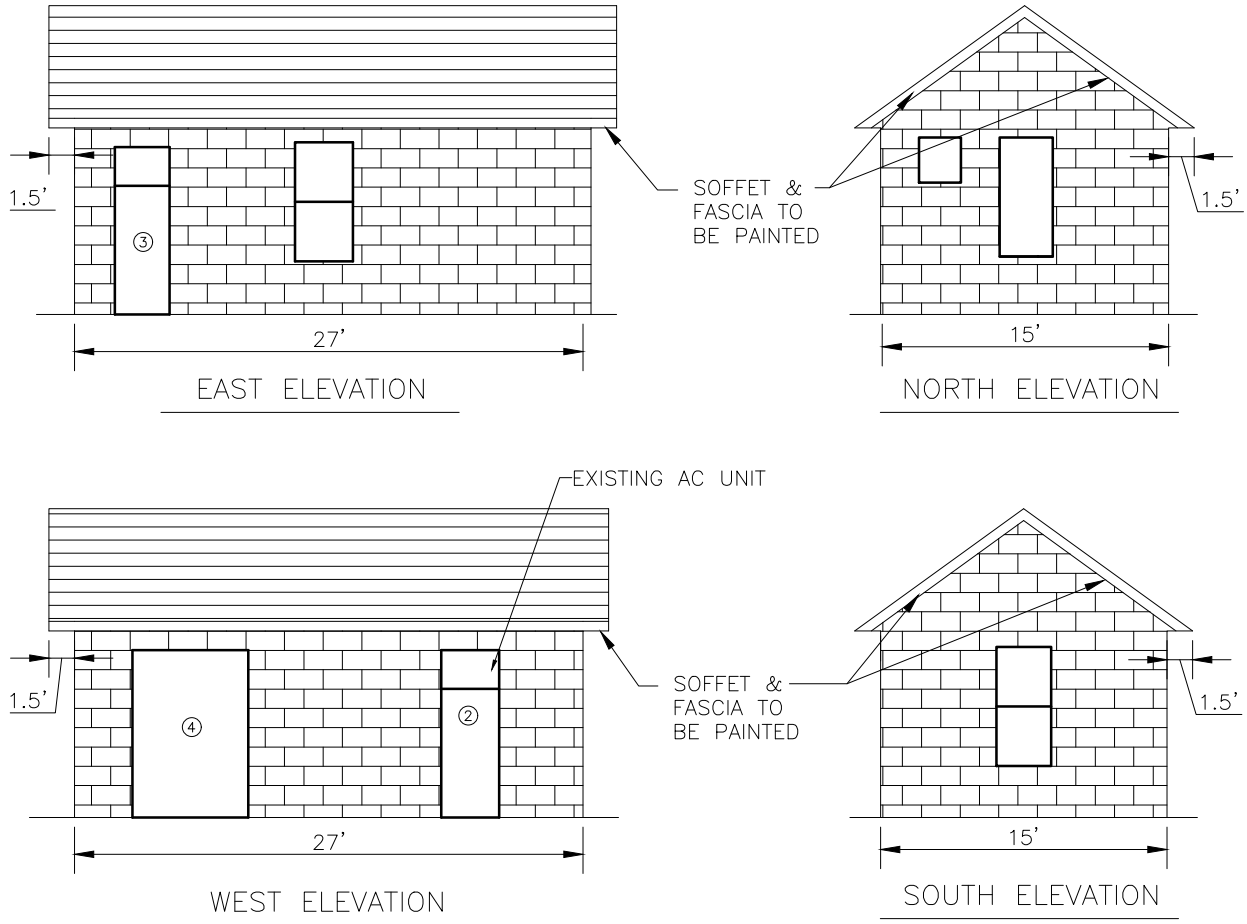

NOTES

- 1) ALL MORTAR JOINTS SHALL BE INSPECTED AND TUCKPOINTED AS REQUIRED. ALL MASONRY SHALL BE CLEANED FOLLOWING TUCKPOINTING.
- 2) ALL EXTERIOR PAINTED SURFACES SHALL BE REPAINTED IN ACCORDANCE WITH THE SPECIFICATIONS.

DOOR SCHEDULE

SIZE	TYPE	NORTH	SOUTH	EAST	WEST	TOTAL
② 3' x 6'-8"	ENTRY DOOR	0	0	0	1	1
③ 2'-10" x 6'-8"	ENTRY DOOR	0	0	1	0	1
④ 6' x 8'-8"	SLIDING DOOR	0	0	0	1	1
TOTAL						3

CHAMLIN
 ASSOCIATES
 PERU ILLINOIS MORRIS

SEC.: 13-00052-01-HP

LIVINGSTON
 COUNTY

DWIGHT DEPOT
 PAINTING, DOOR, & TUCKPOINTING PROJECT
 SHIPPING DEPOT ELEVATIONS

DATE: 11/14/17

SHTS:
 5 OF 5

DRAWN BY:
 KEH

CHAMLIN & ASSOCIATES, INC. 2017
 Drawing Name: H:\JOB\KORY\PROJECTS\2412-DWIGHT TRANSPORTATION\WINDOWS RESTORATION.dwg Last Modified: Nov 13, 2017 - 4:48pm Plotted on: Nov 13, 2017 - 4:49pm by nickt

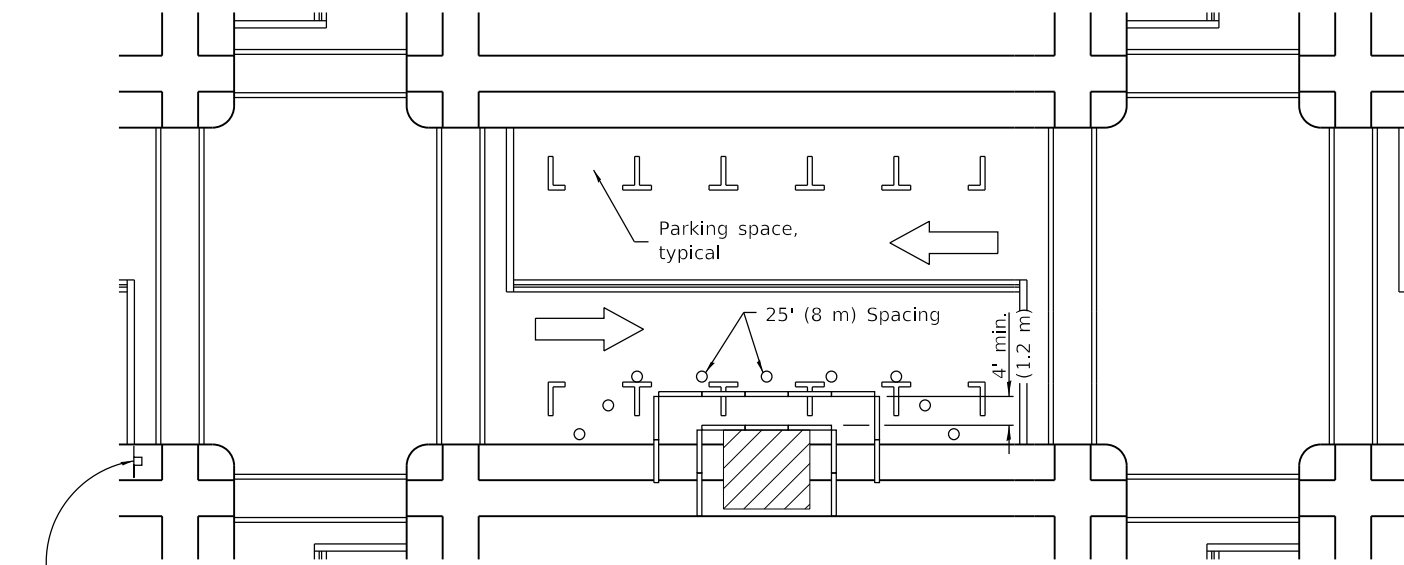

① ROAD CONSTRUCTION AHEAD
W20-1103(0)-48 for contract construction projects

Or
① ROAD WORK AHEAD
W20-1(0)-48 for maintenance and utility projects

SIDEWALK DIVERSION

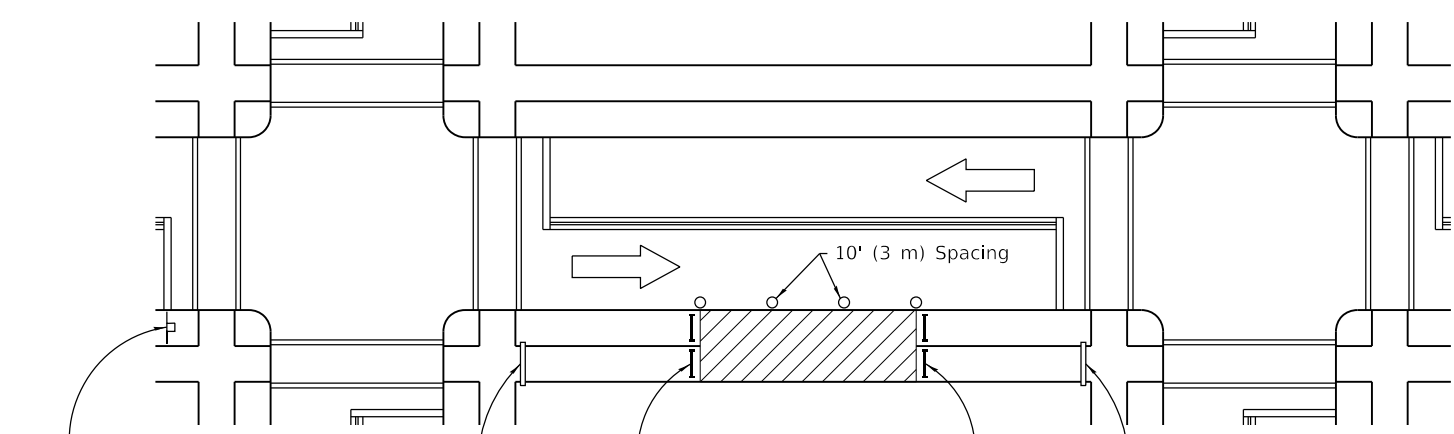

① ROAD CONSTRUCTION AHEAD
W20-1103(0)-48 for contract construction projects

Or
① ROAD WORK AHEAD
W20-1(0)-48 for maintenance and utility projects

R11-1102-2430
SIDEWALK CLOSED
USE OTHER SIDE

R11-1101-2418
SIDEWALK CLOSED

R11-1102-2430
SIDEWALK CLOSED
USE OTHER SIDE

SIDEWALK CLOSURE

① Omit whenever duplicated by road work traffic control.

GENERAL NOTES

This Standard is used where, at any time, pedestrian traffic must be rerouted due to work being performed.

This Standard must be used in conjunction with other Traffic Control & Protection Standards when roadway traffic is affected.

Temporary facilities shall be detectable and accessible.

The temporary pedestrian facilities shall be provided on the same side of the closed facilities whenever possible.

The SIDEWALK CLOSED / USE OTHER SIDE sign shall be placed at the nearest crosswalk or intersection to each end of the closure. Where the closure occurs at a corner, the signs shall be erected on the corners across the street from the closure. The SIDEWALK CLOSED signs shall be used at the ends of the actual closures.

Type III barricades and R11-2-4830 signs shall be positioned as shown in "ROAD CLOSED TO ALL TRAFFIC" detail on Standard 701901.

All dimensions are in inches (millimeters) unless otherwise shown.

SYMBOLS

- Work area
- Sign on portable or permanent support
- Barricade or drum
- Cone, drum or barricade
- Type III barricade
- Detectable pedestrian channelizing barricade

Illinois Department of Transportation

PASSED April 1, 2016
ENGINEER OF SAFETY ENGINEERING

APPROVED April 1, 2016
ENGINEER OF DESIGN AND ENVIRONMENT

ISSUED 1-1-97

DATE	REVISIONS
4-1-16	Omitted orange safety fence from standard as this is covered in the std. spec.
1-1-12	Added SIDEWALK DIVERSION. Modified appearance of plan views. Renamed Std.

SIDEWALK, CORNER OR CROSSWALK CLOSURE

(Sheet 1 of 2)

STANDARD 701801-06

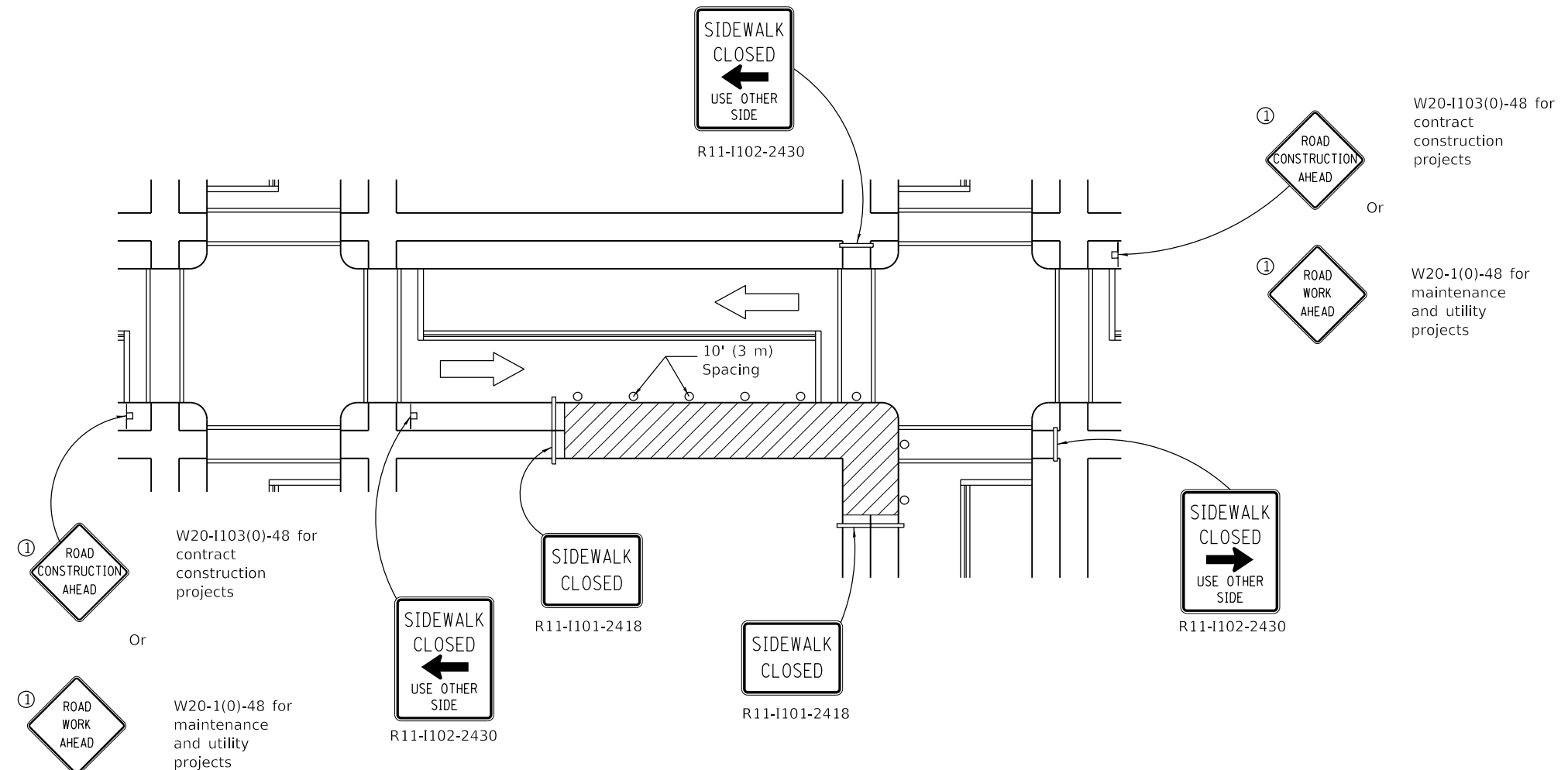

CORNER CLOSURE

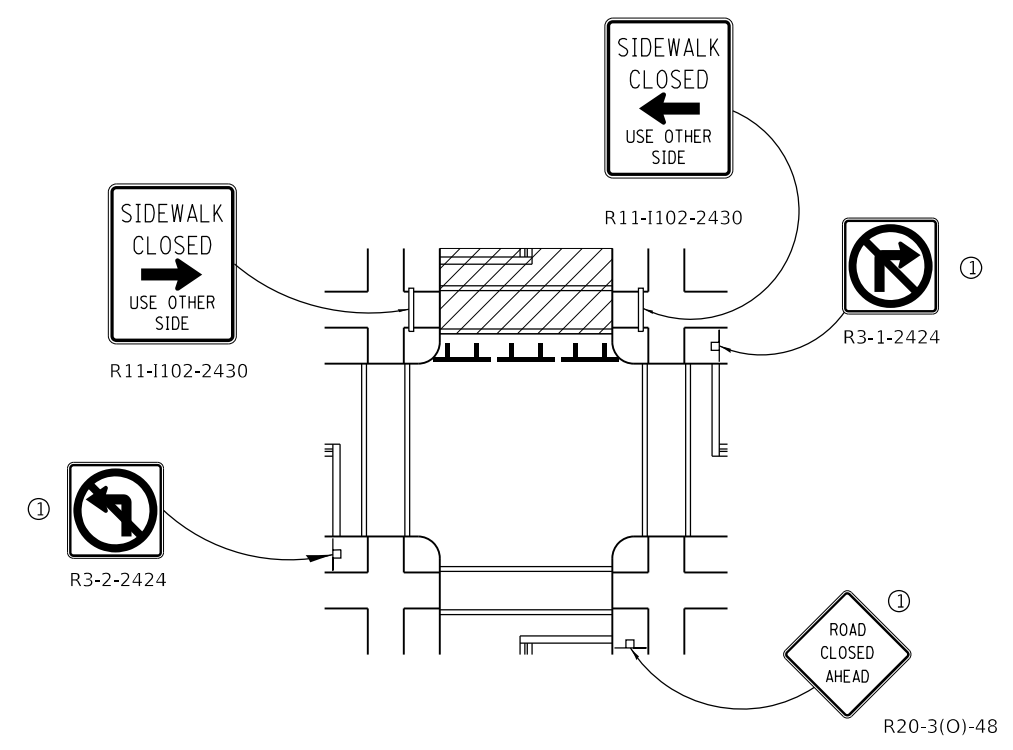

CROSSWALK CLOSURE

W20-I103(0)-48 for contract construction projects
Or
W20-1(0)-48 for maintenance and utility projects

SIDEWALK, CORNER OR CROSSWALK CLOSURE

(Sheet 2 of 2)

STANDARD 701801-06

Illinois Department of Transportation

PASSED April 1, 2016

[Signature]
ENGINEER OF SAFETY ENGINEERING

APPROVED April 1, 2016

[Signature]
ENGINEER OF DESIGN AND ENVIRONMENT

ISSUED 1-1-97

REQUIRED CONTRACT PROVISIONS FEDERAL-AID CONSTRUCTION CONTRACTS

- I. General
- II. Nondiscrimination
- III. Nonsegregated Facilities
- IV. Davis-Bacon and Related Act Provisions
- V. Contract Work Hours and Safety Standards Act Provisions
- VI. Subletting or Assigning the Contract
- VII. Safety: Accident Prevention
- VIII. False Statements Concerning Highway Projects
- IX. Implementation of Clean Air Act and Federal Water Pollution Control Act
- X. Compliance with Governmentwide Suspension and Debarment Requirements
- XI. Certification Regarding Use of Contract Funds for Lobbying

ATTACHMENTS

A. Employment and Materials Preference for Appalachian Development Highway System or Appalachian Local Access Road Contracts (included in Appalachian contracts only)

I. GENERAL

1. Form FHWA-1273 must be physically incorporated in each construction contract funded under Title 23 (excluding emergency contracts solely intended for debris removal). The contractor (or subcontractor) must insert this form in each subcontract and further require its inclusion in all lower tier subcontracts (excluding purchase orders, rental agreements and other agreements for supplies or services).

The applicable requirements of Form FHWA-1273 are incorporated by reference for work done under any purchase order, rental agreement or agreement for other services. The prime contractor shall be responsible for compliance by any subcontractor, lower-tier subcontractor or service provider.

Form FHWA-1273 must be included in all Federal-aid design-build contracts, in all subcontracts and in lower tier subcontracts (excluding subcontracts for design services, purchase orders, rental agreements and other agreements for supplies or services). The design-builder shall be responsible for compliance by any subcontractor, lower-tier subcontractor or service provider.

Contracting agencies may reference Form FHWA-1273 in bid proposal or request for proposal documents, however, the Form FHWA-1273 must be physically incorporated (not referenced) in all contracts, subcontracts and lower-tier subcontracts (excluding purchase orders, rental agreements and other agreements for supplies or services related to a construction contract).

2. Subject to the applicability criteria noted in the following sections, these contract provisions shall apply to all work performed on the contract by the contractor's own organization and with the assistance of workers under the contractor's immediate superintendence and to all work performed on the contract by piecework, station work, or by subcontract.

3. A breach of any of the stipulations contained in these Required Contract Provisions may be sufficient grounds for withholding of progress payments, withholding of final payment, termination of the contract, suspension / debarment or any other action determined to be appropriate by the contracting agency and FHWA.

4. Selection of Labor: During the performance of this contract, the contractor shall not use convict labor for any purpose within the limits of a construction project on a Federal-aid highway unless it is labor

performed by convicts who are on parole, supervised release, or probation. The term Federal-aid highway does not include roadways functionally classified as local roads or rural minor collectors.

II. NONDISCRIMINATION

The provisions of this section related to 23 CFR Part 230 are applicable to all Federal-aid construction contracts and to all related construction subcontracts of \$10,000 or more. The provisions of 23 CFR Part 230 are not applicable to material supply, engineering, or architectural service contracts.

In addition, the contractor and all subcontractors must comply with the following policies: Executive Order 11246, 41 CFR 60, 29 CFR 1625-1627, Title 23 USC Section 140, the Rehabilitation Act of 1973, as amended (29 USC 794), Title VI of the Civil Rights Act of 1964, as amended, and related regulations including 49 CFR Parts 21, 26 and 27; and 23 CFR Parts 200, 230, and 633.

The contractor and all subcontractors must comply with: the requirements of the Equal Opportunity Clause in 41 CFR 60-1.4(b) and, for all construction contracts exceeding \$10,000, the Standard Federal Equal Employment Opportunity Construction Contract Specifications in 41 CFR 60-4.3.

Note: The U.S. Department of Labor has exclusive authority to determine compliance with Executive Order 11246 and the policies of the Secretary of Labor including 41 CFR 60, and 29 CFR 1625-1627. The contracting agency and the FHWA have the authority and the responsibility to ensure compliance with Title 23 USC Section 140, the Rehabilitation Act of 1973, as amended (29 USC 794), and Title VI of the Civil Rights Act of 1964, as amended, and related regulations including 49 CFR Parts 21, 26 and 27; and 23 CFR Parts 200, 230, and 633.

The following provision is adopted from 23 CFR 230, Appendix A, with appropriate revisions to conform to the U.S. Department of Labor (US DOL) and FHWA requirements.

1. Equal Employment Opportunity: Equal employment opportunity (EEO) requirements not to discriminate and to take affirmative action to assure equal opportunity as set forth under laws, executive orders, rules, regulations (28 CFR 35, 29 CFR 1630, 29 CFR 1625-1627, 41 CFR 60 and 49 CFR 27) and orders of the Secretary of Labor as modified by the provisions prescribed herein, and imposed pursuant to 23 U.S.C. 140 shall constitute the EEO and specific affirmative action standards for the contractor's project activities under this contract. The provisions of the Americans with Disabilities Act of 1990 (42 U.S.C. 12101 et seq.) set forth under 28 CFR 35 and 29 CFR 1630 are incorporated by reference in this contract. In the execution of this contract, the contractor agrees to comply with the following minimum specific requirement activities of EEO:

a. The contractor will work with the contracting agency and the Federal Government to ensure that it has made every good faith effort to provide equal opportunity with respect to all of its terms and conditions of employment and in their review of activities under the contract.

b. The contractor will accept as its operating policy the following statement:

"It is the policy of this Company to assure that applicants are employed, and that employees are treated during employment, without regard to their race, religion, sex, color, national origin, age or disability. Such action shall include: employment, upgrading, demotion, or transfer; recruitment or recruitment advertising; layoff or termination; rates of pay or other forms of compensation; and selection

for training, including apprenticeship, pre-apprenticeship, and/or on-the-job training."

2. EEO Officer: The contractor will designate and make known to the contracting officers an EEO Officer who will have the responsibility for and must be capable of effectively administering and promoting an active EEO program and who must be assigned adequate authority and responsibility to do so.

3. Dissemination of Policy: All members of the contractor's staff who are authorized to hire, supervise, promote, and discharge employees, or who recommend such action, or who are substantially involved in such action, will be made fully cognizant of, and will implement, the contractor's EEO policy and contractual responsibilities to provide EEO in each grade and classification of employment. To ensure that the above agreement will be met, the following actions will be taken as a minimum:

a. Periodic meetings of supervisory and personnel office employees will be conducted before the start of work and then not less often than once every six months, at which time the contractor's EEO policy and its implementation will be reviewed and explained. The meetings will be conducted by the EEO Officer.

b. All new supervisory or personnel office employees will be given a thorough indoctrination by the EEO Officer, covering all major aspects of the contractor's EEO obligations within thirty days following their reporting for duty with the contractor.

c. All personnel who are engaged in direct recruitment for the project will be instructed by the EEO Officer in the contractor's procedures for locating and hiring minorities and women.

d. Notices and posters setting forth the contractor's EEO policy will be placed in areas readily accessible to employees, applicants for employment and potential employees.

e. The contractor's EEO policy and the procedures to implement such policy will be brought to the attention of employees by means of meetings, employee handbooks, or other appropriate means.

4. Recruitment: When advertising for employees, the contractor will include in all advertisements for employees the notation: "An Equal Opportunity Employer." All such advertisements will be placed in publications having a large circulation among minorities and women in the area from which the project work force would normally be derived.

a. The contractor will, unless precluded by a valid bargaining agreement, conduct systematic and direct recruitment through public and private employee referral sources likely to yield qualified minorities and women. To meet this requirement, the contractor will identify sources of potential minority group employees, and establish with such identified sources procedures whereby minority and women applicants may be referred to the contractor for employment consideration.

b. In the event the contractor has a valid bargaining agreement providing for exclusive hiring hall referrals, the contractor is expected to observe the provisions of that agreement to the extent that the system meets the contractor's compliance with EEO contract provisions. Where implementation of such an agreement has the effect of discriminating against minorities or women, or obligates the contractor to do the same, such implementation violates Federal nondiscrimination provisions.

c. The contractor will encourage its present employees to refer minorities and women as applicants for employment. Information and procedures with regard to referring such applicants will be discussed with employees.

5. Personnel Actions: Wages, working conditions, and employee benefits shall be established and administered, and personnel actions of every type, including hiring, upgrading, promotion, transfer, demotion, layoff, and termination, shall be taken without regard to race, color, religion, sex, national origin, age or disability. The following procedures shall be followed:

a. The contractor will conduct periodic inspections of project sites to insure that working conditions and employee facilities do not indicate discriminatory treatment of project site personnel.

b. The contractor will periodically evaluate the spread of wages paid within each classification to determine any evidence of discriminatory wage practices.

c. The contractor will periodically review selected personnel actions in depth to determine whether there is evidence of discrimination. Where evidence is found, the contractor will promptly take corrective action. If the review indicates that the discrimination may extend beyond the actions reviewed, such corrective action shall include all affected persons.

d. The contractor will promptly investigate all complaints of alleged discrimination made to the contractor in connection with its obligations under this contract, will attempt to resolve such complaints, and will take appropriate corrective action within a reasonable time. If the investigation indicates that the discrimination may affect persons other than the complainant, such corrective action shall include such other persons. Upon completion of each investigation, the contractor will inform every complainant of all of their avenues of appeal.

6. Training and Promotion:

a. The contractor will assist in locating, qualifying, and increasing the skills of minorities and women who are applicants for employment or current employees. Such efforts should be aimed at developing full journey level status employees in the type of trade or job classification involved.

b. Consistent with the contractor's work force requirements and as permissible under Federal and State regulations, the contractor shall make full use of training programs, i.e., apprenticeship, and on-the-job training programs for the geographical area of contract performance. In the event a special provision for training is provided under this contract, this subparagraph will be superseded as indicated in the special provision. The contracting agency may reserve training positions for persons who receive welfare assistance in accordance with 23 U.S.C. 140(a).

c. The contractor will advise employees and applicants for employment of available training programs and entrance requirements for each.

d. The contractor will periodically review the training and promotion potential of employees who are minorities and women and will encourage eligible employees to apply for such training and promotion.

7. Unions: If the contractor relies in whole or in part upon unions as a source of employees, the contractor will use good faith efforts to obtain the cooperation of such unions to increase opportunities for minorities and women. Actions by the contractor, either directly or through a contractor's association acting as agent, will include the procedures set forth below:

a. The contractor will use good faith efforts to develop, in cooperation with the unions, joint training programs aimed toward qualifying more minorities and women for membership in the unions and increasing the skills of minorities and women so that they may qualify for higher paying employment.

b. The contractor will use good faith efforts to incorporate an EEO clause into each union agreement to the end that such union will be contractually bound to refer applicants without regard to their race, color, religion, sex, national origin, age or disability.

c. The contractor is to obtain information as to the referral practices and policies of the labor union except that to the extent such information is within the exclusive possession of the labor union and such labor union refuses to furnish such information to the contractor, the contractor shall so certify to the contracting agency and shall set forth what efforts have been made to obtain such information.

d. In the event the union is unable to provide the contractor with a reasonable flow of referrals within the time limit set forth in the collective bargaining agreement, the contractor will, through independent recruitment efforts, fill the employment vacancies without regard to race, color, religion, sex, national origin, age or disability; making full efforts to obtain qualified and/or qualifiable minorities and women. The failure of a union to provide sufficient referrals (even though it is obligated to provide exclusive referrals under the terms of a collective bargaining agreement) does not relieve the contractor from the requirements of this paragraph. In the event the union referral practice prevents the contractor from meeting the obligations pursuant to Executive Order 11246, as amended, and these special provisions, such contractor shall immediately notify the contracting agency.

8. Reasonable Accommodation for Applicants / Employees with Disabilities: The contractor must be familiar with the requirements for and comply with the Americans with Disabilities Act and all rules and regulations established there under. Employers must provide reasonable accommodation in all employment activities unless to do so would cause an undue hardship.

9. Selection of Subcontractors, Procurement of Materials and Leasing of Equipment: The contractor shall not discriminate on the grounds of race, color, religion, sex, national origin, age or disability in the selection and retention of subcontractors, including procurement of materials and leases of equipment. The contractor shall take all necessary and reasonable steps to ensure nondiscrimination in the administration of this contract.

a. The contractor shall notify all potential subcontractors and suppliers and lessors of their EEO obligations under this contract.

b. The contractor will use good faith efforts to ensure subcontractor compliance with their EEO obligations.

10. Assurance Required by 49 CFR 26.13(b):

a. The requirements of 49 CFR Part 26 and the State DOT's U.S. DOT-approved DBE program are incorporated by reference.

b. The contractor or subcontractor shall not discriminate on the basis of race, color, national origin, or sex in the performance of this contract. The contractor shall carry out applicable requirements of 49 CFR Part 26 in the award and administration of DOT-assisted contracts. Failure by the contractor to carry out these requirements is a material breach of this contract, which may result in the termination of this contract or such other remedy as the contracting agency deems appropriate.

11. Records and Reports: The contractor shall keep such records as necessary to document compliance with the EEO requirements. Such records shall be retained for a period of three years following the date of the final payment to the contractor for all contract work and shall be available at reasonable times and places for inspection by authorized representatives of the contracting agency and the FHWA.

a. The records kept by the contractor shall document the following:

(1) The number and work hours of minority and non-minority group members and women employed in each work classification on the project;

(2) The progress and efforts being made in cooperation with unions, when applicable, to increase employment opportunities for minorities and women; and

(3) The progress and efforts being made in locating, hiring, training, qualifying, and upgrading minorities and women;

b. The contractors and subcontractors will submit an annual report to the contracting agency each July for the duration of the project, indicating the number of minority, women, and non-minority group employees currently engaged in each work classification required by the contract work. This information is to be reported on [Form FHWA-1391](#).

The staffing data should represent the project work force on board in all or any part of the last payroll period preceding the end of July. If on-the-job training is being required by special provision, the contractor will be required to collect and report training data. The employment data should reflect the work force on board during all or any part of the last payroll period preceding the end of July.

III. NONSEGREGATED FACILITIES

This provision is applicable to all Federal-aid construction contracts and to all related construction subcontracts of \$10,000 or more.

The contractor must ensure that facilities provided for employees are provided in such a manner that segregation on the basis of race, color, religion, sex, or national origin cannot result. The contractor may neither require such segregated use by written or oral policies nor tolerate such use by employee custom. The contractor's obligation extends further to ensure that its employees are not assigned to perform their services at any location, under the contractor's control, where the facilities are segregated. The term "facilities" includes waiting rooms, work areas, restaurants and other eating areas, time clocks, restrooms, washrooms, locker rooms, and other storage or dressing areas, parking lots, drinking fountains, recreation or entertainment areas, transportation, and housing provided for employees. The contractor shall provide separate or single-user restrooms and necessary dressing or sleeping areas to assure privacy between sexes.

IV. DAVIS-BACON AND RELATED ACT PROVISIONS

This section is applicable to all Federal-aid construction projects exceeding \$2,000 and to all related subcontracts and lower-tier subcontracts (regardless of subcontract size). The requirements apply to all projects located within the right-of-way of a roadway that is functionally classified as Federal-aid highway. This excludes roadways functionally classified as local roads or rural minor collectors, which are exempt. Contracting agencies may elect to apply these requirements to other projects.

The following provisions are from the U.S. Department of Labor regulations in 29 CFR 5.5 "Contract provisions and related matters" with minor revisions to conform to the FHWA-1273 format and FHWA program requirements.

1. Minimum wages

a. All laborers and mechanics employed or working upon the site of the work, will be paid unconditionally and not less often than once a week, and without subsequent deduction or rebate on any account (except such payroll deductions as are permitted by regulations issued by the Secretary of Labor under the Copeland Act (29 CFR part 3)), the full amount of wages and bona fide fringe benefits (or cash equivalents thereof) due at time of payment computed at rates not less than those contained in the wage determination of the Secretary of Labor which is attached hereto and made a part hereof, regardless of any contractual relationship which may be alleged to exist between the contractor and such laborers and mechanics.

Contributions made or costs reasonably anticipated for bona fide fringe benefits under section 1(b)(2) of the Davis-Bacon Act on behalf of laborers or mechanics are considered wages paid to such laborers or mechanics, subject to the provisions of paragraph 1.d. of this section; also, regular contributions made or costs incurred for more than a weekly period (but not less often than quarterly) under plans, funds, or programs which cover the particular weekly period, are deemed to be constructively made or incurred during such weekly period. Such laborers and mechanics shall be paid the appropriate wage rate and fringe benefits on the wage determination for the classification of work actually performed, without regard to skill, except as provided in 29 CFR 5.5(a)(4). Laborers or mechanics performing work in more than one classification may be compensated at the rate specified for each classification for the time actually worked therein: Provided, That the

employer's payroll records accurately set forth the time spent in each classification in which work is performed. The wage determination (including any additional classification and wage rates conformed under paragraph 1.b. of this section) and the Davis-Bacon poster (WH-1321) shall be posted at all times by the contractor and its subcontractors at the site of the work in a prominent and accessible place where it can be easily seen by the workers.

b. (1) The contracting officer shall require that any class of laborers or mechanics, including helpers, which is not listed in the wage determination and which is to be employed under the contract shall be classified in conformance with the wage determination. The contracting officer shall approve an additional classification and wage rate and fringe benefits therefore only when the following criteria have been met:

(i) The work to be performed by the classification requested is not performed by a classification in the wage determination; and

(ii) The classification is utilized in the area by the construction industry; and

(iii) The proposed wage rate, including any bona fide fringe benefits, bears a reasonable relationship to the wage rates contained in the wage determination.

(2) If the contractor and the laborers and mechanics to be employed in the classification (if known), or their representatives, and the contracting officer agree on the classification and wage rate (including the amount designated for fringe benefits where appropriate), a report of the action taken shall be sent by the contracting officer to the Administrator of the Wage and Hour Division, Employment Standards Administration, U.S. Department of Labor, Washington, DC 20210. The Administrator, or an authorized representative, will approve, modify, or disapprove every additional classification action within 30 days of receipt and so advise the contracting officer or will notify the contracting officer within the 30-day period that additional time is necessary.

(3) In the event the contractor, the laborers or mechanics to be employed in the classification or their representatives, and the contracting officer do not agree on the proposed classification and wage rate (including the amount designated for fringe benefits, where appropriate), the contracting officer shall refer the questions, including the views of all interested parties and the recommendation of the contracting officer, to the Wage and Hour Administrator for determination. The Wage and Hour Administrator, or an authorized representative, will issue a determination within 30 days of receipt and so advise the contracting officer or will notify the contracting officer within the 30-day period that additional time is necessary.

(4) The wage rate (including fringe benefits where appropriate) determined pursuant to paragraphs 1.b.(2) or 1.b.(3) of this section, shall be paid to all workers performing work in the classification under this contract from the first day on which work is performed in the classification.

c. Whenever the minimum wage rate prescribed in the contract for a class of laborers or mechanics includes a fringe benefit which is not expressed as an hourly rate, the contractor shall either pay the benefit as stated in the wage determination or shall pay another bona fide fringe benefit or an hourly cash equivalent thereof.

d. If the contractor does not make payments to a trustee or other third person, the contractor may consider as part of the wages of any laborer or mechanic the amount of any costs reasonably anticipated in providing bona fide fringe benefits under a plan or program, Provided, That the Secretary of Labor has found, upon the written request of the contractor, that the applicable standards of the Davis-Bacon Act have been met. The Secretary of Labor may require the contractor to set aside in a separate account assets for the meeting of obligations under the plan or program.

2. Withholding

The contracting agency shall upon its own action or upon written request of an authorized representative of the Department of Labor, withhold or cause to be withheld from the contractor under this contract, or any other Federal contract with the same prime contractor, or any other federally-assisted contract subject to Davis-Bacon prevailing wage requirements, which is held by the same prime contractor, so much of the accrued payments or advances as may be considered necessary to pay laborers and mechanics, including apprentices, trainees, and helpers, employed by the contractor or any subcontractor the full amount of wages required by the contract. In the event of failure to pay any laborer or mechanic, including any apprentice, trainee, or helper, employed or working on the site of the work, all or part of the wages required by the contract, the contracting agency may, after written notice to the contractor, take such action as may be necessary to cause the suspension of any further payment, advance, or guarantee of funds until such violations have ceased.

3. Payrolls and basic records

a. Payrolls and basic records relating thereto shall be maintained by the contractor during the course of the work and preserved for a period of three years thereafter for all laborers and mechanics working at the site of the work. Such records shall contain the name, address, and social security number of each such worker, his or her correct classification, hourly rates of wages paid (including rates of contributions or costs anticipated for bona fide fringe benefits or cash equivalents thereof of the types described in section 1(b)(2)(B) of the Davis-Bacon Act), daily and weekly number of hours worked, deductions made and actual wages paid. Whenever the Secretary of Labor has found under 29 CFR 5.5(a)(1)(iv) that the wages of any laborer or mechanic include the amount of any costs reasonably anticipated in providing benefits under a plan or program described in section 1(b)(2)(B) of the Davis-Bacon Act, the contractor shall maintain records which show that the commitment to provide such benefits is enforceable, that the plan or program is financially responsible, and that the plan or program has been communicated in writing to the laborers or mechanics affected, and records which show the costs anticipated or the actual cost incurred in providing such benefits. Contractors employing apprentices or trainees under approved programs shall maintain written evidence of the registration of apprenticeship programs and certification of trainee programs, the registration of the apprentices and trainees, and the ratios and wage rates prescribed in the applicable programs.

b. (1) The contractor shall submit weekly for each week in which any contract work is performed a copy of all payrolls to the contracting agency. The payrolls submitted shall set out accurately and completely all of the information required to be maintained under 29 CFR 5.5(a)(3)(i), except that full social security numbers and home addresses shall not be included on weekly transmittals. Instead the payrolls shall only need to include an individually identifying number for each employee (e.g. , the last four digits of the employee's social security number). The required weekly payroll information may be submitted in any form desired. Optional Form WH-347 is available for this purpose from the Wage and Hour Division Web site at <http://www.dol.gov/esa/whd/forms/wh347instr.htm> or its successor site. The prime contractor is responsible for the submission of copies of payrolls by all subcontractors. Contractors and subcontractors shall maintain the full social security number and current address of each covered worker, and shall provide them upon request to the contracting agency for transmission to the State DOT, the FHWA or the Wage and Hour Division of the Department of Labor for purposes of an investigation or audit of compliance with prevailing wage requirements. It is not a violation of this section for a prime contractor to require a subcontractor to provide addresses and social security numbers to the prime contractor for its own records, without weekly submission to the contracting agency..

(2) Each payroll submitted shall be accompanied by a "Statement of Compliance," signed by the contractor or subcontractor or his or her agent who pays or supervises the payment of the persons employed under the contract and shall certify the following:

(i) That the payroll for the payroll period contains the information required to be provided under §5.5 (a)(3)(ii) of Regulations, 29 CFR part 5, the appropriate information is being maintained under §5.5 (a)(3)(i) of Regulations, 29 CFR part 5, and that such information is correct and complete;

(ii) That each laborer or mechanic (including each helper, apprentice, and trainee) employed on the contract during the payroll period has been paid the full weekly wages earned, without rebate, either directly or indirectly, and that no deductions have been made either directly or indirectly from the full wages earned, other than permissible deductions as set forth in Regulations, 29 CFR part 3;

(iii) That each laborer or mechanic has been paid not less than the applicable wage rates and fringe benefits or cash equivalents for the classification of work performed, as specified in the applicable wage determination incorporated into the contract.

(3) The weekly submission of a properly executed certification set forth on the reverse side of Optional Form WH-347 shall satisfy the requirement for submission of the "Statement of Compliance" required by paragraph 3.b.(2) of this section.

(4) The falsification of any of the above certifications may subject the contractor or subcontractor to civil or criminal prosecution under section 1001 of title 18 and section 231 of title 31 of the United States Code.

c. The contractor or subcontractor shall make the records required under paragraph 3.a. of this section available for inspection, copying, or transcription by authorized representatives of the contracting agency, the State DOT, the FHWA, or the Department of Labor, and shall permit such representatives to interview employees during working hours on the job. If the contractor or subcontractor fails to submit the required records or to make them available, the FHWA may, after written notice to the contractor, the contracting agency or the State DOT, take such action as may be necessary to cause the suspension of any further payment, advance, or guarantee of funds. Furthermore, failure to submit the required records upon request or to make such records available may be grounds for debarment action pursuant to 29 CFR 5.12.

4. Apprentices and trainees

a. Apprentices (programs of the USDOL).

Apprentices will be permitted to work at less than the predetermined rate for the work they performed when they are employed pursuant to and individually registered in a bona fide apprenticeship program registered with the U.S. Department of Labor, Employment and Training Administration, Office of Apprenticeship Training, Employer and Labor Services, or with a State Apprenticeship Agency recognized by the Office, or if a person is employed in his or her first 90 days of probationary employment as an apprentice in such an apprenticeship program, who is not individually registered in the program, but who has been certified by the Office of Apprenticeship Training, Employer and Labor Services or a State Apprenticeship Agency (where appropriate) to be eligible for probationary employment as an apprentice.

The allowable ratio of apprentices to journeymen on the job site in any craft classification shall not be greater than the ratio permitted to the contractor as to the entire work force under the registered program. Any worker listed on a payroll at an apprentice wage rate, who is not registered or otherwise employed as stated above, shall be paid not less than the applicable wage rate on the wage determination for the classification of work actually performed. In addition, any apprentice performing work on the job site in excess of the ratio permitted under the registered program shall be paid not less than the applicable wage rate on the wage determination for the work actually performed. Where a contractor is performing construction on a project in a locality other than that in which its program is registered, the ratios and wage rates

(expressed in percentages of the journeyman's hourly rate) specified in the contractor's or subcontractor's registered program shall be observed.

Every apprentice must be paid at not less than the rate specified in the registered program for the apprentice's level of progress, expressed as a percentage of the journeymen hourly rate specified in the applicable wage determination. Apprentices shall be paid fringe benefits in accordance with the provisions of the apprenticeship program. If the apprenticeship program does not specify fringe benefits, apprentices must be paid the full amount of fringe benefits listed on the wage determination for the applicable classification. If the Administrator determines that a different practice prevails for the applicable apprentice classification, fringes shall be paid in accordance with that determination.

In the event the Office of Apprenticeship Training, Employer and Labor Services, or a State Apprenticeship Agency recognized by the Office, withdraws approval of an apprenticeship program, the contractor will no longer be permitted to utilize apprentices at less than the applicable predetermined rate for the work performed until an acceptable program is approved.

b. Trainees (programs of the USDOL).

Except as provided in 29 CFR 5.16, trainees will not be permitted to work at less than the predetermined rate for the work performed unless they are employed pursuant to and individually registered in a program which has received prior approval, evidenced by formal certification by the U.S. Department of Labor, Employment and Training Administration.

The ratio of trainees to journeymen on the job site shall not be greater than permitted under the plan approved by the Employment and Training Administration.

Every trainee must be paid at not less than the rate specified in the approved program for the trainee's level of progress, expressed as a percentage of the journeyman hourly rate specified in the applicable wage determination. Trainees shall be paid fringe benefits in accordance with the provisions of the trainee program. If the trainee program does not mention fringe benefits, trainees shall be paid the full amount of fringe benefits listed on the wage determination unless the Administrator of the Wage and Hour Division determines that there is an apprenticeship program associated with the corresponding journeyman wage rate on the wage determination which provides for less than full fringe benefits for apprentices. Any employee listed on the payroll at a trainee rate who is not registered and participating in a training plan approved by the Employment and Training Administration shall be paid not less than the applicable wage rate on the wage determination for the classification of work actually performed. In addition, any trainee performing work on the job site in excess of the ratio permitted under the registered program shall be paid not less than the applicable wage rate on the wage determination for the work actually performed.

In the event the Employment and Training Administration withdraws approval of a training program, the contractor will no longer be permitted to utilize trainees at less than the applicable predetermined rate for the work performed until an acceptable program is approved.

c. Equal employment opportunity. The utilization of apprentices, trainees and journeymen under this part shall be in conformity with the equal employment opportunity requirements of Executive Order 11246, as amended, and 29 CFR part 30.

d. Apprentices and Trainees (programs of the U.S. DOT).

Apprentices and trainees working under apprenticeship and skill training programs which have been certified by the Secretary of Transportation as promoting EEO in connection with Federal-aid highway construction programs are not subject to the requirements of paragraph 4 of this Section IV. The straight time hourly wage rates for apprentices and trainees under such programs will be established by the particular

programs. The ratio of apprentices and trainees to journeymen shall not be greater than permitted by the terms of the particular program.

5. Compliance with Copeland Act requirements. The contractor shall comply with the requirements of 29 CFR part 3, which are incorporated by reference in this contract.

6. Subcontracts. The contractor or subcontractor shall insert Form FHWA-1273 in any subcontracts and also require the subcontractors to include Form FHWA-1273 in any lower tier subcontracts. The prime contractor shall be responsible for the compliance by any subcontractor or lower tier subcontractor with all the contract clauses in 29 CFR 5.5.

7. Contract termination: debarment. A breach of the contract clauses in 29 CFR 5.5 may be grounds for termination of the contract, and for debarment as a contractor and a subcontractor as provided in 29 CFR 5.12.

8. Compliance with Davis-Bacon and Related Act requirements. All rulings and interpretations of the Davis-Bacon and Related Acts contained in 29 CFR parts 1, 3, and 5 are herein incorporated by reference in this contract.

9. Disputes concerning labor standards. Disputes arising out of the labor standards provisions of this contract shall not be subject to the general disputes clause of this contract. Such disputes shall be resolved in accordance with the procedures of the Department of Labor set forth in 29 CFR parts 5, 6, and 7. Disputes within the meaning of this clause include disputes between the contractor (or any of its subcontractors) and the contracting agency, the U.S. Department of Labor, or the employees or their representatives.

10. Certification of eligibility.

a. By entering into this contract, the contractor certifies that neither it (nor he or she) nor any person or firm who has an interest in the contractor's firm is a person or firm ineligible to be awarded Government contracts by virtue of section 3(a) of the Davis-Bacon Act or 29 CFR 5.12(a)(1).

b. No part of this contract shall be subcontracted to any person or firm ineligible for award of a Government contract by virtue of section 3(a) of the Davis-Bacon Act or 29 CFR 5.12(a)(1).

c. The penalty for making false statements is prescribed in the U.S. Criminal Code, 18 U.S.C. 1001.

V. CONTRACT WORK HOURS AND SAFETY STANDARDS ACT

The following clauses apply to any Federal-aid construction contract in an amount in excess of \$100,000 and subject to the overtime provisions of the Contract Work Hours and Safety Standards Act. These clauses shall be inserted in addition to the clauses required by 29 CFR 5.5(a) or 29 CFR 4.6. As used in this paragraph, the terms laborers and mechanics include watchmen and guards.

1. Overtime requirements. No contractor or subcontractor contracting for any part of the contract work which may require or involve the employment of laborers or mechanics shall require or permit any such laborer or mechanic in any workweek in which he or she is employed on such work to work in excess of forty hours in such workweek unless such laborer or mechanic receives compensation at a rate not less than one and one-half times the basic rate of pay for all hours worked in excess of forty hours in such workweek.

2. Violation; liability for unpaid wages; liquidated damages. In the event of any violation of the clause set forth in paragraph (1.) of this

section, the contractor and any subcontractor responsible therefor shall be liable for the unpaid wages. In addition, such contractor and subcontractor shall be liable to the United States (in the case of work done under contract for the District of Columbia or a territory, to such District or to such territory), for liquidated damages. Such liquidated damages shall be computed with respect to each individual laborer or mechanic, including watchmen and guards, employed in violation of the clause set forth in paragraph (1.) of this section, in the sum of \$10 for each calendar day on which such individual was required or permitted to work in excess of the standard workweek of forty hours without payment of the overtime wages required by the clause set forth in paragraph (1.) of this section.

3. Withholding for unpaid wages and liquidated damages. The FHWA or the contracting agency shall upon its own action or upon written request of an authorized representative of the Department of Labor withhold or cause to be withheld, from any moneys payable on account of work performed by the contractor or subcontractor under any such contract or any other Federal contract with the same prime contractor, or any other federally-assisted contract subject to the Contract Work Hours and Safety Standards Act, which is held by the same prime contractor, such sums as may be determined to be necessary to satisfy any liabilities of such contractor or subcontractor for unpaid wages and liquidated damages as provided in the clause set forth in paragraph (2.) of this section.

4. Subcontracts. The contractor or subcontractor shall insert in any subcontracts the clauses set forth in paragraph (1.) through (4.) of this section and also a clause requiring the subcontractors to include these clauses in any lower tier subcontracts. The prime contractor shall be responsible for compliance by any subcontractor or lower tier subcontractor with the clauses set forth in paragraphs (1.) through (4.) of this section.

VI. SUBLETTING OR ASSIGNING THE CONTRACT

This provision is applicable to all Federal-aid construction contracts on the National Highway System.

1. The contractor shall perform with its own organization contract work amounting to not less than 30 percent (or a greater percentage if specified elsewhere in the contract) of the total original contract price, excluding any specialty items designated by the contracting agency. Specialty items may be performed by subcontract and the amount of any such specialty items performed may be deducted from the total original contract price before computing the amount of work required to be performed by the contractor's own organization (23 CFR 635.116).

a. The term "perform work with its own organization" refers to workers employed or leased by the prime contractor, and equipment owned or rented by the prime contractor, with or without operators. Such term does not include employees or equipment of a subcontractor or lower tier subcontractor, agents of the prime contractor, or any other assignees. The term may include payments for the costs of hiring leased employees from an employee leasing firm meeting all relevant Federal and State regulatory requirements. Leased employees may only be included in this term if the prime contractor meets all of the following conditions:

- (1) the prime contractor maintains control over the supervision of the day-to-day activities of the leased employees;
- (2) the prime contractor remains responsible for the quality of the work of the leased employees;
- (3) the prime contractor retains all power to accept or exclude individual employees from work on the project; and
- (4) the prime contractor remains ultimately responsible for the payment of predetermined minimum wages, the submission of payrolls, statements of compliance and all other Federal regulatory requirements.

b. "Specialty Items" shall be construed to be limited to work that requires highly specialized knowledge, abilities, or equipment not ordinarily available in the type of contracting organizations qualified and expected to bid or propose on the contract as a whole and in general are to be limited to minor components of the overall contract.

2. The contract amount upon which the requirements set forth in paragraph (1) of Section VI is computed includes the cost of material and manufactured products which are to be purchased or produced by the contractor under the contract provisions.

3. The contractor shall furnish (a) a competent superintendent or supervisor who is employed by the firm, has full authority to direct performance of the work in accordance with the contract requirements, and is in charge of all construction operations (regardless of who performs the work) and (b) such other of its own organizational resources (supervision, management, and engineering services) as the contracting officer determines is necessary to assure the performance of the contract.

4. No portion of the contract shall be sublet, assigned or otherwise disposed of except with the written consent of the contracting officer, or authorized representative, and such consent when given shall not be construed to relieve the contractor of any responsibility for the fulfillment of the contract. Written consent will be given only after the contracting agency has assured that each subcontract is evidenced in writing and that it contains all pertinent provisions and requirements of the prime contract.

5. The 30% self-performance requirement of paragraph (1) is not applicable to design-build contracts; however, contracting agencies may establish their own self-performance requirements.

VII. SAFETY: ACCIDENT PREVENTION

This provision is applicable to all Federal-aid construction contracts and to all related subcontracts.

1. In the performance of this contract the contractor shall comply with all applicable Federal, State, and local laws governing safety, health, and sanitation (23 CFR 635). The contractor shall provide all safeguards, safety devices and protective equipment and take any other needed actions as it determines, or as the contracting officer may determine, to be reasonably necessary to protect the life and health of employees on the job and the safety of the public and to protect property in connection with the performance of the work covered by the contract.

2. It is a condition of this contract, and shall be made a condition of each subcontract, which the contractor enters into pursuant to this contract, that the contractor and any subcontractor shall not permit any employee, in performance of the contract, to work in surroundings or under conditions which are unsanitary, hazardous or dangerous to his/her health or safety, as determined under construction safety and health standards (29 CFR 1926) promulgated by the Secretary of Labor, in accordance with Section 107 of the Contract Work Hours and Safety Standards Act (40 U.S.C. 3704).

3. Pursuant to 29 CFR 1926.3, it is a condition of this contract that the Secretary of Labor or authorized representative thereof, shall have right of entry to any site of contract performance to inspect or investigate the matter of compliance with the construction safety and health standards and to carry out the duties of the Secretary under Section 107 of the Contract Work Hours and Safety Standards Act (40 U.S.C.3704).

VIII. FALSE STATEMENTS CONCERNING HIGHWAY PROJECTS

This provision is applicable to all Federal-aid construction contracts and to all related subcontracts.

In order to assure high quality and durable construction in conformity with approved plans and specifications and a high degree of reliability on statements and representations made by engineers, contractors, suppliers, and workers on Federal-aid highway projects, it is essential

that all persons concerned with the project perform their functions as carefully, thoroughly, and honestly as possible. Willful falsification, distortion, or misrepresentation with respect to any facts related to the project is a violation of Federal law. To prevent any misunderstanding regarding the seriousness of these and similar acts, Form FHWA-1022 shall be posted on each Federal-aid highway project (23 CFR 635) in one or more places where it is readily available to all persons concerned with the project:

18 U.S.C. 1020 reads as follows:

"Whoever, being an officer, agent, or employee of the United States, or of any State or Territory, or whoever, whether a person, association, firm, or corporation, knowingly makes any false statement, false representation, or false report as to the character, quality, quantity, or cost of the material used or to be used, or the quantity or quality of the work performed or to be performed, or the cost thereof in connection with the submission of plans, maps, specifications, contracts, or costs of construction on any highway or related project submitted for approval to the Secretary of Transportation; or

Whoever knowingly makes any false statement, false representation, false report or false claim with respect to the character, quality, quantity, or cost of any work performed or to be performed, or materials furnished or to be furnished, in connection with the construction of any highway or related project approved by the Secretary of Transportation; or

Whoever knowingly makes any false statement or false representation as to material fact in any statement, certificate, or report submitted pursuant to provisions of the Federal-aid Roads Act approved July 1, 1916, (39 Stat. 355), as amended and supplemented;

Shall be fined under this title or imprisoned not more than 5 years or both."

IX. IMPLEMENTATION OF CLEAN AIR ACT AND FEDERAL WATER POLLUTION CONTROL ACT

This provision is applicable to all Federal-aid construction contracts and to all related subcontracts.

By submission of this bid/proposal or the execution of this contract, or subcontract, as appropriate, the bidder, proposer, Federal-aid construction contractor, or subcontractor, as appropriate, will be deemed to have stipulated as follows:

1. That any person who is or will be utilized in the performance of this contract is not prohibited from receiving an award due to a violation of Section 508 of the Clean Water Act or Section 306 of the Clean Air Act.

2. That the contractor agrees to include or cause to be included the requirements of paragraph (1) of this Section X in every subcontract, and further agrees to take such action as the contracting agency may direct as a means of enforcing such requirements.

X. CERTIFICATION REGARDING DEBARMENT, SUSPENSION, INELIGIBILITY AND VOLUNTARY EXCLUSION

This provision is applicable to all Federal-aid construction contracts, design-build contracts, subcontracts, lower-tier subcontracts, purchase orders, lease agreements, consultant contracts or any other covered transaction requiring FHWA approval or that is estimated to cost \$25,000 or more – as defined in 2 CFR Parts 180 and 1200.

1. Instructions for Certification – First Tier Participants:

a. By signing and submitting this proposal, the prospective first tier participant is providing the certification set out below.

b. The inability of a person to provide the certification set out below will not necessarily result in denial of participation in this covered transaction.

The prospective first tier participant shall submit an explanation of why it cannot provide the certification set out below. The certification or explanation will be considered in connection with the department or agency's determination whether to enter into this transaction. However, failure of the prospective first tier participant to furnish a certification or an explanation shall disqualify such a person from participation in this transaction.

c. The certification in this clause is a material representation of fact upon which reliance was placed when the contracting agency determined to enter into this transaction. If it is later determined that the prospective participant knowingly rendered an erroneous certification, in addition to other remedies available to the Federal Government, the contracting agency may terminate this transaction for cause of default.

d. The prospective first tier participant shall provide immediate written notice to the contracting agency to whom this proposal is submitted if any time the prospective first tier participant learns that its certification was erroneous when submitted or has become erroneous by reason of changed circumstances.

e. The terms "covered transaction," "debarred," "suspended," "ineligible," "participant," "person," "principal," and "voluntarily excluded," as used in this clause, are defined in 2 CFR Parts 180 and 1200. "First Tier Covered Transactions" refers to any covered transaction between a grantee or subgrantee of Federal funds and a participant (such as the prime or general contractor). "Lower Tier Covered Transactions" refers to any covered transaction under a First Tier Covered Transaction (such as subcontracts). "First Tier Participant" refers to the participant who has entered into a covered transaction with a grantee or subgrantee of Federal funds (such as the prime or general contractor). "Lower Tier Participant" refers any participant who has entered into a covered transaction with a First Tier Participant or other Lower Tier Participants (such as subcontractors and suppliers).

f. The prospective first tier participant agrees by submitting this proposal that, should the proposed covered transaction be entered into, it shall not knowingly enter into any lower tier covered transaction with a person who is debarred, suspended, declared ineligible, or voluntarily excluded from participation in this covered transaction, unless authorized by the department or agency entering into this transaction.

g. The prospective first tier participant further agrees by submitting this proposal that it will include the clause titled "Certification Regarding Debarment, Suspension, Ineligibility and Voluntary Exclusion-Lower Tier Covered Transactions," provided by the department or contracting agency, entering into this covered transaction, without modification, in all lower tier covered transactions and in all solicitations for lower tier covered transactions exceeding the \$25,000 threshold.

h. A participant in a covered transaction may rely upon a certification of a prospective participant in a lower tier covered transaction that is not debarred, suspended, ineligible, or voluntarily excluded from the covered transaction, unless it knows that the certification is erroneous. A participant is responsible for ensuring that its principals are not suspended, debarred, or otherwise ineligible to participate in covered transactions. To verify the eligibility of its principals, as well as the eligibility of any lower tier prospective participants, each participant may, but is not required to, check the Excluded Parties List System website (<https://www.epls.gov/>), which is compiled by the General Services Administration.

i. Nothing contained in the foregoing shall be construed to require the establishment of a system of records in order to render in good faith the certification required by this clause. The knowledge and information of the prospective participant is not required to exceed that which is normally possessed by a prudent person in the ordinary course of business dealings.

j. Except for transactions authorized under paragraph (f) of these instructions, if a participant in a covered transaction knowingly enters into a lower tier covered transaction with a person who is suspended, debarred, ineligible, or voluntarily excluded from participation in this transaction, in addition to other remedies available to the Federal

Government, the department or agency may terminate this transaction for cause or default.

* * * * *

2. Certification Regarding Debarment, Suspension, Ineligibility and Voluntary Exclusion – First Tier Participants:

a. The prospective first tier participant certifies to the best of its knowledge and belief, that it and its principals:

(1) Are not presently debarred, suspended, proposed for debarment, declared ineligible, or voluntarily excluded from participating in covered transactions by any Federal department or agency;

(2) Have not within a three-year period preceding this proposal been convicted of or had a civil judgment rendered against them for commission of fraud or a criminal offense in connection with obtaining, attempting to obtain, or performing a public (Federal, State or local) transaction or contract under a public transaction; violation of Federal or State antitrust statutes or commission of embezzlement, theft, forgery, bribery, falsification or destruction of records, making false statements, or receiving stolen property;

(3) Are not presently indicted for or otherwise criminally or civilly charged by a governmental entity (Federal, State or local) with commission of any of the offenses enumerated in paragraph (a)(2) of this certification; and

(4) Have not within a three-year period preceding this application/proposal had one or more public transactions (Federal, State or local) terminated for cause or default.

b. Where the prospective participant is unable to certify to any of the statements in this certification, such prospective participant shall attach an explanation to this proposal.

2. Instructions for Certification - Lower Tier Participants:

(Applicable to all subcontracts, purchase orders and other lower tier transactions requiring prior FHWA approval or estimated to cost \$25,000 or more - 2 CFR Parts 180 and 1200)

a. By signing and submitting this proposal, the prospective lower tier is providing the certification set out below.

b. The certification in this clause is a material representation of fact upon which reliance was placed when this transaction was entered into. If it is later determined that the prospective lower tier participant knowingly rendered an erroneous certification, in addition to other remedies available to the Federal Government, the department, or agency with which this transaction originated may pursue available remedies, including suspension and/or debarment.

c. The prospective lower tier participant shall provide immediate written notice to the person to which this proposal is submitted if at any time the prospective lower tier participant learns that its certification was erroneous by reason of changed circumstances.

d. The terms "covered transaction," "debarred," "suspended," "ineligible," "participant," "person," "principal," and "voluntarily excluded," as used in this clause, are defined in 2 CFR Parts 180 and 1200. You may contact the person to which this proposal is submitted for assistance in obtaining a copy of those regulations. "First Tier Covered Transactions" refers to any covered transaction between a grantee or subgrantee of Federal funds and a participant (such as the prime or general contractor). "Lower Tier Covered Transactions" refers to any covered transaction under a First Tier Covered Transaction (such as subcontracts). "First Tier Participant" refers to the participant who has entered into a covered transaction with a grantee or subgrantee of Federal funds (such as the prime or general contractor). "Lower Tier Participant" refers any participant who has entered into a covered transaction with a First Tier Participant or other Lower Tier Participants (such as subcontractors and suppliers).

e. The prospective lower tier participant agrees by submitting this proposal that, should the proposed covered transaction be entered into, it shall not knowingly enter into any lower tier covered transaction with a person who is debarred, suspended, declared ineligible, or voluntarily excluded from participation in this covered transaction, unless authorized by the department or agency with which this transaction originated.

f. The prospective lower tier participant further agrees by submitting this proposal that it will include this clause titled "Certification Regarding Debarment, Suspension, Ineligibility and Voluntary Exclusion-Lower Tier Covered Transaction," without modification, in all lower tier covered transactions and in all solicitations for lower tier covered transactions exceeding the \$25,000 threshold.

g. A participant in a covered transaction may rely upon a certification of a prospective participant in a lower tier covered transaction that is not debarred, suspended, ineligible, or voluntarily excluded from the covered transaction, unless it knows that the certification is erroneous. A participant is responsible for ensuring that its principals are not suspended, debarred, or otherwise ineligible to participate in covered transactions. To verify the eligibility of its principals, as well as the eligibility of any lower tier prospective participants, each participant may, but is not required to, check the Excluded Parties List System website (<https://www.epls.gov/>), which is compiled by the General Services Administration.

h. Nothing contained in the foregoing shall be construed to require establishment of a system of records in order to render in good faith the certification required by this clause. The knowledge and information of participant is not required to exceed that which is normally possessed by a prudent person in the ordinary course of business dealings.

i. Except for transactions authorized under paragraph e of these instructions, if a participant in a covered transaction knowingly enters into a lower tier covered transaction with a person who is suspended, debarred, ineligible, or voluntarily excluded from participation in this transaction, in addition to other remedies available to the Federal Government, the department or agency with which this transaction originated may pursue available remedies, including suspension and/or debarment.

* * * * *

Certification Regarding Debarment, Suspension, Ineligibility and Voluntary Exclusion--Lower Tier Participants:

1. The prospective lower tier participant certifies, by submission of this proposal, that neither it nor its principals is presently debarred, suspended, proposed for debarment, declared ineligible, or voluntarily excluded from participating in covered transactions by any Federal department or agency.

2. Where the prospective lower tier participant is unable to certify to any of the statements in this certification, such prospective participant shall attach an explanation to this proposal.

* * * * *

XI. CERTIFICATION REGARDING USE OF CONTRACT FUNDS FOR LOBBYING

This provision is applicable to all Federal-aid construction contracts and to all related subcontracts which exceed \$100,000 (49 CFR 20).

1. The prospective participant certifies, by signing and submitting this bid or proposal, to the best of his or her knowledge and belief, that:

a. No Federal appropriated funds have been paid or will be paid, by or on behalf of the undersigned, to any person for influencing or attempting to influence an officer or employee of any Federal agency, a Member of Congress, an officer or employee of Congress, or an employee of a Member of Congress in connection with the awarding of any Federal contract, the making of any Federal grant, the making of any Federal loan, the entering into of any cooperative agreement, and the extension,

continuation, renewal, amendment, or modification of any Federal contract, grant, loan, or cooperative agreement.

b. If any funds other than Federal appropriated funds have been paid or will be paid to any person for influencing or attempting to influence an officer or employee of any Federal agency, a Member of Congress, an officer or employee of Congress, or an employee of a Member of Congress in connection with this Federal contract, grant, loan, or cooperative agreement, the undersigned shall complete and submit Standard Form-LLL, "Disclosure Form to Report Lobbying," in accordance with its instructions.

2. This certification is a material representation of fact upon which reliance was placed when this transaction was made or entered into. Submission of this certification is a prerequisite for making or entering into this transaction imposed by 31 U.S.C. 1352. Any person who fails to file the required certification shall be subject to a civil penalty of not less than \$10,000 and not more than \$100,000 for each such failure.

3. The prospective participant also agrees by submitting its bid or proposal that the participant shall require that the language of this certification be included in all lower tier subcontracts, which exceed \$100,000 and that all such recipients shall certify and disclose accordingly.

ATTACHMENT A - EMPLOYMENT AND MATERIALS PREFERENCE FOR APPALACHIAN DEVELOPMENT HIGHWAY SYSTEM OR APPALACHIAN LOCAL ACCESS ROAD CONTRACTS

This provision is applicable to all Federal-aid projects funded under the Appalachian Regional Development Act of 1965.

1. During the performance of this contract, the contractor undertaking to do work which is, or reasonably may be, done as on-site work, shall give preference to qualified persons who regularly reside in the labor area as designated by the DOL wherein the contract work is situated, or the subregion, or the Appalachian counties of the State wherein the contract work is situated, except:

a. To the extent that qualified persons regularly residing in the area are not available.

b. For the reasonable needs of the contractor to employ supervisory or specially experienced personnel necessary to assure an efficient execution of the contract work.

c. For the obligation of the contractor to offer employment to present or former employees as the result of a lawful collective bargaining contract, provided that the number of nonresident persons employed under this subparagraph (1c) shall not exceed 20 percent of the total number of employees employed by the contractor on the contract work, except as provided in subparagraph (4) below.

2. The contractor shall place a job order with the State Employment Service indicating (a) the classifications of the laborers, mechanics and other employees required to perform the contract work, (b) the number of employees required in each classification, (c) the date on which the participant estimates such employees will be required, and (d) any other pertinent information required by the State Employment Service to complete the job order form. The job order may be placed with the State Employment Service in writing or by telephone. If during the course of the contract work, the information submitted by the contractor in the original job order is substantially modified, the participant shall promptly notify the State Employment Service.

3. The contractor shall give full consideration to all qualified job applicants referred to him by the State Employment Service. The contractor is not required to grant employment to any job applicants who, in his opinion, are not qualified to perform the classification of work required.

4. If, within one week following the placing of a job order by the contractor with the State Employment Service, the State Employment Service is unable to refer any qualified job applicants to the contractor, or less than the number requested, the State Employment Service will forward a certificate to the contractor indicating the unavailability of applicants. Such certificate shall be made a part of the contractor's permanent project records. Upon receipt of this certificate, the contractor may employ persons who do not normally reside in the labor area to fill positions covered by the certificate, notwithstanding the provisions of subparagraph (1c) above.

5. The provisions of 23 CFR 633.207(e) allow the contracting agency to provide a contractual preference for the use of mineral resource materials native to the Appalachian region.

6. The contractor shall include the provisions of Sections 1 through 4 of this Attachment A in every subcontract for work which is, or reasonably may be, done as on-site work.

Contract Provision - Cargo Preference Requirements

In accordance with Title 46 CFR § 381.7 (b), the contractor agrees—

“(1) To utilize privately owned United States-flag commercial vessels to ship at least 50 percent of the gross tonnage (computed separately for dry bulk carriers, dry cargo liners, and tankers) involved, whenever shipping any equipment, material, or commodities pursuant to this contract, to the extent such vessels are available at fair and reasonable rates for United States-flag commercial vessels.

(2) To furnish within 20 days following the date of loading for shipments originating within the United States or within 30 working days following the date of loading for shipments originating outside the United States, a legible copy of a rated, ‘on-board’ commercial ocean bill-of-lading in English for each shipment of cargo described in paragraph (b) (1) of this section to both the Contracting Officer (through the prime contractor in the case of subcontractor bills-of-lading) and to the Division of National Cargo, Office of Market Development, Maritime Administration, Washington, DC 20590.

(3) To insert the substance of the provisions of this clause in all subcontracts issued pursuant to this contract.”

Provisions (1) and (2) apply to materials or equipment that are acquired solely for the project. The two provisions do not apply to goods or materials that come into inventories independent of the project, such as shipments of Portland cement, asphalt cement, or aggregates, when industry suppliers and contractors use these materials to replenish existing inventories.

**MINIMUM WAGES FOR FEDERAL AND FEDERALLY
ASSISTED CONSTRUCTION CONTRACTS**

This project is funded, in part, with Federal-aid funds and, as such, is subject to the provisions of the Davis-Bacon Act of March 3, 1931, as amended (46 Sta. 1494, as amended, 40 U.S.C. 276a) and of other Federal statutes referred to in a 29 CFR Part 1, Appendix A, as well as such additional statutes as may from time to time be enacted containing provisions for the payment of wages determined to be prevailing by the Secretary of Labor in accordance with the Davis-Bacon Act and pursuant to the provisions of 29 CFR Part 1. The prevailing rates and fringe benefits shown in the General Wage Determination Decisions issued by the U.S. Department of Labor shall, in accordance with the provisions of the foregoing statutes, constitute the minimum wages payable on Federal and federally assisted construction projects to laborers and mechanics of the specified classes engaged on contract work of the character and in the localities described therein.

General Wage Determination Decisions, modifications and supersedes decisions thereto are to be used in accordance with the provisions of 29 CFR Parts 1 and 5. Accordingly, the applicable decision, together with any modifications issued, must be made a part of every contract for performance of the described work within the geographic area indicated as required by an applicable DBRA Federal prevailing wage law and 29 CFR Part 5. The wage rates and fringe benefits contained in the General Wage Determination Decision shall be the minimum paid by contractors and subcontractors to laborers and mechanics.