

If you plan to submit a bid directly to the Department of Transportation

PREQUALIFICATION

Any contractor who desires to become pre-qualified to bid on work advertised by IDOT must submit the properly completed pre-qualification forms to the Bureau of Construction no later than 4:30 p.m. prevailing time twenty-one days prior to the letting of interest. This pre-qualification requirement applies to first time contractors, contractors renewing expired ratings, contractors maintaining continuous pre-qualification or contractors requesting revised ratings. To be eligible to bid, existing pre-qualification ratings must be effective through the date of letting.

REQUESTS FOR AUTHORIZATION TO BID

Contractors downloading and/or ordering CD-ROM's and are wanting to bid on items included in a particular letting must submit the properly completed "Request for Authorization to Bid/or Not For Bid Status" (BDE 124INT) and the ORIGINAL, signed and notarized, "Affidavit of Availability" (BC 57) to the proper office no later than 4:30 p.m. prevailing time, three (3) days prior to the letting date.

WHO CAN BID ?

Bids will be accepted from only those companies that request and receive written **Authorization to Bid** from IDOT's Central Bureau of Construction.

WHAT CONSTITUTES WRITTEN AUTHORIZATION TO BID? When a prospective prime bidder submits a "Request for Authorization to Bid/or Not For Bid Status" (BDE 124INT) he/she must indicate at that time which items are being requested For Bidding purposes. Only those items requested For Bidding will be analyzed. After the request has been analyzed, the bidder will be issued a **Proposal Denial and/or Authorization Form**, approved by the Central Bureau of Construction, that indicates which items have been approved For Bidding. If **Authorization to Bid** cannot be approved, the **Proposal Denial and/or Authorization Form** will indicate the reason for denial.

ABOUT AUTHORIZATION TO BID: Firms that have not received an authorization form within a reasonable time of complete and correct original document submittal should contact the department as to status. This is critical in the week before the letting. These documents must be received three days before the letting date. Firms unsure as to authorization status should call the Prequalification Section of the Bureau of Construction at the number listed at the end of these instructions.

ADDENDA AND REVISIONS: It is the contractor's responsibility to determine which, if any, addenda or revisions pertain to any project they may be bidding. Failure to incorporate all relevant addenda or revisions may cause the bid to be declared unacceptable.

Each addendum will be placed with the contract number. Addenda and revisions will also be placed on the Addendum/Revision Checklist and each subscription service subscriber will be notified by e-mail of each addendum and revision issued.

The Internet is the Department's primary way of doing business. The subscription server e-mails are an added courtesy the Department provides. It is suggested that bidder check IDOT's website <http://www.dot.il.gov/desenv/delett.html> before submitting final bid information.

IDOT is not responsible for any e-mail related failures.

Addenda Questions may be directed to the Contracts Office at (217)782-7806 or D&Econtracts@dot.il.gov

Technical Questions about downloading these files may be directed to Tim Garman (217)524-1642 or garmantr@dot.il.gov.

WHAT MUST BE INCLUDED WHEN BIDS ARE SUBMITTED?: Bidders need not return the entire proposal when bids are submitted. That portion of the proposal that must be returned includes the following:

1. All documents from the Proposal Cover Sheet through the Proposal Bid Bond
2. Other special documentation and/or information that may be required by the contract special provisions

All proposal documents, including Proposal Guaranty Checks or Proposal Bid Bonds, should be stapled together to prevent loss when bids are processed by IDOT personnel.

ABOUT SUBMITTING BIDS: It is recommended that bidders deliver bids in person to insure they arrive at the proper location prior to the time specified for the receipt of bids. Any bid received at the place of letting after the time specified will not be accepted.

WHO SHOULD BE CALLED IF ASSISTANCE IS NEEDED?

Questions Regarding	Call
Prequalification and/or Authorization to Bid	(217)782-3413
Preparation and submittal of bids	(217)782-7806
Mailing of plans and proposals	(217)782-7806
Electronic plans and proposals	(217)524-1642

ADDENDUMS AND REVISIONS TO THE PROPOSAL FORMS

Planholders should verify that they have received and incorporated the addendum and/or revision prior to submitting their bid. Failure by the bidder to include an addendum could result in a bid being rejected as irregular.

27

RETURN WITH BID

Proposal Submitted By
Name
Address
City

Letting January 20, 2006

BIDDERS NEED NOT RETURN THE ENTIRE PROPOSAL
(See instructions inside front cover)

NOTICE TO PROSPECTIVE BIDDERS
 This proposal can be used for bidding purposes by only those companies that request and receive written AUTHORIZATION TO BID from IDOT's Central Bureau of Construction.
 (SEE INSTRUCTIONS ON THE INSIDE OF COVER)

Notice To Bidders, Specifications, Proposal, Contract and Contract Bond



**Illinois Department
of Transportation**

Springfield, Illinois 62764

**Contract No. 68529
PEORIA County
Section D4 TRAFFIC SIGNALS 2006
District 4 Construction Funds
Route FAP 315**

PLEASE MARK THE APPROPRIATE BOX BELOW:

A Bid Bond is included.

A Cashier's Check or a Certified Check is included.

Plans Included
Herein

Prepared by	
Checked by	S

(Printed by authority of the State of Illinois)

INSTRUCTIONS

ABOUT IDOT PROPOSALS: All proposals issued by IDOT are potential bidding proposals. Each proposal contains all Certifications and Affidavits, a Proposal Signature Sheet and a Proposal Bid Bond required for Prime Contractors to submit a bid after written **Authorization to Bid** has been issued by IDOT's Central Bureau of Construction.

WHO CAN BID?: Bids will be accepted from only those companies that request and receive written **Authorization to Bid** from IDOT's Central Bureau of Construction. To request authorization, a potential bidder must complete and submit Part B of the Request for Authorization to Bid/or Not For Bid Status form (BDE 124 INT) and submit an original Affidavit of Availability (BC 57).

WHAT CONSTITUTES WRITTEN AUTHORIZATION TO BID?: When a prospective prime bidder submits a "Request for Proposal Forms and Plans" he/she must indicate at that time which items are being requested For Bidding purposes. Only those items requested For Bidding will be analyzed. After the request has been analyzed, the bidder will be issued a **Proposal Denial and/or Authorization Form**, approved by the Central Bureau of Construction, that indicates which items have been approved For Bidding. If **Authorization to Bid** cannot be approved, the **Proposal Denial and/or Authorization Form** will indicate the reason for denial. If a contractor has requested to bid but has not received a **Proposal Denial and/or Authorization Form**, they should contact the Central Bureau of Construction in advance of the letting date.

WHAT MUST BE INCLUDED WHEN BIDS ARE SUBMITTED?: Bidders need not return the entire proposal when bids are submitted. That portion of the proposal that must be returned includes the following:

1. All documents from the Proposal Cover Sheet through the Proposal Bid Bond
2. Other special documentation and/or information that may be required by the contract special provisions

All proposal documents, including Proposal Guaranty Checks or Proposal Bid Bonds, should be stapled together to prevent loss when bids are processed by IDOT personnel.

ABOUT SUBMITTING BIDS: It is recommended that bidders deliver bids in person to insure they arrive at the proper location prior to the time specified for the receipt of bids. Any bid received at the place of letting after the time specified will not be accepted.

WHO SHOULD BE CALLED IF ASSISTANCE IS NEEDED?

Questions Regarding	Call
Prequalification and/or Authorization to Bid	217/782-3413
Preparation and submittal of bids	217/782-7806
Mailing of CD-ROMS	217/782-7806

RETURN WITH BID



PROPOSAL

TO THE DEPARTMENT OF TRANSPORTATION

1. Proposal of _____

Taxpayer Identification Number (Mandatory) _____

for the improvement identified and advertised for bids in the Invitation for Bids as:

**Contract No. 68529
PEORIA County
Section D4 TRAFFIC SIGNALS 2006
Route FAP 315
District 4 Construction Funds**

This project consists of installation of fiber optic traffic signal interconnect cable in existing conduit along U.S. Route 150 (War Memorial Drive) from the intersection of Big Hollow/Willow Knolls Road to Glen/Sterling Avenue and from the intersection of Prospect Avenue to the intersection of Illinois Route 29 (Adams Street) in Peoria.

2. The undersigned bidder will furnish all labor, material and equipment to complete the above described project in a good and workmanlike manner as provided in the contract documents provided by the Department of Transportation. This proposal will become part of the contract and the terms and conditions contained in the contract documents shall govern performance and payments.

RETURN WITH BID

6. **COMBINATION BIDS.** The undersigned further agrees that if awarded the contract for the sections contained in the following combination, he/she will perform the work in accordance with the requirements of each individual proposal comprising the combination bid specified in the schedule below, and that the combination bid shall be prorated against each section in proportion to the bid submitted for the same. If an error is found to exist in the gross sum bid for one or more of the individual sections included in a combination, the combination bid shall be corrected as provided in the specifications.

When a combination bid is submitted, the schedule below must be completed in each proposal comprising the combination.

If alternate bids are submitted for one or more of the sections comprising the combination, a combination bid must be submitted for each alternate.

Schedule of Combination Bids

Combination No.	Sections Included in Combination	Combination Bid	
		Dollars	Cents

7. **SCHEDULE OF PRICES.** The undersigned bidder submits herewith, in accordance with the rules and instructions, a schedule of prices for the items of work for which bids are sought. The unit prices bid are in U.S. dollars and cents, and all extensions and summations have been made. The bidder understands that the quantities appearing in the bid schedule are approximate and are provided for the purpose of obtaining a gross sum for the comparison of bids. If there is an error in the extension of the unit prices, the unit prices shall govern. Payment to the contractor awarded the contract will be made only for actual quantities of work performed and accepted or materials furnished according to the contract. The scheduled quantities of work to be done and materials to be furnished may be increased, decreased or omitted as provided elsewhere in the contract.

8. **CERTIFICATE OF AUTHORITY.** The undersigned bidder, if a business organized under the laws of another State, assures the Department that it will furnish a copy of its certificate of authority to do business in the State of Illinois with the return of the executed contract and bond. Failure to furnish the certificate within the time provided for execution of an awarded contract may be cause for cancellation of the award and forfeiture of the proposal guaranty to the State.

ILLINOIS DEPARTMENT OF TRANSPORTATION
 SCHEDULE OF PRICES
 CONTRACT
 NUMBER - 68529

State Job # - C-94-140-05
 PPS NBR - 0-00856-4026
 County Name - PEORIA- -
 Code - 143 - -
 District - 4 - -
 Section Number - D4 TRAFFIC SIGNALS 2006

Project Number

Route
 FAP 315

Item Number	Pay Item Description	Unit of Measure	Quantity	x	Unit Price	=	Total Price
X0323909	DATA NETWORK PORT ADP	EACH	8.000				
X8110170	REP EX CONDUIT ATT ST	L SUM	1.000				
X8710020	FOCC62.5/125 MM12SM12	FOOT	23,027.000				
X8710050	FO ETN DROP REPEAT SW	EACH	9.000				
X8710070	FO INTER CENTER 24F	EACH	3.000				
67100100	MOBILIZATION	L SUM	1.000				
70102632	TR CONT & PROT 701602	L SUM	1.000				
70102635	TR CONT & PROT 701701	L SUM	1.000				
81306100	JUNCTION BOX SPL	EACH	2.000				

CONTRACT NUMBER

68529

THIS IS THE TOTAL BID

\$ _____

NOTES:

1. Each PAY ITEM should have a UNIT PRICE and a TOTAL PRICE.
2. The UNIT PRICE shall govern if no TOTAL PRICE is shown or if there is a discrepancy between the product of the UNIT PRICE multiplied by the QUANTITY.
3. If a UNIT PRICE is omitted, the TOTAL PRICE will be divided by the QUANTITY in order to establish a UNIT PRICE.
4. A bid may be declared UNACCEPTABLE if neither a unit price nor a total price is shown.

RETURN WITH BID

STATE REQUIRED ETHICAL STANDARDS GOVERNING CONTRACT PROCUREMENT: ASSURANCES, CERTIFICATIONS AND DISCLOSURES

I. GENERAL

A. Article 50 of the Illinois Procurement Code establishes the duty of all State chief procurement officers, State purchasing officers, and their designees to maximize the value of the expenditure of public moneys in procuring goods, services, and contracts for the State of Illinois and to act in a manner that maintains the integrity and public trust of State government. In discharging this duty, they are charged by law to use all available information, reasonable efforts, and reasonable actions to protect, safeguard, and maintain the procurement process of the State of Illinois.

B. In order to comply with the provisions of Article 50 and to carry out the duty established therein, all bidders are to adhere to ethical standards established for the procurement process, and to make such assurances, disclosures and certifications required by law. By execution of the Proposal Signature Sheet, the bidder indicates that each of the mandated assurances has been read and understood, that each certification is made and understood, and that each disclosure requirement has been understood and completed.

C. In addition to all other remedies provided by law, failure to comply with any assurance, failure to make any disclosure or the making of a false certification shall be grounds for termination of the contract and the suspension or debarment of the bidder.

II. ASSURANCES

A. The assurances hereinafter made by the bidder are each a material representation of fact upon which reliance is placed should the Department enter into the contract with the bidder. The Department may terminate the contract if it is later determined that the bidder rendered a false or erroneous assurance, and the surety providing the performance bond shall be responsible for the completion of the contract.

B. Felons

1. The Illinois Procurement Code provides:

Section 50-10. Felons. Unless otherwise provided, no person or business convicted of a felony shall do business with the State of Illinois or any state agency from the date of conviction until 5 years after the date of completion of the sentence for that felony, unless no person held responsible by a prosecutorial office for the facts upon which the conviction was based continues to have any involvement with the business.

2. The bidder assures the Department that the award and execution of the contract would not cause a violation of Section 50-10.

C. Conflicts of Interest

1. The Illinois Procurement Code provides in pertinent part:

Section 50-13. Conflicts of Interest.

(a) Prohibition. It is unlawful for any person holding an elective office in this State, holding a seat in the General Assembly, or appointed to or employed in any of the offices or agencies of state government and who receives compensation for such employment in excess of 60% of the salary of the Governor of the State of Illinois, or who is an officer or employee of the Capital Development Board or the Illinois Toll Highway Authority, or who is the spouse or minor child of any such person to have or acquire any contract, or any direct pecuniary interest in any contract therein, whether for stationery, printing, paper, or any services, materials, or supplies, that will be wholly or partially satisfied by the payment of funds appropriated by the General Assembly of the State of Illinois or in any contract of the Capital Development Board or the Illinois Toll Highway authority.

(b) Interests. It is unlawful for any firm, partnership, association or corporation, in which any person listed in subsection (a) is entitled to receive (i) more than 7 1/2% of the total distributable income or (ii) an amount in excess of the salary of the Governor, to have or acquire any such contract or direct pecuniary interest therein.

(c) Combined interests. It is unlawful for any firm, partnership, association, or corporation, in which any person listed in subsection (a) together with his or her spouse or minor children is entitled to receive (i) more than 15%, in the aggregate, of the total distributable income or (ii) an amount in excess of 2 times the salary of the Governor, to have or acquire any such contract or direct pecuniary interest therein.

(d) Securities. Nothing in this Section invalidates the provisions of any bond or other security previously offered or to be offered for sale or sold by or for the State of Illinois.

(e) Prior interests. This Section does not affect the validity of any contract made between the State and an officer or employee of the State or member of the General Assembly, his or her spouse, minor child or any combination of those persons if that contract was in existence before his or her election or employment as an officer, member, or employee. The contract is voidable, however, if it cannot be completed within 365 days after the officer, member, or employee takes office or is employed.

The current salary of the Governor is \$150,700.00. Sixty percent of the salary is \$90,420.00.

RETURN WITH BID

2. The bidder assures the Department that the award and execution of the contract would not cause a violation of Section 50-13, or that an effective exemption has been issued by the Board of Ethics to any individual subject to the Section 50-13 prohibitions pursuant to the provisions of Section 50-20 of the Code and Executive Order Number 3 (1998). Information concerning the exemption process is available from the Department upon request.

D. Negotiations

1. The Illinois Procurement Code provides in pertinent part:

Section 50-15. Negotiations.

(a) It is unlawful for any person employed in or on a continual contractual relationship with any of the offices or agencies of State government to participate in contract negotiations on behalf of that office or agency with any firm, partnership, association, or corporation with whom that person has a contract for future employment or is negotiating concerning possible future employment.

2. The bidder assures the Department that the award and execution of the contract would not cause a violation of Section 50-15, and that the bidder has no knowledge of any facts relevant to the kinds of acts prohibited therein.

E. Inducements

1. The Illinois Procurement Code provides:

Section 50-25. Inducement. Any person who offers or pays any money or other valuable thing to any person to induce him or her not to bid for a State contract or as recompense for not having bid on a State contract is guilty of a Class 4 felony. Any person who accepts any money or other valuable thing for not bidding for a State contract or who withholds a bid in consideration of the promise for the payment of money or other valuable thing is guilty of a Class 4 felony.

2. The bidder assures the Department that the award and execution of the contract would not cause a violation of Section 50-25, and that the bidder has no knowledge of any facts relevant to the kinds of acts prohibited therein.

F. Revolving Door Prohibition

1. The Illinois Procurement Code provides:

Section 50-30. Revolving door prohibition. Chief procurement officers, associate procurement officers, State purchasing officers, their designees whose principal duties are directly related to State procurement, and executive officers confirmed by the Senate are expressly prohibited for a period of 2 years after terminating an affected position from engaging in any procurement activity relating to the State agency most recently employing them in an affected position for a period of at least 6 months. The prohibition includes, but is not limited to: lobbying the procurement process; specifying; bidding; proposing bid, proposal, or contract documents; on their own behalf or on behalf of any firm, partnership, association, or corporation. This Section applies only to persons who terminate an affected position on or after January 15, 1999.

2. The bidder assures the Department that the award and execution of the contract would not cause a violation of Section 50-30, and that the bidder has no knowledge of any facts relevant to the kinds of acts prohibited therein.

G. Reporting Anticompetitive Practices

1. The Illinois Procurement Code provides:

Section 50-40. Reporting anticompetitive practices. When, for any reason, any vendor, bidder, contractor, chief procurement officer, State purchasing officer, designee, elected official, or State employee suspects collusion or other anticompetitive practice among any bidders, offerors, contractors, proposers, or employees of the State, a notice of the relevant facts shall be transmitted to the Attorney General and the chief procurement officer.

2. The bidder assures the Department that it has not failed to report any relevant facts concerning the practices addressed in Section 50-40 which may involve the contract for which the bid is submitted.

H. Confidentiality

1. The Illinois Procurement Code provides:

Section 50-45. Confidentiality. Any chief procurement officer, State purchasing officer, designee, or executive officer who willfully uses or allows the use of specifications, competitive bid documents, proprietary competitive information, proposals, contracts, or selection information to compromise the fairness or integrity of the procurement, bidding, or contract process shall be subject to immediate dismissal, regardless of the Personnel code, any contract, or any collective bargaining agreement, and may in addition be subject to criminal prosecution.

2. The bidder assures the Department that it has no knowledge of any fact relevant to the practices addressed in Section 50-45 which may involve the contract for which the bid is submitted.

RETURN WITH BID

I. Insider Information

1. The Illinois Procurement Act provides:

Section 50-50. Insider information. It is unlawful for any current or former elected or appointed State official or State employee to knowingly use confidential information available only by virtue of that office or employment for actual or anticipated gain for themselves or another person.

2. The bidder assures the Department that it has no knowledge of any facts relevant to the practices addressed in Section 50-50 which may involve the contract for which the bid is submitted.

III. CERTIFICATIONS

A. The certifications hereinafter made by the bidder are each a material representation of fact upon which reliance is placed should the Department enter into the contract with the bidder. The Department may terminate the contract if it is later determined that the bidder rendered a false or erroneous certification, and the surety providing the performance bond shall be responsible for completion of the contract.

B. Bribery

1. The Illinois Procurement Code provides:

Section 50-5. Bribery.

(a) Prohibition. No person or business shall be awarded a contract or subcontract under this Code who:

(1) has been convicted under the laws of Illinois or any other state of bribery or attempting to bribe an officer or employee of the State of Illinois or any other state in that officer's or employee's official capacity; or

(2) has made an admission of guilt of that conduct that is a matter of record but has not been prosecuted for that conduct.

(b) Businesses. No business shall be barred from contracting with any unit of State or local government as a result of a conviction under this Section of any employee or agent of the business if the employee or agent is no longer employed by the business and:

(1) the business has been finally adjudicated not guilty; or

(2) the business demonstrates to the governmental entity with which it seeks to contract, and that entity finds that the commission of the offense was not authorized, requested, commanded, or performed by a director, officer, or high managerial agent on behalf of the business as provided in paragraph (2) of subsection (a) of Section 5-4 of the Criminal Code of 1961.

(c) Conduct on behalf of business. For purposes of this Section, when an official, agent, or employee of a business committed the bribery or attempted bribery on behalf of the business and in accordance with the direction or authorization of a responsible official of the business, the business shall be chargeable with the conduct.

(d) Certification. Every bid submitted to and contract executed by the State shall contain a certification by the contractor that the contractor is not barred from being awarded a contract or subcontract under this Section. A contractor who makes a false statement, material to the certification, commits a Class 3 felony.

2. The bidder certifies that it is not barred from being awarded a contract under Section 50.5.

C. Educational Loan

1. Section 3 of the Educational Loan Default Act provides:

§ 3. No State agency shall contract with an individual for goods or services if that individual is in default, as defined in Section 2 of this Act, on an educational loan. Any contract used by any State agency shall include a statement certifying that the individual is not in default on an educational loan as provided in this Section.

2. The bidder, if an individual as opposed to a corporation, partnership or other form of business organization, certifies that the bidder is not in default on an educational loan as provided in Section 3 of the Act.

D. Bid-Rigging/Bid Rotating

1. Section 33E-11 of the Criminal Code of 1961 provides:

§ 33E-11. (a) Every bid submitted to and public contract executed pursuant to such bid by the State or a unit of local government shall contain a certification by the prime contractor that the prime contractor is not barred from contracting with any unit of State or local government as a result of a violation of either Section 33E-3 or 33E-4 of this Article. The State and units of local government shall provide the appropriate forms for such certification.

RETURN WITH BID

(b) A contractor who makes a false statement, material to the certification, commits a Class 3 felony.

A violation of Section 33E-3 would be represented by a conviction of the crime of bid-rigging which, in addition to Class 3 felony sentencing, provides that any person convicted of this offense or any similar offense of any state or the United States which contains the same elements as this offense shall be barred for 5 years from the date of conviction from contracting with any unit of State or local government. No corporation shall be barred from contracting with any unit of State or local government as a result of a conviction under this Section of any employee or agent of such corporation if the employee so convicted is no longer employed by the corporation and: (1) it has been finally adjudicated not guilty or (2) if it demonstrates to the governmental entity with which it seeks to contract and that entity finds that the commission of the offense was neither authorized, requested, commanded, nor performed by a director, officer or a high managerial agent in behalf of the corporation.

A violation of Section 33E-4 would be represented by a conviction of the crime of bid-rotating which, in addition to Class 2 felony sentencing, provides that any person convicted of this offense or any similar offense of any state or the United States which contains the same elements as this offense shall be permanently barred from contracting with any unit of State or local government. No corporation shall be barred from contracting with any unit of State or local government as a result of a conviction under this Section of any employee or agent of such corporation if the employee so convicted is no longer employed by the corporation and: (1) it has been finally adjudicated not guilty or (2) if it demonstrates to the governmental entity with which it seeks to contract and that entity finds that the commission of the offense was neither authorized, requested, commanded, nor performed by a director, officer or a high managerial agent in behalf of the corporation.

2. The bidder certifies that it is not barred from contracting with the Department by reason of a violation of either Section 33E-3 or Section 33E-4.

E. International Anti-Boycott

1. Section 5 of the International Anti-Boycott Certification Act provides:

§ 5. State contracts. Every contract entered into by the State of Illinois for the manufacture, furnishing, or purchasing of supplies, material, or equipment or for the furnishing of work, labor, or services, in an amount exceeding the threshold for small purchases according to the purchasing laws of this State or \$10,000.00, whichever is less, shall contain certification, as a material condition of the contract, by which the contractor agrees that neither the contractor nor any substantially-owned affiliated company is participating or shall participate in an international boycott in violation of the provisions of the U.S. Export Administration Act of 1979 or the regulations of the U.S. Department of Commerce promulgated under that Act.

2. The bidder makes the certification set forth in Section 5 of the Act.

F. Drug Free Workplace

1. The Illinois "Drug Free Workplace Act" applies to this contract and it is necessary to comply with the provisions of the "Act" if the contractor is a corporation, partnership, or other entity (including a sole proprietorship) which has 25 or more employees.

2. The bidder certifies that if awarded a contract in excess of \$5,000 it will provide a drug free workplace by:

(a) Publishing a statement notifying employees that the unlawful manufacture, distribution, dispensation, possession or use of a controlled substance, including cannabis, is prohibited in the contractor's workplace; specifying the actions that will be taken against employees for violations of such prohibition; and notifying the employee that, as a condition of employment on such contract, the employee shall abide by the terms of the statement, and notify the employer of any criminal drug statute conviction for a violation occurring in the workplace no later than five (5) days after such conviction.

(b) Establishing a drug free awareness program to inform employees about the dangers of drug abuse in the workplace; the contractor's policy of maintaining a drug free workplace; any available drug counseling, rehabilitation, and employee assistance programs; and the penalties that may be imposed upon employees for drug violations.

(c) Providing a copy of the statement required by subparagraph (1) to each employee engaged in the performance of the contract and to post the statement in a prominent place in the workplace.

(d) Notifying the Department within ten (10) days after receiving notice from an employee or otherwise receiving actual notice of the conviction of an employee for a violation of any criminal drug statute occurring in the workplace.

(e) Imposing or requiring, within 30 days after receiving notice from an employee of a conviction or actual notice of such a conviction, an appropriate personnel action, up to and including termination, or the satisfactory participation in a drug abuse assistance or rehabilitation program approved by a federal, state or local health, law enforcement or other appropriate agency.

(f) Assisting employees in selecting a course of action in the event drug counseling, treatment, and rehabilitation is required and indicating that a trained referral team is in place.

(g) Making a good faith effort to continue to maintain a drug free workplace through implementation of the actions and efforts stated in this certification.

G. Debt Delinquency

1. The Illinois Procurement Code provides:

Section 50-11 and 50-12. Debt Delinquency.

The contractor or bidder certifies that it, or any affiliate, is not barred from being awarded a contract under 30 ILCS 500. Section 50-11 prohibits a person from entering into a contract with a State agency if it knows or should know that it, or any affiliate, is delinquent in the payment of any debt to the State as defined by the Debt Collection Board. Section 50-12 prohibits a person from entering into a contract with a State agency if it, or any affiliate, has failed to collect and remit Illinois Use Tax on all sales of tangible personal property into the State of Illinois in accordance with the provisions of the Illinois Use Tax Act. The contractor further acknowledges that the contracting State agency may declare the contract void if this certification is false or if the contractor, or any affiliate, is determined to be delinquent in the payment of any debt to the State during the term of the contract.

H. Sarbanes-Oxley Act of 2002

1. The Illinois Procurement Code provides:

Section 50-60(c).

The contractor certifies in accordance with 30 ILCS 500/50-10.5 that no officer, director, partner or other managerial agent of the contracting business has been convicted of a felony under the Sarbanes-Oxley Act of 2002 or a Class 3 or Class 2 felony under the Illinois Securities Law of 1953 for a period of five years prior to the date of the bid or contract. The contractor acknowledges that the contracting agency shall declare the contract void if this certification is false.

I. ADDENDA

The contractor or bidder certifies that all relevant addenda have been incorporated in to this contract. Failure to do so may cause the bid to be declared unacceptable.

J. Section 42 of the Environmental Protection Act

The contractor certifies in accordance with 30 ILCS 500/50-12 that the bidder or contractor is not barred from being awarded a contract under this Section which prohibits the bidding on or entering into contracts with the State of Illinois or a State agency by a person or business found by a court or the Pollution Control Board to have committed a willful or knowing violation of Section 42 of the Environmental Protection Act for a period of five years from the date of the order. The contractor acknowledges that the contracting agency may declare the contract void if this certification is false.

K. Apprenticeship and Training Certification (Does not apply to federal aid projects)

In accordance with the provisions of Section 30-22 (6) of the Illinois Procurement Code, the bidder certifies that it is a participant, either as an individual or as part of a group program, in the approved apprenticeship and training programs applicable to each type of work or craft that the bidder will perform with its own forces. The bidder further certifies for work that will be performed by subcontract that each of its subcontractors submitted for approval either (a) is, at the time of such bid, participating in an approved, applicable apprenticeship and training program; or (b) will, prior to commencement of performance of work pursuant to this contract, begin participation in an approved apprenticeship and training program applicable to the work of the subcontract. The Department, at any time before or after award, may require the production of a copy of each applicable Certificate of Registration issued by the United States Department of Labor evidencing such participation by the contractor and any or all of its subcontractors. Applicable apprenticeship and training programs are those that have been approved and registered with the United States Department of Labor. The bidder shall list in the space below, the official name of the program sponsor holding the Certificate of Registration for all of the types of work or crafts in which the bidder is a participant and that will be performed with the bidder's forces. Types of work or craft work that will be subcontracted shall be included and listed as subcontract work. The list shall also indicate any type of work or craft job category that does not have an applicable apprenticeship or training program. **The bidder is responsible for making a complete report and shall make certain that each type of work or craft job category that will be utilized on the project as reported on the Construction Employee Workforce Projection (Form BC-1256) and returned with the bid is accounted for and listed.**

The requirements of this certification and disclosure are a material part of the contract, and the contractor shall require this certification provision to be included in all approved subcontracts. In order to fulfill this requirement, it shall not be necessary that an applicable program sponsor be currently taking or that it will take applications for apprenticeship, training or employment during the performance of the work of this contract.

TO BE RETURNED WITH BID

IV. DISCLOSURES

A. The disclosures hereinafter made by the bidder are each a material representation of fact upon which reliance is placed should the Department enter into the contract with the bidder. The Department may terminate the contract if it is later determined that the bidder rendered a false or erroneous disclosure, and the surety providing the performance bond shall be responsible for completion of the contract.

B. Financial Interests and Conflicts of Interest

1. Section 50-35 of the Illinois Procurement Code provides that all bids of more than \$10,000 shall be accompanied by disclosure of the financial interests of the bidder. This disclosed information for the successful bidder, will be maintained as public information subject to release by request pursuant to the Freedom of Information Act.

The financial interests to be disclosed shall include ownership or distributive income share that is in excess of 5%, or an amount greater than 60% of the annual salary of the Governor, of the bidding entity or its parent entity, whichever is less, unless the contractor or bidder is a publicly traded entity subject to Federal 10K reporting, in which case it may submit its 10K disclosure in place of the prescribed disclosure. If a bidder is a privately held entity that is exempt from Federal 10K reporting, but has more than 400 shareholders, it may submit the information that Federal 10K companies are required to report, and list the names of any person or entity holding any ownership share that is in excess of 5%. The disclosure shall include the names, addresses, and dollar or proportionate share of ownership of each person making the disclosure, their instrument of ownership or beneficial relationship, and notice of any potential conflict of interest resulting from the current ownership or beneficial interest of each person making the disclosure having any of the relationships identified in Section 50-35 and on the disclosure form.

In addition, all disclosures shall indicate any other current or pending contracts, proposals, leases, or other ongoing procurement relationships the bidding entity has with any other unit of state government and shall clearly identify the unit and the contract, proposal, lease, or other relationship.

2. Disclosure Forms. Disclosure Form A is attached for use concerning the individuals meeting the above ownership or distributive share requirements. Subject individuals should be covered each by one form. In addition, a second form (Disclosure Form B) provides for the disclosure of current or pending procurement relationships with other (non-IDOT) state agencies. **The forms must be included with each bid or incorporated by reference.**

C. Disclosure Form Instructions

Form A: For bidders that have previously submitted the information requested in Form A

The Department has retained the Form A disclosures submitted by all bidders responding to these requirements for the April 24, 1998 or any subsequent letting conducted by the Department. The bidder has the option of submitting the information again or the bidder may sign the following certification statement indicating that the information previously submitted by the bidder is, as of the date of signature, current and accurate. The Certification must be signed and dated by a person who is authorized to execute contracts for the bidding company. Before signing this certification, the bidder should carefully review its prior submissions to ensure the Certification is correct. If the Bidder signs the Certification, the Bidder should proceed to Form B instructions.

CERTIFICATION STATEMENT

I have determined that the Form A disclosure information previously submitted is current and accurate, and all forms are hereby incorporated by reference in this bid. Any necessary additional forms or amendments to previously submitted forms are attached to this bid.

(Bidding Company)

Name of Authorized Representative (type or print)

Title of Authorized Representative (type or print)

Signature of Authorized Representative

Date

Form A: For bidders who have NOT previously submitted the information requested in Form A

If the bidder is a publicly traded entity subject to Federal 10K reporting, the 10K Report may be submitted to meet the requirements of Form A. If a bidder is a privately held entity that is exempt from Federal 10K reporting, but has more than 400 shareholders, it may submit the information that Federal 10K companies are required to report, and list the names of any person or entity holding any ownership share that is in excess of 5%. If a bidder is not subject to Federal 10K reporting, the bidder must determine if any individuals are required by law to complete a financial disclosure form. To do this, the bidder should answer each of the following questions. A "YES" answer indicates Form A must be completed. If the answer to each of the following questions is "NO", then the NOT APPLICABLE STATEMENT on the second page of Form A must be signed and dated by a person that is authorized to execute contracts for the bidding company. Note: These questions are for assistance only and are not required to be completed.

1. Does anyone in your organization have a direct or beneficial ownership share of greater than 5% of the bidding entity or parent entity? YES ___ NO ___
2. Does anyone in your organization have a direct or beneficial ownership share of less than 5%, but which has a value greater than \$90,420.00? YES ___ NO ___
3. Does anyone in your organization receive more than \$90,420.00 of the bidding entity's or parent entity's distributive income? (Note: Distributive income is, for these purposes, any type of distribution of profits. An annual salary is not distributive income.) YES ___ NO ___
4. Does anyone in your organization receive greater than 5% of the bidding entity's or parent entity's total distributive income, but which is less than \$90,420.00? YES ___ NO ___

(Note: Only one set of forms needs to be completed per person per bid even if a specific individual would require a yes answer to more than one question.)

A "YES" answer to any of these questions requires the completion of Form A. The bidder must determine each individual in the bidding entity or the bidding entity's parent company that would cause the questions to be answered "Yes". Each form must be signed and dated by a person that is authorized to execute contracts for your organization. **Photocopied or stamped signatures are not acceptable.** The person signing can be, but does not have to be, the person for which the form is being completed. The bidder is responsible for the accuracy of any information provided.

If the answer to each of the above questions is "NO", then the NOT APPLICABLE STATEMENT on page 2 of Form A must be signed and dated by a person that is authorized to execute contracts for your company.

Form B: Identifying Other Contracts & Procurement Related Information Disclosure Form B must be completed for each bid submitted by the bidding entity. It must be signed by an individual who is authorized to execute contracts for the bidding entity. *Note: Signing the NOT APPLICABLE STATEMENT on Form A does not allow the bidder to ignore Form B. Form B must be completed, signed and dated or the bidder may be considered nonresponsive and the bid will not be accepted.*

The Bidder shall identify, by checking Yes or No on Form B, whether it has any pending contracts (including leases), bids, proposals, or other ongoing procurement relationship with any other (non-IDOT) State of Illinois agency. If "No" is checked, the bidder only needs to complete the signature box on the bottom of Form B. If "Yes" is checked, the bidder must do one of the following:

Option I: If the bidder did not submit an Affidavit of Availability to obtain authorization to bid, the bidder must list all non-IDOT State of Illinois agency pending contracts, leases, bids, proposals, and other ongoing procurement relationships. These items may be listed on Form B or on an attached sheet(s). Do not include IDOT contracts. Contracts with cities, counties, villages, etc. are not considered State of Illinois agency contracts and are not to be included. Contracts with other State of Illinois agencies such as the Department of Natural Resources or the Capital Development Board must be included. Bidders who submit Affidavits of Availability are suggested to use Option II.

Option II: If the bidder is required and has submitted an Affidavit of Availability in order to obtain authorization to bid, the bidder may write or type "See Affidavit of Availability" which indicates that the Affidavit of Availability is incorporated by reference and includes all non-IDOT State of Illinois agency pending contracts, leases, bids, proposals, and other ongoing procurement relationships. For any contracts that are not covered by the Affidavit of Availability, the bidder must identify them on Form B or on an attached sheet(s). These might be such things as leases.

D. Bidders Submitting More Than One Bid

Bidders submitting multiple bids may submit one set of forms consisting of all required Form A disclosures and one Form B for use with all bids. Please indicate in the space provided below the bid item that contains the original disclosure forms and the bid items which incorporate the forms by reference.

- The bid submitted for letting item _____ contains the Form A disclosures or Certification Statement and the Form B disclosures. The following letting items incorporate the said forms by reference:

**ILLINOIS DEPARTMENT
OF TRANSPORTATION**

**Form A
Financial Information &
Potential Conflicts of Interest
Disclosure**

Contractor Name		
Legal Address		
City, State, Zip		
Telephone Number	Email Address	Fax Number (if available)

Disclosure of the information contained in this Form is required by the Section 50-35 of the Illinois Procurement Code (30 ILCS 500). Vendors desiring to enter into a contract with the State of Illinois must disclose the financial information and potential conflict of interest information as specified in this Disclosure Form. This information shall become part of the publicly available contract file. This Form A must be completed for bids in excess of \$10,000, and for all open-ended contracts. **A publicly traded company may submit a 10K disclosure (or equivalent if applicable) in satisfaction of the requirements set forth in Form A. See Disclosure Form Instructions.**

DISCLOSURE OF FINANCIAL INFORMATION

1. Disclosure of Financial Information. The individual named below has an interest in the BIDDER (or its parent) in terms of ownership or distributive income share in excess of 5%, or an interest which has a value of more than \$90,420.00 (60% of the Governor's salary as of 7/1/01). **(Make copies of this form as necessary and attach a separate Disclosure Form A for each individual meeting these requirements)**

FOR INDIVIDUAL (type or print information)

NAME: _____

ADDRESS _____

Type of ownership/distributable income share:

stock _____ sole proprietorship _____ Partnership _____ other: (explain on separate sheet):
% or \$ value of ownership/distributable income share: _____

2. Disclosure of Potential Conflicts of Interest. Check "Yes" or "No" to indicate which, if any, of the following potential conflict of interest relationships apply. If the answer to any question is "Yes", please attach additional pages and describe.

(a) State employment, currently or in the previous 3 years, including contractual employment of services. Yes ___ No ___

If your answer is yes, please answer each of the following questions.

1. Are you currently an officer or employee of either the Capitol Development Board or the Illinois Toll Highway Authority? Yes ___ No ___
2. Are you currently appointed to or employed by any agency of the State of Illinois? If you are currently appointed to or employed by any agency of the State of Illinois, and your annual salary exceeds \$90,420.00, (60% of the Governor's salary as of 7/1/01) provide the name the State agency for which you are employed and your annual salary. _____

RETURN WITH BID/OFFER

3. If you are currently appointed to or employed by any agency of the State of Illinois, and your annual salary exceeds \$90,420.00, (60% of the Governor's salary as of 7/1/01) are you entitled to receive (i) more than 7 1/2% of the total distributable income of your firm, partnership, association or corporation, or (ii) an amount in excess of the salary of the Governor? Yes ___ No ___
4. If you are currently appointed to or employed by any agency of the State of Illinois, and your annual salary exceeds \$90,420.00, (60% of the Governor's salary as of 7/1/01) are you and your spouse or minor children entitled to receive (i) more than 15 % in the aggregate of the total distributable income of your firm, partnership, association or corporation, or (ii) an amount in excess of 2 times the salary of the Governor? Yes ___ No ___

(b) State employment of spouse, father, mother, son, or daughter, including contractual employment services in the previous 2 years.

Yes ___ No ___

If your answer is yes, please answer each of the following questions.

1. Is your spouse or any minor children currently an officer or employee of the Capitol Development Board or the Illinois Toll Highway Authority? Yes ___ No ___
2. Is your spouse or any minor children currently appointed to or employed by any agency of the State of Illinois? If your spouse or minor children is/are currently appointed to or employed by any agency of the State of Illinois, and his/her annual salary exceeds \$90,420.00, (60 % of the Governor's salary as of 7/1/01) provide the name of your spouse and/or minor children, the name of the State agency for which he/she is employed and his/her annual salary. _____
3. If your spouse or any minor children is/are currently appointed to or employed by any agency of the State of Illinois, and his/her annual salary exceeds \$90,420.00, (60% of the salary of the Governor as of 7/1/01) are you entitled to receive (i) more then 71/2% of the total distributable income of your firm, partnership, association or corporation, or (ii) an amount in excess of the salary of the Governor? Yes ___ No ___
4. If your spouse or any minor children are currently appointed to or employed by any agency of the State of Illinois, and his/her annual salary exceeds \$90,420.00, (60% of the Governor's salary as of 7/1/01) are you and your spouse or minor children entitled to receive (i) more than 15 % in the aggregate of the total distributable income of your firm, partnership, association or corporation, or (ii) an amount in excess of 2 times the salary of the Governor? Yes ___ No ___

(c) Elective status; the holding of elective office of the State of Illinois, the government of the United States, any unit of local government authorized by the Constitution of the State of Illinois or the statutes of the State of Illinois currently or in the previous 3 years.

Yes ___ No ___

(d) Relationship to anyone holding elective office currently or in the previous 2 years; spouse, father, mother, son, or daughter.

Yes ___ No ___

(e) Appointive office; the holding of any appointive government office of the State of Illinois, the United States of America, or any unit of local government authorized by the Constitution of the State of Illinois or the statutes of the State of Illinois, which office entitles the holder to compensation in excess of the expenses incurred in the discharge of that office currently or in the previous 3 years.

Yes ___ No ___

(f) Relationship to anyone holding appointive office currently or in the previous 2 years; spouse, father, mother, son, or daughter.

Yes ___ No ___

(g) Employment, currently or in the previous 3 years, as or by any registered lobbyist of the State government.

Yes ___ No ___

RETURN WITH BID/OFFER

(h) Relationship to anyone who is or was a registered lobbyist in the previous 2 years; spouse, father, mother, son, or daughter. Yes ___ No ___

(i) Compensated employment, currently or in the previous 3 years, by any registered election or reelection committee registered with the Secretary of State or any county clerk of the State of Illinois, or any political action committee registered with either the Secretary of State or the Federal Board of Elections. Yes ___ No ___

(j) Relationship to anyone; spouse, father, mother, son, or daughter; who was a compensated employee in the last 2 years by any registered election or re-election committee registered with the Secretary of State or any county clerk of the State of Illinois, or any political action committee registered with either the Secretary of State or the Federal Board of Elections. Yes ___ No ___

APPLICABLE STATEMENT

This Disclosure Form A is submitted on behalf of the INDIVIDUAL named on previous page.

Completed by:

Name of Authorized Representative (type or print)

Completed by:

Title of Authorized Representative (type or print)

Completed by:

Signature of Individual or Authorized Representative

Date

NOT APPLICABLE STATEMENT

I have determined that no individuals associated with this organization meet the criteria that would require the completion of this Form A.

This Disclosure Form A is submitted on behalf of the CONTRACTOR listed on the previous page.

Name of Authorized Representative (type or print)

Title of Authorized Representative (type or print)

Signature of Authorized Representative

Date

RETURN WITH BID/OFFER

ILLINOIS DEPARTMENT
OF TRANSPORTATION

Form B
Other Contracts &
Procurement Related Information
Disclosure

Contractor Name		
Legal Address		
City, State, Zip		
Telephone Number	Email Address	Fax Number (if available)

Disclosure of the information contained in this Form is required by the Section 50-35 of the Illinois Procurement Act (30 ILCS 500). This information shall become part of the publicly available contract file. This Form B must be completed for bids in excess of \$10,000, and for all open-ended contracts.

DISCLOSURE OF OTHER CONTRACTS AND PROCUREMENT RELATED INFORMATION

1. Identifying Other Contracts & Procurement Related Information. The BIDDER shall identify whether it has any pending contracts (including leases), bids, proposals, or other ongoing procurement relationship with any other State of Illinois agency: Yes ___ No ___

If **“No” is checked**, the bidder only needs to complete the signature box on the bottom of this page.

2. If “Yes” is checked. Identify each such relationship by showing State of Illinois agency name and other descriptive information such as bid or project number (attach additional pages as necessary). SEE DISCLOSURE FORM INSTRUCTIONS:

THE FOLLOWING STATEMENT MUST BE SIGNED

Name of Authorized Representative (type or print)	

Title of Authorized Representative (type or print)	
_____	_____
Signature of Authorized Representative	Date

RETURN WITH BID

SPECIAL NOTICE TO CONTRACTORS

The following requirements of the Illinois Department of Human Rights' Rules and Regulations are applicable to bidders on all construction contracts advertised by the Illinois Department of Transportation:

CONSTRUCTION EMPLOYEE UTILIZATION PROJECTION

- (a) All bidders on construction contracts shall complete and submit, along with and as part of their bids, a Bidder's Employee Utilization Form (Form BC-1256) setting forth a projection and breakdown of the total workforce intended to be hired and/or allocated to such contract work by the bidder including a projection of minority and female employee utilization in all job classifications on the contract project.
- (b) The Department of Transportation shall review the Employee Utilization Form, and workforce projections contained therein, of the contract awardee to determine if such projections reflect an underutilization of minority persons and/or women in any job classification in accordance with the Equal Employment Opportunity Clause and Section 7.2 of the Illinois Department of Human Rights' Rules and Regulations for Public Contracts adopted as amended on September 17, 1980. If it is determined that the contract awardee's projections reflect an underutilization of minority persons and/or women in any job classification, it shall be advised in writing of the manner in which it is underutilizing and such awardee shall be considered to be in breach of the contract unless, prior to commencement of work on the contract project, it submits revised satisfactory projections or an acceptable written affirmative action plan to correct such underutilization including a specific timetable geared to the completion stages of the contract.
- (c) The Department of Transportation shall provide to the Department of Human Rights a copy of the contract awardee's Employee Utilization Form, a copy of any required written affirmative action plan, and any written correspondence related thereto. The Department of Human Rights may review and revise any action taken by the Department of Transportation with respect to these requirements.

RETURN WITH BID

**Contract No. 68529
PEORIA County
Section D4 TRAFFIC SIGNALS 2006
Route FAP 315
District 4 Construction Funds**

PART II. WORKFORCE PROJECTION - continued

B. Included in "Total Employees" under Table A is the total number of **new hires** that would be employed in the event the undersigned bidder is awarded this contract.

The undersigned bidder projects that: (number) _____ new hires would be recruited from the area in which the contract project is located; and/or (number) _____ new hires would be recruited from the area in which the bidder's principal office or base of operation is located.

C. Included in "Total Employees" under Table A is a projection of numbers of persons to be employed directly by the undersigned bidder as well as a projection of numbers of persons to be employed by subcontractors.

The undersigned bidder estimates that (number) _____ persons will be directly employed by the prime contractor and that (number) _____ persons will be employed by subcontractors.

PART III. AFFIRMATIVE ACTION PLAN

A. The undersigned bidder understands and agrees that in the event the foregoing minority and female employee utilization projection included under **PART II** is determined to be an underutilization of minority persons or women in any job category, and in the event that the undersigned bidder is awarded this contract, he/she will, prior to commencement of work, develop and submit a written Affirmative Action Plan including a specific timetable (geared to the completion stages of the contract) whereby deficiencies in minority and/or female employee utilization are corrected. Such Affirmative Action Plan will be subject to approval by the contracting agency and the **Department of Human Rights**.

B. The undersigned bidder understands and agrees that the minority and female employee utilization projection submitted herein, and the goals and timetable included under an Affirmative Action Plan if required, are deemed to be part of the contract specifications.

Company _____ Telephone Number _____

Address _____

NOTICE REGARDING SIGNATURE

The Bidder's signature on the Proposal Signature Sheet will constitute the signing of this form. The following signature block needs to be completed only if revisions are required.

Signature: _____ Title: _____ Date: _____

- Instructions: All tables must include subcontractor personnel in addition to prime contractor personnel.
- Table A - Include both the number of employees that would be hired to perform the contract work and the total number currently employed (Table B) that will be allocated to contract work, and include all apprentices and on-the-job trainees. The "Total Employees" column should include all employees including all minorities, apprentices and on-the-job trainees to be employed on the contract work.
- Table B - Include all employees currently employed that will be allocated to the contract work including any apprentices and on-the-job trainees currently employed.
- Table C - Indicate the racial breakdown of the total apprentices and on-the-job trainees shown in Table A.

RETURN WITH BID

**Contract No. 68529
PEORIA County
Section D4 TRAFFIC SIGNALS 2006
Route FAP 315
District 4 Construction Funds**

PROPOSAL SIGNATURE SHEET

The undersigned bidder hereby makes and submits this bid on the subject Proposal, thereby assuring the Department that all requirements of the Invitation for Bids and rules of the Department have been met, that there is no misunderstanding of the requirements of paragraph 3 of this Proposal, and that the contract will be executed in accordance with the rules of the Department if an award is made on this bid.

Firm Name _____
(IF AN INDIVIDUAL) Signature of Owner _____
Business Address _____

Firm Name _____
By _____
(IF A CO-PARTNERSHIP) Business Address _____

Name and Address of All Members of the Firm:

Corporate Name _____
By _____
Signature of Authorized Representative _____
Typed or printed name and title of Authorized Representative _____
(IF A CORPORATION) Attest _____
Signature _____
(IF A JOINT VENTURE, USE THIS SECTION
FOR THE MANAGING PARTY AND THE
SECOND PARTY SHOULD SIGN BELOW) Business Address _____

Corporate Name _____
By _____
Signature of Authorized Representative _____
Typed or printed name and title of Authorized Representative _____
(IF A JOINT VENTURE) Attest _____
Signature _____
Business Address _____

If more than two parties are in the joint venture, please attach an additional signature sheet.



RETURN WITH BID

Division of Highways
Proposal Bid Bond
(Effective November 1, 1992)

Item No.
Letting Date

KNOW ALL MEN BY THESE PRESENTS, That We
as PRINCIPAL, and

held jointly, severally and firmly bound unto the STATE OF ILLINOIS in the penal sum of 5 percent of the total bid price, or for the amount specified in Article 102.09 of the "Standard Specifications for Road and Bridge Construction" in effect on the date of invitation for bids, whichever is the lesser sum, well and truly to be paid unto said STATE OF ILLINOIS, for the payment of which we bind ourselves, our heirs, executors, administrators, successors and assigns.

THE CONDITION OF THE FOREGOING OBLIGATION IS SUCH, That Whereas, the PRINCIPAL has submitted a bid proposal to the STATE OF ILLINOIS, acting through the Department of Transportation, for the improvement designated by the Transportation Bulletin Item Number and Letting Date indicated above.

NOW, THEREFORE, if the Department shall accept the bid proposal of the PRINCIPAL; and if the PRINCIPAL shall, within the time and as specified in the bidding and contract documents, submit a DBE Utilization Plan that is accepted and approved by the Department; and if, after award by the Department, the PRINCIPAL shall enter into a contract in accordance with the terms of the bidding and contract documents including evidence of the required insurance coverages and providing such bond as specified with good and sufficient surety for the faithful performance of such contract and for the prompt payment of labor and material furnished in the prosecution thereof; or if, in the event of the failure of the PRINCIPAL to make the required DBE submission or to enter into such contract and to give the specified bond, the PRINCIPAL pays to the Department the difference not to exceed the penalty hereof between the amount specified in the bid proposal and such larger amount for which the Department may contract with another party to perform the work covered by said bid proposal, then this obligation shall be null and void, otherwise, it shall remain in full force and effect.

IN THE EVENT the Department determines the PRINCIPAL has failed to comply with any requirement as set forth in the preceding paragraph, then Surety shall pay the penal sum to the Department within fifteen (15) days of written demand therefor. If Surety does not make full payment within such period of time, the Department may bring an action to collect the amount owed. Surety is liable to the Department for all its expenses, including attorney's fees, incurred in any litigation in which it prevails either in whole or in part.

In TESTIMONY WHEREOF, the said PRINCIPAL and the said SURETY have caused this instrument to be signed by their respective officers this day of A.D.,

PRINCIPAL SURETY
(Company Name) (Company Name)
By: (Signature & Title) By: (Signature of Attorney-in-Fact)

Notary Certification for Principal and Surety

STATE OF ILLINOIS,
COUNTY OF

I, a Notary Public in and for said County, do hereby certify that
and

(Insert names of individuals signing on behalf of PRINCIPAL & SURETY)

who are each personally known to me to be the same persons whose names are subscribed to the foregoing instrument on behalf of PRINCIPAL and SURETY, appeared before me this day in person and acknowledged respectively, that they signed and delivered said instrument as their free and voluntary act for the uses and purposes therein set forth.

Given under my hand and notarial seal this day of, A.D.

My commission expires
Notary Public

In lieu of completing the above section of the Proposal Bid Form, the Principal may file an Electronic Bid Bond. By signing below the Principal is ensuring the identified electronic bid bond has been executed and the Principal and Surety are firmly bound unto the State of Illinois under the conditions of the bid bond as shown above.

Electronic Bid Bond ID# Company/Bidder Name Signature and Title

PROPOSAL ENVELOPE



PROPOSALS

for construction work advertised for bids by the
Illinois Department of Transportation

Item No.	Item No.	Item No.

Submitted By:

Name:
Address:
Phone No.

Bidders should use an IDOT proposal envelope or affix this form to the front of a 10" x 13" envelope for the submittal of bids. If proposals are mailed, they should be enclosed in a second or outer envelope addressed to:

Engineer of Design and Environment - Room 326
Illinois Department of Transportation
2300 South Dirksen Parkway
Springfield, Illinois 62764

NOTICE

Individual bids, including Bid Bond and/or supplemental information if required, should be securely stapled.

CONTRACTOR OFFICE COPY OF CONTRACT SPECIFICATIONS

NOTICE

None of the following material needs to be returned with the bid package unless the special provisions require documentation and/or other information to be submitted.

Contract No. 68529
PEORIA County
Section D4 TRAFFIC SIGNALS 2006
Route FAP 315
District 4 Construction Funds



Illinois Department of Transportation



NOTICE TO BIDDERS

- 1. TIME AND PLACE OF OPENING BIDS.** Sealed proposals for the improvement described herein will be received by the Department of Transportation at the Harry R. Hanley Building, 2300 South Dirksen Parkway, in Springfield, Illinois until 10:00 o'clock a.m., January 20, 2006. All bids will be gathered, sorted, publicly opened and read in the auditorium at the Department of Transportation's Harry R. Hanley Building shortly after the 10:00 a.m. cut off time.
- 2. DESCRIPTION OF WORK.** The proposed improvement is identified and advertised for bids in the Invitation for Bids as:

**Contract No. 68529
PEORIA County
Section D4 TRAFFIC SIGNALS 2006
Route FAP 315
District 4 Construction Funds**

This project consists of installation of fiber optic traffic signal interconnect cable in existing conduit along U.S. Route 150 (War Memorial Drive) from the intersection of Big Hollow/Willow Knolls Road to Glen/Sterling Avenue and from the intersection of Prospect Avenue to the intersection of Illinois Route 29 (Adams Street) in Peoria.

- 3. INSTRUCTIONS TO BIDDERS.** (a) This Notice, the invitation for bids, proposal and letter of award shall, together with all other documents in accordance with Article 101.09 of the Standard Specifications for Road and Bridge Construction, become part of the contract. Bidders are cautioned to read and examine carefully all documents, to make all required inspections, and to inquire or seek explanation of the same prior to submission of a bid.

(b) State law, and, if the work is to be paid wholly or in part with Federal-aid funds, Federal law requires the bidder to make various certifications as a part of the proposal and contract. By execution and submission of the proposal, the bidder makes the certification contained therein. A false or fraudulent certification shall, in addition to all other remedies provided by law, be a breach of contract and may result in termination of the contract.
- 4. AWARD CRITERIA AND REJECTION OF BIDS.** This contract will be awarded to the lowest responsive and responsible bidder considering conformity with the terms and conditions established by the Department in the rules, Invitation for Bids and contract documents. The issuance of plans and proposal forms for bidding based upon a prequalification rating shall not be the sole determinant of responsibility. The Department reserves the right to determine responsibility at the time of award, to reject any or all proposals, to readvertise the proposed improvement, and to waive technicalities.

By Order of the
Illinois Department of Transportation

Timothy W. Martin, Secretary

BD 351 (Rev. 01/2003)

INDEX
FOR
SUPPLEMENTAL SPECIFICATIONS
AND RECURRING SPECIAL PROVISIONS

Adopted March 1, 2005

This index contains a listing of SUPPLEMENTAL SPECIFICATIONS and frequently used RECURRING SPECIAL PROVISIONS.

ERRATA Standard Specifications for Road and Bridge Construction (Adopted 1-1-02) (Revised 3-1-05)

SUPPLEMENTAL SPECIFICATIONS

<u>Std. Spec. Sec.</u>	<u>Page No.</u>
101 Definition of Terms	1
105 Control of Work	2
205 Embankment	3
251 Mulch	4
281 Riprap	5
282 Filter Fabric for Use With Riprap	8
285 Concrete Revetment Mats	10
311 Granular Subbase	14
351 Aggregate Base Course	15
440 Removal of Existing Pavement and Appurtenances	16
442 Pavement Patching	17
449 Removal and Replacement of Prefomed Elastomeric Compression Joint Seal	18
481 Aggregate Shoulders	19
501 Removal of Existing Structures	20
503 Concrete Structures	21
505 Steel Structures	22
506 Cleaning and Painting Metal Structures	25
508 Reinforcement Bars	26
512 Piling	27
540 Box Culverts	28
589 Elastic Joint Sealer	30
602 Catch Basin, Manhole, Inlet, Drainage Structures and Valve Vault Construction, Adjustment and Reconstruction	31
603 Adjusting Frames and Grates of Drainage and Utility Structures	32
610 Shoulder Inlets with Curb	33
665 Woven Wire Fence	34
669 Removal and Disposal of Regulated Substances	35
671 Mobilization	36
702 Work Zone Traffic Control Devices	37
1003 Fine Aggregates	38
1004 Coarse Aggregate	39
1005 Stone, Concrete Blocks and Broken Concrete for Erosion Protection, Sediment Control and Rockfill	42
1006 Metals	46
1007 Timber and Preservative Treatment	49
1012 Hydrated Lime	50
1020 Portland Cement Concrete	51
1021 Concrete Admixtures	58
1022 Concrete Curing Materials	59
1024 Nonshrink Grout	61
1041 Brick	63
1043 Precast Reinforced Concrete Manhole Sections and Adjusting Rings	64
1056 Prefomed Flexible Gaskets and Mastic Joint Sealer for Sewer and Culvert Pipe	66
1059 Elastic Joint Sealers	67
1060 Waterproofing Materials	68
1069 Pole and Tower	69
1070 Foundation and Breakaway Devices	70
1077 Post and Foundation	72
1080 Fabric Materials	73
1081 Materials For Planting	76
1083 Elastomeric Bearings	77
1094 Overhead Sign Structures	78
1103 Portland Cement Concrete Equipment	79

RECURRING SPECIAL PROVISIONS

The following RECURRING SPECIAL PROVISIONS indicated by an "X" are applicable to this contract and are included by reference:

<u>CHECK SHEET #</u>	<u>PAGE NO.</u>
1 State Required Contract Provisions All Federal-aid Construction Contracts (Eff. 2-1-69) (Rev. 10-1-83)	80
2 Subletting of Contracts (Federal-aid Contracts) (Eff. 1-1-88) (Rev. 5-1-93).....	82
3 X EEO (Eff. 7-21-78) (Rev. 11-18-80).....	83
4 X Specific Equal Employment Opportunity Responsibilities NonFederal-aid Contracts (Eff. 3-20-69) (Rev. 1-1-94)	94
5 X Required Provisions - State Contracts (Eff. 4-1-65) (Rev. 4-1-93).....	100
6 Reserved	105
7 Asphalt Quantities and Cost Reviews (Eff. 7-1-88).....	106
8 National Pollutant Discharge Elimination System Permit (Eff. 7-1-94) (Rev. 1-1-03).....	107
9 Haul Road Stream Crossings, Other Temporary Stream Crossings and In-Stream Work Pads (Eff. 1-2-92) (Rev. 1-1-98)	108
10 Construction Layout Stakes Except for Bridges (Eff. 1-1-99) (Rev. 1-1-02).....	109
11 Construction Layout Stakes (Eff. 5-1-93) (Rev. 1-1-02).....	112
12 Use of Geotextile Fabric for Railroad Crossing (Eff. 1-1-95) (Rev. 1-1-97).....	115
13 Asphaltic Emulsion Slurry Seal and Fibrated Asphaltic Emulsion Slurry Seal (Eff. 8-1-89) (Rev. 2-1-97)	117
14 Bituminous Surface Treatments Half-Smart (Eff. 7-1-93) (Rev. 1-1-97)	123
15 Quality Control/Quality Assurance of Bituminous Concrete Mixtures (Eff. 1-1-00) (Rev. 3-1-05)	129
16 Subsealing of Concrete Pavements (Eff. 11-1-84) (Rev. 2-1-95).....	148
17 Bituminous Surface Removal (Cold Milling) (Eff. 11-1-87) (Rev. 10-15-97).....	152
18 Resurfacing of Milled Surfaces (Eff. 10-1-95)	154
19 PCC Partial Depth Bituminous Patching (Eff. 1-1-98).....	155
20 Patching with Bituminous Overlay Removal (Eff. 10-1-95) (Rev. 7-1-99)	157
21 Reserved	159
22 Protective Shield System (Eff. 4-1-95) (Rev. 1-1-03).....	160
23 Polymer Concrete (Eff. 8-1-95) (Rev. 3-1-05).....	162
24 Controlled Low-Strength Material (CLSM) (Eff. 1-1-90) (Rev. 3-1-05).....	164
25 Pipe Underdrains (Eff. 9-9-87) (Rev. 1-1-98).....	169
26 Guardrail and Barrier Wall Delineation (Eff. 12-15-93) (Rev. 1-1-97)	170
27 Bicycle Racks (Eff. 4-1-94) (Rev. 1-1-97)	175
28 Reserved	177
29 Reserved	178
30 Reserved	179
31 Night Time Inspection of Roadway Lighting (Eff. 5-1-96).....	180
32 Reserved	181
33 English Substitution of Metric Bolts (Eff. 7-1-96).....	182
34 English Substitution of Metric Reinforcement Bars (Eff. 4-1-96) (Rev. 1-1-03)	183
35 Polymer Modified Emulsified Asphalt (Eff. 5-15-89) (Rev. 1-1-04).....	185
36 Corrosion Inhibitor (Eff. 3-1-80) (Rev. 7-1-99)	187
37 Quality Control of Concrete Mixtures at the Plant-Single A (Eff. 8-1-00) (Rev. 1-1-04)	188
38 Quality Control of Concrete Mixtures at the Plant-Double A (Eff. 8-1-00) (Rev. 1-1-04)	194
39 Quality Control/Quality Assurance of Concrete Mixtures (Eff. 4-1-92) (Rev. 3-1-05).....	202
40 Traffic Barrier Terminal Type 1, Special (Eff. 8-1-94) (Rev. 1-1-03)	215
41 Reserved	216
42 Segregation Control of Bituminous Concrete (Eff. 7-15-97).....	217
43 Reserved	220

TABLE OF CONTENTS

LOCATION OF PROJECT	1
DESCRIPTION OF PROJECT	1
TRAFFIC CONTROL PLAN	1
LOCATION OF UNDERGROUND STATE MAINTAINED FACILITIES	2
SYSTEM OPERATIONAL PARAMETERS.....	2
CONTRACT GUARANTEE	3
FIBER OPTIC CABLE IN CONDUIT NO. 24F (12 62.5/125 UM MULTI-MODE AND 12 SINGLE MODE FIBERS)	3
FIBER OPTIC INTERCONNECT CENTER, 24 FIBER	5
JUNCTION BOX, SPECIAL	5
REPAIR EXISTING CONDUIT ATTACHED TO STRUCTURE	6
DATA NETWORK PORT ADAPTER	6
FIBER OPTIC ETHERNET DROP AND REPEAT SWITCH.....	9
FLAGGER VESTS (BDE).....	11
PARTIAL PAYMENTS (BDE)	12
PAYMENTS TO SUBCONTRACTORS (BDE)	13
SUBCONTRACTOR MOBILIZATION PAYMENTS (BDE).....	14
TRAFFIC CONTROL DEFICIENCY DEDUCTION (BDE).....	15
WORK ZONE TRAFFIC CONTROL DEVICES (BDE).....	15
WORKING DAYS (BDE)	17
PAYROLLS AND PAYROLL RECORDS (BDE)	17
PERSONAL PROTECTIVE EQUIPMENT (BDE)	18

STATE OF ILLINOIS

SPECIAL PROVISIONS

The following Special Provisions supplement the "Standard Specifications for Road and Bridge Construction," adopted January 1, 2002, the latest edition of the "Manual on Uniform Traffic Control Devices for Streets and Highways," and the "Manual of Test Procedures for Materials" in effect on the date of invitation for bids, and the Supplemental Specifications and Recurring Special Provisions indicated on the Check Sheet included herein which apply to and govern the construction of FAP Route 315 (US 150), Section D4 Traffic Signals 2006 in Peoria County and in case of conflict with any part or parts of said Specifications, the said Special Provisions shall take precedence and shall govern.

LOCATION OF PROJECT

The project is located along US 150 (War Memorial Drive) from the intersection of Big Hollow/Willow Knolls Road to the intersection of Glen/Sterling Avenue and from the intersection of Prospect Avenue to the intersection of IL 29 (Adams Street) in the City of Peoria.

DESCRIPTION OF PROJECT

This project consists of installing fiber optic traffic signal interconnect cables in existing conduit and handholes, installing fiber optic Ethernet switches and RS-232 terminal servers in existing traffic signal cabinets to establish communications with traffic signal equipment, and all other work required to complete the improvement.

TRAFFIC CONTROL PLAN

Effective August 30, 2005

Traffic control shall be in accordance with the applicable sections of the "Standard Specifications for Road and Bridge Construction", the applicable guidelines contained in the "Illinois Manual on Uniform Traffic Control Devices for Streets and Highways", these Special Provisions, and any special details and Highway Standards contained herein and in the plans.

Special attention is called to Section 701 and Articles 107.09 and 107.14 of the "Standard Specifications for Road and Bridge Construction" and the following Highway Standards relating to traffic control:

701101 701106 701602 701701 702001

Lane restrictions on US 150 shall only be allowed from 9:00 a.m. to 3:00 p.m., Monday through Friday.

LOCATION OF UNDERGROUND STATE MAINTAINED FACILITIES

The Contractor shall be responsible for locating all existing and proposed IDOT/City of Peoria traffic signal, overhead lighting, and other electrical facilities prior to performing any work at his/her own expense if required. The Contractor shall also be liable for any damage to facilities resulting from inaccurate locating. The Contractor may obtain, on request, plans of existing electrical facilities from the Department.

The Contractor shall also be responsible for locating and providing protection for facilities during all phases of construction. If at any time, the facilities are damaged, the Contractor shall immediately notify the Department and make all necessary arrangements for repair to the satisfaction of the Engineer. This work shall be included in the contract bid price and no additional compensation will be allowed.

SYSTEM OPERATIONAL PARAMETERS

The fiber optic traffic signal interconnect cable will be used to establish communications with existing field devices located in existing traffic signal cabinets. An Ethernet network will be created between the traffic signal central monitoring facility located at the City of Peoria's Traffic Operations Center at Dries Lane to the existing components. The network will extend from the central facility westward along US 150 (War Memorial Dr.) to the intersection with Big Hollow/Willow Knolls Road. The network will extend eastward, utilizing existing traffic signal interconnect cable to the intersection of Prospect Rd. and will extend from Prospect Rd. to the IL 29 (Adams St.) interchange by utilizing proposed traffic signal interconnect cable.

Drop and repeat fiber optic Ethernet switches and Data Network Port Adapters (serial to Ethernet converters) will be utilized to establish communications from the central facility to the existing field components through the use of the existing central computer and individual component software (Econolite Aries, Econolite Autoscope Suite, Iteris VRAS).

The fiber optic network equipment (switches and data network port adapters) shall be subject to a 30 day burn-in period. The system along with all of its components shall be fully and functionally operational before the burn-in can commence. During the "burn-in" period, the components shall perform continuously, without any interruption of operation, for a period of thirty days. In the event that there are operational problems during the burn-in period, the burn-in period shall reset back to day one.

After the successful completion of the burn-in period, the system will have completed final acceptance.

CONTRACT GUARANTEE

The Contractor shall provide a written guarantee for all electrical equipment, apparatus, materials, and workmanship provided under the contract for a period of six months after the date of final acceptance according to Article 801.13.

All instruction sheets and other documentation required to be furnished by the manufacturer for materials and supplies and for operations shall be delivered to the Engineer prior to the acceptance of the project, with the following warranties and guarantees:

1. The manufacturer's standard written warranty for each piece of electrical equipment or apparatus furnished under the contract.
2. The Contractor's written guarantee that, for a period of six months after the date of final inspection of the project, all necessary repairs to or replacement of said warranted equipment, or apparatus shall be made by the Contractor at no cost to the Department.
3. The Contractor's written guarantee for satisfactory operation of all electrical systems furnished and constructed under the contract for a period of six months after final inspection of the project.

The Contractor shall furnish a warranty certificate for each component that includes the equipment description and details, serial numbers, effective dates, and the details of the warranty regarding materials and labor. The warranty period shall begin on the date of installation and the warranty certificate shall reflect this date.

FIBER OPTIC CABLE IN CONDUIT NO. 24F (12 62.5/125 UM MULTI-MODE AND 12 SINGLE MODE FIBERS)

This work shall be in accordance with Section 871 and 1076 of the Standard Specifications except as modified herein.

The fiber optic cable shall be a 24-fiber cable that includes 12 multi-mode fibers and 12 single mode fibers.

The single-mode, fiber optic cable shall incorporate a loose, buffer-tube design. The cable shall conform to the requirements of RUS 7 CFR1755.900 (PE-90) for a single sheathed, non-armored cable, and shall be new, unused and of current design and manufacture.

Minimum Bending Radius.

The cable shall be capable of withstanding a minimum-bending radius of 20 times its outer diameter during installation and 10 times its outer diameter during operation without changing the characteristics of the optical fibers.

Environmental Requirements

The cable shall meet all of specified requirements under the following conditions:

Shipping/storage temperature: -58° F to +158° F (-50° C to +70° C)

Installation temperature: -22° F to +158° F (-30° C to +70° C)

Operating temperature: -40° F to +158° F (-40° C to +70° C)

Relative humidity from 0% to 95%, non-condensing

Other ancillary components, required to complete the fiber optic cable plant, including but not limited to, moisture and water sealants, cable caps, fan-out kits, etc., shall be supplied under this pay item and will not be paid for separately.

Revise Section 871.00 of the Standard Specifications to read:

This work shall consist of furnishing and installing Fiber Optic cable in conduit with all accessories and connectors according to Section 871 of the Standard Specifications. The cable shall be of the type, size, and the number of fiber specified.

Six multi-mode fibers shall be terminated with approved mechanical connectors at each traffic signal cabinet as shown on the plan sheets. Fibers not being used shall be labeled "spare", and fibers not attached to a distribution enclosure shall be capped and sealed. A minimum of 13 ft. of slack cable shall be provided for the cabinet locations, and the cabinet slack cable shall be stored as directed by the Engineer. The cable shall be tested using a power meter and source in accordance with the standard specifications.

The fiber optic cable shall be pulled into each double handhole and left intact for future use.

A fiber optic tracer wire will not be installed with the fiber optic cable at locations where the existing twisted pair cable can be used for locating. At locations where a tracer cable is required for locating, a #12 1/C THHN cable shall be pulled into the conduits containing the fiber optic cable. The cost of the locating wire shall be included in the bid price for the fiber optic cable.

Preliminary field investigation reveals that the following conduit runs along US 150 (War Memorial Drive) contain pull ropes: from Grand Avenue to Harvard (west side of intersection) and from Harvard (east side of intersection) to NE Madison (near Goodwill store). It is the Contractor's responsibility to verify the pull rope placement and condition prior to bidding the project.

The amount of slack cable listed in Article 873.03 shall be revised as follows:

<u>Location</u>	<u>Length of Slack Cable</u>
	Feet
Gulfbox	6.0
Junction Box	6.0

Handhole	10.0
Double Handhole	40.0
Controller Cabinet	13.0

The fiber optic cable shall be clearly marked in each handhole and cabinet with a brightly colored (orange or yellow) weather resistant marker securely attached to the cable.

Basis of Payment: This work will be paid for at the contract unit price per foot for FIBER OPTIC CABLE IN CONDUIT NO. 24F (12 62.5/125 um MM and 12 SM FIBERS) and shall be payment in full for all labor, equipment, and materials required to provide, test, and install the fiber optic cable described above, complete.

FIBER OPTIC INTERCONNECT CENTER, 24 FIBER

Description

This work shall consist of furnishing and installing a 24 fiber wall mountable interconnect center. The interconnect center shall be installed in the existing traffic signal cabinets as shown on the plan sheets. The Contractor shall be responsible for rearranging any existing components to facilitate installation.

The wall mountable interconnect center shall be equipped with four six-fiber bulkheads, complete with all required fiber termination accessories and six multi-mode fiber optic patch cables.

Basis of Payment: This work will be paid for at the contract unit price each for FIBER OPTIC INTERCONNECT CENTER, 24 FIBER, which shall be payment in full for all labor, equipment, and materials required to provide the equipment described above, complete.

JUNCTION BOX, SPECIAL

Description

This work shall consist of furnishing and installing a polymer concrete junction box with nominal dimensions of 17" x 30" x 12" (L x W x D). The Contractor shall remove the existing communication pedestals and install the junction boxes at the locations shown on the plan sheets. The junction box and cover shall be rated heavy duty (15,000 / 22,500 lb. design/test load) and equipped with gaskets.

The junction box shall be placed at grade and be encased with a minimum of six inches of concrete around all sides.

The Contractor shall encapsulate the communication cables inside the junction box to prevent damage from moisture by using a weather- proof poured encapsulate.

Any splicing of the existing cables and modification of the existing conduit to accommodate the installation of the junction box shall be included in the bid price for the junction box.

The communication pedestals shall be delivered to the City of Peoria at the Traffic Operations facility located on Dries Lane.

Basis of Payment: This work will be paid for at the contract unit price each for JUNCTION BOX, SPECIAL, which shall be payment in full for all labor, equipment, and materials required to provide and install the junction box described above, complete.

REPAIR EXISTING CONDUIT ATTACHED TO STRUCTURE

This work shall consist of removing the damaged liquidtight and PVC conduit at the railroad bridge located along US 150 (War Memorial Dr.) and installing new liquidtight and galvanized steel conduit as shown in the plan detail.

The Contractor shall remove all existing liquidtight metal conduit and a ten foot section of the existing PVC conduit attached to the bridge parapet on both sides of the structure. The Contractor shall install one 10 foot section of 2" diameter galvanized rigid conduit (anchored at three locations) and new liquidtight conduit with new galvanized liquidtight connectors equipped with integral stainless steel "kellems" grips at both ends of the structure.

The Contractor will be allowed to cut the existing 25 pair interconnect cable at the nearest handhole to facilitate repairs.

Upon installation of the existing interconnect cable and proposed fiber optic cable, the Contractor shall splice the interconnect cable together in the nearest handhole. The splice shall utilize soldered connections and approved splice sleeves and shall be enclosed in a weather-proof poured encapsulate such as 3M 82A of the required size.

The Contractor, at his option, may elect to completely remove the interconnect cable from the conduit, make the required repairs to the conduit, and re-install the cable. If the Contractor chooses this option, there will be no additional compensation for this work.

Basis of Payment: This work will be paid for at the contract unit price lump sum for REPAIR EXISTING CONDUIT ATTACHED TO STRUCTURE, which shall be payment in full for all labor, equipment, and materials required to repair the conduit as described above, complete.

DATA NETWORK PORT ADAPTER

Effective October 8, 2002 Revised October 21, 2005

Description

The Data Network Port Adapter (DNPA) shall act as a bridge between a high-speed Internet Protocol (IP) Ethernet network and low-speed serial devices. The port adapter shall convert serial data into Ethernet data and vice versa. The port adapter shall be IP addressable and shall respond to packets sent to this address when power is supplied.

Materials

The Contractor shall supply an environmentally hardened data network port adapter that meets or exceeds the following minimum specifications:

Approved Models: MOXA Model N-Port 5210 or approved equal.

LAN:

Ethernet: 10/100 Mbps, RJ45, IEEE 802.3
Protection: Built-in 1.5 KV magnetic isolation

SERIAL INTERFACE:

Interface: RS-232
Number of Ports: 2
Port Type: 8-Pin RJ45
Signals: TxD, RxD, RTS, CTS, DTR, DSR, DCD, GND
Serial Line Protection: 15 KV ESD for all signals
Power Line Protection: 4 KV Burst (EFT), 2 KV Surge (Power)

SERIAL COMMUNICATION PARAMETERS:

Parity: None, Even, Odd, Space, Mark
Data Bits: 5, 6, 7, 8
Stop Bit: 1, 1.5, 2
Flow Control: RTS/CTS, XON/XOFF, DTR/DSR
Transmission Speed: 110 bps to 230.4 Kbps (Bi-Directional Data Transmission)

SOFTWARE FEATURES:

Protocols: ICMP, IP, TCP, UDP, DHCP, BOOTP, Telnet, DNS, SNMP, HTTP, SMTP, SNTP
Real COM/TTY Drivers: Windows 95/98/ME/NT/2000/XP/2003 Real COM drivers
Configuration: Web Browser, Serial/Telnet Console, or Windows Utility

The data network port adaptor shall include software that can be installed on the central traffic signal computer to provide access to all adapters through the use of software selectable and assignable virtual communication ports (minimum of 128 ports) on the host computer.

ELECTRICAL:

- 120 VAC (internal or external power supply) and self-setting over-current protection shall be included

ENVIRONMENTAL:

- Operating Temperature: -40 to 70 degrees C
- Relative Humidity: 0-95% non-condensing

OTHER:

- Both local and remote configuration and software upgrade capability
- Password protection for security

The Contractor shall supply a power strip with a minimum of six outlets and integral surge suppression that meets or exceeds the following minimum specifications:

- Let Through Voltage: <85 Volts
- Operating Voltage: 120VAC, 50/60H
- UL Suppressed Voltage Rating: 330V
- Energy Rating: 320J
- Peak Current NM/CM: 13k Amps NM, 13k Amps CM
- EMI/RFI Noise Filtration: >25-60dB

Cabling

The Contractor shall supply the required cabling (CAT 5E and serial cables) to connect the DNPA to the Ethernet network and low speed serial devices (master controllers and Econolite or Iteris video detection systems). This cabling is included in the cost of the Data Network Port Adaptor.

Construction Requirements

Installation

The Contractor shall install the Data Network Port Adapter and connect the required cables as shown on the Plans. Additionally, the Contractor shall install a power strip in each traffic signal cabinet. The power strip shall be wired directly to the protected power terminals on the cabinet surge arrestor. Any moving or rearrangement of cabinet shelves and/or components shall be included in this pay item.

Warranty: The Contractor shall warranty all materials and workmanship including labor for a period of two years after the completion and acceptance of the installation, unless other warranty requirements prevail. The warranty period shall begin when the Contractor completes all construction obligations related to this item and when the components for this item have been accepted, which shall be documented as the final completion date in the construction status report. This warranty shall include repair and/or replacement of all failed components via a factory authorized depot repair service. All items sent to the depot for repair shall be returned within two weeks of the date of receipt at the facility. The depot location shall be in the United States.

Equipment sent back for repair shall be returned in two weeks from date of receipt of defective equipment at the repair facility. The provider of the warranty service shall be responsible for all return shipping costs. The depot maintainer designated for each component shall be authorized by the original manufacturer to supply this service.

A warranty certificate shall be supplied for each component indicating the start and end dates of the warranty. The certificate shall be supplied to the Department and the warranty shall initiate on the date of acceptance and continue a minimum of two years after that date. The certificate shall name the Department as the recipient of the service. The Department shall have the right to transfer this service to other private parties who may be contracted to perform overall maintenance of the facility.

Documentation: The Contractor shall deliver two (2) copies of the user manual and installation manual for each data network port adapter installed to the Engineer and place one copy in each traffic signal controller cabinet.

Method of Measurement: Data Network Port Adapter shall be measured for payment by the actual number of port adapters furnished, installed, tested, and accepted by the Engineer.

Basis of Payment: This work will be paid for at the contract unit price each for DATA NETWORK PORT ADAPTER, which shall be payment in full for all labor, materials, and equipment required to furnish, install, and test the port adapter described above, complete.

FIBER OPTIC ETHERNET DROP AND REPEAT SWITCH

Effective: February 19, 2003

Revised October 21, 2005

Description

This work consists of furnishing and installing an environmentally hardened fiber optic Ethernet drop and repeat switch at locations indicated in the plans or as directed by the Engineer. The fiber optic Ethernet drop and repeat switch extends four IEEE 802.3 (Ethernet) ports from field locations to communications nodes and shall contain all of the components described in the material specification and detailed in the plans.

Materials

(a) Fiber Optic Transceiver

The Contractor shall provide fiber optic transceivers to provide drop and repeat transmission of 10/100 Mbps Ethernet signals over one multi-mode fiber. The module shall support the transmission of four channels of 10 or 100 Mbps over one multimode fiber and shall feature four electrical ports (RJ-45) and two optical ports for drop and repeat capability. The transceiver shall meet or exceed the following minimum specifications:

Approved Models: IFS Model D7420WDM, Optelecom Model 9772Y-MM-ST, or approved equal.

LAN:

- 10/100 Mbps
- Auto-Negotiating, 10/100 Selectable
- Auto Network Detection MDI/MDI-X

- Relay Output for Network Communication Failure Notification
- Power, Transmit and Receive Data Status LED Indicators
- Hot-Swappable Modules

FIBER OPTIC:

- Optical Fiber: 62.5/125 micron multimode
- Optical Wavelength: 1310/1550, 1550nm/1310nm, 850nm/1310nm
- ST Optical Connectors
- Data transmission over one multi-mode fiber utilizing wave division multiplexing
- Optical Power Budget: 10 dB
- Maximum Distance: 6.2 miles (10Km)

ELECTRICAL:

- 120 VAC (internal or external power supply) and self-setting over-current protection shall be included
- Stand alone enclosure for rack mounted modules.

ENVIRONMENTAL:

- Operating Temperature: -40 to 70 degrees C
- Relative Humidity: 0-95% non-condensing

TESTING AND COMPLIANCE:

- Tested and Certified by an Independent Testing Laboratory for Full Compliance with the Environmental Requirements (Ambient Operating Temperature, Mechanical Shock, Vibration, Humidity with Condensation, High-Line/Low-Line Voltage Conditions and Transient Voltage Protection) of NEMA TS-1/TS-2 and the Caltrans Specification for Traffic Signal Control Equipment.
- IEEE 802.3 Compliant

(b) Data Cables

The Contractor shall furnish Cat 5E compliant cables and fiber optic jumper cables to interconnect the transceiver to the networked equipment.

Construction Requirements

The Contractor shall prepare a shop drawing submittal, which will include copies of manufacturer's descriptive literature or "cut-sheets" for the Device Server. The submittal shall include a complete description of the central control port protocol utilized to command and configure the Device Server.

Shop Drawings shall be submitted and shall include specific details of the installation of all of the materials listed in this specification including cable lengths, connector types, gender and connector pin outs. All cables shall be labeled with permanent legible marking tags. The shop drawing submittal must be approved by the Engineer prior to any factory testing or installation of the completed assembly in the field.

Warranty: The Contractor shall warranty all materials and workmanship including labor for a period of two years after the completion and acceptance of the installation, unless other warranty requirements prevail. The warranty period shall begin when the Contractor completes all construction obligations related to this item and when the components for this item have been accepted, which shall be documented as the final completion date in the construction status report. This warranty shall include repair and/or replacement of all failed components via a factory authorized depot repair service.

All items sent to the depot for repair shall be returned within two weeks of the date of receipt at the facility. The depot location shall be in the United States.

Equipment sent back for repair shall be returned in two weeks from date of receipt of defective equipment at the repair facility. The provider of the warranty service shall be responsible for all return shipping costs. The depot maintainer designated for each component shall be authorized by the original manufacturer to supply this service.

A warranty certificate shall be supplied for each component indicating the start and end dates of the warranty. The certificate shall be supplied to the Department and the warranty shall initiate on the date of acceptance and continue a minimum of two years after that date. The certificate shall name the Department as the recipient of the service. The Department shall have the right to transfer this service to other private parties who may be contracted to perform overall maintenance of the facility.

Documentation: The Contractor shall deliver one copy of all operations and maintenance manuals for each piece of equipment installed in each Fiber Optic Ethernet Drop and Repeat Switch and place a copy of the manuals in each controller cabinet.

Method of Measurement: The fiber optic Ethernet drop and repeat switch shall be measured for payment as a unit furnished, installed, tested, and complete in-place.

Basis of Payment: Payment will be made at the contract unit price for each FIBER OPTIC ETHERNET DROP AND REPEAT SWITCH, which shall be payment in full for all labor, equipment, and materials required to furnish, install, and test the switch as described above.

FLAGGER VESTS (BDE)

Effective: April 1, 2003

Revised: January 1, 2006

Revise the first sentence of Article 701.04(c)(1) of the Standard Specifications to read:

“The flagger shall be stationed to the satisfaction of the Engineer and be equipped with a fluorescent orange, fluorescent yellow/green or a combination of fluorescent orange and fluorescent yellow/green vest meeting the requirements of the American National Standards Institute specification ANSI/ISEA 107-2004 for Conspicuity Class 2 garments

and approved flagger traffic control signs conforming to Standard 702001 and Article 702.05(e).”

Revise Article 701.04(c)(6) of the Standard Specifications to read:

“(6) Nighttime Flagging. Flaggers shall be illuminated by an overhead light source providing a minimum vertical illuminance of 108 lux (10 fc) measured 300 mm (1 ft) out from the flagger’s chest. The bottom of any luminaire shall be a minimum of 3 m (10 ft) above the pavement. Luminaire(s) shall be shielded to minimize glare to approaching traffic and trespass light to adjoining properties.

The flagger vest shall be a fluorescent orange or fluorescent orange and fluorescent yellow/green vest meeting the requirements of the American National Standards Institute specification ANSI/ISEA 107-1999 for Conspicuity Class 3 garments.”

80101

PARTIAL PAYMENTS (BDE)

Effective: September 1, 2003

Revise Article 109.07 of the Standard Specifications to read:

“**109.07 Partial Payments.** Partial payments will be made as follows:

(a) Progress Payments. At least once each month, the Engineer will make a written estimate of the amount of work performed in accordance with the contract, and the value thereof at the contract unit prices. The amount of the estimate approved as due for payment will be vouchered by the Department and presented to the State Comptroller for payment. No amount less than \$1000.00 will be approved for payment other than the final payment.

The failure to perform any requirement, obligation, or term of the contract by the Contractor shall be reason for withholding any progress payments until the Department determines that compliance has been achieved. Furthermore, progress payments may be reduced by liens filed pursuant to Section 23(c) of the Mechanics Lien Act, 770 ILCS 60/23(c).

(b) Material Allowances. At the discretion of the Department, payment may be made for materials, prior to their use in the work, when satisfactory evidence is presented by the Contractor. Satisfactory evidence includes justification for the allowance (to expedite the work, meet project schedules, regional or national material shortages, etc.), documentation of material and transportation costs, and evidence that such material is properly stored on the project or at a secure location acceptable and accessible to the Department.

Material allowances will be considered only for nonperishable materials when the cost, including transportation, exceeds \$10,000 and such materials are not expected to be utilized within 60 days of the request for the allowance. For contracts valued under \$500,000, the minimum \$10,000 requirement may be met by combining the principal (material) product of no more than two contract items. An exception to this two item limitation may be considered for any contract regardless of value for items in which material (products) are similar except for type and/or size.

Material allowances shall not exceed the value of the contract items in which used and shall not include the cost of installation or related markups. Amounts paid by the Department for material allowances will be deducted from estimates due the Contractor as the material is used. Two-sided copies of the Contractor's cancelled checks for materials and transportation must be furnished to the Department within 60 days of payment of the allowances or the amounts will be reclaimed by the Department."

80116

PAYMENTS TO SUBCONTRACTORS (BDE)

Effective: June 1, 2000

Revised: January 1, 2006

Federal regulations found at 49 CFR §26.29 mandate the Department to establish a contract clause to require Contractors to pay subcontractors for satisfactory performance of their subcontracts and to set the time for such payments.

State law also addresses the timing of payments to be made to subcontractors and material suppliers. Section 7 of the Prompt Payment Act, 30 ILCS 540/7, requires that when a Contractor receives any payment from the Department, the Contractor shall make corresponding, proportional payments to each subcontractor and material supplier performing work or supplying material within 15 calendar days after receipt of the Department payment. Section 7 of the Act further provides that interest in the amount of 2 percent per month, in addition to the payment due, shall be paid to any subcontractor or material supplier by the Contractor if the payment required by the Act is withheld or delayed without reasonable cause. The Act also provides that the time for payment required and the calculation of any interest due applies to transactions between subcontractors and lower-tier subcontractors and material suppliers throughout the contracting chain.

This Special Provision establishes the required federal contract clause, and adopts the 15 calendar day requirement of the State Prompt Payment Act for purposes of compliance with the federal regulation regarding payments to subcontractors. This contract is subject to the following payment obligations.

When progress payments are made to the Contractor according to Article 109.07 of the Standard Specifications, the Contractor shall make a corresponding payment to each subcontractor and material supplier in proportion to the work satisfactorily completed by each subcontractor and for the material supplied to perform any work of the contract. The

proportionate amount of partial payment due to each subcontractor and material supplier throughout the contracting chain shall be determined by the quantities measured or otherwise determined as eligible for payment by the Department and included in the progress payment to the Contractor. Subcontractors and material suppliers shall be paid by the Contractor within 15 calendar days after the receipt of payment from the Department. The Contractor shall not hold retainage from the subcontractors. These obligations shall also apply to any payments made by subcontractors and material suppliers to their subcontractors and material suppliers; and to all payments made to lower tier subcontractors and material suppliers throughout the contracting chain. Any payment or portion of a payment subject to this provision may only be withheld from the subcontractor or material supplier to whom it is due for reasonable cause.

This Special Provision does not create any rights in favor of any subcontractor or material supplier against the State or authorize any cause of action against the State on account of any payment, nonpayment, delayed payment, or interest claimed by application of the State Prompt Payment Act. The Department will not approve any delay or postponement of the 15 day requirement except for reasonable cause shown after notice and hearing pursuant to Section 7(b) of the State Prompt Payment Act. State law creates other and additional remedies available to any subcontractor or material supplier, regardless of tier, who has not been paid for work properly performed or material furnished. These remedies are a lien against public funds set forth in Section 23(c) of the Mechanics Lien Act, 770 ILCS 60/23(c), and a recovery on the Contractor's payment bond according to the Public Construction Bond Act, 30 ILCS 550.

80022

SUBCONTRACTOR MOBILIZATION PAYMENTS (BDE)

Effective: April 2, 2005

To account for the preparatory work and operations necessary for the movement of subcontractor personnel, equipment, supplies, and incidentals to the project site and for all other work or operations that must be performed or costs incurred when beginning work approved for subcontracting in accordance with Article 108.01 of the Standard Specifications, the Contractor shall make a mobilization payment to each subcontractor.

This mobilization payment shall be made at least 14 days prior to the subcontractor starting work. The amount paid shall be equal to 3 percent of the amount of the subcontract reported on form BC 260A submitted for the approval of the subcontractor's work.

This provision shall be incorporated directly or by reference into each subcontract approved by the Department.

80143

TRAFFIC CONTROL DEFICIENCY DEDUCTION (BDE)

Effective: April 1, 1992

Revised: January 1, 2005

To ensure a prompt response to incidents involving the integrity of work zone traffic control, the Contractor shall provide a telephone number where a responsible individual can be contacted 24 hours-a-day.

When the Engineer is notified, or determines a traffic control deficiency exists, he/she will notify and direct the Contractor to correct the deficiency within a specified time. The specified time, which begins upon notification to the Contractor, will be from 1/2 hour to 12 hours based upon the urgency of the situation and the nature of the deficiency. The Engineer shall be the sole judge.

A deficiency may be any lack of repair, maintenance, or non-compliance with the traffic control plan. A deficiency may also be applied to situations where corrective action is not an option such as the use of non-certified flaggers for short term operations; working with lane closures beyond the time allowed in the contract; or failure to perform required contract obligations such as traffic control surveillance.

If the Contractor fails to correct a deficiency within the specified time, a daily monetary deduction will be imposed for each calendar day or fraction thereof the deficiency exists. The calendar day(s) will begin with notification to the Contractor and end with the Engineer's acceptance of the correction. The daily monetary deduction will be either \$1,000 or 0.05 percent of the awarded contract value, whichever is greater. For those deficiencies where corrective action was not an option this monetary deduction will be immediate.

In addition, if the Contractor fails to respond, the Engineer may correct the deficiency and the cost thereof will be deducted from monies due or which may become due the Contractor. This corrective action will in no way relieve the Contractor of his/her contractual requirements or responsibilities.

5729I

WORK ZONE TRAFFIC CONTROL DEVICES (BDE)

Effective: January 1, 2003

Revised: November 1, 2004

Add the following to Article 702.01 of the Standard Specifications:

“All devices and combinations of devices shall meet the requirements of the National Cooperative Highway Research Program (NCHRP) Report 350 for their respective categories. The categories are as follows:

Category 1 includes small, lightweight, channelizing and delineating devices that have been

in common use for many years and are known to be crashworthy by crash testing of similar devices or years of demonstrable safe performance. These include cones, tubular markers, flexible delineators and plastic drums with no attachments. Category 1 devices shall be crash tested and accepted or may be self-certified by the manufacturer.

Category 2 includes devices that are not expected to produce significant vehicular velocity change but may otherwise be hazardous. These include drums and vertical panels with lights, barricades and portable sign supports. Category 2 devices shall be crash tested and accepted for Test Level 3.

Category 3 includes devices that are expected to cause significant velocity changes or other potentially harmful reactions to impacting vehicles. These include crash cushions, truck mounted attenuators and other devices not meeting the definitions of Category 1 or 2. Category 3 devices shall be crash tested and accepted for either Test Level 3 or the test level specified.

Category 4 includes portable or trailer-mounted devices such as arrow boards, changeable message signs, temporary traffic signals and area lighting supports. Currently, there is no implementation date set for this category and it is exempt from the NCHRP 350 compliance requirement.

The Contractor shall provide a manufacturer's self-certification letter for each Category 1 device and an FHWA acceptance letter for each Category 2 and Category 3 device used on the contract. The letters shall state the device meets the NCHRP 350 requirements for its respective category and test level, and shall include a detail drawing of the device."

Delete the third, fourth and fifth paragraphs of Article 702.03(b) of the Standard Specifications.

Delete the third sentence of the first paragraph of Article 702.03(c) of the Standard Specifications.

Revise the first sentence of the first paragraph of Article 702.03(e) of the Standard Specifications to read:

"Drums shall be nonmetallic and have alternating reflectorized Type AA or Type AP fluorescent orange and reflectorized white horizontal, circumferential stripes."

Add the following to Article 702.03 of the Standard Specifications:

"(h) Vertical Barricades. Vertical barricades may be used in lieu of cones, drums or Type II barricades to channelize traffic."

Delete the fourth paragraph of Article 702.05(a) of the Standard Specifications.

Revise the sixth paragraph of Article 702.05(a) of the Standard Specifications to read:

"When the work operations exceed four days, all signs shall be post mounted unless the signs are located on the pavement or define a moving or intermittent operation. When

approved by the Engineer, a temporary sign stand may be used to support a sign at 1.2 m (5 ft) minimum where posts are impractical. Longitudinal dimensions shown on the plans for the placement of signs may be increased up to 30 m (100 ft) to avoid obstacles, hazards or to improve sight distance, when approved by the Engineer. "ROAD CONSTRUCTION AHEAD" signs will also be required on side roads located within the limits of the mainline "ROAD CONSTRUCTION AHEAD" signs."

Delete all references to "Type 1A barricades" and "wing barricades" throughout Section 702 of the Standard Specifications.

80097

WORKING DAYS (BDE)

Effective: January 1, 2002

The Contractor shall complete the work within 20 working days.

80071

PAYROLLS AND PAYROLL RECORDS (BDE)

Effective: August 10, 2005

FEDERAL AID CONTRACTS. Add the following State of Illinois requirements to the Federal requirements contained in Section V of Form FHWA-1273:

"The payroll records shall include each worker's name, address, telephone number, social security number, classification, rate of pay, number of hours worked each day, starting and ending times of work each day, total hours worked each week, itemized deductions made, and actual wages paid.

The Contractor and each subcontractor shall submit payroll records to the Engineer each week from the start to the completion of their respective work. The submittals shall be on the Department's form SBE 48, or an approved facsimile. When there has been no activity during a work week, a payroll record shall still be submitted with the appropriate box ("No Work", "Suspended", or "Complete") checked on the form."

STATE CONTRACTS. Revise Section IV of Check Sheet #5 of the Recurring Special Provisions to read:

"IV.COMPLIANCE WITH THE PREVAILING WAGE ACT

1. Prevailing Wages. All wages paid by the Contractor and each subcontractor shall be in compliance with The Prevailing Wage Act (820 ILCS 130), as amended, except where a prevailing wage violates a federal law, order, or ruling, the rate conforming to the federal

law, order, or ruling shall govern. The Contractor shall be responsible to notify each subcontractor of the wage rates set forth in this contract and any revisions thereto. If the Department of Labor revises the wage rates, the Contractor will not be allowed additional compensation on account of said revisions.

2. Payroll Records. The Contractor and each subcontractor shall make and keep, for a period of three years from the date of completion of this contract, records of the wages paid to his/her workers. The payroll records shall include each worker's name, address, telephone number, social security number, classification, rate of pay, number of hours worked each day, starting and ending times of work each day, total hours worked each week, itemized deductions made, and actual wages paid. Upon two business days' notice, these records shall be available, at all reasonable hours at a location within the State, for inspection by the Department or the Department of Labor.
3. Submission of Payroll Records. The Contractor and each subcontractor shall submit payroll records to the Engineer each week from the start to the completion of their respective work. The submittals shall be on the Department's form SBE 48, or an approved facsimile. When there has been no activity during a work week, a payroll record shall still be submitted with the appropriate box ("No Work", "Suspended", or "Complete") checked on the form.

Each submittal shall be accompanied by a statement signed by the Contractor or subcontractor which avers that: (i) such records are true and accurate; (ii) the hourly rate paid to each worker is not less than the general prevailing rate of hourly wages required by the Act; and (iii) the Contractor or subcontractor is aware that filing a payroll record that he/she knows to be false is a Class B misdemeanor.

4. Employee Interviews. The Contractor and each subcontractor shall permit his/her employees to be interviewed on the job, during working hours, by compliance investigators of the Department or the Department of Labor."

80155

PERSONAL PROTECTIVE EQUIPMENT (BDE)

Effective: July 1, 2004

All personnel, excluding flaggers, working outside of a vehicle (car or truck) within 7.6 m (25 ft) of pavement open to traffic shall wear a fluorescent orange, fluorescent yellow/green or a combination of fluorescent orange and fluorescent yellow/.green vest meeting the requirements of the American National Standards Institute specification ANSI/ISEA 107-1999 for Conspicuity Class 2 garments. Other types of garments may be substituted for the vest as long as the garments have manufacturers tags identifying them as meeting the ANSI Class 2 requirement.

80130

PROJECT ENGR.: RANDY LANINGA (309) 671-4477

DESIGN ENGR.: ERIC HOWALD (309) 671-4481

INDEX OF SHEETS

- 1. COVER SHEET
- 2. COMMITMENTS AND NOTES
- 3. SUMMARY OF QUANTITIES
- 4. SCHEDULE OF QUANTITIES
- 5-8. FIBER INSTALLATION (US 150)
- 9. FIBER INSTALLATION (IL 40)
- 10-11. COMMUNICATION LINE DIAGRAMS

**STATE OF ILLINOIS
DEPARTMENT OF TRANSPORTATION
DIVISION OF HIGHWAYS**

SHEET 1 OF 11
D-94-115-05

**FAP 315 (US 150)
SECTION D4 TRAFFIC SIGNALS 2006
PEORIA COUNTY
C-94-140-05**



US 150 (WAR MEMORIAL DR.)
FROM BIG HOLLOW/WILLOW KNOLLS
GLEN/STERLING

IL 40 (KNOXVILLE AVE.)
FROM PENNSYLVANIA AVE.
TO NEBRASKA

US 150 (WAR MEMORIAL DR.)
FROM PROSPECT AVE. TO
IL 29 (ADAMS ST.)

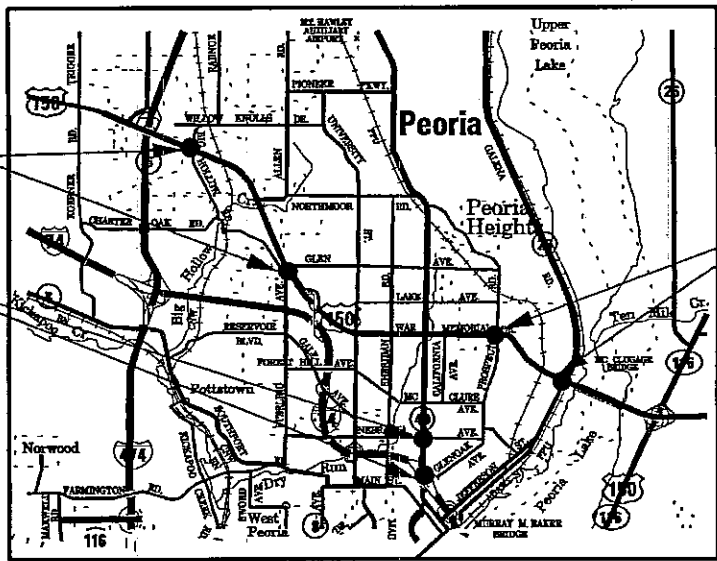

STANDARDS

- 701101--01
 - 701106--0001
 - 701602--0000
 - 701701--0000
 - 702001--0000
- NLS

LOCATION OF IMPROVEMENT

THIS PROJECT IS LOCATED ALONG US 150 (WAR MEMORIAL DR.) FROM THE INTERCHANGE OF IL 29 (ADAMS ST.) TO THE INTERSECTION OF BIG HOLLOW/WILLOW KNOLLS RD. AND ALONG IL 40 (KNOXVILLE AVE.) FROM THE INTERSECTION OF PENNSYLVANIA TO THE INTERSECTION OF NEBRASKA IN THE CITY OF PEORIA, IN PEORIA COUNTY.

DESCRIPTION OF WORK

THIS PROJECT CONSISTS OF INSTALLING FIBER OPTIC CABLE IN EXISTING CONDUIT AND HANDHOLES; INSTALLING COMMUNICATIONS EQUIPMENT IN EXISTING TRAFFIC SIGNAL CABINETS; AND ALL OTHER COLLATERAL WORK REQUIRED TO COMPLETE THE IMPROVEMENT.

J.U.L.I.E.
JOINT UTILITY LOCATION INFORMATION FOR EXCAVATION
1-800-892-0123

**STATE OF ILLINOIS
DEPARTMENT OF TRANSPORTATION
DIVISION OF HIGHWAYS**

SUBMITTED 10/25, 2005

J. E. Curran
DEPUTY DIRECTOR OF HIGHWAYS REGION ENGINEER

CONTRACT NO. 68529
CATALOG NO. 033139-000

PRINTED BY THE AUTHORITY
OF THE STATE OF ILLINOIS

ROUTE		SECTION	COUNTY	SHEET	
MKD.	DESIG.	D4 TRAFFIC SIGNALS 2006	PEORIA	TOTAL	NO.
US 150	FAP 315			11	2

CONSTRUCTION NOTES

THE LOCATION OF ALL UTILITIES SHALL BE FIELD VERIFIED BY THE CONTRACTOR BEFORE THE INSTALLATION OF ANY COMPONENTS.

THE EXISTING COMMUNICATION SYSTEM SHALL REMAIN IN OPERATION DURING THE INSTALLATION OF THE PROPOSED COMPONENTS AND FIBER OPTIC CABLE.

ANY MAINTENANCE OF EXISTING EQUIPMENT WILL BE CONSIDERED EXTRA WORK IN ACCORDANCE WITH ART. 109.04 OF THE STANDARD SPECIFICATIONS.

THE LOCATION OF ALL UTILITIES AND PRIVATELY OWNED FACILITIES SHALL BE FIELD VERIFIED BY THE CONTRACTOR PRIOR TO THE INSTALLATION OF ANY COMPONENTS.

THE CONTRACTOR SHALL BE RESPONSIBLE FOR LOCATING ALL EXISTING AND PROPOSED STATE OWNED ITS, TRAFFIC SIGNAL, AND LIGHTING FACILITIES.

THE CONTRACTOR SHALL FURNISH A WARRANTY CERTIFICATE FOR ALL INSTALLED EQUIPMENT THAT INCLUDES THE EQUIPMENT DESCRIPTION, SERIAL NUMBERS, EFFECTIVE DATES, AND THE WARRANTY DETAILS FOR EACH WARRANTY ITEM.

A FIBER OPTIC TRACER WIRE WILL NOT BE INSTALLED WITH THE FIBER OPTIC CABLE AT LOCATIONS WHERE THE EXISTING TWISTED PAIR CABLE CAN BE USED FOR LOCATING. AT LOCATIONS WHERE A TRACER CABLE IS REQUIRED FOR LOCATING, A #12 1/C CABLE SHALL BE PULLED INTO THE CONDUITS CONTAINING THE FIBER OPTIC CABLE. THE COST OF THE LOCATING WIRE SHALL BE INCLUDED IN THE BID PRICE FOR THE FIBER OPTIC CABLE.





ALL SURPLUS MATERIALS SHALL BE DISPOSED OF IN ACCORDANCE WITH ARTICLE 202.03 OF THE STANDARD SPECIFICATIONS.

EACH HANDHOLE SHALL HAVE 10.0 FT OF SLACK CABLE AND EACH DOUBLE HANDHOLE SHALL HAVE 40.0 FT OF SLACK CABLE UNLESS NOTED OTHERWISE ON THE PLAN SHEETS.

COMMITMENTS

NO COMMITMENTS WERE MADE IN CONJUNCTION WITH THIS PROJECT.

TRAFFIC SIGNAL LEGEND

-  EX. CONT. CABINET (SIGNAL)
-  EX. DBL HANDHOLE
-  EX. HANDHOLE
-  PROP. JUNCTION BOX
-  EX. CONDUIT

COMMITMENTS AND NOTES

ROUTE		SECTION	COUNTY	SHEET	
MKD.	DESIG.	D4 TRAFFIC	PEORIA	TOTAL	NO.
US 150	FAP 315	SIGNALS 2006		11	3

SUMMARY OF QUANTITIES

SUMMARY OF QUANTITIES					PEORIA COUNTY
CODE NUMBER	ITEM DESCRIPTION	UNIT	TOTAL QTY	CONST. TYPE CODE Y031-1F 100% STATE 0% CITY URBAN CITY OF PEORIA	
67100100	MOBILIZATION	L SUM	1	1	
70102632	TRAFFIC CONTROL & PROTECTION STANDARD 701602	L SUM	1	1	
70102635	TRAFFIC CONTROL & PROTECTION STANDARD 701701	L SUM	1	1	
81306100	JUNCTION BOX, SPECIAL	EACH	2	2	
X0323909	DATA NETWORK PORT ADAPTER	EACH	8	8	
X8710020	FIBER OPTIC CABLE IN CONDUIT, 62.5/125, MM12F SM12F	FOOT	23,027	23,027	
X8710050	FIBER OPTIC ETHERNET DROP AND REPEAT SWITCH	EACH	9	9	
X8710070	FIBER OPTIC INTERCONNECT CENTER, 24F	EACH	3	3	
X8110170	REPAIR EXISTING CONDUIT ATTACHED TO STRUCTURE	LSUM	1	1	

SUMMARY OF QUANTITIES

ROUTE		SECTION	COUNTY	SHEET	
MKD.	DESIG.	D4 TRAFFIC SIGNALS 2006	PEORIA	TOTAL	NO.
US 150	FAP 315			11	4

FIBER OPTIC INTERCONNECT CENTER, 24F - QTY. 3

EX. CABINET AT IL 29 (ADAMS) & US 150 WB RAMP - 1 EACH
EX. CABINET AT US 150 (WAR MEMORIAL) & GLEN HOLLOW - 1 EACH
EX. CABINET AT US 150 (WAR MEMORIAL) & BIG HOLLOW - 1 EACH

JUNCTION BOX, SPECIAL - QTY. 2

NEAR INTERSECTION OF US 150 (WAR MEMORIAL) & GLEN HOLLOW- 1 EACH
NEAR INTERSECTION OF US 150 (WAR MEMORIAL) & NORTHLAND- 1 EACH

DATA NETWORK PORT ADAPTER - QTY. 8

EX. CABINET AT US 150 (WAR MEMORIAL) & BIG HOLLOW - 1 EACH
EX. CABINET AT US 150 (WAR MEMORIAL) & ALLEN RD. - 1 EACH
EX. CABINET AT US 150 (WAR MEMORIAL) & GLEN/STERLING - 1 EACH
EX. CABINET AT US 150 (WAR MEMORIAL) & UNIVERSITY - 1 EACH
EX. CABINET AT US 150 (WAR MEMORIAL) & SHERIDAN - 1 EACH
EX. CABINET AT US 150 (WAR MEMORIAL) & KNOXVILLE - 1 EACH
EX. CABINET AT US 150 (WAR MEMORIAL) & PROSPECT - 1 EACH
EX. CABINET AT IL 29 (ADAMS) & US 150 WB RAMP - 1 EACH

FIBER OPTIC ETHERNET DROP AND REPEAT SWITCH - QTY. 9

CITY OF PEORIA DRIES LANE FACILITY - 1 EACH
EX. CABINET AT US 150 (WAR MEMORIAL) & BIG HOLLOW - 1 EACH
EX. CABINET AT US 150 (WAR MEMORIAL) & ALLEN RD. - 1 EACH
EX. CABINET AT US 150 (WAR MEMORIAL) & GLEN/STERLING - 1 EACH
EX. CABINET AT US 150 (WAR MEMORIAL) & UNIVERSITY - 1 EACH
EX. CABINET AT US 150 (WAR MEMORIAL) & SHERIDAN - 1 EACH
EX. CABINET AT US 150 (WAR MEMORIAL) & KNOXVILLE - 1 EACH
EX. CABINET AT US 150 (WAR MEMORIAL) & PROSPECT - 1 EACH
EX. CABINET AT IL 29 (ADAMS) & US 150 WB RAMP - 1 EACH

SCHEDULE OF QUANTITIES

ROUTE		SECTION	COUNTY	SHEET	
MKD.	DESIG.	D4 TRAFFIC SIGNALS 2006	PEORIA	TOTAL	NO.
US 150	FAP 315			11	5

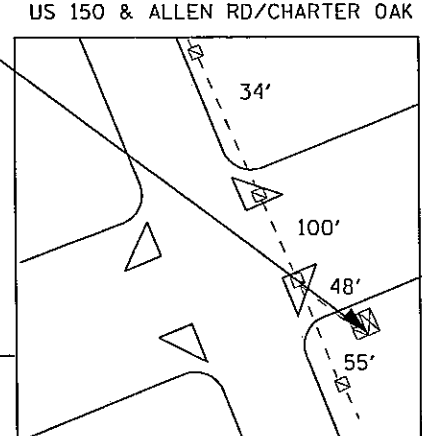
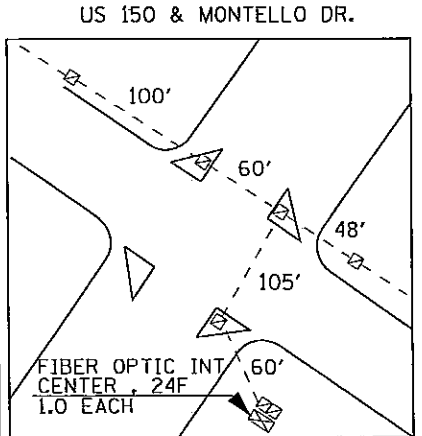
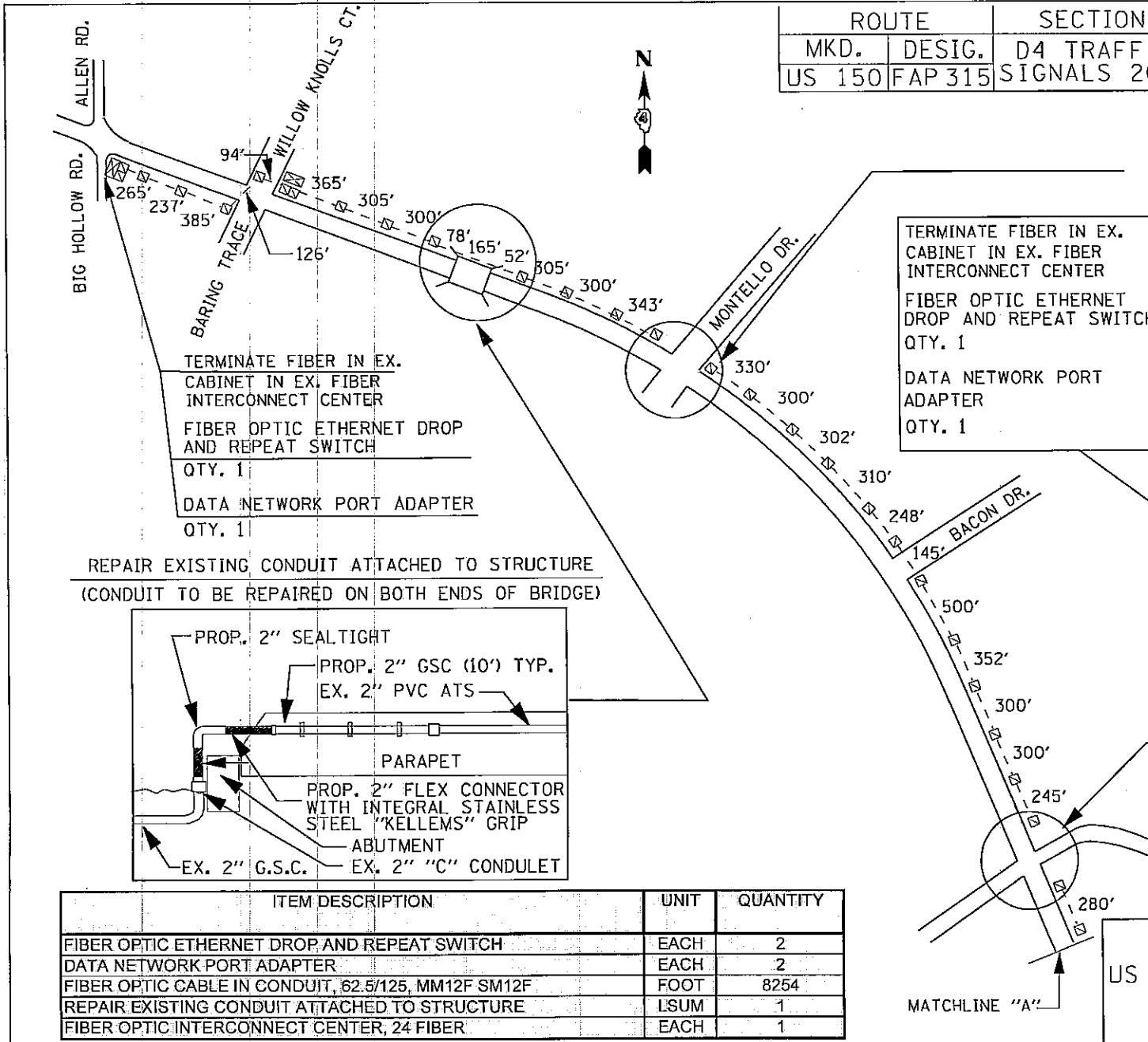

TERMINATE FIBER IN EX. CABINET IN EX. FIBER INTERCONNECT CENTER
 FIBER OPTIC ETHERNET DROP AND REPEAT SWITCH
 QTY. 1
 DATA NETWORK PORT ADAPTER
 QTY. 1

REPAIR EXISTING CONDUIT ATTACHED TO STRUCTURE
 (CONDUIT TO BE REPAIRED ON BOTH ENDS OF BRIDGE)

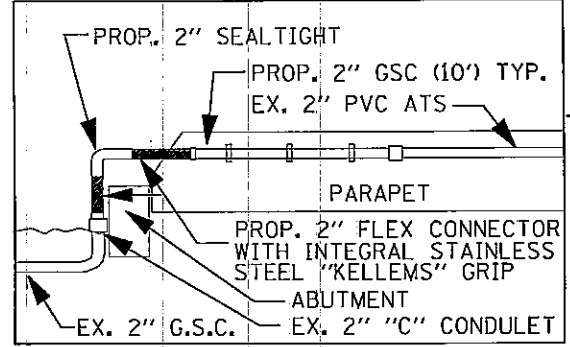

ITEM DESCRIPTION	UNIT	QUANTITY
FIBER OPTIC ETHERNET DROP AND REPEAT SWITCH	EACH	2
DATA NETWORK PORT ADAPTER	EACH	2
FIBER OPTIC CABLE IN CONDUIT, 62.5/125, MM12F SM12F	FOOT	8254
REPAIR EXISTING CONDUIT ATTACHED TO STRUCTURE	LSUM	1
FIBER OPTIC INTERCONNECT CENTER, 24 FIBER	EACH	1

NOT TO SCALE
 CONDUIT DETAILS
 US 150 (WAR MEMORIAL DR.)
 CITY OF PEORIA
 PEORIA COUNTY

ROUTE		SECTION	COUNTY	SHEET	
MKD.	DESIG.	D4 TRAFFIC SIGNALS 2006	PEORIA	TOTAL	NO.
US 150	FAP 315			11	6

ITEM DESCRIPTION	UNIT	QUANTITY
FIBER OPTIC ETHERNET DROP AND REPEAT SWITCH	EACH	1
DATA NETWORK PORT ADAPTER	EACH	1
FIBER OPTIC CABLE IN CONDUIT, 62.5/125, MM12F SM12F	FOOT	5497
FIBER OPTIC INTERCONNECT CENTER, 24 FIBER	EACH	1
JUNCTION BOX (SPECIAL)	EACH	2

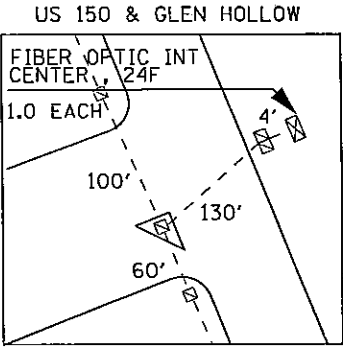
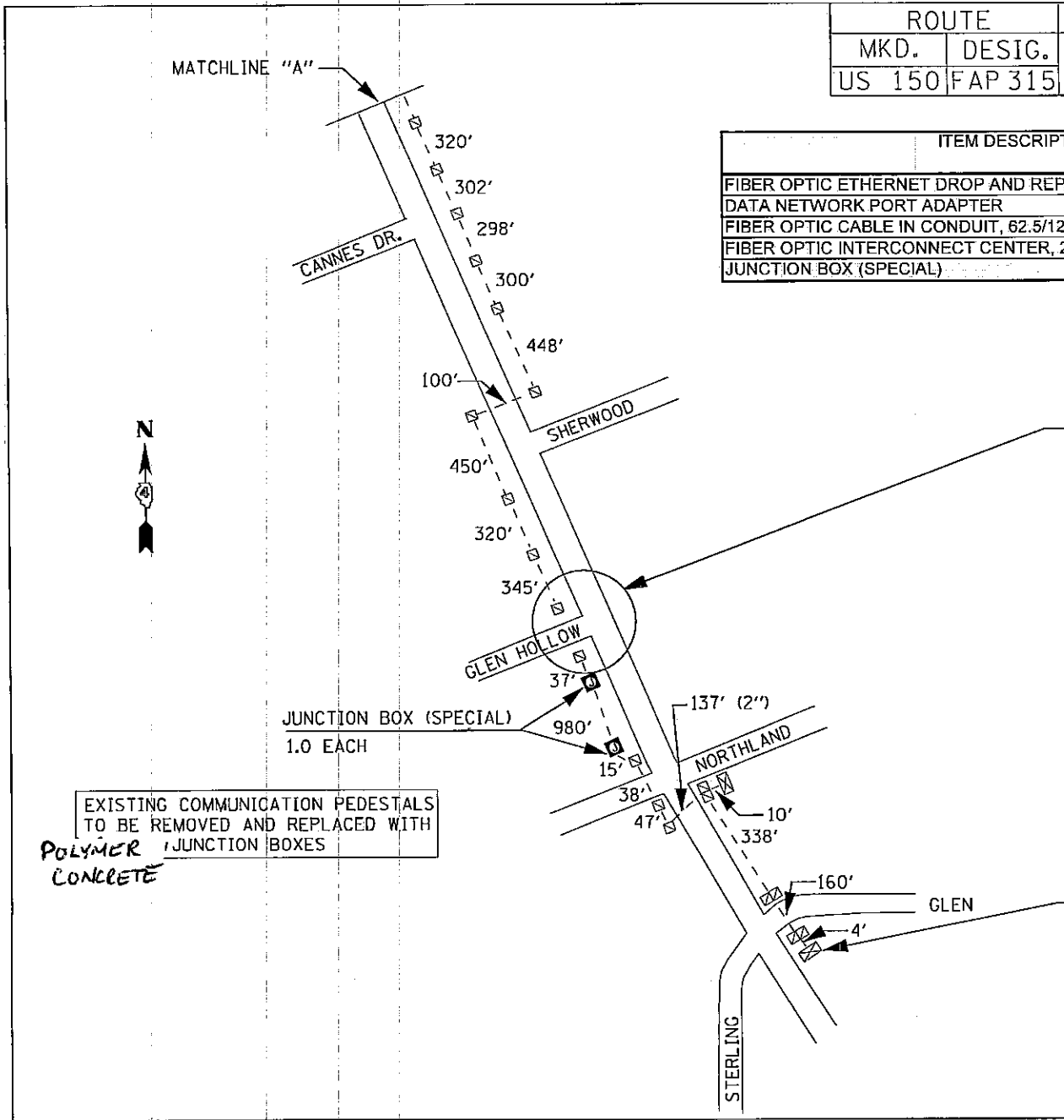

TERMINATE FIBER IN EX. CABINET IN EX. FIBER INTERCONNECT CENTER

FIBER OPTIC ETHERNET DROP AND REPEAT SWITCH QTY. 1

DATA NETWORK PORT ADAPTER QTY. 1

NOT TO SCALE

CONDUIT DETAILS
IL 40 (KNOXVILLE AVE.)
PEORIA
PEORIA COUNTY

ROUTE		SECTION	COUNTY	SHEET	
MKD.	DESIG.	D4 TRAFFIC SIGNALS 2006	PEORIA	TOTAL	NO.
US 150	FAP315			11	7

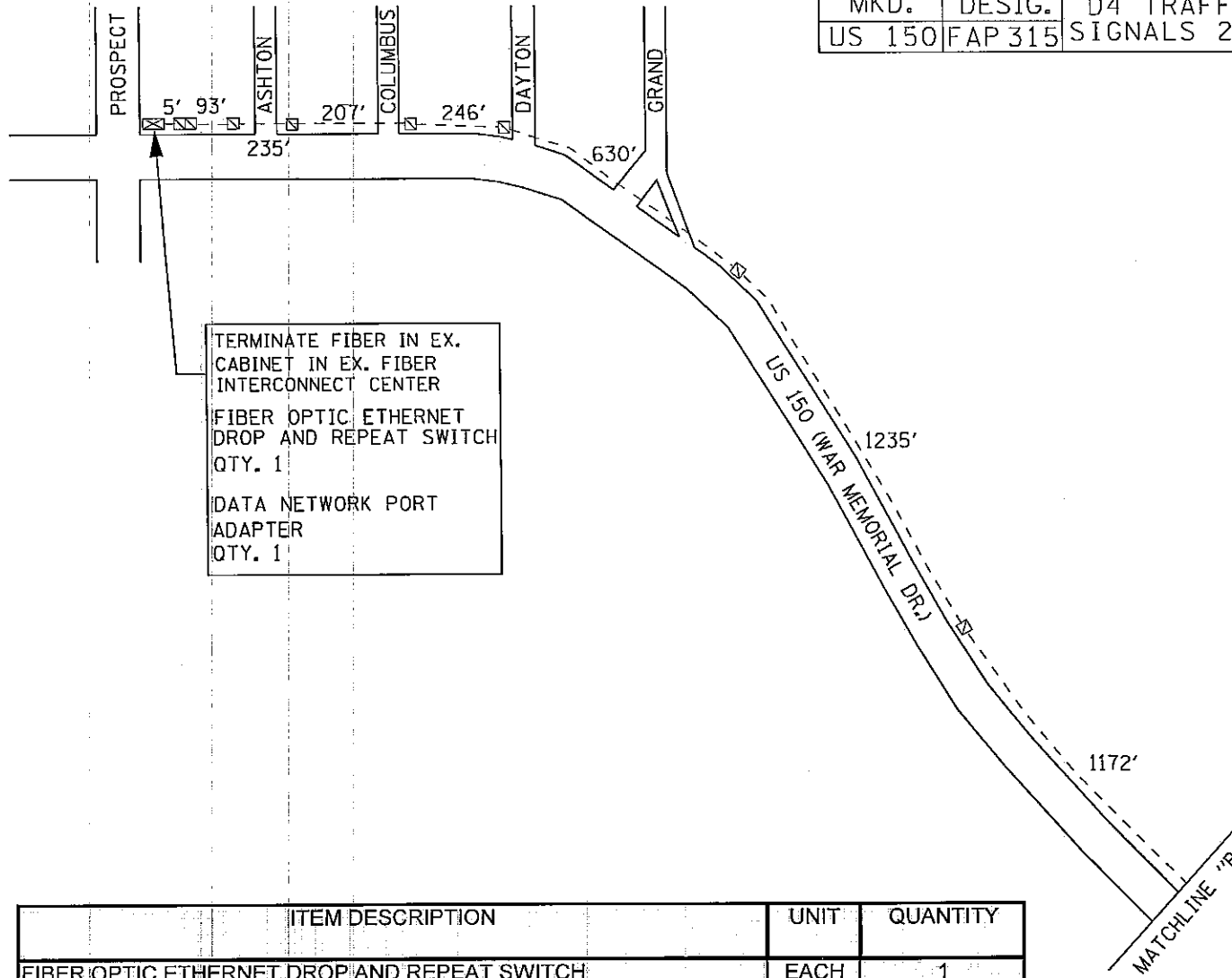

TERMINATE FIBER IN EX. CABINET IN EX. FIBER INTERCONNECT CENTER
 FIBER OPTIC ETHERNET DROP AND REPEAT SWITCH
 QTY. 1
 DATA NETWORK PORT ADAPTER
 QTY. 1



ITEM DESCRIPTION	UNIT	QUANTITY
FIBER OPTIC ETHERNET DROP AND REPEAT SWITCH	EACH	1
DATA NETWORK PORT ADAPTER	EACH	1
FIBER OPTIC CABLE IN CONDUIT, 62.5/125, MM12F SM12F	FOOT	3936

NOT TO SCALE
 CONDUIT DETAILS
 US 150 (WAR MEMORIAL DR.)
 CITY OF PEORIA
 PEORIA COUNTY

ROUTE		SECTION	COUNTY	SHEET	
MKD.	DESIG.	D4 TRAFFIC SIGNALS 2006	PEORIA	TOTAL	NO.
US 150	FAP 315			11	8

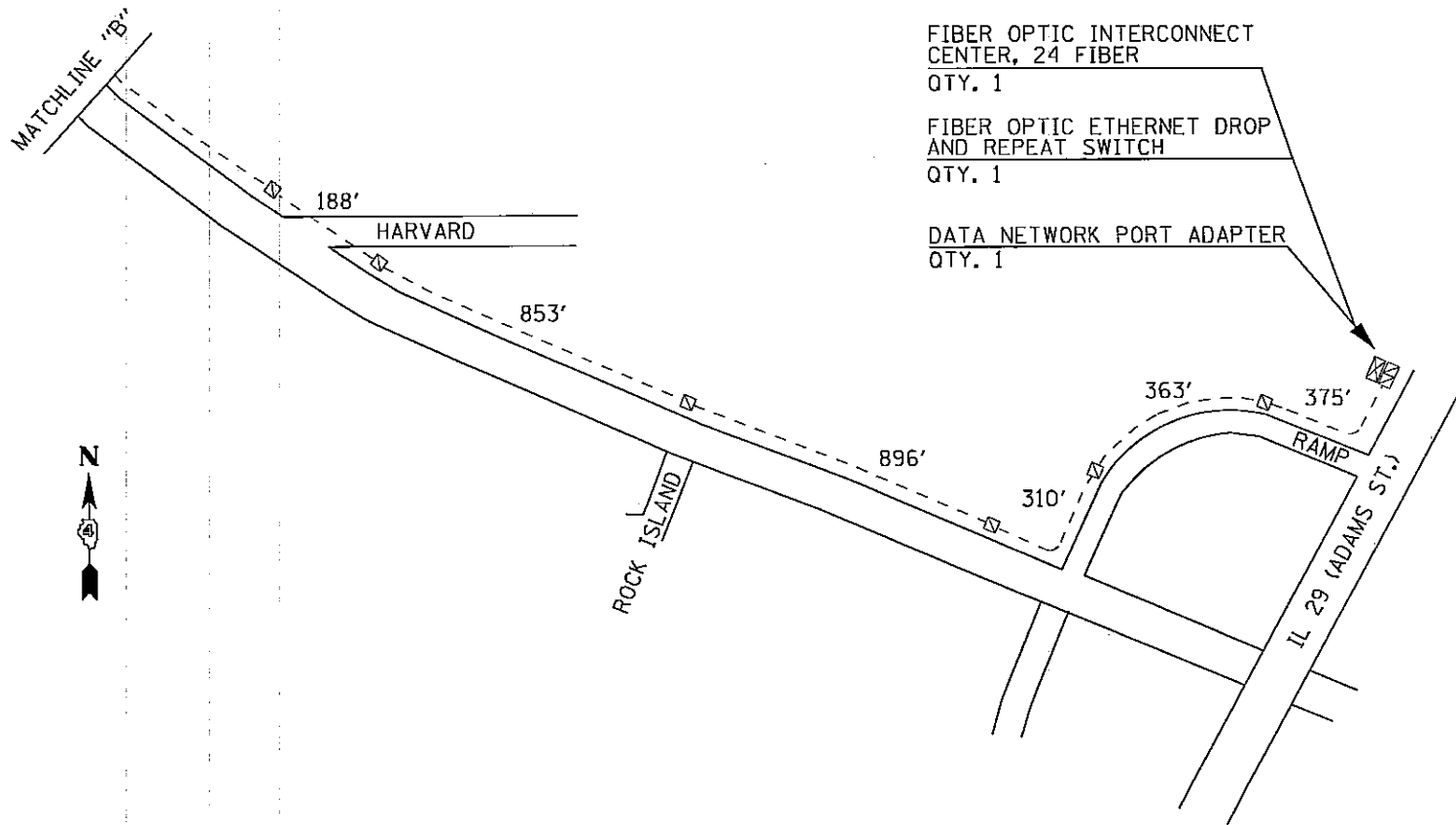

- FIBER OPTIC INTERCONNECT CENTER, 24 FIBER
QTY. 1
- FIBER OPTIC ETHERNET DROP AND REPEAT SWITCH
QTY. 1
- DATA NETWORK PORT ADAPTER
QTY. 1

ITEM DESCRIPTION	UNIT	QUANTITY
FIBER OPTIC ETHERNET DROP AND REPEAT SWITCH	EACH	1
DATA NETWORK PORT ADAPTER	EACH	1
FIBER OPTIC CABLE IN CONDUIT, 62.5/125, MM12F SM12F	FOOT	3098
FIBER OPTIC INTERCONNECT CENTER, 24 FIBER	EACH	1

NOT TO SCALE

CONDUIT DETAILS
 US 150 (WAR MEMORIAL DR.)
 PEORIA
 PEORIA COUNTY

ROUTE		SECTION	COUNTY	SHEET	
MKD.	DESIG.	D4 TRAFFIC SIGNALS	PEORIA	TOTAL	NO.
US 150	FAP 315	2006		11	9

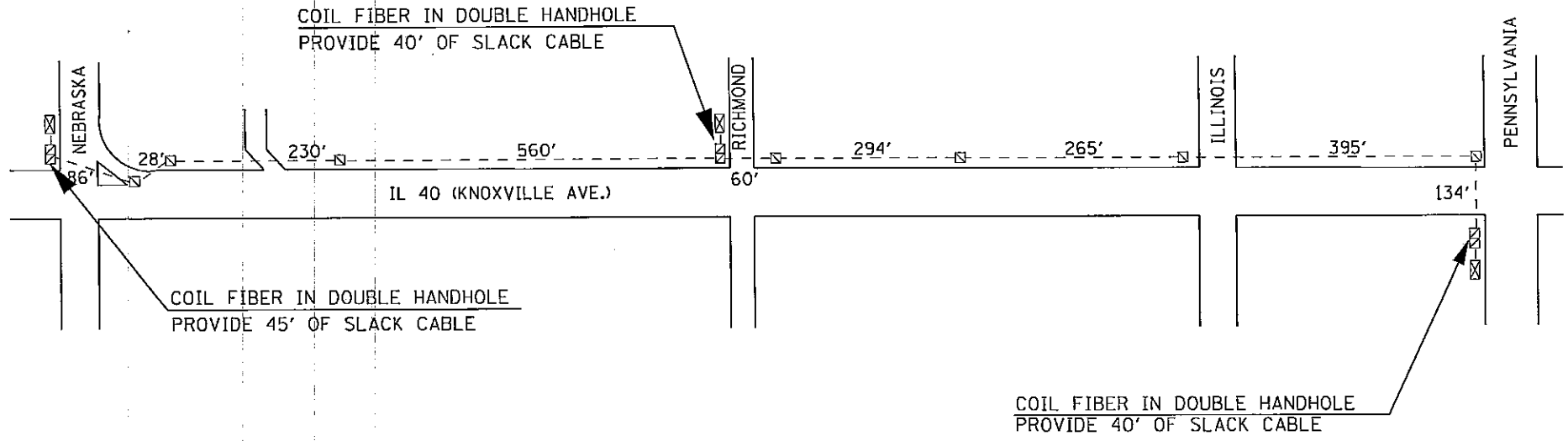
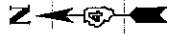

ITEM DESCRIPTION	UNIT	QUANTITY
FIBER OPTIC CABLE IN CONDUIT, 62.5/125, MM12F SM12F	FOOT	2242

NOT TO SCALE

CONDUIT DETAILS
 IL 40 (KNOXVILLE AVE.)
 PEORIA
 PEORIA COUNTY

ROUTE		SECTION	COUNTY	SHEET	
MKD.	DESIG.	D4 TRAFFIC SIGNALS 2006	PEORIA	TOTAL	NO.
US 150	FAP 315			11	10

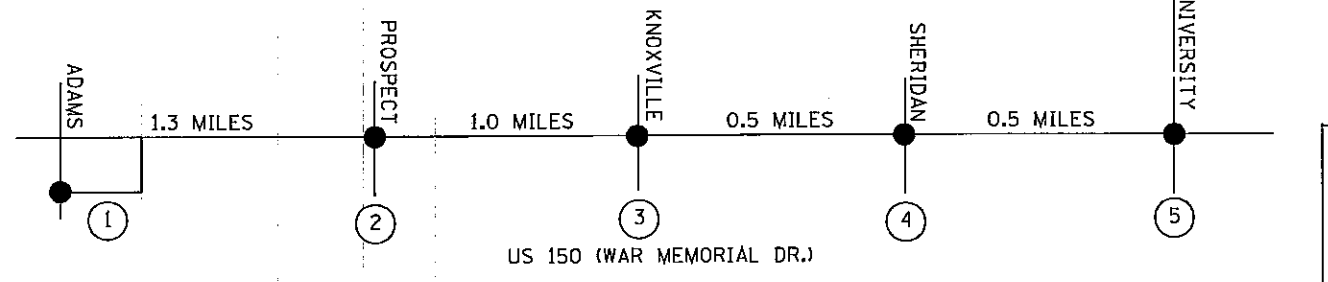
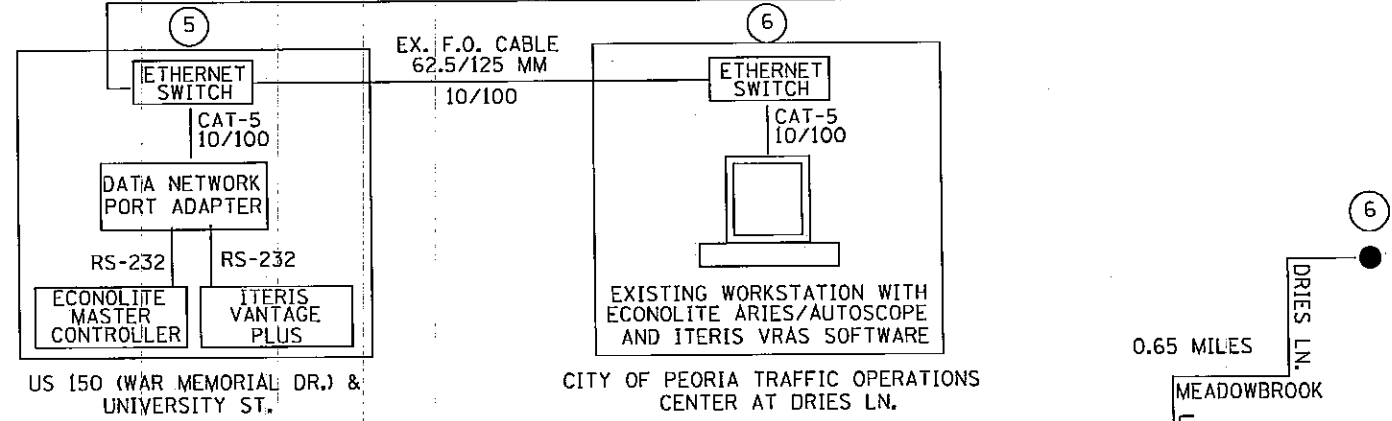
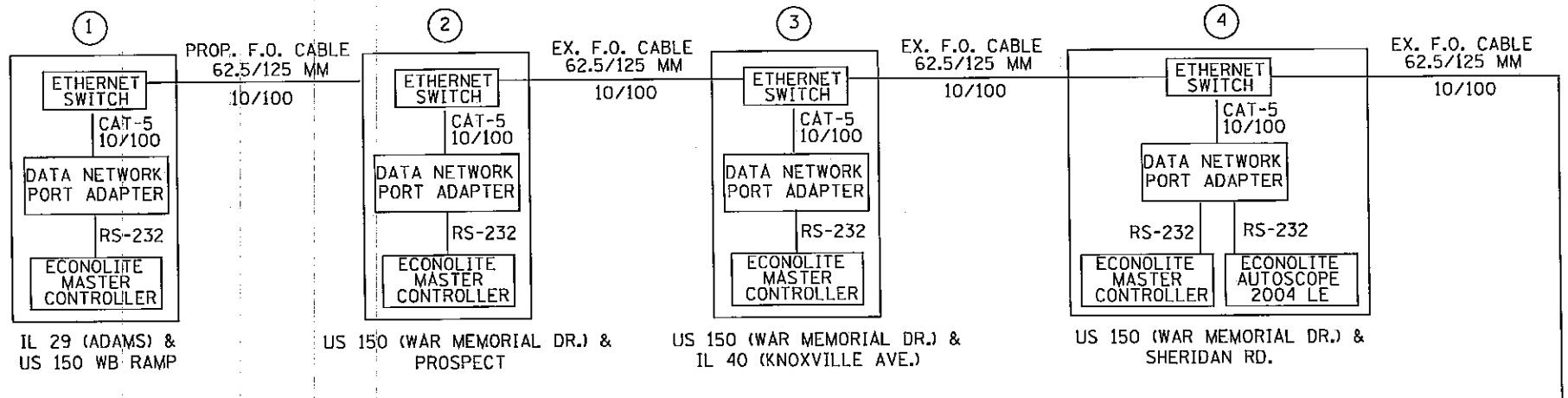

NOT TO SCALE

COMMUNICATION LINE DIAGRAM
 US 150 (WAR MEMORIAL DR.)
 CITY OF PEORIA
 PEORIA COUNTY

ROUTE		SECTION	COUNTY	SHEET	
MKD.	DESIG.	D4 TRAFFIC SIGNALS	PEORIA	TOTAL	NO.
US 150	FAP 315	2006		11	11

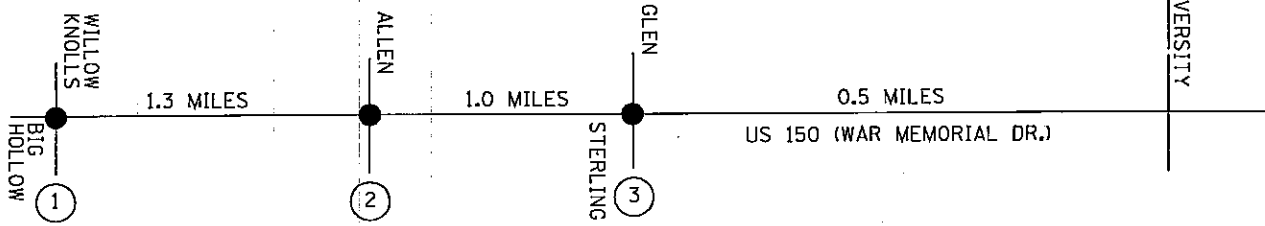
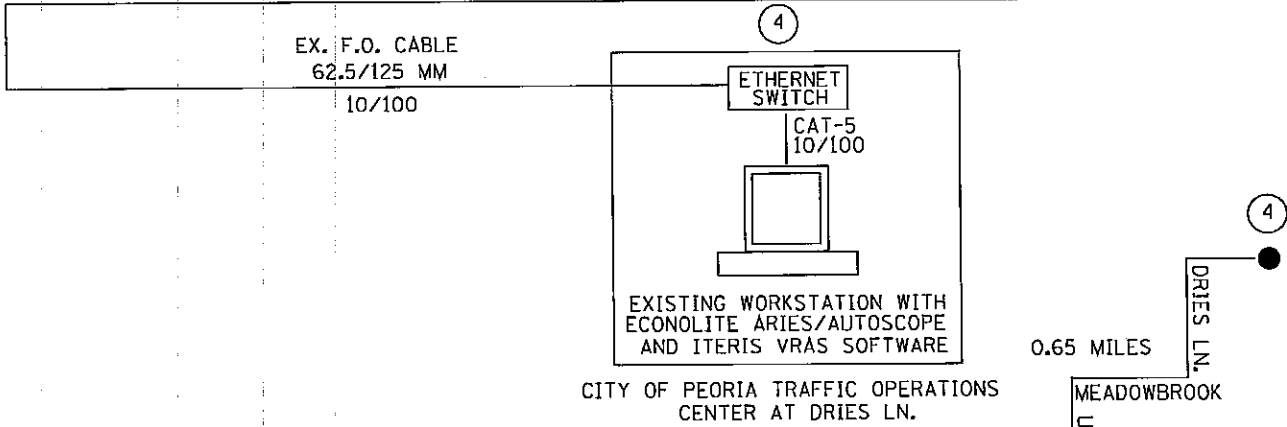
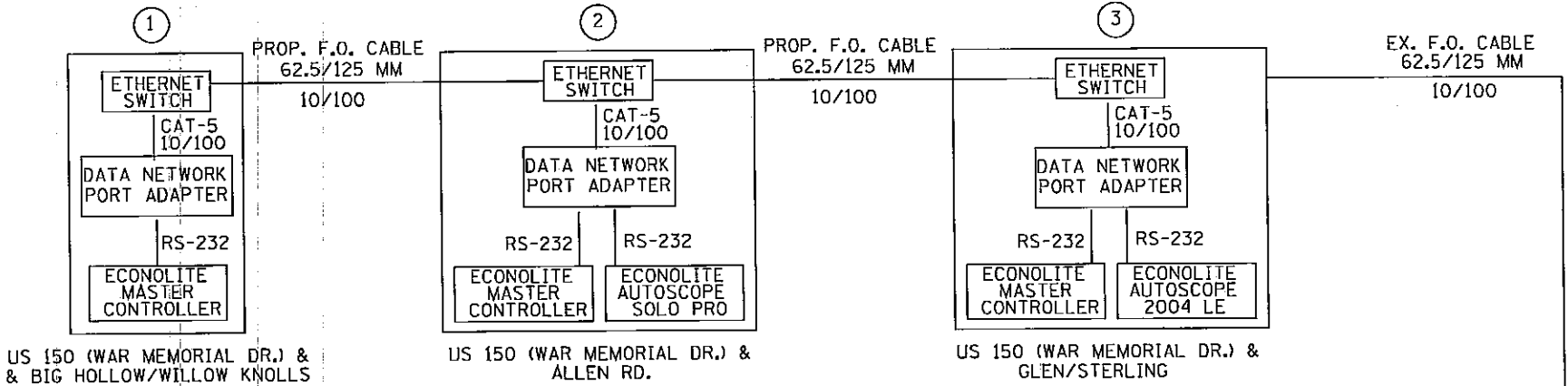

NOT TO SCALE
 COMMUNICATION LINE DIAGRAM
 US 150 (WAR MEMORIAL DR.)
 CITY OF PEORIA
 PEORIA COUNTY

ILLINOIS DEPARTMENT OF LABOR

PREVAILING WAGES FOR PEORIA COUNTY EFFECTIVE DECEMBER 2005

The Prevailing rates of wages are included in the Contract proposals which are subject to Check Sheet #5 of the Supplemental Specifications and Recurring Special Provisions. The rates have been ascertained and certified by the Illinois Department of Labor for the locality in which the work is to be performed and for each craft or type of work or mechanic needed to execute the work of the Contract. As required by Prevailing Wage Act (820 ILCS 130/0.01, et seq.) and Check Sheet #5 of the Contract, not less than the rates of wages ascertained by the Illinois Department of Labor and as revised during the performance of a Contract shall be paid to all laborers, workers and mechanics performing work under the Contract. Post the scale of wages in a prominent and easily accessible place at the site of work.

If the Illinois Department of Labor revises the prevailing rates of wages to be paid as listed in the specification of rates, the contractor shall post the revised rates of wages and shall pay not less than the revised rates of wages. Current wage rate information shall be obtained by visiting the Illinois Department of Labor web site at <http://www.state.il.us/agency/idol/> or by calling 312-793-2814. It is the responsibility of the contractor to review the rates applicable to the work of the contract at regular intervals in order to insure the timely payment of current rates. Provision of this information to the contractor by means of the Illinois Department of Labor web site satisfies the notification of revisions by the Department to the contractor pursuant to the Act, and the contractor agrees that no additional notice is required. The contractor shall notify each of its subcontractors of the revised rates of wages.

Peoria County Prevailing Wage for December 2005

Trade Name	RG	TYP	C	Base	FRMAN	*M-F>8	OSA	OSH	H/W	Pensn	Vac	Trng
=====	==	==	=	=====	=====	=====	==	==	=====	=====	=====	=====
ASBESTOS ABT-GEN		BLD		21.910	22.510	1.5	1.5	2.0	5.700	8.000	0.000	0.600
ASBESTOS ABT-GEN		HWY		23.000	23.750	1.5	1.5	2.0	5.700	8.200	0.000	0.750
ASBESTOS ABT-MEC		BLD		23.300	24.800	1.5	1.5	2.0	7.860	4.910	0.000	0.000
BOILERMAKER		BLD		28.970	31.970	2.0	2.0	2.0	7.020	6.600	0.000	0.210
BRICK MASON		BLD		26.110	27.610	1.5	1.5	2.0	5.000	6.100	0.000	0.360
CARPENTER		BLD		24.940	26.690	1.5	1.5	2.0	6.500	6.450	0.000	0.300
CARPENTER		HWY		25.520	27.270	1.5	1.5	2.0	6.500	6.410	0.000	0.250
CEMENT MASON		BLD		22.480	23.980	1.5	1.5	2.0	4.950	9.300	0.000	0.500
CEMENT MASON		HWY		23.280	24.280	1.5	1.5	2.0	4.950	9.300	0.000	0.500
CERAMIC TILE FNSHER		BLD		24.090	0.000	1.5	1.5	2.0	5.000	6.100	0.000	0.350
ELECTRIC PWR EQMT OP		ALL		28.840	34.100	1.5	1.5	2.0	4.500	7.790	0.000	0.000
ELECTRIC PWR GRNDMAN		ALL		19.790	34.100	1.5	1.5	2.0	4.500	5.340	0.000	0.000
ELECTRIC PWR LINEMAN		ALL		32.040	34.100	1.5	1.5	2.0	4.500	8.650	0.000	0.000
ELECTRIC PWR TRK DRV		ALL		20.760	34.100	1.5	1.5	2.0	4.500	5.600	0.000	0.000
ELECTRICIAN		BLD		28.030	29.530	1.5	1.5	2.0	5.150	7.385	0.000	0.250
ELECTRONIC SYS TECH		BLD		22.830	24.330	1.5	1.5	2.0	5.150	5.185	0.000	0.250
ELEVATOR CONSTRUCTOR		BLD		31.135	35.030	2.0	2.0	2.0	7.275	3.420	1.870	0.000
GLAZIER		BLD		25.620	26.370	1.5	1.5	2.0	5.150	5.550	0.000	0.300
HT/FROST INSULATOR		BLD		32.800	34.550	1.5	1.5	2.0	7.860	8.610	0.000	0.310
IRON WORKER		BLD		24.080	25.830	1.5	1.5	2.0	7.690	6.910	0.000	0.300
IRON WORKER		HWY		25.790	27.290	1.5	1.5	2.0	7.690	6.910	0.000	0.320
LABORER		BLD		20.190	21.510	1.5	1.5	2.0	5.700	8.000	0.000	0.600
LABORER		HWY		22.250	23.000	1.5	1.5	2.0	5.700	8.200	0.000	0.600
LABORER, SKILLED		BLD		21.310	21.910	1.5	1.5	2.0	5.700	8.000	0.000	0.600
LABORER, SKILLED		HWY		22.550	23.300	1.5	1.5	2.0	5.700	8.200	0.000	0.600
LATHER		BLD		24.940	26.690	1.5	1.5	2.0	6.500	6.450	0.000	0.300
MACHINERY MOVER		HWY		25.790	27.290	1.5	1.5	2.0	7.690	6.910	0.000	0.320
MACHINIST		BLD		35.630	37.630	2.0	2.0	2.0	3.880	4.750	2.460	0.000
MARBLE FINISHERS		BLD		24.090	0.000	1.5	1.5	2.0	5.000	6.100	0.000	0.350
MARBLE MASON		BLD		25.630	26.880	1.5	1.5	2.0	5.000	6.100	0.000	0.350
MILLWRIGHT		BLD		25.860	27.610	1.5	1.5	2.0	6.500	5.850	0.000	0.300
MILLWRIGHT		HWY		21.150	22.400	1.5	1.5	2.0	2.800	2.430	0.000	0.000
OPERATING ENGINEER		BLD	1	27.310	29.060	1.5	1.5	2.0	4.650	7.750	0.000	0.800
OPERATING ENGINEER		BLD	2	25.490	29.060	1.5	1.5	2.0	4.650	7.750	0.000	0.800
OPERATING ENGINEER		BLD	3	24.170	29.060	1.5	1.5	2.0	4.650	7.750	0.000	0.800
OPERATING ENGINEER		HWY	1	27.420	30.420	1.5	1.5	2.0	5.150	7.750	0.000	0.800
OPERATING ENGINEER		HWY	2	25.260	30.420	1.5	1.5	2.0	5.150	7.750	0.000	0.800
OPERATING ENGINEER		HWY	3	21.690	30.420	1.5	1.5	2.0	5.150	7.750	0.000	0.800
PAINTER		ALL		26.150	27.150	1.5	1.5	1.5	5.150	5.000	0.000	0.250
PAINTER SIGNS		BLD		25.150	28.240	1.5	1.5	1.5	2.600	2.010	0.000	0.000
PILEDRIVER		BLD		25.440	27.190	1.5	1.5	2.0	6.500	6.450	0.000	0.300
PILEDRIVER		HWY		26.020	27.770	1.5	1.5	2.0	6.500	6.410	0.000	0.250
PIPEFITTER		BLD		31.300	34.430	1.5	1.5	2.0	6.100	6.460	0.000	0.420
PLASTERER		BLD		22.340	23.590	1.5	1.5	2.0	4.950	9.500	0.000	0.500
PLUMBER		BLD		27.970	30.490	1.5	1.5	2.0	6.100	7.910	0.000	0.800
ROOFER		BLD		23.200	24.200	1.5	1.5	2.0	5.350	6.100	0.000	0.150
SHEETMETAL WORKER		BLD		27.030	28.380	1.5	1.5	2.0	5.370	8.320	0.000	0.310
SIGN HANGER		HWY		25.790	27.290	1.5	1.5	2.0	7.690	6.910	0.000	0.320
SPRINKLER FITTER		BLD		31.240	33.240	1.5	1.5	2.0	6.100	5.000	0.000	0.250
STEEL ERECTOR		HWY		25.790	27.290	1.5	1.5	2.0	7.690	6.910	0.000	0.320
STONE MASON		BLD		26.110	27.610	1.5	1.5	2.0	5.000	6.100	0.000	0.360
TERRAZZO FINISHER		BLD		24.090	0.000	1.5	1.5	2.0	5.000	6.100	0.000	0.350
TERRAZZO MASON		BLD		25.630	26.880	1.5	1.5	2.0	5.000	6.100	0.000	0.350
TILE MASON		BLD		25.630	26.880	1.5	1.5	2.0	5.000	6.100	0.000	0.350
TRUCK DRIVER		ALL	1	24.755	0.000	1.5	1.5	2.0	7.000	3.100	0.000	0.000
TRUCK DRIVER		ALL	2	25.155	0.000	1.5	1.5	2.0	7.000	3.100	0.000	0.000
TRUCK DRIVER		ALL	3	25.355	0.000	1.5	1.5	2.0	7.000	3.100	0.000	0.000
TRUCK DRIVER		ALL	4	25.605	0.000	1.5	1.5	2.0	7.000	3.100	0.000	0.000

TRUCK DRIVER	ALL	5	26.355	0.000	1.5	1.5	2.0	7.000	3.100	0.000	0.000
TRUCK DRIVER	O&C	1	19.804	0.000	1.5	1.5	2.0	7.000	3.100	0.000	0.000
TRUCK DRIVER	O&C	2	20.124	0.000	1.5	1.5	2.0	7.000	3.100	0.000	0.000
TRUCK DRIVER	O&C	3	20.284	0.000	1.5	1.5	2.0	7.000	3.100	0.000	0.000
TRUCK DRIVER	O&C	4	20.484	0.000	1.5	1.5	2.0	7.000	3.100	0.000	0.000
TRUCK DRIVER	O&C	5	21.084	0.000	1.5	1.5	2.0	7.000	3.100	0.000	0.000
TUCKPOINTER	BLD		26.110	27.610	1.5	1.5	2.0	5.000	6.100	0.000	0.360

Legend:

M-F>8 (Overtime is required for any hour greater than 8 worked each day, Monday through Friday.)

OSA (Overtime is required for every hour worked on Saturday)

OSH (Overtime is required for every hour worked on Sunday and Holidays)

H/W (Health & Welfare Insurance)

Pensn (Pension)

Vac (Vacation)

Trng (Training)

Explanations

PEORIA COUNTY

The following list is considered as those days for which holiday rates of wages for work performed apply: New Years Day, Memorial/Decoration Day, Fourth of July, Labor Day, Veterans Day, Thanksgiving Day, Christmas Day. Generally, any of these holidays which fall on a Sunday is celebrated on the following Monday. This then makes work performed on that Monday payable at the appropriate overtime rate for holiday pay. Common practice in a given local may alter certain days of celebration such as the day after Thanksgiving for Veterans Day. If in doubt, please check with IDOL.

Oil and chip resealing (O&C) means the application of road oils and liquid asphalt to coat an existing road surface, followed by application of aggregate chips or gravel to coated surface, and subsequent rolling of material to seal the surface.

EXPLANATION OF CLASSES

ASBESTOS - GENERAL - removal of asbestos material/mold and hazardous materials from any place in a building, including mechanical systems where those mechanical systems are to be removed. This includes the removal of asbestos materials/mold and hazardous materials from ductwork or pipes in a building when the building is to be demolished at the time or at some close future date.

ASBESTOS - MECHANICAL - removal of asbestos material from mechanical systems, such as pipes, ducts, and boilers, where the mechanical systems are to remain.

CERAMIC TILE FINISHER, MARBLE FINISHER, TERRAZZO FINISHER

Assisting, helping or supporting the tile, marble and terrazzo mechanic by performing their historic and traditional work assignments required to complete the proper installation of the work covered by said crafts. The term "Ceramic" is used for naming the classification only and is in no way a limitation of the product handled. Ceramic takes into consideration most hard tiles.

ELECTRONIC SYSTEMS TECHNICIAN

Installation, service and maintenance of low-voltage systems which utilizes the transmission and/or transference of voice, sound, vision, or digital for commercial, education, security and entertainment purposes for the following: TV monitoring and surveillance, background/foreground music, intercom and telephone interconnect, field programming, inventory control systems, microwave transmission, multi-media, multiplex, radio page, school, intercom and sound burglar alarms and low voltage master clock systems.

Excluded from this classification are energy management systems, life safety systems, supervisory controls and data acquisition systems not intrinsic with the above listed systems, fire alarm systems, nurse call systems and raceways exceeding fifteen feet in length.

LABORER, SKILLED - BUILDING

The skilled laborer building (BLD) classification shall encompass the following types of work, irrespective of the site of the work: cutting & acetylene torch, gunnite nozzlemen, gunnite pump men & pots, kettlemen & carriers of men handling hot stuff, sandblaster nozzle men, sandblasting pump men & pots, setting up and using concrete burning bars, wood block setters, underpinning & shoring of existing buildings, and the unloading and handling of all material coated with creosote.

LABORER, SKILLED - HIGHWAY

The skilled laborer heavy & highway (HWY) classification shall encompass the following types of work, irrespective of the site of the work: jackhammer & drill operator, gunite pump & pot man, puddlers, vibrator men, wire fabric placer, sandblast pump & pot man, strike off concrete, unloading, handling & carrying of all creosoted piles, ties or timber, concrete burning bars, power wheelbarrows or buggies, asphalt raker, bricksetters, cutting torchman (electric & acetylene), men setting lines to level forms, form setters, gunite nozzle man & sandblasting nozzle man, power man, and rip-rapping by hand.

TRUCK DRIVER - BUILDING, HEAVY AND HIGHWAY CONSTRUCTION

Class 1. Drivers on 2 axle trucks hauling less than 9 ton. Air compressor and welding machines and brooms, including those pulled by separate units, truck driver helpers, warehouse employees, mechanic helpers, greasers and tiremen, pickup trucks when hauling materials, tools, or workers to and from and on-the-job site, and fork lifts up to 6,000 lb. capacity.

Class 2. Two or three axle trucks hauling more than 9 ton but hauling less than 16 ton. A-frame winch trucks, hydrolift trucks, vector trucks or similar equipment when used for transportation purposes. Fork lifts over 6,000 lb. capacity, winch trucks, four axle combination units, and ticket writers.

Class 3. Two, three or four axle trucks hauling 16 ton or more. Drivers on water pulls, articulated dump trucks, mechanics and working

forepersons, and dispatchers. Five axle or more combination units.

Class 4. Low Boy and Oil Distributors.

Class 5. Drivers who require special protective clothing while employed on hazardous waste work.

TRUCK DRIVER - OIL AND CHIP RESEALING ONLY.

This shall encompass laborers, workers and mechanics who drive contractor or subcontractor owned, leased, or hired pickup, dump, service, or oil distributor trucks. The work includes transporting materials and equipment (including but not limited to, oils, aggregate supplies, parts, machinery and tools) to or from the job site; distributing oil or liquid asphalt and aggregate; stock piling material when in connection with the actual oil and chip contract. The Truck Driver (Oil & Chip Resealing) wage classification does not include supplier delivered materials.

OPERATING ENGINEERS - BUILDING

Class 1. Cranes; Overhead Cranes; Gradall; All Cherry Pickers; Mechanics; Central Concrete Mixing Plant Operator; Road Pavers (27E - Dual Drum - Tri Batchers); Blacktop Plant Operators and Plant Engineers; 3 Drum Hoist; Derricks; Hydro Cranes; Shovels; Skimmer Scoops; Koehring Scooper; Drag Lines; Backhoe; Derrick Boats; Pile Drivers and Skid Rigs; Clamshells; Locomotive Cranes; Dredge (all types) Motor Patrol; Power Blades - Dumore - Elevating and similar types; Tower Cranes (Crawler-Mobile) and Stationary; Crane-type Backfiller; Drott Yumbo and similar types considered as Cranes; Caisson Rigs; Dozer; Tournadozer; Work Boats; Ross Carrier; Helicopter; Tournapulls - all and similar types; Scoops (all sizes); Pushcats; Endloaders (all types); Asphalt Surfacing Machine; Slip Form Paver; Rock Crusher; Heavy Equipment Greaser; CMI, CMI Belt Placer, Auto Grade & 3 Track and similar types; Side Booms; Multiple Unit Earth Movers; Creter Crane; Trench Machine; Pump-crete-Belt Crete-Squeeze Cretes-Screw-type Pumps and Gypsum; Bulker & Pump - Operator will clean; Formless Finishing Machine; Flaherty Spreader or similar types; Screed Man on Laydown Machine; Wheel Tractors (industrial or Farm-type w/Dozer-Hoe-Endloader or other attachments); F.W.D. & Similar Types; Vermeer Concrete Saw.

Class 2. Dinkeys; Power Launches; PH One-pass Soil Cement Machine (and similar types); Pugmill with Pump; Backfillers; Euclid Loader; Forklifts; Jeeps w/Ditching Machine or other attachments; Tuneluger; Automatic Cement and Gravel Batching Plants; Mobile Drills (Soil Testing) and similar types; Gurries and Similar Types; (1) and (2) Drum Hoists (Buck Hoist and Similar Types); Chicago Boom; Boring Machine & Pipe Jacking Machine; Hydro Boom; Dewatering System; Straw Blower; Hydro Seeder; Assistant Heavy Equipment Greaser on Spread; Tractors (Track type) without Power Unit pulling Rollers; Rollers on Asphalt -- Brick Macadem; Concrete Breakers; Concrete Spreaders; Mule Pulling Rollers; Center Stripper; Cement Finishing Machines & CMI Texture & Reel Curing Machines; Cement Finishing Machine; Barber Green or similar loaders; Vibro Tamper (All similar types) Self-propelled; Winch or Boom Truck; Mechanical Bull Floats; Mixers over 3 Bag to 27E; Tractor pulling Power Blade or Elevating Grader; Porter Rex Rail; Clary Screed; Truck Type Hoptoe Oilers; Fireman; Spray Machine on Paving; Curb Machines; Truck Crane Oilers; Oil Distributor; Truck-Mounted Saws.

Class 3. Air Compressor; Power Subgrader; Straight Tractor; Trac Air

without attachments; Herman Nelson Heater, Dravo, Warner, Silent Glo, and similar types; Roller: Five (5) Ton and under on Earth or Gravel; Form Grader; Crawler Crane & Skid Rig Oilers; Freight Elevators - permanently installed; Pump; Light Plant; Generator; Conveyor (1) or (2) - Operator will clean; Welding Machine; Mixer (3) Bag and Under (Standard Capacity with skip); Bulk Cement Plant; Oiler on Central Concrete Mixing Plant.

OPERATING ENGINEERS - HEAVY AND HIGHWAY CONSTRUCTION

Class 1. Cranes; Hydro Crane; Shovels; Crane Type Backfiller; Tower Cranes - Mobile & Crawler & Stationary; Derricks & Hoists (3 Drum); Draglines; Drott Yumbo & similar types considered as Cranes; Back Hoe; Derrick Boats; Pile Driver and Skid Rigs; Clam Shell; Locomotive - Cranes; Road Pavers - Single Drum - Dual Drum - Tri Batcher; Motor Patrols & Power Blades - Dumore - Elevating & Similar Types; Mechanics; Central Concrete Mixing Plant Operator; Asphalt Batch Plant Operators and Plant Engineers; Gradall; Caisson Rigs; Skimmer Scoop - Koering Scooper; Dredges (all types); Hoptoe; All Cherry Pickers; Work Boat; Ross Carrier; Helicopter; Dozer; Tournadozer; Tournapulls - all and similar types; Multiple Unit Earth Movers; Scoops (all sizes); Pushcats; Endloaders (all types); Asphalt Surfacing Machine; Slip Form Paver; Rock Crusher; Heavy Equipment Greaser (top greaser on spread); CMI, Auto Grade, CMI Belt Placer & 3 Track and similar types; Side Booms; Starting Engineer on Pipeline; Asphalt Heater & Planer Combination (used to plane streets); Wheel Tractors (with dozer, hoe or endloader attachments); F.W.D. and Similar types; Blaw Knox Spreader and Similar types; Trench Machines; Pump Crete - Belt Crete - Squeeze Crete - screw type pumps and gypsum (operator will clean); Formless Finishing Machines; Flaherty Spreader or similar types; Screed Man on Laydown Machine; Vermeer Concrete Saw.

Class 2. Bulker & Pump; Power Launches; Boring Machine & Pipe Jacking Machine; Dinkeys; P-H One Pass Soil Cement Machines and similar types; Wheel Tractors (Industry or farm type - other); Back Fillers; Euclid Loader; Fork Lifts; Jeep w/Ditching Machine or other attachments; Tunneluger; Automatic Cement & Gravel Batching Plants; Mobile Drills - Soil Testing and similar types; Pugmill with pump; All (1) and (2) Drum Hoists; Dewatering System; Straw Blower; Hydro-Seeder; Boring Machine; Hydro-Boom; Bump Grinders (self-propelled); Assistant Heavy Equipment Greaser; Apsco Spreader; Tractors (track-type) without Power Units Pulling Rollers on Asphalt - Brick or Macadam; Concrete Breakers; Concrete Spreaders; Cement Strippers; Cement Finishing Machines & CMI Texture & Reel Curing Machines; Vibro-Tampers (all similar types self-propelled); Mechanical Bull Floats; Self-propelled Concrete Saws; Mixers-over three (3) bags to 27E; Winch and Boom Trucks; Tractor Pulling Power Blade or Elevating Grader; Porter Rex Rail; Clary Screed; Mule Pulling Rollers; Pugmill without Pump; Barber Greene or similar Loaders; Track Type Tractor w/Power Unit attached (minimum); Fireman; Spray Machine on Paving; Curb Machines; Paved Ditch Machine; Power Broom; Self-Propelled Conveyors; Power Subgrader; Oil Distributor; Straight Tractor; Truck Crane Oiler; Truck Type Oilers; Directional boring machine; Horizontal directional drill.

Class 3. Straight framed articulating end dump vehicles and Truck mounted vac unit (separately powered); Trac Air Machine (without attachments); Herman Nelson Heater, Dravo Warner, Silent Glo & similar types; Rollers - five ton and under on earth and gravel; Form Graders; Pumps; Light Plant; Generator; Air Compressor (1) or (2); Conveyor; Welding Machine; Mixer - 3 bags and under; Bulk Cement Plant; Oilers.

Other Classifications of Work:

For definitions of classifications not otherwise set out, the Department generally has on file such definitions which are available. If a task to be performed is not subject to one of the classifications of pay set out, the Department will upon being contacted state which neighboring county has such a classification and provide such rate, such rate being deemed to exist by reference in this document. If no neighboring county rate applies to the task, the Department shall undertake a special determination, such special determination being then deemed to have existed under this determination. If a project requires these, or any classification not listed, please contact IDOL at 618/993-7271 for wage rates or clarifications.

LANDSCAPING

Landscaping work falls under the existing classifications for laborer, operating engineer and truck driver. The work performed by landscape plantsman and landscape laborer is covered by the existing classification of laborer. The work performed by landscape operators (regardless of equipment used or its size) is covered by the classifications of operating engineer. The work performed by landscape truck drivers (regardless of size of truck driven) is covered by the classifications of truck driver.