

STATE OF ILLINOIS
DEPARTMENT OF TRANSPORTATION

CONTRACT 98939
U.S. RTE. 60 & U.E. RTE. 62
(138D-BR) P-1
ALEXANDER COUNTY
SHEET 85 OF 85

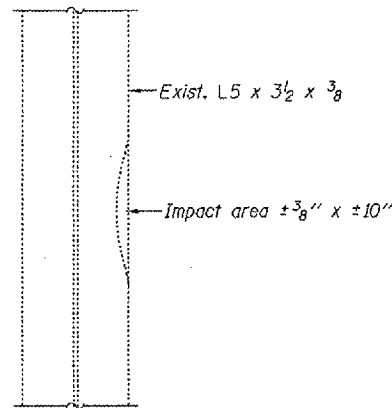

REPAIR 16
L18W-U18W, looking west

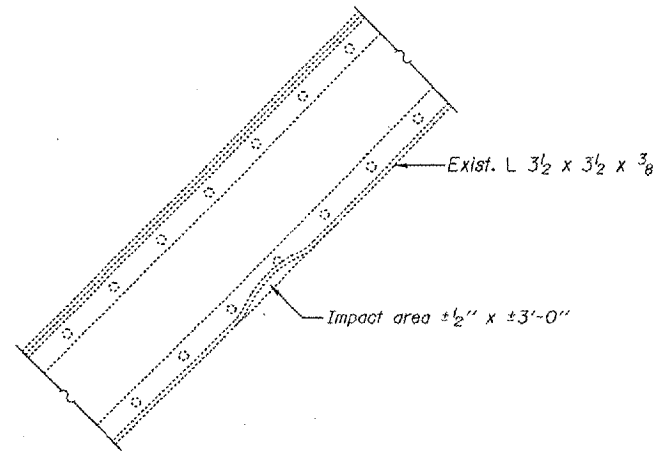

REPAIR 16
L101W-U102W, looking west

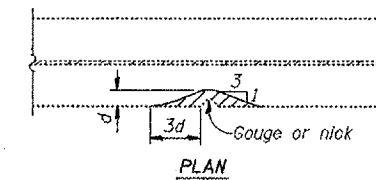
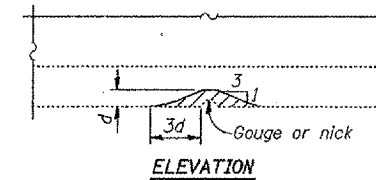

GRINDING DETAIL
REPAIR 15 & 16

Grind existing nicks, gouges and shallow cracks in the damaged areas as detailed. Ground surfaces shall be inspected for cracks using magnetic particle testing prior to initiating any straightening operations. Cost included with Structural Steel Repair. Any cracks that cannot be removed by grinding approximately 1/4" deep shall be identified and reported to the Bureau of Bridges and Structures for further disposition.

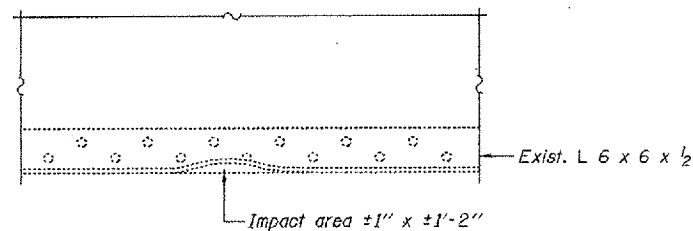

REPAIR 16
FB34, looking north

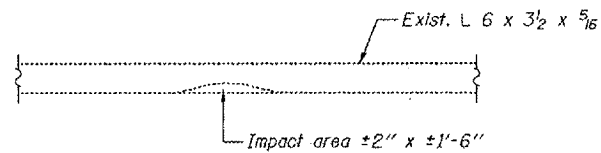

REPAIR 16
Horiz. sway brace @ PP 39, looking north

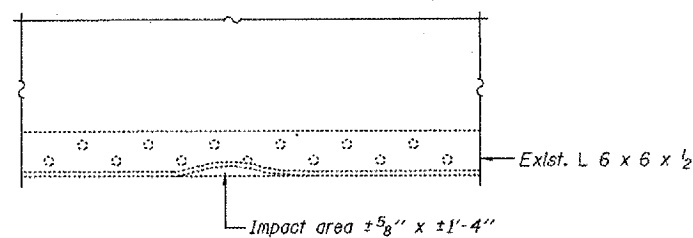

REPAIR 16
FB56, looking north

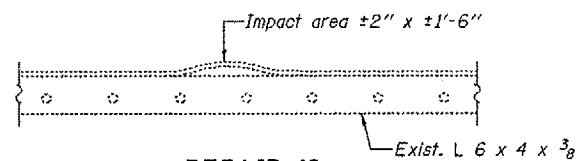

REPAIR 16
Horiz. sway brace between PP 66 & PP 67, looking south

Impacted areas shall be straightened.
See special provision Straighten Bent Members.
Cost included with Straighten Bent Members.
Typical for repair 16.

STRUCTURAL STEEL REPAIR				
Repair #	Member	Location	Description	Action
15	L50W-U50W	8' above deck	Nicks	Grind
15	L59E-U59E	7' above deck	Minor impact damage	Grind
15	L60E-U60E	8' above deck	Gouge	Grind
15	L60E-U61E	10' above deck	Gouge	Grind
15	L80E-U80E	6' above deck	Minor impact damage	Grind
15	L92E-U93E	6' above deck	Gouge	Grind
15	L98E-U99E	10' above deck	Gouge	Grind
15	L100E-U101E	10' above deck	Gouge	Grind
16	FB 34	B'twn. Str. B & C	Bent bottom flange	Straighten & grind
16	L18W-U18W	8' above deck	Damaged angle	Straighten & grind
16	Horiz. sway brace	PP 39	Damaged angle	Straighten & grind
16	FB 56	12' from E. truss	Damaged angle	Straighten & grind
16	Horiz. sway brace	B'twn. PP 66 & 67	Damaged angle	Straighten & grind
16	L102W-U101W	6' above deck	Damaged angle	Straighten & grind

Notes:
Repair 15 paid for as Structural Steel Repair.
Repair 16 paid for as Straighten Bent Members.

DESIGNED	DAB
CHECKED	JSB
DRAWN	baliva
CHECKED	DAB JSB

MARCH 14, 2005
EXAMINED *John A. Morris*
ENGINEER OF STRUCTURAL SERVICES
PASSED *Ralph E. Anderson*
ENGINEER OF BRIDGES AND STRUCTURES

BRIDGE NO. 1
STRUCTURE 002-0005
FOR INFORMATION ONLY

BRIDGE REPAIRS
OLD CAIRO BRIDGE OVER MISSISSIPPI RIVER
FAS RTE. 944 (US 60 & 62)
SEC. (138D-BR)1-5
ALEXANDER COUNTY
SN 002-0005