

CONTRACT NO. 98940
 ROUTE FAI-57
 (02-1B-1) P1
 ALEXANDER COUNTY
 SHEET 15 OF 67

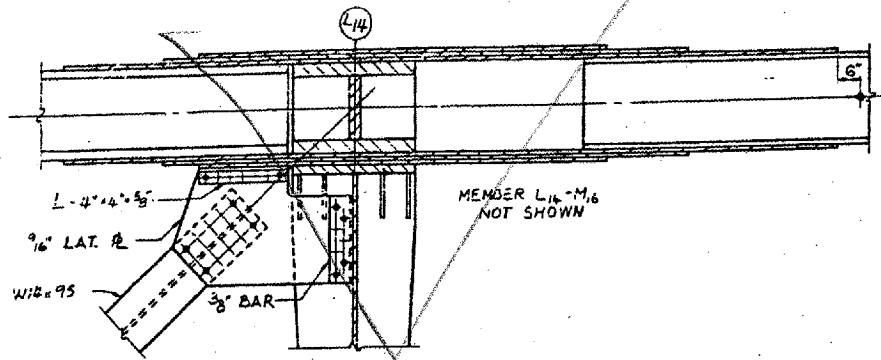

SECTION E14-E14

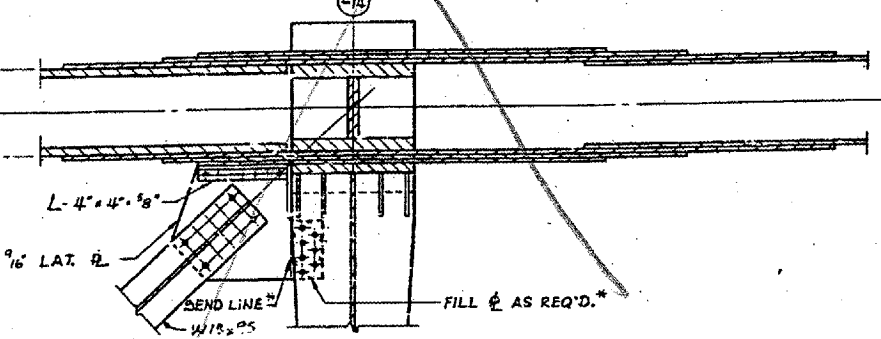

SECTION F14-F14

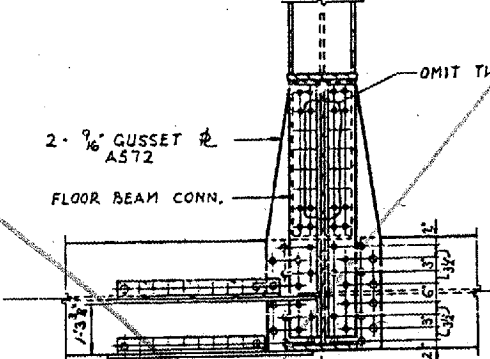

SECTION E15-E15

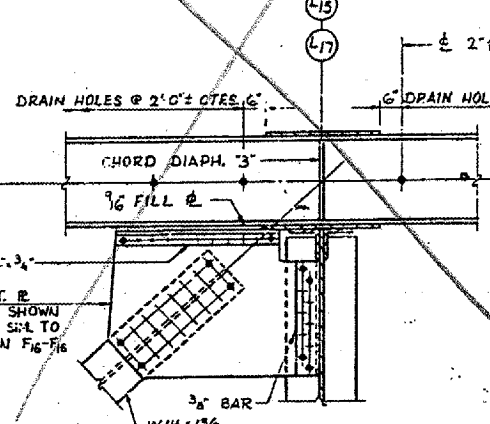

SECTION F15-F15

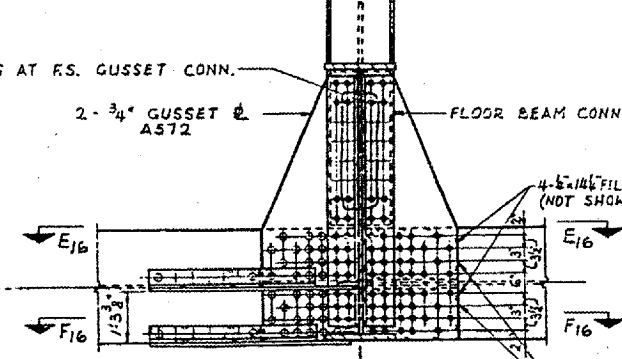

SECTION E16-E16

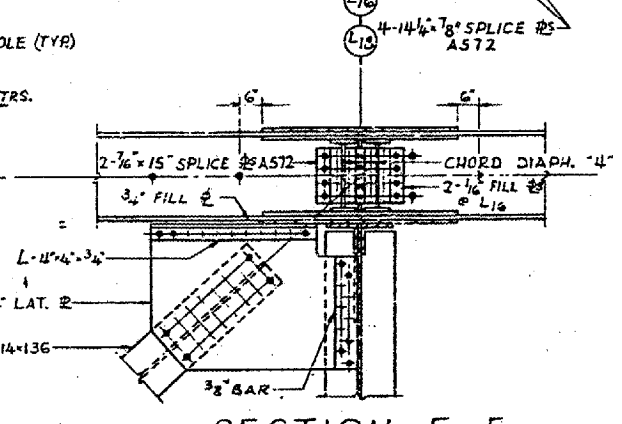

SECTION F16-F16

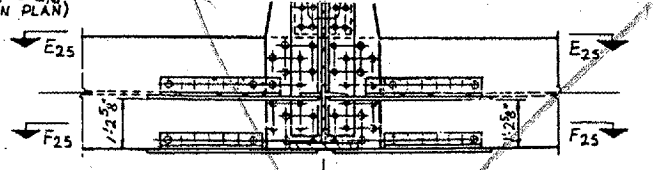

SECTION E25-E25

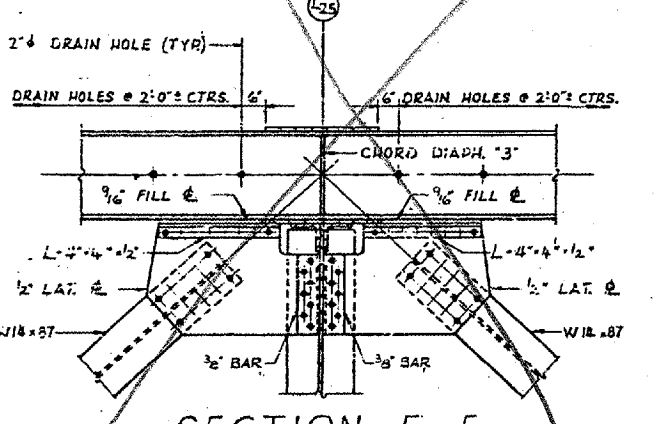

SECTION F25-F25

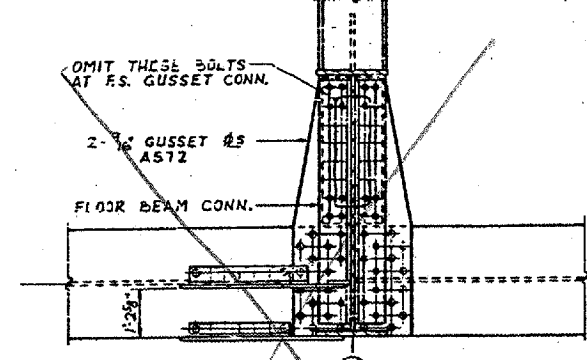

SECTION E19-E19

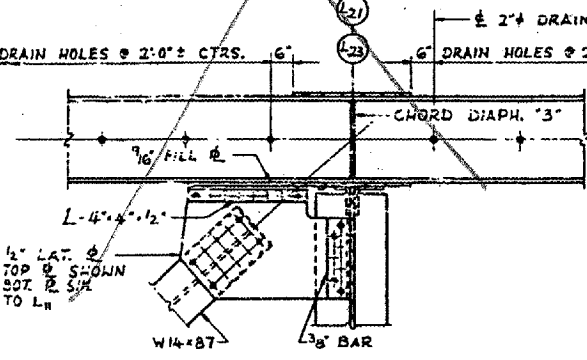

SECTION F19-F19

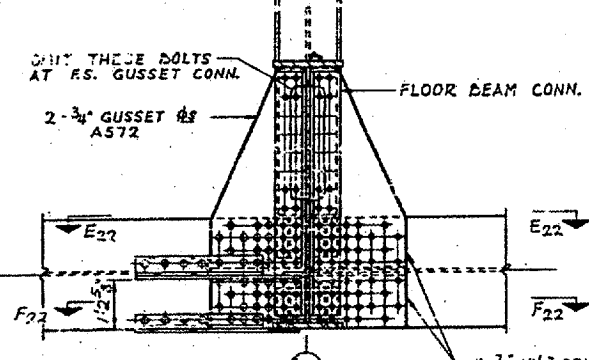

SECTION E20-E20

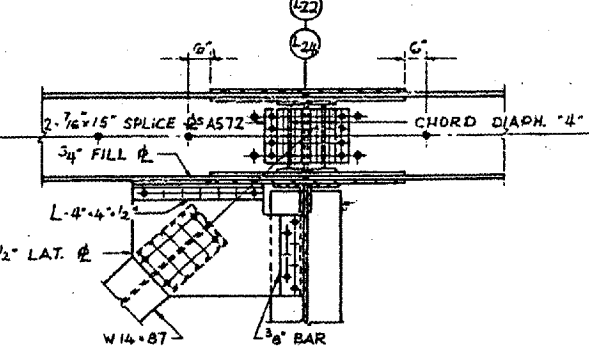

SECTION F20-F20

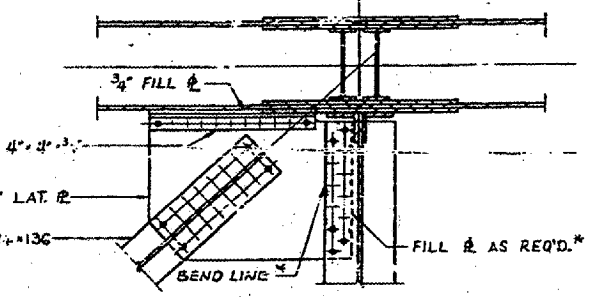

SECTION E22-E22

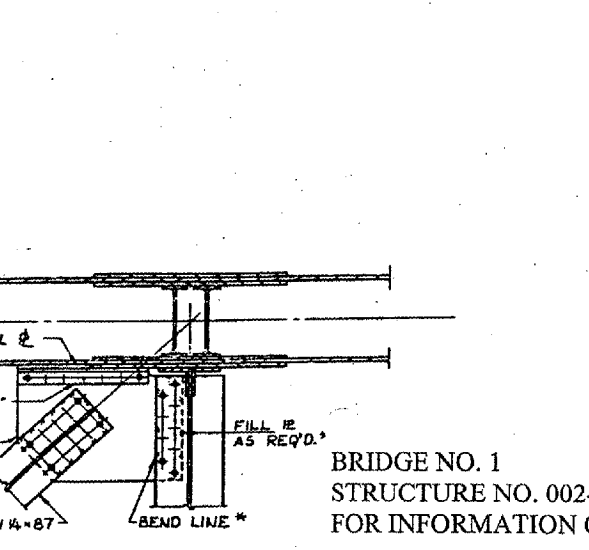

SECTION F22-F22

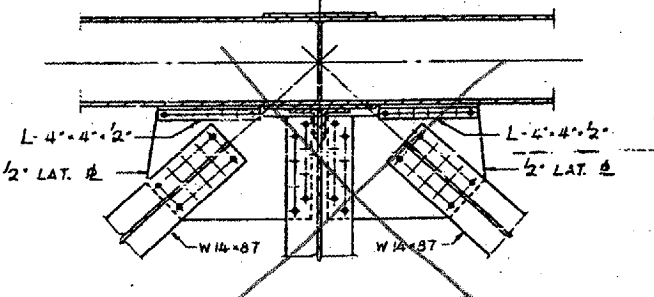

SECTION E25-E25

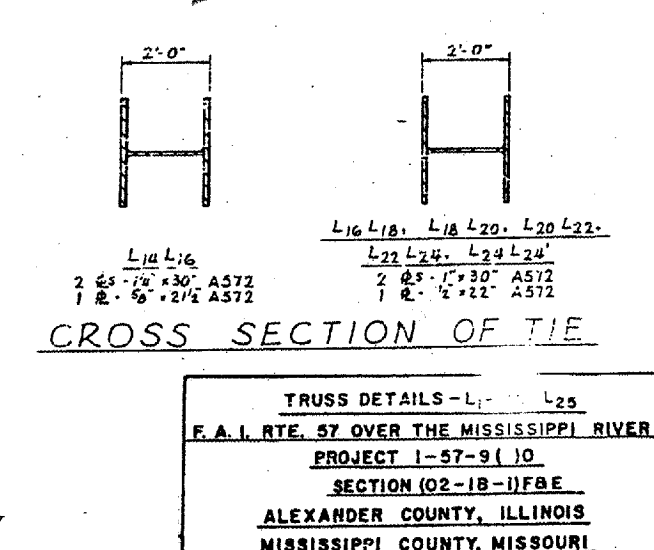

SECTION F25-F25



L16 L18, L18 L20, L20 L22
 L22 L24, L24 L24
 2 #5-1/2x30 A572
 1 #5-21/2 A572
 2 #5-1/2x30 A572
 1 #5-21/2 A572

CROSS SECTION OF TIE

BRIDGE NO. 1
 STRUCTURE NO. 002-0022
 FOR INFORMATION ONLY

TRUSS DETAILS - L1 - L25
 F.A.I. RTE. 57 OVER THE MISSISSIPPI RIVER
 PROJECT 1-57-9(1)0
 SECTION (02-1B-1) F&E
 ALEXANDER COUNTY, ILLINOIS
 MISSISSIPPI COUNTY, MISSOURI
 STA. 1141 + 64.75 TO STA. 1182 + 75.25