

PANEL SIGN DESIGN TYPE 1

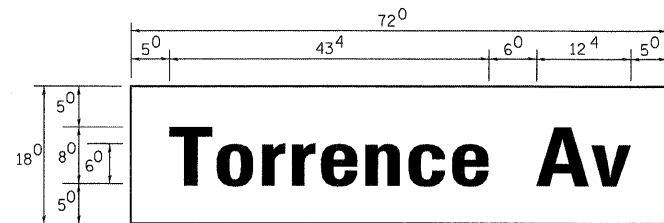

Torrence Av

Sq. M. each
9 Sq. Ft. each
2 Required
Design Series D

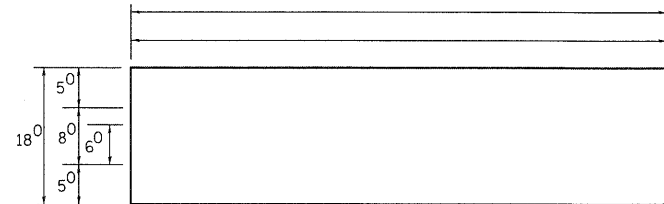

Sq. M. each
Sq. Ft. each
Required
Design Series

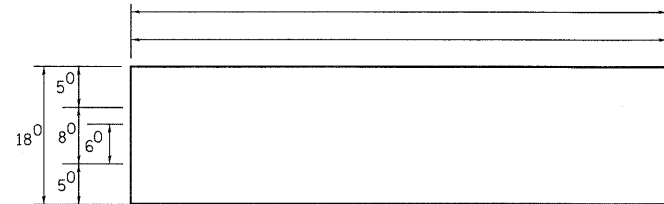

Sq. M. each
Sq. Ft. each
Required
Design Series

NOTE: SIGN DIMENSIONS ARE IN ENGLISH UNITS

PANEL SIGN DESIGN TYPE 2

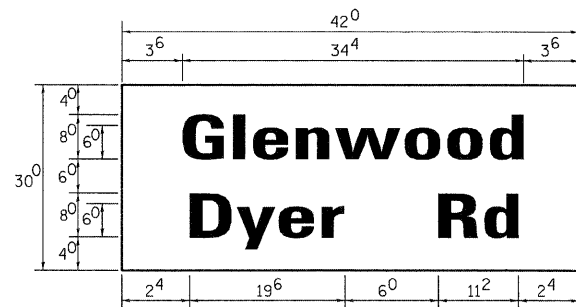

Glenwood Dyer Rd

Sq. M. each
8.75 Sq. Ft. each
2 Required
Design Series D

SUPPORTING CHANNELS

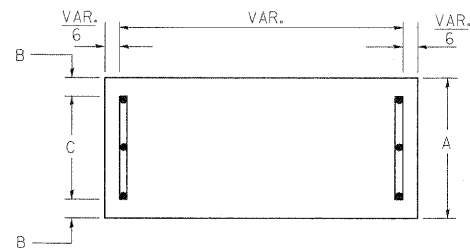

A	B	C
18"	2"	14"

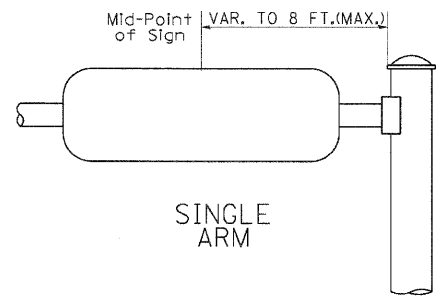

SUPPORTING CHANNELS

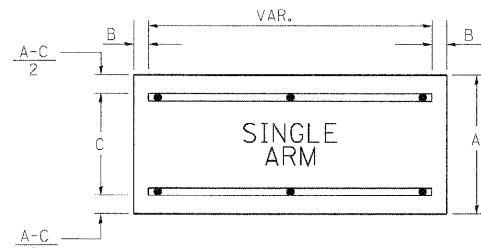

A	B	C
18"	2"	12"
30"	2"	22"

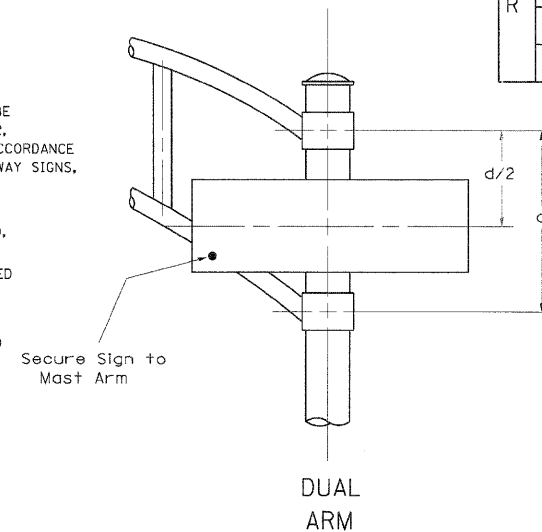

SIGNFIX ALUMINUM CHANNEL FRAMING SYSTEM shall be used. See Note #5.

Upper Case To Lower Case
Spacing Chart 8-6 Inch Series "C & D"

SERIES	SECOND LETTER															
	acde		g h i k l		f w		j		s t		v y		x		z	
	C	D	C	D	C	D	C	D	C	D	C	D	C	D	C	D
A W X	12	14	14	15	12	14	06	10	11	14	06	10	11	12	12	14
B	14	15	20	21	14	15	11	12	14	15	12	14	12	14	16	17
C E G	14	15	20	21	12	14	06	10	12	14	12	14	14	15	14	15
D O Q R	14	15	20	21	14	15	06	10	12	14	12	14	14	15	14	15
F	05	06	14	15	06	10	05	06	06	10	06	10	06	10	11	12
H I M N	20	21	22	24	20	21	14	15	16	17	16	17	20	21	20	21
J U	20	21	20	21	16	17	14	15	16	17	16	17	16	17	20	21
K L	11	12	16	17	11	12	05	06	11	12	11	12	11	12	12	14
P	12	14	14	15	12	14	05	06	11	12	11	12	12	14	12	14
S	12	14	16	17	12	14	06	10	12	14	12	14	12	14	12	14
T	11	12	16	17	06	10	06	10	11	12	11	12	11	12	12	14
V	06	10	14	15	11	12	06	10	12	14	12	14	12	14	12	14
Y	05	06	14	15	06	10	05	06	05	07	05	06	06	10	11	12
Z	16	17	22	24	16	17	12	14	16	17	16	17	16	17	20	21

Lower Case To Lower Case
Spacing Chart 6 Inch Series "C & D"

SERIES	SECOND LETTER															
	acde		g h i k l		f w		j		s t		v y		x		z	
	C	D	C	D	C	D	C	D	C	D	C	D	C	D	C	D
ad h g i j	16	17	22	24	16	17	12	14	14	15	14	15	16	17	16	17
l m n q u																
b f k o p s	12	14	16	17	11	12	05	06	11	12	11	12	12	14	12	14
c e	12	14	16	17	12	14	06	10	12	14	12	14	12	14	12	14
r	06	10	12	14	06	10	03	03	05	06	05	06	06	10	06	10
t z	12	14	16	17	12	14	06	10	11	12	11	12	12	14	12	14
v y	11	12	14	15	11	12	05	06	06	10	06	10	11	12	11	12
w	11	12	14	15	11	12	05	06	11	12	11	12	11	12	12	14
x	12	14	16	17	11	12	05	06	11	12	11	12	11	12	12	14

Number To Number
Spacing Chart 8 Inch Series "C & D"

SERIES	SECOND NUMBER																			
	0		1		2		3		4		5		6		7		8		9	
	C	D	C	D	C	D	C	D	C	D	C	D	C	D	C	D	C	D	C	D
0 9	16	17	16	17	14	15	12	14	14	15	14	15	16	17	12	14	16	17	16	17
1	20	21	20	21	20	21	16	17	14	15	20	21	20	21	14	15	20	21	20	21
2 3 4	14	15	14	15	14	15	12	14	12	14	14	15	14	15	11	12	16	17	14	15
5	14	15	14	15	14	15	11	12	11	12	14	15	14	15	11	12	14	15	14	15
6	16	17	14	15	14	15	12	15	12	14	14	15	14	15	11	12	14	15	14	15
7	12	14	12	14	14	15	12	15	05	06	12	14	14	15	11	12	14	15	12	14
8	16	17	16	17	14	15	12	15	12	14	14	15	16	17	12	14	16	17	14	15

EXAMPLE, 2³ DENOTES $\frac{3}{8}$

UPPER AND LOWER CASE
LETTER WIDTHS

LETTERS	6 INCH UPPER CASE LETTERS				8 INCH UPPER CASE LETTERS				LETTERS	6 INCH LOWER CASE LETTERS	
	SERIES		SERIES		SERIES		SERIES			SERIES	
	C	D	C	D	C	D	C	D		C	D
A	36	50	50	65	a	35	42				
B	32	40	43	53	b	35	42				
C	32	40	43	53	c	35	41				
D	32	40	43	53	d	35	42				
E	30	35	40	47	e	35	42				
F	30	35	40	47	f	23	26				
G	32	40	43	53	g	35	42				
H	32	40	43	53	h	35	42				
I	07	07	11	12	i	11	11				
J	30	36	40	50	j	20	22				
K	32	41	43	54	k	35	42				
L	30	35	40	47	l	11	11				
M	37	45	51	61	m	60	70				
N	32	40	43	53	n	35	42				
O	34	42	45	55	o	36	43				
P	32	40	43	53	p	35	42				
Q	34	42	45	55	q	35	42				
R	32	40	43	53	r	26	32				
S	32	40	43	53	s	36	42				
T	30	35	40	47	t	27	32				
U	32	40	43	53	u	35	42				
V	35	44	47	60	v	42	47				
W	44	52	60	70	w	55	64				
X	34	40	45	53	x	44	51				
Y	36	50	50	66	y	46	53				
Z	32	40	43	53	z	36	43				

NUMBER	6 INCH SERIES		8 INCH SERIES	
	C	D	C	D
1	12	14	15	20
2	32	40	43	53
3	32	40	43	53
4	35	43	47	57
5	32	40	43	53
6	32	40	43	53
7	32	40	43	53
8	32	40	43	53
9	32	40	43	53
0	34	42	45	55

GENERAL NOTES

1. WHERE MAST ARM MOUNTED STREET NAME SIGNS ARE SPECIFIED, THE MAST ARM ASSEMBLY AND POLES SHALL BE DESIGNED TO SUPPORT THE LOADINGS CALLED FOR ON STANDARDS 877001, 877002, 877006, 877011 AND 877012, AS APPLICABLE, PLUS TWO (2) SIGN PANELS 2'-6" x 8'-0" MOUNTED AS SHOWN. THE DESIGN SHALL BE IN ACCORDANCE WITH THE REQUIREMENTS OF THE CURRENT "STANDARD SPECIFICATIONS FOR STRUCTURAL SUPPORTS FOR HIGHWAY SIGNS, LUMINAIRES, AND TRAFFIC SIGNALS" AS PUBLISHED BY THE AMERICAN ASSOCIATION OF STATE HIGHWAY AND TRANSPORTATION OFFICIALS FOR 80 M.P.H. WIND VELOCITY.

2. ALL SIGNS SHALL HAVE A WHITE REFLECTORIZED LEGEND AND BORDER ON A GREEN REFLECTORIZED BACKGROUND, TYPE A SHEETING.

3. THE SIGN LENGTH SHOULD BE INCREASED IN 6-INCH INCREMENTS, BUT THE OVERALL LENGTH SHOULD NOT EXCEED 8'-0".

4. ALL BORDERS SHALL BE 3/4" WIDE AND CORNER RADIUS SHALL BE 2-1/4".

5. SIGNFIX ALUMINUM CHANNEL FRAMING SYSTEM SHALL BE USED FOR ALL SIGNS ATTACHED TO SIGNAL POLES AND POSTS. LOCAL SUPPLIERS OF THE SIGNFIX ALUMINUM CHANNEL FRAMING SYSTEM ARE:

* J.O. HERBERT CO. MIDLOTHIAN, VA. * WESTERN REMAC INC. WOODRIDGE, IL.

PARTS LISTING:
SIGN CHANNEL PART #HPN053 (MED. CHANNEL)
SIGN SCREWS 1/4" x 14 x 1" H.W.H. #3
SELF TAPPING WITH NEOPRENE WASHER
BRACKETS PART #HPN034 (UNIVERSAL)

CHANNEL CLAMPS WITH STAINLESS STEEL STRAPPING
OTHER BRANDS OF MOUNTING HARDWARE ARE ACCEPTABLE, BASED UPON THE DEPARTMENT'S APPROVAL AND COMPATIBILITY WITH THE CHANNEL/BACKET OF THE ABOVE PRODUCT.

FILE NAME =	USER NAME = kanthaphixaybc	DESIGNED - DAG./BCK.	REVISED - DAG-10/28/09
ca:\pwwork\pwwid\KANTHAPHIXAYBC\d01126	4\tr\fig.legend.v7.dgn	DRAWN - BCK.	REVISED -
	PLOT SCALE = 20.0000' / IN.	CHECKED - DAG/DAD	REVISED -
	PLOT DATE = 10/16/2009	DATE - 03/15/09	REVISED -

STATE OF ILLINOIS
DEPARTMENT OF TRANSPORTATION

DISTRICT 1
MAST ARM MOUNTED STREET NAME SIGNS

SCALE: SHEET NO. OF SHEETS STA. TO STA.

F.A.U. RTE. 2937	SECTION 2011-040-TS	COUNTY COOK	TOTAL SHEETS 14	SHEET NO. 14
CONTRACT NO. 60P46			ILLINOIS FED. AID PROJECT	