

F.A.P. RTE.	SECTION	COUNTY	TOTAL SHEETS	SHEET NO.
365	(58859) WRS-3	DuPAGE	466	314
STA. TO STA.				
FED. ROAD DIST. NO.	ILLINOIS	FED. AID PROJECT		

PANEL DESIGN TYPE 1

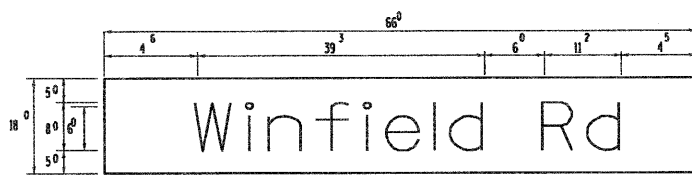

Sq. M. each
 8.25 Sq. Ft. each
 2 Required
 Design Series D

PANEL DESIGN TYPE 1

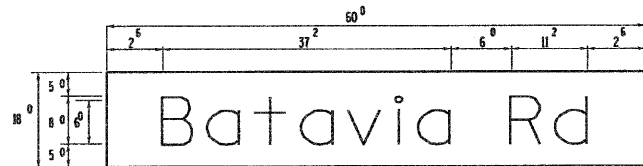

Sq. M. each
 7.5 Sq. Ft. each
 2 Required
 Design Series D

PANEL DESIGN TYPE 1

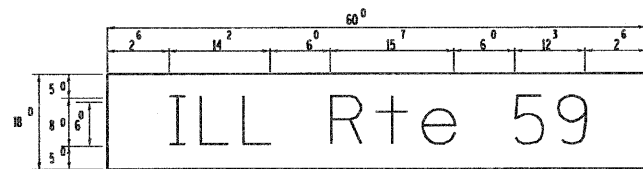

Sq. M. each
 7.5 Sq. Ft. each
 2 Required
 Design Series D

PANEL DESIGN TYPE 2

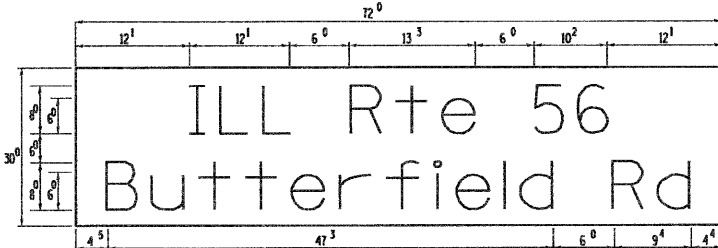

Sq. M. each
 15 Sq. Ft. each
 6 Required
 Design Series C

SUPPORTING CHANNELS

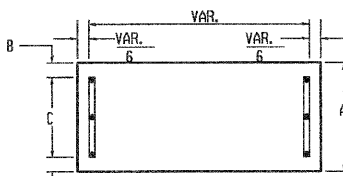

A	B	C
18"	2"	14"

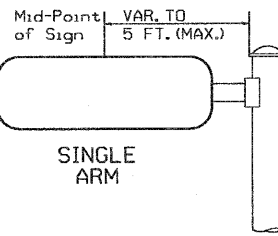

SINGLE ARM

SUPPORTING CHANNELS

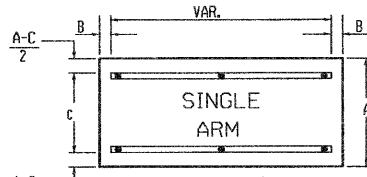

A	B	C
18"	2"	22"

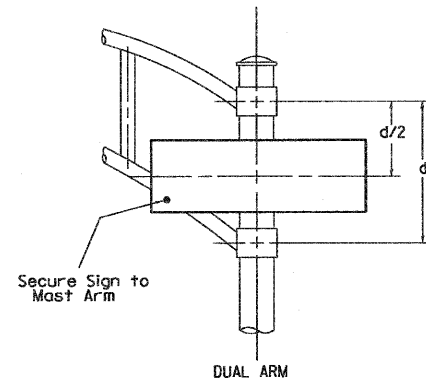

SIGNFIX ALUMINUM CHANNEL FRAMING SYSTEM
 Shall be used. See Note #5.

Upper Case To Lower Case
 Spacing Chart 8-6 Inch Series "C & D"

FIRST LETTER	SECOND LETTER																													
	ac d e				bh i k l				f w j				s t v y				x z													
	c	D	C	D	C	D	C	D	C	D	C	D	C	D	C	D	C	D	C	D										
A W X	12	14	14	15	12	14	10	10	11	14	10	10	11	12	12	14														
B	14	15	2 0	2 1	14	15	11	12	14	15	12	14	12	14	12	14	16	17												
C E G	14	15	2 0	2 1	12	14	10	10	12	14	12	14	14	15	14	15														
D O Q R	14	15	2 0	2 1	14	15	10	10	12	14	12	14	14	15	14	15														
F	05	06	14	15	06	10	05	06	10	06	10	06	10	11	12															
H I M N	20	21	2 2	2 4	20	2 1	14	15	16	17	16	17	16	17	20	2 1														
J U	20	21	2 0	2 1	16	17	14	15	16	17	16	17	16	17	20	2 1														
K L	11	12	16	17	11	12	10	10	11	12	11	12	11	12	12	14														
P	12	14	14	15	12	14	10	10	12	14	12	14	12	14	12	14														
S	12	14	16	17	12	14	10	10	12	14	12	14	12	14	12	14														
T	11	12	16	17	10	10	10	10	11	12	11	12	11	12	12	14														
v y	06	10	14	15	11	12	06	10	12	14	12	14	12	14	12	14														
Y	05	06	14	15	06	10	05	06	10	05	06	10	05	06	10	11	12													
Z	16	17	2 2	2 4	16	17	12	14	16	17	16	17	16	17	20	2 1														

Lower Case To Lower Case
 Spacing Chart 6 Inch Series "C & D"

FIRST LETTER	SECOND LETTER																													
	ac d e				bh i k l				f w j				s t v y				x z													
	c	D	C	D	C	D	C	D	C	D	C	D	C	D	C	D	C	D	C	D										
a d h g i j	16	17	2 2	2 4	16	17	12	14	11	15	14	15	16	17	16	17														
l m n q u	16	17	2 2	2 4	16	17	12	14	11	15	14	15	16	17	16	17														
b f k o p s	12	14	16	17	11	12	05	06	11	12	11	12	12	14	12	14														
c e	12	14	16	17	12	14	06	10	12	14	12	14	12	14	12	14														
r	06	10	12	14	06	10	03	03	05	06	05	06	06	10	06	10														
t z	12	14	16	17	12	14	06	10	11	12	11	12	12	14	12	14														
v y	11	12	14	15	11	12	05	06	10	06	10	11	12	12	14	12														
w	11	12	14	15	11	12	05	06	11	12	11	12	11	12	12	14														
x	12	14	16	17	11	12	05	06	11	12	11	12	11	12	12	14														

Number To Number
 Spacing Chart 8 Inch Series "C & D"

FIRST NUMBER	SECOND NUMBER																			
	0		1		2		3		4		5		6		7		8		9	
	C	D	C	D	C	D	C	D	C	D	C	D	C	D	C	D	C	D	C	D
0 9	16	17	16	17	14	15	12	14	14	15	14	15	16	17	12	14	16	17	16	17
1	20	21	20	21	20	21	16	17	14	15	20	21	20	21	14	15	20	21	20	21
2 3 4	14	15	14	15	14	15	12	14	12	14	14	15	14	15	11	12	16	17	14	15
5	4	5	4	5	4	5	1	2	1	2	4	5	4	5	1	2	4	5	4	5
6	16	17	14	15	14	15	12	14	14	15	14	15	14	15	11	12	14	15	14	15
7	12	14	16	17	14	15	12	14	05	06	12	14	14	15	11	12	14	15	12	14
8	16	17	16	17	14	15	12	14	14	15	16	17	12	14	16	17	14	15	14	15

UPPER AND LOWER CASE
 LETTER WIDTHS

LETTERS	6 INCH UPPER CASE LETTERS		8 INCH UPPER CASE LETTERS		LETTERS	6 INCH LOWER CASE LETTERS	
	C	D	C	D		C	D
A	36	50	50	65	a	35	42
B	32	40	43	53	b	35	42
C	32	40	43	53	c	35	41
D	32	40	43	53	d	35	42
E	30	35	40	47	e	35	42
F	30	35	40	47	f	23	26
G	32	40	43	53	g	35	42
H	32	40	43	53	h	35	42
I	07	07	11	12	i	11	11
J	30	36	40	50	j	20	22
K	32	41	43	54	k	35	42
L	30	35	40	47	l	11	11
M	37	45	51	61	m	60	70
N	32	40	43	53	n	35	42
O	34	42	45	55	o	36	43
P	32	40	43	53	p	35	42
Q	34	42	45	55	q	35	42
R	32	40	43	53	r	26	32
S	32	40	43	53	s	36	42
T	30	35	40	47	t	27	32
U	32	40	43	53	u	35	42
V	35	44	47	60	v	42	47
W	44	52	60	70	w	55	64
X	34	40	45	53	x	44	51
Y	36	50	50	66	y	46	53
Z	32	40	43	53	z	36	43

NUMBER	6 INCH SERIES		8 INCH SERIES	
	C	D	C	D
1	12	14	15	20
2	32	40	43	53
3	32	40	43	53
4	35	43	47	57
5	32	40	43	53
6	32	40	43	53
7	32	40	43	53
8	32	40	43	53
9	32	40	43	53
0	34	42	45	55

EXAMPLE, 2 (3) DENOTES 3"

GENERAL NOTES

- WHERE MAST ARM MOUNTED STREET NAME SIGNS ARE SPECIFIED, THE MAST ARM ASSEMBLY AND POLES SHALL BE DESIGNED TO SUPPORT THE LOADINGS CALLED FOR ON STANDARDS 87700, 87706 AND 87701, AS APPLICABLE, PLUS TWO (2) SIGN PANELS 2'-6" x 6'-0" MOUNTED AS SHOWN. THE DESIGN SHALL BE IN ACCORDANCE WITH THE REQUIREMENTS OF THE CURRENT "STANDARD SPECIFICATIONS FOR STRUCTURAL SUPPORTS FOR HIGHWAY SIGNS, LUMINAIRES, AND TRAFFIC SIGNALS" AS PUBLISHED BY THE AMERICAN ASSOCIATION OF STATE HIGHWAY AND TRANSPORTATION OFFICIALS FOR 80 M.P.H. WIND VELOCITY.
- ALL SIGNS SHALL HAVE A WHITE REFLECTORIZED LEGEND AND BORDER ON A GREEN REFLECTORIZED BACKGROUND, TYPE A SHEETING.
- THE SIGN LENGTH SHOULD BE INCREASED IN 6-INCH INCREMENTS, BUT THE OVERALL LENGTH SHOULD NOT EXCEED 6'-0".
- ALL BORDERS SHALL BE 3/4" WIDE AND CORNER RADIUS SHALL BE 2-1/4".
- SIGNFIX ALUMINUM CHANNEL FRAMING SYSTEM SHALL BE USED FOR ALL SIGNS ATTACHED TO SIGNAL POLES AND POSTS. LOCAL SUPPLIERS OF THE SIGNFIX ALUMINUM CHANNEL FRAMING SYSTEM ARE:
 - A.K.T. CORPORATION, SCHAUMBURG, IL
 - AMERICAN FABRICATION CO., CHICAGO HEIGHTS, IL
 - TUCKER COMPANY, INC., WAUWATOSA, WI
 - WESTERN TRAFFIC CONTROL INC., CICERO, IL

PARTS LISTING:

SIGN CHANNEL PART #HPN053 (MED. CHANNEL)
 SIGN SCREWS 1/4" x 14 x 1" H.W.H. #3
 SELF TAPPING WITH NEOPRENE WASHER
 BRACKETS PART #HPN034 (UNIVERSAL)
 CHANNEL CLAMPS WITH STAINLESS STEEL STRAPPING
 OTHER BRANDS OF MOUNTING HARDWARE ARE ACCEPTABLE, BASED UPON THE DEPARTMENT'S APPROVAL AND COMPATIBILITY WITH THE CHANNEL/BACKET OF THE ABOVE PRODUCT.

REVISIONS	
NAME	DATE

ILLINOIS DEPARTMENT OF TRANSPORTATION DISTRICT 1

MAST ARM MOUNTED STREET NAME SIGNS

SCALE: NONE
 DATE:

DRAWN BY: RAS
 DESIGN BY: RAS
 CHECKED BY: ADO