

BID PROPOSAL INSTRUCTIONS

ABOUT IDOT PROPOSALS: All proposals are potential bidding proposals. Each proposal contains all certifications and affidavits, a proposal signature sheet and a proposal bid bond.

PREQUALIFICATION

Any contractor who desires to become pre-qualified to bid on work advertised by IDOT must submit the properly completed pre-qualification forms to the Bureau of Construction no later than 4:30 p.m. prevailing time twenty-one days prior to the letting of interest. This pre-qualification requirement applies to first time contractors, contractors renewing expired ratings, contractors maintaining continuous pre-qualification or contractors requesting revised ratings. To be eligible to bid, existing pre-qualification ratings must be effective through the date of letting.

WHO CAN BID ?

Bids will be accepted from only those companies that request and receive written Authorization to Bid from IDOT's Central Bureau of Construction.

REQUESTS FOR AUTHORIZATION TO BID

Contractors wanting to bid on items included in a particular letting must submit the properly completed "Request for Authorization to Bid/or Not For Bid Status" (BDE 124) and the ORIGINAL "Affidavit of Availability" (BC 57) to the proper office no later than 4:30 p.m. prevailing time, three (3) days prior to the letting date.

WHAT CONSTITUTES WRITTEN AUTHORIZATION TO BID?

When a prospective prime bidder submits a "Request for Authorization to Bid/or Not For Bid Status"(BDE 124) he/she must indicate at that time which items are being requested For Bidding purposes. Only those items requested For Bidding will be analyzed. After the request has been analyzed, the bidder will be issued an **Authorization to Bid or Not for Bid Report**, approved by the Central Bureau of Construction and the Chief Procurement Officer that indicates which items have been approved For Bidding. If **Authorization to Bid** cannot be approved, the **Authorization to Bid or Not for Bid Report** will indicate the reason for denial.

ABOUT AUTHORIZATION TO BID

Firms that have not received an Authorization to Bid or Not For Bid Report within a reasonable time of complete and correct original document submittal should contact the Department as to the status. Firms unsure as to authorization status should call the Prequalification Section of the Bureau of Construction at the number listed at the end of these instructions.

ADDENDA AND REVISIONS

It is the bidder's responsibility to determine which, if any, addenda or revisions pertain to any project they may be bidding. Failure to incorporate all relevant addenda or revisions may cause the bid to be declared unacceptable.

Each addendum or revision will be included with the Electronic Plans and Proposals. Addenda and revisions will also be placed on the Addendum/Revision Checklist and each subscription service subscriber will be notified by e-mail of each addendum and revision issued.

The Internet is the Department's primary way of doing business. The subscription service emails are an added courtesy the Department provides. It is suggested that bidders check IDOT's website at <http://www.idot.illinois.gov/doing-business/procurements/construction-services/construction-bulletins/transportation-bulletin/index#TransportationBulletin> before submitting final bid information.

IDOT IS NOT RESPONSIBLE FOR ANY E-MAIL FAILURES.

Addenda questions may be directed to the Contracts Office at (217)782-7806 or DOT.D&Econtracts@illinois.gov

Technical questions about downloading these files may be directed to Tim Garman at (217)524-1642 or Timothy.Garman@illinois.gov.

STANDARD GUIDELINES FOR SUBMITTING BIDS

- All pages should be single sided.
- Use the Cover Page that is provided in the Bid Proposal (posted on the IDOT Web Site) as the first page of your submitted bid. It has the item number in large bold type in the upper left-hand corner and lines provided for your company name and address in the upper right-hand corner.
- Do not use report covers, presentation folders or special bindings and do not staple multiple times on left side like a book. Use only 1 staple in the upper left hand corner. Make sure all elements of your bid are stapled together including the bid bond or guaranty check (if required).
- **Do not include any certificates of eligibility, your authorization to bid, Addendum Letters or affidavit of availability.**
- Do not include the Subcontractor Documentation with your bid (pages i – iii and pages a – g). This documentation is required only if you are awarded the project.
- Use the envelope cover sheet (provided with the proposal) as the cover for the proposal envelope.
- Do not rely on overnight services to deliver your proposal prior to 10 AM on letting day. It will not be read if it is delivered after 10 AM.
- Do not submit your Substance Abuse Prevention Program (SAPP) with your bid. If you are awarded the contract this form is to be submitted to the district engineer at the pre-construction conference.

BID SUBMITTAL CHECKLIST

- Cover page** (the sheet that has the item number on it) – This should be the first page of your bid proposal, **followed by your bid (the Schedule of Prices/Pay Items)**. If you are using special software or CBID to generate your schedule of prices, do not include the blank pages of the schedule of prices that came with the proposal package.
- Page 4 (Item 9)** – Check “YES” if you will use a subcontractor(s) with an annual value over \$50,000. Include the subcontractor(s) name, address, general type of work to be performed and the dollar amount. If you will use subcontractor(s) but are uncertain who or the dollar amount; check “YES” but leave the lines blank.
- After page 4** – Insert the following documents: Cost Adjustments for Steel, Bituminous and Fuel (if applicable) and the Contractor Letter of Assent (if applicable). The general rule should be, if you don’t know where it goes, put it after page 4.
- Page 10 (Paragraph J)** – Check “YES” or “NO” whether your company has any business in Iran.
- Page 10 (Paragraph K)** – (Not applicable to federally funded projects) List the name of the apprenticeship and training program sponsor holding the certificate of registration from the US Department of Labor. If no applicable program exists, please indicate the work/job category. Do not include certificates with your bid. Keep the certificates in your office in case they are requested by IDOT.
- Page 11 (Paragraph L)** – A copy of your State Board of Elections certificate of registration is no longer required with your bid.
- Page 11 (Paragraph M)** – Indicate if your company has hired a lobbyist in connection with the job for which you are submitting the bid proposal.
- Page 12 (Paragraph C)** – This is a work sheet to determine if a completed Form A is required. It is not part of the form and you do not need to make copies for each completed Form A.
- Pages 14-17 (Form A)** – One Form A (4 pages) is required for each applicable person in your company. Copies of the forms can be used and only need to be changed when the information changes. The certification signature and date must be original for each letting. **Do not staple the forms together.** If you answered “NO” to all of the questions in Paragraph C (page 12), complete the first section (page 14) with your company information and then sign and date the Not Applicable statement on page 17.
- Page 18 (Form B)** - If you check “YES” to having other current or pending contracts it is acceptable to use the phrase, “See Affidavit of Availability on file”. **Ownership Certification** (at the bottom of the page) - Check N/A if the Form A(s) you submitted accounts for 100 percent of the company ownership. Check YES if any percentage of ownership falls outside of the parameters that require reporting on the Form A. Checking NO indicates that the Form A(s) you submitted is not correct and you will be required to submit a revised Form A.
- Page 20 (Workforce Projection)** – Be sure to include the Duration of the Project. It is acceptable to use the phrase “Per Contract Specifications”.

Proposal Bid Bond – (Insert after the proposal signature page) Submit your proposal Proposal Bid Bond (if applicable) using the current Proposal Bid Bond form provided in the proposal package. The Power of Attorney page should be stapled to the Proposal Bid Bond. If you are using an electronic bond, include your bid bond number on the Proposal Bid Bond and attach the Proof of Insurance printed from the Surety’s Web Site.

Disadvantaged Business Utilization Plan and/or Good Faith Effort – The last items in your bid should be the DBE Utilization Plan (SBE 2026), followed by the DBE Participation Statement (SBE 2025) and supporting paperwork. If you have documentation of a Good Faith Effort, it is to follow the SBE Forms.

The Bid Letting is now available in streaming Audio/Video from the IDOT Web Site. A link to the stream will be placed on the main page of the current letting on the day of the Letting. The stream will not begin until 10 AM. The actual reading of the bids does not begin until approximately 10:30 AM.

Following the Letting, the As-Read Tabulation of Bids will be posted by the end of the day. You will find the link on the main Web page for the current letting.

QUESTIONS: pre-letting up to execution of the contract

Contractor pre-qualification	217-782-3413
Small Business, Disadvantaged Business Enterprise (DBE)	217-785-4611
Contracts, Bids, Letting process or Internet downloads	217-782-7806
Estimates Unit.....	217-785-3483
Aeronautics.....	217-785-8515
IDNR (Land Reclamation, Water Resources, Natural Resources).....	217-782-6302

QUESTIONS: following contract execution

Subcontractor documentation, payments	217-782-3413
Railroad Insurance	217-785-0275

25

RETURN WITH BID

Proposal Submitted By
Name
Address
City

Letting March 4, 2016

NOTICE TO PROSPECTIVE BIDDERS

This proposal can be used for bidding purposes by only those companies that request and receive written AUTHORIZATION TO BID from IDOT's Central Bureau of Construction.

BIDDERS NEED NOT RETURN THE ENTIRE PROPOSAL

Notice to Bidders, Specifications, Proposal, Contract and Contract Bond



**Illinois Department
of Transportation**

Springfield, Illinois 62764

**Contract No. 64L02
WHITESIDE-HENRY Counties
Section D2 DRAINAGE 2016-1
Routes FAI 74/280 & FAI 88
District 2 Construction Funds**

PLEASE MARK THE APPROPRIATE BOX BELOW:

- A Bid Bond is included.
- A Cashier's Check or a Certified Check is included.
- An Annual Bid Bond is included or is on file with IDOT.

Plans Included
Herein

Prepared by

S

Checked by

(Printed by authority of the State of Illinois)

Page intentionally left blank

RETURN WITH BID



PROPOSAL

TO THE DEPARTMENT OF TRANSPORTATION

1. Proposal of _____

Taxpayer Identification Number (Mandatory) _____

For the improvement identified and advertised for bids in the Invitation for Bids as:

**Contract No. 64L02
WHITESIDE-HENRY Counties
Section D2 DRAINAGE 2016-1
Routes FAI 74/280 & FAI 88
District 2 Construction Funds**

This project consists of culvert repairs on I-74/280 located approximately 1.2 miles west of the I-80 interchange and on I-88 approximately 1.7 miles west of IL 78.

2. The undersigned bidder will furnish all labor, material and equipment to complete the above described project in a good and workmanlike manner as provided in the contract documents provided by the Department of Transportation. This proposal will become part of the contract and the terms and conditions contained in the contract documents will govern performance and payments.

RETURN WITH BID

3. **ASSURANCE OF EXAMINATION AND INSPECTION/WAIVER.** The undersigned bidder further declares that he/she has carefully examined the proposal, plans, specifications, addenda, form of contract and contract bond, and special provisions, and that he/she has inspected in detail the site of the proposed work, and that he/she has familiarized themselves with all of the local conditions affecting the contract and the detailed requirements of construction, and understands that in making this bid proposal he/she waives all right to plead any misunderstanding regarding the same.
4. **EXECUTION OF CONTRACT AND CONTRACT BOND.** The undersigned bidder further agrees to execute a contract for this work and present the same to the department within fifteen (15) days after the contract has been mailed to him/her. The undersigned further agrees that he/she and his/her surety will execute and present within fifteen (15) days after the contract has been mailed to him/her contract bond satisfactory to and in the form prescribed by the Department of Transportation, in the penal sum of the full amount of the contract, or as specified in the special provisions, guaranteeing the faithful performance of the work in accordance with the terms of the contract.
5. **PROPOSAL GUARANTY.** Accompanying this proposal is either a bid bond on the department form, executed by a corporate surety company satisfactory to the department, or a proposal guaranty check consisting of a bank cashier's check or a properly certified check for not less than 5 per cent of the amount bid or for the amount specified in the following schedule:

<u>Amount of Bid</u>	<u>Proposal Guaranty</u>	<u>Amount of Bid</u>	<u>Proposal Guaranty</u>
Up to \$5,000	to \$150	\$2,000,000	to \$100,000
\$5,000 to \$10,000	to \$300	\$3,000,000	to \$150,000
\$10,000 to \$50,000	to \$1,000	\$5,000,000	to \$250,000
\$50,000 to \$100,000	to \$3,000	\$7,500,000	to \$400,000
\$100,000 to \$150,000	to \$5,000	\$10,000,000	to \$500,000
\$150,000 to \$250,000	to \$7,500	\$15,000,000	to \$600,000
\$250,000 to \$500,000	to \$12,500	\$20,000,000	to \$700,000
\$500,000 to \$1,000,000	to \$25,000	\$25,000,000	to \$800,000
\$1,000,000 to \$1,500,000	to \$50,000	\$30,000,000	to \$900,000
\$1,500,000 to \$2,000,000	to \$75,000	over \$35,000,000	to \$1,000,000

Bank cashier's checks or properly certified checks accompanying bid proposals will be made payable to the Treasurer, State of Illinois.

If a combination bid is submitted, the proposal guaranties which accompany the individual bid proposals making up the combination will be considered as also covering the combination bid.

The amount of the proposal guaranty check is _____ \$(_____). If this proposal is accepted and the undersigned will fail to execute a contract bond as required herein, it is hereby agreed that the amount of the proposal guaranty will become the property of the State of Illinois, and shall be considered as payment of damages due to delay and other causes suffered by the State because of the failure to execute said contract and contract bond; otherwise, the bid bond will become void or the proposal guaranty check will be returned to the undersigned.

Attach Cashier's Check or Certified Check Here

In the event that one proposal guaranty check is intended to cover two or more bid proposals, the amount must be equal to the sum of the proposal guaranties which would be required for each individual proposal. If the guaranty check is placed in another bid proposal, state below where it may be found.

The proposal guaranty check will be found in the bid proposal for: Item _____

Section No. _____

County _____

Mark the proposal cover sheet as to the type of proposal guaranty submitted.

RETURN WITH BID

6. **COMBINATION BIDS.** The undersigned bidder further agrees that if awarded the contract for the sections contained in the following combination, he/she will perform the work in accordance with the requirements of each individual contract comprising the combination bid specified in the schedule below, and that the combination bid shall be prorated against each section in proportion to the bid submitted for the same. If an error is found to exist in the gross sum bid for one or more of the individual sections included in a combination, the combination bid shall be corrected as provided in the specifications.

When a combination bid is submitted, the schedule below must be completed in each proposal comprising the combination.

If alternate bids are submitted for one or more of the sections comprising the combination, a combination bid must be submitted for each alternate.

Schedule of Combination Bids

Combination No.	Sections Included in Combination	Combination Bid	
		Dollars	Cents

7. **SCHEDULE OF PRICES.** The undersigned bidder submits herewith, in accordance with the rules and instructions, a schedule of prices for the items of work for which bids are sought. The unit prices bid are in U.S. dollars and cents, and all extensions and summations have been made. The bidder understands that the quantities appearing in the bid schedule are approximate and are provided for the purpose of obtaining a gross sum for the comparison of bids. If there is an error in the extension of the unit prices, the unit prices will govern. Payment to the contractor awarded the contract will be made only for actual quantities of work performed and accepted or materials furnished according to the contract. The scheduled quantities of work to be done and materials to be furnished may be increased, decreased or omitted as provided elsewhere in the contract.
8. **AUTHORITY TO DO BUSINESS IN ILLINOIS.** Section 20-43 of the Illinois Procurement Code (the Code) (30 ILCS 500/20-43) provides that a person (other than an individual acting as a sole proprietor) must be a legal entity authorized to transact business or conduct affairs in the State of Illinois prior to submitting the bid.
9. **EXECUTION OF CONTRACT:** The Department of Transportation will, in accordance with the rules governing Department procurements, execute the contract and shall be the sole entity having the authority to accept performance and make payments under the contract. Execution of the contract by the Chief Procurement Officer (CPO) or the State Purchasing Officer (SPO) is for approval of the procurement process and execution of the contract by the Department. Neither the CPO nor the SPO shall be responsible for administration of the contract or determinations respecting performance or payment there under except as otherwise permitted in the Code.

10. **The services of a subcontractor will be used.**

Check box Yes
 Check box No

For known subcontractors with subcontracts with an annual value of more than \$50,000, the contract shall include their name, address, general type of work to be performed, and the dollar allocation for each subcontractor. (30 ILCS 500/20-120)

ILLINOIS DEPARTMENT OF TRANSPORTATION
 SCHEDULE OF PRICES
 CONTRACT
 NUMBER -

State Job # - C-92-021-16

64L02

Project Number

Route

County Name - HENRY- WHITESIDE-

FAI74/280

Code - 73 - 195 -

FAI 88

District - 2 - 2 -

Section Number - D2 DRAINAGE 2016-1

Item Number	Pay Item Description	Unit of Measure	Quantity	x	Unit Price	=	Total Price
X7010410	SPEED DISPLAY TRAILER	CAL MO	1.000				
20200100	EARTH EXCAVATION	CU YD	100.000				
20400800	FURNISHED EXCAVATION	CU YD	275.000				
20800150	TRENCH BACKFILL	CU YD	100.000				
21301072	EXPLOR TRENCH 72	FOOT	25.000				
28100207	STONE RIPRAP CL A4	TON	15.000				
44201796	CL D PATCH T4 12	SQ YD	22.000				
50105220	PIPE CULVERT REMOV	FOOT	60.000				
50800105	REINFORCEMENT BARS	POUND	60.000				
542A1069	P CUL CL A 2 24	FOOT	16.000				
542D1069	P CUL CL D 2 24	FOOT	80.000				
54213459	END SECTIONS 24	EACH	1.000				
54248510	CONCRETE COLLAR	CU YD	1.800				
60900515	CONC THRUST BLOCKS	EACH	1.000				
63301210	REM RE-E SPBGR TY A	FOOT	100.000				

ILLINOIS DEPARTMENT OF TRANSPORTATION
 SCHEDULE OF PRICES
 CONTRACT
 NUMBER - 64L02

State Job # - C-92-021-16

Project Number

Route

County Name - HENRY- WHITESIDE-

FAI74/280

Code - 73 - 195 -

FAI 88

District - 2 - 2 -

Section Number - D2 DRAINAGE 2016-1

Item Number	Pay Item Description	Unit of Measure	Quantity	x	Unit Price	=	Total Price
67100100	MOBILIZATION	L SUM	1.000				
70100205	TRAF CONT-PROT 701401	EACH	2.000				
70100700	TRAF CONT-PROT 701406	L SUM	1.000				

CONTRACT NUMBER

64L02

THIS IS THE TOTAL BID

\$ _____

NOTES:

1. Each PAY ITEM should have a UNIT PRICE and a TOTAL PRICE.
2. The UNIT PRICE shall govern if no TOTAL PRICE is shown or if there is a discrepancy between the product of the UNIT PRICE multiplied by the QUANTITY.
3. If a UNIT PRICE is omitted, the TOTAL PRICE will be divided by the QUANTITY in order to establish a UNIT PRICE.
4. A bid may be declared UNACCEPTABLE if neither a unit price nor a total price is shown.

RETURN WITH BID

STATE REQUIRED ETHICAL STANDARDS GOVERNING CONTRACT PROCUREMENT: ASSURANCES, CERTIFICATIONS AND DISCLOSURES

I. GENERAL

A. Article 50 of the Code establishes the duty of all State CPOs, SPOs, and their designees to maximize the value of the expenditure of public moneys in procuring goods, services, and contracts for the State of Illinois and to act in a manner that maintains the integrity and public trust of State government. In discharging this duty, they are charged by law to use all available information, reasonable efforts, and reasonable actions to protect, safeguard, and maintain the procurement process of the State of Illinois.

B. In order to comply with the provisions of Article 50 and to carry out the duty established therein, all bidders are to adhere to ethical standards established for the procurement process, and to make such assurances, disclosures and certifications required by law. Except as otherwise required in subsection III, paragraphs J-M, by execution of the Proposal Signature Sheet, the bidder indicates that each of the mandated assurances have been read and understood, that each certification is made and understood, and that each disclosure requirement has been understood and completed.

C. In addition to all other remedies provided by law, failure to comply with any assurance, failure to make any disclosure or the making of a false certification shall be grounds for the CPO to void the contract, and may result in the suspension or debarment of the bidder or subcontractor. If a false certification is made by a subcontractor the contractor's submitted bid and the executed contract may not be declared void unless the contractor refuses to terminate the subcontract upon the State's request after a finding that the subcontractor's certification was false.

I acknowledge, understand and accept these terms and conditions.

II. ASSURANCES

The assurances hereinafter made by the bidder are each a material representation of fact upon which reliance is placed should the Department enter into the contract with the bidder.

A. Conflicts of Interest

Section 50-13. Conflicts of Interest.

(a) Prohibition. It is unlawful for any person holding an elective office in this State, holding a seat in the General Assembly, or appointed to or employed in any of the offices or agencies of state government and who receives compensation for such employment in excess of 60% of the salary of the Governor of the State of Illinois, or who is an officer or employee of the Capital Development Board or the Illinois State Toll Highway Authority, or who is the spouse or minor child of any such person to have or acquire any contract, or any direct pecuniary interest in any contract therein, whether for stationery, printing, paper, or any services, materials, or supplies, that will be wholly or partially satisfied by the payment of funds appropriated by the General Assembly of the State of Illinois or in any contract of the Capital Development Board or the Illinois State Toll Highway Authority.

(b) Interests. It is unlawful for any firm, partnership, association or corporation, in which any person listed in subsection (a) is entitled to receive (i) more than 7 1/2% of the total distributable income or (ii) an amount in excess of the salary of the Governor, to have or acquire any such contract or direct pecuniary interest therein.

(c) Combined interests. It is unlawful for any firm, partnership, association, or corporation, in which any person listed in subsection (a) together with his or her spouse or minor children is entitled to receive (i) more than 15%, in the aggregate, of the total distributable income or (ii) an amount in excess of 2 times the salary of the Governor, to have or acquire any such contract or direct pecuniary interest therein.

(d) Securities. Nothing in this Section invalidates the provisions of any bond or other security previously offered or to be offered for sale or sold by or for the State of Illinois.

(e) Prior interests. This Section does not affect the validity of any contract made between the State and an officer or employee of the State or member of the General Assembly, his or her spouse, minor child or any combination of those persons if that contract was in existence before his or her election or employment as an officer, member, or employee. The contract is voidable, however, if it cannot be completed within 365 calendar days after the officer, member, or employee takes office or is employed. The current salary of the Governor is \$177,412.00. Sixty percent of the salary is \$106,447.20.

RETURN WITH BID

The bidder assures the Department that the award and execution of the contract would not cause a violation of Section 50-13, or that an effective exemption has been issued by the Board of Ethics to any individual subject to the Section 50-13 prohibitions pursuant to the provisions of Section 50-20 of the Code. Information concerning the exemption process is available from the Department upon request.

B. Negotiations

Section 50-15. Negotiations.

It is unlawful for any person employed in or on a continual contractual relationship with any of the offices or agencies of State government to participate in contract negotiations on behalf of that office or agency with any firm, partnership, association, or corporation with whom that person has a contract for future employment or is negotiating concerning possible future employment.

The bidder assures the Department that the award and execution of the contract would not cause a violation of Section 50-15, and that the bidder has no knowledge of any facts relevant to the kinds of acts prohibited therein.

C. Inducements

Section 50-25. Inducement.

Any person who offers or pays any money or other valuable thing to any person to induce him or her not to provide a submission to a vendor portal or to bid for a State contract or as recompense for not having bid on a State contract is guilty of a Class 4 felony. Any person who accepts any money or other valuable thing for not bidding for a State contract, not making a submission to a vendor portal, or who withholds a bid or submission to a vendor portal in consideration of the promise for the payment of money or other valuable thing is guilty of a Class 4 felony.

The bidder assures the Department that the award and execution of the contract would not cause a violation of Section 50-25, and that the bidder has no knowledge of any facts relevant to the kinds of acts prohibited therein.

D. Revolving Door Prohibition

Section 50-30. Revolving door prohibition.

CPOs, SPOs, procurement compliance monitors, their designees whose principal duties are directly related to State procurement, and executive officers confirmed by the Senate are expressly prohibited for a period of 2 years after terminating an affected position from engaging in any procurement activity relating to the State agency most recently employing them in an affected position for a period of at least 6 months. The prohibition includes, but is not limited to: lobbying the procurement process; specifying; bidding; proposing bid, proposal, or contract documents; on their own behalf or on behalf of any firm, partnership, association, or corporation. This Section applies only to persons who terminate an affected position on or after January 15, 1999.

The bidder assures the Department that the award and execution of the contract would not cause a violation of Section 50-30, and that the bidder has no knowledge of any facts relevant to the kinds of acts prohibited therein.

E. Reporting Anticompetitive Practices

Section 50-40. Reporting anticompetitive practices.

When, for any reason, any vendor, bidder, contractor, CPO, SPO, designee, elected official, or State employee suspects collusion or other anticompetitive practice among any bidders, offerors, contractors, proposers, or employees of the State, a notice of the relevant facts shall be transmitted to the Attorney General and the CPO.

The bidder assures the Department that it has not failed to report any relevant facts concerning the practices addressed in Section 50-40 which may involve the contract for which the bid or submission to a vendor portal is submitted.

F. Confidentiality

Section 50-45. Confidentiality.

Any CPO, SPO, designee, or executive officer who willfully uses or allows the use of specifications, competitive bid documents, proprietary competitive information, proposals, contracts, or selection information to compromise the fairness or integrity of the procurement, bidding, or contract process shall be subject to immediate dismissal, regardless of the Personnel code, any contract, or any collective bargaining agreement, and may in addition be subject to criminal prosecution.

The bidder assures the Department that it has no knowledge of any fact relevant to the practices addressed in Section 50-45 which may involve the contract for which the bid is submitted.

RETURN WITH BID

G. Insider Information

Section 50-50. Insider information.

It is unlawful for any current or former elected or appointed State official or State employee to knowingly use confidential information available only by virtue of that office or employment for actual or anticipated gain for themselves or another person.

The bidder assures the Department that it has no knowledge of any facts relevant to the practices addressed in Section 50-50 which may involve the contract for which the bid is submitted.

I acknowledge, understand and accept these terms and conditions for the above assurances.

III. CERTIFICATIONS

The certifications hereinafter made by the bidder are each a material representation of fact upon which reliance is placed should the Department enter into the contract with the bidder. Section 50-2 of the Code provides that every person that has entered into a multi-year contract and every subcontractor with a multi-year subcontract shall certify, by July 1 of each fiscal year covered by the contract after the initial fiscal year, to the responsible CPO whether it continues to satisfy the requirements of Article 50 pertaining to the eligibility for a contract award. If a contractor or subcontractor is not able to truthfully certify that it continues to meet all requirements, it shall provide with its certification a detailed explanation of the circumstances leading to the change in certification status. A contractor or subcontractor that makes a false statement material to any given certification required under Article 50 is, in addition to any other penalties or consequences prescribed by law, subject to liability under the Whistleblower Reward and Protection Act for submission of a false claim.

A. Bribery

Section 50-5. Bribery.

(a) Prohibition. No person or business shall be awarded a contract or subcontract under this Code who:

(1) has been convicted under the laws of Illinois or any other state of bribery or attempting to bribe an officer or employee of the State of Illinois or any other state in that officer's or employee's official capacity; or

(2) has made an admission of guilt of that conduct that is a matter of record but has not been prosecuted for that conduct.

(b) Businesses. No business shall be barred from contracting with any unit of State or local government, or subcontracting under such a contract, as a result of a conviction under this Section of any employee or agent of the business if the employee or agent is no longer employed by the business and:

(1) the business has been finally adjudicated not guilty; or

(2) the business demonstrates to the governmental entity with which it seeks to contract, or which is signatory to the contract which the subcontract relates, and that entity finds that the commission of the offense was not authorized, requested, commanded, or performed by a director, officer, or high managerial agent on behalf of the business as provided in paragraph (2) of subsection (a) of Section 5-4 of the Criminal Code of 2012.

(c) Conduct on behalf of business. For purposes of this Section, when an official, agent, or employee of a business committed the bribery or attempted bribery on behalf of the business and in accordance with the direction or authorization of a responsible official of the business, the business shall be chargeable with the conduct.

(d) Certification. Every bid submitted to and contract executed by the State, and every subcontract subject to Section 20-120 of the Code shall contain a certification by the contractor or the subcontractor, respectively, that the contractor or subcontractor is not barred from being awarded a contract or subcontract under this Section and acknowledges that the CPO may declare the related contract void if any certifications required by this Section are false. A contractor who makes a false statement, material to the certification, commits a Class 3 felony.

The contractor or subcontractor certifies that it is not barred from being awarded a contract under Section 50-5.

B. Felons

Section 50-10. Felons.

(a) Unless otherwise provided, no person or business convicted of a felony shall do business with the State of Illinois or any State agency, or enter into a subcontract, from the date of conviction until 5 years after the date of completion of the sentence for that felony, unless no person held responsible by a prosecutorial office for the facts upon which the conviction was based continues to have any involvement with the business.

(b) Certification. Every bid submitted to and contract executed by the State and every subcontract subject to Section 20-120 of the Code and every vendor's submission to a vendor portal shall contain a certification by the bidder or contractor or subcontractor, respectively, that the bidder, contractor, or subcontractor is not barred from being awarded a contract or subcontract under this Section and acknowledges that the CPO may declare the related contract void if any of the certifications required by this Section are false.

RETURN WITH BID

C. Debt Delinquency

Section 50-11 and 50-12. Debt Delinquency.

The contractor or bidder or subcontractor, respectively, certifies that it, or any affiliate, is not barred from being awarded a contract or subcontract under the Code. Section 50-11 prohibits a person from entering into a contract with a State agency, or entering into a subcontract, if it knows or should know that it, or any affiliate, is delinquent in the payment of any debt to the State as defined by the Debt Collection Board. Section 50-12 prohibits a person from entering into a contract with a State agency, or entering into a subcontract, if it, or any affiliate, has failed to collect and remit Illinois Use Tax on all sales of tangible personal property into the State of Illinois in accordance with the provisions of the Illinois Use Tax Act. The bidder or contractor or subcontractor, respectively, further acknowledges that the CPO may declare the related contract void if this certification is false or if the bidder, contractor, or subcontractor, or any affiliate, is determined to be delinquent in the payment of any debt to the State during the term of the contract.

D. Prohibited Bidders, Contractors and Subcontractors

Section 50-10.5 and 50-60(c). Prohibited bidders, contractors and subcontractors.

The bidder or contractor or subcontractor, respectively, certifies in accordance with Section 50-10.5 that no officer, director, partner or other managerial agent of the contracting business has been convicted of a felony under the Sarbanes-Oxley Act of 2002 or a Class 3 or Class 2 felony under the Illinois Securities Law of 1953 or if in violation of Subsection (c) for a period of five years from the date of conviction. Every bid submitted to and contract executed by the State and every subcontract subject to Section 20-120 of the Code shall contain a certification by the bidder, contractor, or subcontractor, respectively, that the bidder, contractor, or subcontractor is not barred from being awarded a contract or subcontract under this Section and acknowledges that the CPO shall declare the related contract void if any of the certifications completed pursuant to this Section are false.

E. Section 42 of the Environmental Protection Act

Section 50-14 Environmental Protection Act violations.

The bidder or contractor or subcontractor, respectively, certifies in accordance with Section 50-14 that the bidder, contractor, or subcontractor, is not barred from being awarded a contract or entering into a subcontract under this Section which prohibits the bidding on or entering into contracts with the State of Illinois or a State agency, or entering into any subcontract, that is subject to the Code by a person or business found by a court or the Pollution Control Board to have committed a willful or knowing violation of Section 42 of the Environmental Protection Act for a period of five years from the date of the order. The bidder or contractor or subcontractor, respectively, acknowledges that the CPO may declare the contract void if this certification is false.

F. Educational Loan

Section 3 of the Educational Loan Default Act, 5 ILCS 385/3.

Pursuant to the Educational Loan Default Act no State agency shall contract with an individual for goods or services if that individual is in default on an educational loan.

The bidder, if an individual as opposed to a corporation, partnership or other form of business organization, certifies that the bidder is not in default on an educational loan as provided in Section 3 of the Act.

G. Bid-Rigging/Bid Rotating

Section 33E-11 of the Criminal Code of 2012, 720 ILCS 5/33E-11.:

(a) Every bid submitted to and public contract executed pursuant to such bid by the State or a unit of local government shall contain a certification by the prime contractor that the prime contractor is not barred from contracting with any unit of State or local government as a result of a violation of either Section 33E-3 or 33E-4 of this Article

(b) A contractor who makes a false statement, material to the certification, commits a Class 3 felony.

A violation of Section 33E-3 would be represented by a conviction of the crime of bid-rigging which, in addition to Class 3 felony sentencing, provides that any person convicted of this offense or any similar offense of any state or the United States which contains the same elements as this offense shall be barred for 5 years from the date of conviction from contracting with any unit of State or local government. No corporation shall be barred from contracting with any unit of State or local government as a result of a conviction under this Section of any employee or agent of such corporation if the employee so convicted is no longer employed by the corporation and: (1) it has been finally adjudicated not guilty or (2) if it demonstrates to the governmental entity with which it seeks to contract and that entity finds that the commission of the offense was neither authorized, requested, commanded, nor performed by a director, officer or a high managerial agent in behalf of the corporation.

The bidder certifies that it is not barred from contracting with the Department by reason of a violation of either Section 33E-3 or Section 33E-4.

RETURN WITH BID

H. International Anti-Boycott

Section 5 of the International Anti-Boycott Certification Act provides every contract entered into by the State of Illinois for the manufacture, furnishing, or purchasing of supplies, material, or equipment or for the furnishing of work, labor, or services, in an amount exceeding the threshold for small purchases according to the purchasing laws of this State or \$10,000.00, whichever is less, shall contain certification, as a material condition of the contract, by which the contractor agrees that neither the contractor nor any substantially-owned affiliated company is participating or shall participate in an international boycott in violation of the provisions of the U.S. Export Administration Act of 1979 or the regulations of the U.S. Department of Commerce promulgated under that Act.

The bidder makes the certification set forth in Section 5 of the Act.

I. Drug Free Workplace

The Illinois "Drug Free Workplace Act" applies to this contract and it is necessary to comply with the provisions of the "Act" if the contractor is a corporation, partnership, or other entity (including a sole proprietorship) which has 25 or more employees.

The bidder certifies that if awarded a contract in excess of \$5,000 it will provide a drug free workplace in compliance with the provisions of the Act.

J. Disclosure of Business Operations in Iran

Section 50-36 of the Code provides that each bid, offer, or proposal submitted for a State contract shall include a disclosure of whether or not the Company acting as the bidder, offeror, or proposing entity, or any of its corporate parents or subsidiaries, within the 24 months before submission of the bid, offer, or proposal had business operations that involved contracts with or provision of supplies or services to the Government of Iran, companies in which the Government of Iran has any direct or indirect equity share, consortiums or projects commissioned by the Government of Iran, or companies involved in consortiums or projects commissioned by the Government of Iran and either of the following conditions apply:

- (1) More than 10% of the Company's revenues produced in or assets located in Iran involve oil-related activities or mineral-extraction activities; less than 75% of the Company's revenues produced in or assets located in Iran involve contracts with or provision of oil-related or mineral-extraction products or services to the Government of Iran or a project or consortium created exclusively by that government; and the Company has failed to take substantial action.
- (2) The Company has, on or after August 5, 1996, made an investment of \$20 million or more, or any combination of investments of at least \$10 million each that in the aggregate equals or exceeds \$20 million in any 12-month period, which directly or significantly contributes to the enhancement of Iran's ability to develop petroleum resources of Iran.

The terms "Business operations", "Company", "Mineral-extraction activities", "Oil-related activities", "Petroleum resources", and "Substantial action" are all defined in the Code.

Failure to make the disclosure required by the Code may cause the bid, offer or proposal to be considered not responsive. The disclosure will be considered when evaluating the bid or awarding the contract. The name of each Company disclosed as doing business or having done business in Iran will be provided to the State Comptroller.

Check the appropriate statement:

Company has no business operations in Iran to disclose.

Company has business operations in Iran as disclosed on the attached document.

RETURN WITH BID

K. Apprenticeship and Training Certification (Does not apply to federal aid projects)

In accordance with the provisions of Section 30-22 (6) of the Code, the bidder certifies that it is a participant, either as an individual or as part of a group program, in the approved apprenticeship and training programs applicable to each type of work or craft that the bidder will perform with its own forces. The bidder further certifies for work that will be performed by subcontract that each of its subcontractors submitted for approval either (a) is, at the time of such bid, participating in an approved, applicable apprenticeship and training program; or (b) will, prior to commencement of performance of work pursuant to this contract, begin participation in an approved apprenticeship and training program applicable to the work of the subcontract. The Department, at any time before or after award, may require the production of a copy of each applicable Certificate of Registration issued by the United States Department of Labor evidencing such participation by the contractor and any or all of its subcontractors. Applicable apprenticeship and training programs are those that have been approved and registered with the United States Department of Labor. The bidder shall list in the space below, the official name of the program sponsor holding the Certificate of Registration for all of the types of work or crafts in which the bidder is a participant and that will be performed with the bidder's forces. Types of work or craft work that will be subcontracted shall be included and listed as subcontract work. The list shall also indicate any type of work or craft job category that does not have an applicable apprenticeship or training program. **The bidder is responsible for making a complete report and shall make certain that each type of work or craft job category that will be utilized on the project as reported on the Construction Employee Workforce Projection (Form BC-1256) and returned with the bid is accounted for and listed.**

Additionally, Section 30-22 of the Code requires that the bidder certify that an Illinois office be maintained as the primary place of employment for persons employed for this contract.

The requirements of these certifications and disclosures are a material part of the contract, and the contractor shall require these certification provisions to be included in all approved subcontracts. In order to fulfill this requirement, it shall not be necessary that an applicable program sponsor be currently taking, or that it will take applications for apprenticeship, training or employment during the performance of the work of this contract.

TO BE RETURNED WITH BID

L. Political Contributions and Registration with the State Board of Elections

Sections 20-160 and 50-37 of the Code regulate political contributions from business entities and any affiliated entities or affiliated persons bidding on or contracting with the state. Generally under Section 50-37, any business entity, and any affiliated entity or affiliated person of the business entity, whose current year contracts with all state agencies exceed an awarded value of \$50,000, are prohibited from making any contributions to any political committees established to promote the candidacy of the officeholder responsible for the awarding of the contracts or any other declared candidate for that office for the duration of the term of office of the incumbent officeholder or a period 2 years after the termination of the contract, whichever is longer. Any business entity and affiliated entities or affiliated persons whose state contracts in the current year do not exceed an awarded value of \$50,000, but whose aggregate pending bids and proposals on state contracts exceed \$50,000, either alone or in combination with contracts not exceeding \$50,000, are prohibited from making any political contributions to any political committee established to promote the candidacy of the officeholder responsible for awarding the pending contract during the period beginning on the date the invitation for bids or request for proposals or any other procurement opportunity is issued and ending on the day after the date of award or selection if the entity was not awarded or selected. Section 20-160 requires certification of registration of affected business entities in accordance with procedures found in Section 9-35 of The Election Code.

By submission of a bid, the contractor business entity acknowledges and agrees that it has read and understands Sections 20-160 and 50-37 of the Code, and that it makes the following certification:

The undersigned bidder certifies that it has registered as a business with the State Board of Elections and acknowledges a continuing duty to update the registration in accordance with the above referenced statutes. If the business entity is required to register, the CPO shall verify that it is in compliance on the date the bid or proposal is due. The CPO shall not accept a bid or proposal if the business entity is not in compliance with the registration requirements.

These requirements and compliance with the above referenced statutory sections are a material part of the contract, and any breach thereof shall be cause to void the contract under Section 50-60 of the Code. This provision does not apply to Federal-aid contracts.

M. Lobbyist Disclosure

Section 50-38 of the Code requires that any bidder or offeror on a State contract that hires a person required to register under the Lobbyist Registration Act to assist in obtaining a contract shall:

- (i) Disclose all costs, fees, compensation, reimbursements, and other remunerations paid or to be paid to the lobbyist related to the contract,
- (ii) Not bill or otherwise cause the State of Illinois to pay for any of the lobbyist's costs, fees, compensation, reimbursements, or other remuneration, and
- (iii) Sign a verification certifying that none of the lobbyist's costs, fees, compensation, reimbursements, or other remuneration were billed to the State.

This information, along with all supporting documents, shall be filed with the agency awarding the contract and with the Secretary of State. The CPO shall post this information, together with the contract award notice, in the online Procurement Bulletin.

Pursuant to Subsection (c) of this Section, no person or entity shall retain a person or entity to attempt to influence the outcome of a procurement decision made under the Code for compensation contingent in whole or in part upon the decision or procurement. Any person who violates this subsection is guilty of a business offense and shall be fined not more than \$10,000.

Bidder acknowledges that it is required to disclose the hiring of any person required to register pursuant to the Illinois Lobbyist Registration Act (25 ILCS 170) in connection with this contract.

Bidder has not hired any person required to register pursuant to the Illinois Lobbyist Registration Act in connection with this contract.

Or

Bidder has hired the following persons required to register pursuant to the Illinois Lobbyist Registration Act in connection with the contract:

Name and address of person: _____
All costs, fees, compensation, reimbursements and other remuneration paid to said person: _____

I acknowledge, understand and accept these terms and conditions for the above certifications.

RETURN WITH BID

IV. DISCLOSURES

- A. The disclosures hereinafter made by the bidder are each a material representation of fact upon which reliance is placed should the Department enter into the contract with the bidder. The bidder further certifies that the Department has received the disclosure forms for each bid.

The CPO may void the bid, or contract, respectively, if it is later determined that the bidder or subcontractor rendered a false or erroneous disclosure. A contractor or subcontractor may be suspended or debarred for violations of the Code. Furthermore, the CPO may void the contract and the surety providing the performance bond shall be responsible for completion of the contract.

B. Financial Interests and Conflicts of Interest

1. Section 50-35 of the Code provides that all bids of more than \$50,000 and all submissions to a vendor portal shall be accompanied by disclosure of the financial interests of the bidder. This disclosed information for the successful bidder, will be maintained as public information subject to release by request pursuant to the Freedom of Information Act, filed with the Procurement Policy Board, and shall be incorporated as a material term of the contract. Furthermore, pursuant to Section 5-5, the Procurement Policy Board may review a proposal, bid, or contract and issue a recommendation to void a contract or reject a proposal or bid based on any violation of the Code or the existence of a conflict of interest as provided in subsections (b) and (d) of Section 50-35.

The financial interests to be disclosed shall include ownership or distributive income share that is in excess of 5%, or an amount greater than 60% of the annual salary of the Governor, of the bidding entity or its parent entity, whichever is less, unless the contractor or bidder is a publicly traded entity subject to Federal 10K reporting, in which case it may submit its 10K disclosure in place of the prescribed disclosure. If a bidder is a privately held entity that is exempt from Federal 10K reporting, but has more than 100 shareholders, it may submit the information that Federal 10K companies are required to report, and list the names of any person or entity holding any ownership share that is in excess of 5%. The disclosure shall include the names, addresses, and dollar or proportionate share of ownership of each individual making the disclosure, their instrument of ownership or beneficial relationship, and notice of any potential conflict of interest resulting from the current ownership or beneficial interest of each individual making the disclosure having any of the relationships identified in Section 50-35 and on the disclosure form.

The current annual salary of the Governor is \$177,412.00

In addition, all disclosures shall indicate any other current or pending contracts, proposals, leases, or other ongoing procurement relationships the bidding entity has with any other unit of state government and shall clearly identify the unit and the contract, proposal, lease, or other relationship.

2. Disclosure Forms. Disclosure Form A is attached for use concerning the individuals meeting the above ownership or distributive share requirements. A separate Disclosure Form A must be submitted with the bid for each individual meeting the above requirements. In addition, a second form (Disclosure Form B) provides for the disclosure of current or pending procurement relationships with other (non-IDOT) state agencies and a total ownership certification. **The forms must be included with each bid.**

C. Disclosure Form Instructions

Form A Instructions for Financial Information & Potential Conflicts of Interest

If the bidder is a publicly traded entity subject to Federal 10K reporting, the 10K Report may be submitted to meet the requirements of Form A. If a bidder is a privately held entity that is exempt from Federal 10K reporting, but has more than 100 shareholders, it may submit the information that Federal 10K companies are required to report, and list the names of any person or entity holding any ownership share that is in excess of 5%. If a bidder is not subject to Federal 10K reporting, the bidder must determine if any individuals are required by law to complete a financial disclosure form. To do this, the bidder should answer each of the following questions. A "YES" answer indicates Form A must be completed. If the answer to each of the following questions is "NO", then the NOT APPLICABLE STATEMENT on Form A must be signed and dated by an individual that is authorized to execute contracts for the bidding company. Note: These questions are for assistance only and are not required to be completed.

1. Does anyone in your organization have a direct or beneficial ownership share of greater than 5% of the bidding entity or parent entity? YES ___ NO ___
2. Does anyone in your organization have a direct or beneficial ownership share of less than 5%, but which has a value greater than 60% of the annual salary of the Governor? YES ___ NO ___
3. Does anyone in your organization receive more than 60% of the annual salary of the Governor of the bidding entity's or parent entity's distributive income? YES ___ NO ___

(Note: Distributive income is, for these purposes, any type of distribution of profits. An annual salary is not distributive income.)

4. Does anyone in your organization receive greater than 5% of the bidding entity's or parent entity's total distributive income, but which is less than 60% of the annual salary of the Governor? YES ___ NO ___

(Note: Only one set of forms needs to be completed per individual per bid even if a specific individual would require a yes answer to more than one question.)

A "YES" answer to any of these questions requires the completion of Form A. The bidder must determine each individual in the bidding entity or the bidding entity's parent company that would cause the questions to be answered "Yes". Each form must be signed and dated by an individual that is authorized to execute contracts for your organization. The individual signing can be, but does not have to be, the individual for which the form is being completed. The bidder is responsible for the accuracy of any information provided.

If the answer to each of the above questions is "NO", then the NOT APPLICABLE STATEMENT of Form A must be signed and dated by an individual that is authorized to execute contracts for your company.

RETURN WITH BID

Form B: Instructions for Identifying Other Contracts & Procurement Related Information

Disclosure Form B must be completed for each bid submitted by the bidding entity. *Note: Checking the NOT APPLICABLE STATEMENT on Form A does not allow the bidder to ignore Form B. Form B must be completed, checked, and dated or the bidder may be considered nonresponsive and the bid will not be accepted.*

The Bidder shall identify, by checking Yes or No on Form B, whether it has any pending contracts (including leases), bids, proposals, or other ongoing procurement relationship with any other (non-IDOT) State of Illinois agency. If "No" is checked, the bidder only needs to complete the check box on the bottom of Form B. If "Yes" is checked, the bidder must do one of the following:

Option I: If the bidder did not submit an Affidavit of Availability to obtain authorization to bid, the bidder must list all non-IDOT State of Illinois agency pending contracts, leases, bids, proposals, and other ongoing procurement relationships. These items may be listed on Form B or on an attached sheet(s). Do not include IDOT contracts. Contracts with cities, counties, villages, etc. are not considered State of Illinois agency contracts and are not to be included. Contracts with other State of Illinois agencies such as the Department of Natural Resources or the Capital Development Board must be included. Bidders who submit Affidavits of Availability are suggested to use Option II.

Option II: If the bidder is required and has submitted an Affidavit of Availability in order to obtain authorization to bid, the bidder may write or type "See Affidavit of Availability" which indicates that the Affidavit of Availability is incorporated by reference and includes all non-IDOT State of Illinois agency pending contracts, leases, bids, proposals, and other ongoing procurement relationships. For any contracts that are not covered by the Affidavit of Availability, the bidder must identify them on Form B or on an attached sheet(s). These might be such things as leases.

ILLINOIS DEPARTMENT OF TRANSPORTATION

Form A Financial Information & Potential Conflicts of Interest Disclosure

Contractor Name, Legal Address, City, State, Zip, Telephone Number, Email Address, Fax Number (if available)

Disclosure of the information contained in this Form is required by Section 50-35 of the Code (30 ILCS 500). Vendors desiring to enter into a contract with the State of Illinois must disclose the financial information and potential conflict of interest information as specified in this Disclosure Form. This information shall become part of the publicly available contract file. This Form A must be completed for bids in excess of \$50,000, and for all open-ended contracts. A publicly traded company may submit a 10K disclosure (or equivalent if applicable) in satisfaction of the requirements set forth in Form A. See Disclosure Form Instructions.

The current annual salary of the Governor is \$177,412.00.

DISCLOSURE OF FINANCIAL INFORMATION

1. Disclosure of Financial Information. The individual named below has an interest in the BIDDER (or its parent) in terms of ownership or distributive income share in excess of 5%, or an interest which has a value of more than 60% of the annual salary of the Governor. (Make copies of this form as necessary and attach a separate Disclosure Form A for each individual meeting these requirements)

FOR INDIVIDUAL (type or print information) NAME: ADDRESS Type of ownership/distributable income share: stock sole proprietorship Partnership other: (explain on separate sheet): % or \$ value of ownership/distributable income share:

2. Disclosure of Potential Conflicts of Interest. Check "Yes" or "No" to indicate which, if any, of the following potential conflict of interest relationships apply. If the answer to any question is "Yes", please attach additional pages and describe.

(a) State employment, currently or in the previous 3 years, including contractual employment of services. Yes ___ No ___

If your answer is yes, please answer each of the following questions.

1. Are you currently an officer or employee of either the Capitol Development Board or the Illinois State Toll Highway Authority? Yes ___ No ___

2. Are you currently appointed to or employed by any agency of the State of Illinois? If you are currently appointed to or employed by any agency of the State of Illinois, and your annual salary exceeds 60% of the annual salary of the Governor, provide the name the State agency for which you are employed and your annual salary.

RETURN WITH BID

3. If you are currently appointed to or employed by any agency of the State of Illinois, and your annual salary exceeds 60% of the annual salary of the Governor, are you entitled to receive (i) more than 7 1/2% of the total distributable income of your firm, partnership, association or corporation, or (ii) an amount in excess of 100% of the annual salary of the Governor?
Yes ___ No ___

4. If you are currently appointed to or employed by any agency of the State of Illinois, and your annual salary exceeds 60% of the annual salary of the Governor, are you and your spouse or minor children entitled to receive (i) more than 15 % in the aggregate of the total distributable income of your firm, partnership, association or corporation, or (ii) an amount in excess of two times the salary of the Governor?
Yes ___ No ___

(b) State employment of spouse, father, mother, son, or daughter, including contractual employment for services in the previous 2 years.

Yes ___ No ___

If your answer is yes, please answer each of the following questions.

1. Is your spouse or any minor children currently an officer or employee of the Capitol Development Board or the Illinois State Toll Highway Authority?
Yes ___ No ___

2. Is your spouse or any minor children currently appointed to or employed by any agency of the State of Illinois? If your spouse or minor children is/are currently appointed to or employed by any agency of the State of Illinois, and his/her annual salary exceeds 60% of the annual salary of the Governor, provide the name of your spouse and/or minor children, the name of the State agency for which he/she is employed and his/her annual salary. _____

3. If your spouse or any minor children is/are currently appointed to or employed by any agency of the State of Illinois, and his/her annual salary exceeds 60% of the annual salary of the Governor, are you entitled to receive (i) more than 7 1/2% of the total distributable income of your firm, partnership, association or corporation, or (ii) an amount in excess of 100% of the annual salary of the Governor?
Yes ___ No ___

4. If your spouse or any minor children are currently appointed to or employed by any agency of the State of Illinois, and his/her annual salary exceeds 60% of the annual salary of the Governor, are you and your spouse or minor children entitled to receive (i) more than 15 % in the aggregate of the total distributable income of your firm, partnership, association or corporation, or (ii) an amount in excess of two times the salary of the Governor?
Yes ___ No ___

(c) Elective status; the holding of elective office of the State of Illinois, the government of the United States, any unit of local government authorized by the Constitution of the State of Illinois or the statutes of the State of Illinois currently or in the previous 3 years.
Yes ___ No ___

(d) Relationship to anyone holding elective office currently or in the previous 2 years; spouse, father, mother, son, or daughter.
Yes ___ No ___

(e) Appointive office; the holding of any appointive government office of the State of Illinois, the United States of America, or any unit of local government authorized by the Constitution of the State of Illinois or the statutes of the State of Illinois, which office entitles the holder to compensation in excess of the expenses incurred in the discharge of that office currently or in the previous 3 years.
Yes ___ No ___

(f) Relationship to anyone holding appointive office currently or in the previous 2 years; spouse, father, mother, son, or daughter.
Yes ___ No ___

(g) Employment, currently or in the previous 3 years, as or by any registered lobbyist of the State government.
Yes ___ No ___

RETURN WITH BID

(h) Relationship to anyone who is or was a registered lobbyist in the previous 2 years; spouse, father, mother, son, or daughter. Yes ___ No ___

(i) Compensated employment, currently or in the previous 3 years, by any registered election or reelection committee registered with the Secretary of State or any county clerk of the State of Illinois, or any political action committee registered with either the Secretary of State or the Federal Board of Elections. Yes ___ No ___

(j) Relationship to anyone; spouse, father, mother, son, or daughter; who was a compensated employee in the last 2 years by any registered election or re-election committee registered with the Secretary of State or any county clerk of the State of Illinois, or any political action committee registered with either the Secretary of State or the Federal Board of Elections. Yes ___ No ___

3. Communication Disclosure.

Disclose the name and address of each lobbyist and other agent of the bidder or offeror who is not identified in Section 2 of this form, who is has communicated, is communicating, or may communicate with any State officer or employee concerning the bid or offer. This disclosure is a continuing obligation and must be promptly supplemented for accuracy throughout the process and throughout the term of the contract. If no person is identified, enter "None" on the line below:

Name and address of person(s): _____

RETURN WITH BID

4. Suspension or Debarment Disclosure. For each of the persons identified under Sections 2 and 3 of this form, disclose whether any of the following has occurred within the previous 10 years: suspension or debarment from contracting with any governmental entity; professional licensure discipline; bankruptcies; adverse civil judgments and administrative findings; and criminal felony convictions. This disclosure is a continuing obligation and must be promptly supplemented for accuracy throughout the procurement process and term of the contract. If no person is identified, enter "None" on the line below:

Name of person(s): _____

Nature of disclosure: _____

APPLICABLE STATEMENT

This Disclosure Form A is submitted on behalf of the INDIVIDUAL named on previous page. Under penalty of perjury, I certify the contents of this disclosure to be true and accurate to the best of my knowledge.

Completed by: _____ Date _____
Signature of Individual or Authorized Representative

NOT APPLICABLE STATEMENT

Under penalty of perjury, I have determined that no individuals associated with this organization meet the criteria that would require the completion of this Form A.

This Disclosure Form A is submitted on behalf of the CONTRACTOR listed on the previous page.

_____ Date _____
Signature of Authorized Representative

The bidder has a continuing obligation to supplement these disclosures under Sec. 50-35 of the Code.

RETURN WITH BID

ILLINOIS DEPARTMENT OF TRANSPORTATION

Form B Other Contracts & Financial Related Information Disclosure

Contractor Name, Legal Address, City, State, Zip, Telephone Number, Email Address, Fax Number (if available)

Disclosure of the information contained in this Form is required by Section 50-35 of the Code (30 ILCS 500). This information shall become part of the publicly available contract file. This Form B must be completed for all bids.

DISCLOSURE OF OTHER CONTRACTS AND PROCUREMENT RELATED INFORMATION

- 1. Identifying Other Contracts & Procurement Related Information. The BIDDER shall identify whether it has any pending contracts... 2. If "Yes" is checked. Identify each such relationship by showing State of Illinois agency name and other descriptive information...

THE FOLLOWING STATEMENT MUST BE CHECKED

Signature of Authorized Representative, Date

OWNERSHIP CERTIFICATION

Please certify that the following statement is true if the individuals for all submitted Form A disclosures do not total 100% of ownership.

Any remaining ownership interest is held by individuals receiving less than \$106,447.20 of the bidding entity's or parent entity's distributive income or holding less than a 5% ownership interest.

- Yes No N/A (Form A disclosure(s) established 100% ownership)

RETURN WITH BID

SPECIAL NOTICE TO CONTRACTORS

The following requirements of the Illinois Department of Human Rights Act are applicable to bidders on all construction contracts advertised by the Illinois Department of Transportation:

CONSTRUCTION EMPLOYEE UTILIZATION PROJECTION

- (a) All bidders on construction contracts shall complete and submit, along with and as part of their bids, a Bidder's Employee Utilization Form (Form BC-1256) setting forth a projection and breakdown of the total workforce intended to be hired and/or allocated to such contract work by the bidder including a projection of minority and female employee utilization in all job classifications on the contract project.
- (b) The Department of Transportation shall review the Employee Utilization Form, and workforce projections contained therein, of the contract awardee to determine if such projections reflect an underutilization of minority persons and/or women in any job classification in accordance with the Equal Employment Opportunity Clause and Title 44, Illinois Administrative Code, Section 750.120. If it is determined that the contract awardee's projections reflect an underutilization of minority persons and/or women in any job classification, it shall be advised in writing of the manner in which it is underutilizing and such awardee shall be considered to be in breach of the contract unless, prior to commencement of work on the contract project, it submits revised satisfactory projections or an acceptable written affirmative action plan to correct such underutilization including a specific timetable geared to the completion stages of the contract.
- (c) The Department of Transportation shall provide to the Department of Human Rights a copy of the contract awardee's Employee Utilization Form, a copy of any required written affirmative action plan, and any written correspondence related thereto. The Department of Human Rights may review and revise any action taken by the Department of Transportation with respect to these requirements.

RETURN WITH BID

**Contract No. 64L02
WHITESIDE-HENRY Counties
Section D2 DRAINAGE 2016-1
Routes FAI 74/280 & FAI 88
District 2 Construction Funds**

PART II. WORKFORCE PROJECTION - continued

- B. Included in "Total Employees" under Table A is the total number of **new hires** that would be employed in the event the undersigned bidder is awarded this contract.

The undersigned bidder projects that: (number) _____ new hires would be recruited from the area in which the contract project is located; and/or (number) _____ new hires would be recruited from the area in which the bidder's principal office or base of operation is located.

- C. Included in "Total Employees" under Table A is a projection of numbers of persons to be employed directly by the undersigned bidder as well as a projection of numbers of persons to be employed by subcontractors.

The undersigned bidder estimates that (number) _____ persons will be directly employed by the prime contractor and that (number) _____ persons will be employed by subcontractors.

PART III. AFFIRMATIVE ACTION PLAN

- A. The undersigned bidder understands and agrees that in the event the foregoing minority and female employee utilization projection included under **PART II** is determined to be an underutilization of minority persons or women in any job category, and in the event that the undersigned bidder is awarded this contract, he/she will, prior to commencement of work, develop and submit a written Affirmative Action Plan including a specific timetable (geared to the completion stages of the contract) whereby deficiencies in minority and/or female employee utilization are corrected. Such Affirmative Action Plan will be subject to approval by the contracting agency and the **Illinois Department of Human Rights**.
- B. The undersigned bidder understands and agrees that the minority and female employee utilization projection submitted herein, and the goals and timetable included under an Affirmative Action Plan if required, are deemed to be part of the contract specifications.

Company _____ Telephone Number _____

Address _____

NOTICE REGARDING SIGNATURE

The Bidder's signature on the Proposal Signature Sheet will constitute the signing of this form. The following signature block needs to be completed if revisions are required.

Signature: _____ Title: _____ Date: _____

- Instructions: All tables must include subcontractor personnel in addition to prime contractor personnel.
- Table A - Include both the number of employees that would be hired to perform the contract work and the total number currently employed (Table B) that will be allocated to contract work, and include all apprentices and on-the-job trainees. The "Total Employees" column should include all employees including all minorities, apprentices and on-the-job trainees to be employed on the contract work.
- Table B - Include all employees currently employed that will be allocated to the contract work including any apprentices and on-the-job trainees currently employed.
- Table C - Indicate the racial breakdown of the total apprentices and on-the-job trainees shown in Table A.

RETURN WITH BID

**Contract No. 64L02
WHITESIDE-HENRY Counties
Section D2 DRAINAGE 2016-1
Routes FAI 74/280 & FAI 88
District 2 Construction Funds**

PROPOSAL SIGNATURE SHEET

The undersigned bidder hereby makes and submits this bid on the subject Proposal, thereby assuring the Department that all requirements of the Invitation for Bids and rules of the Department have been met, that there is no misunderstanding of the requirements of paragraph 3 of this Proposal, and that the contract will be executed in accordance with the rules of the Department if an award is made on this bid.

(IF AN INDIVIDUAL) Firm Name _____
Signature of Owner _____
Business Address _____

(IF A CO-PARTNERSHIP) Firm Name _____
By _____
Business Address _____
Name and Address of All Members of the Firm:

(IF A CORPORATION)
(IF A JOINT VENTURE, USE THIS SECTION FOR THE MANAGING PARTY AND THE SECOND PARTY SHOULD SIGN BELOW)
Corporate Name _____
By _____
Signature of Authorized Representative
Typed or printed name and title of Authorized Representative
Attest _____
Signature
Business Address _____

(IF A JOINT VENTURE)
Corporate Name _____
By _____
Signature of Authorized Representative
Typed or printed name and title of Authorized Representative
Attest _____
Signature
Business Address _____

If more than two parties are in the joint venture, please attach an additional signature sheet.



This Annual Proposal Bid Bond shall become effective at 12:01 AM (CDST) on _____ and shall be valid until _____ 11:59 PM (CDST).

KNOW ALL PERSONS BY THESE PRESENTS, That We _____

as PRINCIPAL, and _____

as SURETY, and held jointly, severally and firmly bound unto the STATE OF ILLINOIS in the penal sum of 5 percent of the total bid price, or for the amount specified in the bid proposal under "Proposal Guaranty" in effect on the date of the Invitation for Bids, whichever is the lesser sum, well and truly to be paid unto said STATE OF ILLINOIS, for the payment of which we bind ourselves, our heirs, executors, administrators, successors and assigns.

THE CONDITION OF THE FOREGOING OBLIGATION IS SUCH that whereas, the PRINCIPAL may submit bid proposal(s) to the STATE OF ILLINOIS, acting through the Department of Transportation, for various improvements published in the Transportation Bulletin during the effective term indicated above.

NOW, THEREFORE, if the Department shall accept the bid proposal(s) of the PRINCIPAL; and if the PRINCIPAL shall, within the time and as specified in the bidding and contract documents; and if, after award by the Department, the PRINCIPAL shall enter into a contract in accordance with the terms of the bidding and contract documents including evidence of the required insurance coverages and providing such bond as specified with good and sufficient surety for the faithful performance of such contract and for the prompt payment of labor and material furnished in the prosecution thereof; or if, in the event of the failure of the PRINCIPAL to enter into such contract and to give the specified bond, the PRINCIPAL pays to the Department the difference not to exceed the penalty hereof between the amount specified in the bid proposal and such larger amount for which the Department may contract with another party to perform the work covered by said bid proposal, then this obligation shall be null and void, otherwise, it shall remain in full force and effect.

IN THE EVENT the Department determines the PRINCIPAL has failed to comply with any requirement as set forth in the preceding paragraph, then Surety shall pay the penal sum to the Department within fifteen (15) days of written demand therefor. If Surety does not make full payment within such period of time, the Department may bring an action to collect the amount owed. Surety is liable to the Department for all its expenses, including attorney's fees, incurred in any litigation in which it prevails either in whole or in part.

In TESTIMONY WHEREOF, the said PRINCIPAL has caused this instrument to be signed by its officer _____ day of _____ A.D., _____

In TESTIMONY WHEREOF, the said SURETY has caused this instrument to be signed by its officer _____ day of _____ A.D., _____

(Company Name)

(Company Name)

By _____
(Signature and Title)

By _____
(Signature of Attorney-in-Fact)

Notary for PRINCIPAL

Notary for SURETY

STATE OF _____
COUNTY OF _____

STATE OF _____
COUNTY OF _____

Signed and attested before me on _____ (date)

Signed and attested before me on _____ (date)

by _____
(Name of Notary Public)

by _____
(Name of Notary Public)

(Seal) _____
(Signature of Notary Public)

(Seal) _____
(Signature of Notary Public)

(Date Commission Expires)

(Date Commission Expires)

In lieu of completing the above section of the Annual Proposal Bid Bond form, the Principal may file an Electronic Bid Bond. By signing the proposal(s) the Principal is ensuring the identified electronic bid bond has been executed and the Principal and Surety are firmly bound unto the State of Illinois under the conditions of the bid bond as shown above.

Electronic Bid Bond ID #	Company/Bidder Name	Signature and Title
--------------------------	---------------------	---------------------

This bond may be terminated, at Surety's request, upon giving not less than thirty (30) days prior written notice of the cancellation/termination of the bond. Said written notice shall be issued to the Illinois Department of Transportation, Chief Contracts Official, 2300 South Dirksen Parkway, Springfield, Illinois, 62764, and shall be served in person, by receipted courier delivery or certified or registered mail, return receipt requested. Said notice period shall commence on the first calendar day following the Department's receipt of written cancellation/termination notice. Surety shall remain firmly bound to all obligations herein for proposals submitted prior to the cancellation/termination. Surety shall be released and discharged from any obligation(s) for proposals submitted for any letting or date after the effective date of cancellation/termination.



Item No. _____

Letting Date _____

KNOW ALL PERSONS BY THESE PRESENTS, That We _____

as PRINCIPAL, and _____

as SURETY, and held jointly, severally and firmly bound unto the STATE OF ILLINOIS in the penal sum of 5 percent of the total bid price, or for the amount specified in the bid proposal under "Proposal Guaranty" in effect on the date of the Invitation for Bids, whichever is the lesser sum, well and truly to be paid unto said STATE OF ILLINOIS, for the payment of which we bind ourselves, our heirs, executors, administrators, successors and assigns.

THE CONDITION OF THE FOREGOING OBLIGATION IS SUCH that whereas, the PRINCIPAL has submitted a bid proposal to the STATE OF ILLINOIS, acting through the Department of Transportation, for the improvement designated by the Transportation Bulletin Item Number and Letting Date indicated above.

NOW, THEREFORE, if the Department shall accept the bid proposal of the PRINCIPAL; and if the PRINCIPAL shall, within the time and as specified in the bidding and contract documents; and if, after award by the Department, the PRINCIPAL shall enter into a contract in accordance with the terms of the bidding and contract documents including evidence of the required insurance coverages and providing such bond as specified with good and sufficient surety for the faithful performance of such contract and for the prompt payment of labor and material furnished in the prosecution thereof; or if, in the event of the failure of the PRINCIPAL to enter into such contract and to give the specified bond, the PRINCIPAL pays to the Department the difference not to exceed the penalty hereof between the amount specified in the bid proposal and such larger amount for which the Department may contract with another party to perform the work covered by said bid proposal, then this obligation shall be null and void, otherwise, it shall remain in full force and effect.

IN THE EVENT the Department determines the PRINCIPAL has failed to comply with any requirement as set forth in the preceding paragraph, then Surety shall pay the penal sum to the Department within fifteen (15) days of written demand therefor. If Surety does not make full payment within such period of time, the Department may bring an action to collect the amount owed. Surety is liable to the Department for all its expenses, including attorney's fees, incurred in any litigation in which it prevails either in whole or in part.

In TESTIMONY WHEREOF, the said PRINCIPAL has caused this instrument to be signed by its officer
_____ day of _____ A.D., _____ .

In TESTIMONY WHEREOF, the said SURETY has caused this instrument to be signed by its officer
_____ day of _____ A.D., _____ .

(Company Name)

(Company Name)

By _____
(Signature and Title)

By _____
(Signature of Attorney-in-Fact)

Notary for PRINCIPAL

Notary for SURETY

STATE OF _____
COUNTY OF _____

STATE OF _____
COUNTY OF _____

Signed and attested before me on _____ (date)
by _____
(Name of Notary Public)

Signed and attested before me on _____ (date)
by _____
(Name of Notary Public)

(Seal) _____
(Signature of Notary Public)

(Seal) _____
(Signature of Notary Public)

(Date Commission Expires)

(Date Commission Expires)

In lieu of completing the above section of the Proposal Bid Bond form, the Principal may file an Electronic Bid Bond. By signing the proposal the Principal is ensuring the identified electronic bid bond has been executed and the Principal and Surety are firmly bound unto the State of Illinois under the conditions of the bid bond as shown above.

Electronic Bid Bond ID # _____ Company/Bidder Name _____ Signature and Title _____



(1) Policy

It is public policy that disadvantageded businesses as defined in 49 CFR Part 26 and the Special Provision shall have the maximum opportunity to participate in the performance of contracts financed in whole or in part with Federal or State funds. Consequently the requirements of 49 CFR Part 26 apply to this contract.

(2) Obligation

The contractor agrees to ensure that disadvantageded businesses as defined in 49 CFR Part 26 and the Special Provision have the maximum opportunity to participate in the performance of contracts or subcontracts financed in whole or in part with Federal or State funds. The contractor shall take all necessary and reasonable steps in accordance with 49 CFR Part 26 and the Special Provision to ensure that said businesses have the maximum opportunity to compete for and perform under this contract. The contractor shall not discriminate on the basis of race, color, national origin or sex in the award and performance of contracts.

(3) Project and Bid Identification

Complete the following information concerning the project and bid:

Route _____

Section _____

Project _____

County _____

Letting Date _____

Contract No. _____

Letting Item No. _____

Total Bid _____

Contract DBE Goal _____

(Percent) (Dollar Amount)

(4) Assurance

I, acting in my capacity as an officer of the undersigned bidder (or bidders if a joint venture), hereby assure the Department that on this project my company : (check one)

- Meets or exceeds contract award goals and has provided documented participation as follows:
Disadvantaged Business Participation _____ percent

Attached are the signed participation statements, forms SBE 2025, required by the Special Provision evidencing availability and use of each business participating in this plan and assuring that each business will perform a commercially useful function in the work of the contract.

- Failed to meet contract award goals and has included good faith effort documentation to meet the goals and that my company has provided participation as follows:
Disadvantaged Business Participation _____ percent

The contract goals should be accordingly modified or waived. Attached is all information required by the Special Provision in support of this request including good faith effort. Also attached are the signed participation statements, forms SBE 2025, required by the Special Provision evidencing availability and use of each business participating in this plan and assuring that each business will perform a commercially useful function in the work of the contract.

_____ Company

By _____

Title _____

Date _____

The "as read" Low Bidder is required to comply with the Special Provision.

Submit only one utilization plan for each project. The utilization plan shall be submitted in accordance with the special provision.

Bureau of Small Business Enterprises **Local Let Projects**
2300 South Dirksen Parkway Submit forms to the
Springfield, Illinois 62764 Local Agency

The Department of Transportation is requesting disclosure of information that is necessary to accomplish the purpose as outlined under State and Federal law. Disclosure of this information is **REQUIRED**. Failure to provide any information will result in the contract not being awarded. This form has been approved by the State Forms Manager Center.



Illinois Department of Transportation

DBE Participation Statement

Subcontractor Registration Number _____

Letting _____

Participation Statement

Item No. _____

(1) Instructions

Contract No. _____

This form must be completed for each disadvantaged business participating in the Utilization Plan. This form shall be submitted in accordance with the special provision and will be attached to the Utilization Plan form. If additional space is needed complete an additional form for the firm. Trucking participation items; description must list what is anticipated towards goal credit.

(2) Work:

Please indicate: J/V _____ Manufacturer _____ Supplier (60%) _____ Subcontractor _____ Trucking _____

Pay Item No.	Description (Anticipated items for trucking)*	Quantity	Unit Price	Total
Total				

(3) Partial Payment Items (For any of the above items which are partial pay items)

Description must be sufficient to determine a Commercially Useful Function, specifically describe the work and subcontract dollar amount:

*Applies to trucking only

(4) Commitment

When a DBE is to be a second-tier subcontractor, or if the first-tier DBE subcontractor is going to be subcontracting a portion of its subcontract, it must be clearly indicated on the DBE Participation Statement, and the details of the transaction fully explained.

In the event a DBE subcontractor second-tiers a portion of its subcontract to one or more subcontractors during the work of a contract, the prime must submit a DBE Participation Statement, with the details of the transaction(s) fully explained.

The undersigned certify that the information included herein is true and correct, and that the DBE firm listed below has agreed to perform a commercially useful function in the work of the contract item(s) listed above and to execute a contract with the prime contractor or 1st Tier subcontractor. The undersigned further understand that no changes to this statement may be made without prior approval from the Department's Bureau of Small Business Enterprises and that complete and accurate information regarding actual work performed on this project and the payment therefore must be provided to the Department.

Signature for Contractor __ 1st Tier __ 2nd Tier

Signature for DBE Firm __ 1st Tier __ 2nd Tier

Date _____

Date _____

Contact Person _____

Contact Person _____

Title _____

Title _____

Firm Name _____

Firm Name _____

Address _____

Address _____

City/State/Zip _____

City/State/Zip _____

Phone _____

Phone _____

Email Address _____

Email Address _____

E _____

WC _____

The Department of Transportation is requesting disclosure of information that is necessary to accomplish the statutory purpose as outlined under the state and federal law. Disclosure of this information is **REQUIRED**. Failure to provide any information will result in the contract not being awarded. This form has been approved by the State Forms Management Center.

PROPOSAL ENVELOPE



PROPOSALS

for construction work advertised for bids by the
Illinois Department of Transportation

Item No.	Item No.	Item No.

Submitted By:

Name:
Address:
Phone No.

Bidders should use an IDOT proposal envelope or affix this form to the front of a 10" x 13" envelope for the submittal of bids. If proposals are mailed, they should be enclosed in a second or outer envelope addressed to:

Engineer of Design and Environment - Room 326
Illinois Department of Transportation
2300 South Dirksen Parkway
Springfield, Illinois 62764

NOTICE

Individual bids, including Bid Bond and/or supplemental information if required, should be securely stapled.

CONTRACTOR OFFICE COPY OF CONTRACT SPECIFICATIONS

NOTICE

None of the following material needs to be returned with the bid package unless the special provisions require documentation and/or other information to be submitted.

**Contract No. 64L02
WHITESIDE-HENRY Counties
Section D2 DRAINAGE 2016-1
Routes FAI 74/280 & FAI 88
District 2 Construction Funds**



Illinois Department of Transportation

SUBCONTRACTOR DOCUMENTATION

Public Acts 96-0795, 96-0920, and 97-0895 enacted substantial changes to the provisions of the Code (30 ILCS 500). Among the changes are provisions affecting subcontractors. The Contractor awarded this contract will be required as a material condition of the contract to implement and enforce the contract requirements applicable to subcontractors that entered into a contractual agreement with a total value of \$50,000 or more with a person or entity who has a contract subject to the Code and approved in accordance with article 108.01 of the Standard Specifications for Road and Bridge Construction.

If the Contractor seeks approval of subcontractors to perform a portion of the work, and approval is granted by the Department, the Contractor shall provide a copy of the subcontract to the Illinois Department of Transportation's CPO upon request within 15 calendar days after execution of the subcontract.

Financial disclosures required pursuant to Sec. 50-35 of the Code must be submitted for all applicable subcontractors. The subcontract shall contain the certifications required to be made by subcontractors pursuant to Article 50 of the Code. This Notice to Bidders includes a document incorporating all required subcontractor certifications and disclosures for use by the Contractor in compliance with this mandate. The document is entitled State Required Ethical Standards Governing Subcontractors.

RETURN WITH SUBCONTRACT

STATE ETHICAL STANDARDS GOVERNING SUBCONTRACTORS

Article 50 of the Code establishes the duty of all State CPOs, SPOs, and their designees to maximize the value of the expenditure of public moneys in procuring goods, services, and contracts for the State of Illinois and to act in a manner that maintains the integrity and public trust of State government. In discharging this duty, they are charged by law to use all available information, reasonable efforts, and reasonable actions to protect, safeguard, and maintain the procurement process of the State of Illinois.

The certifications hereinafter made by the subcontractor are each a material representation of fact upon which reliance is placed should the Department approve the subcontractor. The CPO may terminate or void the contract approval if it is later determined that the bidder or subcontractor rendered a false or erroneous certification. If a false certification is made by a subcontractor the contractor's submitted bid and the executed contract may not be declared void unless the contractor refuses to terminate the subcontract upon the State's request after a finding that the subcontractor's certification was false.

Section 50-2 of the Code provides that every person that has entered into a multi-year contract and every subcontractor with a multi-year subcontract shall certify, by July 1 of each fiscal year covered by the contract after the initial fiscal year, to the responsible CPO whether it continues to satisfy the requirements of Article 50 pertaining to the eligibility for a contract award. If a contractor or subcontractor is not able to truthfully certify that it continues to meet all requirements, it shall provide with its certification a detailed explanation of the circumstances leading to the change in certification status. A contractor or subcontractor that makes a false statement material to any given certification required under Article 50 is, in addition to any other penalties or consequences prescribed by law, subject to liability under the Whistleblower Reward and Protection Act for submission of a false claim.

A. Bribery

Section 50-5. Bribery.

(a) Prohibition. No person or business shall be awarded a contract or subcontract under this Code who:

(1) has been convicted under the laws of Illinois or any other state of bribery or attempting to bribe an officer or employee of the State of Illinois or any other state in that officer's or employee's official capacity; or

(2) has made an admission of guilt of that conduct that is a matter of record but has not been prosecuted for that conduct.

(b) Businesses. No business shall be barred from contracting with any unit of State or local government, or subcontracting under such a contract, as a result of a conviction under this Section of any employee or agent of the business if the employee or agent is no longer employed by the business and:

(1) the business has been finally adjudicated not guilty; or

(2) the business demonstrates to the governmental entity with which it seeks to contract, or which is signatory to the contract to which the subcontract relates, and that entity finds that the commission of the offense was not authorized, requested, commanded, or performed by a director, officer, or high managerial agent on behalf of the business as provided in paragraph (2) of subsection (a) of Section 5-4 of the Criminal Code of 2012.

(c) Conduct on behalf of business. For purposes of this Section, when an official, agent, or employee of a business committed the bribery or attempted bribery on behalf of the business and in accordance with the direction or authorization of a responsible official of the business, the business shall be chargeable with the conduct.

(d) Certification. Every bid submitted to and contract executed by the State, and every subcontract subject to Section 20-120 of the Code shall contain a certification by the contractor or the subcontractor, respectively, that the contractor or subcontractor is not barred from being awarded a contract or subcontract under this Section and acknowledges that the CPO may declare the related contract void if any certifications required by this Section are false. A contractor who makes a false statement, material to the certification, commits a Class 3 felony.

The contractor or subcontractor certifies that it is not barred from being awarded a contract under Section 50-5.

B. Felons

Section 50-10. Felons.

Unless otherwise provided, no person or business convicted of a felony shall do business with the State of Illinois or any State agency, or enter into a subcontract, from the date of conviction until 5 years after the date of completion of the sentence for that felony, unless no person held responsible by a prosecutorial office for the facts upon which the conviction was based continues to have any involvement with the business.

Certification. Every bid submitted to and contract executed by the State and every subcontract subject to Section 20-120 of the Code shall contain a certification by the bidder or contractor or subcontractor, respectively, that the bidder, contractor, or subcontractor is not barred from being awarded a contract or subcontract under this Section and acknowledges that the CPO may declare the related contract void if any of the certifications required by this Section are false.

RETURN WITH SUBCONTRACT

C. Debt Delinquency

Section 50-11 and 50-12. Debt Delinquency.

The contractor or bidder or subcontractor, respectively, certifies that it, or any affiliate, is not barred from being awarded a contract or subcontract under the Code. Section 50-11 prohibits a person from entering into a contract with a State agency, or entering into a subcontract, if it knows or should know that it, or any affiliate, is delinquent in the payment of any debt to the State as defined by the Debt Collection Board. Section 50-12 prohibits a person from entering into a contract with a State agency, or entering into a subcontract, if it, or any affiliate, has failed to collect and remit Illinois Use Tax on all sales of tangible personal property into the State of Illinois in accordance with the provisions of the Illinois Use Tax Act. The bidder or contractor or subcontractor, respectively, further acknowledges that the CPO may declare the related contract void if this certification is false or if the bidder, contractor, or subcontractor, or any affiliate, is determined to be delinquent in the payment of any debt to the State during the term of the contract.

D. Prohibited Bidders, Contractors and Subcontractors

Section 50-10.5 and 50-60(c). Prohibited bidders, contractors and subcontractors.

The bidder or contractor or subcontractor, respectively, certifies in accordance with 30 ILCS 500/50-10.5 that no officer, director, partner or other managerial agent of the contracting business has been convicted of a felony under the Sarbanes-Oxley Act of 2002 or a Class 3 or Class 2 felony under the Illinois Securities Law of 1953 or if in violation of Subsection (c) for a period of five years from the date of conviction. Every bid submitted to and contract executed by the State and every subcontract subject to Section 20-120 of the Code shall contain a certification by the bidder, contractor, or subcontractor, respectively, that the bidder, contractor, or subcontractor is not barred from being awarded a contract or subcontract under this Section and acknowledges that the CPO shall declare the related contract void if any of the certifications completed pursuant to this Section are false.

E. Section 42 of the Environmental Protection Act

The bidder or contractor or subcontractor, respectively, certifies in accordance with 30 ILCS 500/50-14 that the bidder, contractor, or subcontractor, is not barred from being awarded a contract or entering into a subcontract under this Section which prohibits the bidding on or entering into contracts with the State of Illinois or a State agency, or entering into any subcontract, that is subject to the Code by a person or business found by a court or the Pollution Control Board to have committed a willful or knowing violation of Section 42 of the Environmental Protection Act for a period of five years from the date of the order. The bidder or contractor or subcontractor, respectively, acknowledges that the CPO may declare the contract void if this certification is false.

The undersigned, on behalf of the subcontracting company, has read and understands the above certifications and makes the certifications as required by law.

_____ Name of Subcontracting Company		
_____ Authorized Officer	_____ Date	

RETURN WITH SUBCONTRACT
SUBCONTRACTOR DISCLOSURES

I. DISCLOSURES

A. The disclosures hereinafter made by the subcontractor are each a material representation of fact upon which reliance is placed. The subcontractor further certifies that the Department has received the disclosure forms for each subcontract.

The CPO may void the bid, contract, or subcontract, respectively, if it is later determined that the bidder or subcontractor rendered a false or erroneous disclosure. A contractor or subcontractor may be suspended or debarred for violations of the Code. Furthermore, the CPO may void the contract.

B. Financial Interests and Conflicts of Interest

1. Section 50-35 of the Code provides that all subcontracts with a total value of \$50,000 or more from subcontractors identified in Section 20-120 of the Code, shall be accompanied by disclosure of the financial interests of the subcontractor. This disclosed information for the subcontractor, will be maintained as public information subject to release by request pursuant to the Freedom of Information Act, filed with the Procurement Policy Board, and shall be incorporated as a material term of the Prime Contractor's contract. Furthermore, pursuant to this Section, the Procurement Policy Board may recommend to allow or void a contract or subcontract based on a potential conflict of interest.

The financial interests to be disclosed shall include ownership or distributive income share that is in excess of 5%, or an amount greater than 60% of the annual salary of the Governor, of the subcontracting entity or its parent entity, whichever is less, unless the subcontractor is a publicly traded entity subject to Federal 10K reporting, in which case it may submit its 10K disclosure in place of the prescribed disclosure. If a subcontractor is a privately held entity that is exempt from Federal 10K reporting, but has more than 100 shareholders, it may submit the information that Federal 10K companies are required to report, and list the names of any individual or entity holding any ownership share that is in excess of 5%. The disclosure shall include the names, addresses, and dollar or proportionate share of ownership of each individual making the disclosure, their instrument of ownership or beneficial relationship, and notice of any potential conflict of interest resulting from the current ownership or beneficial interest of each individual making the disclosure having any of the relationships identified in Section 50-35 and on the disclosure form.

The current annual salary of the Governor is \$177,412.00.

In addition, all disclosures shall indicate any other current or pending contracts, subcontracts, proposals, leases, or other ongoing procurement relationships the subcontracting entity has with any other unit of state government and shall clearly identify the unit and the contract, subcontract, proposal, lease, or other relationship.

2. Disclosure Forms. Disclosure Form A is attached for use concerning the individuals meeting the above ownership or distributive share requirements. A separate Disclosure Form A must be submitted with the bid for each individual meeting the above requirements. In addition, a second form (Disclosure Form B) provides for the disclosure of current or pending procurement relationships with other (non-IDOT) state agencies and a total ownership certification.

C. Disclosure Form Instructions

Form A Instructions for Financial Information & Potential Conflicts of Interest

If the subcontractor is a publicly traded entity subject to Federal 10K reporting, the 10K Report may be submitted to meet the requirements of Form A. If a subcontractor is a privately held entity that is exempt from Federal 10K reporting, but has more than 100 shareholders, it may submit the information that Federal 10K companies are required to report, and list the names of any individual or entity holding any ownership share that is in excess of 5%. If a subcontractor is not subject to Federal 10K reporting, the subcontractor must determine if any individuals are required by law to complete a financial disclosure form. To do this, the subcontractor should answer each of the following questions. A "YES" answer indicates Form A must be completed. If the answer to each of the following questions is "NO", then the NOT APPLICABLE STATEMENT on the second page of Form A must be signed and dated by an individual that is authorized to execute contracts for the subcontracting company. Note: These questions are for assistance only and are not required to be completed.

1. Does anyone in your organization have a direct or beneficial ownership share of greater than 5% of the bidding entity or parent entity? YES ___ NO ___
2. Does anyone in your organization have a direct or beneficial ownership share of less than 5%, but which has a value greater than 60% of the annual salary of the Governor? YES ___ NO ___
3. Does anyone in your organization receive more than 60% of the annual salary of the Governor of the subcontracting entity's or parent entity's distributive income? YES ___ NO ___

(Note: Distributive income is, for these purposes, any type of distribution of profits. An annual salary is not distributive income.)

4. Does anyone in your organization receive greater than 5% of the subcontracting entity's or parent entity's total distributive income, but which is less than 60% of the annual salary of the Governor? YES ___ NO ___

(Note: Only one set of forms needs to be completed per individual per subcontract even if a specific individual would require a yes answer to more than one question.)

A "YES" answer to any of these questions requires the completion of Form A. The subcontractor must determine each individual in the subcontracting entity or the subcontracting entity's parent company that would cause the questions to be answered "Yes". Each form must be signed and dated by an individual that is authorized to execute contracts for your organization. The individual signing can be, but does not have to be, the individual for which the form is being completed. The subcontractor is responsible for the accuracy of any information provided.

If the answer to each of the above questions is "NO", then the NOT APPLICABLE STATEMENT on page 2 of Form A must be signed and dated by an individual that is authorized to execute contracts for your company.

RETURN WITH SUBCONTRACT

Form B: Instructions for Identifying Other Contracts & Procurement Related Information

Disclosure Form B must be completed for each subcontract submitted by the subcontracting entity. *Note: Checking the NOT APPLICABLE STATEMENT on Form A does not allow the subcontractor to ignore Form B. Form B must be completed, checked, and dated or the subcontract will not be approved.*

The Subcontractor shall identify, by checking Yes or No on Form B, whether it has any pending contracts, subcontracts, leases, bids, proposals, or other ongoing procurement relationship with any other (non-IDOT) State of Illinois agency. If "No" is checked, the subcontractor only needs to complete the check box on the bottom of Form B. If "Yes" is checked, the subcontractor must list all non-IDOT State of Illinois agency pending contracts, subcontracts, leases, bids, proposals, and other ongoing procurement relationships. These items may be listed on Form B or on an attached sheet(s). Contracts with cities, counties, villages, etc. are not considered State of Illinois agency contracts and are not to be included. Contracts or subcontracts with other State of Illinois agencies such as the Department of Natural Resources or the Capital Development Board must be included.

RETURN WITH SUBCONTRACT

**ILLINOIS DEPARTMENT
OF TRANSPORTATION**

**Form A
Subcontractor: Financial
Information & Potential Conflicts
of Interest Disclosure**

Subcontractor Name		
Legal Address		
City, State, Zip		
Telephone Number	Email Address	Fax Number (if available)

Disclosure of the information contained in this Form is required by Section 50-35 of the Code (30 ILCS 500). Subcontractors desiring to enter into a subcontract of a State of Illinois contract must disclose the financial information and potential conflict of interest information as specified in this Disclosure Form. This information shall become part of the publicly available contract file. This Form A must be completed for subcontracts with a total value of \$50,000 or more, from subcontractors identified in Section 20-120 of the Code, and for all open-ended contracts. **A publicly traded company may submit a 10K disclosure (or equivalent if applicable) in satisfaction of the requirements set forth in Form A. See Disclosure Form Instructions.**

The current annual salary of the Governor is \$177,412.00.

DISCLOSURE OF FINANCIAL INFORMATION

1. Disclosure of Financial Information. The individual named below has an interest in the SUBCONTRACTOR (or its parent) in terms of ownership or distributive income share in excess of 5%, or an interest which has a value of more than 60% of the annual salary of the Governor. **(Make copies of this form as necessary and attach a separate Disclosure Form A for each individual meeting these requirements)**

FOR INDIVIDUAL (type or print information)	
NAME:	_____
ADDRESS	_____
Type of ownership/distributable income share:	
stock _____ sole proprietorship _____ Partnership _____ other: (explain on separate sheet):	
% or \$ value of ownership/distributable income share:	_____

2. Disclosure of Potential Conflicts of Interest. Check "Yes" or "No" to indicate which, if any, of the following potential conflict of interest relationships apply. If the answer to any question is "Yes", please attach additional pages and describe.

(a) State employment, currently or in the previous 3 years, including contractual employment of services.

Yes ___ No ___

If your answer is yes, please answer each of the following questions.

1. Are you currently an officer or employee of either the Capitol Development Board or the Illinois State Toll Highway Authority? Yes ___ No ___

2. Are you currently appointed to or employed by any agency of the State of Illinois? If you are currently appointed to or employed by any agency of the State of Illinois, and your annual salary exceeds 60% of the annual salary of the Governor, provide the name the State agency for which you are employed and your annual salary. _____

RETURN WITH SUBCONTRACT

3. If you are currently appointed to or employed by any agency of the State of Illinois, and your annual salary exceeds 60% of the annual salary of the Governor, are you entitled to receive (i) more than 7 1/2% of the total distributable income of your firm, partnership, association or corporation, or (ii) an amount in excess of 100% of the annual salary of the Governor?
Yes ___ No ___

4. If you are currently appointed to or employed by any agency of the State of Illinois, and your annual salary exceeds 60% of the annual salary of the Governor, are you and your spouse or minor children entitled to receive (i) more than 15 % in the aggregate of the total distributable income of your firm, partnership, association or corporation, or (ii) an amount in excess of two times the salary of the Governor?
Yes ___ No ___

(b) State employment of spouse, father, mother, son, or daughter, including contractual employment services in the previous 2 years.

Yes ___ No ___

If your answer is yes, please answer each of the following questions.

1. Is your spouse or any minor children currently an officer or employee of the Capitol Development Board or the Illinois Toll Highway Authority?
Yes ___ No ___

2. Is your spouse or any minor children currently appointed to or employed by any agency of the State of Illinois? If your spouse or minor children is/are currently appointed to or employed by any agency of the State of Illinois, and his/her annual salary exceeds 60% of the annual salary of the Governor, provide the name of your spouse and/or minor children, the name of the State agency for which he/she is employed and his/her annual salary. _____

3. If your spouse or any minor children is/are currently appointed to or employed by any agency of the State of Illinois, and his/her annual salary exceeds 60% of the annual salary of the Governor, as of 7/1/07) are you entitled to receive (i) more then 7 1/2% of the total distributable income of your firm, partnership, association or corporation, or (ii) an amount in excess of 100% of the annual salary of the Governor?
Yes ___ No ___

4. If your spouse or any minor children are currently appointed to or employed by any agency of the State of Illinois, and his/her annual salary exceeds 60% of the annual salary of the Governor, are you and your spouse or minor children entitled to receive (i) more than 15 % in the aggregate of the total distributable income of your firm, partnership, association or corporation, or (ii) an amount in excess of two times the annual salary of the Governor?
Yes ___ No ___

(c) Elective status; the holding of elective office of the State of Illinois, the government of the United States, any unit of local government authorized by the Constitution of the State of Illinois or the statutes of the State of Illinois currently or in the previous 3 years.
Yes ___ No ___

(d) Relationship to anyone holding elective office currently or in the previous 2 years; spouse, father, mother, son, or daughter.
Yes ___ No ___

(e) Appointive office; the holding of any appointive government office of the State of Illinois, the United States of America, or any unit of local government authorized by the Constitution of the State of Illinois or the statutes of the State of Illinois, which office entitles the holder to compensation in excess of the expenses incurred in the discharge of that office currently or in the previous 3 years.
Yes ___ No ___

(f) Relationship to anyone holding appointive office currently or in the previous 2 years; spouse, father, mother, son, or daughter.
Yes ___ No ___

(g) Employment, currently or in the previous 3 years, as or by any registered lobbyist of the State government.
Yes ___ No ___

RETURN WITH SUBCONTRACT

(h) Relationship to anyone who is or was a registered lobbyist in the previous 2 years; spouse, father, mother, son, or daughter. Yes ___ No ___

(i) Compensated employment, currently or in the previous 3 years, by any registered election or reelection committee registered with the Secretary of State or any county clerk of the State of Illinois, or any political action committee registered with either the Secretary of State or the Federal Board of Elections. Yes ___ No ___

(j) Relationship to anyone; spouse, father, mother, son, or daughter; who was a compensated employee in the last 2 years by any registered election or re-election committee registered with the Secretary of State or any county clerk of the State of Illinois, or any political action committee registered with either the Secretary of State or the Federal Board of Elections. Yes ___ No ___

3 Communication Disclosure.

Disclose the name and address of each lobbyist and other agent of the bidder or offeror who is not identified in Section 2 of this form, who is has communicated, is communicating, or may communicate with any State officer or employee concerning the bid or offer. This disclosure is a continuing obligation and must be promptly supplemented for accuracy throughout the process and throughout the term of the contract. If no person is identified, enter "None" on the line below:

Name and address of person(s): _____

RETURN WITH SUBCONTRACT

4. Suspension or Debarment Disclosure. For each of the persons identified under Sections 2 and 3 of this form, disclose whether any of the following has occurred within the previous 10 years: suspension or debarment from contracting with any governmental entity; professional licensure discipline; bankruptcies; adverse civil judgments and administrative findings; and criminal felony convictions. This disclosure is a continuing obligation and must be promptly supplemented for accuracy throughout the procurement process and term of the contract. If no person is identified, enter "None" on the line below:

Name of person(s): _____

Nature of disclosure: _____

APPLICABLE STATEMENT

This Disclosure Form A is submitted on behalf of the INDIVIDUAL named on previous page. Under penalty of perjury, I certify the contents of this disclosure to be true and accurate to the best of my knowledge.

Completed by: _____ Date _____
Signature of Individual or Authorized Officer

NOT APPLICABLE STATEMENT

Under penalty of perjury, I have determined that no individuals associated with this organization meet the criteria that would require the completion of this Form A.

This Disclosure Form A is submitted on behalf of the SUBCONTRACTOR listed on the previous page.

_____ Date _____
Signature of Authorized Officer

RETURN WITH SUBCONTRACT

ILLINOIS DEPARTMENT OF TRANSPORTATION

Form B
Subcontractor: Other Contracts & Financial Related Information Disclosure

Form with fields: Subcontractor Name, Legal Address, City, State, Zip, Telephone Number, Email Address, Fax Number (if available)

Disclosure of the information contained in this Form is required by Section 50-35 of the Code (30 ILCS 500). This information shall become part of the publicly available contract file. This Form B must be completed for subcontracts with a total value of \$50,000 or more, from subcontractors identified in Section 20-120 of the Code, and for all open-ended contracts.

DISCLOSURE OF OTHER CONTRACTS, SUBCONTRACTS, AND PROCUREMENT RELATED INFORMATION

1. Identifying Other Contracts & Procurement Related Information. The SUBCONTRACTOR shall identify whether it has any pending contracts, subcontracts, including leases, bids, proposals, or other ongoing procurement relationship with any other State of Illinois agency: Yes ___ No ___

If "No" is checked, the subcontractor only needs to complete the signature box on this page.

2. If "Yes" is checked. Identify each such relationship by showing State of Illinois agency name and other descriptive information such as bid or project number (attach additional pages as necessary). SEE DISCLOSURE FORM INSTRUCTIONS:

THE FOLLOWING STATEMENT MUST BE CHECKED

Signature box with fields: Signature of Authorized Representative, Date

OWNERSHIP CERTIFICATION

Please certify that the following statement is true if the individuals for all submitted Form A disclosures do not total 100% of ownership

Any remaining ownership interest is held by individuals receiving less than \$106,447.20 of the bidding entity's or parent entity's distributive income or holding less than a 5% ownership interest.

Yes No N/A (Form A disclosure(s) established 100% ownership)



NOTICE TO BIDDERS

1. TIME AND PLACE OF OPENING BIDS. Sealed proposals for the improvement described herein will be received by the Department of Transportation. Electronic bids are to be submitted to the electronic bidding system (iCX-Integrated Contractors Exchange). Paper-based bids are to be submitted to the Chief Procurement Officer for the Department of Transportation in care of the Chief Contracts Official at the Harry R. Hanley Building, 2300 South Dirksen Parkway, in Springfield, Illinois until 10:00 a.m. March 4, 2016. All bids will be gathered, sorted, publicly opened and read in the auditorium at the Department of Transportation's Harry R. Hanley Building shortly after 10:00 a.m.

2. DESCRIPTION OF WORK. The proposed improvement is identified and advertised for bids in the Invitation for Bids as:

**Contract No. 64L02
WHITESIDE-HENRY Counties
Section D2 DRAINAGE 2016-1
Routes FAI 74/280 & FAI 88
District 2 Construction Funds**

This project consists of culvert repairs on I-74/280 located approximately 1.2 miles west of the I-80 interchange and on I-88 approximately 1.7 miles west of IL 78.

3. INSTRUCTIONS TO BIDDERS. (a) This Notice, the invitation for bids, proposal and letter of award shall, together with all other documents in accordance with Article 101.09 of the Standard Specifications for Road and Bridge Construction, become part of the contract. Bidders are cautioned to read and examine carefully all documents, to make all required inspections, and to inquire or seek explanation of the same prior to submission of a bid.

(b) State law, and, if the work is to be paid wholly or in part with Federal-aid funds, Federal law requires the bidder to make various certifications as a part of the proposal and contract. By execution and submission of the proposal, the bidder makes the certification contained therein. A false or fraudulent certification shall, in addition to all other remedies provided by law, be a breach of contract and may result in termination of the contract.

4. AWARD CRITERIA AND REJECTION OF BIDS. This contract will be awarded to the lowest responsive and responsible bidder considering conformity with the terms and conditions established by the Department in the rules, Invitation for Bids and contract documents. The issuance of plans and proposal forms for bidding based upon a prequalification rating shall not be the sole determinant of responsibility. The Department reserves the right to determine responsibility at the time of award, to reject any or all proposals, to readvertise the proposed improvement, and to waive technicalities.

By Order of the
Illinois Department of Transportation

Randall S. Blankenhorn,
Secretary

INDEX
FOR
SUPPLEMENTAL SPECIFICATIONS
AND RECURRING SPECIAL PROVISIONS

Adopted January 1, 2015

This index contains a listing of SUPPLEMENTAL SPECIFICATIONS, frequently used RECURRING SPECIAL PROVISIONS, and LOCAL ROADS AND STREETS RECURRING SPECIAL PROVISIONS.

ERRATA Standard Specifications for Road and Bridge Construction (Adopted 1-1-12) (Revised 1-1-15)

SUPPLEMENTAL SPECIFICATIONS

<u>Std. Spec. Sec.</u>	<u>Page No.</u>
101 Definition of Terms	1
102 Advertisement, Bidding, Award, and Contract Execution	2
105 Control of Work	3
106 Control of Materials	5
107 Legal Regulations and Responsibility to Public	6
108 Prosecution and Progress	14
109 Measurement and Payment	15
202 Earth and Rock Excavation	17
211 Topsoil and Compost	19
250 Seeding	20
253 Planting Woody Plants	21
280 Temporary Erosion and Sediment Control	23
312 Stabilized Subbase	24
406 Hot-Mix Asphalt Binder and Surface Course	25
407 Hot-Mix Asphalt Pavement (Full-Depth)	28
420 Portland Cement Concrete Pavement	32
424 Portland Cement Concrete Sidewalk	34
440 Removal of Existing Pavement and Appurtenances	35
502 Excavation for Structures	36
503 Concrete Structures	37
504 Precast Concrete Structures	40
506 Cleaning and Painting New Steel Structures	41
512 Piling	42
516 Drilled Shafts	43
521 Bearings	44
540 Box Culverts	45
588 Bridge Relief Joint System	46
589 Elastic Joint Sealer	48
602 Catch Basin, Manhole, Inlet, Drainage Structure, and Valve Vault Construction, Adjustment, and Reconstruction	49
603 Adjusting Frames and Grates of Drainage and Utility Structures	50
606 Concrete Gutter, Curb, Median, and Paved Ditch	52
610 Shoulder Inlets with Curb	53
639 Precast Prestressed Concrete Sight Screen	54
642 Shoulder Rumble Strips	55
643 Impact Attenuators	56
644 High Tension Cable Median Barrier	58
669 Removal and Disposal of Regulated Substances	60
670 Engineer's Field Office and Laboratory	64
701 Work Zone Traffic Control and Protection	65
706 Impact Attenuators, Temporary	68
707 Movable Traffic Barrier	71
708 Temporary Water Filled Barrier	73
730 Wood Sign Support	75
780 Pavement Striping	76
816 Unit Duct	81
836 Pole Foundation	82
860 Master Controller	83

FAI Route 74/280 & FAI Route 88 (I-74/280 & I-88)
Section D2 DRAINAGE 2016-1
Henry & Whiteside Counties
Contract No. 64L02

1001	Cement	84
1003	Fine Aggregates	85
1004	Coarse Aggregates	87
1006	Metals	91
1011	Mineral Filler	93
1017	Packaged, Dry, Combined Materials for Mortar	94
1018	Packaged Rapid Hardening Mortar or Concrete	95
1019	Controlled Low-Strength Material (CLSM)	96
1020	Portland Cement Concrete	97
1024	Grout and Nonshrink Grout	136
1030	Hot-Mix Asphalt	137
1040	Drain Pipe, Tile, Drainage Mat, and Wall Drain	142
1042	Precast Concrete Products	143
1069	Pole and Tower	144
1070	Foundation and Breakaway Devices	145
1073	Controller	146
1081	Materials for Planting	147
1082	Preformed Bearing Pads	148
1083	Elastomeric Bearings	149
1088	Wireway and Conduit System	150
1095	Pavement Markings	152
1101	General Equipment	155
1102	Hot-Mix Asphalt Equipment	157
1103	Portland Cement Concrete Equipment	159
1105	Pavement Marking Equipment	160
1106	Work Zone Traffic Control Devices	161

RECURRING SPECIAL PROVISIONS

The following RECURRING SPECIAL PROVISIONS indicated by an "X" are applicable to this contract and are included by reference:

<u>CHECK SHEET #</u>	<u>PAGE NO.</u>
1	163
2	166
3 X	167
4 X	177
5 X	182
6	188
7	189
8	190
9	191
10	194
11	197
12	199
13	203
14	205
15	206
16	207
17	208
18	210
19	211
20	212
21	216
22	218
23	219
24	221
25	222
26	223
27	224
28	225
29	226
30	227
31 X	235
32	251
33	253
34	254
35	260
36	275
37	286
38	296
39	297

TABLE OF CONTENTS

LOCATION OF PROJECT	1
DESCRIPTION OF PROJECT	1
TRAFFIC CONTROL PLAN	1
FURNISHED EXCAVATION	3
CONCRETE MIX DESIGN – DEPARTMENT PROVIDED (BDE)	3
CONTRACT CLAIMS (BDE)	4
DISADVANTAGED BUSINESS ENTERPRISE PARTICIPATION (BDE)	5
EQUAL EMPLOYMENT OPPORTUNITY (BDE)	16
LRFD PIPE CULVERT BURIAL TABLES (BDE)	19
PAVEMENT PATCHING (BDE)	38
PROGRESS PAYMENTS (BDE)	38
REINFORCEMENT BARS (BDE)	39
SIDEWALK, CORNER, OR CROSSWALK CLOSURE (BDE)	40
SPEED DISPLAY TRAILER (BDE)	41
TRACKING THE USE OF PESTICIDES (BDE)	42
WEEKLY DBE TRUCKING REPORTS (BDE)	42
WORKING DAYS (BDE)	42
VETERAN BUSINESS PROGRAM	43

STATE OF ILLINOIS

SPECIAL PROVISIONS

The following Special Provisions supplement the "Standard Specifications for Road and Bridge Construction, Adopted January 1, 2012", the latest edition of the "Manual on Uniform Traffic Control Devices for Streets and Highways", and the "Manual of Test Procedures for Materials" in effect on the date of invitation for bids, and the "Supplemental Specifications and Recurring Special Provisions" indicated on the Check Sheet included herein, which apply to and govern the construction of FAI Route 74/280 & FAI Route 88 (I-74/280 & I-88), Section D2 DRAINAGE 2016-1, Henry & Whiteside Counties, Contract No. 64L02 and in case of conflict with any part, or parts, of said Specifications, the said Special Provisions shall take precedence and shall govern.

LOCATION OF PROJECT

I-74/280, 1.2 miles west of the I-80 interchange and I-88, 1.7 miles west of IL 78.

DESCRIPTION OF PROJECT

Culvert repairs.

TRAFFIC CONTROL PLAN

Effective: January 14, 1999

Revised: July 22, 2015

Traffic Control shall be according to the applicable sections of the Standard Specifications for Road and Bridge Construction, the applicable guidelines contained in the National Manual on Uniform Traffic Control Devices for Streets and Highways, Illinois Supplement to the National Manual on Uniform Traffic Control Devices, these special provisions, and any special details and Highway Standards contained herein and in the plans.

Special attention is called to Articles 107.09 and 107.14 of the Standard Specifications for Road and Bridge Construction and the following Highway Standards relating to traffic control.

Standards:

701101 701106 701400 701401 701406 701901

Signs:

No bracing shall be allowed on post-mounted signs.

Post-mounted signs shall be installed using standard 720011, 728001, 729001, on 4"x4" wood posts, or on any other "break away" connection if accepted by the FHWA and corresponding letter is provided to the resident.

All signs are required on both sides of the road when the median is greater than 10 feet and on one way roadways.

The "WORKERS" (W21-1a(O)-48) signs shall be replaced with symbol "Right or Left Lane Closed Ahead" (W4-2R or L(O)-48) signs on multilane roadways.

When covering existing Department signs, no tape shall be used on the reflective portion of the sign. Contact the District sign shop for covering techniques.

All regulatory signs shall be maintained at a 5 foot minimum bottom (rural), 7 foot minimum (urban).

Plate altering signs shall have the same sheeting as the base sign.

No more than one plate shall be used to alter a sign.

Any post stubs without a sign in place and visible shall have a reflector placed on each post.

Devices:

Cones or reflectorized cones shall not be used during hours of darkness.

On all standards and devices listed in Section 701 of the Standard Specifications, the device spacing shall be revised to the following dimensions:

- Where the spacing shown on the standard is 25 feet, the devices shall be placed at 20 feet.
- Where the spacing shown on the standard is 50 feet, the devices shall be placed at 40 feet.
- Where the spacing shown on the standard is 100 feet, the devices shall be placed at 80 feet.

Direction Indicator Barricades shall exclusively be used in lane closure tapers. The backside of the direction indicator barricades shall be striped like a type II barricade when opposing traffic is within 12 feet of the device. The taper shall be continuous. It shall not be broken for access to turn lanes, side roads, ramps, or large commercial driveways. The taper shall be moved further away and shall be completed prior to the access point.

Vertical barricades shall not be used as a device where the existing speed limit is 65 mph or greater.

Traffic Control and Protection Standards 701401 and 701422: This work shall be done according to Standard 701401 and Section 701 of the Standard Specifications. The Contractor shall be required to install the 701401 two (2) calendar days in advance of the areas to be patched for the protection of the State personnel laying out the locations for pavement patching.

The barricades as shown in Standard 701401 and 701422 shall not encroach on the lane open to traffic at any time.

This work shall be included in the contract unit price per Lump Sum for TRAFFIC CONTROL AND PROTECTION STANDARD 701401.

Interstates and multi-lane divided highways where the existing speed is greater than 45 mph:
The Contractor shall equip all machinery and vehicles with flashing amber lights, installed so the illumination is visible from all directions.

The median crossover will generally not be available for Contractor use. It may be used only when both lanes adjacent to the median are closed. Under no condition shall left turn lanes be made to cross the median from lanes open to traffic. Where interchanges are not available, the Contractor shall only be allowed to turn around where left turn lanes are present.

Parking of personal vehicles within the right-of-way will be strictly prohibited. Parking of construction equipment within the right-of-way will be permitted only at locations approved by the Engineer.

Maintenance of Traffic:

The Contractor shall have all lanes open from 6:00 PM Friday until 6:00 AM Monday, unless prior approval is obtained from the Resident Engineer.

Traffic shall be maintained using Traffic Control and Protection Standard 701401.

FURNISHED EXCAVATION

Effective: July 1, 1994

Revised: October 28, 2010

The Furnished Excavation shall be measured by the truck load method. Prior to the start of work the Contractor and the Engineer shall agree to standard volume for the trucks utilized by the Contractor.

Suitable excavated materials from the project shall not be wasted without permission of the Engineer. Embankment and mechanical compaction will not be measured for payment.

This work shall be paid for at the contract unit price per Cubic Yard for FURNISHED EXCAVATION.

CONCRETE MIX DESIGN – DEPARTMENT PROVIDED (BDE)

Effective: January 1, 2012

Revised: January 1, 2014

For the concrete mix design requirements in Article 1020.05(a) of the Supplemental Specifications and Recurring Special Provisions, the Contractor has the option to request the Engineer determine mix design material proportions for Class PV, PP, RR, BS, DS, SC, and SI concrete. A single mix design for each class of concrete will be provided. Acceptance by the Contractor to use the mix design developed by the Engineer shall not relieve the Contractor from meeting specification requirements.

CONTRACT CLAIMS (BDE)

Effective: April 1, 2014

Revise the first paragraph of Article 109.09(a) of the Standard Specifications to read:

“(a) Submission of Claim. All claims filed by the Contractor shall be in writing and in sufficient detail to enable the Department to ascertain the basis and amount of the claim. As a minimum, the following information must accompany each claim submitted.”

Revise Article 109.09(e) of the Standard Specifications to read:

“(e) Procedure. The Department provides two administrative levels for claims review.

- Level I Engineer of Construction
- Level II Chief Engineer/Director of Highways or Designee

- (1) Level I. All claims shall first be submitted at Level I. Two copies each of the claim and supporting documentation shall be submitted simultaneously to the District and the Engineer of Construction. The Engineer of Construction, in consultation with the District, will consider all information submitted with the claim and render a decision on the claim within 90 days after receipt by the Engineer of Construction. Claims not conforming to this Article will be returned without consideration. The Engineer of Construction may schedule a claim presentation meeting if in the Engineer of Construction’s judgment such a meeting would aid in resolution of the claim, otherwise a decision will be made based on the claim documentation submitted. If a Level I decision is not rendered within 90 days of receipt of the claim, or if the Contractor disputes the decision, an appeal to Level II may be made by the Contractor.
- (2) Level II. An appeal to Level II shall be made in writing to the Engineer of Construction within 45 days after the date of the Level I decision. Review of the claim at Level II shall be conducted as a full evaluation of the claim. A claim presentation meeting may be scheduled if the Chief Engineer/Director of Highways determines that such a meeting would aid in resolution of the claim, otherwise a decision will be made based on the claim documentation submitted. A Level II final decision will be rendered within 90 days of receipt of the written request for appeal.

Full compliance by the Contractor with the provisions specified in this Article is a contractual condition precedent to the Contractor’s right to seek relief in the Court of Claims. The Director’s written decision shall be the final administrative action of the Department. Unless the Contractor files a claim for adjudication by the Court of Claims within 60 days after the date of the written decision, the failure to file shall constitute a release and waiver of the claim.”

DISADVANTAGED BUSINESS ENTERPRISE PARTICIPATION (DBE)

Effective: September 1, 2000

Revised: January 2, 2016

FEDERAL OBLIGATION. The Department of Transportation, as a recipient of federal financial assistance, is required to take all necessary and reasonable steps to ensure nondiscrimination in the award and administration of contracts. Consequently, the federal regulatory provisions of 49 CFR Part 26 apply to this contract concerning the utilization of disadvantaged business enterprises. For the purposes of this Special Provision, a disadvantaged business enterprise (DBE) means a business certified by the Department in accordance with the requirements of 49 CFR Part 26 and listed in the Illinois Unified Certification Program (IL UCP) DBE Directory.

STATE OBLIGATION. This Special Provision will also be used by the Department to satisfy the requirements of the Business Enterprise for Minorities, Females, and Persons with Disabilities Act, 30 ILCS 575. When this Special Provision is used to satisfy state law requirements on 100 percent state-funded contracts, the federal government has no involvement in such contracts (not a federal-aid contract) and no responsibility to oversee the implementation of this Special Provision by the Department on those contracts. DBE participation on 100 percent state-funded contracts will not be credited toward fulfilling the Department's annual overall DBE goal required by the US Department of Transportation to comply with the federal DBE program requirements.

CONTRACTOR ASSURANCE. The Contractor makes the following assurance and agrees to include the assurance in each subcontract that the Contractor signs with a subcontractor.

The Contractor, subrecipient, or subcontractor shall not discriminate on the basis of race, color, national origin, or sex in the performance of this contract. The Contractor shall carry out applicable requirements of 49 CFR Part 26 in the award and administration of contracts funded in whole or in part with federal or state funds. Failure by the Contractor to carry out these requirements is a material breach of this contract, which may result in the termination of this contract or such other remedy as the recipient deems appropriate, which may include, but is not limited to:

- (a) Withholding progress payments;
- (b) Assessing sanctions;
- (c) Liquidated damages; and/or
- (d) Disqualifying the Contractor from future bidding as non-responsible.

OVERALL GOAL SET FOR THE DEPARTMENT. As a requirement of compliance with 49 CFR Part 26, the Department has set an overall goal for DBE participation in its federally assisted contracts. That goal applies to all federal-aid funds the Department will expend in its federally assisted contracts for the subject reporting fiscal year. The Department is required to make a good faith effort to achieve the overall goal. The dollar amount paid to all approved DBE companies performing work called for in this contract is eligible to be credited toward fulfillment of the Department's overall goal.

CONTRACT GOAL TO BE ACHIEVED BY THE CONTRACTOR. This contract includes a specific DBE utilization goal established by the Department. The goal has been included because the Department has determined that the work of this contract has subcontracting opportunities that may be suitable for performance by DBE companies. The determination is based on an assessment of the type of work, the location of the work, and the availability of DBE companies to do a part of the work. The assessment indicates that, in the absence of unlawful discrimination, and in an arena of fair and open competition, DBE companies can be expected to perform **0.00%** of the work. This percentage is set as the DBE participation goal for this contract. Consequently, in addition to the other award criteria established for this contract, the Department will only award this contract to a bidder who makes a good faith effort to meet this goal of DBE participation in the performance of the work. A bidder makes a good faith effort for award consideration if either of the following is done in accordance with the procedures set for in this Special Provision:

- (a) The bidder documents that enough DBE participation has been obtained to meet the goal or,
- (b) The bidder documents that a good faith effort has been made to meet the goal, even though the effort did not succeed in obtaining enough DBE participation to meet the goal.

DBE LOCATOR REFERENCES. Bidders shall consult the IL UCP DBE Directory as a reference source for DBE-certified companies. In addition, the Department maintains a letting and item specific DBE locator information system whereby DBE companies can register their interest in providing quotes on particular bid items advertised for letting. Information concerning DBE companies willing to quote work for particular contracts may be obtained by contacting the Department's Bureau of Small Business Enterprises at telephone number (217) 785-4611, or by visiting the Department's website at:
<http://www.idot.illinois.gov/doing-business/certifications/disadvantaged-business-enterprise-certification/il-ucp-directory/index>.

BIDDING PROCEDURES. Compliance with this Special Provision is required prior to the award of the contract and the failure of the low bidder to comply will render the bid not responsive.

In order to assure the timely award of the contract, the low bidder shall submit:

- (a) The bidder shall submit a Disadvantaged Business Utilization Plan on completed Department forms SBE 2025 and 2026.
 - (1) The final Utilization Plan must be submitted within five calendar days after the date of the letting.
 - (2) To meet the five day requirement, the bidder may send the Utilization Plan electronically by scanning and sending to **DOT.DBE.UP@illinois.gov** or faxing to (217) 785-1524. The subject line must include the bid Item Number and the Letting date. The Utilization Plan should be sent as one .pdf file, rather than multiple files and emails for the same Item Number. It is the responsibility of the bidder to obtain confirmation of email or fax delivery.

Alternatively, the Utilization Plan may be sent by certified mail or delivery service within the five calendar day period. If a question arises concerning the mailing date of a Utilization Plan, the mailing date will be established by the U.S. Postal Service postmark on the original certified mail receipt from the U.S. Postal Service or the receipt issued by a delivery service. It is the responsibility of the bidder to ensure the postmark or receipt date is affixed within the five days if the bidder intends to rely upon mailing or delivery to satisfy the submission day requirement. The Utilization Plan is to be submitted to:

Illinois Department of Transportation
Bureau of Small Business Enterprises
Contract Compliance Section
2300 South Dirksen Parkway, Room 319
Springfield, Illinois 62764

The Department will not accept a Utilization Plan if it does not meet the five day submittal requirement and the bid will be declared not responsive. In the event the bid is declared not responsive due to a failure to submit a Utilization Plan or failure to comply with the bidding procedures set forth herein, the Department may elect to cause the forfeiture of the penal sum of the bidder's proposal guaranty, and may deny authorization to bid the project if re-advertised for bids. The Department reserves the right to invite any other bidder to submit a Utilization Plan at any time for award consideration or to extend the time for award.

- (b) The Utilization Plan shall indicate that the bidder either has obtained sufficient DBE participation commitments to meet the contract goal or has not obtained enough DBE participation commitments in spite of a good faith effort to meet the goal. The Utilization Plan shall further provide the name, telephone number, and telefax number of a responsible official of the bidder designated for purposes of notification of Utilization Plan approval or disapproval under the procedures of this Special Provision.
- (c) The Utilization Plan shall include a DBE Participation Commitment Statement, Department form SBE 2025, for each DBE proposed for the performance of work to achieve the contract goal. For bidding purposes, submission of the completed SBE 2025 forms, signed by the DBEs and scanned or faxed to the bidder will be acceptable as long as the original is available and provided upon request. All elements of information indicated on the said form shall be provided, including but not limited to the following:
 - (1) The names and addresses of DBE firms that will participate in the contract;
 - (2) A description, including pay item numbers, of the work each DBE will perform;
 - (3) The dollar amount of the participation of each DBE firm participating. The dollar amount of participation for identified work shall specifically state the quantity, unit price, and total subcontract price for the work to be completed by the DBE. If partial pay items are to be performed by the DBE, indicate the portion of each item, a unit price where appropriate and the subcontract price amount;

- (4) DBE Participation Commitment Statements, form SBE 2025, signed by the bidder and each participating DBE firm documenting the commitment to use the DBE subcontractors whose participation is submitted to meet the contract goal;
- (5) If the bidder is a joint venture comprised of DBE companies and non-DBE companies, the Utilization Plan must also include a clear identification of the portion of the work to be performed by the DBE partner(s); and,
- (6) If the contract goal is not met, evidence of good faith efforts; the documentation of good faith efforts must include copies of each DBE and non-DBE subcontractor quote submitted to the bidder when a non-DBE subcontractor is selected over a DBE for work on the contract.

GOOD FAITH EFFORT PROCEDURES. The contract will not be awarded until the Utilization Plan submitted by the apparent successful bidder is approved. All information submitted by the bidder must be complete, accurate and adequately document that enough DBE participation has been obtained or document that good faith efforts of the bidder, in the event enough DBE participation has not been obtained, before the Department will commit to the performance of the contract by the bidder. The Utilization Plan will be approved by the Department if the Utilization Plan documents sufficient commercially useful DBE work to meet the contract goal or the bidder submits sufficient documentation of a good faith effort to meet the contract goal pursuant to 49 CFR Part 26, Appendix A. The Utilization Plan will not be approved by the Department if the Utilization Plan does not document sufficient DBE participation to meet the contract goal unless the apparent successful bidder documented in the Utilization Plan that it made a good faith effort to meet the goal. This means that the bidder must show that all necessary and reasonable steps were taken to achieve the contract goal. Necessary and reasonable steps are those which, by their scope, intensity and appropriateness to the objective, could reasonably be expected to obtain sufficient DBE participation, even if they were not successful. The Department will consider the quality, quantity, and intensity of the kinds of efforts that the bidder has made. Mere *pro forma* efforts, in other words, efforts done as a matter of form, are not good faith efforts; rather, the bidder is expected to have taken genuine efforts that would be reasonably expected of a bidder actively and aggressively trying to obtain DBE participation sufficient to meet the contract goal.

- (a) The following is a list of types of action that the Department will consider as part of the evaluation of the bidder's good faith efforts to obtain participation. These listed factors are not intended to be a mandatory checklist and are not intended to be exhaustive. Other factors or efforts brought to the attention of the Department may be relevant in appropriate cases, and will be considered by the Department.
 - (1) Soliciting through all reasonable and available means (e.g. attendance at pre-bid meetings, advertising and/or written notices) the interest of all certified DBE companies that have the capability to perform the work of the contract. The bidder must solicit this interest within sufficient time to allow the DBE companies to respond to the solicitation. The bidder must determine with certainty if the DBE companies are interested by taking appropriate steps to follow up initial solicitations.

- (2) Selecting portions of the work to be performed by DBE companies in order to increase the likelihood that the DBE goals will be achieved. This includes, where appropriate, breaking out contract work items into economically feasible units to facilitate DBE participation, even when the prime Contractor might otherwise prefer to perform these work items with its own forces.
- (3) Providing interested DBE companies with adequate information about the plans, specifications, and requirements of the contract in a timely manner to assist them in responding to a solicitation.
- (4) a. Negotiating in good faith with interested DBE companies. It is the bidder's responsibility to make a portion of the work available to DBE subcontractors and suppliers and to select those portions of the work or material needs consistent with the available DBE subcontractors and suppliers, so as to facilitate DBE participation. Evidence of such negotiation includes the names, addresses, and telephone numbers of DBE companies that were considered; a description of the information provided regarding the plans and specifications for the work selected for subcontracting; and evidence as to why additional agreements could not be reached for DBE companies to perform the work.
 - b. A bidder using good business judgment would consider a number of factors in negotiating with subcontractors, including DBE subcontractors, and would take a firm's price and capabilities as well as contract goals into consideration. However, the fact that there may be some additional costs involved in finding and using DBE companies is not in itself sufficient reason for a bidder's failure to meet the contract DBE goal, as long as such costs are reasonable. Also the ability or desire of a bidder to perform the work of a contract with its own organization does not relieve the bidder of the responsibility to make good faith efforts. Bidders are not, however, required to accept higher quotes from DBE companies if the price difference is excessive or unreasonable. In accordance with subsection (c)(6) of the above Bidding Procedures, the documentation of good faith efforts must include copies of each DBE and non-DBE subcontractor quote submitted to the bidder when a non-DBE subcontractor was selected over a DBE for work on the contract.
- (5) Not rejecting DBE companies as being unqualified without sound reasons based on a thorough investigation of their capabilities. The bidder's standing within its industry, membership in specific groups, organizations, or associations and political or social affiliations (for example union vs. non-union employee status) are not legitimate causes for the rejection or non-solicitation of bids in the bidder's efforts to meet the project goal.
- (6) Making efforts to assist interested DBE companies in obtaining bonding, lines of credit, or insurance as required by the recipient or Contractor.
- (7) Making efforts to assist interested DBE companies in obtaining necessary equipment, supplies, materials, or related assistance or services.

- (8) Effectively using the services of available minority/women community organizations; minority/women contractors' groups; local, state, and federal minority/women business assistance offices; and other organizations as allowed on a case-by-case basis to provide assistance in the recruitment and placement of DBE companies.
- (b) If the Department determines that the apparent successful bidder has made a good faith effort to secure the work commitment of DBE companies to meet the contract goal, the Department will award the contract provided that it is otherwise eligible for award. If the Department determines that the bidder has failed to meet the requirements of this Special Provision or that a good faith effort has not been made, the Department will notify the responsible company official designated in the Utilization Plan that the bid is not responsive. The notification shall include a statement of reasons for the determination. If the Utilization Plan is not approved because it is deficient as a technical matter, unless waived by the Department, the bidder will be notified and will be allowed no more than a five calendar day period in order to cure the deficiency.
- (c) The bidder may request administrative reconsideration of a determination adverse to the bidder within the five working days after the receipt of the notification date of the determination by delivering the request to the Department of Transportation, Bureau of Small Business Enterprises, Contract Compliance Section, 2300 South Dirksen Parkway, Room 319, Springfield, Illinois 62764 (Telefax: (217) 785-1524). Deposit of the request in the United States mail on or before the fifth business day shall not be deemed delivery. The determination shall become final if a request is not made and delivered. A request may provide additional written documentation or argument concerning the issues raised in the determination statement of reasons, provided the documentation and arguments address efforts made prior to submitting the bid. The request will be forwarded to the Department's Reconsideration Officer. The Reconsideration Officer will extend an opportunity to the bidder to meet in person in order to consider all issues of documentation and whether the bidder made a good faith effort to meet the goal. After the review by the Reconsideration Officer, the bidder will be sent a written decision within ten working days after receipt of the request for consideration, explaining the basis for finding that the bidder did or did not meet the goal or make adequate good faith efforts to do so. A final decision by the Reconsideration Officer that a good faith effort was made shall approve the Utilization Plan submitted by the bidder and shall clear the contract for award. A final decision that a good faith effort was not made shall render the bid not responsive.

CALCULATING DBE PARTICIPATION. The Utilization Plan values represent work anticipated to be performed and paid for upon satisfactory completion. The Department is only able to count toward the achievement of the overall goal and the contract goal the value of payments made for the work actually performed by DBE companies. In addition, a DBE must perform a commercially useful function on the contract to be counted. A commercially useful function is generally performed when the DBE is responsible for the work and is carrying out its responsibilities by actually performing, managing, and supervising the work involved. The Department and Contractor are governed by the provisions of 49 CFR Part 26.55(c) on questions of commercially useful functions as it affects the work. Specific counting guidelines are provided in 49 CFR Part 26.55, the provisions of which govern over the summary contained herein.

- (a) DBE as the Contractor: 100 percent goal credit for that portion of the work performed by the DBE's own forces, including the cost of materials and supplies. Work that a DBE subcontracts to a non-DBE does not count toward the DBE goals.
- (b) DBE as a joint venture Contractor: 100 percent goal credit for that portion of the total dollar value of the contract equal to the distinct, clearly defined portion of the work performed by the DBE's own forces.
- (c) DBE as a subcontractor: 100 percent goal credit for the work of the subcontract performed by the DBE's own forces, including the cost of materials and supplies, excluding the purchase of materials and supplies or the lease of equipment by the DBE subcontractor from the prime Contractor or its affiliates. Work that a DBE subcontractor in turn subcontracts to a non-DBE does not count toward the DBE goal.
- (d) DBE as a trucker: 100 percent goal credit for trucking participation provided the DBE is responsible for the management and supervision of the entire trucking operation for which it is responsible. At least one truck owned, operated, licensed, and insured by the DBE must be used on the contract. Credit will be given for the following:
 - (1) The DBE may lease trucks from another DBE firm, including an owner-operator who is certified as a DBE. The DBE who leases trucks from another DBE receives credit for the total value of the transportation services the lessee DBE provides on the contract.
 - (2) The DBE may also lease trucks from a non-DBE firm, including from an owner-operator. The DBE who leases trucks from a non-DBE is entitled to credit only for the fee or commission is receives as a result of the lease arrangement.
- (e) DBE as a material supplier:
 - (1) 60 percent goal credit for the cost of the materials or supplies purchased from a DBE regular dealer.
 - (2) 100 percent goal credit for the cost of materials of supplies obtained from a DBE manufacturer.
 - (3) 100 percent credit for the value of reasonable fees and commissions for the procurement of materials and supplies if not a DBE regular dealer or DBE manufacturer.

CONTRACT COMPLIANCE. Compliance with this Special Provision is an essential part of the contract. The Department is prohibited by federal regulations from crediting the participation of a DBE included in the Utilization Plan toward either the contract goal or the Department's overall goal until the amount to be applied toward the goals has been paid to the DBE. The following administrative procedures and remedies govern the compliance by the Contractor with the contractual obligations established by the Utilization Plan. After approval of the Utilization Plan and award of the contract, the Utilization Plan and individual DBE Participation Statements become part of the contract. If the Contractor did not succeed in obtaining enough DBE participation to achieve the advertised contract goal, and the Utilization Plan was approved and contract awarded based upon a determination of good faith, the total dollar value of DBE work calculated in the approved Utilization Plan as a percentage of the awarded contract value shall become the amended contract goal. All work indicated for performance by an approved DBE shall be performed, managed, and supervised by the DBE executing the DBE Participation Commitment Statement.

- (a) NO AMENDMENT. No amendment to the Utilization Plan may be made without prior written approval from the Department's Bureau of Small Business Enterprises. All requests for amendment to the Utilization Plan shall be submitted to the Department of Transportation, Bureau of Small Business Enterprises, Contract Compliance Section, 2300 South Dirksen Parkway, Room 319, Springfield, Illinois 62764. Telephone number (217) 785-4611. Telefax number (217) 785-1524.
- (b) CHANGES TO WORK. Any deviation from the DBE condition-of-award or contract plans, specifications, or special provisions must be approved, in writing, by the Department as provided elsewhere in the Contract. The Contractor shall notify affected DBEs in writing of any changes in the scope of work which result in a reduction in the dollar amount condition-of-award to the contract. Where the revision includes work committed to a new DBE subcontractor, not previously involved in the project, then a Request for Approval of Subcontractor, Department form BC 260A or AER 260A, must be signed and submitted. If the commitment of work is in the form of additional tasks assigned to an existing subcontract, then a new Request for Approval of Subcontractor shall not be required. However, the Contractor must document efforts to assure that the existing DBE subcontractor is capable of performing the additional work and has agreed in writing to the change.
- (c) SUBCONTRACT. The Contractor must provide DBE subcontracts to IDOT upon request. Subcontractors shall ensure that all lower tier subcontracts or agreements with DBEs to supply labor or materials be performed in accordance with this Special Provision.

- (d) ALTERNATIVE WORK METHODS. In addition to the above requirements for reductions in the condition of award, additional requirements apply to the two cases of Contractor-initiated work substitution proposals. Where the contract allows alternate work methods which serve to delete or create underruns in condition of award DBE work, and the Contractor selects that alternate method or, where the Contractor proposes a substitute work method or material that serves to diminish or delete work committed to a DBE and replace it with other work, then the Contractor must demonstrate one of the following:
- (1) That the replacement work will be performed by the same DBE (as long as the DBE is certified in the respective item of work) in a modification of the condition of award; or
 - (2) That the DBE is aware that its work will be deleted or will experience underruns and has agreed in writing to the change. If this occurs, the Contractor shall substitute other work of equivalent value to a certified DBE or provide documentation of good faith efforts to do so; or
 - (3) That the DBE is not capable of performing the replacement work or has declined to perform the work at a reasonable competitive price. If this occurs, the Contractor shall substitute other work of equivalent value to a certified DBE or provide documentation of good faith efforts to do so.
- (e) TERMINATION AND REPLACEMENT PROCEDURES. The Contractor shall not terminate or replace a DBE listed on the approved Utilization Plan, or perform with other forces work designated for a listed DBE except as provided in this Special Provision. The Contractor shall utilize the specific DBEs listed to perform the work and supply the materials for which each is listed unless the Contractor obtains the Department's written consent as provided in subsection (a) of this part. Unless Department consent is provided for termination of a DBE subcontractor, the Contractor shall not be entitled to any payment for work or material unless it is performed or supplied by the DBE in the Utilization Plan.

As stated above, the Contractor shall not terminate or replace a DBE subcontractor listed in the approved Utilization Plan without prior written consent. This includes, but is not limited to, instances in which the Contractor seeks to perform work originally designated for a DBE subcontractor with its own forces or those of an affiliate, a non-DBE firm, or with another DBE firm. Written consent will be granted only if the Bureau of Small Business Enterprises agrees, for reasons stated in its concurrence document, that the Contractor has good cause to terminate or replace the DBE firm. Before transmitting to the Bureau of Small Business Enterprises any request to terminate and/or substitute a DBE subcontractor, the Contractor shall give notice in writing to the DBE subcontractor, with a copy to the Bureau, of its intent to request to terminate and/or substitute, and the reason for the request. The Contractor shall give the DBE five days to respond to the Contractor's notice. The DBE so notified shall advise the Bureau and the Contractor of the reasons, if any, why it objects to the proposed termination of its subcontract and why the Bureau should not approve the Contractor's action. If required in a particular case as a matter of public necessity, the Bureau may provide a response period shorter than five days.

For purposes of this paragraph, good cause includes the following circumstances:

- (1) The listed DBE subcontractor fails or refuses to execute a written contract;
- (2) The listed DBE subcontractor fails or refuses to perform the work of its subcontract in a way consistent with normal industry standards. Provided, however, that good cause does not exist if the failure or refusal of the DBE subcontractor to perform its work on the subcontract results from the bad faith or discriminatory action of the prime contractor;
- (3) The listed DBE subcontractor fails or refuses to meet the prime Contractor's reasonable, nondiscriminatory bond requirements;
- (4) The listed DBE subcontractor becomes bankrupt, insolvent, or exhibits credit unworthiness;
- (5) The listed DBE subcontractor is ineligible to work on public works projects because of suspension and debarment proceedings pursuant 2 CFR Parts 180, 215 and 1200 or applicable state law.
- (6) You have determined that the listed DBE subcontractor is not a responsible contractor;
- (7) The listed DBE subcontractor voluntarily withdraws from the projects and provides to you written notice of its withdrawal;
- (8) The listed DBE is ineligible to receive DBE credit for the type of work required;
- (9) A DBE owner dies or becomes disabled with the result that the listed DBE contractor is unable to complete its work on the contract;
- (10) Other documented good cause that compels the termination of the DBE subcontractor. Provided, that good cause does not exist if the prime Contractor seeks to terminate a DBE it relied upon to obtain the contract so that the prime Contractor can self-perform the work for which the DBE contractor was engaged or so that the prime Contractor can substitute another DBE or non-DBE contractor after contract award.

When a DBE is terminated, or fails to complete its work on the Contract for any reason the Contractor shall make a good faith effort to find another DBE to substitute for the original DBE to perform at least the same amount of work under the contract as the terminated DBE to the extent needed to meet the established Contract goal. The good faith efforts shall be documented by the Contractor. If the Department requests documentation under this provision, the Contractor shall submit the documentation within seven days, which may be extended for an additional seven days if necessary at the request of the Contractor. The Department shall provide a written determination to the Contractor stating whether or not good faith efforts have been demonstrated.

- (f) PAYMENT RECORDS. The Contractor shall maintain a record of payments for work performed to the DBE participants. The records shall be made available to the Department for inspection upon request. After the performance of the final item of work or delivery of material by a DBE and final payment therefore to the DBE by the Contractor, but not later than thirty calendar days after payment has been made by the Department to the Contractor for such work or material, the Contractor shall submit a DBE Payment Agreement on Department form SBE 2115 to the Resident Engineer. If full and final payment has not been made to the DBE, the DBE Payment Agreement shall indicate whether a disagreement as to the payment required exists between the Contractor and the DBE or if the Contractor believes that the work has not been satisfactorily completed. If the Contractor does not have the full amount of work indicated in the Utilization Plan performed by the DBE companies indicated in the Utilization Plan and after good faith efforts are reviewed, the Department may deduct from contract payments to the Contractor the amount of the goal not achieved as liquidated and ascertained damages. The Contractor may request an administrative reconsideration of any amount deducted as damages pursuant to subsection (h) of this part.
- (g) ENFORCEMENT. The Department reserves the right to withhold payment to the Contractor to enforce the provisions of this Special Provision. Final payment shall not be made on the contract until such time as the Contractor submits sufficient documentation demonstrating achievement of the goal in accordance with this Special Provision or after liquidated damages have been determined and collected.
- (h) RECONSIDERATION. Notwithstanding any other provision of the contract, including but not limited to Article 109.09 of the Standard Specifications, the Contractor may request administrative reconsideration of a decision to deduct the amount of the goal not achieved as liquidated damages. A request to reconsider shall be delivered to the Contract Compliance Section and shall be handled and considered in the same manner as set forth in paragraph (c) of "Good Faith Effort Procedures" of this Special Provision, except a final decision that a good faith effort was not made during contract performance to achieve the goal agreed to in the Utilization Plan shall be the final administrative decision of the Department. The result of the reconsideration process is not administratively appealable to the U.S. Department of Transportation.

EQUAL EMPLOYMENT OPPORTUNITY (BDE)

Effective: April 1, 2015

FEDERAL AID CONTRACTS. Revise the following section of Check Sheet #1 of the Recurring Special Provisions to read:

"EQUAL EMPLOYMENT OPPORTUNITY

In the event of the Contractor's noncompliance with the provisions of this Equal Employment Opportunity Clause, the Illinois Human Rights Act, or the Illinois Department of Human Rights Rules and Regulations, the Contractor may be declared ineligible for future contracts or subcontracts with the State of Illinois or any of its political sub-divisions or municipal corporations, and the contract may be cancelled or voided in whole or in part, and such other sanctions or penalties may be imposed or remedies invoked as provided by statute or regulation.

During the performance of this Contract, the Contractor agrees as follows:

- (1) That it will not discriminate against any employee or applicant for employment because of race, color, religion, sex, sexual orientation, marital status, order of protection status, national origin or ancestry, citizenship status, age, physical or mental disability unrelated to ability, military status, or an unfavorable discharge from military service; and further that it will examine all job classifications to determine if minority persons or women are underutilized and will take appropriate affirmative action to rectify any such underutilization.
- (2) That, if it hires additional employees in order to perform this contract or any portion hereof, it will determine the availability (according to the Illinois Department of Human Rights Rules and Regulations) of minorities and women in the area(s) from which it may reasonably recruit and it will hire for each job classification for which employees are hired in such a way that minorities and women are not underutilized.
- (3) That, in all solicitations or advertisements for employees placed by it or on its behalf, it will state that all applicants will be afforded equal opportunity without discrimination because of race, color, religion, sex, sexual orientation, marital status, order of protection status, national origin or ancestry, citizenship status, age, physical or mental disability unrelated to ability, military status or an unfavorable discharge from military service.
- (4) That it will send to each labor organization or representative of workers with which it has or is bound by a collective bargaining or other agreement or understanding, a notice advising such labor organization or representative of the Contractor's obligations under the Illinois Human Rights Act and the Illinois Department of Human Rights Rules and Regulations. If any labor organization or representative fails or refuses to cooperate with the Contractor in its efforts to comply with such Act and Rules and Regulations, the Contractor will promptly so notify the Illinois Department of Human Rights and IDOT and will recruit employees from other sources when necessary to fulfill its obligations thereunder.

- (5) That it will submit reports as required by the Illinois Department of Human Rights Rules and Regulations, furnish all relevant information as may from time to time be requested by the Illinois Department of Human Rights or IDOT, and in all respects comply with the Illinois Human Rights Act and the Illinois Department of Human Rights Rules and Regulations.
- (6) That it will permit access to all relevant books, records, accounts, and work sites by personnel of IDOT and the Illinois Department of Human Rights for purposes of investigation to ascertain compliance with the Illinois Human Rights Act and the Illinois Department of Human Rights Rules and Regulations.
- (7) That it will include verbatim or by reference the provisions of this clause in every subcontract it awards under which any portion of the contract obligations are undertaken or assumed, so that the provisions will be binding upon the subcontractor. In the same manner as with other provisions of this contract, the Contractor will be liable for compliance with applicable provisions of this clause by subcontractors; and further it will promptly notify IDOT and the Illinois Department of Human Rights in the event any subcontractor fails or refuses to comply with these provisions. In addition, the Contractor will not utilize any subcontractor declared by the Illinois Human Rights Commission to be ineligible for contracts or subcontracts with the State of Illinois or any of its political subdivisions or municipal corporations."

STATE CONTRACTS. Revise Section II of Check Sheet #5 of the Recurring Special Provisions to read:

"II. EQUAL EMPLOYMENT OPPORTUNITY

In the event of the Contractor's noncompliance with the provisions of this Equal Employment Opportunity Clause, the Illinois Human Rights Act or the Illinois Department of Human Rights Rules and Regulations, the Contractor may be declared ineligible for future contracts or subcontracts with the State of Illinois or any of its political sub-divisions or municipal corporations, and the contract may be cancelled or voided in whole or in part, and such other sanctions or penalties may be imposed or remedies invoked as provided by statute or regulation.

During the performance of this Contract, the Contractor agrees as follows:

1. That it will not discriminate against any employee or applicant for employment because of race, color, religion, sex, sexual orientation, marital status, order of protection status, national origin or ancestry, citizenship status, age, physical or mental disability unrelated to ability, military status, or an unfavorable discharge from military service; and further that it will examine all job classifications to determine if minority persons or women are underutilized and will take appropriate affirmative action to rectify any such underutilization.

2. That, if it hires additional employees in order to perform this contract or any portion hereof, it will determine the availability (according to the Illinois Department of Human Rights Rules and Regulations) of minorities and women in the area(s) from which it may reasonably recruit and it will hire for each job classification for which employees are hired in such a way that minorities and women are not underutilized.
3. That, in all solicitations or advertisements for employees placed by it or on its behalf, it will state that all applicants will be afforded equal opportunity without discrimination because of race, color, religion, sex, sexual orientation, marital status, order of protection status, national origin or ancestry, citizenship status, age, physical or mental disability unrelated to ability, military status, or an unfavorable discharge from military service.
4. That it will send to each labor organization or representative of workers with which it has or is bound by a collective bargaining or other agreement or understanding, a notice advising such labor organization or representative of the Contractor's obligations under the Illinois Human Rights Act and the Illinois Department of Human Rights Rules and Regulations. If any labor organization or representative fails or refuses to cooperate with the Contractor in its efforts to comply with such Act and Rules and Regulations, the Contractor will promptly so notify the Illinois Department of Human Rights and IDOT and will recruit employees from other sources when necessary to fulfill its obligations thereunder.
5. That it will submit reports as required by the Illinois Department of Human Rights Rules and Regulations, furnish all relevant information as may from time to time be requested by the Illinois Department of Human Rights or IDOT, and in all respects comply with the Illinois Human Rights Act and the Illinois Department of Human Rights Rules and Regulations.
6. That it will permit access to all relevant books, records, accounts and work sites by personnel of IDOT and the Illinois Department of Human Rights for purposes of investigation to ascertain compliance with the Illinois Human Rights Act and the Illinois Department of Human Rights Rules and Regulations.
7. That it will include verbatim or by reference the provisions of this clause in every subcontract it awards under which any portion of the contract obligations are undertaken or assumed, so that the provisions will be binding upon the subcontractor. In the same manner as with other provisions of this contract, the Contractor will be liable for compliance with applicable provisions of this clause by subcontractors; and further it will promptly notify IDOT and the Illinois Department of Human Rights in the event any subcontractor fails or refuses to comply with these provisions. In addition, the Contractor will not utilize any subcontractor declared by the Illinois Human Rights Commission to be ineligible for contracts or subcontracts with the State of Illinois or any of its political subdivisions or municipal corporations.”

LRFD PIPE CULVERT BURIAL TABLES (BDE)

Effective: November 1, 2013

Revised: April 1, 2015

Revise Article 542.02 of the Standard Specifications to read as follows:

“Item	Article/Section
(a) Galvanized Corrugated Steel Pipe	1006.01
(b) Galvanized Corrugated Steel Pipe Arch	1006.01
(c) Bituminous Coated Corrugated Steel Pipe	1006.01
(d) Bituminous Coated Corrugated Steel Pipe Arch	1006.01
(e) Reserved	
(f) Aluminized Steel Type 2 Corrugated Pipe	1006.01
(g) Aluminized Steel Type 2 Corrugated Pipe Arch	1006.01
(h) Precoated Galvanized Corrugated Steel Pipe	1006.01
(i) Precoated Galvanized Corrugated Steel Pipe Arch	1006.01
(j) Corrugated Aluminum Alloy Pipe	1006.03
(k) Corrugated Aluminum Alloy Pipe Arch	1006.03
(l) Extra Strength Clay Pipe	1040.02
(m) Concrete Sewer, Storm Drain, and Culvert Pipe	1042
(n) Reinforced Concrete Culvert, Storm Drain, and Sewer Pipe	1042
(o) Reinforced Concrete Elliptical Culvert, Storm Drain, and Sewer Pipe.....	1042
(p) Reinforced Concrete Arch Culvert, Storm Drain, and Sewer Pipe	1042
(q) Polyvinyl Chloride (PVC) Pipe	1040.03
(r) Corrugated Polyvinyl Chloride (PVC) Pipe with a Smooth Interior	1040.03
(s) Corrugated Polypropylene (CPP) pipe with smooth Interior	1040.08
(t) Corrugated Polyethylene (PE) Pipe with a Smooth Interior	1040.04
(u) Polyethylene (PE) Pipe with a Smooth Interior	1040.04
(v) Rubber Gaskets and Preformed Flexible Joint Sealants for Concrete Pipe	1056
(w) Mastic Joint Sealer for Pipe	1055
(x) External Sealing Band	1057
(y) Fine Aggregate (Note 1)	1003.04
(z) Coarse Aggregate (Note 2)	1004.05
(aa) Packaged Rapid Hardening Mortar or Concrete	1018
(bb) Nonshrink Grout	1024.02
(cc) Reinforcement Bars and Welded Wire Fabric	1006.10
(dd) Handling Hole Plugs	1042.16

Note 1. The fine aggregate shall be moist.

Note 2. The coarse aggregate shall be wet.”

Revise the table for permitted materials in Article 542.03 of the Standard Specifications as follows:

"Class	Materials
A	Rigid Pipes: Extra Strength Clay Pipe Concrete Sewer Storm Drain and Culvert Pipe, Class 3 Reinforced Concrete Culvert, Storm Drain, and Sewer Pipe Reinforced Concrete Elliptical Culvert, Storm Drain, and Sewer Pipe Reinforced Concrete Arch Culvert, Storm Drain, and Sewer Pipe
C	Rigid Pipes: Extra Strength Clay Pipe Concrete Sewer Storm Drain and Culvert Pipe, Class 3 Reinforced Concrete Culvert, Storm Drain, and Sewer Pipe Reinforced Concrete Elliptical Culvert, Storm Drain, and Sewer Pipe Reinforced Concrete Arch Culvert, Storm Drain, and Sewer Pipe Flexible Pipes: Aluminized Steel Type 2 Corrugated Pipe Aluminized Steel Type 2 Corrugated Pipe Arch Precoated Galvanized Corrugated Steel Pipe Precoated Galvanized Corrugated Steel Pipe Arch Corrugated Aluminum Alloy Pipe Corrugated Aluminum Alloy Pipe Arch Polyvinyl Chloride (PVC) Pipe Corrugated Polyvinyl Chloride (PVC) Pipe with a Smooth Interior Polyethylene (PE) Pipe with a Smooth Interior Corrugated Polypropylene (CPP) Pipe with Smooth Interior
D	Rigid Pipes: Extra Strength Clay Pipe Concrete Sewer Storm Drain and Culvert Pipe, Class 3 Reinforced Concrete Culvert, Storm Drain, and Sewer Pipe Reinforced Concrete Elliptical Culvert, Storm Drain, and Sewer Pipe Reinforced Concrete Arch Culvert, Storm Drain, and Sewer Pipe Flexible Pipes: Galvanized Corrugated Steel Pipe Galvanized Corrugated Steel Pipe Arch Bituminous Coated Corrugated Steel Pipe Bituminous Coated Corrugated Steel Pipe Arch Aluminized Steel Type 2 Corrugated Pipe Aluminized Steel Type 2 Corrugated Pipe Arch Precoated Galvanized Corrugated Steel Pipe Precoated Galvanized Corrugated Steel Pipe Arch Corrugated Aluminum Alloy Pipe Corrugated Aluminum Alloy Pipe Arch Polyvinyl Chloride (PVC) Pipe Corrugated Polyvinyl Chloride (PVC) Pipe with a Smooth Interior Corrugated Polyethylene (PE) Pipe with a Smooth Interior Polyethylene (PE) Pipe with a Smooth Interior" Corrugated Polypropylene (CPP) Pipe with Smooth Interior

Revise Articles 542.03(b) and (c) of the Standard Specifications to read:

- “(b) Extra strength clay pipe will only be permitted for pipe culverts Type 1, for 10 in., 12 in., 42 in. and 48 in. (250 mm, 300 mm, 1050 mm and 1200 mm), Types 2, up to and including 48 in. (1200 mm), Type 3, up to and including 18 in. (450 mm), Type 4 up to and including 10 in. (250 mm), for all pipe classes.
- (c) Concrete sewer, storm drain, and culvert pipe Class 3 will only be permitted for pipe culverts Type 1, up to and including 10 in (250 mm), Type 2, up to and including 30 in. (750 mm), Type 3, up to and including 15 in. (375 mm); Type 4, up to and including 10 in. (250 mm), for all pipe classes.”

Replace the pipe tables in Article 542.03 of the Standard Specifications with the following:

"Table IA: Classes of Reinforced Concrete Pipe for the Respective Diameters of Pipe and Fill Heights over the Top of the Pipe							
Nominal Diameter in.	Type 1	Type 2	Type 3	Type 4	Type 5	Type 6	Type 7
	Fill Height: 3' and less 1' min cover	Fill Height: Greater than 3' not exceeding 10'	Fill Height: Greater than 10' not exceeding 15'	Fill Height: Greater than 15' not exceeding 20'	Fill Height: Greater than 20' not exceeding 25'	Fill Height: Greater than 25' not exceeding 30'	Fill Height: Greater than 30' not exceeding 35'
12	IV	II	III	IV	IV	V	V
15	IV	II	III	IV	IV	V	V
18	IV	II	III	IV	IV	V	V
21	III	II	III	IV	IV	V	V
24	III	II	III	IV	IV	V	V
30	IV	II	III	IV	IV	V	V
36	III	II	III	IV	IV	V	V
42	II	II	III	IV	IV	V	V
48	II	II	III	IV	IV	V	V
54	II	II	III	IV	IV	V	V
60	II	II	III	IV	IV	V	V
66	II	II	III	IV	IV	V	V
72	II	II	III	IV	V	V	V
78	II	II	III	IV	2020	2370	2730
84	II	II	III	IV	2020	2380	2740
90	II	II	III	1680	2030	2390	2750
96	II	III	III	1690	2040	2400	2750
102	II	III	III	1700	2050	2410	2760
108	II	III	1360	1710	2060	2410	2770

Notes:

A number indicates the D-Load for the diameter and depth of fill and that a special design is required.
Design assumptions; Water filled pipe, Type 2 bedding and Class C Walls

Table IA: Classes of Reinforced Concrete Pipe
for the Respective Diameters of Pipe and Fill Heights over the Top of the Pipe
(Metric)

Nominal Diameter mm	Type 1	Type 2	Type 3	Type 4	Type 5	Type 6	Type 7
	Fill Height: 1 m and less 0.3 m min cover	Fill Height: Greater than 1 m not exceeding 3 m	Fill Height: Greater than 3 m not exceeding 4.5 m	Fill Height: Greater than 4.5 m not exceeding 6 m	Fill Height: Greater than 6 m not exceeding 7.5 m	Fill Height: Greater than 7.5 m not exceeding 9 m	Fill Height: Greater than 9 m not exceeding 10.5 m
300	IV	II	III	IV	IV	V	V
375	IV	II	III	IV	IV	V	V
450	IV	II	III	IV	IV	V	V
525	III	II	III	IV	IV	V	V
600	III	II	III	IV	IV	V	V
750	IV	II	III	IV	IV	V	V
900	III	II	III	IV	IV	V	V
1050	II	II	III	IV	IV	V	V
1200	II	II	III	IV	IV	V	V
1350	II	II	III	IV	IV	V	V
1500	II	II	III	IV	IV	V	V
1650	II	II	III	IV	IV	V	V
1800	II	II	III	IV	V	V	V
1950	II	II	III	IV	100	110	130
2100	II	II	III	IV	100	110	130
2250	II	II	III	80	100	110	130
2400	II	III	III	80	100	110	130
2550	II	III	III	80	100	120	130
2700	II	III	70	80	100	120	130

Notes:

A number indicates the D-Load for the diameter and depth of fill and that a special design is required.
Design assumptions; Water filled pipe, Type 2 bedding and Class C Walls

FAI Route 74/280 & FAI Route 88 (I-74/280 & I-88)
Section D2 DRAINAGE 2016-1
Henry & Whiteside Counties
Contract No. 64L02

TABLE IB: THICKNESS OF CORRUGATED STEEL PIPE
FOR THE RESPECTIVE DIAMETER OF PIPE AND FILL HEIGHTS OVER THE TOP OF THE PIPE FOR 2 2/3"x1/2", 3"x1" AND 5"x1" CORRUGATIONS

Nominal Diameter in.*	Type 1			Type 2			Type 3			Type 4			Type 5			Type 6			Type 7		
	Fill Height: 3' and less 1' min. cover			Fill Height: Greater than 3' not exceeding 10'			Fill Height: Greater than 10' not exceeding 15'			Fill Height: Greater than 15' not exceeding 20'			Fill Height: Greater than 20' not exceeding 25'			Fill Height: Greater than 25' not exceeding 30'			Fill Height: Greater than 30' not exceeding 35'		
	2 2/3" x 1/2"	3"x1"	5"x1"	2 2/3" x 1/2"	3"x1"	5"x1"	2 2/3" x 1/2"	3"x1"	5"x1"	2 2/3" x 1/2"	3"x1"	5"x1"	2 2/3" x 1/2"	3"x1"	5"x1"	2 2/3" x 1/2"	3"x1"	5"x1"	2 2/3" x 1/2"	3"x1"	5"x1"
12	0.064			0.064			0.064			0.064			0.064			0.064			0.064		
15	0.064			0.064			0.064			0.064			0.064			0.064			0.064		
18	(0.079)			0.064			0.064			0.064			0.064			(0.079)			(0.079)		
21	(0.079)			0.064			0.064			0.064			(0.079)			(0.079)			(0.079)		
24	(0.079)			0.064			0.064			0.064			(0.079)			(0.079)			(0.079)		
30	(0.109E)			0.064			0.064			(0.079)			(0.079)			(0.109)			(0.109)		
36	(0.109E)			0.064			(0.079)			(0.079)			(0.109)			0.109			(0.138E)		
42	0.079			0.064			(0.079)			(0.079)			(0.109)			(0.109E)			(0.109E)		
48	0.109	(0.109)	0.109	(0.109)	0.079	0.079	(0.109)	0.079	(0.109)	0.109	(0.109)	0.109	(0.138)	(0.109)	0.109	(0.138E)	0.109	0.109	(0.138E)	0.109	(0.138)
54	0.109	(0.109)	0.109	(0.109)	0.079	0.079	0.109	(0.109)	0.109	0.109	(0.109)	0.109	(0.138)	0.109	0.109	(0.138E)	0.109	(0.138)	(0.138E)	0.138	0.138
60	0.109	0.109	0.109	0.109	0.079	(0.109)	0.109	(0.109)	0.109	0.109	(0.109)	0.109	(0.138)	0.109	0.109	(0.138E)	(0.138)	(0.138)	0.138E	(0.138E)	(0.138E)
66	(0.138)	0.109	0.109	0.109	0.079	(0.109)	0.109	(0.109)	0.109	0.109	(0.109)	0.109	(0.138)	0.109	(0.138)	(0.138E)	0.138	0.138	0.138E	(0.138E)	0.138E
72	0.138	0.109	(0.138)	0.138	(0.109)	(0.109)	0.138	(0.109)	0.109	0.138	(0.109)	0.109	0.138	(0.138)	(0.138)	(0.168E)	(0.138E)	0.138E	(0.168E)	(0.138E)	0.138E
78	0.168	0.109	(0.138)	0.168	(0.109)	0.109	0.168	0.109	0.109	0.168	0.109	(0.138)	0.168	(0.138)	(0.138)	H0.168E	(0.138E)	0.138E	H0.168E	0.138E	(0.168E)
84	0.168	(0.138)	(0.138)	0.168	(0.109)	0.109	0.168	0.109	0.109	0.168	0.109	(0.138)	0.168	(0.138)	0.138	H0.168E	(0.138E)	0.138E	H0.168E	(0.168E)	(0.168E)
90		(0.138)	(0.138)		(0.109)	0.109		0.109	0.109		(0.138)	(0.138)		(0.138)	0.138		0.138E	(0.168E)		(0.168E)	(0.168E)
96		(0.138)	(0.138)		(0.109)	0.109		0.109	0.109		(0.138)	(0.138)		(0.138)	0.138		(0.168E)	(0.168E)		(0.168E)	(0.168E)
102		0.109Z	0.109Z		(0.109)	0.109		0.109	(0.138)		(0.138)	(0.138)		(0.138)	0.138		(0.168E)	(0.168E)		H0.138E	H0.168E
108		0.109Z	(0.138Z)		0.109	0.109		0.109	(0.138)		(0.138)	0.138		0.138	(0.168)		(0.168E)	(0.168E)		H0.138E	H0.168E
114		0.109Z	(0.138Z)		0.109	0.109		0.109	(0.138)		(0.138)	0.138		(0.168)	(0.168)		(0.168E)	0.168E		H0.138E	H0.168E
120		0.109Z	(0.138Z)		0.109	0.109		0.109	(0.138)	(0.138)		0.138		(0.168)	(0.168)		H0.138E	H0.168E		H0.168E	H0.168E
126		0.138Z	0.138Z		0.138	0.138		0.138	0.138		0.138	(0.168)		(0.168)	(0.168)		H0.138E	H0.168E		H0.168E	H0.168E
132		0.138Z	0.138Z		0.138	0.138		0.138	0.138		(0.168)	(0.168)		0.168	0.168		H0.138E	H0.168E		H0.168E	H0.168E
138		0.138Z	0.138Z		0.138	0.138		0.138	0.138		(0.168)	(0.168)		(0.168E)	H0.168E		H0.168E	H0.168E		H0.168E	H0.168E
144		0.168Z	0.168Z		0.168	0.168		0.168	0.168		0.168	0.168		H0.168E	H0.168E		H0.168E	H0.168E		H0.168E	H0.168E

Notes:

- * Aluminized Type 2 Steel or Precoated Galvanized Steel shall be required for diameters up to 42" according to Article 1006.01, 1 1/2" x 1/4" corrugations shall be used for diameters less than 12".
- Thicknesses are based on longitudinal riveted seam fabrication, values in "()" can be reduced by one gage thickness if helical seam fabrication is utilized.
- A thickness preceded by "H" indicates only helical seam fabrication is allowed.
- E Elongation according to Article 542.04(e)
- Z 1'-6" Minimum fill

FAI Route 74/280 & FAI Route 88 (I-74/280 & I-88)
Section D2 DRAINAGE 2016-1
Henry & Whiteside Counties
Contract No. 64L02

TABLE IB: THICKNESS OF CORRUGATED STEEL PIPE FOR THE RESPECTIVE DIAMETER OF PIPE AND FILL HEIGHTS OVER THE TOP OF THE PIPE FOR 68 mm x 13 mm, 75 mm x 25 mm AND 125 mm x 25 mm CORRUGATIONS (Metric)																					
Nominal Diameter mm *	Type 1 Fill Height:			Type 2 Fill Height:			Type 3 Fill Height:			Type 4 Fill Height:			Type 5 Fill Height:			Type 6 Fill Height:			Type 7 Fill Height:		
	1 m and less 0.3 m min. cover			Greater than 1 m not exceeding 3 m			Greater than 3 m not exceeding 4.5 m			Greater than 4.5 m not exceeding 6 m			Greater than 6 m not exceeding 7.5 m			Greater than 7.5 m not exceeding 9 m			Greater than 9 m not exceeding 10.5 m		
	68 x 13 mm	75 x 25 mm	125 x 25 mm	68 x 13 mm	75 x 25 mm	125 x 25 mm	68 x 13 mm	75 x 25 mm	125 x 25 mm	68 x 13 mm	75 x 25 mm	125 x 25 mm	68 x 13 mm	75 x 25 mm	125 x 25 mm	68 x 13 mm	75 x 25 mm	125 x 25 mm	68 x 13 mm	75 x 25 mm	125 x 25 mm
300	1.63			1.63			1.63			1.63			1.63			1.63			1.63		
375	1.63			1.63			1.63			1.63			1.63			1.63			1.63		
450	(2.01)			1.63			1.63			1.63			1.63			(2.01)			(2.01)		
525	(2.01)			1.63			1.63			1.63			(2.01)			(2.01)			(2.01)		
600	(2.01)			1.63			1.63			1.63			(2.01)			(2.01)			(2.01)		
750	(2.77E)			1.63			1.63			(2.01)			(2.01)			(2.01)			(2.77)		
900	(2.77E)			1.63			(2.01)			(2.01)			(2.77)			2.77			(3.51E)		
1050	2.01			1.63			(2.01)			(2.01)			(2.77)			(2.77E)			(2.77E)		
1200	2.77	(2.77)	2.77	(2.77)	2.01	2.01	(2.77)	2.01	(2.77)	2.77	(2.77)	2.77	(3.51)	(2.77)	2.77	(3.51E)	2.77	2.77	(3.51E)	2.77	(3.51)
1350	2.77	(2.77)	2.77	(2.77)	2.01	2.01	2.77	(2.77)	2.77	2.77	(2.77)	2.77	(3.51)	2.77	2.77	(3.51E)	2.77	(3.51)	(3.51E)	3.51	3.51
1500	2.77	2.77	2.77	2.77	2.01	(2.77)	2.77	(2.77)	2.77	2.77	(2.77)	2.77	(3.51)	2.77	2.77	(3.51E)	(3.51)	(3.51)	3.51E	(3.51E)	(3.51E)
1650	(3.51)	2.77	2.77	2.77	2.01	(2.77)	2.77	(2.77)	2.77	2.77	2.77	2.77	(3.51)	2.77	(3.51)	(3.51E)	3.51	3.51	3.51E	(3.51E)	3.51E
1800	3.51	2.77	(3.51)	3.51	(2.77)	(2.77)	3.51	(2.77)	2.77	3.51	2.77	2.77	3.51	(3.51)	(3.51)	(4.27E)	(3.51E)	3.51E	(4.27E)	(3.51E)	3.51E
1950	4.27	2.77	(3.51)	4.27	(2.77)	2.77	4.27	2.77	2.77	4.27	2.77	(3.51)	4.27	(3.51)	(3.51)	H 4.27E	(3.51E)	3.51E	H 4.27E	3.51E	(4.27E)
2100	4.27	(3.51)	(3.51)	4.27	(2.77)	2.77	4.27	2.77	2.77	4.27	2.77	(3.51)	4.27	(3.51)	3.51	H 4.27E	(3.51E)	3.51E	H 4.27E	(4.27E)	(4.27E)
2250		(3.51)	(3.51)		(2.77)	2.77		2.77	2.77		(3.51)	(3.51)		(3.51)	3.51		3.51E	(4.27E)		(4.27E)	(4.27E)
2400		(3.51)	(3.51)		(2.77)	2.77		2.77	2.77		(3.51)	(3.51)		(3.51)	3.51		(4.27E)	(4.27E)		(4.27E)	(4.27E)
2550		2.77Z	2.77Z		(2.77)	2.77		2.77	(3.51)		(3.51)	(3.51)		(3.51)	3.51		(4.27E)	(4.27E)		H 3.51E	H 4.27E
2700		2.77Z	(3.51Z)		2.77	2.77		2.77	(3.51)		(3.51)	3.51		3.51	(4.27)		(4.27E)	(4.27E)		H 3.51E	H 4.27E
2850		2.77Z	(3.51Z)		2.77	2.77		2.77	(3.51)		(3.51)	3.51		(4.27)	(4.27)		(4.27E)	4.27E		H 3.51E	H 4.27E
3000		2.77Z	(3.51Z)		2.77	2.77		(3.51)	(3.51)		(3.51)	3.51		(4.27)	(4.27)		H 3.51E	H 4.27E		H 4.27E	H 4.27E
3150		3.51Z	3.51Z		3.51	3.51		3.51	3.51		3.51	(4.27)		(4.27)	(4.27)		H 3.51E	H 4.27E		H 4.27E	H 4.27E
3300		3.51Z	3.51Z		3.51	3.51		3.51	3.51		(4.27)	(4.27)		4.27	4.27		H 3.51E	H 4.27E		H 4.27E	H 4.27E
3450		3.51Z	3.51Z		3.51	3.51		3.51	3.51		(4.27)	(4.27)		(4.27E)	H 4.27E		H 4.27E	H 4.27E		H 4.27E	
3600		4.27Z	4.27Z		4.27	4.27		4.27	4.27		4.27	4.27		H 4.27E	H 4.27E		H 4.27E	H 4.27E		H 4.27E	

Notes:
 * Aluminized Type 2 Steel or Precoated Galvanized Steel shall be required for diameters up to 1050 mm according to Article 1006.01, 38 mm x 6.5 mm corrugations shall be used for diameters less than 300 mm.
 Thicknesses are based on longitudinal riveted seam fabrication, values in "()" can be reduced by one gage thickness if helical seam fabrication is utilized.
 A thickness preceded by an "H" indicates only helical seam fabrication is allowed.
 E Elongation according to Article 542.04(e)
 Z 450 mm Minimum Fill

FAI Route 74/280 & FAI Route 88 (I-74/280 & I-88)
Section D2 DRAINAGE 2016-1
Henry & Whiteside Counties
Contract No. 64L02

TABLE IC: THICKNESS OF CORRUGATED ALUMINUM ALLOY PIPE
FOR THE RESPECTIVE DIAMETER OF PIPE AND FILL HEIGHTS OVER THE TOP OF THE PIPE FOR 2 2/3"x1/2" AND 3"x1" CORRUGATIONS

Nominal Diameter in.	Type 1		Type 2		Type 3		Type 4		Type 5		Type 6		Type 7	
	Fill Height: 3' and less 1' min. cover		Fill Height: Greater than 3' not exceeding 10'		Fill Height: Greater than 10' not exceeding 15'		Fill Height: Greater than 15' not exceeding 20'		Fill Height: Greater than 20' not exceeding 25'		Fill Height: Greater than 25' not exceeding 30'		Fill Height: Greater than 30' not exceeding 35'	
	2 2/3"x1/2"	3"x1"	2 2/3"x1/2"	3"x1"	2 2/3"x1/2"	3"x1"	2 2/3"x1/2"	3"x1"	2 2/3"x1/2"	3"x1"	2 2/3"x1/2"	3"x1"	2 2/3"x1/2"	3"x1"
12	(0.075)		0.060		0.060		0.060		0.060		0.060		0.060	
15	(0.075)		0.060		0.060		0.060		0.060		0.060		(0.075)	
18	(0.075)		0.060		0.060		0.060		0.060		(0.075)		H 0.060	
21	H 0.060E		0.060		0.060		0.060		(0.075)		H 0.060		H 0.060E	
24	(0.105E)		0.060		0.060		(0.075)		(0.105)		(0.105)		(0.105E)	
30	H 0.075E	H 0.060	0.075	H 0.060	0.075	H 0.060	(0.105)	H 0.060	(0.105)	H 0.060	H 0.075E	H 0.060	H 0.075E	H 0.060
36	(0.135E)	H 0.060E	0.075	H 0.060	(0.105)	H 0.060	(0.105)	H 0.060	(0.135)	H 0.060	H 0.075E	H 0.060	H 0.075E	H 0.060E
42	0.105E	(0.075)	0.105	0.060	0.105	0.060	0.105	0.060	0.105	(0.075)	0.105E	0.105	0.105E	(0.105E)
48	0.105E	(0.075)	0.105	0.060	0.105	0.060	0.105	(0.075)	0.105	(0.105)	0.105E	(0.105E)	0.105E	(0.135E)
54	0.105E	(0.105)	0.105	0.060	0.105	0.060	0.105	(0.075)	0.105	(0.105)	0.105E	(0.105E)	(0.135E)	(0.135E)
60	0.135E	(0.105)	0.135	0.060	0.135	(0.075)	0.135	(0.105)	0.135	(0.105)	0.135E	(0.135E)	(0.164E)	(0.135E)
66	0.164E	(0.105)	0.164	0.060	0.164	(0.075)	0.164	(0.105)	0.164	(0.135)	0.164E	(0.135E)	H 0.164E	(0.135E)
72	0.164E	(0.105)	0.164	0.060	0.164	(0.075)	0.164	(0.105)	0.164	(0.135)	H 0.164E	(0.135E)	H 0.164E	(0.164E)
78		(0.135)		0.075		(0.105)		(0.105)		(0.135)		(0.135E)		(0.164E)
84		(0.135)		0.105		0.105		(0.135)		(0.135)		(0.164E)		(0.164E)
90		(0.135)		0.105		0.105		(0.135)		(0.135)		(0.164E)		(0.164E)
96		(0.135)		0.105		0.105		(0.135)		(0.135)		(0.164E)		H 0.135E
102		0.135Z		0.135		0.135		0.135		(0.164)		(0.164E)		H 0.135E
108		0.135Z		0.135		0.135		0.135		(0.164)		(0.164E)		H 0.164E
114		0.164Z		0.164		0.164		0.164		0.164		H 0.164E		H 0.164E
120		0.164Z		0.164		0.164		0.164		0.164		H 0.164E		H 0.164E

Notes:

Thicknesses are based on longitudinal riveted seam fabrication, values in "()" can be reduced by one gage thickness if helical seam fabrication is utilized.

A thickness preceded by an "H" indicates only helical seam fabrication is allowed.

E Elongation according to Article 542.04(e), the elongation requirement for Type 1 fill heights may be eliminated for fills above 1'-6"

Z 1"-6" Minimum fill

FAI Route 74/280 & FAI Route 88 (I-74/280 & I-88)
Section D2 DRAINAGE 2016-1
Henry & Whiteside Counties
Contract No. 64L02

TABLE IC: THICKNESS OF CORRUGATED ALUMINUM ALLOY PIPE
FOR THE RESPECTIVE DIAMETER OF PIPE AND FILL HEIGHTS OVER THE TOP OF THE PIPE
FOR 68 mm x 13 mm AND 75 mm x 25 mm CORRUGATIONS
(Metric)

Nominal Diameter mm	Type 1		Type 2		Type 3		Type 4		Type 5		Type 6		Type 7	
	Fill Height: 1 m and less 0.3 m min. cover		Fill Height: Greater than 1 m not exceeding 3 m		Fill Height: Greater than 3 m not exceeding 4.5 m		Fill Height: Greater than 4.5 m not exceeding 6 m		Fill Height: Greater than 6 m not exceeding 7.5 m		Fill Height: Greater than 7.5 m not exceeding 9 m		Fill Height: Greater than 9 m not exceeding 10.5 m	
	68 x 13 mm	75 x 25 mm	68 x 13 mm	75 x 25 mm	68 x 13 mm	75 x 25 mm	68 x 13 mm	75 x 25 mm	68 x 13 mm	75 x 25 mm	68 x 13 mm	75 x 25 mm	68 x 13 mm	75 x 25 mm
300	(1.91)		1.52		1.52		1.52		1.52		1.52		1.52	
375	(1.91)		1.52		1.52		1.52		1.52		1.52		(1.91)	
450	(1.91)		1.52		1.52		1.52		1.52		(1.91)		H 1.52	
525	H 1.52E		1.52		1.52		1.52		(1.91)		H 1.52		H 1.52E	
600	(2.67E)		1.52		1.52		(1.91)		(2.67)		(2.67)		(2.67E)	
750	H 1.91E	H 1.52	1.91	H 1.52	1.91	H 1.52	(2.67)	H 1.52	(2.67)	H 1.52	H 1.91E	H 1.52	H 1.91E	H 1.52
900	(3.43E)	H 1.52E	1.91	H 1.52	(2.67)	H 1.52	(2.67)	H 1.52	(3.43)	H 1.52	H 1.91E	H 1.52	H 1.91E	H 1.52E
1050	2.67E	(1.91)	2.67	1.52	2.67	1.52	2.67	1.52	2.67	(1.91)	2.67E	2.67	2.67E	(2.67E)
1200	2.67E	(1.91)	2.67	1.52	2.67	1.52	2.67	(1.91)	2.67	(2.67)	2.67E	(2.67E)	2.67E	(3.43E)
1350	2.67E	(2.67)	2.67	1.52	2.67	1.52	2.67	(1.91)	2.67	(2.67)	2.67E	(2.67E)	(3.43E)	(3.43E)
1500	3.43E	(2.67)	3.43	1.52	3.43	(1.91)	3.43	(2.67)	3.43	(2.67)	3.43E	(3.43E)	(4.17E)	(3.43E)
1650	4.17E	(2.67)	4.17	1.52	4.17	(1.91)	4.17	(2.67)	4.17	(3.43)	4.17E	(3.43E)	H 4.17E	(3.43E)
1800	4.17E	(2.67)	4.17	1.52	4.17	(1.91)	4.17	(2.67)	4.17	(3.43)	H 4.17E	(3.43E)	H 4.17E	(4.17E)
1950		(3.43)		1.91		(2.67)		(2.67)		(3.43)		(3.43E)		(4.17E)
2100		(3.43)		2.67		2.67		(3.43)		(3.43)		(4.17E)		(4.17E)
2250		(3.43)		2.67		2.67		(3.43)		(3.43)		(4.17E)		(4.17E)
2400		(3.43)		2.67		2.67		(3.43)		(3.43)		(4.17E)		H 3.43E
2550		3.43Z		3.43		3.43		3.43		(4.17)		(4.17E)		H 3.43E
2700		3.43Z		3.43		3.43		3.43		(4.17)		(4.17E)		H 4.17E
2850		4.17Z		4.17		4.17		4.17		4.17		H 4.17E		H 4.17E
3000		4.17Z		4.17		4.17		4.17		4.17		H 4.17E		H 4.17E

Notes:

Thicknesses are based on longitudinal riveted seam fabrication, values in “()” can be reduced by one gage thickness if helical seam fabrication is utilized.

A thickness preceded by an “H” indicates only helical seam fabrication is allowed.

E Elongation according to Article 542.04(e), the elongation requirement for Type 1 fill heights may be eliminated for fills above 450 mm.

Z 450 mm Minimum fill

FAI Route 74/280 & FAI Route 88 (I-74/280 & I-88)
Section D2 DRAINAGE 2016-1
Henry & Whiteside Counties
Contract No. 64L02

Table IIA: THICKNESS FOR CORRUGATED STEEL PIPE ARCHES AND CORRUGATED ALUMINUM ALLOY PIPE ARCHES
FOR THE RESPECTIVE EQUIVALENT ROUND SIZE OF PIPE AND FILL HEIGHTS OVER THE TOP OF PIPE

Equivalent Round Size in.	Corrugated Steel & Aluminum Pipe Arch 2 2/3" x 1/2"		Corrugated Steel & Aluminum Pipe Arch 3" x 1"		Corrugated Steel Pipe Arch 5" x 1"		Min. Cover	Type 1						Type 2						Type 3									
								Fill Height:						Fill Height:						Fill Height:									
								3' and less						Greater than 3' not exceeding 10'						Greater than 10' not exceeding 15'									
	Span (in.)*	Rise (in.)	Span (in.)	Rise (in.)	Span (in.)	Rise (in.)		Steel & Aluminum	Steel			Aluminum			Steel			Aluminum			Steel			Aluminum					
2 2/3" x 1/2"							3"x1"		5" x 1"	2 2/3" x 1/2"	3"x1"	2 2/3" x 1/2"	3"x1"	5" x 1"	2 2/3" x 1/2"	3"x1"	5" x 1"	2 2/3" x 1/2"	3"x1"	5" x 1"	2 2/3" x 1/2"	3"x1"	5" x 1"	2 2/3" x 1/2"	3"x1"	5" x 1"			
15	17	13				1'-6"	0.064			0.060		0.064			0.060		0.064			0.060		0.064			0.060			0.060	
18	21	15				1'-6"	0.064			0.060		0.064			0.060		0.064			0.060		0.064			0.060			0.060	
21	24	18				1'-6"	0.064			(0.075)		0.064			0.060		0.064			0.060		0.064			0.060			0.060	
24	28	20				1'-6"	(0.079)			(0.105)		0.064			0.075		0.064			0.075		0.064			0.075			0.075	
30	35	24				1'-6"	(0.079)			(0.105)		0.064			0.075		0.064			0.075		0.064			0.075			(0.105)	
36	42	29				1'-6"	(0.079)			0.105		0.064			0.105		0.064			0.105		0.064			0.105			0.105	
42	49	33				1'-6"	0.109			0.105		(0.109)			0.105		(0.109)			0.105		(0.109)			0.105			0.105	
48	57	38	53	41	53	41	1'-6"	0.109	(0.109)	(0.109)	0.135	0.060	0.109	0.079	0.079	0.135	0.060	0.109	0.079	(0.109)	0.135	0.060	0.109	0.079	(0.109)	0.135	0.060	0.109	0.060
54	64	43	60	46	60	46	1'-6"	0.109	(0.109)	0.109	0.164	(0.075)	0.109	0.079	0.079	0.164	0.060	0.109	0.079	(0.109)	0.164	0.060	0.109	0.079	(0.109)	0.164	(0.075)	0.109	(0.075)
60	71	47	66	51	66	51	1'-6"	0.138	(0.109)	0.109	0.164	(0.075)	0.138	0.079	(0.109)	0.164	0.060	0.138	(0.109)	0.109	0.164	(0.075)	0.138	(0.109)	0.109	0.164	(0.075)	0.138	(0.075)
66	77	52	73	55	73	55	1'-6"	0.168	(0.109)	0.109		0.075	0.168	0.079	(0.109)		0.075	0.168	(0.109)	0.109		0.075	0.168	(0.109)	0.109		0.075	0.075	
72	83	57	81	59	81	59	1'-6"	0.168	(0.109)	0.109		0.105	0.168	0.079	(0.109)		0.105	0.168	(0.109)	0.109		0.105	0.168	(0.109)	0.109		0.105	0.105	
78			87	63	87	63	1'-6"		0.109	0.109		0.105		(0.109)	0.109		0.105		(0.109)	0.109		0.105		(0.109)	0.109		0.105	0.105	
84			95	67	95	67	1'-6"		0.109	0.109		0.105		(0.109)	0.109		0.105		(0.109)	0.109		0.105		(0.109)	0.109		0.105	0.105	
90			103	71	103	71	1'-6"		0.109	0.109		0.135		(0.109)	0.109		0.135		(0.109)	0.109		0.135		(0.109)	0.109		0.135	0.135	
96			112	75	112	75	1'-6"		0.109	(0.138)		0.164		0.109	0.109		0.164		0.109	0.109		0.164		0.109	(0.138)		0.164	0.164	
102			117	79	117	79	1'-6"		0.109	(0.138)		0.164		0.109	0.109		0.164		0.109	0.109		0.164		0.109	(0.138)		0.164	0.164	
108			128	83	128	83	1'-6"		0.138	0.138				0.138	0.138				0.138	0.138				0.138	0.138			0.138	0.138
114			137	87	137	87	1'-6"		0.138	0.138				0.138	0.138				0.138	0.138				0.138	0.138			0.138	0.138
120			142	91	142	91	1'-6"		0.168	0.168				0.168	0.168				0.168	0.168				0.168	0.168			0.168	0.168

Notes:

- * Aluminized Type 2 Steel or Precoated Galvanized Steel shall be required for steel spans up to 42" according to Article 1006.01.
- Thicknesses are based on longitudinal riveted seam fabrication, values in "()" can be reduced by one gage thickness if helical seam fabrication is utilized.
- The Type 1 corrugated steel or aluminum pipe arches shall be placed on soil having a minimum bearing capacity of 3 tons per square foot.
- The Type 2 and 3 corrugated steel or aluminum pipe arches shall be placed on soil having a minimum bearing capacity of 2 tons per square foot.
- This minimum bearing capacity will be determined by the Engineer in the field.

FAI Route 74/280 & FAI Route 88 (I-74/280 & I-88)
Section D2 DRAINAGE 2016-1
Henry & Whiteside Counties
Contract No. 64L02

Table IIA: THICKNESS FOR CORRUGATED STEEL PIPE ARCHES AND CORRUGATED ALUMINUM ALLOY PIPE ARCHES
FOR THE RESPECTIVE EQUIVALENT ROUND SIZE OF PIPE AND FILL HEIGHTS OVER THE TOP OF PIPE
(Metric)

Equivalent Round Size (mm)	Corrugated Steel & Aluminum Pipe Arch 68 x 13 mm		Corrugated Steel & Aluminum Pipe Arch 75 x 25 mm		Corrugated Steel Pipe Arch 125 x 25 mm		Min. Cover	Type 1					Type 2					Type 3					
	Fill Height:																						
	1 m and less					Greater than 1 m not exceeding 3 m					Greater than 3 m not exceeding 4.5 m												
	Span Rise (mm)* (mm)		Span Rise (mm) (mm)		Span Rise (mm) (mm)			Steel & Aluminum	Steel			Aluminum		Steel			Aluminum		Steel			Aluminum	
68 x 13 mm	75 x 25 mm	125 x 25 mm	68 x 13 mm	75 x 25 mm	68 x 13 mm	75 x 25 mm	125 x 25 mm		68 x 13 mm	75 x 25 mm	68 x 13 mm	75 x 25 mm	125 x 25 mm	68 x 13 mm	75 x 25 mm	68 x 13 mm	75 x 25 mm	125 x 25 mm	68 x 13 mm	75 x 25 mm			
375	430	330					0.5 m	1.63			1.52		1.63		1.52		1.63			1.52			
450	530	380					0.5 m	1.63		1.52		1.63		1.52		1.63				1.52			
525	610	460					0.5 m	1.63		(1.91)		1.63		1.52		1.63				1.52			
600	710	510					0.5 m	(2.01)		(2.67)		1.63		1.91		1.63				1.91			
750	870	630					0.5 m	(2.01)		(2.67)		1.63		1.91		(2.01)				(2.67)			
900	1060	740					0.5 m	(2.01)		2.67		1.63		2.67		1.63				2.67			
1050	1240	840					0.5 m	2.77		2.67		(2.77)		2.67		(2.77)				2.67			
1200	1440	970	1340	1050	1340	1050	0.5 m	2.77	(2.77)	(2.77)	3.43	1.52	2.77	2.01	2.01	3.43	1.52	2.77	2.01	(2.77)	3.43	1.52	
1350	1620	1100	1520	1170	1520	1170	0.5 m	2.77	(2.77)	2.77	4.17	(1.91)	2.77	2.01	2.01	4.17	1.52	2.77	(2.77)	2.77	4.17	(1.91)	
1500	1800	1200	1670	1300	1670	1300	0.5 m	3.51	(2.77)	2.77	4.17	(1.91)	3.51	2.01	(2.77)	4.17	1.52	3.51	(2.77)	2.77	4.17	(1.91)	
1650	1950	1320	1850	1400	1850	1400	0.5 m	4.27	(2.77)	2.77		1.91	4.27	2.01	(2.77)		1.91	4.27	(2.77)	2.77		1.91	
1800	2100	1450	2050	1500	2050	1500	0.5 m	4.27	(2.77)	2.77		2.67	4.27	2.01	(2.77)		2.67	4.27	(2.77)	2.77		2.67	
1950			2200	1620	2200	1620	0.5 m			2.77	2.77		2.67	(2.77)	2.77		2.67		2.77	2.77		2.67	
2100			2400	1720	2400	1720	0.5 m			2.77	2.77		2.67	(2.77)	2.77		2.67		2.77	2.77		2.67	
2250			2600	1820	2600	1820	0.5 m			2.77	2.77		3.43	(2.77)	2.77		3.43		2.77	2.77		3.43	
2400			2840	1920	2840	1920	0.5 m			2.77	(3.51)		4.17		2.77	2.77		4.17		2.77	(3.51)		4.17
2550			2970	2020	2970	2020	0.5 m			2.77	(3.51)		4.17		2.77	2.77		4.17		2.77	(3.51)		4.17
2700			3240	2120	3240	2120	0.5 m			3.51	3.51			3.51	3.51				3.51	3.51			
2850			3470	2220	3470	2220	0.5 m			3.51	3.51			3.51	3.51				3.51	3.51			
3000			3600	2320	3600	2320	0.5 m			4.27	4.27			4.27	4.27				4.27	4.27			

Notes:

- * Aluminized Type 2 Steel or Precoated Galvanized Steel shall be required for steel spans up to 1060 mm according to Article 1006.01.
- Thicknesses are based on longitudinal riveted seam fabrication, values in "()" can be reduced by one gage thickness if helical seam fabrication is utilized.
- The Type 1 corrugated steel or aluminum pipe arches shall be placed on soil having a minimum bearing capacity of 290 kN per square meter.
- The Type 2 and 3 corrugated steel or aluminum pipe arches shall be placed on soil having a minimum bearing capacity of 192 kN per square meter.
- This minimum bearing capacity will be determined by the Engineer in the field.

Table IIB: CLASSES OF REINFORCED CONCRETE ELLIPTICAL AND REINFORCED CONCRETE ARCH PIPE FOR THE RESPECTIVE EQUIVALENT ROUND SIZE OF PIPE AND FILL HEIGHTS OVER THE TOP OF PIPE											
Equivalent Round Size (in.)	Reinforced Concrete Elliptical pipe (in.)		Reinforced Concrete Arch pipe (in.)		Minimum Cover	Type 1		Type 2		Type 3	
						Fill Height: 3' and less		Fill Height: Greater than 3' not exceeding 10'		Fill Height: Greater than 10' not exceeding 15'	
	Span	Rise	Span	Rise	RCCP HE & A	HE	Arch	HE	Arch	HE	Arch
15	23	14	18	11	1' -0"	HE-III	A-III	HE-III	A-III	HE-IV	A-IV
18	23	14	22	13 1/2	1' -0"	HE-III	A-III	HE-III	A-III	HE-IV	A-IV
21	30	19	26	15 1/2	1' -0"	HE-III	A-III	HE-III	A-III	HE-IV	A-IV
24	30	19	28 1/2	18	1' -0"	HE-III	A-III	HE-III	A-III	HE-IV	A-IV
27	34	22	36 1/4	22 1/2	1' -0"	HE-III	A-III	HE-III	A-III	HE-IV	A-IV
30	38	24	36 1/4	22 1/2	1' -0"	HE-III	A-III	HE-III	A-III	HE-IV	A-IV
36	45	29	43 3/4	26 5/8	1' -0"	HE-II	A-II	HE-III	A-III	HE-IV	A-IV
42	53	34	51 1/8	31 5/16	1' -0"	HE-I	A-II	HE-III	A-III	HE-IV	A-IV
48	60	38	58 1/2	36	1' -0"	HE-I	A-II	HE-III	A-III	1460	1450
54	68	43	65	40	1' -0"	HE-I	A-II	HE-III	A-III	1460	1460
60	76	48	73	45	1' -0"	HE-I	A-II	HE-III	A-III	1460	1470
66	83	53	88	54	1' -0"	HE-I	A-II	HE-III	A-III	1470	1480
72	91	58	88	54	1' -0"	HE-I	A-II	HE-III	A-III	1470	1480

Notes:

A number indicates the D-Load for the diameter and depth of fill and that a special design is required.

Design assumptions; Water filled pipe, AASHTO Type 2 installation per AASHTO LRFD Table 12.10.2.1-1

FAI Route 74/280 & FAI Route 88 (I-74/280 & I-88)
Section D2 DRAINAGE 2016-1
Henry & Whiteside Counties
Contract No. 64L02

Table IIB: CLASSES OF REINFORCED CONCRETE ELLIPTICAL AND REINFORCED CONCRETE ARCH PIPE
FOR THE RESPECTIVE EQUIVALENT ROUND SIZE OF PIPE AND FILL HEIGHTS OVER THE TOP OF PIPE
(Metric)

Equivalent Round Size (mm)	Reinforced Concrete Elliptical pipe (mm)		Reinforced Concrete Arch pipe (mm)		Minimum Cover RCCP HE & A	Type 1		Type 2		Type 3	
	Span	Rise	Span	Rise		Fill Height: 1 m and less		Fill Height: Greater than 1 m not exceeding 3 m		Fill Height: Greater than 3 m not exceeding 4.5 m	
					HE	Arch	HE	Arch	HE	Arch	
375	584	356	457	279	0.3 m	HE-III	A-III	HE-III	A-III	HE-IV	A-IV
450	584	356	559	343	0.3 m	HE-III	A-III	HE-III	A-III	HE-IV	A-IV
525	762	483	660	394	0.3 m	HE-III	A-III	HE-III	A-III	HE-IV	A-IV
600	762	483	724	457	0.3 m	HE-III	A-III	HE-III	A-III	HE-IV	A-IV
686	864	559	921	572	0.3 m	HE-III	A-III	HE-III	A-III	HE-IV	A-IV
750	965	610	921	572	0.3 m	HE-III	A-III	HE-III	A-III	HE-IV	A-IV
900	1143	737	1111	676	0.3 m	HE-II	A-II	HE-III	A-III	HE-IV	A-IV
1050	1346	864	1299	795	0.3 m	HE-I	A-II	HE-III	A-III	HE-IV	A-IV
1200	1524	965	1486	914	0.3 m	HE-I	A-II	HE-III	A-III	70	70
1350	1727	1092	1651	1016	0.3 m	HE-I	A-II	HE-III	A-III	70	70
1500	1930	1219	1854	1143	0.3 m	HE-I	A-II	HE-III	A-III	70	70
1676	2108	1346	2235	1372	0.3 m	HE-I	A-II	HE-III	A-III	70	70
1800	2311	1473	2235	1372	0.3 m	HE-I	A-II	HE-III	A-III	70	70

Notes:
A number indicates the D-Load for the diameter and depth of fill and that a special design is required.
Design assumptions; Water filled pipe, AASHTO Type 2 installation per AASHTO LRFD Table 12.10.2.1-1

TABLE IIIA: PLASTIC PIPE PERMITTED
FOR A GIVEN PIPE DIAMETER AND FILL HEIGHT OVER THE TOP OF THE PIPE

Nominal Diameter (in.)	Type 1					Type 2					Type 3					Type 4			
	Fill Height: 3' and less, with 1' min					Fill Height: Greater than 3', not exceeding 10'					Fill Height: Greater than 10', not exceeding 15'					Fill Height: Greater than 15', not exceeding 20'			
	PVC	CPVC	PE	CPE	CPP	PVC	CPVC	PE	CPE	CPP	PVC	CPVC	PE	CPE	CPP	PVC	CPVC	PE	CPP
10	X	X	X	X	NA	X	X	X	X	NA	X	X	X	X	NA	X	X	X	NA
12	X	X	X	X	X	X	X	X	X	X	X	X	X	NA	X	X	X	X	NA
15	X	X	NA	X	X	X	X	NA	X	X	X	X	NA	NA	X	X	X	NA	X
18	X	X	X	X	X	X	X	X	X	X	X	X	X	NA	X	X	X	X	NA
21	X	X	NA	NA	NA	X	X	NA	NA	NA	X	X	NA	NA	NA	X	X	NA	NA
24	X	X	X	X	X	X	X	X	X	X	X	X	NA	NA	NA	X	X	X	NA
30	X	X	X	X	X	X	X	X	X	X	X	X	X	NA	X	X	X	X	NA
36	X	X	X	X	X	X	X	X	X	X	X	X	X	NA	NA	X	X	X	NA
42	X	NA	X	X	NA	X	NA	X	NA	NA	X	NA	X	NA	NA	X	NA	X	NA
48	X	NA	X	X	X	X	NA	X	NA	NA	X	NA	X	NA	NA	X	NA	X	NA

- Notes:
- PVC Polyvinyl Chloride (PVC) pipe with a smooth interior
 - CPVC Corrugated Polyvinyl Chloride (CPVC) pipe with a smooth interior
 - PE Polyethylene (PE) pipe with a smooth interior
 - CPE Corrugated Polyethylene (PE) pipe with a smooth interior
 - CPP Corrugated Polypropylene (CPP) pipe with a smooth interior
 - X This material may be used for the given pipe diameter and fill height
 - NA Not Available

TABLE IIIA: PLASTIC PIPE PERMITTED
FOR A GIVEN PIPE DIAMETER AND FILL HEIGHT OVER THE TOP OF THE PIPE
(Metric)

Nominal Diameter (mm)	Type 1					Type 2					Type 3					Type 4			
	Fill Height: 1 m and less, with 0.3 m min. cover					Fill Height: Greater than 1 m, not exceeding 3 m					Fill Height: Greater than 3 m, not exceeding 4.5 m					Fill Height: Greater than 4.5 m, not exceeding 6 m			
	PVC	CPVC	PE	CPE	CPP	PVC	CPVC	PE	CPE	CPP	PVC	CPVC	PE	CPE	CPP	PVC	CPVC	PE	CPP
250	X	X	X	X	NA	X	X	X	X	NA	X	X	X	X	NA	X	X	X	NA
300	X	X	X	X	X	X	X	X	X	X	X	X	X	NA	X	X	X	X	NA
375	X	X	NA	X	X	X	X	NA	X	X	X	X	NA	NA	X	X	X	NA	X
450	X	X	X	X	X	X	X	X	X	X	X	X	X	NA	X	X	X	X	NA
525	X	X	NA	NA	NA	X	X	NA	NA	NA	X	X	NA	NA	NA	X	X	NA	NA
600	X	X	X	X	X	X	X	X	X	X	X	X	NA	NA	NA	X	X	X	NA
750	X	X	X	X	X	X	X	X	X	X	X	X	X	NA	X	X	X	X	NA
900	X	X	X	X	X	X	X	X	X	X	X	X	X	NA	NA	X	X	X	NA
1000	X	NA	X	X	NA	X	NA	X	NA	NA	X	NA	X	NA	NA	X	NA	X	NA
1200	X	NA	X	X	X	X	NA	X	NA	NA	X	NA	X	NA	NA	X	NA	X	NA

Notes:

- PVC Polyvinyl Chloride (PVC) pipe with a smooth interior
- CPVC Corrugated Polyvinyl Chloride (CPVC) pipe with a smooth interior
- PE Polyethylene (PE) pipe with a smooth interior
- CPE Corrugated Polyethylene (PE) pipe with a smooth interior
- CPP Corrugated Polypropylene (CPP) pipe with a smooth interior
- X This material may be used for the given pipe diameter and fill height
- NA Not Available

TABLE IIIB: PLASTIC PIPE PERMITTED								
FOR A GIVEN PIPE DIAMETER AND FILL HEIGHT OVER THE TOP OF THE PIPE								
Nominal Diameter (in.)	Type 5			Type 6			Type 7	
	Fill Height: Greater than 20', not exceeding 25'			Fill Height: Greater than 25', not exceeding 30'			Fill Height: Greater than 30', not exceeding 35'	
	PVC	CPVC		PVC	CPVC		CPVC	
10	X	X		X	X		X	
12	X	X		X	X		X	
15	X	X		X	X		X	
18	X	X		X	X		X	
21	X	X		X	X		X	
24	X	X		X	X		X	
30	X	X		X	X		X	
36	X	X		X	X		X	
42	X	NA		X	NA		NA	
48	X	NA		X	NA		NA	

Notes:
 PVC Polyvinyl Chloride (PVC) pipe with a smooth interior
 CPVC Corrugated Polyvinyl Chloride (CPVC) pipe with a smooth interior
 X This material may be used for the given pipe diameter and fill height
 NA Not Available

TABLE IIIB: PLASTIC PIPE PERMITTED FOR A GIVEN PIPE DIAMETER AND FILL HEIGHT OVER THE TOP OF THE PIPE (metric)								
Nominal Diameter (mm)	Type 5			Type 6			Type 7	
	Fill Height: Greater than 6 m, not exceeding 7.5 m			Fill Height: Greater than 7.5 m, not exceeding 9 m			Fill Height: Greater than 9 m, not exceeding 10.5 m	
	PVC	CPVC		PVC	CPVC		CPVC	
250	X	X		X	X		X	
300	X	X		X	X		X	
375	X	X		X	X		X	
450	X	X		X	X		X	
525	X	X		X	X		X	
600	X	X		X	X		X	
750	X	X		X	X		X	
900	X	X		X	X		X	
1000	X	NA		X	NA		NA	
1200	X	NA		X	NA		NA	

- Notes:
- PVC Polyvinyl Chloride (PVC) pipe with a smooth interior
 - CPVC Corrugated Polyvinyl Chloride (CPVC) pipe with a smooth interior
 - PE Polyethylene (PE) pipe with a smooth interior
 - X This material may be used for the given pipe diameter and fill height
 - NA Not Available"

Revise the first sentence of the first paragraph of Article 542.04(c) of the Standard Specifications to read:

“Compacted aggregate, at least 4 in. (100 mm) in depth below the pipe culvert, shall be placed the entire width of the trench and for the length of the pipe culvert, except compacted impervious material shall be used for the outer 3 ft (1 m) at each end of the pipe culvert.”

Revise the seventh paragraph of Article 542.04(d) of the Standard Specifications to read:

“PVC, PE and CPP pipes shall be joined according to the manufacturer’s specifications.”

Replace the third sentence of the first paragraph of Article 542.04(h) of the Standard Specifications with the following:

“The total cover required for various construction loadings shall be the responsibility of the Contractor.”

Delete “Table IV : Wheel Loads and Total Cover” in Article 542.04(h) of the Standard Specifications.

Revise the first and second paragraphs of Article 542.04(i) of the Standard Specifications to read:

“(i) Deflection Testing for Pipe Culverts. All PE, PVC and CPP pipe culverts shall be tested for deflection not less than 30 days after the pipe is installed and the backfill compacted. The testing shall be performed in the presence of the Engineer.

For PVC, PE, and CPP pipe culverts with diameters 24 in. (600 mm) or smaller, a mandrel drag shall be used for deflection testing. For PVC, PE, and CPP pipe culverts with diameters over 24 in. (600 mm), deflection measurements other than by a mandrel shall be used.”

Revise Articles 542.04(i)(1) and (2) of the Standard Specifications to read:

“(1) For all PVC pipe: as defined using ASTM D 3034 methodology.

(2) For all PE and CPP pipe: the average inside diameter based on the minimum and maximum tolerances specified in the corresponding ASTM or AASHTO material specifications.”

Revise the second sentence of the second paragraph of Article 542.07 of the Standard Specifications to read:

“When a prefabricated end section is used, it shall be of the same material as the pipe culvert, except for polyethylene (PE), polyvinylchloride (PVC), and polypropylene (PP) pipes which shall have metal end sections.”

Revise the first paragraph of Article 1040.03 of the Standard Specifications to read:

“1040.03 Polyvinyl Chloride (PVC) Pipe. Acceptance testing of PVC pipe and fittings shall be accomplished during the same construction season in which they are installed. The section properties shall be according to the manufacturer pre-submitted geometric properties on file with the Department. The manufacturer shall submit written certification that the material meets those properties. The pipe shall meet the following additional requirements.”

Delete Articles 1040.03(e) and (f) of the Standard Specifications.

Revise Articles 1040.04(c) and (d) of the Standard Specifications to read:

“(c) PE Profile Wall Pipe for Insertion Lining. The pipe shall be according to ASTM F 894. When used for insertion lining of pipe culverts, the pipe liner shall have a minimum pipe stiffness of 46 psi (317 kPa) at five percent deflection for nominal inside diameters of 42 in. (1050 mm) or less. For nominal inside diameters of greater than 42 in. (1050 mm), the pipe liner shall have a minimum pipe stiffness of 32.5 psi (225 kPa) at five percent deflection. All sizes shall have wall construction that presents essentially smooth internal and external surfaces.

(d) PE Pipe with a Smooth Interior. The pipe shall be according to ASTM F 714 (DR 32.5) with a minimum cell classification of PE 335434 as defined in ASTM D 3350. The section properties shall be according to the manufacturer pre-submitted geometric properties on file with the Department. The manufacturer shall submit written certification that the material meets those properties and the resin used to manufacture the pipe meets or exceeds the minimum cell classification requirements.”

Add the following to Section 1040 of the Standard Specifications:

“1040.08 Polypropylene (PP) Pipe. Storage and handling shall be according to the manufacturer's recommendations, except in no case shall the pipe be exposed to direct sunlight for more than six months. Acceptance testing of the pipe shall be accomplished during the same construction season in which it is installed. The section properties shall be according to the manufacturer pre-submitted geometric properties on file with the Department. The manufacturer shall submit written certification that the material meets those properties. The pipe shall meet the following additional requirements.

(a) Corrugated PP Pipe with a Smooth Interior. The pipe shall be according to AAHSTO M 330 (nominal size – 12 to 60 in. (300 to 1500 mm)). The pipe shall be Type S or D.

(b) Perforated Corrugated PP Pipe with A Smooth Interior. The pipe shall be according to AASHTO M 330 (nominal size – 12 to 60 in. (300 to 1500 mm)). The pipe shall be Type SP. In addition, the top centerline of the pipe shall be marked so that it is readily visible from the top of the trench before backfilling, and the upper ends of the slot perforations shall be a minimum of ten degrees below the horizontal.”

PAVEMENT PATCHING (BDE)

Effective: January 1, 2010

Revise the first sentence of the second paragraph of Article 701.17(e)(1) of the Standard Specifications to read:

“In addition to the traffic control and protection shown elsewhere in the contract for pavement, two devices shall be placed immediately in front of each open patch, open hole, and broken pavement where temporary concrete barriers are not used to separate traffic from the work area.”

PROGRESS PAYMENTS (BDE)

Effective: November 2, 2013

Revise Article 109.07(a) of the Standard Specifications to read:

“(a) Progress Payments. At least once each month, the Engineer will make a written estimate of the quantity of work performed in accordance with the contract, and the value thereof at the contract unit prices. The amount of the estimate approved as due for payment will be vouchered by the Department and presented to the State Comptroller for payment. No amount less than \$1000.00 will be approved for payment other than the final payment.

Progress payments may be reduced by liens filed pursuant to Section 23(c) of the Mechanics' Lien Act, 770 ILCS 60/23(c).

If a Contractor or subcontractor has defaulted on a loan issued under the Department's Disadvantaged Business Revolving Loan Program (20 ILCS 2705/2705-610), progress payments may be reduced pursuant to the terms of that loan agreement. In such cases, the amount of the estimate related to the work performed by the Contractor or subcontractor, in default of the loan agreement, will be offset, in whole or in part, and vouchered by the Department to the Working Capital Revolving Fund or designated escrow account. Payment for the work shall be considered as issued and received by the Contractor or subcontractor on the date of the offset voucher. Further, the amount of the offset voucher shall be a credit against the Department's obligation to pay the Contractor, the Contractor's obligation to pay the subcontractor, and the Contractor's or subcontractor's total loan indebtedness to the Department. The offset shall continue until such time as the entire loan indebtedness is satisfied. The Department will notify the Contractor and Fund Control Agent in a timely manner of such offset. The Contractor or subcontractor shall not be entitled to additional payment in consideration of the offset.

The failure to perform any requirement, obligation, or term of the contract by the Contractor shall be reason for withholding any progress payments until the Department determines that compliance has been achieved.”

REINFORCEMENT BARS (BDE)

Effective: November 1, 2013

Revise the first and second paragraphs of Article 508.05 of the Standard Specifications to read:

“508.05 Placing and Securing. All reinforcement bars shall be placed and tied securely at the locations and in the configuration shown on the plans prior to the placement of concrete. Manual welding of reinforcement may only be permitted on precast concrete products as indicated in the current Bureau of Materials and Physical Research Policy Memorandum “Quality Control / Quality Assurance Program for Precast Concrete Products”, and for precast prestressed concrete products as indicated in the Department’s current “Manual for Fabrication of Precast Prestressed Concrete Products”. Reinforcement bars shall not be placed by sticking or floating into place or immediately after placement of the concrete.

Bars shall be tied at all intersections, except where the center to center dimension is less than 1 ft (300 mm) in each direction, in which case alternate intersections shall be tied. Molded plastic clips may be used in lieu of wire to secure bar intersections, but shall not be permitted in horizontal bar mats subject to construction foot traffic or to secure longitudinal bar laps. Plastic clips shall adequately secure the reinforcement bars, and shall permit the concrete to flow through and fully encase the reinforcement. Plastic clips may be recycled plastic, and shall meet the approval of the Engineer. The number of ties as specified shall be doubled for lap splices at the stage construction line of concrete bridge decks when traffic is allowed on the first completed stage during the pouring of the second stage.”

Revise the fifth paragraph of Article 508.05 of the Standard Specifications to read:

“Supports for reinforcement in bridge decks shall be metal. For all other concrete construction the supports shall be metal or plastic. Metal bar supports shall be made of cold-drawn wire, or other approved material and shall be either epoxy coated, galvanized or plastic tipped. When the reinforcement bars are epoxy coated, the metal supports shall be epoxy coated. Plastic supports may be recycled plastic. Supports shall be provided in sufficient number and spaced to provide the required clearances. Supports shall adequately support the reinforcement bars, and shall permit the concrete to flow through and fully encase the reinforcement. The legs of supports shall be spaced to allow an opening that is a minimum 1.33 times the nominal maximum aggregate size used in the concrete. Nominal maximum aggregate size is defined as the largest sieve which retains any of the aggregate sample particles. All supports shall meet the approval of the Engineer.”

Revise the first sentence of the eighth paragraph of Article 508.05 of the Standard Specifications to read:

“Epoxy coated reinforcement bars shall be tied with plastic coated wire, epoxy coated wire, or molded plastic clips where allowed.”

Add the following sentence to the end of the first paragraph of Article 508.06(c) of the Standard Specifications:

“In addition, the total slip of the bars within the splice sleeve of the connector after loading in tension to 30 ksi (207 MPa) and relaxing to 3 ksi (20.7 MPa) shall not exceed 0.01 in. (254 microns).”

Revise Article 1042.03(d) of the Standard Specifications to read:

“(d) Reinforcement and Accessories: The concrete cover over all reinforcement shall be within $\pm 1/4$ in. (± 6 mm) of the specified cover.

Welded wire fabric shall be accurately bent and tied in place.

Miscellaneous accessories to be cast into the concrete or for forming holes and recesses shall be carefully located and rigidly held in place by bolts, clamps, or other effective means. If paper tubes are used for vertical dowel holes, or other vertical holes which require grouting, they shall be removed before transportation to the construction site.”

SIDEWALK, CORNER, OR CROSSWALK CLOSURE (BDE)

Effective: January 1, 2015

Revised: April 1, 2015

Revise the first sentence of Article 1106.02(m) of the Supplemental Specifications to read:

“The top and bottom panels shall have alternating white and orange stripes sloping 45 degrees on both sides.”

SPEED DISPLAY TRAILER (BDE)

Effective: April 2, 2014

Add the following to Article 701.15(l) of the Standard Specifications:

“(l) Speed Display Trailer. A speed display trailer shall be utilized on freeways and expressways as part of Highway Standard 701400. The trailer shall be placed on the right hand side of the roadway adjacent to, or within 100 ft (30 m) beyond, the first work zone speed limit sign.

Whenever the speed display trailer is not in use, it shall be considered non-operating equipment and shall be stored according to Article 701.11.”

Add the following to Article 701.20 of the Standard Specifications:

“(k) Speed Display Trailer will be paid for at the contract unit price per calendar month or fraction thereof for each trailer as SPEED DISPLAY TRAILER.”

Add the following to Article 1106.02 of the Standard Specifications:

“(o) Speed Display Trailer. The speed display trailer shall consist of a LED speed indicator display with self-contained, one-direction radar mounted on an orange see-through trailer. The height of the display and radar shall be such that it will function and be visible when located behind concrete barrier.

The speed measurement shall be by radar and provide a minimum detection distance of 1000 ft (300 m). The radar shall have an accuracy of ± 1 mile per hour.

The speed indicator display shall face approaching traffic and shall have a sign legend of “YOUR SPEED” immediately above or below the speed display. The digital speed display shall show two digits (00 to 99) in mph. The color of the changeable message legend shall be a yellow legend on a black background. The minimum height of the numerals shall be 18 in. (450 mm), and the nominal legibility distance shall be at least 750 ft (250 m).

The speed indicator display shall be equipped with a violation alert that flashes the displayed detected speed when the posted limit is exceeded. The speed indicator shall have a maximum speed cutoff. The display shall include automatic dimming for nighttime operation.

The speed indicator measurement and display functions shall be equipped with the power supply capable of providing 24 hours of uninterrupted service.”

TRACKING THE USE OF PESTICIDES (BDE)

Effective: August 1, 2012

Add the following paragraph after the first paragraph of Article 107.23 of the Standard Specifications:

“Within 48 hours of the application of pesticides, including but not limited to herbicides, insecticides, algaecides, and fungicides, the Contractor shall complete and return to the Engineer, Operations form “OPER 2720”.”

WEEKLY DBE TRUCKING REPORTS (BDE)

Effective: June 2, 2012

Revised: April 2, 2015

The Contractor shall submit a weekly report of Disadvantaged Business Enterprise (DBE) trucks hired by the Contractor or subcontractors (i.e. not owned by the Contractor or subcontractors) that are used for DBE goal credit.

The report shall be submitted to the Engineer on Department form “SBE 723” within ten business days following the reporting period. The reporting period shall be Monday through Sunday for each week reportable trucking activities occur.

Any costs associated with providing weekly DBE trucking reports shall be considered as included in the contract unit prices bid for the various items of work involved and no additional compensation will be allowed.

WORKING DAYS (BDE)

Effective: January 1, 2002

The Contractor shall complete the work within 15 working days.

VETERAN BUSINESS PROGRAM

Effective: November 6, 2014

STATE OBLIGATION. This special provision will be used by the Department to satisfy the requirements of the Illinois Procurement Code, 30 ILCS 500/45-57. It is the goal of the State to promote and encourage the continued economic development of small businesses owned and controlled by qualified veterans and that qualified Service-Disabled Veteran-Owned Small Businesses (SDVOSB) and Veteran-Owned Small Businesses (VOSB) participate in the State's procurement process as both prime contractors and subcontractors.

CONTRACT GOAL TO BE ACHIEVED BY THE CONTRACTOR. This contract includes a specific Veteran Small Business participation goal of **0.00%** based on the availability of CMS certified veteran-owned and service-disabled veteran-owned small business (VOSB/SDVOSB) vendors to perform or provide the anticipated services and/or supplies required by this contract.

The Veteran Small Business participation goal is applicable to all bids. In addition to the other award criteria established for this contract, the Department will award this contract to a Vendor that meets the goal or makes good faith efforts to meet the goal. This goal is also applicable to change orders and allowances within the scope of work provided by the certified VOSB/SDVOSB vendor. If Vendor is a CMS certified VOSB/SDVOSB vendor, the entire goal is met and no subcontracting with a CMS certified VOSB/SDVOSB vendor is required; however, Vendor must submit a Utilization Plan indicating that the goal will be met by self-performance.

VETERAN SMALL BUSINESS CERTIFIED VENDOR LOCATOR REFERENCES. Vendors may consult CMS' Veteran Small Business Vendor Directory at www.sell2.illinois.gov/cms/business as well as the directories of other certifying agencies, but firms must be certified with CMS as VOSB/SDVOSB vendors at the time of bid/offer (see Title 44 Illinois Administrative Code Sec. 20.530).

BIDDING PROCEDURES. Compliance with this Special Provision is a material bidding requirement. The failure of the bidder to comply with this special provision will render the bid nonresponsive or not responsible.

At the time of the bid, Vendor, or Vendor's proposed subcontractor, must be certified with CMS as a VOSB or SDVOSB.

Following are guidelines for Vendor's completion of the Utilization Plan.

- (a) The bidder shall submit a Veteran Business Program (VBP) Utilization Plan. The format for the VBP Utilization Plan is included in this special provision.
- (b) Vendor should include any additional information that will add clarity to Vendor's proposed utilization of certified Veteran Small Business vendors to meet the targeted goal. The Utilization Plan must demonstrate that Vendor has either:
 - (1) met the entire contract goal;
 - (2) made good faith efforts towards meeting the entire goal; or

- (3) made good faith efforts towards meeting a portion of the goal. Any submission of good faith efforts by Vendor shall be considered as a request for a full or partial waiver.
- (c) If the bidder is a joint venture comprised of Veteran Business Enterprises (VBE) companies and non-VBE companies, the plan must also include:
 - (1) A clear identification of the portion of work to be performed by the VOSB/SDVOSB partner(s); and
 - (2) An agreement between a vendor and a certified VOSB/SDVOSB vendor in which a certified VOSB/SDVOSB vendor promises not to provide subcontracting or pricing quotations to other vendors is prohibited. The Department may request additional information to demonstrate compliance. Vendor agrees to cooperate promptly with the Department in submitting to interviews, allowing entry to places of business, providing further documentation, and to soliciting the cooperation of a proposed certified VOSB/SDVOSB vendor. Failure to cooperate by Vendor and certified VOSB/SDVOSB vendor may render the bidder nonresponsive or not responsible. The contract will not be awarded to Vendor unless Vendor's Utilization Plan is approved.

GOOD FAITH EFFORT PROCEDURES. Vendor must submit a Utilization Plans and Letters of Intent that meet or exceed the published goal. If Vendor cannot meet the stated goal, Vendor must document and explain within the Utilization Plan the good faith efforts it undertook to meet the goal. Utilization Plans are due at the time of bid. Vendors may not be permitted to correct goal deficiencies after bid due dates. The Department will consider the quality, quantity, and intensity of Vendor's efforts but if the Department determines that a Vendor did not demonstrate good faith efforts towards meeting the goal on the bid, the bid may be deemed nonresponsive or not responsible.

The Utilization Plan contains a checklist of actions that the Department will consider as evidence of Vendor's good faith efforts to meet the goal. Other factors or efforts brought to the attention of the Department may be relevant in appropriate cases.

- (a) In evaluating Vendor's good faith efforts, the Department may consider whether the ability of other bidders to meet the contract goal suggests that good faith efforts could have resulted in Vendor meeting the goal.
- (b) If the Department determines that Vendor has made good faith efforts to meet the goal, the Department may award the contract provided that Vendor is otherwise eligible for award.
- (c) If the Department determines that good faith efforts have not been met, the bidder may be determined to be nonresponsive or not responsible.

CALCULATING CERTIFIED VOSB/SDVOSB VENDOR PARTICIPATION. The Utilization Plan documents work anticipated to be performed by all certified VOSB/SDVOSB vendors and paid for upon satisfactory completion. The Department is only able to count toward the achievement of the overall goal and the contract goal the value of payments made for the work actually performed by the VOSB/SDVOSB vendors. Applicable guidelines for counting payments attributable to contract goals are listed below:

- (a) A Vendor shall count towards the goal only expenditures to firms that perform a commercially useful function in the work of the contract.
 - (1) A firm is considered to perform a commercially useful function when it is responsible for execution of a distinct element of the work of a contract and carries out its responsibilities by actually performing, managing, and supervising the work involved. The certified VOSB/SDVOSB vendor must also be responsible, with respect to materials or supplies used on the contract, for negotiating price, determining quality and quantity, ordering the materials or supplies, and installing the materials (where applicable) and paying for the material or supplies. To determine whether a firm is performing a commercially useful function, the Department shall evaluate the amount of work subcontracted, whether the amount the firm is to be paid under the contract is commensurate with the work it is actually performing and the credit claimed for its performance of the work, industry practices, and other relevant factors.
 - (2) A certified VOSB/SDVOSB vendor does not perform a commercially useful function if its role is limited to that of an extra participant in a transaction or contract through which funds are passed through in order to obtain certified VOSB/SDVOSB vendor participation. In determining whether a certified VOSB/SDVOSB vendor is such an extra participant, the Department shall examine similar transactions, particularly those in which certified VOSB/SDVOSB vendors do not participate, and industry practices.
- (b) The value of the work actually performed or goods/equipment provided by the certified VOSB/SDVOSB vendor shall be counted towards the goal. The entire amount of that portion of the contract that is performed by the certified VOSB/SDVOSB vendor, including supplies purchased or equipment leased by the certified VOSB/SDVOSB vendor shall be counted, except supplies purchased and equipment rented from the Prime Vendor submitting this bid.
- (c) A vendor shall count the portion of the total dollar value of the Veteran Small Business contract equal to the distinct, clearly defined portion of the work of the contract that the certified VOSB/SDVOSB vendor performs toward the goal. A vendor shall also count the dollar value of work subcontracted to other certified VOSB/SDVOSB vendor. Work performed by the non-certified VOSB/SDVOSB party shall not be counted toward the goal. Work that a certified VOSB/SDVOSB vendor subcontracts to a non-certified VOSB/SDVOSB vendor will not count towards the goal.

- (d) A Vendor shall count toward the goal 100% of its expenditures for materials and supplies required under the contract and obtained from a certified VOSB/SDVOSB vendor manufacturer, regular dealer, or supplier. A Vendor shall count toward the goal the following expenditures to certified VOSB/SDVOSB vendors that are not manufacturers, regular dealers, or suppliers.
- (1) The fees or commissions charged for providing a bona fide service, such as professional, technical, consultant or managerial services and assistance in the procurement of essential personnel, facilities, equipment, materials or supplies required for performance of the contract, provided that the fee or commission is determined by the Department to be reasonable and not excessive as compared with fees customarily allowed for similar services.
 - (2) The fees charged for delivery of materials and supplies required by the contract (but not the cost of the materials and supplies themselves) when the hauler, trucker, or delivery service is not also the manufacturer or a supplier of the materials and supplies being procured, provided that the fee is determined by the Department to be reasonable and not excessive as compared with fees customarily allowed for similar services. The certified VOSB/SDVOSB vendor's trucking firm must be responsible for the management and supervision of the entire trucking operation for which it is responsible on the contract, and must itself own and operate at least one fully licensed, insured and operational truck used on the contract.
 - (3) The fees or commissions charged for providing any bonds or insurance specifically required for the performance of the contract, provided that the fee or commission is determined by the Department to be reasonable and not excessive as compared with fees customarily allowed for similar services.
- (e) Certified VOSB/SDVOSB vendors who are performing on contract as second tier subcontractors may be counted in meeting the established Veteran Small Business goal for this contract as long as the Prime Vendor can provide documentation indicating the utilization of these vendors.
- (f) A Vendor shall not count towards the goal expenditures that are not direct, necessary and related to the work of the contract. Only the amount of services or goods that are directly attributable to the performance of the contract shall be counted. Ineligible expenditures include general office overhead or other Vendor support activities.

CONTRACT COMPLIANCE. Compliance with this section is an essential part of the contract. The following administrative procedures and remedies govern Vendor's compliance with the contractual obligations established by the Utilization Plan. After approval of the Plan and award of the contract, the Utilization Plan becomes part of the contract. If Vendor did not succeed in obtaining certified VOSB/SDVOSB vendor participation to achieve the goal and the Utilization Plan was approved and contract awarded based upon a determination of good faith, the total dollar value of certified VOSB/SDVOSB vendor work calculated in the approved Utilization Plan as a percentage of the awarded contract value shall become the contract goal. Vendors are encouraged to seek VOSB/SDVOSB firms during the course of performing the contract.

- (a) NO AMENDMENT. The Utilization Plan may not be amended after contract execution without the Department's prior written approval.
- (b) CHANGES TO WORK. Vendor may not make changes to its contractual certified VOSB/SDVOSB vendor commitments or substitute certified VOSB/SDVOSB vendors without the prior written approval of the Department. Unauthorized changes or substitutions, including performing the work designated for a certified VOSB/SDVOSB vendor with Vendor's own forces, shall be a violation of the utilization plan and a breach of the contract, and shall be cause to terminate the contract, and/or seek other contract remedies or sanctions. The facts supporting the request for changes must not have been known nor reasonably should have been known by the parties prior to entering into the subcontract. Vendor must negotiate with the certified VOSB/SDVOSB vendor to resolve the problem. Where there has been a mistake or disagreement about the scope of work or goods/equipment, provided the certified VOSB/SDVOSB vendor can be substituted only where agreement cannot be reached for a reasonable price or schedule for the correct scope of work, goods or equipment.

Substitutions of a certified VOSB/SDVOSB vendor may be permitted under the following circumstances and possibly others on a case-by-case basis:

- (1) Unavailability after receipt of reasonable notice to proceed;
- (2) Failure of performance;
- (3) Financial incapacity;
- (4) Refusal by the certified VOSB/SDVOSB vendor to honor the bid or proposal price or scope;
- (5) Material mistake of fact or law about the elements of the scope of work of a solicitation where a reasonable price cannot be agreed;
- (6) Failure of the certified VOSB/SDVOSB vendor to meet insurance, licensing or bonding requirements;
- (7) The certified VOSB/SDVOSB vendor's withdrawal of its bid or offer; or
- (8) Decertification of the certified VOSB/SDVOSB vendor.

If it becomes necessary to substitute a certified VOSB/SDVOSB vendor or otherwise change the Utilization Plan, Vendor must notify the Department in writing of the request to substitute a certified VOSB/SDVOSB vendor or otherwise change the Utilization Plan. The request must state specific reasons for the substitution or change. The Department will approve or deny a request for substitution or other change in the Utilization Plan within five business days of receipt of the request.

Where Vendor has established the basis for the substitution to the Department's satisfaction, it must make good faith efforts to meet the contract goal by substituting a certified VOSB/SDVOSB vendor. Documentation of a replacement certified VOSB/SDVOSB vendor, or of good faith efforts to replace the certified VOSB/SDVOSB vendor, must meet the requirements of the initial Utilization Plan. If the goal cannot be reached and good faith efforts have been made, Vendor may substitute with a non-certified VOSB/SDVOSB vendor or Vendor may perform the work.

When adding a VOSB/SDVOSB, a new certified VOSB/SDVOSB vendor agreement should be executed and submitted to the Department with the appropriate subcontractor approval forms prior to the subcontractor's performance of work on the project.

Vendor shall maintain a record of all relevant data with respect to the utilization of certified VOSB/SDVOSB vendors. Full access to these records shall be granted by Vendor upon 48 hours written demand by the Department to any duly authorized representative thereof, or to any municipal, state or federal authorities. The Department shall have the right to obtain from Vendor any additional data reasonably related or necessary to verify any representations by Vendor. After the performance of the final item of work or delivery of material by the certified VOSB/SDVOSB vendor and final payment to the certified VOSB/SDVOSB vendor by Vendor, but not later than 15 calendar days after such payment, Vendor shall submit a statement confirming the final payment and the total payments made to the certified VOSB/SDVOSB vendor under the contract.

The Department will periodically review Vendor's compliance with these provisions and the terms of its contract. Without limitation, Vendor's failure to comply with these provisions or its contractual commitments as contained in the Utilization Plan, failure to cooperate in providing information regarding its compliance with these provisions or its Utilization Plan, or provision of false or misleading information or statements concerning compliance, certification status or eligibility of the certified VOSB/SDVOSB vendor, good faith efforts or any other material fact or representation shall constitute a material breach of this contract and entitle the Department to declare a default, terminate the contract, or exercise those remedies provided for in the contract or at law or in equity.

The Department reserves the right to withhold payment to Vendor to enforce these provisions and Vendor's contractual commitments. Final payment shall not be made pursuant to the contract until Vendor submits sufficient documentation demonstrating compliance with its Utilization Plan.

****RETURN WITH BID****

VETERAN BUSINESS PROGRAM (VBP) UTILIZATION PLAN

The VBP Utilization Plan includes the Letters of Intent and Good Faith Efforts.

(Vendor)_____ submits the following Utilization Plan as part of our bid or offer in accordance with the requirements of the (VBP). We understand that all subcontractors must be certified with the CMS Veteran Small Business Program at the time of submission of all bids. We understand that compliance with this section is an essential part of this contract and that the Utilization Plan will become a part of the contract, if awarded.

Vendor submits the following statement:

- ___ Vendor is a certified VOSB/SDVOSB and plans to fully meet the goal through self-performance.
- ___ Vendor has identified certified VOSB/SDVOSB subcontractor(s) to fully meet the established goal and submits the attached completed Letter(s) of Intent; or
- ___ Vendor has made good faith efforts towards meeting the entire goal, or a portion of the goal, and hereby requests a waiver (complete checklist below).

****RETURN WITH BID****

Vendor's person responsible for compliance:

Name: _____ Title: _____
Telephone: _____ Email: _____

DEMONSTRATION OF GOOD FAITH EFFORTS TO ACHIEVE GOAL AND REQUEST FOR WAIVER

If the Veteran Small Business participation goal was not achieved, the Good Faith Efforts Procedures and Guidelines outlined in Contract Compliance will be used to evaluate submitted utilization plans. Vendors providing Good Faith Effort documentation and request for waiver must complete and submit the Good Faith Effort Contact Log with the bid or offer. Failure to submit Good Faith Effort documentation in its entirety shall render Vendor's bid nonresponsive or not responsible and cause it to be rejected or render Vendor ineligible for contract award. Insufficient Good Faith Effort documentation may render the bidder nonresponsive or not responsible.

Below is a checklist of actions that will be used to evaluate a Vendor's Demonstration of Good Faith Efforts and Request for Waiver. Please check the actions which you completed. If any of the following actions are not completed, please attach a detailed written explanation indicating why such action was not completed. If any other efforts were made to obtain Veteran Small Business participation in addition to the items listed below, attach a detailed description of such efforts.

- _____ Utilize the Sell2Illinois website: www2.illinois.gov/cms/business to identify certified VOSB/SDVOSB vendors within the respective commodity/service codes denoted above and at a minimum email all listed vendors and solicit quotes from all vendors who express an interest via follow-up emails or telephone calls.
- _____ Solicit through all reasonable and available means (e.g., attendance at a vendor conference, advertising and/or written notices) the interest of certified VOSB/SDVOSB vendors that have the capability to perform the work of the contract. Vendor must solicit this interest within sufficient time to allow the certified VOSB/SDVOSB vendors to respond to the solicitation. Vendor must determine with certainty if the certified VOSB/SDVOSB vendors are interested by taking appropriate steps to follow up initial solicitations and encourage them to submit a bid or proposal. Vendor must provide interested certified VOSB/SDVOSB vendors with adequate information about the plans, specifications, and requirements of the contract in a timely manner to assist them in responding promptly to the solicitation.
- _____ Select portions of the work to be performed by certified VOSB/SDVOSB vendors in order to increase the likelihood that the goal will be achieved. This includes, where appropriate, breaking out contract work items into economically feasible units to facilitate certified VOSB/SDVOSB vendor participation, even when Vendor might otherwise prefer to perform these work items with its own forces.
- _____ Make a portion of the work available to certified VOSB/SDVOSB vendors and selecting those portions of the work or material needs consistent with their availability, so as to facilitate certified VOSB/SDVOSB vendor participation.

****RETURN WITH BID****

- _____ Negotiate in good faith with interested certified VOSB/SDVOSB vendors. Evidence of such negotiation must include the names, addresses, email addresses, and telephone numbers of certified VOSB/SDVOSB vendors that were considered; a description of the information provided regarding the plans and specifications for the work selected for subcontracting and evidence as to why additional agreements could not be reached for certified VOSB/SDVOSB vendors to perform the work. A Vendor using good business judgment may consider a number of factors in negotiating with certified VOSB/SDVOSB vendors and may take a firm's price and capabilities into consideration. The fact that there may be some additional costs involved in finding and using certified VOSB/SDVOSB vendors may not be in itself sufficient reason for a Vendor's failure to meet the goal, as long as such costs are reasonable. Vendors are not required to accept higher quotes from certified VOSB/SDVOSB vendors if the price difference is excessive or unreasonable.

- _____ Thoroughly investigate the capabilities of certified VOSB/SDVOSB vendors and not reject them as unqualified without documented reasons.

- _____ Make efforts to assist interested certified VOSB/SDVOSB vendors in obtaining lines of credit or insurance as required by the State.

- _____ Make efforts to assist interested certified VOSB/SDVOSB vendors in obtaining necessary equipment, supplies, materials, or related assistance or services.

****RETURN WITH BID****

GOOD FAITH EFFORTS CONTACT LOG

Use this Log to document all contacts and responses (telephone, e-mail, fax, etc.) regarding the solicitation of certified VOSB/SDVOSB vendors within the specific scope of work selected. It is not necessary to show contacts with certified VOSB/SDVOSB vendors who are identified on the Letter(s) of Intent. Keep and submit copies of all emails sent and received from prospective vendors. Include a copy of the commodity list or scope of work you solicited prospective vendors to perform. Duplicate this log as necessary; do not limit your contacts to the number of spaces shown.

Name of Certified Veteran Small Business Vendor	Date	Method of Contact	Scope of Work Solicited	Reason Agreement Was Not Reached
---	------	----------------------	----------------------------	-------------------------------------

****RETURN WITH BID****

LETTER OF INTENT (LOI)

BETWEEN PRIME VENDOR AND CERTIFIED VETERAN SMALL BUSINESS VENDOR

Instructions: The Bidder is required to submit a separate, signed LOI from each identified certified VOSB/SDVOSB vendor (hereinafter "certified vendors"). **LOIs must be submitted with the Bid and must be signed by both parties.** The Prime Bidder shall not prohibit or otherwise limit certified vendor(s) from providing bids or quotes to other potential bidders. Each LOI shall include the dollar amount, percentage, and scope of work to be performed by each identified certified vendor. All LOI's shall be subject to Department approval.

Any changes involving or affecting the identified certified vendor(s) may not be permitted without written approval of the Department.

Contract Number:

Name of Vendor:

Name of Contact Person:

Address:

City, State and Zip:

Telephone: Fax: Email:

Name of Certified Veteran Small Business Vendor: Name of Contact Person:

Address:

City, State and Zip:

Telephone: Fax: Email:

Proposed % of Contract to be performed by the certified vendor firm: _____%

Proposed dollar amount of Contract to be performed by the certified vendor: \$_____

Description of work to be performed by the certified vendor firm:

Vendor and the Certified vendor above hereby agree that upon the execution of a contract for the above-named project between Bidder and the State of Illinois, the certified vendor will perform the scope of work for the percentage as indicated above.

Bidder (Company Name or D/B/A):

Certified Vendor (Company Name or D/B/A):

Signature:

Signature:

Printed Name:

Printed Name:

Title:

Title:

Date:

Date:

STATE OF ILLINOIS
DEPARTMENT OF TRANSPORTATION
DIVISION OF HIGHWAYS

PROPOSED HIGHWAY PLANS

F.A.I. ROUTE 74 /280 & 88 (I-74 /280 & I-88)
SECTION D2 DRAINAGE 2016-1
HENRY & WHITESIDE COUNTIES
C-92-021-16

FOR INDEX OF SHEETS & STATE STANDARDS
SEE SHEET NO. 1

SECTION	COUNTY	SHEET
14/280 & 88	HENRY & WHITESIDE	1
**D2 DRAINAGE 2016-1		
CONTRACT NO. 64102		
D-92-016-16		

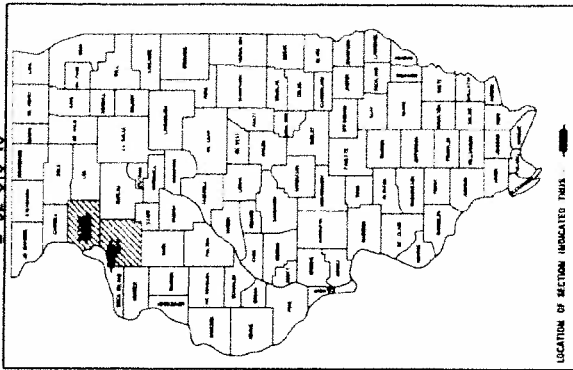

LOCATION OF SECTION INDICATED HERE

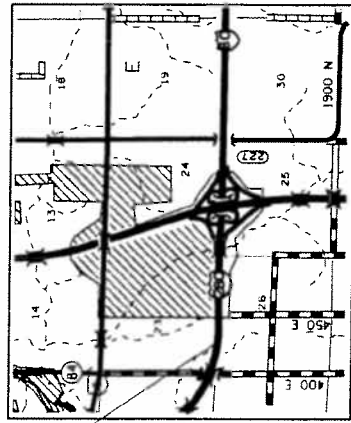
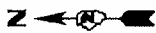

LOCATION 1 (I-74 /280)
STA. 686 + 40

TOWNSHIP (SECTION):
LOCATION 1
COLDNA (23)
LOCATION 2
FENTON (914)

JULIE
JOINT UTILITY LOCATION INFORMATION FOR EXCAVATION
1-800-882-0733

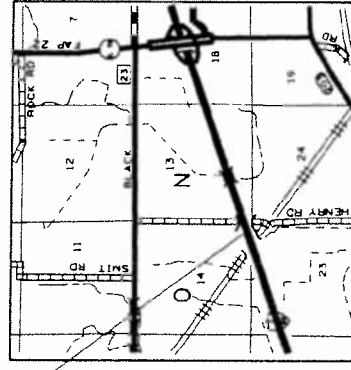

LOCATION 2 (I-88)
STA. 494 + 50

STATE OF ILLINOIS
DEPARTMENT OF TRANSPORTATION
DIVISION OF HIGHWAYS

SUBMITTED Nov. 30TH 2015

David E. [Signature]
DEPUTY DIRECTOR OF HIGHWAYS, REGION ENGINEER

ENGINEER OF DESIGN AND ENVIRONMENT

DIRECTOR OF HIGHWAYS, CHIEF ENGINEER

GROSS LENGTH OF PROJECT = N/A FOOT = N/A MILES
NET LENGTH OF PROJECT = N/A FOOT = N/A MILES

CONTRACT NO. 64102

PRINTED BY THE AUTHORITY
OF THE STATE OF ILLINOIS

INDEX

1	Cover Sheet
2	Index of Sheets / State Standards
3-4	Summary of Quantities
5-6	General Notes
7-12	Plan Sheets
13	Concrete Collars for Pipe or Box Culvert Extensions (D.S. 33.1)
14-17	Remove and Re-Erect Steel Plate Beam Guardrail (D.S. 53.1)

FAI 74/280 & 88 (I-74/280 & I-88)
SECTION D2 DRAINAGE 2016-1
HENRY & WHITESIDE COUNTIES
CONTRACT NO. 64L02
Sheet 2 of 17

STATE STANDARDS

001001-02	AREAS OF REINFORCEMENT BARS
542401-01	METAL END SECTIONS FOR PIPE CULVERTS
610001-06	SHOULDER INLET WITH CURB (FOR INFORMATION ONLY)
701101-04	OFF-ROAD OPERATIONS, MULTILANE, 15' (4.5m) TO 24" (600mm) FROM PAVEMENT EDGE
701106-02	OFF-ROAD OPERATIONS, MULTILANE, MORE THAN 15' (4.5m) AWAY
701400-08	APPROACH TO LANE CLOSURE, FREEWAY / EXPRESSWAY
701401-09	LANE CLOSURE, FREEWAY / EXPRESSWAY
701406-09	LANE CLOSURE, FREEWAY / EXPRESSWAY, DAY OPERATIONS ONLY
701901-04	TRAFFIC CONTROL DEVICES
720011-01	METAL POST FOR SIGNS, MARKERS AND DELINEATORS
728001-01	TELESCOPING STEEL SIGN SUPPORT
729001-01	APPLICATIONS OF TYPES A AND B METAL POST (FOR SIGNS & MARKERS)

SUMMARY OF QUANTITIES

FAI 74290 (174290) & FAI 88 (188)
SECTION D2 DRAINAGE 2016-1
HENRY & WHITESIDE COUNTIES
CONTRACT # 64L02
SHEET 3 OF 17

CODE NO.	ITEM	UNIT	100% State 0044			TOTAL QUANTITY
			HENRY COUNTY	WHITESIDE COUNTY	0044	
20200100	EARTH EXCAVATION	CU YD	25	75	100	
20400800	FURNISHED EXCAVATION	CU YD	25	250	275	
20800150	TRENCH BACKFILL	CU YD	50	50	100	
21301072	EXPLORATION TRENCH 72" DEPTH	FOOT	25		25	
28100207	STONE RIP RAP, CLASS A4	TON	15		15	
44201796	CLASS D PATCHES, TYPE IV, 12 INCH	SQ YD	11	11	22	
50105220	PIPE CULVERT REMOVAL	FOOT	30	30	60	
50800105	REINFORCEMENT BARS	POUND	30	30	60	
542A1069	PIPE CULVERTS, CLASS A, TYPE 2, 24"	FOOT	6	8	16	
542D1069	PIPE CULVERTS, CLASS D, TYPE II, 24"	FOOT	35	45	80	

GENERAL NOTES

The final top 4 inches of soil in any right-of-way area disturbed by the Contractor must be capable of supporting vegetation. The soil must be from the A horizon (zero to 2' deep) of soil profiles of local soils. The cost of this work shall be included in the unit prices bid and no additional compensation will be allowed.

All Borrow/Waste/Use sites must be approved by the Department prior to removing any material from the project or initiating any earthmoving activities, including temporary stockpiling outside the limits of construction.

The Contractor shall seed all disturbed areas within the project limits. Seeding Class 4 or 2A shall be used, except in front of properties where the grass will be mowed, then use Seeding, Class 1. Class 2A shall be used on front slopes and ditch bottoms. Class 4 shall be used behind Type A gutter, on all backslopes and areas behind the backslope, and beyond the toe of front slope on fill sections without ditches. This work will be included in the contract unit price per Cubic Yard for FURNISHED EXCAVATION.

Fertilizer shall be applied to all disturbed areas and incorporated into the seedbed prior to seeding or placement of sod at the rate specified in Sections 250 and 252 of the Standard Specifications. This work shall be included in the cost of FURNISHED EXCAVATION.

Mulch Method II shall be applied over all seeded areas. This shall be included in the cost of the FURNISHED EXCAVATION.

Connecting bands for corrugated metal pipes shall be metal and shall be coated with the same material as the pipe sections. The connecting bands shall be a minimum of 18" wide.

The cost of making culvert connections to existing drainage structures shall be included in the contract unit price for PIPE CULVERTS, OF THE TYPE AND SIZE SPECIFIED.

The Contractor shall be responsible for protecting utility property during construction operations as outlined in Article 107.31 of the Standard Specifications. A minimum of 48 hours advance notice is required for non-emergency work. The JULIE number is 800-892-0123. The following listed utilities located within the project limits or immediately adjacent to the project construction limits are members of JULIE:

Commonwealth Edison	(815)490-2869
Geneseo Telephone Co.	(309)944-8025
MidAmerican Energy Co.	(563)333-8706
MidAmerican Energy Co.	(309)793-3760
Frontier Legacy	(815)772-2078
Mediacom	(309)743-4750
Windstream	(309)282-3110

IDOT is not a member of JULIE. If you are near any overhead lighting, intersection lighting or traffic signals, contact the IDOT Traffic Office at 815/284-5469 at least 48 hours prior to work.

The removal and disposal of the existing concrete collar shall not be paid for separately but shall be included in the cost per CU YD for CONCRETE COLLAR.

A quantity for Pipe Culverts, Class A Type 2, 24" has been included in the plans and shall only be used if the existing concrete culvert at the collar becomes damaged during the removal of the concrete collar.

The contractor shall field verify any elbows needed for the installation of the pipe culverts. The elbows shall not be paid for separately but shall be included in the cost per FOOT for PIPE CULVERTS, CLASS D, TYPE II 24".

All guardrail sections shall be installed and operational over the weekend. The removal and re-erection of the guardrail at each location shall be paid for by the FOOT. The removal and re-erection at each location shall only be measured and paid for one time regardless of the number of times the contractor has to remove and re-erect the guardrail sections.

A quantity for TRENCH BACKFILL has been included in the plans and shall be used only at the direction of the Engineer.

Highway Standard 610001-06 is included in the plans for informational purposes only to show the placement of the CONCRETE THRUST BLOCK. The dimensions shown on the standard are for 12 inch pipe and shall be adjusted for the 24 inch pipe it is to be placed around. It is estimated that 0.75 cubic yards of concrete will be needed in order to place the thrust block. The CONCRETE THRUST BLOCK shall be paid for at the contract unit price per EACH.

LOCATION 1

I-74 /280 STA. 668 + 40 (WEST BOUND)



E400TH STREET

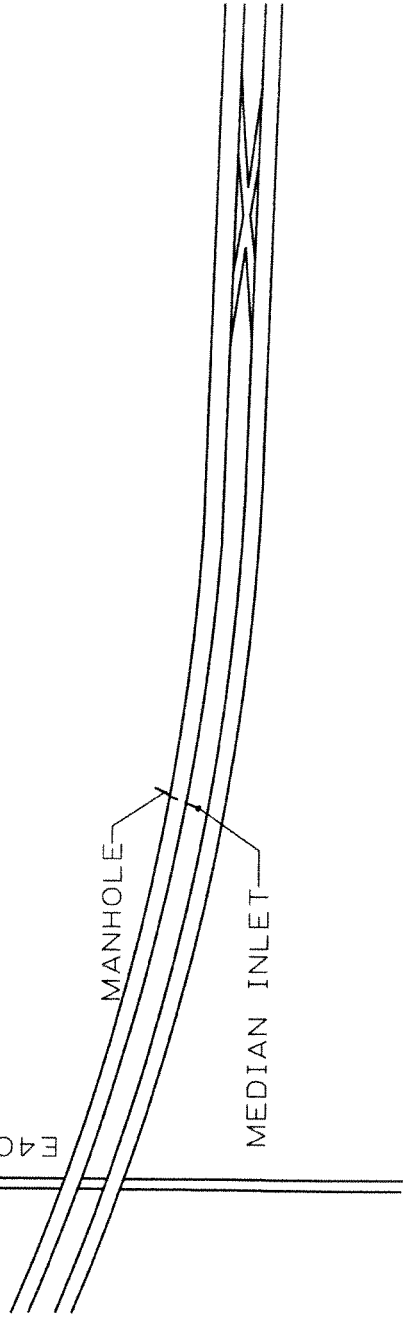

MANHOLE

MEDIAN INLET

I-74/280

FILE NAME D:\A\Projects\74 + 280\Drawings\1.dwg DATE 11/11/2011	DESIGNED DRAWN CHECKED DATE	REVISIONS NO. DESCRIPTION DATE	STATE OF ILLINOIS DEPARTMENT OF TRANSPORTATION	SCALE: SHEET OF SHEETS STA. TO STA. 1" = 40' 0" 1 OF 1 668+00 TO 668+40	
PROJECT NO. I-74/280-01-01		COUNTY COOK COUNTY		SHEET NO. 1 OF 1	
DRAWN BY J. B. BROWN		CHECKED BY J. B. BROWN		DATE 11/11/2011	

LOCATION 2

I-88 STA. 494 + 50 (EAST BOUND)

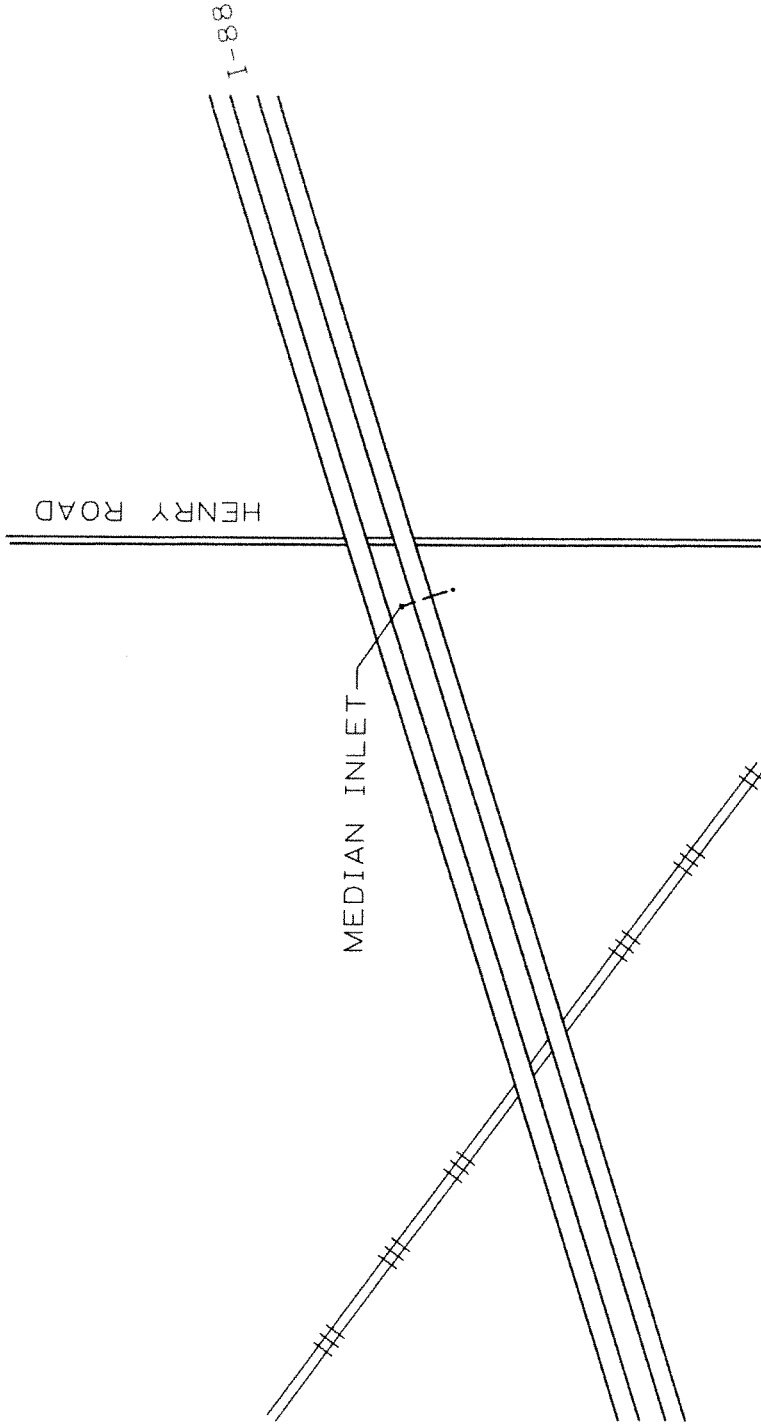

FILE NAME DRAWING NUMBER DATE	DESIGNED CHECKED DATE	REVISIONS NO. 1 DATE BY	SHEET OF SHEETS TO STA. FROM STA.
STATE OF ILLINOIS DEPARTMENT OF TRANSPORTATION		COUNTY DISTRICT PROJECT	

LOCATION 1 (EXISTING)

I-74 /280 STA. 668 + 40 (WEST BOUND)

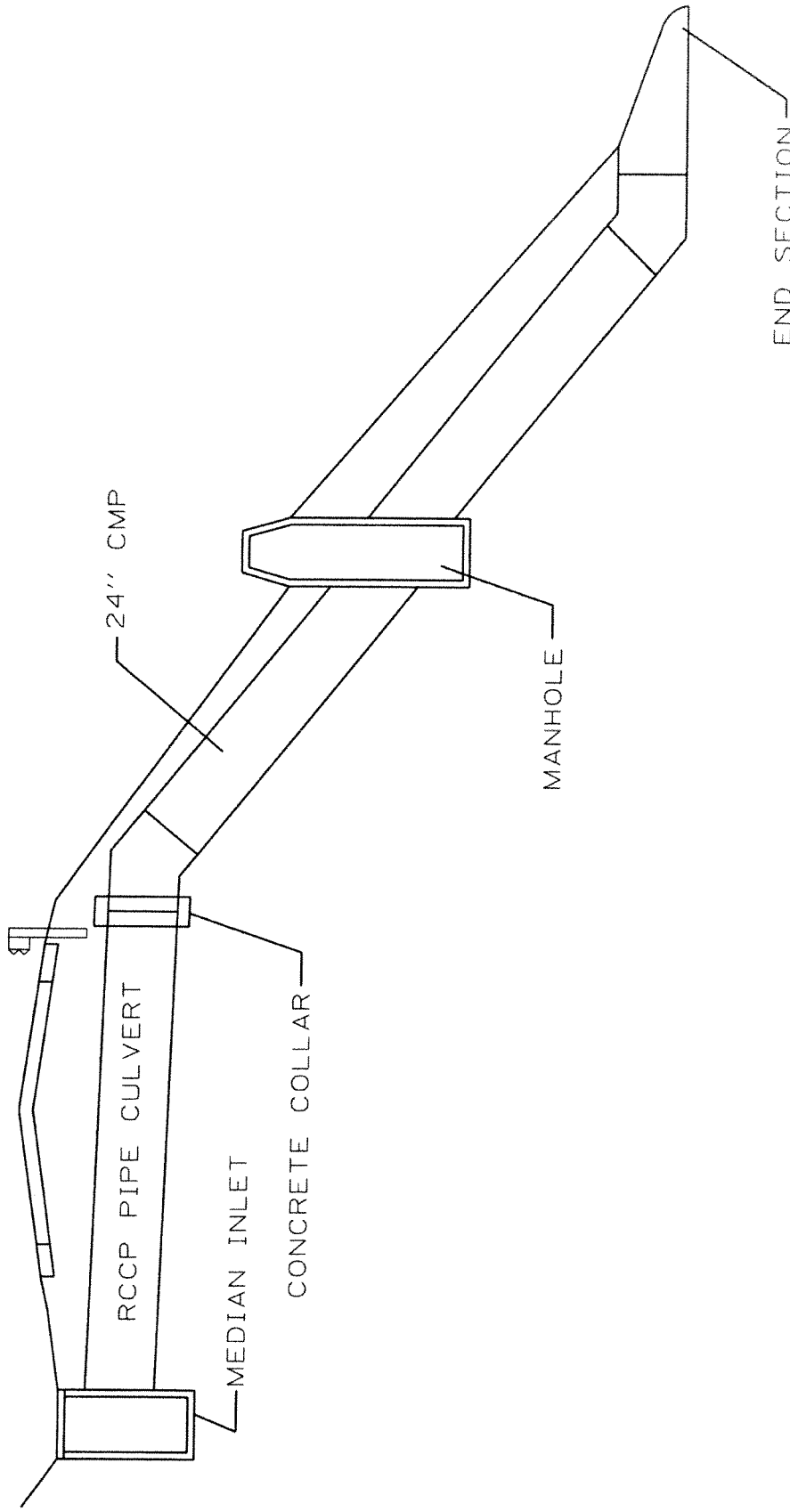

DATE: _____ DRAWN BY: _____ CHECKED BY: _____ DATE: _____	DESIGNED BY: _____ CHECKED BY: _____ DATE: _____	REVISIONS: 1. _____ 2. _____ 3. _____	STATE OF ILLINOIS DEPARTMENT OF TRANSPORTATION	SHEET NO. _____ OF _____ SHEETS PROJECT NO. _____	COUNTY _____ DISTRICT _____ CONTRACT NO. _____ SHEET NO. _____
--	--	--	---	---	---

**LOCATION 2 (EXISTING)
I-88 STA. 494 + 50 (EAST BOUND)**

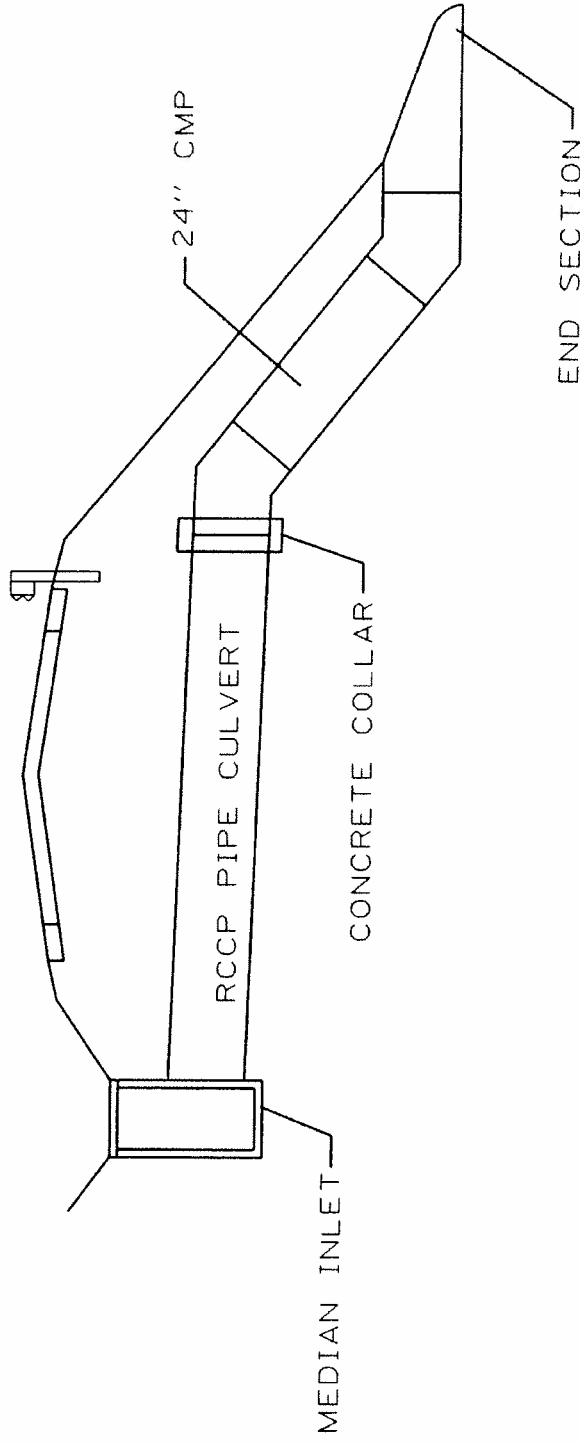

FILE NO. 100-1000-1000 PROJECT NO. 100-1000-1000 DATE 10/10/10 DRAWN BY J. SMITH CHECKED BY J. SMITH DATE 10/10/10		REVISIONS NO. 1 DATE 10/10/10 BY J. SMITH		STATE OF ILLINOIS DEPARTMENT OF TRANSPORTATION		SHEET 1 OF 1 SCALE: AS SHOWN		COUNTY: ILLINOIS DISTRICT: 100-1000-1000 SECTION: 100-1000-1000 DRAWING NO. 100-1000-1000	
---	--	--	--	---	--	---------------------------------	--	--	--

LOCATION 1 (PROPOSED) I-74 /280 STA. 668 + 40 (WEST BOUND)

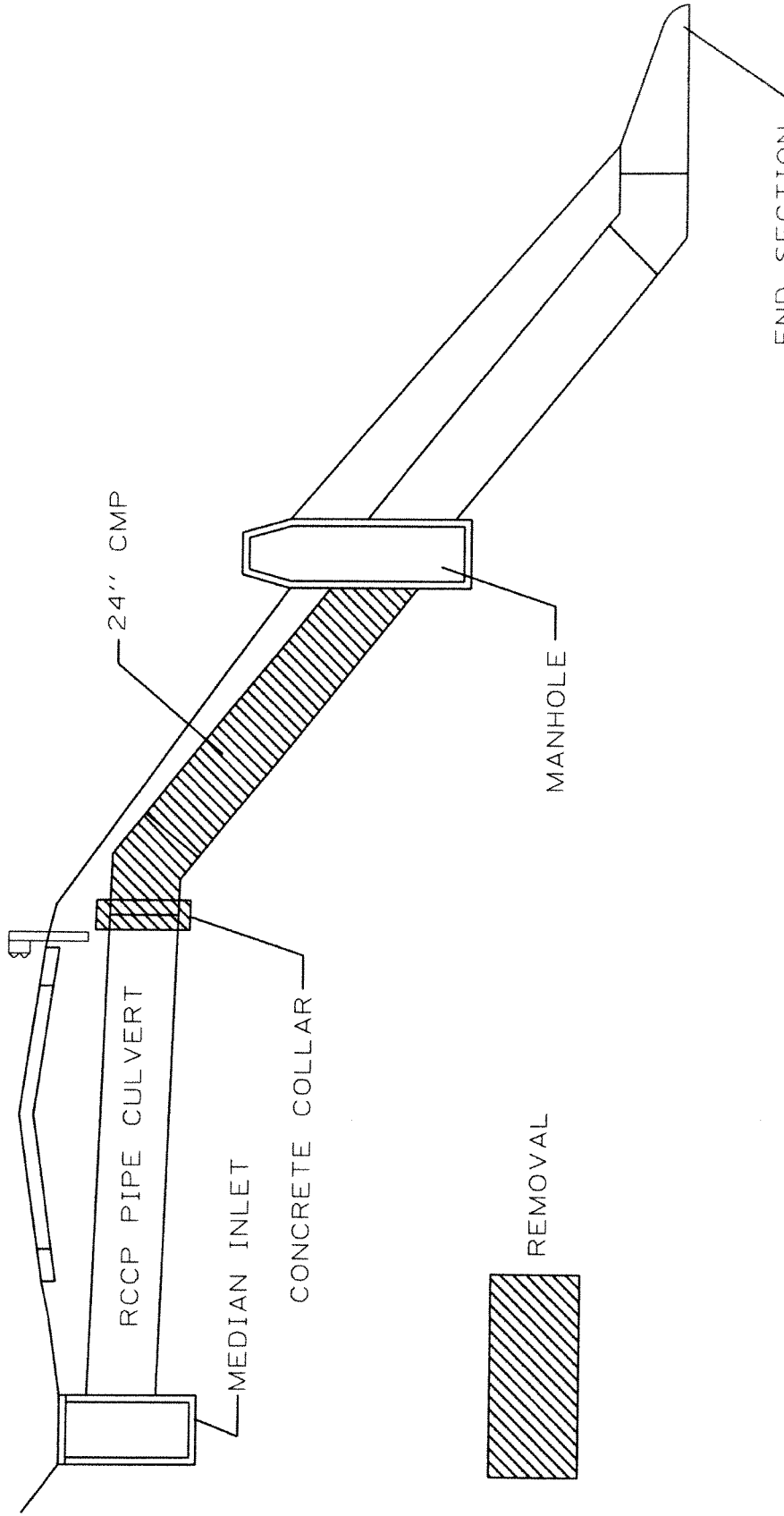

END SECTION

I-74 /280 S.M. COUNTY: ILLINOIS CONTRACT NO. 64-102	SECTION: 01 SHEET NO. 1 OF 1	SHEET NO. 1 OF 1	SCALE: 1" = 10'-0"	STATE OF ILLINOIS DEPARTMENT OF TRANSPORTATION	REVISIONS: NO. 1 DATE: 10/1/02
---	------------------------------------	---------------------	--------------------	---	--------------------------------------

LOCATION 2 (PROPOSED) I-88 STA. 494 + 50 (EAST BOUND)

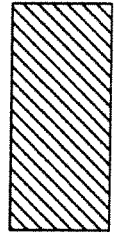
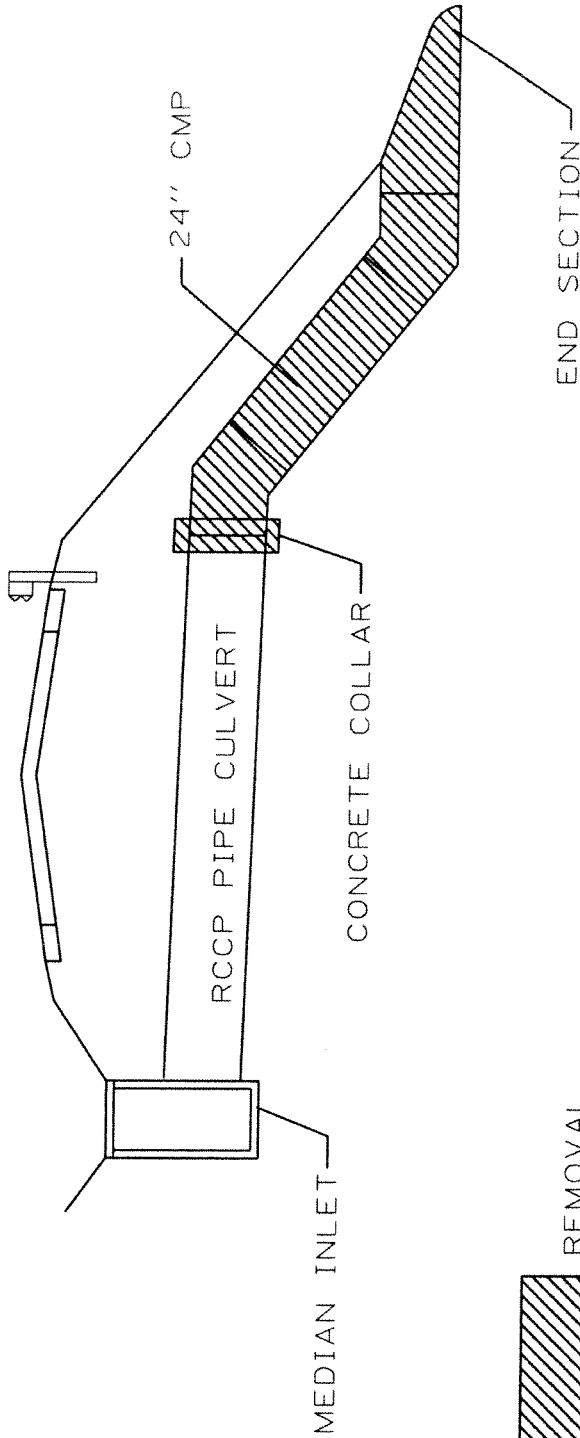

FILE NAME DWG. NUMBER DATE	CHECKED DRAWN CHECKED DATE	REVISIONS REVISION REVISION REVISION	SCALE SHEET OF SHEETS STA. TO STA.	PROJECT & SHEET NO. COUNTY CONTRACT NO. SHEET NO.
STATE OF ILLINOIS DEPARTMENT OF TRANSPORTATION				

REMOVE AND REERECT STEEL PLATE BEAM GUARDRAIL

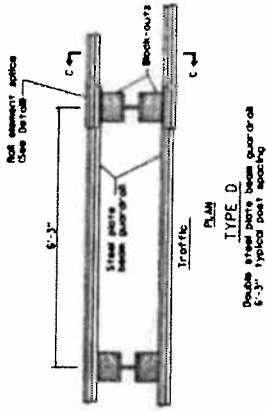
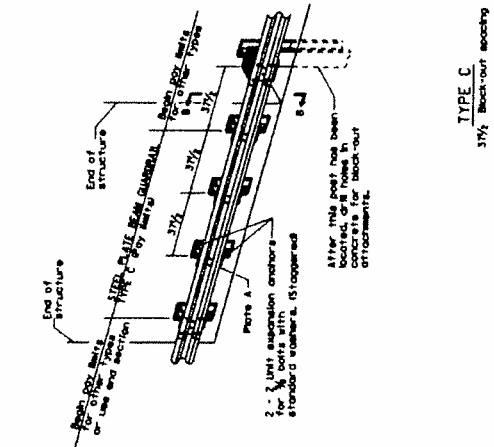
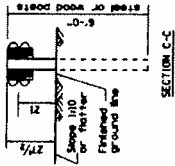
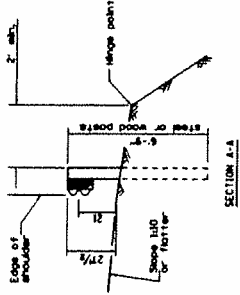
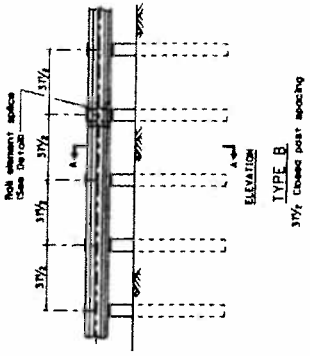
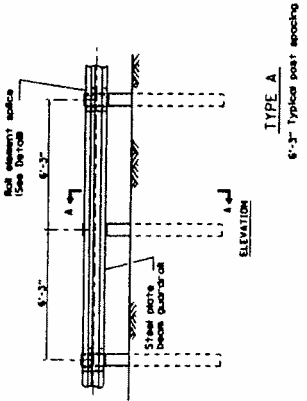

Double steel plate beam guardrail
6'-3" typical post spacing

GENERAL NOTES
All slope ratios are expressed as units of vertical displacement to units of horizontal displacement (V:H).
All dimensions are in inches.
The existing ground profile may be altered to match the soil pattern shown herein for the road back-out. The existing ground profile is provided. This detail is intended for use on systems used prior to January 1, 2003. For details on the latest Guardrail System, see Standard S30001.

PROJECT NO. : SHEET NO. :	REGION 2 / DISTRICT 2 STAIRROAD	SHEET NO. OF SHEETS 1 STL TO 51L	SCALE :	STATE OF ILLINOIS DEPARTMENT OF TRANSPORTATION	SHEET NO. : SHEET NO. OF SHEETS :
DATE : DRAWN BY : CHECKED BY : IN CHARGE :	SECTION :	COUNTY :	PROJECT NO. :	PROJECT NAME :	PROJECT LOCATION :

REMOVE AND REERECT STEEL PLATE BEAM GUARDRAIL SHEET 1 of 4

REMOVE AND REERECT STEEL PLATE BEAM GUARDRAIL

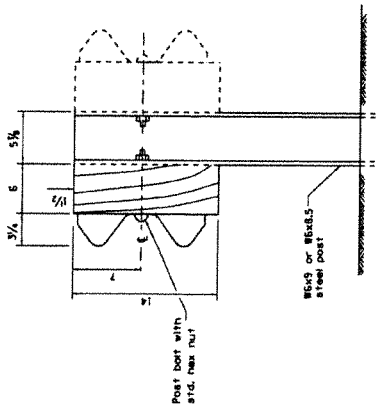

STEEL POST CONSTRUCTION

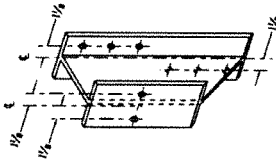

STEEL BLOCK-OUT DETAIL

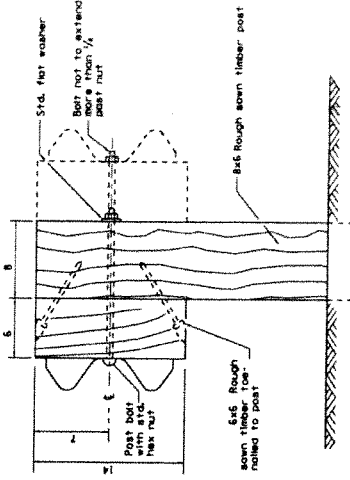

WOOD POST CONSTRUCTION

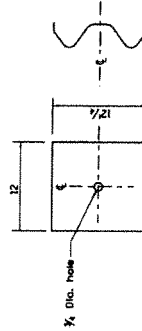

NOTE
Plate A shall be placed between rail element and block-out at non-impact ends of steel block-outs and safety.

PLATE A

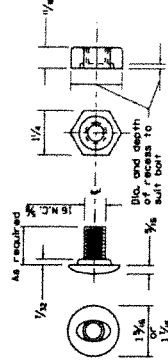

POST OR SPLICE BOLT & NUT

FILE NO. 1	DESIGNED BY	DESIGNED	REVISION	10-11-11	14/250 & M
DATE	BY	CHECKED	DATE	SECTION	SHEET NO.
10-11-11	J. J. J.	J. J. J.	10-11-11	OR DISTRICT 2 STANDARD	17 OF 19
10-11-11	J. J. J.	J. J. J.	10-11-11	SCALE	CONTRACT NO. 64-02
10-11-11	J. J. J.	J. J. J.	10-11-11	SHEET NO. OF SHEETS 131	TO STA.
10-11-11	J. J. J.	J. J. J.	10-11-11	REGION 2 / DISTRICT 2 STANDARD	REMOVE AND REERECT STEEL PLATE BEAM GUARDRAIL SHEET 2 OF 4
10-11-11	J. J. J.	J. J. J.	10-11-11	STATE OF ILLINOIS	53.1
10-11-11	J. J. J.	J. J. J.	10-11-11	DEPARTMENT OF TRANSPORTATION	

REMOVE AND REERECT STEEL PLATE BEAM GUARDRAIL

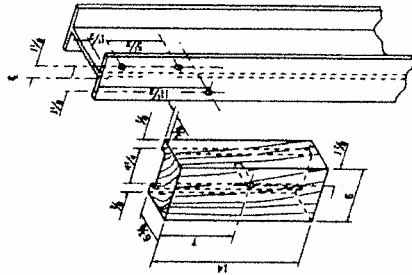

WOOD BLOCK-OUT AND STEEL POST DETAILS

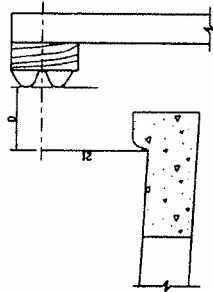

NOTE:
If it is necessary for D to be more than 12 and less than 10'-0" type M-2 curb and gutter (Std. 80000) shall be used in front of and in advance of the guardrail.

GUARDRAIL PLACED BEHIND CURB
@ 7-0 applicable to 12 maximum

V	B	L
D - 10	24	23
M - 41.5	12	8
M - 53.5	12 - 0	8

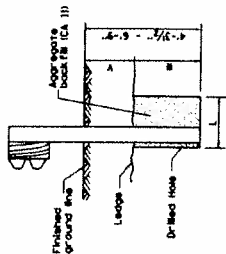

NOTE:
Ledge line is top of rock ledge or hard slag fill.

FOOTING FOR POST WHEN IMPERVIOUS MATERIAL IS ENCOUNTERED

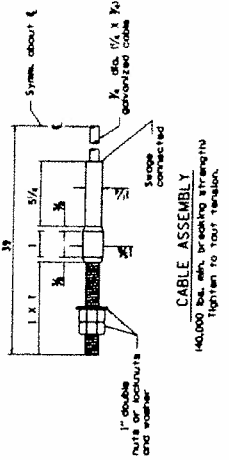

CABLE ASSEMBLY
14,000 lbs. min. breaking strength
Tighten to 100% tension.

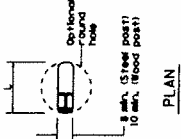

DATE: _____ DRAWN BY: _____ CHECKED BY: _____ DATE: _____	STATE OF ILLINOIS DEPARTMENT OF TRANSPORTATION	REGION 2 / DISTRICT 2 STANDARD SHEET NO. OF SHEETS: 12 OF 12	REMOVE AND REERECT STEEL PLATE BEAM GUARDRAIL SHEET 4 of 4
--	---	--	--

REVISIONS TO THE ILLINOIS PREVAILING WAGE RATES

The Prevailing rates of wages are included in the Contract proposals which are subject to Check Sheet #5 of the Supplemental Specifications and Recurring Special Provisions. The rates have been ascertained and certified by the Illinois Department of Labor for the locality in which the work is to be performed and for each craft or type of work or mechanic needed to execute the work of the Contract. As required by Prevailing Wage Act (820 ILCS 130/0.01, et seq.) and Check Sheet #5 of the Contract, not less than the rates of wages ascertained by the Illinois Department of Labor and as revised during the performance of a Contract shall be paid to all laborers, workers and mechanics performing work under the Contract. Post the scale of wages in a prominent and easily accessible place at the site of work.

If the Illinois Department of Labor revises the prevailing rates of wages to be paid as listed in the specification of rates, the contractor shall post the revised rates of wages and shall pay not less than the revised rates of wages. Current wage rate information shall be obtained by visiting the Illinois Department of Labor web site at <http://www.state.il.us/agency/idol/> or by calling 312-793-2814. It is the responsibility of the contractor to review the rates applicable to the work of the contract at regular intervals in order to insure the timely payment of current rates. Provision of this information to the contractor by means of the Illinois Department of Labor web site satisfies the notification of revisions by the Department to the contractor pursuant to the Act, and the contractor agrees that no additional notice is required. The contractor shall notify each of its subcontractors of the revised rates of wages.