

BID PROPOSAL INSTRUCTIONS

ABOUT IDOT PROPOSALS: All proposals are potential bidding proposals. Each proposal contains all certifications and affidavits, a proposal signature sheet and a proposal bid bond.

PREQUALIFICATION

Any contractor who desires to become pre-qualified to bid on work advertised by IDOT must submit the properly completed pre-qualification forms to the Bureau of Construction no later than 4:30 p.m. prevailing time twenty-one days prior to the letting of interest. This pre-qualification requirement applies to first time contractors, contractors renewing expired ratings, contractors maintaining continuous pre-qualification or contractors requesting revised ratings. To be eligible to bid, existing pre-qualification ratings must be effective through the date of letting.

WHO CAN BID ?

Bids will be accepted from only those companies that request and receive written Authorization to Bid from IDOT's Central Bureau of Construction.

REQUESTS FOR AUTHORIZATION TO BID

Contractors wanting to bid on items included in a particular letting must submit the properly completed "Request for Authorization to Bid/or Not For Bid Status" (BDE 124) and the ORIGINAL "Affidavit of Availability" (BC 57) to the proper office no later than 4:30 p.m. prevailing time, three (3) days prior to the letting date.

WHAT CONSTITUTES WRITTEN AUTHORIZATION TO BID?

When a prospective prime bidder submits a "Request for Authorization to Bid/or Not For Bid Status"(BDE 124) he/she must indicate at that time which items are being requested For Bidding purposes. Only those items requested For Bidding will be analyzed. After the request has been analyzed, the bidder will be issued an **Authorization to Bid or Not for Bid Report**, approved by the Central Bureau of Construction and the Chief Procurement Officer that indicates which items have been approved For Bidding. If **Authorization to Bid** cannot be approved, the **Authorization to Bid or Not for Bid Report** will indicate the reason for denial.

ABOUT AUTHORIZATION TO BID

Firms that have not received an Authorization to Bid or Not For Bid Report within a reasonable time of complete and correct original document submittal should contact the Department as to the status. Firms unsure as to authorization status should call the Prequalification Section of the Bureau of Construction at the number listed at the end of these instructions.

ADDENDA AND REVISIONS

It is the bidder's responsibility to determine which, if any, addenda or revisions pertain to any project they may be bidding. Failure to incorporate all relevant addenda or revisions may cause the bid to be declared unacceptable.

Each addendum or revision will be included with the Electronic Plans and Proposals. Addenda and revisions will also be placed on the Addendum/Revision Checklist and each subscription service subscriber will be notified by e-mail of each addendum and revision issued.

The Internet is the Department's primary way of doing business. The subscription service emails are an added courtesy the Department provides. It is suggested that bidders check IDOT's website at <http://www.idot.illinois.gov/doing-business/procurements/construction-services/construction-bulletins/transportation-bulletin/index#TransportationBulletin> before submitting final bid information.

IDOT IS NOT RESPONSIBLE FOR ANY E-MAIL FAILURES.

Addenda questions may be directed to the Contracts Office at (217)782-7806 or DOT.D&Econtracts@illinois.gov

Technical questions about downloading these files may be directed to Tim Garman at (217)524-1642 or Timothy.Garman@illinois.gov.

STANDARD GUIDELINES FOR SUBMITTING BIDS

- All pages should be single sided.
- Use the Cover Page that is provided in the Bid Proposal (posted on the IDOT Web Site) as the first page of your submitted bid. It has the item number in large bold type in the upper left-hand corner and lines provided for your company name and address in the upper right-hand corner.
- Do not use report covers, presentation folders or special bindings and do not staple multiple times on left side like a book. Use only 1 staple in the upper left hand corner. Make sure all elements of your bid are stapled together including the bid bond or guaranty check (if required).
- **Do not include any certificates of eligibility, your authorization to bid, Addendum Letters or affidavit of availability.**
- Do not include the Subcontractor Documentation with your bid (pages i – iii and pages a – g). This documentation is required only if you are awarded the project.
- Use the envelope cover sheet (provided with the proposal) as the cover for the proposal envelope.
- Do not rely on overnight services to deliver your proposal prior to 10 AM on letting day. It will not be read if it is delivered after 10 AM.
- Do not submit your Substance Abuse Prevention Program (SAPP) with your bid. If you are awarded the contract this form is to be submitted to the district engineer at the pre-construction conference.

BID SUBMITTAL CHECKLIST

- Cover page** (the sheet that has the item number on it) – This should be the first page of your bid proposal, **followed by your bid (the Schedule of Prices/Pay Items)**. If you are using special software or CBID to generate your schedule of prices, do not include the blank pages of the schedule of prices that came with the proposal package.
- Page 4 (Item 9)** – Check “YES” if you will use a subcontractor(s) with an annual value over \$50,000. Include the subcontractor(s) name, address, general type of work to be performed and the dollar amount. If you will use subcontractor(s) but are uncertain who or the dollar amount; check “YES” but leave the lines blank.
- After page 4** – Insert the following documents: Cost Adjustments for Steel, Bituminous and Fuel (if applicable) and the Contractor Letter of Assent (if applicable). The general rule should be, if you don’t know where it goes, put it after page 4.
- Page 10 (Paragraph J)** – Check “YES” or “NO” whether your company has any business in Iran.
- Page 10 (Paragraph K)** – (Not applicable to federally funded projects) List the name of the apprenticeship and training program sponsor holding the certificate of registration from the US Department of Labor. If no applicable program exists, please indicate the work/job category. Do not include certificates with your bid. Keep the certificates in your office in case they are requested by IDOT.
- Page 11 (Paragraph L)** – A copy of your State Board of Elections certificate of registration is no longer required with your bid.
- Page 11 (Paragraph M)** – Indicate if your company has hired a lobbyist in connection with the job for which you are submitting the bid proposal.
- Page 12 (Paragraph C)** – This is a work sheet to determine if a completed Form A is required. It is not part of the form and you do not need to make copies for each completed Form A.
- Pages 14-17 (Form A)** – One Form A (4 pages) is required for each applicable person in your company. Copies of the forms can be used and only need to be changed when the information changes. The certification signature and date must be original for each letting. **Do not staple the forms together.** If you answered “NO” to all of the questions in Paragraph C (page 12), complete the first section (page 14) with your company information and then sign and date the Not Applicable statement on page 17.
- Page 18 (Form B)** - If you check “YES” to having other current or pending contracts it is acceptable to use the phrase, “See Affidavit of Availability on file”. **Ownership Certification** (at the bottom of the page) - Check N/A if the Form A(s) you submitted accounts for 100 percent of the company ownership. Check YES if any percentage of ownership falls outside of the parameters that require reporting on the Form A. Checking NO indicates that the Form A(s) you submitted is not correct and you will be required to submit a revised Form A.
- Page 20 (Workforce Projection)** – Be sure to include the Duration of the Project. It is acceptable to use the phrase “Per Contract Specifications”.

Proposal Bid Bond – (Insert after the proposal signature page) Submit your proposal Proposal Bid Bond (if applicable) using the current Proposal Bid Bond form provided in the proposal package. The Power of Attorney page should be stapled to the Proposal Bid Bond. If you are using an electronic bond, include your bid bond number on the Proposal Bid Bond and attach the Proof of Insurance printed from the Surety’s Web Site.

Disadvantaged Business Utilization Plan and/or Good Faith Effort – The last items in your bid should be the DBE Utilization Plan (SBE 2026), followed by the DBE Participation Statement (SBE 2025) and supporting paperwork. If you have documentation of a Good Faith Effort, it is to follow the SBE Forms.

The Bid Letting is now available in streaming Audio/Video from the IDOT Web Site. A link to the stream will be placed on the main page of the current letting on the day of the Letting. The stream will not begin until 10 AM. The actual reading of the bids does not begin until approximately 10:30 AM.

Following the Letting, the As-Read Tabulation of Bids will be posted by the end of the day. You will find the link on the main Web page for the current letting.

QUESTIONS: pre-letting up to execution of the contract

Contractor pre-qualification 217-782-3413
Small Business, Disadvantaged Business Enterprise (DBE) 217-785-4611
Contracts, Bids, Letting process or Internet downloads 217-782-7806
Estimates Unit..... 217-785-3483
Aeronautics..... 217-785-8515
IDNR (Land Reclamation, Water Resources, Natural Resources)..... 217-782-6302

QUESTIONS: following contract execution

Subcontractor documentation, payments 217-782-3413
Railroad Insurance 217-785-0275

RETURN WITH BID

125

Proposal Submitted By
Name
Address
City

Letting March 4, 2016

NOTICE TO PROSPECTIVE BIDDERS

This proposal can be used for bidding purposes by only those companies that request and receive written AUTHORIZATION TO BID from IDOT's Central Bureau of Construction.

BIDDERS NEED NOT RETURN THE ENTIRE PROPOSAL

**Notice to Bidders,
Specifications,
Proposal, Contract
and Contract Bond**



**Illinois Department
of Transportation**

Springfield, Illinois 62764

**Contract No. 89667
STARK County
Section 13-00167-00-PP
Various Routes
Project RS-0175(029)
District 4 Construction Funds**

PLEASE MARK THE APPROPRIATE BOX BELOW:

- A Bid Bond is included.
- A Cashier's Check or a Certified Check is included
- An Annual Bid Bond is included or is on file with IDOT.

Plans Included
Herein

Prepared by	
Checked by	F

Page intentionally left blank

RETURN WITH BID



PROPOSAL

TO THE DEPARTMENT OF TRANSPORTATION

1. Proposal of _____

Taxpayer Identification Number (Mandatory) _____

For the improvement identified and advertised for bids in the Invitation for Bids as:

**Contract No. 89667
STARK County
Section 13-00167-00-PP
Project RS-0175(029)
Various Routes
District 4 Construction Funds**

Project consists of constructing a single bituminous surface treatment over existing oil and chip surfaces on various County Highways in Stark County.

2. The undersigned bidder will furnish all labor, material and equipment to complete the above described project in a good and workmanlike manner as provided in the contract documents provided by the Department of Transportation. This proposal will become part of the contract and the terms and conditions contained in the contract documents will govern performance and payments.

RETURN WITH BID

3. **ASSURANCE OF EXAMINATION AND INSPECTION/WAIVER.** The undersigned bidder further declares that he/she has carefully examined the proposal, plans, specifications, addenda form of contract and contract bond, and special provisions, and that he/she has inspected in detail the site of the proposed work, and that he/she has familiarized themselves with all of the local conditions affecting the contract and the detailed requirements of construction, and understands that in making this bid proposal he/she waives all right to plead any misunderstanding regarding the same.

4. **EXECUTION OF CONTRACT AND CONTRACT BOND.** The undersigned bidder further agrees to execute a contract for this work and present the same to the department within fifteen (15) days after the contract has been mailed to him/her. The undersigned further agrees that he/she and his/her surety will execute and present within fifteen (15) days after the contract has been mailed to him/her contract bond satisfactory to and in the form prescribed by the Department of Transportation, in the penal sum of the full amount of the contract, or as specified in the special provisions, guaranteeing the faithful performance of the work in accordance with the terms of the contract.

5. **PROPOSAL GUARANTY.** Accompanying this proposal is either a bid bond on the department form, executed by a corporate surety company satisfactory to the department, or a proposal guaranty check consisting of a bank cashier's check or a properly certified check for not less than 5 per cent of the amount bid or for the amount specified in the following schedule:

<u>Amount of Bid</u>		<u>Proposal Guaranty</u>	<u>Amount of Bid</u>		<u>Proposal Guaranty</u>	
Up to	\$5,000	\$150	\$2,000,000	to	\$3,000,000	\$100,000
\$5,000	to \$10,000	\$300	\$3,000,000	to	\$5,000,000	\$150,000
\$10,000	to \$50,000	\$1,000	\$5,000,000	to	\$7,500,000	\$250,000
\$50,000	to \$100,000	\$3,000	\$7,500,000	to	\$10,000,000	\$400,000
\$100,000	to \$150,000	\$5,000	\$10,000,000	to	\$15,000,000	\$500,000
\$150,000	to \$250,000	\$7,500	\$15,000,000	to	\$20,000,000	\$600,000
\$250,000	to \$500,000	\$12,500	\$20,000,000	to	\$25,000,000	\$700,000
\$500,000	to \$1,000,000	\$25,000	\$25,000,000	to	\$30,000,000	\$800,000
\$1,000,000	to \$1,500,000	\$50,000	\$30,000,000	to	\$35,000,000	\$900,000
\$1,500,000	to \$2,000,000	\$75,000	over		\$35,000,000	\$1,000,000

Bank cashier's checks or properly certified checks accompanying bid proposals will be made payable to the Treasurer, State of Illinois.

If a combination bid is submitted, the proposal guaranties which accompany the individual bid proposals making up the combination will be considered as also covering the combination bid.

The amount of the proposal guaranty check is _____ \$(_____). If this proposal is accepted and the undersigned will fail to execute a contract bond as required herein, it is hereby agreed that the amount of the proposal guaranty will become the property of the State of Illinois, and shall be considered as payment of damages due to delay and other causes suffered by the State because of the failure to execute said contract and contract bond; otherwise, the bid bond will become void or the proposal guaranty check will be returned to the undersigned.

Attach Cashier's Check or Certified Check Here

In the event that one proposal guaranty check is intended to cover two or more bid proposals, the amount must be equal to the sum of the proposal guaranties which would be required for each individual bid proposal. If the guaranty check is placed in another bid proposal, state below where it may be found.

The proposal guaranty check will be found in the bid proposal for:

Item _____

Section No. _____

County _____

Mark the proposal cover sheet as to the type of proposal guaranty submitted.

RETURN WITH BID

6. **COMBINATION BIDS.** The undersigned bidder further agrees that if awarded the contract for the sections contained in the following combination, he/she will perform the work in accordance with the requirements of each individual contract comprising the combination bid specified in the schedule below, and that the combination bid shall be prorated against each section in proportion to the bid submitted for the same. If an error is found to exist in the gross sum bid for one or more of the individual sections included in a combination, the combination bid shall be corrected as provided in the specifications.

When a combination bid is submitted, the schedule below must be completed in each proposal comprising the combination.

If alternate bids are submitted for one or more of the sections comprising the combination, a combination bid must be submitted for each alternate.

Schedule of Combination Bids

Combination No.	Sections Included in Combination	Combination Bid	
		Dollars	Cents

7. **SCHEDULE OF PRICES.** The undersigned bidder submits herewith, in accordance with the rules and instructions, a schedule of prices for the items of work for which bids are sought. The unit prices bid are in U.S. dollars and cents, and all extensions and summations have been made. The bidder understands that the quantities appearing in the bid schedule are approximate and are provided for the purpose of obtaining a gross sum for the comparison of bids. If there is an error in the extension of the unit prices, the unit prices will govern. Payment to the contractor awarded the contract will be made only for actual quantities of work performed and accepted or materials furnished according to the contract. The scheduled quantities of work to be done and materials to be furnished may be increased, decreased or omitted as provided elsewhere in the contract.
8. **AUTHORITY TO DO BUSINESS IN ILLINOIS.** Section 20-43 of the Illinois Procurement Code (the Code) (30 ILCS 500/20-43) provides that a person (other than an individual acting as a sole proprietor) must be a legal entity authorized to transact business or conduct affairs in the State of Illinois prior to submitting the bid.
9. **EXECUTION OF CONTRACT:** The Department of Transportation will, in accordance with the rules governing Department procurements, execute the contract and shall be the sole entity having the authority to accept performance and make payments under the contract. Execution of the contract by the Chief Procurement Officer (CPO) or the State Purchasing Officer (SPO) is for approval of the procurement process and execution of the contract by the Department. Neither the CPO nor the SPO shall be responsible for administration of the contract or determinations respecting performance or payment there under except as otherwise permitted in the Code.
10. **The services of a subcontractor will be used.**

Check box Yes
 Check box No

For known subcontractors with subcontracts with an annual value of more than \$50,000, the contract shall include their name, address, general type of work to be performed, and the dollar allocation for each subcontractor.
 (30 ILCS 500/20-120)

COUNTY NAME	CODE	DIST	SECTION NUMBER	PROJECT NUMBER	ROUTE
STARK	175	04	13-00167-00-PP	RS-0175/029/000	VARIOUS

ITEM NUMBER	PAY ITEM DESCRIPTION	UNIT OF MEASURE	QUANTITY	UNIT PRICE		TOTAL PRICE	
				DOLLARS	CENTS	DOLLARS	CTS
40300300	BIT MATLS C&S CT	GALLON	88,048.000 X	=			
40300600	SEAL COAT AGG	TON	3,220.000 X	=			
67100100	MOBILIZATION	L SUM	1.000 X	=			
78001100	PT PVT MK LTRS & SYMB	SQ FT	310.000 X	=			
78001110	PAINT PVT MK LINE 4	FOOT	97,135.000 X	=			

TOTAL \$

- NOTE:
1. EACH PAY ITEM SHOULD HAVE A UNIT PRICE AND A TOTAL PRICE.
 2. THE UNIT PRICE SHALL GOVERN IF NO TOTAL PRICE IS SHOWN OR IF THERE IS A DISCREPANCY BETWEEN THE PRODUCT OF THE UNIT PRICE MULTIPLIED BY THE QUANTITY.
 3. IF A UNIT PRICE IS OMITTED, THE TOTAL PRICE WILL BE DIVIDED BY THE QUANTITY IN ORDER TO ESTABLISH A UNIT PRICE.
 4. A BID MAY BE DECLARED UNACCEPTABLE IF NEITHER A UNIT PRICE NOR A TOTAL PRICE IS SHOWN.

RETURN WITH BID

STATE REQUIRED ETHICAL STANDARDS GOVERNING CONTRACT PROCUREMENT: ASSURANCES, CERTIFICATIONS AND DISCLOSURES

I. GENERAL

A. Article 50 of the Code establishes the duty of all State CPOs, SPOs, and their designees to maximize the value of the expenditure of public moneys in procuring goods, services, and contracts for the State of Illinois and to act in a manner that maintains the integrity and public trust of State government. In discharging this duty, they are charged by law to use all available information, reasonable efforts, and reasonable actions to protect, safeguard, and maintain the procurement process of the State of Illinois.

B. In order to comply with the provisions of Article 50 and to carry out the duty established therein, all bidders are to adhere to ethical standards established for the procurement process, and to make such assurances, disclosures and certifications required by law. Except as otherwise required in subsection III, paragraphs J-M, by execution of the Proposal Signature Sheet, the bidder indicates that each of the mandated assurances have been read and understood, that each certification is made and understood, and that each disclosure requirement has been understood and completed.

C. In addition to all other remedies provided by law, failure to comply with any assurance, failure to make any disclosure or the making of a false certification shall be grounds for the CPO to void the contract, and may result in the suspension or debarment of the bidder or subcontractor. If a false certification is made by a subcontractor the contractor's submitted bid and the executed contract may not be declared void unless the contractor refuses to terminate the subcontract upon the State's request after a finding that the subcontractor's certification was false.

I acknowledge, understand and accept these terms and conditions.

II. ASSURANCES

The assurances hereinafter made by the bidder are each a material representation of fact upon which reliance is placed should the Department enter into the contract with the bidder.

A. Conflicts of Interest

Section 50-13. Conflicts of Interest.

(a) Prohibition. It is unlawful for any person holding an elective office in this State, holding a seat in the General Assembly, or appointed to or employed in any of the offices or agencies of state government and who receives compensation for such employment in excess of 60% of the salary of the Governor of the State of Illinois, or who is an officer or employee of the Capital Development Board or the Illinois State Toll Highway Authority, or who is the spouse or minor child of any such person to have or acquire any contract, or any direct pecuniary interest in any contract therein, whether for stationery, printing, paper, or any services, materials, or supplies, that will be wholly or partially satisfied by the payment of funds appropriated by the General Assembly of the State of Illinois or in any contract of the Capital Development Board or the Illinois State Toll Highway Authority.

(b) Interests. It is unlawful for any firm, partnership, association or corporation, in which any person listed in subsection (a) is entitled to receive (i) more than 7 1/2% of the total distributable income or (ii) an amount in excess of the salary of the Governor, to have or acquire any such contract or direct pecuniary interest therein.

(c) Combined interests. It is unlawful for any firm, partnership, association, or corporation, in which any person listed in subsection (a) together with his or her spouse or minor children is entitled to receive (i) more than 15%, in the aggregate, of the total distributable income or (ii) an amount in excess of 2 times the salary of the Governor, to have or acquire any such contract or direct pecuniary interest therein.

(d) Securities. Nothing in this Section invalidates the provisions of any bond or other security previously offered or to be offered for sale or sold by or for the State of Illinois.

(e) Prior interests. This Section does not affect the validity of any contract made between the State and an officer or employee of the State or member of the General Assembly, his or her spouse, minor child or any combination of those persons if that contract was in existence before his or her election or employment as an officer, member, or employee. The contract is voidable, however, if it cannot be completed within 365 calendar days after the officer, member, or employee takes office or is employed. The current salary of the Governor is \$177,412.00. Sixty percent of the salary is \$106,447.20.

RETURN WITH BID

The bidder assures the Department that the award and execution of the contract would not cause a violation of Section 50-13, or that an effective exemption has been issued by the Board of Ethics to any individual subject to the Section 50-13 prohibitions pursuant to the provisions of Section 50-20 of the Code. Information concerning the exemption process is available from the Department upon request.

B. Negotiations

Section 50-15. Negotiations.

It is unlawful for any person employed in or on a continual contractual relationship with any of the offices or agencies of State government to participate in contract negotiations on behalf of that office or agency with any firm, partnership, association, or corporation with whom that person has a contract for future employment or is negotiating concerning possible future employment.

The bidder assures the Department that the award and execution of the contract would not cause a violation of Section 50-15, and that the bidder has no knowledge of any facts relevant to the kinds of acts prohibited therein.

C. Inducements

Section 50-25. Inducement.

Any person who offers or pays any money or other valuable thing to any person to induce him or her not to provide a submission to a vendor portal or to bid for a State contract or as recompense for not having bid on a State contract is guilty of a Class 4 felony. Any person who accepts any money or other valuable thing for not bidding for a State contract, not making a submission to a vendor portal, or who withholds a bid or submission to a vendor portal in consideration of the promise for the payment of money or other valuable thing is guilty of a Class 4 felony.

The bidder assures the Department that the award and execution of the contract would not cause a violation of Section 50-25, and that the bidder has no knowledge of any facts relevant to the kinds of acts prohibited therein.

D. Revolving Door Prohibition

Section 50-30. Revolving door prohibition.

CPOs, SPOs, procurement compliance monitors, their designees whose principal duties are directly related to State procurement, and executive officers confirmed by the Senate are expressly prohibited for a period of 2 years after terminating an affected position from engaging in any procurement activity relating to the State agency most recently employing them in an affected position for a period of at least 6 months. The prohibition includes, but is not limited to: lobbying the procurement process; specifying; bidding; proposing bid, proposal, or contract documents; on their own behalf or on behalf of any firm, partnership, association, or corporation. This Section applies only to persons who terminate an affected position on or after January 15, 1999.

The bidder assures the Department that the award and execution of the contract would not cause a violation of Section 50-30, and that the bidder has no knowledge of any facts relevant to the kinds of acts prohibited therein.

E. Reporting Anticompetitive Practices

Section 50-40. Reporting anticompetitive practices.

When, for any reason, any vendor, bidder, contractor, CPO, SPO, designee, elected official, or State employee suspects collusion or other anticompetitive practice among any bidders, offerors, contractors, proposers, or employees of the State, a notice of the relevant facts shall be transmitted to the Attorney General and the CPO.

The bidder assures the Department that it has not failed to report any relevant facts concerning the practices addressed in Section 50-40 which may involve the contract for which the bid or submission to a vendor portal is submitted.

F. Confidentiality

Section 50-45. Confidentiality.

Any CPO, SPO, designee, or executive officer who willfully uses or allows the use of specifications, competitive bid documents, proprietary competitive information, proposals, contracts, or selection information to compromise the fairness or integrity of the procurement, bidding, or contract process shall be subject to immediate dismissal, regardless of the Personnel code, any contract, or any collective bargaining agreement, and may in addition be subject to criminal prosecution.

The bidder assures the Department that it has no knowledge of any fact relevant to the practices addressed in Section 50-45 which may involve the contract for which the bid is submitted.

RETURN WITH BID

G. Insider Information

Section 50-50. Insider information.

It is unlawful for any current or former elected or appointed State official or State employee to knowingly use confidential information available only by virtue of that office or employment for actual or anticipated gain for themselves or another person.

The bidder assures the Department that it has no knowledge of any facts relevant to the practices addressed in Section 50-50 which may involve the contract for which the bid is submitted.

I acknowledge, understand and accept these terms and conditions for the above assurances.

III. CERTIFICATIONS

The certifications hereinafter made by the bidder are each a material representation of fact upon which reliance is placed should the Department enter into the contract with the bidder. Section 50-2 of the Code provides that every person that has entered into a multi-year contract and every subcontractor with a multi-year subcontract shall certify, by July 1 of each fiscal year covered by the contract after the initial fiscal year, to the responsible CPO whether it continues to satisfy the requirements of Article 50 pertaining to the eligibility for a contract award. If a contractor or subcontractor is not able to truthfully certify that it continues to meet all requirements, it shall provide with its certification a detailed explanation of the circumstances leading to the change in certification status. A contractor or subcontractor that makes a false statement material to any given certification required under Article 50 is, in addition to any other penalties or consequences prescribed by law, subject to liability under the Whistleblower Reward and Protection Act for submission of a false claim.

A. Bribery

Section 50-5. Bribery.

(a) Prohibition. No person or business shall be awarded a contract or subcontract under this Code who:

(1) has been convicted under the laws of Illinois or any other state of bribery or attempting to bribe an officer or employee of the State of Illinois or any other state in that officer's or employee's official capacity; or

(2) has made an admission of guilt of that conduct that is a matter of record but has not been prosecuted for that conduct.

(b) Businesses. No business shall be barred from contracting with any unit of State or local government, or subcontracting under such a contract, as a result of a conviction under this Section of any employee or agent of the business if the employee or agent is no longer employed by the business and:

(1) the business has been finally adjudicated not guilty; or

(2) the business demonstrates to the governmental entity with which it seeks to contract, or which is signatory to the contract which the subcontract relates, and that entity finds that the commission of the offense was not authorized, requested, commanded, or performed by a director, officer, or high managerial agent on behalf of the business as provided in paragraph (2) of subsection (a) of Section 5-4 of the Criminal Code of 2012.

(c) Conduct on behalf of business. For purposes of this Section, when an official, agent, or employee of a business committed the bribery or attempted bribery on behalf of the business and in accordance with the direction or authorization of a responsible official of the business, the business shall be chargeable with the conduct.

(d) Certification. Every bid submitted to and contract executed by the State, and every subcontract subject to Section 20-120 of the Code shall contain a certification by the contractor or the subcontractor, respectively, that the contractor or subcontractor is not barred from being awarded a contract or subcontract under this Section and acknowledges that the CPO may declare the related contract void if any certifications required by this Section are false. A contractor who makes a false statement, material to the certification, commits a Class 3 felony.

The contractor or subcontractor certifies that it is not barred from being awarded a contract under Section 50-5.

B. Felons

Section 50-10. Felons.

(a) Unless otherwise provided, no person or business convicted of a felony shall do business with the State of Illinois or any State agency, or enter into a subcontract, from the date of conviction until 5 years after the date of completion of the sentence for that felony, unless no person held responsible by a prosecutorial office for the facts upon which the conviction was based continues to have any involvement with the business.

(b) Certification. Every bid submitted to and contract executed by the State and every subcontract subject to Section 20-120 of the Code and every vendor's submission to a vendor portal shall contain a certification by the bidder or contractor or subcontractor, respectively, that the bidder, contractor, or subcontractor is not barred from being awarded a contract or subcontract under this Section and acknowledges that the CPO may declare the related contract void if any of the certifications required by this Section are false.

RETURN WITH BID

C. Debt Delinquency

Section 50-11 and 50-12. Debt Delinquency.

The contractor or bidder or subcontractor, respectively, certifies that it, or any affiliate, is not barred from being awarded a contract or subcontract under the Code. Section 50-11 prohibits a person from entering into a contract with a State agency, or entering into a subcontract, if it knows or should know that it, or any affiliate, is delinquent in the payment of any debt to the State as defined by the Debt Collection Board. Section 50-12 prohibits a person from entering into a contract with a State agency, or entering into a subcontract, if it, or any affiliate, has failed to collect and remit Illinois Use Tax on all sales of tangible personal property into the State of Illinois in accordance with the provisions of the Illinois Use Tax Act. The bidder or contractor or subcontractor, respectively, further acknowledges that the CPO may declare the related contract void if this certification is false or if the bidder, contractor, or subcontractor, or any affiliate, is determined to be delinquent in the payment of any debt to the State during the term of the contract.

D. Prohibited Bidders, Contractors and Subcontractors

Section 50-10.5 and 50-60(c). Prohibited bidders, contractors and subcontractors.

The bidder or contractor or subcontractor, respectively, certifies in accordance with Section 50-10.5 that no officer, director, partner or other managerial agent of the contracting business has been convicted of a felony under the Sarbanes-Oxley Act of 2002 or a Class 3 or Class 2 felony under the Illinois Securities Law of 1953 or if in violation of Subsection (c) for a period of five years from the date of conviction. Every bid submitted to and contract executed by the State and every subcontract subject to Section 20-120 of the Code shall contain a certification by the bidder, contractor, or subcontractor, respectively, that the bidder, contractor, or subcontractor is not barred from being awarded a contract or subcontract under this Section and acknowledges that the CPO shall declare the related contract void if any of the certifications completed pursuant to this Section are false.

E. Section 42 of the Environmental Protection Act

Section 50-14 Environmental Protection Act violations.

The bidder or contractor or subcontractor, respectively, certifies in accordance with Section 50-14 that the bidder, contractor, or subcontractor, is not barred from being awarded a contract or entering into a subcontract under this Section which prohibits the bidding on or entering into contracts with the State of Illinois or a State agency, or entering into any subcontract, that is subject to the Code by a person or business found by a court or the Pollution Control Board to have committed a willful or knowing violation of Section 42 of the Environmental Protection Act for a period of five years from the date of the order. The bidder or contractor or subcontractor, respectively, acknowledges that the CPO may declare the contract void if this certification is false.

F. Educational Loan

Section 3 of the Educational Loan Default Act, 5 ILCS 385/3.

Pursuant to the Educational Loan Default Act no State agency shall contract with an individual for goods or services if that individual is in default on an educational loan.

The bidder, if an individual as opposed to a corporation, partnership or other form of business organization, certifies that the bidder is not in default on an educational loan as provided in Section 3 of the Act.

G. Bid-Rigging/Bid Rotating

Section 33E-11 of the Criminal Code of 2012, 720 ILCS 5/3BE-11.

(a) Every bid submitted to and public contract executed pursuant to such bid by the State or a unit of local government shall contain a certification by the prime contractor that the prime contractor is not barred from contracting with any unit of State or local government as a result of a violation of either Section 33E-3 or 33E-4 of this Article.

(b) A contractor who makes a false statement, material to the certification, commits a Class 3 felony.

A violation of Section 33E-3 would be represented by a conviction of the crime of bid-rigging which, in addition to Class 3 felony sentencing, provides that any person convicted of this offense or any similar offense of any state or the United States which contains the same elements as this offense shall be barred for 5 years from the date of conviction from contracting with any unit of State or local government. No corporation shall be barred from contracting with any unit of State or local government as a result of a conviction under this Section of any employee or agent of such corporation if the employee so convicted is no longer employed by the corporation and: (1) it has been finally adjudicated not guilty or (2) if it demonstrates to the governmental entity with which it seeks to contract and that entity finds that the commission of the offense was neither authorized, requested, commanded, nor performed by a director, officer or a high managerial agent in behalf of the corporation.

The bidder certifies that it is not barred from contracting with the Department by reason of a violation of either Section 33E-3 or Section 33E-4.

RETURN WITH BID

H. International Anti-Boycott

Section 5 of the International Anti-Boycott Certification Act provides every contract entered into by the State of Illinois for the manufacture, furnishing, or purchasing of supplies, material, or equipment or for the furnishing of work, labor, or services, in an amount exceeding the threshold for small purchases according to the purchasing laws of this State or \$10,000.00, whichever is less, shall contain certification, as a material condition of the contract, by which the contractor agrees that neither the contractor nor any substantially-owned affiliated company is participating or shall participate in an international boycott in violation of the provisions of the U.S. Export Administration Act of 1979 or the regulations of the U.S. Department of Commerce promulgated under that Act.

The bidder makes the certification set forth in Section 5 of the Act.

I. Drug Free Workplace

The Illinois "Drug Free Workplace Act" applies to this contract and it is necessary to comply with the provisions of the "Act" if the contractor is a corporation, partnership, or other entity (including a sole proprietorship) which has 25 or more employees.

The bidder certifies that if awarded a contract in excess of \$5,000 it will provide a drug free workplace in compliance with the provisions of the Act.

J. Disclosure of Business Operations in Iran

Section 50-36 of the Code provides that each bid, offer, or proposal submitted for a State contract shall include a disclosure of whether or not the Company acting as the bidder, offeror, or proposing entity, or any of its corporate parents or subsidiaries, within the 24 months before submission of the bid, offer, or proposal had business operations that involved contracts with or provision of supplies or services to the Government of Iran, companies in which the Government of Iran has any direct or indirect equity share, consortiums or projects commissioned by the Government of Iran, or companies involved in consortiums or projects commissioned by the Government of Iran and either of the following conditions apply:

- (1) More than 10% of the Company's revenues produced in or assets located in Iran involve oil-related activities or mineral-extraction activities; less than 75% of the Company's revenues produced in or assets located in Iran involve contracts with or provision of oil-related or mineral-extraction products or services to the Government of Iran or a project or consortium created exclusively by that government; and the Company has failed to take substantial action.
- (2) The Company has, on or after August 5, 1996, made an investment of \$20 million or more, or any combination of investments of at least \$10 million each that in the aggregate equals or exceeds \$20 million in any 12-month period, which directly or significantly contributes to the enhancement of Iran's ability to develop petroleum resources of Iran.

The terms "Business operations", "Company", "Mineral-extraction activities", "Oil-related activities", "Petroleum resources", and "Substantial action" are all defined in the Code.

Failure to make the disclosure required by the Code may cause the bid, offer or proposal to be considered not responsive. The disclosure will be considered when evaluating the bid or awarding the contract. The name of each Company disclosed as doing business or having done business in Iran will be provided to the State Comptroller.

Check the appropriate statement:

Company has no business operations in Iran to disclose.

Company has business operations in Iran as disclosed on the attached document.

RETURN WITH BID

K. Apprenticeship and Training Certification (Does not apply to federal aid projects)

In accordance with the provisions of Section 30-22 (6) of the Code, the bidder certifies that it is a participant, either as an individual or as part of a group program, in the approved apprenticeship and training programs applicable to each type of work or craft that the bidder will perform with its own forces. The bidder further certifies for work that will be performed by subcontract that each of its subcontractors submitted for approval either (a) is, at the time of such bid, participating in an approved, applicable apprenticeship and training program; or (b) will, prior to commencement of performance of work pursuant to this contract, begin participation in an approved apprenticeship and training program applicable to the work of the subcontract. The Department, at any time before or after award, may require the production of a copy of each applicable Certificate of Registration issued by the United States Department of Labor evidencing such participation by the contractor and any or all of its subcontractors. Applicable apprenticeship and training programs are those that have been approved and registered with the United States Department of Labor. The bidder shall list in the space below, the official name of the program sponsor holding the Certificate of Registration for all of the types of work or crafts in which the bidder is a participant and that will be performed with the bidder's forces. Types of work or craft work that will be subcontracted shall be included and listed as subcontract work. The list shall also indicate any type of work or craft job category that does not have an applicable apprenticeship or training program. **The bidder is responsible for making a complete report and shall make certain that each type of work or craft job category that will be utilized on the project as reported on the Construction Employee Workforce Projection (Form BC-1256) and returned with the bid is accounted for and listed.**

Additionally, Section 30-22 of the Code requires that the bidder certify that an Illinois office be maintained as the primary place of employment for persons employed for this contract.

NA-FEDERAL

The requirements of these certifications and disclosures are a material part of the contract, and the contractor shall require these certification provisions to be included in all approved subcontracts. In order to fulfill this requirement, it shall not be necessary that an applicable program sponsor be currently taking, or that it will take applications for apprenticeship, training or employment during the performance of the work of this contract.

RETURN WITH BID

L. Political Contributions and Registration with the State Board of Elections

Sections 20-160 and 50-37 of the Code regulate political contributions from business entities and any affiliated entities or affiliated persons bidding on or contracting with the state. Generally under Section 50-37, any business entity, and any affiliated entity or affiliated person of the business entity, whose current year contracts with all state agencies exceed an awarded value of \$50,000, are prohibited from making any contributions to any political committees established to promote the candidacy of the officeholder responsible for the awarding of the contracts or any other declared candidate for that office for the duration of the term of office of the incumbent officeholder or a period 2 years after the termination of the contract, whichever is longer. Any business entity and affiliated entities or affiliated persons whose state contracts in the current year do not exceed an awarded value of \$50,000, but whose aggregate pending bids and proposals on state contracts exceed \$50,000, either alone or in combination with contracts not exceeding \$50,000, are prohibited from making any political contributions to any political committee established to promote the candidacy of the officeholder responsible for awarding the pending contract during the period beginning on the date the invitation for bids or request for proposals or any other procurement opportunity is issued and ending on the day after the date of award or selection if the entity was not awarded or selected. Section 20-160 requires certification of registration of affected business entities in accordance with procedures found in Section 9-35 of The Election Code.

By submission of a bid, the contractor business entity acknowledges and agrees that it has read and understands Sections 20-160 and 50-37 of the Code, and that it makes the following certification:

The undersigned bidder certifies that it has registered as a business with the State Board of Elections and acknowledges a continuing duty to update the registration in accordance with the above referenced statutes. If the business entity is required to register, the CPO shall verify that it is in compliance on the date the bid or proposal is due. The CPO shall not accept a bid or proposal if the business entity is not in compliance with the registration requirements.

These requirements and compliance with the above referenced statutory sections are a material part of the contract, and any breach thereof shall be cause to void the contract under Section 50-60 of the Code. This provision does not apply to Federal-aid contracts.

M. Lobbyist Disclosure

Section 50-38 of the Code requires that any bidder or offeror on a State contract that hires a person required to register under the Lobbyist Registration Act to assist in obtaining a contract shall:

- (i) Disclose all costs, fees, compensation, reimbursements, and other remunerations paid or to be paid to the lobbyist related to the contract,
- (ii) Not bill or otherwise cause the State of Illinois to pay for any of the lobbyist's costs, fees, compensation, reimbursements, or other remuneration, and
- (iii) Sign a verification certifying that none of the lobbyist's costs, fees, compensation, reimbursements, or other remuneration were billed to the State.

This information, along with all supporting documents, shall be filed with the agency awarding the contract and with the Secretary of State. The CPO shall post this information, together with the contract award notice, in the online Procurement Bulletin.

Pursuant to Subsection (c) of this Section, no person or entity shall retain a person or entity to attempt to influence the outcome of a procurement decision made under the Code for compensation contingent in whole or in part upon the decision or procurement. Any person who violates this subsection is guilty of a business offense and shall be fined not more than \$10,000.

Bidder acknowledges that it is required to disclose the hiring of any person required to register pursuant to the Illinois Lobbyist Registration Act (25 ILCS 170) in connection with this contract.

Bidder has not hired any person required to register pursuant to the Illinois Lobbyist Registration Act in connection with this contract.

Or

Bidder has hired the following persons required to register pursuant to the Illinois Lobbyist Registration Act in connection with the contract:

Name and address of person: _____
All costs, fees, compensation, reimbursements and other remuneration paid to said person: _____

I acknowledge, understand and accept these terms and conditions for the above certifications.

RETURN WITH BID

IV. DISCLOSURES

- A. The disclosures hereinafter made by the bidder are each a material representation of fact upon which reliance is placed should the Department enter into the contract with the bidder. The bidder further certifies that the Department has received the disclosure forms for each bid.

The CPO may void the bid, or contract, respectively, if it is later determined that the bidder or subcontractor rendered a false or erroneous disclosure. A contractor or subcontractor may be suspended or debarred for violations of the Code. Furthermore, the CPO may void the contract and the surety providing the performance bond shall be responsible for completion of the contract.

B. Financial Interests and Conflicts of Interest

1. Section 50-35 of the Code provides that all bids of more than \$50,000 and all submissions to a vendor portal shall be accompanied by disclosure of the financial interests of the bidder. This disclosed information for the successful bidder, will be maintained as public information subject to release by request pursuant to the Freedom of Information Act, filed with the Procurement Policy Board, and shall be incorporated as a material term of the contract. Furthermore, pursuant to Section 5-5, the Procurement Policy Board may review a proposal, bid, or contract and issue a recommendation to void a contract or reject a proposal or bid based on any violation of the Code or the existence of a conflict of interest as provided in subsections (b) and (d) of Section 50-35.

The financial interests to be disclosed shall include ownership or distributive income share that is in excess of 5%, or an amount greater than 60% of the annual salary of the Governor, of the bidding entity or its parent entity, whichever is less, unless the contractor or bidder is a publicly traded entity subject to Federal 10K reporting, in which case it may submit its 10K disclosure in place of the prescribed disclosure. If a bidder is a privately held entity that is exempt from Federal 10K reporting, but has more than 100 shareholders, it may submit the information that Federal 10K companies are required to report, and list the names of any individual or entity holding any ownership share that is in excess of 5%. The disclosure shall include the names, addresses, and dollar or proportionate share of ownership of each individual making the disclosure, their instrument of ownership or beneficial relationship, and notice of any potential conflict of interest resulting from the current ownership or beneficial interest of each individual making the disclosure having any of the relationships identified in Section 50-35 and on the disclosure form.

The current annual salary of the Governor is \$177,412.00.

In addition, all disclosures shall indicate any other current or pending contracts, proposals, leases, or other ongoing procurement relationships the bidding entity has with any other unit of state government and shall clearly identify the unit and the contract, proposal, lease, or other relationship.

2. Disclosure Forms. Disclosure Form A is attached for use concerning the individuals meeting the above ownership or distributive share requirements. A separate Disclosure Form A must be submitted with the bid for each individual meeting the above requirements. In addition, a second form (Disclosure Form B) provides for the disclosure of current or pending procurement relationships with other (non-IDOT) state agencies and a total ownership certification. **The forms must be included with each bid.**

C. Disclosure Form Instructions

Form A Instructions for Financial Information & Potential Conflicts of Interest

If the bidder is a publicly traded entity subject to Federal 10K reporting, the 10K Report may be submitted to meet the requirements of Form A. If a bidder is a privately held entity that is exempt from Federal 10K reporting, but has more than 100 shareholders, it may submit the information that Federal 10K companies are required to report, and list the names of any individual or entity holding any ownership share that is in excess of 5%. If a bidder is not subject to Federal 10K reporting, the bidder must determine if any individuals are required by law to complete a financial disclosure form. To do this, the bidder should answer each of the following questions. A "YES" answer indicates Form A must be completed. If the answer to each of the following questions is "NO", then the NOT APPLICABLE STATEMENT on Form A must be signed and dated by an individual that is authorized to execute contracts for the bidding company. Note: These questions are for assistance only and are not required to be completed.

1. Does anyone in your organization have a direct or beneficial ownership share of greater than 5% of the bidding entity or parent entity? YES ___ NO ___
2. Does anyone in your organization have a direct or beneficial ownership share of less than 5%, but which has a value greater than 60% of the annual salary of the Governor? YES ___ NO ___
3. Does anyone in your organization receive more than 60% of the annual salary of the Governor of the bidding entity's or parent entity's distributive income? YES ___ NO ___
4. Does anyone in your organization receive greater than 5% of the bidding entity's or parent entity's total distributive income, but which is less than 60% of the annual salary of the Governor? YES ___ NO ___

(Note: Only one set of forms needs to be completed per individual per bid even if a specific individual would require a yes answer to more than one question.)

A "YES" answer to any of these questions requires the completion of Form A. The bidder must determine each individual in the bidding entity or the bidding entity's parent company that would cause the questions to be answered "Yes". Each form must be signed and dated by an individual that is authorized to execute contracts for your organization. The individual signing can be, but does not have to be, the individual for which the form is being completed. The bidder is responsible for the accuracy of any information provided.

If the answer to each of the above questions is "NO", then the NOT APPLICABLE STATEMENT of Form A must be signed and dated by an individual that is authorized to execute contracts for your company.

RETURN WITH BID

Form B: Instructions for Identifying Other Contracts & Procurement Related Information

Disclosure Form B must be completed for each bid submitted by the bidding entity. *Note: Checking the NOT APPLICABLE STATEMENT on Form A does not allow the bidder to ignore Form B. Form B must be completed, checked, and dated or the bidder may be considered nonresponsive and the bid will not be accepted.*

The Bidder shall identify, by checking Yes or No on Form B, whether it has any pending contracts (including leases), bids, proposals, or other ongoing procurement relationship with any other (non-IDOT) State of Illinois agency. If "No" is checked, the bidder only needs to complete the check box on the bottom of Form B. If "Yes" is checked, the bidder must do one of the following:

Option I: If the bidder did not submit an Affidavit of Availability to obtain authorization to bid, the bidder must list all non-IDOT State of Illinois agency pending contracts, leases, bids, proposals, and other ongoing procurement relationships. These items may be listed on Form B or on an attached sheet(s). Do not include IDOT contracts. Contracts with cities, counties, villages, etc. are not considered State of Illinois agency contracts and are not to be included. Contracts with other State of Illinois agencies such as the Department of Natural Resources or the Capital Development Board must be included. Bidders who submit Affidavits of Availability are suggested to use Option II.

Option II: If the bidder is required and has submitted an Affidavit of Availability in order to obtain authorization to bid, the bidder may write or type "See Affidavit of Availability" which indicates that the Affidavit of Availability is incorporated by reference and includes all non-IDOT State of Illinois agency pending contracts, leases, bids, proposals, and other ongoing procurement relationships. For any contracts that are not covered by the Affidavit of Availability, the bidder must identify them on Form B or on an attached sheet(s). These might be such things as leases.

RETURN WITH BID

ILLINOIS DEPARTMENT OF TRANSPORTATION

Form A Financial Information & Potential Conflicts of Interest Disclosure

Contractor Name
Legal Address
City, State, Zip
Telephone Number Email Address Fax Number (if available)

Disclosure of the information contained in this Form is required by Section 50-35 of the Code (30 ILCS 500). Vendors desiring to enter into a contract with the State of Illinois must disclose the financial information and potential conflict of interest information as specified in this Disclosure Form. This information shall become part of the publicly available contract file. This Form A must be completed for bids in excess of \$50,000, and for all open-ended contracts. A publicly traded company may submit a 10K disclosure (or equivalent if applicable) in satisfaction of the requirements set forth in Form A. See Disclosure Form Instructions.

The current annual salary of the Governor is \$177,412.00.

DISCLOSURE OF FINANCIAL INFORMATION

- 1. Disclosure of Financial Information. The individual named below has an interest in the BIDDER (or its parent) in terms of ownership or distributive income share in excess of 5%, or an interest which has a value of more than 60% of the annual salary of the Governor. (Make copies of this form as necessary and attach a separate Disclosure Form A for each individual meeting these requirements)

FOR INDIVIDUAL (type or print information)
NAME:
ADDRESS
Type of ownership/distributable income share:
stock sole proprietorship Partnership other: (explain on separate sheet):
% or \$ value of ownership/distributable income share:

- 2. Disclosure of Potential Conflicts of Interest. Check "Yes" or "No" to indicate which, if any, of the following potential conflict of interest relationships apply. If the answer to any question is "Yes", please attach additional pages and describe.

(a) State employment, currently or in the previous 3 years, including contractual employment of services. Yes ___ No ___

If your answer is yes, please answer each of the following questions.

- 1. Are you currently an officer or employee of either the Capitol Development Board or the Illinois State Toll Highway Authority? Yes ___ No ___
2. Are you currently appointed to or employed by any agency of the State of Illinois? If you are currently appointed to or employed by any agency of the State of Illinois, and your annual salary exceeds 60% of the annual salary of the Governor provide the name the State agency for which you are employed and your annual salary.

RETURN WITH BID

3. If you are currently appointed to or employed by any agency of the State of Illinois, and your annual salary exceeds 60% of the annual salary of the Governor, are you entitled to receive (i) more than 7 1/2% of the total distributable income of your firm, partnership, association or corporation, or (ii) an amount in excess of 100% of the annual salary of the Governor? Yes ___ No ___
4. If you are currently appointed to or employed by any agency of the State of Illinois, and your annual salary exceeds 60% of the annual salary of the Governor, are you and your spouse or minor children entitled to receive (i) more than 15% in aggregate of the total distributable income of your firm, partnership, association or corporation, or (ii) an amount in excess of two times the salary of the Governor? Yes ___ No ___

(b) State employment of spouse, father, mother, son, or daughter, including contractual employment for services in the previous 2 years.

Yes ___ No ___

If your answer is yes, please answer each of the following questions.

1. Is your spouse or any minor children currently an officer or employee of the Capitol Development Board or the Illinois State Toll Highway Authority? Yes ___ No ___
2. Is your spouse or any minor children currently appointed to or employed by any agency of the State of Illinois? If your spouse or minor children is/are currently appointed to or employed by any agency of the State of Illinois, and his/her annual salary exceeds 60% of the annual salary of the Governor, provide the name of the spouse and/or minor children, the name of the State agency for which he/she is employed and his/her annual salary. _____
-
3. If your spouse or any minor children is/are currently appointed to or employed by any agency of the State of Illinois, and his/her annual salary exceeds 60% of the annual salary of the Governor, are you entitled to receive (i) more than 7 1/2% of the total distributable income of your firm, partnership, association or corporation, or (ii) an amount in excess 100% of the annual salary of the Governor? Yes ___ No ___
4. If your spouse or any minor children are currently appointed to or employed by any agency of the State of Illinois, and his/her annual salary exceeds 60% of the annual salary of the Governor, are you and your spouse or any minor children entitled to receive (i) more than 15% in the aggregate of the total distributable income from your firm, partnership, association or corporation, or (ii) an amount in excess of two times the salary of the Governor? Yes ___ No ___

(c) Elective status; the holding of elective office of the State of Illinois, the government of the United States, any unit of local government authorized by the Constitution of the State of Illinois or the statutes of the State of Illinois currently or in the previous 3 years. Yes ___ No ___

(d) Relationship to anyone holding elective office currently or in the previous 2 years; spouse, father, mother, son, or daughter. Yes ___ No ___

(e) Appointive office; the holding of any appointive government office of the State of Illinois, the United State of America, or any unit of local government authorized by the Constitution of the State of Illinois or the statutes of the State of Illinois, which office entitles the holder to compensation in excess of the expenses incurred in the discharge of that office currently or in the previous 3 years. Yes ___ No ___

(f) Relationship to anyone holding appointive office currently or in the previous 2 years; spouse, father, mother, son, or daughter. Yes ___ No ___

(g) Employment, currently or in the previous 3 years, as or by any registered lobbyist of the State government. Yes ___ No ___

RETURN WITH BID

(h) Relationship to anyone who is or was a registered lobbyist in the previous 2 years; spouse, father, mother, son, or daughter. Yes ___ No ___

(i) Compensated employment, currently or in the previous 3 years, by any registered election or reelection committee registered with the Secretary of State or any county clerk of the State of Illinois, or any political action committee registered with either the Secretary of State or the Federal Board of Elections. Yes ___ No ___

(j) Relationship to anyone; spouse, father, mother, son, or daughter; who was a compensated employee in the last 2 years by any registered election or re-election committee registered with the Secretary of State or any county clerk of the State of Illinois, or any political action committee registered with either the Secretary of State or the Federal Board of Elections. Yes ___ No ___

3. Communication Disclosure.

Disclose the name and address of each lobbyist and other agent of the bidder or offeror who is not identified in Section 2 of this form, who is has communicated, is communicating, or may communicate with any State officer or employee concerning the bid or offer. This disclosure is a continuing obligation and must be promptly supplemented for accuracy throughout the process and throughout the term of the contract. If no person is identified, enter "None" on the line below:

Name and address of person(s): _____

RETURN WITH BID

4. Suspension or Debarment Disclosure. For each of the persons identified under Sections 2 and 3 of this form, disclose whether any of the following has occurred within the previous 10 years: suspension or debarment from contracting with any governmental entity; professional licensure discipline; bankruptcies; adverse civil judgments and administrative findings; and criminal felony convictions. This disclosure is a continuing obligation and must be promptly supplemented for accuracy throughout the procurement process and term of the contract. If no person is identified, enter "None" on the line below:

Name of person(s): _____

Nature of disclosure: _____

APPLICABLE STATEMENT

This Disclosure Form A is submitted on behalf of the INDIVIDUAL named on previous page. Under penalty of perjury, I certify the contents of this disclosure to be true and accurate to the best of my knowledge.

Completed by: _____ Date _____
Signature of Individual or Authorized Representative

NOT APPLICABLE STATEMENT

Under penalty of perjury, I have determined that no individuals associated with this organization meet the criteria that would require the completion of this Form A.

This Disclosure Form A is submitted on behalf of the CONTRACTOR listed on the previous page.

_____ Date _____
Signature of Authorized Representative

The bidder has a continuing obligation to supplement these disclosures under Sec. 50-35 of the Code.

RETURN WITH BID

ILLINOIS DEPARTMENT OF TRANSPORTATION

Form B Other Contracts & Financial Related Information Disclosure

Contractor Name, Legal Address, City, State, Zip, Telephone Number, Email Address, Fax Number (if available)

Disclosure of the information contained in this Form is required by Section 50-35 of the Code (30 ILCS 500). This information shall become part of the publicly available contract file. This Form B must be completed for all bids.

DISCLOSURE OF OTHER CONTRACTS AND PROCUREMENT RELATED INFORMATION

1. Identifying Other Contracts & Procurement Related Information. The BIDDER shall identify whether it has any pending contracts (including leases), bids, proposals, or other ongoing procurement relationship with any other State of Illinois agency: Yes ___ No ___

If "No" is checked, the bidder only needs to complete the signature box on this page.

2. If "Yes" is checked. Identify each such relationship by showing State of Illinois agency name and other descriptive information such as bid or project number (attach additional pages as necessary). SEE DISCLOSURE FORM INSTRUCTIONS:

THE FOLLOWING STATEMENT MUST BE CHECKED

Signature of Authorized Representative, Date

OWNERSHIP CERTIFICATION

Please certify that the following statement is true if the individuals for all submitted Form A disclosures do not total 100% of ownership.

Any remaining ownership interest is held by individuals receiving less than \$106,447.20 of the bidding entity's or parent entity's distributive income or holding less than a 5% ownership interest.

Yes No N/A (Form A disclosure(s) established 100% ownership)

RETURN WITH BID

SPECIAL NOTICE TO CONTRACTORS

The following requirements of the Illinois Department of Human Rights Act are applicable to bidders on all construction contracts advertised by the Illinois Department of Transportation:

CONSTRUCTION EMPLOYEE UTILIZATION PROJECTION

- (a) All bidders on construction contracts shall complete and submit, along with and as part of their bids, a Bidder's Employee Utilization Form (Form BC-1256) setting forth a projection and breakdown of the total workforce intended to be hired and/or allocated to such contract work by the bidder including a projection of minority and female employee utilization in all job classifications on the contract project.
- (b) The Department of Transportation shall review the Employee Utilization Form, and workforce projections contained therein, of the contract awardee to determine if such projections reflect an underutilization of minority persons and/or women in any job classification in accordance with the Equal Employment Opportunity Clause and Title 44, Illinois Administrative Code, Section 750.120. If it is determined that the contract awardee's projections reflect an underutilization of minority persons and/or women in any job classification, it shall be advised in writing of the manner in which it is underutilizing and such awardee shall be considered to be in breach of the contract unless, prior to commencement of work on the contract project, it submits revised satisfactory projections or an acceptable written affirmative action plan to correct such underutilization including a specific timetable geared to the completion stages of the contract.
- (c) The Department of Transportation shall provide to the Department of Human Rights a copy of the contract awardee's Employee Utilization Form, a copy of any required written affirmative action plan, and any written correspondence related thereto. The Department of Human Rights may review and revise any action taken by the Department of Transportation with respect to these requirements.

RETURN WITH BID

**Contract No. 89667
STARK County
Section 13-00167-00-PP
Project RS-0175(029)
Various Routes
District 4 Construction Funds**

PART II. WORKFORCE PROJECTION - continued

- B. Included in "Total Employees" under Table A is the total number of **new hires** that would be employed in the event the undersigned bidder is awarded this contract.

The undersigned bidder projects that: (number) _____ new hires would be recruited from the area in which the contract project is located; and/or (number) _____ new hires would be recruited from the area in which the bidder's principal office or base of operation is located.

- C. Included in "Total Employees" under Table A is a projection of numbers of persons to be employed directly by the undersigned bidder as well as a projection of numbers of persons to be employed by subcontractors.

The undersigned bidder estimates that (number) _____ persons will be directly employed by the prime contractor and that (number) _____ persons will be employed by subcontractors.

PART III. AFFIRMATIVE ACTION PLAN

- A. The undersigned bidder understands and agrees that in the event the foregoing minority and female employee utilization projection included under **PART II** is determined to be an underutilization of minority persons or women in any job category, and in the event that the undersigned bidder is awarded this contract, he/she will, prior to commencement of work, develop and submit a written Affirmative Action Plan including a specific timetable (geared to the completion stages of the contract) whereby deficiencies in minority and/or female employee utilization are corrected. Such Affirmative Action Plan will be subject to approval by the contracting agency and the **Illinois Department of Human Rights**.
- B. The undersigned bidder understands and agrees that the minority and female employee utilization projection submitted herein, and the goals and timetable included under an Affirmative Action Plan if required, are deemed to be part of the contract specifications.

Company _____ Telephone Number _____

Address _____

NOTICE REGARDING SIGNATURE

The Bidder's signature on the Proposal Signature Sheet will constitute the signing of this form. The following signature block needs to be completed only if revisions are required.

Signature: _____ Title: _____ Date: _____

Instructions: All tables must include subcontractor personnel in addition to prime contractor personnel.

Table A - Include both the number of employees that would be hired to perform the contract work and the total number currently employed (Table B) that will be allocated to contract work, and include all apprentices and on-the-job trainees. The "Total Employees" column should include all employees including all minorities, apprentices and on-the-job trainees to be employed on the contract work.

Table B - Include all employees currently employed that will be allocated to the contract work including any apprentices and on-the-job trainees currently employed.

Table C - Indicate the racial breakdown of the total apprentices and on-the-job trainees shown in Table A.

RETURN WITH BID

ADDITIONAL FEDERAL REQUIREMENTS

In addition to the Required Contract Provisions for Federal-Aid Construction Contracts (FHWA 1273), all bidders make the following certifications.

- A. By the execution of this proposal, the signing bidder certifies that the bidding entity has not, either directly or indirectly, entered into any agreement, participated in any collusion, or otherwise taken any action, in restraint of free competitive bidding in connection with the submitted bid. This statement made by the undersigned bidder is true and correct under penalty of perjury under the laws of the United States.
- B. CERTIFICATION, EQUAL EMPLOYMENT OPPORTUNITY:
1. Have you participated in any previous contracts or subcontracts subject to the equal opportunity clause. YES _____ NO _____
 2. If answer to #1 is yes, have you filed with the Joint Reporting Committee, the Director of OFCC, any Federal agency, or the former President's Committee on Equal Employment Opportunity, all reports due under the applicable filing requirements of those organizations? YES _____ NO _____

RETURN WITH BID

**Contract No. 89667
STARK County
Section 13-00167-00-PP
Project RS-0175(029)
Various Routes
District 4 Construction Funds**

PROPOSAL SIGNATURE SHEET

The undersigned bidder hereby makes and submits this bid on the subject Proposal, thereby assuring the Department that all requirements of the Invitation for Bids and rules of the Department have been met, that there is no misunderstanding of the requirements of paragraph 3 of this Proposal, and that the contract will be executed in accordance with the rules of the Department if an award is made on this bid.

(IF AN INDIVIDUAL)

Firm Name _____
Signature of Owner _____
Business Address _____

(IF A CO-PARTNERSHIP)

Firm Name _____
By _____
Business Address _____
Name and Address of All Members of the Firm: _____

(IF A CORPORATION)

Corporate Name _____
By _____
Signature of Authorized Representative _____
Typed or printed name and title of Authorized Representative _____
Attest _____
Signature _____
(IF A JOINT VENTURE, USE THIS SECTION FOR THE MANAGING PARTY AND THE SECOND PARTY SHOULD SIGN BELOW)
Business Address _____

(IF A JOINT VENTURE)

Corporate Name _____
By _____
Signature of Authorized Representative _____
Typed or printed name and title of Authorized Representative _____
Attest _____
Signature _____
Business Address _____

If more than two parties are in the joint venture, please attach an additional signature sheet.



This Annual Proposal Bid Bond shall become effective at 12:01 AM (CDST) on _____ and shall be valid until _____ 11:59 PM (CDST).

KNOW ALL PERSONS BY THESE PRESENTS, That We _____

as PRINCIPAL, and _____

as SURETY, and held jointly, severally and firmly bound unto the STATE OF ILLINOIS in the penal sum of 5 percent of the total bid price, or for the amount specified in the bid proposal under "Proposal Guaranty" in effect on the date of the Invitation for Bids, whichever is the lesser sum, well and truly to be paid unto said STATE OF ILLINOIS, for the payment of which we bind ourselves, our heirs, executors, administrators, successors and assigns.

THE CONDITION OF THE FOREGOING OBLIGATION IS SUCH that whereas, the PRINCIPAL may submit bid proposal(s) to the STATE OF ILLINOIS, acting through the Department of Transportation, for various improvements published in the Transportation Bulletin during the effective term indicated above.

NOW, THEREFORE, if the Department shall accept the bid proposal(s) of the PRINCIPAL; and if the PRINCIPAL shall, within the time and as specified in the bidding and contract documents; and if, after award by the Department, the PRINCIPAL shall enter into a contract in accordance with the terms of the bidding and contract documents including evidence of the required insurance coverages and providing such bond as specified with good and sufficient surety for the faithful performance of such contract and for the prompt payment of labor and material furnished in the prosecution thereof; or if, in the event of the failure of the PRINCIPAL to enter into such contract and to give the specified bond, the PRINCIPAL pays to the Department the difference not to exceed the penalty hereof between the amount specified in the bid proposal and such larger amount for which the Department may contract with another party to perform the work covered by said bid proposal, then this obligation shall be null and void, otherwise, it shall remain in full force and effect.

IN THE EVENT the Department determines the PRINCIPAL has failed to comply with any requirement as set forth in the preceding paragraph, then Surety shall pay the penal sum to the Department within fifteen (15) days of written demand therefor. If Surety does not make full payment within such period of time, the Department may bring an action to collect the amount owed. Surety is liable to the Department for all its expenses, including attorney's fees, incurred in any litigation in which it prevails either in whole or in part.

In TESTIMONY WHEREOF, the said PRINCIPAL has caused this instrument to be signed by its officer _____ day of _____ A.D., _____

In TESTIMONY WHEREOF, the said SURETY has caused this instrument to be signed by its officer _____ day of _____ A.D., _____

(Company Name)

(Company Name)

By _____
(Signature and Title)

By _____
(Signature of Attorney-in-Fact)

Notary for PRINCIPAL

Notary for SURETY

STATE OF _____
COUNTY OF _____

STATE OF _____
COUNTY OF _____

Signed and attested before me on _____ (date)

Signed and attested before me on _____ (date)

by _____
(Name of Notary Public)

by _____
(Name of Notary Public)

(Seal) _____
(Signature of Notary Public)

(Seal) _____
(Signature of Notary Public)

(Date Commission Expires)

(Date Commission Expires)

In lieu of completing the above section of the Annual Proposal Bid Bond form, the Principal may file an Electronic Bid Bond. By signing the proposal(s) the Principal is ensuring the identified electronic bid bond has been executed and the Principal and Surety are firmly bound unto the State of Illinois under the conditions of the bid bond as shown above.

Electronic Bid Bond ID #	Company/Bidder Name	Signature and Title
--------------------------	---------------------	---------------------

This bond may be terminated, at Surety's request, upon giving not less than thirty (30) days prior written notice of the cancellation/termination of the bond. Said written notice shall be issued to the Illinois Department of Transportation, Chief Contracts Official, 2300 South Dirksen Parkway, Springfield, Illinois, 62764, and shall be served in person, by receipted courier delivery or certified or registered mail, return receipt requested. Said notice period shall commence on the first calendar day following the Department's receipt of written cancellation/termination notice. Surety shall remain firmly bound to all obligations herein for proposals submitted prior to the cancellation/termination. Surety shall be released and discharged from any obligation(s) for proposals submitted for any letting or date after the effective date of cancellation/termination.



Return with Bid

Division of Highways
Proposal Bid Bond

Item No. _____

Letting Date _____

KNOW ALL PERSONS BY THESE PRESENTS, That We _____

as PRINCIPAL, and _____

as SURETY, and held jointly, severally and firmly bound unto the STATE OF ILLINOIS in the penal sum of 5 percent of the total bid price, or for the amount specified in the bid proposal under "Proposal Guaranty" in effect on the date of the Invitation for Bids, whichever is the lesser sum, well and truly to be paid unto said STATE OF ILLINOIS, for the payment of which we bind ourselves, our heirs, executors, administrators, successors and assigns.

THE CONDITION OF THE FOREGOING OBLIGATION IS SUCH that whereas, the PRINCIPAL has submitted a bid proposal to the STATE OF ILLINOIS, acting through the Department of Transportation, for the improvement designated by the Transportation Bulletin Item Number and Letting Date indicated above.

NOW, THEREFORE, if the Department shall accept the bid proposal of the PRINCIPAL; and if the PRINCIPAL shall, within the time and as specified in the bidding and contract documents; and if, after award by the Department, the PRINCIPAL shall enter into a contract in accordance with the terms of the bidding and contract documents including evidence of the required insurance coverages and providing such bond as specified with good and sufficient surety for the faithful performance of such contract and for the prompt payment of labor and material furnished in the prosecution thereof; or if, in the event of the failure of the PRINCIPAL to enter into such contract and to give the specified bond, the PRINCIPAL pays to the Department the difference not to exceed the penalty hereof between the amount specified in the bid proposal and such larger amount for which the Department may contract with another party to perform the work covered by said bid proposal, then this obligation shall be null and void, otherwise, it shall remain in full force and effect.

IN THE EVENT the Department determines the PRINCIPAL has failed to comply with any requirement as set forth in the preceding paragraph, then Surety shall pay the penal sum to the Department within fifteen (15) days of written demand therefor. If Surety does not make full payment within such period of time, the Department may bring an action to collect the amount owed. Surety is liable to the Department for all its expenses, including attorney's fees, incurred in any litigation in which it prevails either in whole or in part.

In TESTIMONY WHEREOF, the said PRINCIPAL has caused this instrument to be signed by its officer _____ day of _____ A.D., _____

In TESTIMONY WHEREOF, the said SURETY has caused this instrument to be signed by its officer _____ day of _____ A.D., _____

(Company Name)

(Company Name)

By _____ (Signature and Title)

By _____ (Signature of Attorney-in-Fact)

Notary for PRINCIPAL

Notary for SURETY

STATE OF _____
COUNTY OF _____

STATE OF _____
COUNTY OF _____

Signed and attested before me on _____ (date)
by _____

Signed and attested before me on _____ (date)
by _____

(Name of Notary Public)

(Name of Notary Public)

(Seal) _____ (Signature of Notary Public)

(Seal) _____ (Signature of Notary Public)

(Date Commission Expires)

(Date Commission Expires)

In lieu of completing the above section of the Proposal Bid Bond form, the Principal may file an Electronic Bid Bond. By signing the proposal the Principal is ensuring the identified electronic bid bond has been executed and the Principal and Surety are firmly bound unto the State of Illinois under the conditions of the bid bond as shown above.

Electronic Bid Bond ID # _____ Company/Bidder Name _____ Signature and Title _____

(1) Policy

It is public policy that disadvantageded businesses as defined in 49 CFR Part 26 and the Special Provision shall have the maximum opportunity to participate in the performance of contracts financed in whole or in part with Federal or State funds. Consequently the requirements of 49 CFR Part 26 apply to this contract.

(2) Obligation

The contractor agrees to ensure that disadvantageded businesses as defined in 49 CFR Part 26 and the Special Provision have the maximum opportunity to participate in the performance of contracts or subcontracts financed in whole or in part with Federal or State funds. The contractor shall take all necessary and reasonable steps in accordance with 49 CFR Part 26 and the Special Provision to ensure that said businesses have the maximum opportunity to compete for and perform under this contract. The contractor shall not discriminate on the basis of race, color, national origin or sex in the award and performance of contracts.

(3) Project and Bid Identification

Complete the following information concerning the project and bid:

Route _____	Total Bid _____
Section _____	Contract DBE Goal _____ (Percent) _____ (Dollar Amount)
Project _____	
County _____	
Letting Date _____	
Contract No. _____	
Letting Item No. _____	

(4) Assurance

I, acting in my capacity as an officer of the undersigned bidder (or bidders if a joint venture), hereby assure the Department that on this project my company : (check one)

- Meets or exceeds contract award goals and has provided documented participation as follows:
Disadvantaged Business Participation _____ percent

Attached are the signed participation statements, forms SBE 2025, required by the Special Provision evidencing availability and use of each business participating in this plan and assuring that each business will perform a commercially useful function in the work of the contract.

- Failed to meet contract award goals and has included good faith effort documentation to meet the goals and that my company has provided participation as follows:

Disadvantaged Business Participation _____ percent

The contract goals should be accordingly modified or waived. Attached is all information required by the Special Provision in support of this request including good faith effort. Also attached are the signed participation statements, forms SBE 2025, required by the Special Provision evidencing availability and use of each business participating in this plan and assuring that each business will perform a commercially useful function in the work of the contract.

Company

By _____

Title _____

Date _____

The "as read" Low Bidder is required to comply with the Special Provision.

Submit only one utilization plan for each project. The utilization plan shall be submitted in accordance with the special provision.

Bureau of Small Business Enterprises
2300 South Dirksen Parkway
Springfield, Illinois 62764

Local Let Projects
Submit forms to the
Local Agency

PROPOSAL ENVELOPE



PROPOSALS

for construction work advertised for bids by the
Illinois Department of Transportation

Item No.	Item No.	Item No.

Submitted By:

Name:
Address:
Phone No.

Bidders should use an IDOT proposal envelope or affix this form to the front of a 10" x 13" envelope for the submittal of bids. If proposals are mailed, they should be enclosed in a second or outer envelope addressed to:

Engineer of Design and Environment - Room 326
Illinois Department of Transportation
2300 South Dirksen Parkway
Springfield, Illinois 62764

NOTICE

Individual bids, including Bid Bond and/or supplemental information if required, should be securely stapled.

CONTRACTOR OFFICE COPY OF CONTRACT SPECIFICATIONS

NOTICE

None of the following material needs to be returned with the bid package unless the special provisions require documentation and/or other information to be submitted.

**Contract No. 89667
STARK County
Section 13-00167-00-PP
Project RS-0175(029)
Various Routes
District 4 Construction Funds**



Illinois Department of Transportation

SUBCONTRACTOR DOCUMENTATION

Public Acts 96-0795, 96-0920, and 97-0895 enacted substantial changes to the provisions of the Code (30 ILCS 500). Among the changes are provisions affecting subcontractors. The Contractor awarded this contract will be required as a material condition of the contract to implement and enforce the contract requirements applicable to subcontractors that entered into a contractual agreement with a total value of \$50,000 or more with a person or entity who has a contract subject to the Code and approved in accordance with article 108.01 of the Standard Specifications for Road and Bridge Construction.

If the Contractor seeks approval of subcontractors to perform a portion of the work, and approval is granted by the Department, the Contractor shall provide a copy of the subcontract to the Illinois Department of Transportation's CPO upon request within 15 calendar days after execution of the subcontract.

Financial disclosures required pursuant to Sec. 50-35 of the Code must be submitted for all applicable subcontractors. The subcontract shall contain the certifications required to be made by subcontractors pursuant to Article 50 of the Code. This Notice to Bidders includes a document incorporating all required subcontractor certifications and disclosures for use by the Contractor in compliance with this mandate. The document is entitled State Required Ethical Standards Governing Subcontractors.

RETURN WITH SUBCONTRACT

STATE ETHICAL STANDARDS GOVERNING SUBCONTRACTORS

Article 50 of the Code establishes the duty of all State CPOs, SPOs, and their designees to maximize the value of the expenditure of public moneys in procuring goods, services, and contracts for the State of Illinois and to act in a manner that maintains the integrity and public trust of State government. In discharging this duty, they are charged by law to use all available information, reasonable efforts, and reasonable actions to protect, safeguard, and maintain the procurement process of the State of Illinois.

The certifications hereinafter made by the subcontractor are each a material representation of fact upon which reliance is placed should the Department approve the subcontractor. The CPO may terminate or void the contract approval if it is later determined that the bidder or subcontractor rendered a false or erroneous certification. If a false certification is made by a subcontractor the contractor's submitted bid and the executed contract may not be declared void unless the contractor refuses to terminate the subcontract upon the State's request after a finding that the subcontractor's certification was false.

Section 50-2 of the Code provides that every person that has entered into a multi-year contract and every subcontractor with a multi-year subcontract shall certify, by July 1 of each fiscal year covered by the contract after the initial fiscal year, to the responsible CPO whether it continues to satisfy the requirements of Article 50 pertaining to the eligibility for a contract award. If a contractor or subcontractor is not able to truthfully certify that it continues to meet all requirements, it shall provide with its certification a detailed explanation of the circumstances leading to the change in certification status. A contractor or subcontractor that makes a false statement material to any given certification required under Article 50 is, in addition to any other penalties or consequences prescribed by law, subject to liability under the Whistleblower Reward and Protection Act for submission of a false claim.

A. Bribery

Section 50-5. Bribery.

(a) Prohibition. No person or business shall be awarded a contract or subcontract under this Code who:

(1) has been convicted under the laws of Illinois or any other state of bribery or attempting to bribe an officer or employee of the State of Illinois or any other state in that officer's or employee's official capacity; or

(2) has made an admission of guilt of that conduct that is a matter of record but has not been prosecuted for that conduct.

(b) Businesses. No business shall be barred from contracting with any unit of State or local government, or subcontracting under such a contract, as a result of a conviction under this Section of any employee or agent of the business if the employee or agent is no longer employed by the business and:

(1) the business has been finally adjudicated not guilty; or

(2) the business demonstrates to the governmental entity with which it seeks to contract, or which is signatory to the contract to which the subcontract relates, and that entity finds that the commission of the offense was not authorized, requested, commanded, or performed by a director, officer, or high managerial agent on behalf of the business as provided in paragraph (2) of subsection (a) of Section 5-4 of the Criminal Code of 2012.

(c) Conduct on behalf of business. For purposes of this Section, when an official, agent, or employee of a business committed the bribery or attempted bribery on behalf of the business and in accordance with the direction or authorization of a responsible official of the business, the business shall be chargeable with the conduct.

(d) Certification. Every bid submitted to and contract executed by the State, and every subcontract subject to Section 20-120 of the Code shall contain a certification by the contractor or the subcontractor, respectively, that the contractor or subcontractor is not barred from being awarded a contract or subcontract under this Section and acknowledges that the CPO may declare the related contract void if any certifications required by this Section are false. A contractor who makes a false statement, material to the certification, commits a Class 3 felony.

The contractor or subcontractor certifies that it is not barred from being awarded a contract under Section 50-5.

B. Felons

Section 50-10. Felons.

(a) Unless otherwise provided, no person or business convicted of a felony shall do business with the State of Illinois or any State agency, or enter into a subcontract, from the date of conviction until 5 years after the date of completion of the sentence for that felony, unless no person held responsible by a prosecutorial office for the facts upon which the conviction was based continues to have any involvement with the business.

(b) Certification. Every bid submitted to and contract executed by the State and every subcontract subject to Section 20-120 of the Code shall contain a certification by the bidder or contractor or subcontractor, respectively, that the bidder, contractor, or subcontractor is not barred from being awarded a contract or subcontract under this Section and acknowledges that the CPO may declare the related contract void if any of the certifications required by this Section are false.

RETURN WITH SUBCONTRACT

C. Debt Delinquency

Section 50-11 and 50-12. Debt Delinquency.

The contractor or bidder or subcontractor, respectively, certifies that it, or any affiliate, is not barred from being awarded a contract or subcontract under the Code. Section 50-11 prohibits a person from entering into a contract with a State agency, or entering into a subcontract, if it knows or should know that it, or any affiliate, is delinquent in the payment of any debt to the State as defined by the Debt Collection Board. Section 50-12 prohibits a person from entering into a contract with a State agency, or entering into a subcontract, if it, or any affiliate, has failed to collect and remit Illinois Use Tax on all sales of tangible personal property into the State of Illinois in accordance with the provisions of the Illinois Use Tax Act. The bidder or contractor or subcontractor, respectively, further acknowledges that the CPO may declare the related contract void if this certification is false or if the bidder, contractor, or subcontractor, or any affiliate, is determined to be delinquent in the payment of any debt to the State during the term of the contract.

D. Prohibited Bidders, Contractors and Subcontractors

Section 50-10.5 and 50-60(c). Prohibited bidders, contractors and subcontractors.

The bidder or contractor or subcontractor, respectively, certifies in accordance with 30 ILCS 500/50-10.5 that no officer, director, partner or other managerial agent of the contracting business has been convicted of a felony under the Sarbanes-Oxley Act of 2002 or a Class 3 or Class 2 felony under the Illinois Securities Law of 1953 or if in violation of Subsection (c) for a period of five years from the date of conviction. Every bid submitted to and contract executed by the State and every subcontract subject to Section 20-120 of the Code shall contain a certification by the bidder, contractor, or subcontractor, respectively, that the bidder, contractor, or subcontractor is not barred from being awarded a contract or subcontract under this Section and acknowledges that the CPO shall declare the related contract void if any of the certifications completed pursuant to this Section are false.

E. Section 42 of the Environmental Protection Act

The bidder or contractor or subcontractor, respectively, certifies in accordance with 30 ILCS 500/50-14 that the bidder, contractor, or subcontractor, is not barred from being awarded a contract or entering into a subcontract under this Section which prohibits the bidding on or entering into contracts with the State of Illinois or a State agency, or entering into any subcontract, that is subject to the Code by a person or business found by a court or the Pollution Control Board to have committed a willful or knowing violation of Section 42 of the Environmental Protection Act for a period of five years from the date of the order. The bidder or contractor or subcontractor, respectively, acknowledges that the CPO may declare the contract void if this certification is false.

The undersigned, on behalf of the subcontracting company, has read and understands the above certifications and makes the certifications as required by law.

_____ Name of Subcontracting Company		
_____ Authorized Officer	_____ Date	

RETURN WITH SUBCONTRACT
SUBCONTRACTOR DISCLOSURES

I. DISCLOSURES

- A.** The disclosures hereinafter made by the subcontractor are each a material representation of fact upon which reliance is placed. The subcontractor further certifies that the Department has received the disclosure forms for each subcontract.

The CPO may void the bid, contract, or subcontract, respectively, if it is later determined that the bidder or subcontractor rendered a false or erroneous disclosure. A contractor or subcontractor may be scuspended or debarred for violations of the Code. Furthermore, the CPO may void the contract.

B. Financial Interests and Conflicts of Interest

1. Section 50-35 of the Code provides that all subcontracts with a total value of \$50,000 or more, from subcontractors identified in Section 20-120 of the Code, shall be accompanied by disclosure of the financial interests of the subcontractor. This disclosed information for the subcontractor, will be maintained as public information subject to release by request pursuant to the Freedom of Information Act, filed with the Procurement Policy Board, and shall be incorporated as a material term of the Prime Contractor's contract. Furthermore, pursuant to this Section, the Procurement Policy Board may recommend to allow or void a contract or subcontract based on a potential conflict of interest.

The financial interests to be disclosed shall include ownership or distributive income share that is in excess of 5%, or an amount greater than 60% of the annual salary of the Governor, of the subcontracting entity or its parent entity, whichever is less, unless the subcontractor is a publicly traded entity subject to Federal 10K reporting, in which case it may submit its 10K disclosure in place of the prescribed disclosure. If a subcontractor is a privately held entity that is exempt from Federal 10K reporting, but has more than 100 shareholders, it may submit the information that Federal 10K companies are required to report, and list the names of any individual or entity holding any ownership share that is in excess of 5%. The disclosure shall include the names, addresses, and dollar or proportionate share of ownership of each individual making the disclosure, their instrument of ownership or beneficial relationship, and notice of any potential conflict of interest resulting from the current ownership or beneficial interest of each individual making the disclosure having any of the relationships identified in Section 50-35 and on the disclosure form.

The current annual salary of the Governor is \$177,412.00.

In addition, all disclosures shall indicate any other current or pending contracts, subcontracts, proposals, leases, or other ongoing procurement relationships the subcontracting entity has with any other unit of state government and shall clearly identify the unit and the contract, subcontract, proposal, lease, or other relationship.

2. Disclosure Forms. Disclosure Form A is attached for use concerning the individuals meeting the above ownership or distributive share requirements. A separate Disclosure Form A must be submitted with the bid for each individual meeting the above requirements. In addition, a second form (Disclosure Form B) provides for the disclosure of current or pending procurement relationships with other (non-IDOT) state agencies and a total ownership certification.

C. Disclosure Form Instructions

Form A Instructions for Financial Information & Potential Conflicts of Interest

If the subcontractor is a publicly traded entity subject to Federal 10K reporting, the 10K Report may be submitted to meet the requirements of Form A. If a subcontractor is a privately held entity that is exempt from Federal 10K reporting, but has more than 100 shareholders, it may submit the information that Federal 10K companies are required to report, and list the names of any individual or entity holding any ownership share that is in excess of 5%. If a subcontractor is not subject to Federal 10K reporting, the subcontractor must determine if any individuals are required by law to complete a financial disclosure form. To do this, the subcontractor should answer each of the following questions. A "YES" answer indicates Form A must be completed. If the answer to each of the following questions is "NO", then the NOT APPLICABLE STATEMENT on the second page of Form A must be signed and dated by an individual that is authorized to execute contracts for the subcontracting company. Note: These questions are for assistance only and are not required to be completed.

1. Does anyone in your organization have a direct or beneficial ownership share of greater than 5% of the bidding entity or parent entity? YES ___ NO ___
2. Does anyone in your organization have a direct or beneficial ownership share of less than 5%, but which has a value greater than 60% of the annual salary of the Governor? YES ___ NO ___
3. Does anyone in your organization receive more than 60% of the annual salary of the Governor of the subcontracting entity's or parent entity's distributive income? YES ___ NO ___

(Note: Distributive income is, for these purposes, any type of distribution of profits. An annual salary is not distributive income.)

4. Does anyone in your organization receive greater than 5% of the subcontracting entity's or parent entity's total distributive income, but which is less than 60% of the annual salary of the Governor? YES ___ NO ___

(Note: Only one set of forms needs to be completed per individual per subcontract even if a specific individual would require a yes answer to more than one question.)

A "YES" answer to any of these questions requires the completion of Form A. The subcontractor must determine each individual in the subcontracting entity or the subcontracting entity's parent company that would cause the questions to be answered "Yes". Each form must be signed and dated by an individual that is authorized to execute contracts for your organization. The individual signing can be, but does not have to be, the individual for which the form is being completed. The subcontractor is responsible for the accuracy of any information provided.

If the answer to each of the above questions is "NO", then the NOT APPLICABLE STATEMENT on page 2 of Form A must be signed and dated by an individual that is authorized to execute contracts for your company.

RETURN WITH SUBCONTRACT

Form B: Instructions for Identifying Other Contracts & Procurement Related Information

Disclosure Form B must be completed for each subcontract submitted by the subcontracting entity. *Note: Checking the NOT APPLICABLE STATEMENT on Form A does not allow the subcontractor to ignore Form B. Form B must be completed, checked, and dated or the subcontract will not be approved.*

The Subcontractor shall identify, by checking Yes or No on Form B, whether it has any pending contracts, subcontracts, leases, bids, proposals, or other ongoing procurement relationship with any other (non-IDOT) State of Illinois agency. If "No" is checked, the subcontractor only needs to complete the check box on the bottom of Form B. If "Yes" is checked, the subcontractor must list all non-IDOT State of Illinois agency pending contracts, subcontracts, leases, bids, proposals, and other ongoing procurement relationships. These items may be listed on Form B or on an attached sheet(s). Contracts with cities, counties, villages, etc. are not considered State of Illinois agency contracts and are not to be included. Contracts or subcontracts with other State of Illinois agencies such as the Department of Natural Resources or the Capital Development Board must be included.

ILLINOIS DEPARTMENT OF TRANSPORTATION

Form A Subcontractor: Financial Information & Potential Conflicts of Interest Disclosure

Subcontractor Name, Legal Address, City, State, Zip, Telephone Number, Email Address, Fax Number (if available)

Disclosure of the information contained in this Form is required by Section 50-35 of the Code (30 ILCS 500). Subcontractors desiring to enter into a subcontract of a State of Illinois contract must disclose the financial information and potential conflict of interest information as specified in this Disclosure Form.

The current annual salary of the Governor is \$177,412.00.

DISCLOSURE OF FINANCIAL INFORMATION

1. Disclosure of Financial Information. The individual named below has an interest in the SUBCONTRACTOR (or its parent) in terms of ownership or distributive income share in excess of 5%, or an interest which has a value of more than 60% of the annual salary of the Governor.

FOR INDIVIDUAL (type or print information) NAME: ADDRESS Type of ownership/distributable income share: stock sole proprietorship Partnership other: (explain on separate sheet): % or \$ value of ownership/distributable income share:

2. Disclosure of Potential Conflicts of Interest. Check "Yes" or "No" to indicate which, if any, of the following potential conflict of interest relationships apply. If the answer to any question is "Yes", please attach additional pages and describe.

(a) State employment, currently or in the previous 3 years, including contractual employment of services. Yes ___ No ___

If your answer is yes, please answer each of the following questions.

1. Are you currently an officer or employee of either the Capitol Development Board or the Illinois State Toll Highway Authority? Yes ___ No ___

2. Are you currently appointed to or employed by any agency of the State of Illinois? If you are currently appointed to or employed by any agency of the State of Illinois, and your annual salary exceeds 60% of the annual salary of the Governor, provide the name the State agency for which you are employed and your annual salary.

RETURN WITH SUBCONTRACT

3. If you are currently appointed to or employed by any agency of the State of Illinois, and your annual salary exceeds 60% of the annual salary of the Governor, are you entitled to receive (i) more than 7 1/2% of the total distributable income of your firm, partnership, association or corporation, or (ii) an amount in excess of 100% of the annual salary of the Governor?
Yes ___ No ___

4. If you are currently appointed to or employed by any agency of the State of Illinois, and your annual salary exceeds 60% of the annual salary of the Governor, are you and your spouse or minor children entitled to receive (i) more than 15 % in the aggregate of the total distributable income of your firm, partnership, association or corporation, or (ii) an amount in excess of two times the salary of the Governor?
Yes ___ No ___

(b) State employment of spouse, father, mother, son, or daughter, including contractual employment services in the previous 2 years.

Yes ___ No ___

If your answer is yes, please answer each of the following questions.

1. Is your spouse or any minor children currently an officer or employee of the Capitol Development Board or the Illinois State Toll Highway Authority?
Yes ___ No ___

2. Is your spouse or any minor children currently appointed to or employed by any agency of the State of Illinois? If your spouse or minor children is/are currently appointed to or employed by any agency of the State of Illinois, and his/her annual salary exceeds 60% of the annual salary of the Governor, provide the name of your spouse and/or minor children, the name of the State agency for which he/she is employed and his/her annual salary. _____

3. If your spouse or any minor children is/are currently appointed to or employed by any agency of the State of Illinois, and his/her annual salary exceeds 60% of the annual salary of the Governor, are you entitled to receive (i) more than 7 1/2% of the total distributable income of your firm, partnership, association or corporation, or (ii) an amount in excess of 100% of the annual salary of the Governor?
Yes ___ No ___

4. If your spouse or any minor children are currently appointed to or employed by any agency of the State of Illinois, and his/her annual salary exceeds 60% of the annual salary of the Governor, are you and your spouse or minor children entitled to receive (i) more than 15 % in the aggregate of the total distributable income of your firm, partnership, association or corporation, or (ii) an amount in excess of two times the salary of the Governor?
Yes ___ No ___

(c) Elective status; the holding of elective office of the State of Illinois, the government of the United States, any unit of local government authorized by the Constitution of the State of Illinois or the statutes of the State of Illinois currently or in the previous 3 years.
Yes ___ No ___

(d) Relationship to anyone holding elective office currently or in the previous 2 years; spouse, father, mother, son, or daughter.
Yes ___ No ___

(e) Appointive office; the holding of any appointive government office of the State of Illinois, the United States of America, or any unit of local government authorized by the Constitution of the State of Illinois or the statutes of the State of Illinois, which office entitles the holder to compensation in excess of the expenses incurred in the discharge of that office currently or in the previous 3 years.
Yes ___ No ___

(f) Relationship to anyone holding appointive office currently or in the previous 2 years; spouse, father, mother, son, or daughter.
Yes ___ No ___

(g) Employment, currently or in the previous 3 years, as or by any registered lobbyist of the State government.
Yes ___ No ___

RETURN WITH SUBCONTRACT

(h) Relationship to anyone who is or was a registered lobbyist in the previous 2 years; spouse, father, mother, son, or daughter. Yes ___ No ___

(i) Compensated employment, currently or in the previous 3 years, by any registered election or reelection committee registered with the Secretary of State or any county clerk of the State of Illinois, or any political action committee registered with either the Secretary of State or the Federal Board of Elections. Yes ___ No ___

(j) Relationship to anyone; spouse, father, mother, son, or daughter; who was a compensated employee in the last 2 years by any registered election or re-election committee registered with the Secretary of State or any county clerk of the State of Illinois, or any political action committee registered with either the Secretary of State or the Federal Board of Elections. Yes ___ No ___

3 Communication Disclosure.

Disclose the name and address of each lobbyist and other agent of the bidder or offeror who is not identified in Section 2 of this form, who is has communicated, is communicating, or may communicate with any State officer or employee concerning the bid or offer. This disclosure is a continuing obligation and must be promptly supplemented for accuracy throughout the process and throughout the term of the contract. If no person is identified, enter "None" on the line below:

Name and address of person(s): _____

RETURN WITH SUBCONTRACT

4. Suspension or Debarment Disclosure. For each of the persons identified under Sections 2 and 3 of this form, disclose whether any of the following has occurred within the previous 10 years: suspension or debarment from contracting with any governmental entity; professional licensure discipline; bankruptcies; adverse civil judgments and administrative findings; and criminal felony convictions. This disclosure is a continuing obligation and must be promptly supplemented for accuracy throughout the procurement process and term of the contract. If no person is identified, enter "None" on the line below:

Name of person(s): _____

Nature of disclosure: _____

APPLICABLE STATEMENT

This Disclosure Form A is submitted on behalf of the INDIVIDUAL named on previous page. Under penalty of perjury, I certify the contents of this disclosure to be true and accurate to the best of my knowledge.

Completed by: _____ Date _____
Signature of Individual or Authorized Officer

NOT APPLICABLE STATEMENT

Under penalty of perjury, I have determined that no individuals associated with this organization meet the criteria that would require the completion of this Form A.

This Disclosure Form A is submitted on behalf of the SUBCONTRACTOR listed on the previous page.

_____ Date _____
Signature of Authorized Officer

RETURN WITH SUBCONTRACT

ILLINOIS DEPARTMENT OF TRANSPORTATION

Form B Subcontractor: Other Contracts & Financial Related Information Disclosure

Form with fields: Subcontractor Name, Legal Address, City, State, Zip, Telephone Number, Email Address, Fax Number (if available)

Disclosure of the information contained in this Form is required by Section 50-35 of the Code (30 ILCS 500). This information shall become part of the publicly available contract file. This Form B must be completed for subcontracts with a total value of \$50,000 or more, from subcontractors identified in Section 20-120 of the Code, and for all open-ended contracts.

DISCLOSURE OF OTHER CONTRACTS, SUBCONTRACTS, AND PROCUREMENT RELATED INFORMATION

1. Identifying Other Contracts & Procurement Related Information. The SUBCONTRACTOR shall identify whether it has any pending contracts, subcontracts, including leases, bids, proposals, or other ongoing procurement relationship with any other State of Illinois agency: Yes ___ No ___

If "No" is checked, the subcontractor only needs to complete the signature box on this page.

2. If "Yes" is checked. Identify each such relationship by showing State of Illinois agency name and other descriptive information such as bid or project number (attach additional pages as necessary). SEE DISCLOSURE FORM INSTRUCTIONS:

THE FOLLOWING STATEMENT MUST BE CHECKED

Signature box with fields: Signature of Authorized Officer, Date

OWNERSHIP CERTIFICATION

Please certify that the following statement is true if the individuals for all submitted Form A disclosures do not total 100% of ownership

Any remaining ownership interest is held by individuals receiving less than \$106,447.20 of the bidding entity's or parent entity's distributive income or holding less than a 5% ownership interest.

Yes No N/A (Form A disclosure(s) established 100% ownership)



- 1. TIME AND PLACE OF OPENING BIDS.** Sealed proposals for the improvement described herein will be received by the Department of Transportation. Electronic bids are to be submitted to the electronic bidding system (iCX-Integrated Contractors Exchange). Paper-based bids are to be submitted to the Chief Procurement Officer for the Department of Transportation in care of the Chief Contracts Official at the Harry R. Hanley Building, 2300 South Dirksen Parkway, in Springfield, Illinois until 10:00 a.m. March 4, 2016. All bids will be gathered, sorted, publicly opened and read in the auditorium at the Department of Transportation's Harry R. Hanley Building shortly after 10:00 a.m.
- 2. DESCRIPTION OF WORK.** The proposed improvement is identified and advertised for bids in the Invitation for Bids as:

**Contract No. 89667
STARK County
Section 13-00167-00-PP
Project RS-0175(029)
Various Routes
District 4 Construction Funds**

Project consists of constructing a single bituminous surface treatment over existing oil and chip surfaces on various County Highways in Stark County.

- 3. INSTRUCTIONS TO BIDDERS.** (a) This Notice, the invitation for bids, proposal and letter of award shall, together with all other documents in accordance with Article 101.09 of the Standard Specifications for Road and Bridge Construction, become part of the contract. Bidders are cautioned to read and examine carefully all documents, to make all required inspections, and to inquire or seek explanation of the same prior to submission of a bid.

(b) State law, and, if the work is to be paid wholly or in part with Federal-aid funds, Federal law requires the bidder to make various certifications as a part of the proposal and contract. By execution and submission of the proposal, the bidder makes the certification contained therein. A false or fraudulent certification shall, in addition to all other remedies provided by law, be a breach of contract and may result in termination of the contract.
- 4. AWARD CRITERIA AND REJECTION OF BIDS.** This contract will be awarded to the lowest responsive and responsible bidder considering conformity with the terms and conditions established by the Department in the rules, Invitation for Bids and contract documents. The issuance of plans and proposal forms for bidding based upon a prequalification rating shall not be the sole determinant of responsibility. The Department reserves the right to determine responsibility at the time of award, to reject any or all proposals, to readvertise the proposed improvement, and to waive technicalities.

By Order of the
Illinois Department of Transportation

Randall S. Blankenhorn,
Secretary

**INDEX
FOR
SUPPLEMENTAL SPECIFICATIONS
AND RECURRING SPECIAL PROVISIONS**

Adopted January 1, 2015

This index contains a listing of SUPPLEMENTAL SPECIFICATIONS, frequently used RECURRING SPECIAL PROVISIONS, and LOCAL ROADS AND STREETS RECURRING SPECIAL PROVISIONS.

ERRATA Standard Specifications for Road and Bridge Construction (Adopted 1-1-12) (Revised 1-1-15)

SUPPLEMENTAL SPECIFICATIONS

<u>Std. Spec. Sec.</u>	<u>Page No.</u>
101 Definition of Terms	1
102 Advertisement, Bidding, Award, and Contract Execution	2
105 Control of Work	3
106 Control of Materials	5
107 Legal Regulations and Responsibility to Public	6
108 Prosecution and Progress	14
109 Measurement and Payment	15
202 Earth and Rock Excavation	17
211 Topsoil and Compost	19
250 Seeding	20
253 Planting Woody Plants	21
280 Temporary Erosion and Sediment Control	23
312 Stabilized Subbase	24
406 Hot-Mix Asphalt Binder and Surface Course	25
407 Hot-Mix Asphalt Pavement (Full-Depth)	28
420 Portland Cement Concrete Pavement	32
424 Portland Cement Concrete Sidewalk	34
440 Removal of Existing Pavement and Appurtenances	35
502 Excavation for Structures	36
503 Concrete Structures	37
504 Precast Concrete Structures	40
506 Cleaning and Painting New Steel Structures	41
512 Piling	42
516 Drilled Shafts	43
521 Bearings	44
540 Box Culverts	45
588 Bridge Relief Joint System	46
589 Elastic Joint Sealer	48
602 Catch Basin, Manhole, Inlet, Drainage Structure, and Valve Vault Construction, Adjustment, and Reconstruction	49
603 Adjusting Frames and Grates of Drainage and Utility Structures	50
606 Concrete Gutter, Curb, Median, and Paved Ditch	52
610 Shoulder Inlets with Curb	53
639 Precast Prestressed Concrete Sight Screen	54
642 Shoulder Rumble Strips	55
643 Impact Attenuators	56
644 High Tension Cable Median Barrier	58
669 Removal and Disposal of Regulated Substances	60
670 Engineer's Field Office and Laboratory	64

<u>Std. Spec. Sec.</u>	<u>Page No.</u>
701 Work Zone Traffic Control and Protection	65
706 Impact Attenuators, Temporary	68
707 Movable Traffic Barrier	71
708 Temporary Water Filled Barrier	73
730 Wood Sign Support	75
780 Pavement Striping	76
816 Unit Duct	81
836 Pole Foundation	82
860 Master Controller	83
1001 Cement	84
1003 Fine Aggregates	85
1004 Coarse Aggregates	87
1006 Metals	91
1011 Mineral Filler	93
1017 Packaged, Dry, Combined Materials for Mortar	94
1018 Packaged Rapid Hardening Mortar or Concrete	95
1019 Controlled Low-Strength Material (CLSM)	96
1020 Portland Cement Concrete	97
1024 Grout and Nonshrink Grout	136
1030 Hot-Mix Asphalt	137
1040 Drain Pipe, Tile, Drainage Mat, and Wall Drain	142
1042 Precast Concrete Products	143
1069 Pole and Tower	144
1070 Foundation and Breakaway Devices	145
1073 Controller	146
1081 Materials for Planting	147
1082 Preformed Bearing Pads	148
1083 Elastomeric Bearings	149
1088 Wireway and Conduit System	150
1095 Pavement Markings	152
1101 General Equipment	155
1102 Hot-Mix Asphalt Equipment	157
1103 Portland Cement Concrete Equipment	159
1105 Pavement Marking Equipment	160
1106 Work Zone Traffic Control Devices	161

RECURRING SPECIAL PROVISIONS

The following RECURRING SPECIAL PROVISIONS indicated by an "X" are applicable to this contract and are included by reference:

<u>CHECK SHEET #</u>	<u>PAGE NO.</u>
1 X Additional State Requirements for Federal-Aid Construction Contracts	163
2 X Subletting of Contracts (Federal-Aid Contracts)	166
3 X EEO	167
4 Specific EEO Responsibilities Non Federal-Aid Contracts	177
5 Required Provisions - State Contracts	182
6 Asbestos Bearing Pad Removal	188
7 Asbestos Waterproofing Membrane and Asbestos HMA Surface Removal	189
8 Temporary Stream Crossings and In-Stream Work Pads	190
9 Construction Layout Stakes Except for Bridges	191
10 Construction Layout Stakes	194
11 Use of Geotextile Fabric for Railroad Crossing	197
12 Subsealing of Concrete Pavements	199
13 Hot-Mix Asphalt Surface Correction	203
14 Pavement and Shoulder Resurfacing	205
15 Reserved	206
16 Patching with Hot-Mix Asphalt Overlay Removal	207
17 Polymer Concrete	208
18 PVC Pipeliner	210
19 Pipe Underdrains	211
20 Guardrail and Barrier Wall Delineation	212
21 Bicycle Racks	216
22 Reserved	218
23 Temporary Portable Bridge Traffic Signals	219
24 Work Zone Public Information Signs	221
25 Nighttime Inspection of Roadway Lighting	222
26 English Substitution of Metric Bolts	223
27 English Substitution of Metric Reinforcement Bars	224
28 Calcium Chloride Accelerator for Portland Cement Concrete	225
29 Reserved	226
30 Quality Control of Concrete Mixtures at the Plant	227
31 Quality Control/Quality Assurance of Concrete Mixtures	235
32 Digital Terrain Modeling for Earthwork Calculations	251
33 Pavement Marking Removal	253
34 Preventive Maintenance – Bituminous Surface Treatment	254
35 Preventive Maintenance – Cape Seal	260
36 Preventive Maintenance – Micro-Surfacing	275
37 Preventive Maintenance – Slurry Seal	286
38 Temporary Raised Pavement Markers	296
39 Restoring Bridge Approach Pavements Using High-Density Foam	297

LOCAL ROADS AND STREETS RECURRING SPECIAL PROVISIONS

The following LOCAL ROADS AND STREETS RECURRING SPECIAL PROVISIONS indicated by an "X" are applicable to this contract and are included by reference:

Table of Contents

<u>CHECK SHEET #</u>		<u>PAGE NO.</u>
LRS 1	Reserved	301
LRS 2	<input type="checkbox"/> Furnished Excavation	302
LRS 3	<input checked="" type="checkbox"/> Work Zone Traffic Control Surveillance	303
LRS 4	<input checked="" type="checkbox"/> Flaggers in Work Zones	304
LRS 5	<input type="checkbox"/> Contract Claims	305
LRS 6	<input type="checkbox"/> Bidding Requirements and Conditions for Contract Proposals	306
LRS 7	<input type="checkbox"/> Bidding Requirements and Conditions for Material Proposals	312
LRS 8	Reserved	318
LRS 9	<input type="checkbox"/> Bituminous Surface Treatments	319
LRS 10	Reserved	320
LRS 11	<input type="checkbox"/> Employment Practices	321
LRS 12	<input type="checkbox"/> Wages of Employees on Public Works	323
LRS 13	<input type="checkbox"/> Selection of Labor	325
LRS 14	<input type="checkbox"/> Paving Brick and Concrete Paver Pavements and Sidewalks	326
LRS 15	<input type="checkbox"/> Partial Payments	329
LRS 16	<input type="checkbox"/> Protests on Local Lettings	330
LRS 17	<input type="checkbox"/> Substance Abuse Prevention Program.....	331
LRS 18	<input type="checkbox"/> Multigrade Cold Mix Asphalt	332

STARK COUNTY

SECTION 13-00167-00-PP

CONTRACT 89667

INDEX OF SPECIAL PROVISIONS

PAGE	TITLE
1	SCOPE OF WORK
1	NOTICE TO BIDDER
1	START DATES, INTERIM COMPLETION DATE, FINAL COMPLETION DATE
1	TRAFFIC CONTROL
1	PREPARATION OF EXISTING SURFACES
1-2	BITUMINOUS MATERIAL (SEAL COAT)
2	SEAL COAT AGGREGATE (FURNISH TO STOCKPILE, LOAD, AND APPLY)
2	ROAD CLOSURES
2	SEQUENCE OF WORK

INDEX LOCAL ROADS AND STREETS SPECIAL PROVISIONS

<u>LR #</u>	<u>Pg #</u>	<u>Special Provision Title</u>	<u>Effective</u>	<u>Revised</u>
LR SD12		<input type="checkbox"/> Slab Movement Detection Device	Nov. 11, 1984	Jan. 1, 2007
LR SD13		<input type="checkbox"/> Required Cold Milled Surface Texture	Nov. 1, 1987	Jan. 1, 2007
LR 107-2		<input type="checkbox"/> Railroad Protective Liability Insurance for Local Lettings	Mar. 1, 2005	Jan. 1, 2006
LR 107-4	3	<input checked="" type="checkbox"/> Insurance	Feb. 1, 2007	Aug. 1, 2007
LR 108		<input type="checkbox"/> Combination Bids	Jan. 1, 1994	Mar. 1, 2005
LR 109		<input type="checkbox"/> Equipment Rental Rates	Jan. 1, 2012	
LR 212		<input type="checkbox"/> Shaping Roadway	Aug. 1, 1969	Jan. 1, 2002
LR 355-1		<input type="checkbox"/> Bituminous Stabilized Base Course, Road Mix or Traveling Plant Mix	Oct. 1, 1973	Jan. 1, 2007
LR 355-2		<input type="checkbox"/> Bituminous Stabilized Base Course, Plant Mix	Feb. 20, 1963	Jan. 1, 2007
LR 400-1		<input type="checkbox"/> Bituminous Treated Earth Surface	Jan. 1, 2007	Apr. 1, 2012
LR 400-2		<input type="checkbox"/> Bituminous Surface Plant Mix (Class B)	Jan. 1, 2008	
LR 400-3		<input type="checkbox"/> Hot In-Place Recycling (HIR) – Surface Recycling	Jan. 1, 2012	
LR 400-4		<input type="checkbox"/> Full-Depth Reclamation (FDR) with Emulsified Asphalt	Apr. 1, 2012	Jun. 1, 2012
LR 400-5		<input type="checkbox"/> Cold In-Place Recycling (CIR) With Emulsified Asphalt	Apr. 1, 2012	Jun. 1, 2012
LR 400-6		<input type="checkbox"/> Cold In Place Recycling (CIR) with Foamed Asphalt	June 1, 2012	
LR 400-7		<input type="checkbox"/> Full-Depth Reclamation (FDR) with Foamed Asphalt	June 1, 2012	
LR 402		<input type="checkbox"/> Salt Stabilized Surface Course	Feb. 20, 1963	Jan. 1, 2007
LR 403-1		<input type="checkbox"/> Surface Profile Milling of Existing, Recycled or Reclaimed Flexible Pavement	Apr. 1, 2012	Jun. 1, 2012
LR 403-2		<input type="checkbox"/> Bituminous Hot Mix Sand Seal Coat	Aug. 1, 1969	Jan. 1, 2007
LR 406		<input type="checkbox"/> Filling HMA Core Holes with Non-shrink Grout	Jan. 1, 2008	
LR 420		<input type="checkbox"/> PCC Pavement (Special)	May 12, 1964	Jan. 2, 2007
LR 442		<input type="checkbox"/> Bituminous Patching Mixtures for Maintenance Use	Jan. 1, 2004	Jun. 1, 2007
LR 451		<input type="checkbox"/> Crack Filling Bituminous Pavement with Fiber-Asphalt	Oct. 1, 1991	Jan. 1, 2007
LR 503-1		<input type="checkbox"/> Furnishing Class SI Concrete	Oct. 1, 1973	Jan. 1, 2002
LR 503-2		<input type="checkbox"/> Furnishing Class SI Concrete (Short Load)	Jan. 1, 1989	Jan. 1, 2002
LR 542		<input type="checkbox"/> Pipe Culverts, Type _____ (Furnished)	Sep. 1, 1964	Jan. 1, 2007
LR 663		<input type="checkbox"/> Calcium Chloride Applied	Jun. 1, 1958	Jan. 1, 2007
LR 702		<input type="checkbox"/> Construction and Maintenance Signs	Jan. 1, 2004	Jun. 1, 2007
LR 1000-1		<input type="checkbox"/> Cold In-Place Recycling (CIR) and Full Depth Reclamation (FDR) with Emulsified Asphalt Mix Design Procedures	Apr. 1, 2012	Jun. 1, 2012
LR 1000-2		<input type="checkbox"/> Cold In-Place Recycling (CIR) and Full Depth Reclamation (FDR) with Foamed Asphalt Mix Design Procedures	June 1, 2012	
LR 1004		<input type="checkbox"/> Coarse Aggregate for Bituminous Surface Treatment	Jan. 1, 2002	Jan. 1, 2007
LR 1030		<input type="checkbox"/> Growth Curve	Mar. 1, 2008	Jan. 1, 2010
LR 1032-1		<input type="checkbox"/> Emulsified Asphalts	Jan. 1, 2007	Feb. 7, 2008
LR 1102		<input type="checkbox"/> Road Mix or Traveling Plan Mix Equipment	Jan. 1, 2007	

BDE SPECIAL PROVISIONS

The following special provisions indicated by an "x" are applicable to this contract. An * indicates a new or revised special provision for the letting.

<u>File Name</u>	<u>Pg.</u>	<u>Special Provision Title</u>	<u>Effective</u>	<u>Revised</u>
80240		Above Grade Inlet Protection	July 1, 2009	Jan. 1, 2012
80099		Accessible Pedestrian Signals (APS)	April 1, 2003	Jan. 1, 2014
* 80274		Aggregate Subgrade Improvement	April 1, 2012	Jan. 1, 2016
80192		Automated Flagger Assistance Device	Jan. 1, 2008	
80173		Bituminous Materials Cost Adjustments	Nov. 2, 2006	July 1, 2015
80241		Bridge Demolition Debris	July 1, 2009	
50261		Building Removal-Case I (Non-Friable and Friable Asbestos)	Sept. 1, 1990	April 1, 2010
50481		Building Removal-Case II (Non-Friable Asbestos)	Sept. 1, 1990	April 1, 2010
50491		Building Removal-Case III (Friable Asbestos)	Sept. 1, 1990	April 1, 2010
50531		Building Removal-Case IV (No Asbestos)	Sept. 1, 1990	April 1, 2010
80360		Coarse Aggregate Quality	July 1, 2015	
80310		Coated Galvanized Steel Conduit	Jan. 1, 2013	Jan. 1, 2015
80341		Coilable Nonmetallic Conduit	Aug. 1, 2014	Jan. 1, 2015
80198		Completion Date (via calendar days)	April 1, 2008	
80199		Completion Date (via calendar days) Plus Working Days	April 1, 2008	
80293		Concrete Box Culverts with Skews > 30 Degrees and Design Fills ≤ 5 Feet	April 1, 2012	April 1, 2015
80294		Concrete Box Culverts with Skews ≤ 30 Degrees Regardless of Design Fill and Skews > 30 Degrees with Design Fills > 5 Feet	April 1, 2012	April 1, 2014
80311		Concrete End Sections for Pipe Culverts	Jan. 1, 2013	
80334		Concrete Gutter, Curb, Median, and Paved Ditch	April 1, 2014	Aug. 1, 2014
80277		Concrete Mix Design – Department Provided	Jan. 1, 2012	Jan. 1, 2014
80261		Construction Air Quality – Diesel Retrofit	June 1, 2010	Nov. 1, 2014
80335	4	X Contract Claims	April 1, 2014	
* 80029	5	X Disadvantaged Business Enterprise Participation	Sept. 1, 2000	Jan. 2, 2016
80358	16	X Equal Employment Opportunity	April 1, 2015	
80265		Friction Aggregate	Jan. 1, 2011	Nov. 1, 2014
80229		Fuel Cost Adjustment	April 1, 2009	July 1, 2015
80329		Glare Screen	Jan. 1, 2014	
80304		Grooving for Recessed Pavement Markings	Nov. 1, 2012	Aug. 1, 2014
80246		Hot-Mix Asphalt – Density Testing of Longitudinal Joints	Jan. 1, 2010	April 1, 2012
80322		Hot-Mix Asphalt – Mixture Design Composition and Volumetric Requirements	Nov. 1, 2013	Nov. 1, 2014
80323		Hot-Mix Asphalt – Mixture Design Verification and Production	Nov. 1, 2013	Nov. 1, 2014
80347		Hot-Mix Asphalt – Pay for Performance Using Percent Within Limits – Jobsite Sampling	Nov. 1, 2014	July 1, 2015
80348		Hot-Mix Asphalt – Prime Coat	Nov. 1, 2014	
80315		Insertion Lining of Culverts	Jan. 1, 2013	Nov. 1, 2013
80351		Light Tower	Jan. 1, 2015	
80336		Longitudinal Joint and Crack Patching	April 1, 2014	
80324		LRFD Pipe Culvert Burial Tables	Nov. 1, 2013	April 1, 2015
80325		LRFD Storm Sewer Burial Tables	Nov. 1, 2013	April 1, 2015
80045		Material Transfer Device	June 15, 1999	Aug. 1, 2014
80342		Mechanical Side Tie Bar Inserter	Aug. 1, 2014	Jan. 1, 2015
80165		Moisture Cured Urethane Paint System	Nov. 1, 2006	Jan. 1, 2010
80361		Overhead Sign Structures Certification of Metal Fabricator	Nov. 1, 2015	
80337		Paved Shoulder Removal	April 1, 2014	
80349		Pavement Marking Blackout Tape	Nov. 1, 2014	
80298		Pavement Marking Tape Type IV	April 1, 2012	
80254		Pavement Patching	Jan. 1, 2010	

<u>File Name</u>	<u>Pg.</u>		<u>Special Provision Title</u>	<u>Effective</u>	<u>Revised</u>
80352	20	X	Pavement Striping - Symbols	Jan. 1, 2015	
80359			Portland Cement Concrete Bridge Deck Curing	April 1, 2015	
80353			Portland Cement Concrete Inlay or Overlay	Jan. 1, 2015	April 1, 2015
80338			Portland Cement Concrete Partial Depth Hot-Mix Asphalt Patching	April 1, 2014	
80343			Precast Concrete Handhole	Aug. 1, 2014	
80300			Preformed Plastic Pavement Marking Type D - Inlaid	April 1, 2012	
80328	21	X	Progress Payments	Nov. 2, 2013	
34261			Railroad Protective Liability Insurance	Dec. 1, 1986	Jan. 1, 2006
80157			Railroad Protective Liability Insurance (5 and 10)	Jan. 1, 2006	
80306			Reclaimed Asphalt Pavement (RAP) and Reclaimed Asphalt Shingles (RAS)	Nov. 1, 2012	Jan. 2, 2015
80350			Retroreflective Sheeting for Highway Signs	Nov. 1, 2014	
80327			Reinforcement Bars	Nov. 1, 2013	
80344			Rigid Metal Conduit	Aug. 1, 2014	
80354			Sidewalk, Corner, or Crosswalk Closure	Jan. 1, 2015	April 1, 2015
80340			Speed Display Trailer	April 2, 2014	
80127			Steel Cost Adjustment	April 2, 2004	July 1, 2015
* 80362			Steel Slag in Trench Backfill	Jan. 1, 2016	
80317			Surface Testing of Hot-Mix Asphalt Overlays	Jan. 1, 2013	
80355			Temporary Concrete Barrier	Jan. 1, 2015	July 1, 2015
80301			Tracking the Use of Pesticides	Aug. 1, 2012	
80356			Traffic Barrier Terminals Type 6 or 6B	Jan. 1, 2015	
20338			Training Special Provisions	Oct. 15, 1975	
80318			Traversable Pipe Grate	Jan. 1, 2013	April 1, 2014
80345			Underpass Luminaire	Aug. 1, 2014	April 1, 2015
80357			Urban Half Road Closure with Mountable Median	Jan. 1, 2015	July 1, 2015
80346			Waterway Obstruction Warning Luminaire	Aug. 1, 2014	April 1, 2015
80288			Warm Mix Asphalt	Jan. 1, 2012	Nov. 1, 2014
80302	22	X	Weekly DBE Trucking Reports	June 2, 2012	April 2, 2015
80289			Wet Reflective Thermoplastic Pavement Marking	Jan. 1, 2012	
80071			Working Days	Jan. 1, 2002	

The following special provisions are in the 2015 Supplemental Specifications and Recurring Special Provisions:

<u>File Name</u>	<u>Special Provision Title</u>	<u>New Location</u>	<u>Effective</u>	<u>Revised</u>
80292	Coarse Aggregate in Bridge Approach Slabs/Footings	Articles 1004.01(b) and 1004.02(f)	April 1, 2012	April 1, 2013
80303	Granular Materials	Articles 1003.04, 1003.04(c), and 1004.05(c)	Nov. 1, 2012	
80330	Pavement Marking for Bike Symbol	Article 780.14	Jan. 1, 2014	
80331	Payrolls and Payroll Records	Recurring CS #1 and #5	Jan. 1, 2014	
80332	Portland Cement Concrete – Curing of Abutments and Piers	Article 1020.13	Jan. 1, 2014	
80326	Portland Cement Concrete Equipment	Article 1103.03(a)(5)	Nov. 1, 2013	
80281	Quality Control/Quality Assurance of Concrete Mixtures	Recurring CS #31	Jan. 1, 2012	Jan. 1, 2014
80283	Removal and Disposal of Regulated Substances	Articles 669.01, 669.08, 669.09, 669.14, and 669.16	Jan. 1, 2012	Nov. 2, 2012
80319	Removal and Disposal of Surplus Materials	Article 202.03	Nov. 2, 2012	
80307	Seeding	Article 250.07	Nov. 1, 2012	
80339	Stabilized Subbase	Article 312.06	April 1, 2014	
80333	Traffic Control Setup and Removal Freeway/Expressway	Articles 701.18(l) and 701.19(a)	Jan. 1, 2014	

The following special provisions require additional information from the designer. The additional information needs to be included in a separate document attached to this check sheet. The Project Development and Implementation section will then include the information in the applicable special provision. The Special Provisions are:

- Bridge Demolition Debris
- Building Removal-Case I
- Building Removal-Case II
- Building Removal-Case III
- Building Removal-Case IV
- Completion Date
- Completion Date Plus Working Days
- DBE Participation
- Material Transfer Device
- Railroad Protective Liability Insurance
- Training Special Provisions
- Working Days



The following Special Provisions supplement the "Standard Specifications for Road and Bridge Construction", January 1, 2014, the latest edition of the "Manual on Uniform Traffic Control Devices and Highways", and the "Manual of Test Procedures of Materials" in effect on the date of invitation of bids, and the Supplemental Specifications and Recurring Special Provisions indicated on the Check Sheet included here in and govern the construction of Section 13-00167-00-PP, and in case of conflict with any part, or parts, of said Specifications, the said Special Provisions shall take precedence and shall govern.

SCOPE OF WORK

This work shall consist of constructing a single (A-1) bituminous surface treatment over existing oil & chip surfaces on various County Highways in Stark County.

NOTICE TO BIDDER

Prequalification is REQUIRED for this project.

START DATES, INTERM COMPLETION DATE, FINAL COMPLETION DATE

No work may begin until June 20, 2016. All sealcoating work specified under this contract (WITH THE EXCEPTION OF PAVEMENT MARKING WORK) shall be completed on or before July 22, 2016.

No pavement marking work may begin until September 19, 2016. All pavement marking work shall be completed on or before October 14, 2016.

TRAFFIC CONTROL

Traffic Control shall be in accordance with the applicable sections of the Standard Specifications for Road and Bridge Construction, the applicable guidelines contained in the Manual of Uniform Traffic Control Devices for Streets and Highways, these special provisions and any special details and Highway Standards contained herein and in the plans.

The following Highway Standards will apply as directed by the Engineer:

701901, BLR 18-5, BLR 22-6

Basis of Payment. This work shall not be paid for separately but shall be included in the contract unit prices bid for the various items.

PREPARATION OF EXISTING BITUMINOUS SURFACES

This work shall be done in accordance with Section 358 of the Standard Specifications except as stated herein: No bituminous material shall be applied until the preparation of the existing surface has been approved by the Engineer.

Basis of Payment. This work shall not be paid for separately but shall be included in the contract unit prices bid for the various items.

BITUMINOUS MATERIAL (SEAL COAT)

This work shall be done in accordance with Section 403 of the Standard Specifications except as stated herein.

Materials. The bituminous material used for seal coat shall be **PG 52-28**.

Application. The pressure distributor shall cover the entire width of the roadway in one pass. The total width of spray shall be no wider than the existing surface unless otherwise directed by the Engineer. A deduction shall be made for excessive over spraying of the bituminous seal coat as determined by the Engineer. The bituminous material shall be applied at the following rates or as directed by the Engineer.

Existing surface	Rate of Application
Hot Mix Asphalt	0.32 gal / Sq Yd
Bituminous seal coat	0.32 gal / Sq Yd

General. Bituminous material shall not be spread until the distributor has been tested to assure a uniform distribution of material by the Engineer. The length of spread from the chipper to distributor shall not be greater than can be covered with aggregate within one (1) minute after the bituminous material has been spread.

Daily Quantities. The Contractor shall provide the Engineer with quantities of material used for each section of roadway (as specified on the plans) and at the end of each day.

Basis of Payment. This work shall be paid at the contract unit price per GALLON for BITUMINOUS MATERIAL (SEAL COAT).

SEAL COAT AGGREGATE (Furnish to Stockpile, Load & Apply)

This work shall be done in accordance with Section 403 of the Standard Specifications and as stated herein.

Materials. The seal coat aggregate gradation shall be FA-4 (1/4 chips) or CA-16 (3/8 chips) and shall be furnished to the secured stockpile locations identified in the plans, and then loaded, and applied to the roadway from the secured stockpile locations. The stockpile locations can only be accessed upon direction by the Engineer. The Engineer, or representative, shall be present during all aggregate delivery and loading operations. At the end of each working day, the Engineer, or representative, shall re-secure the stockpile site. The aggregate shall be furnished, stockpiled, loaded, hauled, and applied to the roadway by the Contractor in accordance with the specifications stated herein.

Application. The material shall be applied to the roadway at a rate of 23 lbs per square yard or as directed by the Engineer. The aggregate spreader shall cover the entire width of the roadway in one pass.

Equipment. Two (2) separate pneumatic-tired rollers meeting the requirements of Section 1101.01 shall be required. A broom will be required to sweep the roadway upon completion of the work as stated in the Standard Specifications, and as directed by the Engineer.

Daily Quantities. The Contractor shall provide the Engineer with quantities of material used for each section of roadway (as specified on the plans) and at the end of each day.

Basis of Payment. This work shall be paid at the contract unit price per TON for SEAL COAT AGGREGATE (Furnish, Load & Apply).

ROAD CLOSURE

The Contractor shall provide notification to any agencies affected by road closures no less than 24 hours prior to the closure. Notification consists of informing the agency when the closure is to occur and notifying them when it is completed. These agencies include, but are not limited to, the following:

U.S. POSTAL SERVICES, SCHOOL DISTRICTS, AMBULANCE, STATE POLICE, FIRE DISTRICTS, & STARK COUNTY SHERIFF'S DEPARTMENT (309) 286-2541

SEQUENCE OF WORK

The Contractor shall schedule a meeting with the County Engineer at least one week prior to starting work to provide the sequence of operations.

State of Illinois
Department of Transportation
Bureau of Local Roads and Streets

SPECIAL PROVISION
FOR
INSURANCE

Effective: February 1, 2007
Revised: August 1, 2007

All references to Sections or Articles in this specification shall be construed to mean specific Section or Article of the Standard Specifications for Road and Bridge Construction, adopted by the Department of Transportation.

The Contractor shall name the following entities as additional insured under the Contractor's general liability insurance policy in accordance with Article 107.27:

Stark County Highway Department

The entities listed above and their officers, employees, and agents shall be indemnified and held harmless in accordance with Article 107.26.

CONTRACT CLAIMS (BDE)

Effective: April 1, 2014

Revise the first paragraph of Article 109.09(a) of the Standard Specifications to read:

“(a) Submission of Claim. All claims filed by the Contractor shall be in writing and in sufficient detail to enable the Department to ascertain the basis and amount of the claim. As a minimum, the following information must accompany each claim submitted.”

Revise Article 109.09(e) of the Standard Specifications to read:

“(e) Procedure. The Department provides two administrative levels for claims review.

Level I Engineer of Construction

Level II Chief Engineer/Director of Highways or Designee

- (1) Level I. All claims shall first be submitted at Level I. Two copies each of the claim and supporting documentation shall be submitted simultaneously to the District and the Engineer of Construction. The Engineer of Construction, in consultation with the District, will consider all information submitted with the claim and render a decision on the claim within 90 days after receipt by the Engineer of Construction. Claims not conforming to this Article will be returned without consideration. The Engineer of Construction may schedule a claim presentation meeting if in the Engineer of Construction's judgment such a meeting would aid in resolution of the claim, otherwise a decision will be made based on the claim documentation submitted. If a Level I decision is not rendered within 90 days of receipt of the claim, or if the Contractor disputes the decision, an appeal to Level II may be made by the Contractor.
- (2) Level II. An appeal to Level II shall be made in writing to the Engineer of Construction within 45 days after the date of the Level I decision. Review of the claim at Level II shall be conducted as a full evaluation of the claim. A claim presentation meeting may be scheduled if the Chief Engineer/Director of Highways determines that such a meeting would aid in resolution of the claim, otherwise a decision will be made based on the claim documentation submitted. A Level II final decision will be rendered within 90 days of receipt of the written request for appeal.

Full compliance by the Contractor with the provisions specified in this Article is a contractual condition precedent to the Contractor's right to seek relief in the Court of Claims. The Director's written decision shall be the final administrative action of the Department. Unless the Contractor files a claim for adjudication by the Court of Claims within 60 days after the date of the written decision, the failure to file shall constitute a release and waiver of the claim.”

80335

DISADVANTAGED BUSINESS ENTERPRISE PARTICIPATION (BDE)

Effective: September 1, 2000

Revised: January 2, 2016

FEDERAL OBLIGATION. The Department of Transportation, as a recipient of federal financial assistance, is required to take all necessary and reasonable steps to ensure nondiscrimination in the award and administration of contracts. Consequently, the federal regulatory provisions of 49 CFR Part 26 apply to this contract concerning the utilization of disadvantaged business enterprises. For the purposes of this Special Provision, a disadvantaged business enterprise (DBE) means a business certified by the Department in accordance with the requirements of 49 CFR Part 26 and listed in the Illinois Unified Certification Program (IL UCP) DBE Directory.

STATE OBLIGATION. This Special Provision will also be used by the Department to satisfy the requirements of the Business Enterprise for Minorities, Females, and Persons with Disabilities Act, 30 ILCS 575. When this Special Provision is used to satisfy state law requirements on 100 percent state-funded contracts, the federal government has no involvement in such contracts (not a federal-aid contract) and no responsibility to oversee the implementation of this Special Provision by the Department on those contracts. DBE participation on 100 percent state-funded contracts will not be credited toward fulfilling the Department's annual overall DBE goal required by the US Department of Transportation to comply with the federal DBE program requirements.

CONTRACTOR ASSURANCE. The Contractor makes the following assurance and agrees to include the assurance in each subcontract that the Contractor signs with a subcontractor.

The Contractor, subrecipient, or subcontractor shall not discriminate on the basis of race, color, national origin, or sex in the performance of this contract. The Contractor shall carry out applicable requirements of 49 CFR Part 26 in the award and administration of contracts funded in whole or in part with federal or state funds. Failure by the Contractor to carry out these requirements is a material breach of this contract, which may result in the termination of this contract or such other remedy as the recipient deems appropriate, which may include, but is not limited to:

- (a) Withholding progress payments;
- (b) Assessing sanctions;
- (c) Liquidated damages; and/or
- (d) Disqualifying the Contractor from future bidding as non-responsible.

OVERALL GOAL SET FOR THE DEPARTMENT. As a requirement of compliance with 49 CFR Part 26, the Department has set an overall goal for DBE participation in its federally assisted contracts. That goal applies to all federal-aid funds the Department will expend in its federally assisted contracts for the subject reporting fiscal year. The Department is required to make a

good faith effort to achieve the overall goal. The dollar amount paid to all approved DBE companies performing work called for in this contract is eligible to be credited toward fulfillment of the Department's overall goal.

CONTRACT GOAL TO BE ACHIEVED BY THE CONTRACTOR. This contract includes a specific DBE utilization goal established by the Department. The goal has been included because the Department has determined that the work of this contract has subcontracting opportunities that may be suitable for performance by DBE companies. The determination is based on an assessment of the type of work, the location of the work, and the availability of DBE companies to do a part of the work. The assessment indicates that, in the absence of unlawful discrimination, and in an arena of fair and open competition, DBE companies can be expected to perform 0.00 % of the work. This percentage is set as the DBE participation goal for this contract. Consequently, in addition to the other award criteria established for this contract, the Department will only award this contract to a bidder who makes a good faith effort to meet this goal of DBE participation in the performance of the work. A bidder makes a good faith effort for award consideration if either of the following is done in accordance with the procedures set for in this Special Provision:

- (a) The bidder documents that enough DBE participation has been obtained to meet the goal or,
- (b) The bidder documents that a good faith effort has been made to meet the goal, even though the effort did not succeed in obtaining enough DBE participation to meet the goal.

DBE LOCATOR REFERENCES. Bidders shall consult the IL UCP DBE Directory as a reference source for DBE-certified companies. In addition, the Department maintains a letting and item specific DBE locator information system whereby DBE companies can register their interest in providing quotes on particular bid items advertised for letting. Information concerning DBE companies willing to quote work for particular contracts may be obtained by contacting the Department's Bureau of Small Business Enterprises at telephone number (217) 785-4611, or by visiting the Department's website at:

<http://www.idot.illinois.gov/doing-business/certifications/disadvantaged-business-enterprise-certification/il-ucp-directory/index>.

BIDDING PROCEDURES. Compliance with this Special Provision is required prior to the award of the contract and the failure of the low bidder to comply will render the bid not responsive.

In order to assure the timely award of the contract, the low bidder shall submit:

- (a) The bidder shall submit a Disadvantaged Business Utilization Plan on completed Department forms SBE 2025 and 2026.
 - (1) The final Utilization Plan must be submitted within five calendar days after the date of the letting.

- (2) To meet the five day requirement, the bidder may send the Utilization Plan electronically by scanning and sending to DOT.DBE.UP@illinois.gov or faxing to (217) 785-1524. The subject line must include the bid Item Number and the Letting date. The Utilization Plan should be sent as one .pdf file, rather than multiple files and emails for the same Item Number. It is the responsibility of the bidder to obtain confirmation of email or fax delivery.

Alternatively, the Utilization Plan may be sent by certified mail or delivery service within the five calendar day period. If a question arises concerning the mailing date of a Utilization Plan, the mailing date will be established by the U.S. Postal Service postmark on the original certified mail receipt from the U.S. Postal Service or the receipt issued by a delivery service. It is the responsibility of the bidder to ensure the postmark or receipt date is affixed within the five days if the bidder intends to rely upon mailing or delivery to satisfy the submission day requirement. The Utilization Plan is to be submitted to:

Illinois Department of Transportation
Bureau of Small Business Enterprises
Contract Compliance Section
2300 South Dirksen Parkway, Room 319
Springfield, Illinois 62764

The Department will not accept a Utilization Plan if it does not meet the five day submittal requirement and the bid will be declared not responsive. In the event the bid is declared not responsive due to a failure to submit a Utilization Plan or failure to comply with the bidding procedures set forth herein, the Department may elect to cause the forfeiture of the penal sum of the bidder's proposal guaranty, and may deny authorization to bid the project if re-advertised for bids. The Department reserves the right to invite any other bidder to submit a Utilization Plan at any time for award consideration or to extend the time for award.

- (b) The Utilization Plan shall indicate that the bidder either has obtained sufficient DBE participation commitments to meet the contract goal or has not obtained enough DBE participation commitments in spite of a good faith effort to meet the goal. The Utilization Plan shall further provide the name, telephone number, and telefax number of a responsible official of the bidder designated for purposes of notification of Utilization Plan approval or disapproval under the procedures of this Special Provision.
- (c) The Utilization Plan shall include a DBE Participation Commitment Statement, Department form SBE 2025, for each DBE proposed for the performance of work to achieve the contract goal. For bidding purposes, submission of the completed SBE 2025 forms, signed by the DBEs and scanned or faxed to the bidder will be acceptable as long as the original is available and provided upon request. All elements of information indicated on the said form shall be provided, including but not limited to the following:

- (1) The names and addresses of DBE firms that will participate in the contract;
- (2) A description, including pay item numbers, of the work each DBE will perform;
- (3) The dollar amount of the participation of each DBE firm participating. The dollar amount of participation for identified work shall specifically state the quantity, unit price, and total subcontract price for the work to be completed by the DBE. If partial pay items are to be performed by the DBE, indicate the portion of each item, a unit price where appropriate and the subcontract price amount;
- (4) DBE Participation Commitment Statements, form SBE 2025, signed by the bidder and each participating DBE firm documenting the commitment to use the DBE subcontractors whose participation is submitted to meet the contract goal;
- (5) If the bidder is a joint venture comprised of DBE companies and non-DBE companies, the Utilization Plan must also include a clear identification of the portion of the work to be performed by the DBE partner(s); and,
- (6) If the contract goal is not met, evidence of good faith efforts; the documentation of good faith efforts must include copies of each DBE and non-DBE subcontractor quote submitted to the bidder when a non-DBE subcontractor is selected over a DBE for work on the contract.

GOOD FAITH EFFORT PROCEDURES. The contract will not be awarded until the Utilization Plan submitted by the apparent successful bidder is approved. All information submitted by the bidder must be complete, accurate and adequately document that enough DBE participation has been obtained or document that good faith efforts of the bidder, in the event enough DBE participation has not been obtained, before the Department will commit to the performance of the contract by the bidder. The Utilization Plan will be approved by the Department if the Utilization Plan documents sufficient commercially useful DBE work to meet the contract goal or the bidder submits sufficient documentation of a good faith effort to meet the contract goal pursuant to 49 CFR Part 26, Appendix A. The Utilization Plan will not be approved by the Department if the Utilization Plan does not document sufficient DBE participation to meet the contract goal unless the apparent successful bidder documented in the Utilization Plan that it made a good faith effort to meet the goal. This means that the bidder must show that all necessary and reasonable steps were taken to achieve the contract goal. Necessary and reasonable steps are those which, by their scope, intensity and appropriateness to the objective, could reasonably be expected to obtain sufficient DBE participation, even if they were not successful. The Department will consider the quality, quantity, and intensity of the kinds of efforts that the bidder has made. Mere *pro forma* efforts, in other words, efforts done as a matter of form, are not good faith efforts; rather, the bidder is expected to have taken genuine efforts that would be reasonably expected of a bidder actively and aggressively trying to obtain DBE participation sufficient to meet the contract goal.

- (a) The following is a list of types of action that the Department will consider as part of the evaluation of the bidder's good faith efforts to obtain participation. These listed factors

are not intended to be a mandatory checklist and are not intended to be exhaustive. Other factors or efforts brought to the attention of the Department may be relevant in appropriate cases, and will be considered by the Department.

- (1) Soliciting through all reasonable and available means (e.g. attendance at pre-bid meetings, advertising and/or written notices) the interest of all certified DBE companies that have the capability to perform the work of the contract. The bidder must solicit this interest within sufficient time to allow the DBE companies to respond to the solicitation. The bidder must determine with certainty if the DBE companies are interested by taking appropriate steps to follow up initial solicitations.
- (2) Selecting portions of the work to be performed by DBE companies in order to increase the likelihood that the DBE goals will be achieved. This includes, where appropriate, breaking out contract work items into economically feasible units to facilitate DBE participation, even when the prime Contractor might otherwise prefer to perform these work items with its own forces.
- (3) Providing interested DBE companies with adequate information about the plans, specifications, and requirements of the contract in a timely manner to assist them in responding to a solicitation.
- (4) a. Negotiating in good faith with interested DBE companies. It is the bidder's responsibility to make a portion of the work available to DBE subcontractors and suppliers and to select those portions of the work or material needs consistent with the available DBE subcontractors and suppliers, so as to facilitate DBE participation. Evidence of such negotiation includes the names, addresses, and telephone numbers of DBE companies that were considered; a description of the information provided regarding the plans and specifications for the work selected for subcontracting; and evidence as to why additional agreements could not be reached for DBE companies to perform the work.
 - b. A bidder using good business judgment would consider a number of factors in negotiating with subcontractors, including DBE subcontractors, and would take a firm's price and capabilities as well as contract goals into consideration. However, the fact that there may be some additional costs involved in finding and using DBE companies is not in itself sufficient reason for a bidder's failure to meet the contract DBE goal, as long as such costs are reasonable. Also the ability or desire of a bidder to perform the work of a contract with its own organization does not relieve the bidder of the responsibility to make good faith efforts. Bidders are not, however, required to accept higher quotes from DBE companies if the price difference is excessive or unreasonable. In accordance with subsection (c)(6) of the above Bidding Procedures, the documentation of good faith efforts must include copies of each DBE and non-DBE subcontractor quote submitted to the bidder when a non-DBE subcontractor was selected over a DBE for work on the contract.

- (5) Not rejecting DBE companies as being unqualified without sound reasons based on a thorough investigation of their capabilities. The bidder's standing within its industry, membership in specific groups, organizations, or associations and political or social affiliations (for example union vs. non-union employee status) are not legitimate causes for the rejection or non-solicitation of bids in the bidder's efforts to meet the project goal.
 - (6) Making efforts to assist interested DBE companies in obtaining bonding, lines of credit, or insurance as required by the recipient or Contractor.
 - (7) Making efforts to assist interested DBE companies in obtaining necessary equipment, supplies, materials, or related assistance or services.
 - (8) Effectively using the services of available minority/women community organizations; minority/women contractors' groups; local, state, and federal minority/women business assistance offices; and other organizations as allowed on a case-by-case basis to provide assistance in the recruitment and placement of DBE companies.
- (b) If the Department determines that the apparent successful bidder has made a good faith effort to secure the work commitment of DBE companies to meet the contract goal, the Department will award the contract provided that it is otherwise eligible for award. If the Department determines that the bidder has failed to meet the requirements of this Special Provision or that a good faith effort has not been made, the Department will notify the responsible company official designated in the Utilization Plan that the bid is not responsive. The notification shall include a statement of reasons for the determination. If the Utilization Plan is not approved because it is deficient as a technical matter, unless waived by the Department, the bidder will be notified and will be allowed no more than a five calendar day period in order to cure the deficiency.
- (c) The bidder may request administrative reconsideration of a determination adverse to the bidder within the five working days after the receipt of the notification date of the determination by delivering the request to the Department of Transportation, Bureau of Small Business Enterprises, Contract Compliance Section, 2300 South Dirksen Parkway, Room 319, Springfield, Illinois 62764 (Telefax: (217) 785-1524). Deposit of the request in the United States mail on or before the fifth business day shall not be deemed delivery. The determination shall become final if a request is not made and delivered. A request may provide additional written documentation or argument concerning the issues raised in the determination statement of reasons, provided the documentation and arguments address efforts made prior to submitting the bid. The request will be forwarded to the Department's Reconsideration Officer. The Reconsideration Officer will extend an opportunity to the bidder to meet in person in order to consider all issues of documentation and whether the bidder made a good faith effort to meet the goal. After the review by the Reconsideration Officer, the bidder will be sent a written decision within ten working days after receipt of the request for consideration, explaining the basis for finding that the bidder did or did not meet the goal or make adequate good faith efforts to do so. A final decision by the Reconsideration

Officer that a good faith effort was made shall approve the Utilization Plan submitted by the bidder and shall clear the contract for award. A final decision that a good faith effort was not made shall render the bid not responsive.

CALCULATING DBE PARTICIPATION. The Utilization Plan values represent work anticipated to be performed and paid for upon satisfactory completion. The Department is only able to count toward the achievement of the overall goal and the contract goal the value of payments made for the work actually performed by DBE companies. In addition, a DBE must perform a commercially useful function on the contract to be counted. A commercially useful function is generally performed when the DBE is responsible for the work and is carrying out its responsibilities by actually performing, managing, and supervising the work involved. The Department and Contractor are governed by the provisions of 49 CFR Part 26.55(c) on questions of commercially useful functions as it affects the work. Specific counting guidelines are provided in 49 CFR Part 26.55, the provisions of which govern over the summary contained herein.

- (a) DBE as the Contractor: 100 percent goal credit for that portion of the work performed by the DBE's own forces, including the cost of materials and supplies. Work that a DBE subcontracts to a non-DBE does not count toward the DBE goals.
- (b) DBE as a joint venture Contractor: 100 percent goal credit for that portion of the total dollar value of the contract equal to the distinct, clearly defined portion of the work performed by the DBE's own forces.
- (c) DBE as a subcontractor: 100 percent goal credit for the work of the subcontract performed by the DBE's own forces, including the cost of materials and supplies, excluding the purchase of materials and supplies or the lease of equipment by the DBE subcontractor from the prime Contractor or its affiliates. Work that a DBE subcontractor in turn subcontracts to a non-DBE does not count toward the DBE goal.
- (d) DBE as a trucker: 100 percent goal credit for trucking participation provided the DBE is responsible for the management and supervision of the entire trucking operation for which it is responsible. At least one truck owned, operated, licensed, and insured by the DBE must be used on the contract. Credit will be given for the following:
 - (1) The DBE may lease trucks from another DBE firm, including an owner-operator who is certified as a DBE. The DBE who leases trucks from another DBE receives credit for the total value of the transportation services the lessee DBE provides on the contract.
 - (2) The DBE may also lease trucks from a non-DBE firm, including from an owner-operator. The DBE who leases trucks from a non-DBE is entitled to credit only for the fee or commission is receives as a result of the lease arrangement.
- (e) DBE as a material supplier:

- (1) 60 percent goal credit for the cost of the materials or supplies purchased from a DBE regular dealer.
- (2) 100 percent goal credit for the cost of materials of supplies obtained from a DBE manufacturer.
- (3) 100 percent credit for the value of reasonable fees and commissions for the procurement of materials and supplies if not a DBE regular dealer or DBE manufacturer.

CONTRACT COMPLIANCE. Compliance with this Special Provision is an essential part of the contract. The Department is prohibited by federal regulations from crediting the participation of a DBE included in the Utilization Plan toward either the contract goal or the Department's overall goal until the amount to be applied toward the goals has been paid to the DBE. The following administrative procedures and remedies govern the compliance by the Contractor with the contractual obligations established by the Utilization Plan. After approval of the Utilization Plan and award of the contract, the Utilization Plan and individual DBE Participation Statements become part of the contract. If the Contractor did not succeed in obtaining enough DBE participation to achieve the advertised contract goal, and the Utilization Plan was approved and contract awarded based upon a determination of good faith, the total dollar value of DBE work calculated in the approved Utilization Plan as a percentage of the awarded contract value shall become the amended contract goal. All work indicated for performance by an approved DBE shall be performed, managed, and supervised by the DBE executing the DBE Participation Commitment Statement.

- (a) NO AMENDMENT. No amendment to the Utilization Plan may be made without prior written approval from the Department's Bureau of Small Business Enterprises. All requests for amendment to the Utilization Plan shall be submitted to the Department of Transportation, Bureau of Small Business Enterprises, Contract Compliance Section, 2300 South Dirksen Parkway, Room 319, Springfield, Illinois 62764. Telephone number (217) 785-4611. Telefax number (217) 785-1524.
- (b) CHANGES TO WORK. Any deviation from the DBE condition-of-award or contract plans, specifications, or special provisions must be approved, in writing, by the Department as provided elsewhere in the Contract. The Contractor shall notify affected DBEs in writing of any changes in the scope of work which result in a reduction in the dollar amount condition-of-award to the contract. Where the revision includes work committed to a new DBE subcontractor, not previously involved in the project, then a Request for Approval of Subcontractor, Department form BC 260A or AER 260A, must be signed and submitted. If the commitment of work is in the form of additional tasks assigned to an existing subcontract, then a new Request for Approval of Subcontractor shall not be required. However, the Contractor must document efforts to assure that the existing DBE subcontractor is capable of performing the additional work and has agreed in writing to the change.

(c) SUBCONTRACT. The Contractor must provide DBE subcontracts to IDOT upon request. Subcontractors shall ensure that all lower tier subcontracts or agreements with DBEs to supply labor or materials be performed in accordance with this Special Provision.

(d) ALTERNATIVE WORK METHODS. In addition to the above requirements for reductions in the condition of award, additional requirements apply to the two cases of Contractor-initiated work substitution proposals. Where the contract allows alternate work methods which serve to delete or create underruns in condition of award DBE work, and the Contractor selects that alternate method or, where the Contractor proposes a substitute work method or material that serves to diminish or delete work committed to a DBE and replace it with other work, then the Contractor must demonstrate one of the following:

- (1) That the replacement work will be performed by the same DBE (as long as the DBE is certified in the respective item of work) in a modification of the condition of award; or
- (2) That the DBE is aware that its work will be deleted or will experience underruns and has agreed in writing to the change. If this occurs, the Contractor shall substitute other work of equivalent value to a certified DBE or provide documentation of good faith efforts to do so; or
- (3) That the DBE is not capable of performing the replacement work or has declined to perform the work at a reasonable competitive price. If this occurs, the Contractor shall substitute other work of equivalent value to a certified DBE or provide documentation of good faith efforts to do so.

(e) TERMINATION AND REPLACEMENT PROCEDURES. The Contractor shall not terminate or replace a DBE listed on the approved Utilization Plan, or perform with other forces work designated for a listed DBE except as provided in this Special Provision. The Contractor shall utilize the specific DBEs listed to perform the work and supply the materials for which each is listed unless the Contractor obtains the Department's written consent as provided in subsection (a) of this part. Unless Department consent is provided for termination of a DBE subcontractor, the Contractor shall not be entitled to any payment for work or material unless it is performed or supplied by the DBE in the Utilization Plan.

As stated above, the Contractor shall not terminate or replace a DBE subcontractor listed in the approved Utilization Plan without prior written consent. This includes, but is not limited to, instances in which the Contractor seeks to perform work originally designated for a DBE subcontractor with its own forces or those of an affiliate, a non-DBE firm, or with another DBE firm. Written consent will be granted only if the Bureau of Small Business Enterprises agrees, for reasons stated in its concurrence document, that the Contractor has good cause to terminate or replace the DBE firm. Before transmitting to the Bureau of Small Business Enterprises any request to terminate and/or substitute a DBE subcontractor, the Contractor shall give notice in writing to the DBE subcontractor,

with a copy to the Bureau, of its intent to request to terminate and/or substitute, and the reason for the request. The Contractor shall give the DBE five days to respond to the Contractor's notice. The DBE so notified shall advise the Bureau and the Contractor of the reasons, if any, why it objects to the proposed termination of its subcontract and why the Bureau should not approve the Contractor's action. If required in a particular case as a matter of public necessity, the Bureau may provide a response period shorter than five days.

For purposes of this paragraph, good cause includes the following circumstances:

- (1) The listed DBE subcontractor fails or refuses to execute a written contract;
- (2) The listed DBE subcontractor fails or refuses to perform the work of its subcontract in a way consistent with normal industry standards. Provided, however, that good cause does not exist if the failure or refusal of the DBE subcontractor to perform its work on the subcontract results from the bad faith or discriminatory action of the prime contractor;
- (3) The listed DBE subcontractor fails or refuses to meet the prime Contractor's reasonable, nondiscriminatory bond requirements;
- (4) The listed DBE subcontractor becomes bankrupt, insolvent, or exhibits credit unworthiness;
- (5) The listed DBE subcontractor is ineligible to work on public works projects because of suspension and debarment proceedings pursuant 2 CFR Parts 180, 215 and 1200 or applicable state law.
- (6) You have determined that the listed DBE subcontractor is not a responsible contractor;
- (7) The listed DBE subcontractor voluntarily withdraws from the projects and provides to you written notice of its withdrawal;
- (8) The listed DBE is ineligible to receive DBE credit for the type of work required;
- (9) A DBE owner dies or becomes disabled with the result that the listed DBE contractor is unable to complete its work on the contract;
- (10) Other documented good cause that compels the termination of the DBE subcontractor. Provided, that good cause does not exist if the prime Contractor seeks to terminate a DBE it relied upon to obtain the contract so that the prime Contractor can self-perform the work for which the DBE contractor was engaged or so that the prime Contractor can substitute another DBE or non-DBE contractor after contract award.

When a DBE is terminated, or fails to complete its work on the Contract for any reason the Contractor shall make a good faith effort to find another DBE to substitute for the original DBE to perform at least the same amount of work under the contract as the terminated DBE to the extent needed to meet the established Contract goal. The good faith efforts shall be documented by the Contractor. If the Department requests documentation under this provision, the Contractor shall submit the documentation within seven days, which may be extended for an additional seven days if necessary at the request of the Contractor. The Department shall provide a written determination to the Contractor stating whether or not good faith efforts have been demonstrated.

- (f) PAYMENT RECORDS. The Contractor shall maintain a record of payments for work performed to the DBE participants. The records shall be made available to the Department for inspection upon request. After the performance of the final item of work or delivery of material by a DBE and final payment therefore to the DBE by the Contractor, but not later than thirty calendar days after payment has been made by the Department to the Contractor for such work or material, the Contractor shall submit a DBE Payment Agreement on Department form SBE 2115 to the Resident Engineer. If full and final payment has not been made to the DBE, the DBE Payment Agreement shall indicate whether a disagreement as to the payment required exists between the Contractor and the DBE or if the Contractor believes that the work has not been satisfactorily completed. If the Contractor does not have the full amount of work indicated in the Utilization Plan performed by the DBE companies indicated in the Utilization Plan and after good faith efforts are reviewed, the Department may deduct from contract payments to the Contractor the amount of the goal not achieved as liquidated and ascertained damages. The Contractor may request an administrative reconsideration of any amount deducted as damages pursuant to subsection (h) of this part.
- (g) ENFORCEMENT. The Department reserves the right to withhold payment to the Contractor to enforce the provisions of this Special Provision. Final payment shall not be made on the contract until such time as the Contractor submits sufficient documentation demonstrating achievement of the goal in accordance with this Special Provision or after liquidated damages have been determined and collected.
- (h) RECONSIDERATION. Notwithstanding any other provision of the contract, including but not limited to Article 109.09 of the Standard Specifications, the Contractor may request administrative reconsideration of a decision to deduct the amount of the goal not achieved as liquidated damages. A request to reconsider shall be delivered to the Contract Compliance Section and shall be handled and considered in the same manner as set forth in paragraph (c) of "Good Faith Effort Procedures" of this Special Provision, except a final decision that a good faith effort was not made during contract performance to achieve the goal agreed to in the Utilization Plan shall be the final administrative decision of the Department. The result of the reconsideration process is not administratively appealable to the U.S. Department of Transportation.

EQUAL EMPLOYMENT OPPORTUNITY (BDE)

Effective: April 1, 2015

FEDERAL AID CONTRACTS. Revise the following section of Check Sheet #1 of the Recurring Special Provisions to read:

"EQUAL EMPLOYMENT OPPORTUNITY

In the event of the Contractor's noncompliance with the provisions of this Equal Employment Opportunity Clause, the Illinois Human Rights Act, or the Illinois Department of Human Rights Rules and Regulations, the Contractor may be declared ineligible for future contracts or subcontracts with the State of Illinois or any of its political sub-divisions or municipal corporations, and the contract may be cancelled or voided in whole or in part, and such other sanctions or penalties may be imposed or remedies invoked as provided by statute or regulation.

During the performance of this Contract, the Contractor agrees as follows:

- (1) That it will not discriminate against any employee or applicant for employment because of race, color, religion, sex, sexual orientation, marital status, order of protection status, national origin or ancestry, citizenship status, age, physical or mental disability unrelated to ability, military status, or an unfavorable discharge from military service; and further that it will examine all job classifications to determine if minority persons or women are underutilized and will take appropriate affirmative action to rectify any such underutilization.
- (2) That, if it hires additional employees in order to perform this contract or any portion hereof, it will determine the availability (according to the Illinois Department of Human Rights Rules and Regulations) of minorities and women in the area(s) from which it may reasonably recruit and it will hire for each job classification for which employees are hired in such a way that minorities and women are not underutilized.
- (3) That, in all solicitations or advertisements for employees placed by it or on its behalf, it will state that all applicants will be afforded equal opportunity without discrimination because of race, color, religion, sex, sexual orientation, marital status, order of protection status, national origin or ancestry, citizenship status, age, physical or mental disability unrelated to ability, military status or an unfavorable discharge from military service.
- (4) That it will send to each labor organization or representative of workers with which it has or is bound by a collective bargaining or other agreement or understanding, a notice advising such labor organization or representative of the Contractor's obligations under the Illinois Human Rights Act and the Illinois Department of Human Rights Rules and Regulations. If any labor organization or representative fails or refuses to cooperate with the Contractor in its efforts to comply with such Act and Rules and Regulations, the

Contractor will promptly so notify the Illinois Department of Human Rights and IDOT and will recruit employees from other sources when necessary to fulfill its obligations thereunder.

- (5) That it will submit reports as required by the Illinois Department of Human Rights Rules and Regulations, furnish all relevant information as may from time to time be requested by the Illinois Department of Human Rights or IDOT, and in all respects comply with the Illinois Human Rights Act and the Illinois Department of Human Rights Rules and Regulations.
- (6) That it will permit access to all relevant books, records, accounts, and work sites by personnel of IDOT and the Illinois Department of Human Rights for purposes of investigation to ascertain compliance with the Illinois Human Rights Act and the Illinois Department of Human Rights Rules and Regulations.
- (7) That it will include verbatim or by reference the provisions of this clause in every subcontract it awards under which any portion of the contract obligations are undertaken or assumed, so that the provisions will be binding upon the subcontractor. In the same manner as with other provisions of this contract, the Contractor will be liable for compliance with applicable provisions of this clause by subcontractors; and further it will promptly notify IDOT and the Illinois Department of Human Rights in the event any subcontractor fails or refuses to comply with these provisions. In addition, the Contractor will not utilize any subcontractor declared by the Illinois Human Rights Commission to be ineligible for contracts or subcontracts with the State of Illinois or any of its political subdivisions or municipal corporations."

STATE CONTRACTS. Revise Section II of Check Sheet #5 of the Recurring Special Provisions to read:

"II. EQUAL EMPLOYMENT OPPORTUNITY

In the event of the Contractor's noncompliance with the provisions of this Equal Employment Opportunity Clause, the Illinois Human Rights Act or the Illinois Department of Human Rights Rules and Regulations, the Contractor may be declared ineligible for future contracts or subcontracts with the State of Illinois or any of its political sub-divisions or municipal corporations, and the contract may be cancelled or voided in whole or in part, and such other sanctions or penalties may be imposed or remedies invoked as provided by statute or regulation.

During the performance of this Contract, the Contractor agrees as follows:

1. That it will not discriminate against any employee or applicant for employment because of race, color, religion, sex, sexual orientation, marital status, order of protection status, national origin or ancestry, citizenship status, age, physical or mental disability unrelated to ability, military status, or an unfavorable discharge from military service; and further

that it will examine all job classifications to determine if minority persons or women are underutilized and will take appropriate affirmative action to rectify any such underutilization.

2. That, if it hires additional employees in order to perform this contract or any portion hereof, it will determine the availability (according to the Illinois Department of Human Rights Rules and Regulations) of minorities and women in the area(s) from which it may reasonably recruit and it will hire for each job classification for which employees are hired in such a way that minorities and women are not underutilized.
3. That, in all solicitations or advertisements for employees placed by it or on its behalf, it will state that all applicants will be afforded equal opportunity without discrimination because of race, color, religion, sex, sexual orientation, marital status, order of protection status, national origin or ancestry, citizenship status, age, physical or mental disability unrelated to ability, military status, or an unfavorable discharge from military service.
4. That it will send to each labor organization or representative of workers with which it has or is bound by a collective bargaining or other agreement or understanding, a notice advising such labor organization or representative of the Contractor's obligations under the Illinois Human Rights Act and the Illinois Department of Human Rights Rules and Regulations. If any labor organization or representative fails or refuses to cooperate with the Contractor in its efforts to comply with such Act and Rules and Regulations, the Contractor will promptly so notify the Illinois Department of Human Rights and IDOT and will recruit employees from other sources when necessary to fulfill its obligations thereunder.
5. That it will submit reports as required by the Illinois Department of Human Rights Rules and Regulations, furnish all relevant information as may from time to time be requested by the Illinois Department of Human Rights or IDOT, and in all respects comply with the Illinois Human Rights Act and the Illinois Department of Human Rights Rules and Regulations.
6. That it will permit access to all relevant books, records, accounts and work sites by personnel of IDOT and the Illinois Department of Human Rights for purposes of investigation to ascertain compliance with the Illinois Human Rights Act and the Illinois Department of Human Rights Rules and Regulations.
7. That it will include verbatim or by reference the provisions of this clause in every subcontract it awards under which any portion of the contract obligations are undertaken or assumed, so that the provisions will be binding upon the subcontractor. In the same manner as with other provisions of this contract, the Contractor will be liable for compliance with applicable provisions of this clause by subcontractors; and further it will promptly notify IDOT and the Illinois Department of Human Rights in the event any subcontractor fails or refuses to comply with these provisions. In addition, the Contractor will not utilize any subcontractor declared by the Illinois Human Rights

Commission to be ineligible for contracts or subcontracts with the State of Illinois or any of its political subdivisions or municipal corporations.”

80358

PAVEMENT STRIPING - SYMBOLS (BDE)

Effective: January 1, 2015

Revise the Symbol Table of Article 780.14 of the Supplemental Specifications to read:

“SYMBOLS

Symbol	Large Size sq ft (sq m)	Small Size sq ft (sq m)
Through Arrow	11.5 (1.07)	6.5 (0.60)
Left or Right Arrow	15.6 (1.47)	8.8 (0.82)
2 Arrow Combination Left (or Right) and Through	26.0 (2.42)	14.7 (1.37)
3 Arrow Combination Left, Right, and Through	38.4 (3.56)	20.9 (1.94)
Lane Drop Arrow	41.5 (3.86)	--
Wrong Way Arrow	24.3 (2.26)	--
Railroad "R" 6 ft (1.8 m)	3.6 (0.33)	--
Railroad "X" 20 ft (6.1 m)	54.0 (5.02)	--
International Symbol of Accessibility	3.1 (0.29)	--
Bike Symbol	4.7 (0.44)	--
Shared Lane Symbol	8.0 (0.74)	--“

80352

PROGRESS PAYMENTS (BDE)

Effective: November 2, 2013

Revise Article 109.07(a) of the Standard Specifications to read:

“(a) Progress Payments. At least once each month, the Engineer will make a written estimate of the quantity of work performed in accordance with the contract, and the value thereof at the contract unit prices. The amount of the estimate approved as due for payment will be vouchered by the Department and presented to the State Comptroller for payment. No amount less than \$1000.00 will be approved for payment other than the final payment.

Progress payments may be reduced by liens filed pursuant to Section 23(c) of the Mechanics' Lien Act, 770 ILCS 60/23(c).

If a Contractor or subcontractor has defaulted on a loan issued under the Department's Disadvantaged Business Revolving Loan Program (20 ILCS 2705/2705-610), progress payments may be reduced pursuant to the terms of that loan agreement. In such cases, the amount of the estimate related to the work performed by the Contractor or subcontractor, in default of the loan agreement, will be offset, in whole or in part, and vouchered by the Department to the Working Capital Revolving Fund or designated escrow account. Payment for the work shall be considered as issued and received by the Contractor or subcontractor on the date of the offset voucher. Further, the amount of the offset voucher shall be a credit against the Department's obligation to pay the Contractor, the Contractor's obligation to pay the subcontractor, and the Contractor's or subcontractor's total loan indebtedness to the Department. The offset shall continue until such time as the entire loan indebtedness is satisfied. The Department will notify the Contractor and Fund Control Agent in a timely manner of such offset. The Contractor or subcontractor shall not be entitled to additional payment in consideration of the offset.

The failure to perform any requirement, obligation, or term of the contract by the Contractor shall be reason for withholding any progress payments until the Department determines that compliance has been achieved.”

80328

WEEKLY DBE TRUCKING REPORTS (BDE)

Effective: June 2, 2012

| Revised: April 2, 2015

| The Contractor shall submit a weekly report of Disadvantaged Business Enterprise (DBE) trucks hired by the Contractor or subcontractors (i.e. not owned by the Contractor or subcontractors) that are used for DBE goal credit.

| The report shall be submitted to the Engineer on Department form "SBE 723" within ten business days following the reporting period. The reporting period shall be Monday through Sunday for each week reportable trucking activities occur.

Any costs associated with providing weekly DBE trucking reports shall be considered as included in the contract unit prices bid for the various items of work involved and no additional compensation will be allowed.

80302

**STATE OF ILLINOIS
DEPARTMENT OF TRANSPORTATION
DIVISION OF HIGHWAYS**

ROUTE: VARIOUS FAS ROUTES
SECTION: 13-00167-00-PP
PROJECT: RS-0175(029)
STARK COUNTY
JOB NO.: C-94-058-14

INDEX OF SHEETS

- 1 Cover Sheet
- 2 Summary of Quantities, Schedules, & Typicals
- 3 Intersection Details
- 4 Stockpile Map
- 5-1Z Highway Standards

HIGHWAY STANDARDS

- 701901-02
- 780001-03
- BLR 18-5
- BLR 22-7



Mark J. Otten
MARK J. OTTEN, P.E.
EXPIRES 11/30/2017

Catalog No. 035071-00
CONTRACT NO. 89667

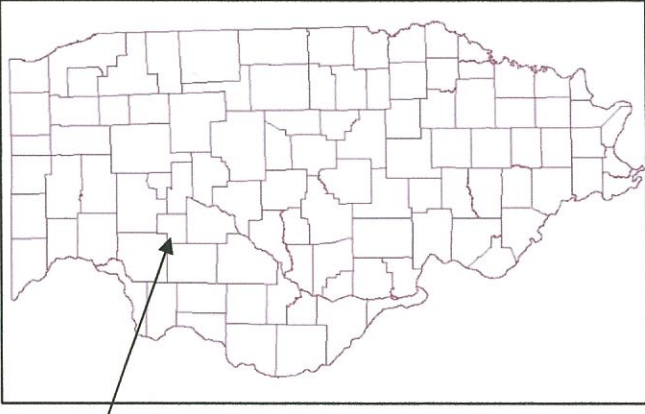

PROJECT LOCATION

STATE OF ILLINOIS

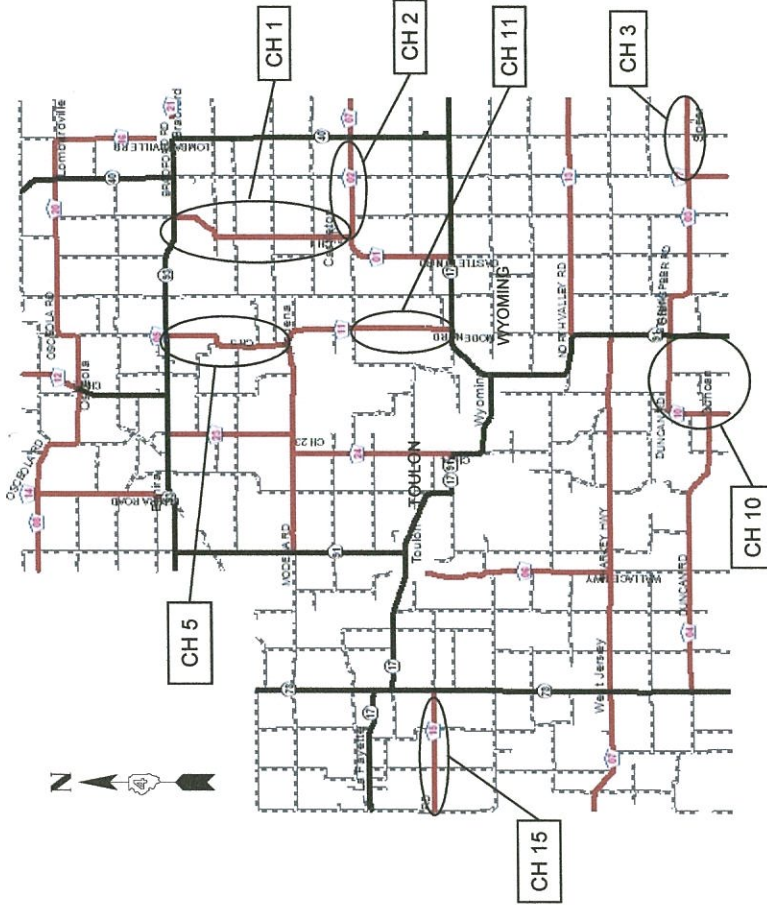

PROJECT DESCRIPTION: A-1 BITUMINOUS SURFACE TREATMENT

ROAD NAME	FROM	TO	LENGTH (MI)
CASTLETON RD	TR 950N	IL 93	4.75
E CASTLETON RD	TR 1450N	IL 40	2.53
SOUTH VALLEY RD	CH 17	CO LINE	2.02
N MODENA RD	TR 1150N	IL 93	3.23
WINANS RD	CO LINE	IL 78	3.09
DUNCAN RD	CO LINE	IL 91	3.49
SNAREVILLE RD	IL 17	TR 950N	2.51
NET LENGTH OF PROJECT =			21.62 MILES

DATE 12/10/2015

APPROVED *Mark J. Otten*
COUNTY ENGINEER

PASSED *Dec 17* 20 *15*

David J. Ott
DISTRICT FOUR ENGINEER OF
LOCAL ROADS & STREETS

Releasing for Bid Based on Limited Review December 17 20 15

Richard A. O'Connell
DEPUTY DIRECTOR OF HIGHWAYS
REGION THREE ENGINEER
STATE OF ILLINOIS
DEPARTMENT OF TRANSPORTATION

STARK COUNTY HIGHWAY DEPT.
411 E. MAIN ST. TOULON, IL 61483
(309) 286-5031

SUMMARY OF QUANTITIES

CODE	ITEM	UNIT	QTY
40300600	BIT MATLS (SEAL COAT)	GAL	88,048
40300600	SEAL COAT AGGREGATE	TON	3,220
78001110	PAINT PAVT MARKING - 4"	FOOT	97,135
78001100	PAINT PV MK LTR & SYMB	SF	310
67100100	MOBILIZATION	LSUM	1

* Specialty Items

*

SCHEDULE OF QUANTITIES

SECTION	ROAD NAME	FROM	TO	LENGTH (MILES)	LENGT H (FT)	WID TH (FT)	ROAD AREA (SQ YD)	CROSS ROADS	CROSS ROAD AREA (SQ YD)	TOTAL AREA (SQ YD)	APP RATE (GAL/SQYD)	40300400 BIT MAT SEAL CT (GAL)	40300600 SEAL COAT AGG (TON)	78001100 PAINT PVT MKLTRS & SYMB (SF)	78001110 PAINT PAVT MARKING- 4" (FOOT)
CH 1B	N. CASTLETON RD	TR 960N	TR 1150N	2.02	10,666	21	24,886	6	720	25,606	0.32	8,194	300		16,375
CH 1C	N. CASTLETON RD	TR 1150N	IL 93	2.73	14,414	21	33,634	3	360	33,994	0.32	10,878	400		6,638
CH 2A	E. CASTLETON RD	TR 1450E	IL 40	2.53	13,358	21	31,170	4	480	31,650	0.32	10,128	370		9,438
CH 3C	SOUTH VALLEY RD	CH 17	Co Line	2.02	10,666	22	26,071	5	600	26,671	0.32	8,535	310	310	8,150
CH 5A	N. MODENA RD	TR 1150N	IL 93	3.23	17,054	21	39,794	4	480	40,274	0.32	12,888	470		17,396
CH 15A	WINANS RD	Co Line	IL 78	3.09	16,315	22	39,882	4	480	40,362	0.32	12,916	470		12,435
CH 10A	DUNCAN RD	Co Line	TR 150N	1.54	8,131	21	18,973	4	480	19,453	0.32	6,225	230		5,387
CH 10B	DUNCAN RD	TR 1000E	IL 91	1.95	10,296	21	24,024	4	480	24,504	0.32	7,841	290		7,642
CH 11D	SNAREVILLE RD	IL 17	TR950N	2.51	13,253	22	32,396	2	240	32,636	0.32	10,443	380		13,684
				21.62						275,149		88,048	3,220	310	97,135

* APPLICATION RATE USED FOR AGGREGATE CALCULATIONS IS 23 LBS / SQ YD
 ** BITUMINOUS SEAL COAT MATERIAL SHALL BE PG 52-28

GENERAL NOTES:
 1. All intersections at State Routes shall be seal coated to the edge of traveled way along the State Route unless otherwise directed by the Engineer - see Intersection Details.

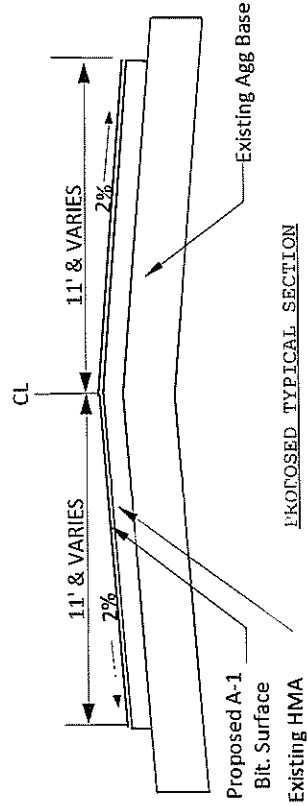

SUMMARY OF QUANTITIES
 SCHEDULE OF QUANTITIES
 & TYPICAL SECTION

STARK COUNTY HIGHWAY DEPT.
 411 E. MAIN ST. TOULON, IL 61483
 (309) 286-5031

Project	RS-175(029)
Route	Various
Section	13-00167-00-PP
County	Stark
Job No.	C-94-058-14
Contract No.	89667

Sheet 3 of 11

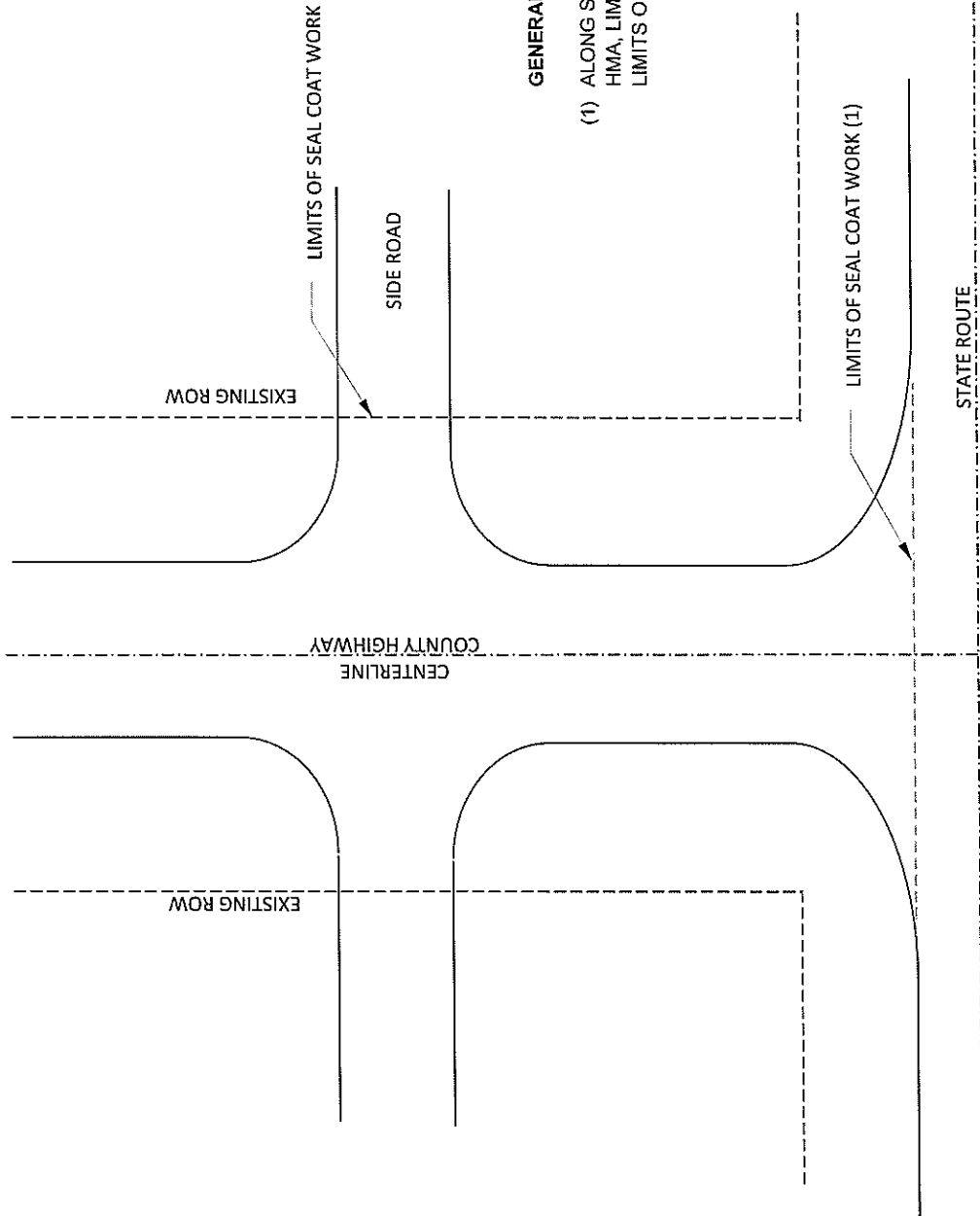

GENERAL NOTES

- (1) ALONG STATE ROUTES WHERE SURFACE IS NEW HMA, LIMITS OF SEAL COAT WILL END AT LIMITS OF NEW HOT-MIX ASPHALT

INTERSECTION DETAILS
STARK COUNTY HIGHWAY DEPT.
 411 E. MAIN ST. TOULON, IL 61483
 (309) 286-5031

STARK COUNTY, ILLINOIS SECURED STOCKPILE LOCATIONS

County	Stark
Job No.	C-94-058-14
Contract No.	89667
Sheet	4 of 11

SECURED STOCKPILE LOCATIONS FOR SEAL COAT AGGREGATE

1. Grain Storage Bins
2. Penn Twp Building
3. R&K Elevator- Speer, IL
4. Roadway Intersection ROW
5. Farm Storage Location

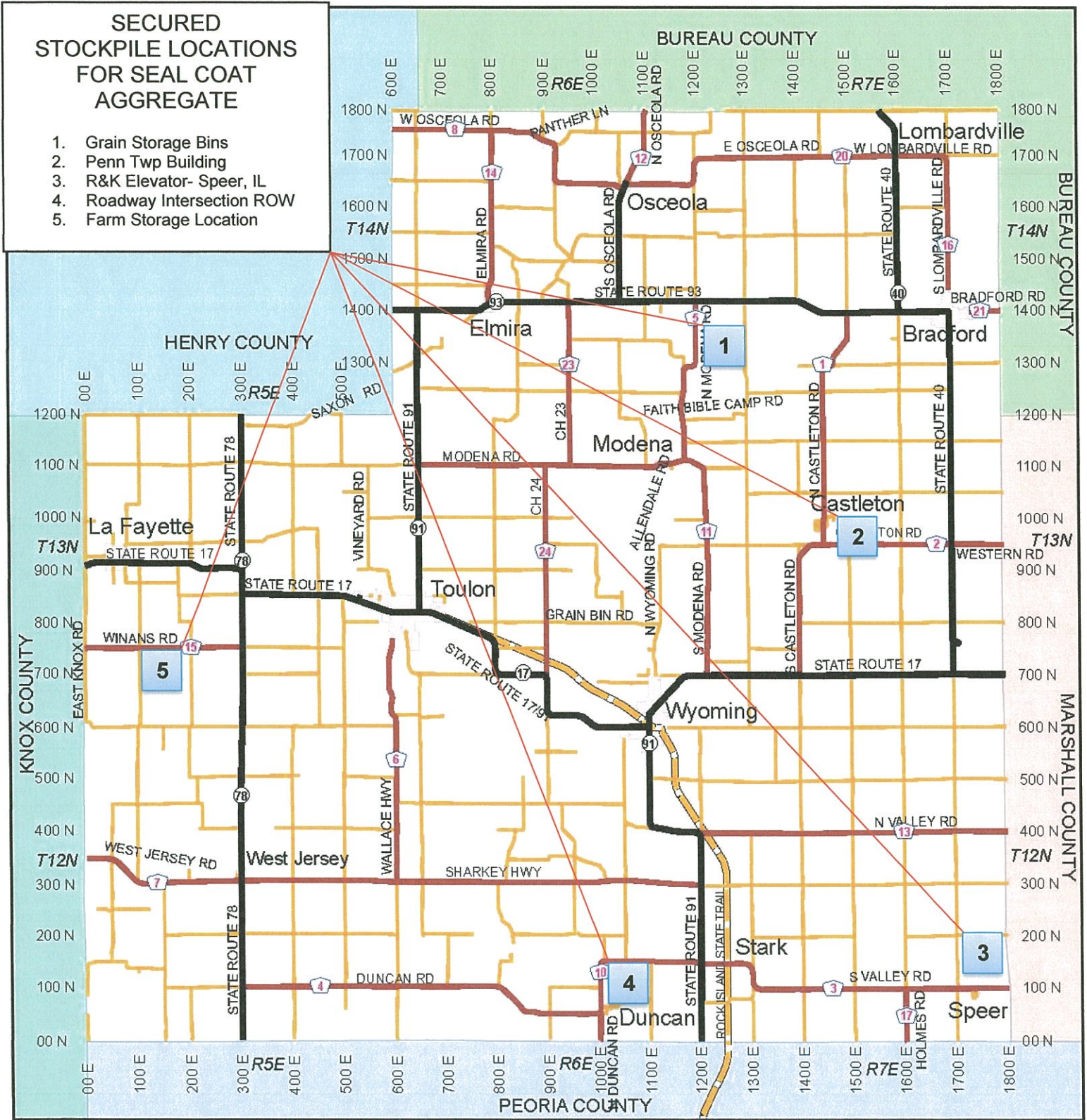

- US Routes
- State Routes
- County Highways
- Unincorporated
- bike trail

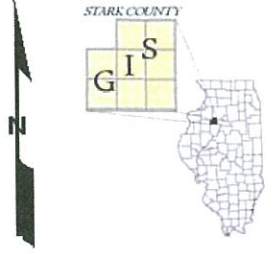

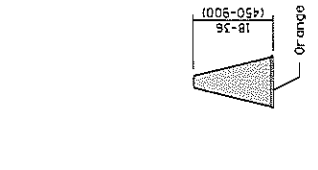

CONE

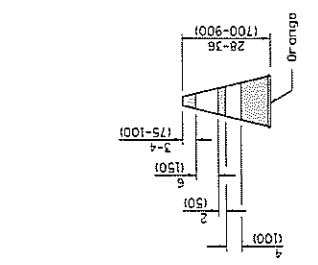

REFLECTORIZED CONE

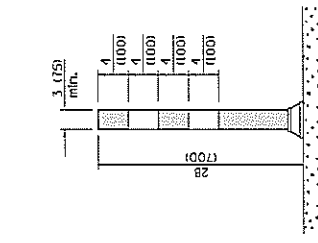

FLEXIBLE DELINEATOR

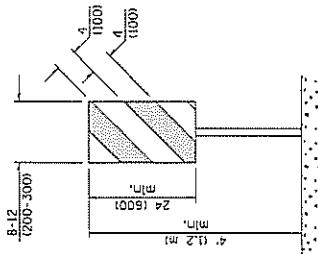

VERTICAL PANEL POST MOUNTED

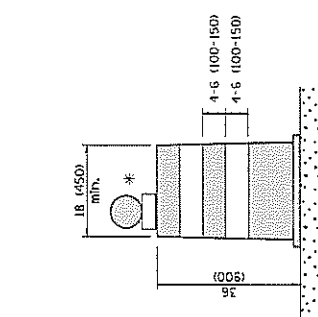

DRUM

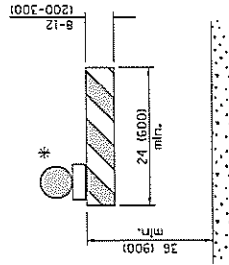

TYPE I BARRICADE

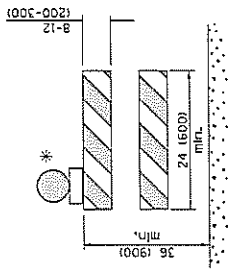

TYPE II BARRICADE

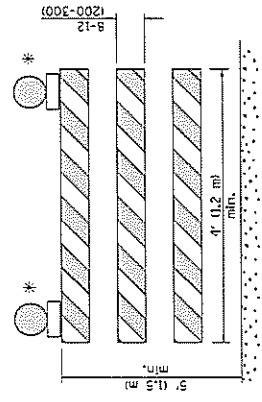

TYPE III BARRICADE

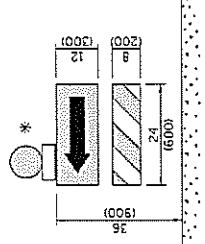

DIRECTION INDICATOR BARRICADE

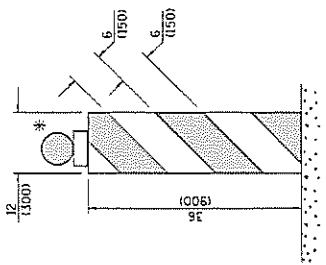

VERTICAL BARRICADE

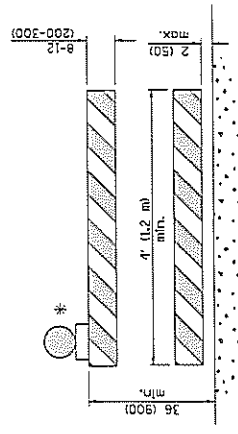

DETECTABLE PEDESTRIAN CHANNELIZING BARRICADE

* Warning lights (if required)

GENERAL NOTES
 All heights shown shall be measured above the pavement surface.
 All dimensions are in inches (millimeters) unless otherwise shown.

DATE	REVISIONS
1-1-15	Revised two sign numbers on sheet 2. Added note req. PHOTO ENFORCED plaque.
1-1-14	Modified Trigger sign height. Added highway construction speed zone signs.

TRAFFIC CONTROL DEVICES

(Sheet 1 of 3)

STANDARD 701801-04

Illinois Department of Transportation

APPROVED _____ 2015
 ENGINEER OF OPERATIONS

APPROVED _____ 2015
 ENGINEER OF DESIGN AND INSTRUMENT

ISSUED 1-1-15

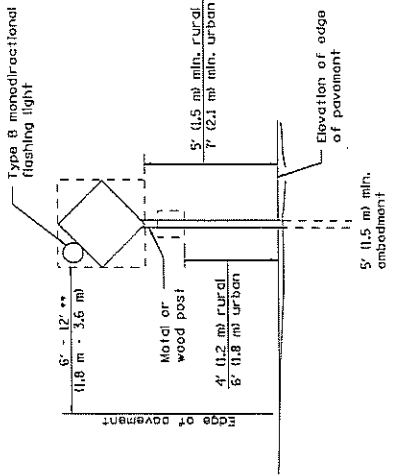

POST MOUNTED SIGNS

** When curb or paved shoulder (see previous) this dimension shall be 24 inches to the face of curb or 11.3 m. To the outside edge of the paved shoulder.

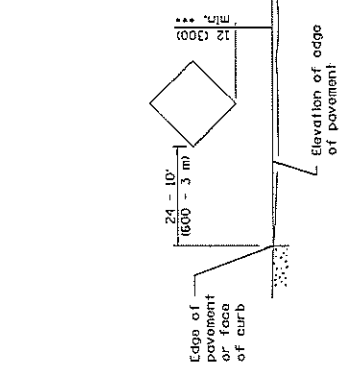

SIGNS ON TEMPORARY SUPPORTS

*** When work operations exceed four days, this dimension shall be 5'-6.5 m min. If located behind other devices, the height shall be sufficient to be seen completely above the devices.

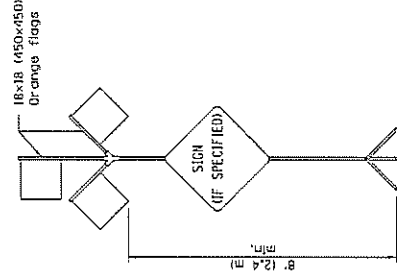

HIGH LEVEL WARNING DEVICE

ROAD CONSTRUCTION NEXT X MILES
620-110400-6036

END CONSTRUCTION
620-110510-6024

This signing is required for all projects 2 miles (3200 m) or more in length.
ROAD CONSTRUCTION NEXT X MILES sign shall be placed 500' (150 m) in advance of project limits.
END CONSTRUCTION sign shall be erected at the end of the job unless another job is within 2 miles (3200 m).
Dual sign displays shall be utilized on multi-lane highways.

WORK LIMIT SIGNING

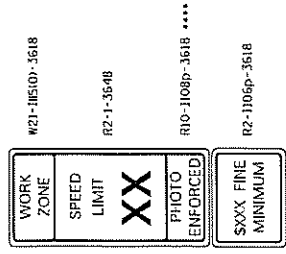

Sign assembly as shown on Standards or as allowed by District Operations.

END WORK ZONE SPEED LIMIT
620-1103100-6036

This sign shall be used when the above sign assembly is used.

HIGHWAY CONSTRUCTION SPEED ZONE SIGNS

**** RI0-1106p shall only be used along roadways under the jurisdiction of the State.

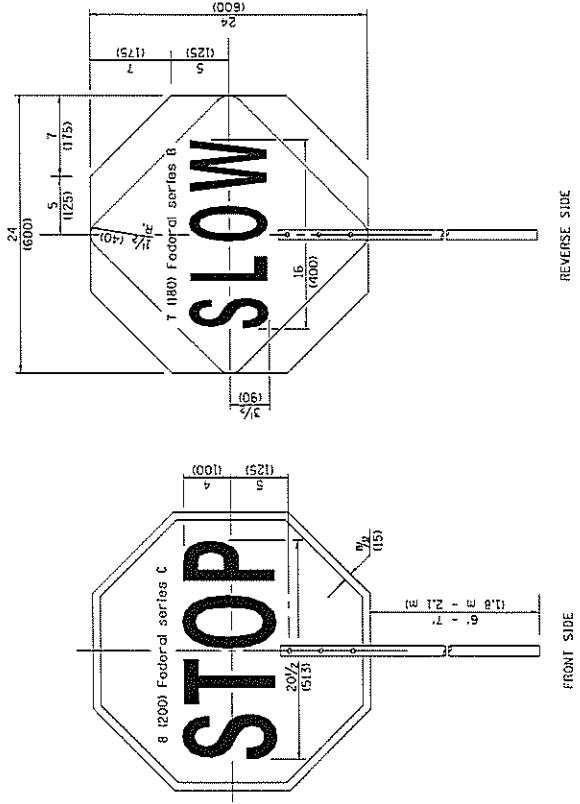

FLAGGER TRAFFIC CONTROL SIGN

Illinois Department of Transportation
 APPROVED: [Signature] 2015
 ENGINEER OF OPERATIONS
 APPROVED: [Signature] 2015
 ENGINEER OF DESIGN AND ENVIRONMENT

TRAFFIC CONTROL DEVICES

(Sheet 2 of 3)

STANDARD 701901-04

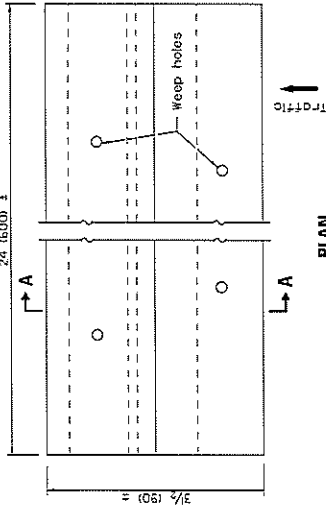

PLAN

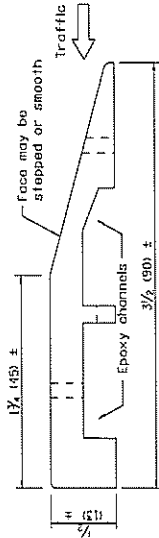

SECTION A-A

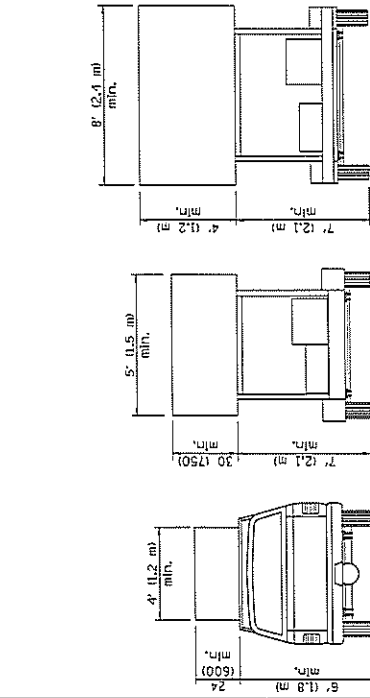

**TYPE A
ROOF
MOUNTED**

**TYPE B
ROOF OR TRAILER
MOUNTED**

**TYPE C
TRAILER
MOUNTED**

ARROW BOARDS

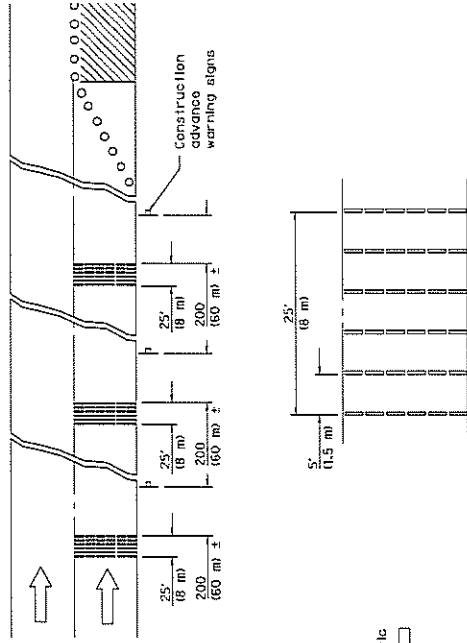

TYPICAL INSTALLATION

TEMPORARY RUMBLE STRIPS

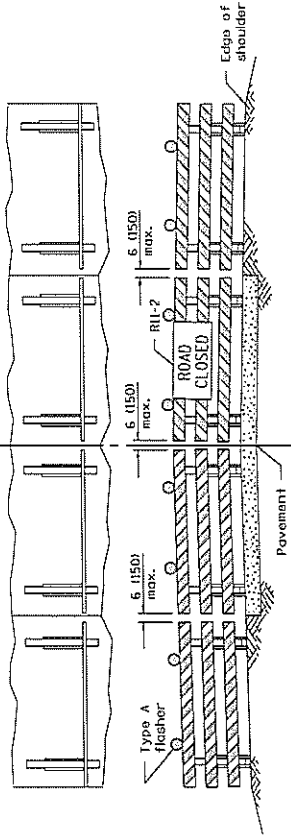

ROAD CLOSED TO ALL TRAFFIC

ReflectORIZED striping may be omitted on the back side of the barricades. If a Type III barricade with an attached sign panel which meets NCHRP 350 is not available, the sign may be mounted on an NCHRP 350 temporary sign support directly in front of the barricade.

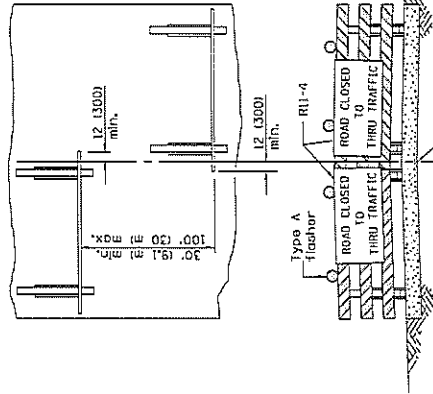

ROAD CLOSED TO THRU TRAFFIC

ReflectORIZED striping shall appear on both sides of the barricades. If a Type III barricade with an attached sign panel which meets NCHRP 350 is not available, the signs may be mounted on NCHRP 350 temporary sign supports directly in front of the barricade.

**TYPICAL APPLICATIONS OF
TYPE III BARRICADES CLOSING A ROAD**

**TRAFFIC CONTROL
DEVICES**

(Sheet 3 of 3)

STANDARD 701901-04

Illinois Department of Transportation APPROVED _____ January 1, 2015 ENGINEER OF OPERATIONS	ISSUED	1-1-97
	APPROVED _____ January 1, 2015 ENGINEER OF DESIGN AND ENVIRONMENT	

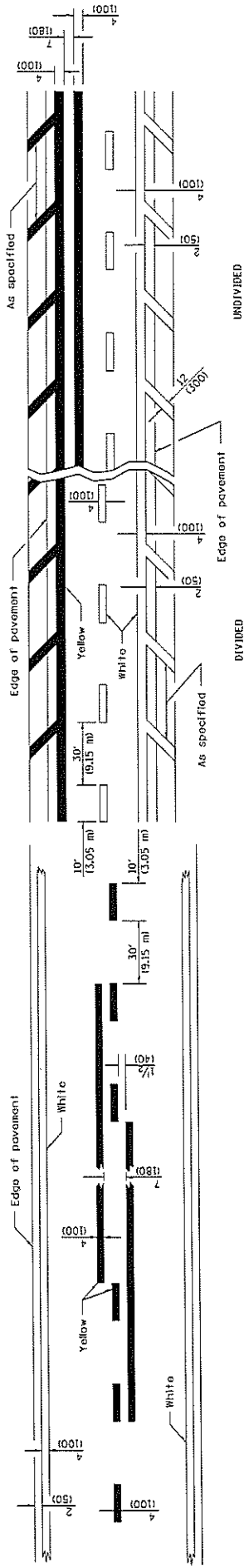

2 LANE

DIVIDED

MULTI LANE

UNDIVIDED

LANE AND EDGE LINES

Approximately 15' (4.5 m) from nearest rail or 8' (2.4 m) back from gate, if present. Stop line placed perpendicular to center line.

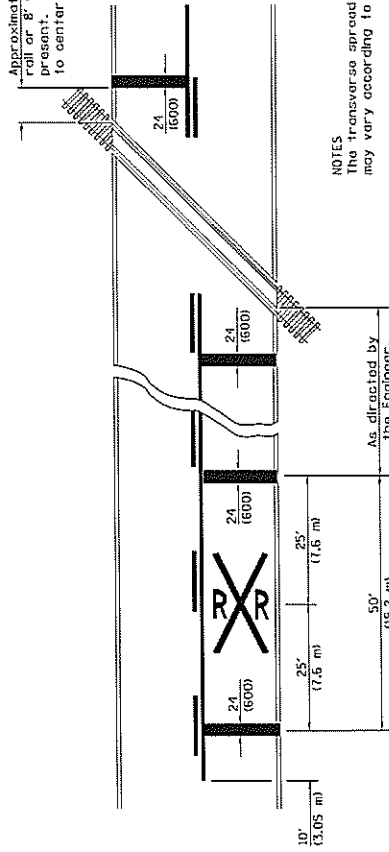

NOTES
 The transverse spread of the "x" may vary according to lane width.
 On multi-lane roads, the stop lines shall extend across all approach lanes and separate RR symbols shall be placed adjacent to each other in each lane.
 When the pavement marking symbol is used, a portion of the symbol should be located directly adjacent to the Advance Warning Sign (W10-1) as placed by Table 2C-4, Condition B of the MUTCD.

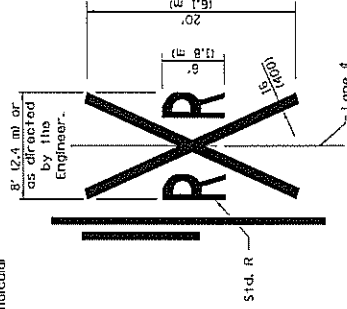

PAVEMENT MARKINGS AT RAILROAD-HIGHWAY GRADE CROSSING

All dimensions are in inches (millimeter) unless otherwise shown.

DATE	REVISIONS
1-1-15	Added symbols, Revised bike symbol, Revised date for stop line at RR crossing.
1-1-14	Added bike symbol, Renamed 'LANE DROP ARROW' detail to 'LANE-REDUCTION ARROW'.

TYPICAL PAVEMENT MARKINGS

(Sheet 1 of 3)

STANDARD 760001-05

Illinois Department of Transportation
 APPROVED: January 1, 2015
 ENGINEER OF OPERATIONS
 APPROVED: January 1, 2015
 ENGINEER OF DESIGN AND ENVIRONMENT

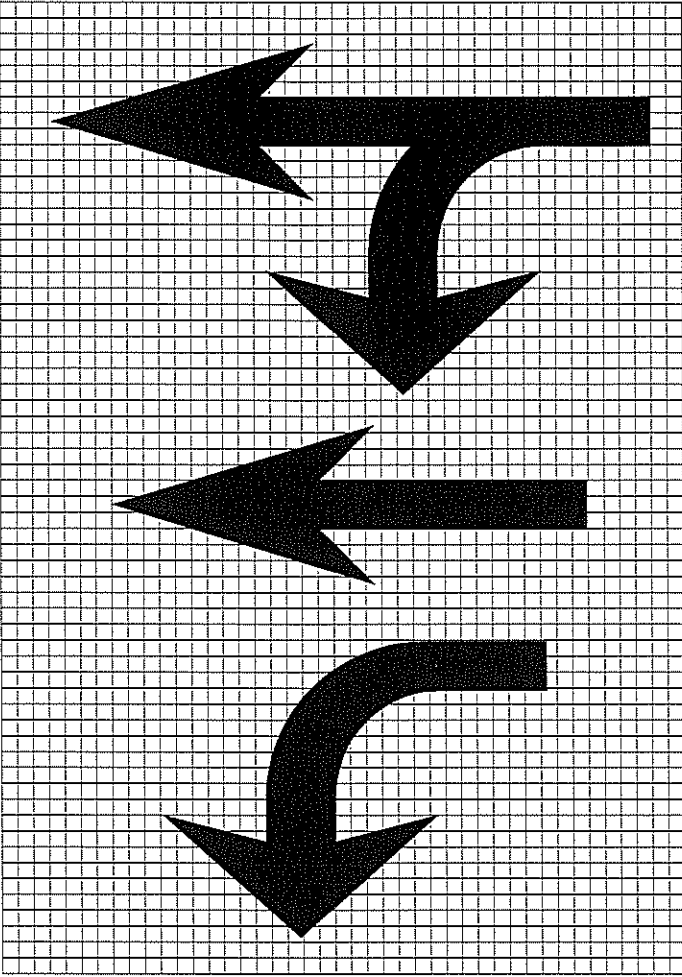
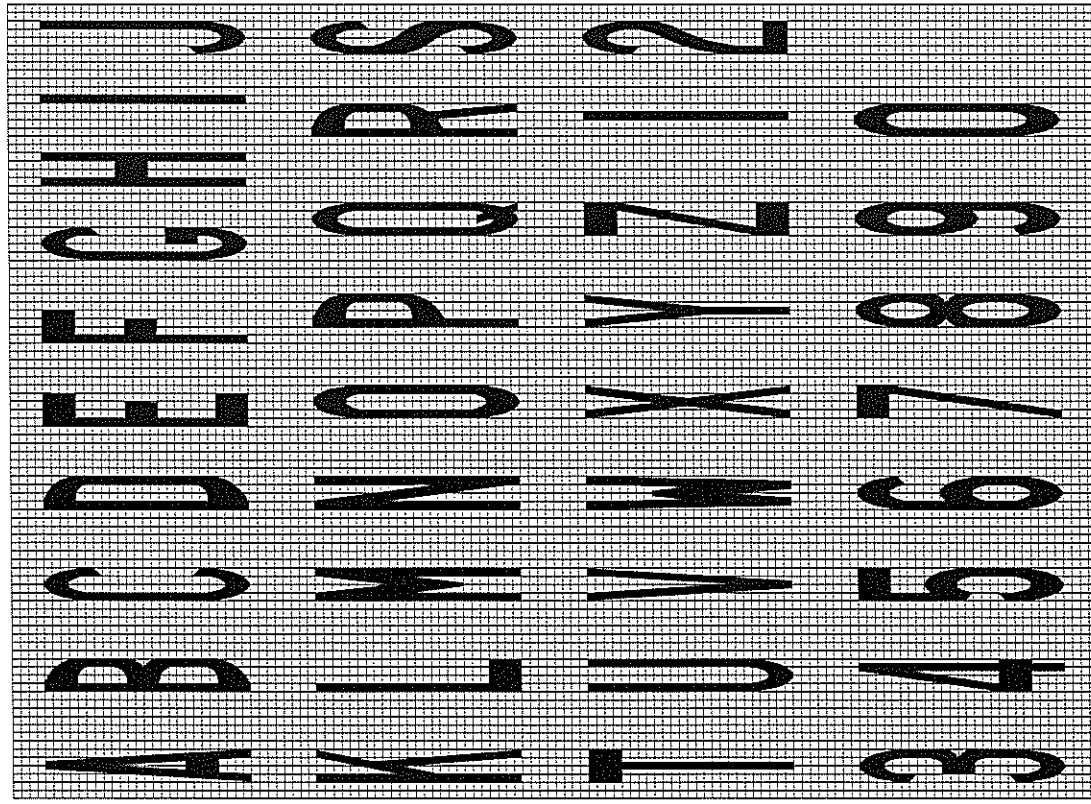

a	a
a	a

Legend Height	Arrow Size	a
6' (1.8 m)	Small	2.9 (74)
8' (2.4 m)	Large	3.8 (96)

The space between adjacent letters or numerals should be approximately 3/32" for 6' (1.8 m) legend and 1/16" for 8' (2.4 m) legend.

LETTER AND ARROW GRID SCALE

TYPICAL PAVEMENT MARKINGS
(Sheet 2 of 3)
STANDARD 780001-05

 Minnesota Department of Transportation	APPROVED _____ 2015	ISSUED 1-1-97
	ENGINEER OF OPERATIONS _____	
	APPROVED _____ 2015	
	ENGINEER OF DESIGN AND ENVIRONMENT _____	

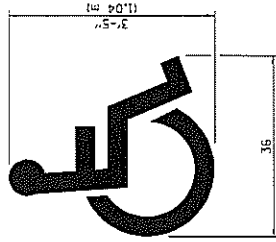

INTERNATIONAL SYMBOL OF ACCESSIBILITY

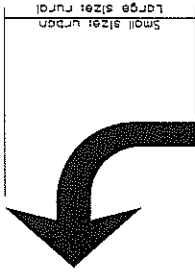

20' (6 m): Urban
50' (15 m): Rural
(Between arrow and word or between words)

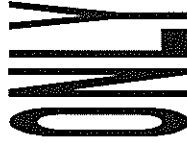

6'-11.8 m: Urban
9'-2.4 m: Rural

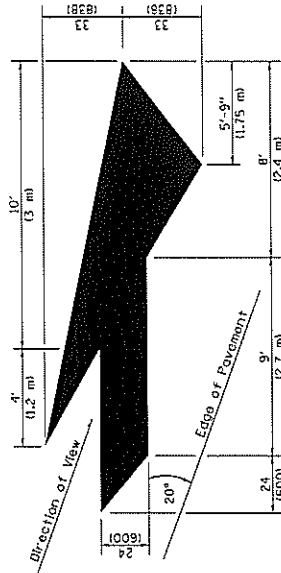

LANE-REDUCTION ARROW

Right lane-reduction arrow shown. Use mirror image for left lane.

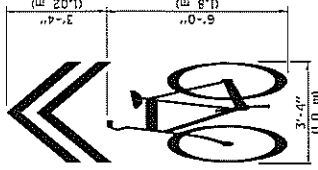

SHARED LANE SYMBOL

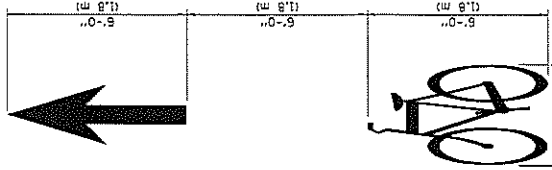

BIKE SYMBOL
(Arrow is optional)

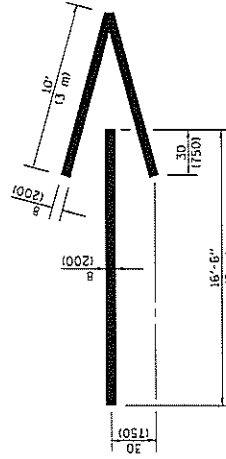

WRONG WAY ARROW

Illinois Department of Transportation

APPROVED January 1, 2015

ENGINEER OF DIVISION

APPROVED January 1, 2015

ENGINEER OF DESIGN AND ENVIRONMENT

ISSUED 1-1-97

TYPICAL PAVEMENT MARKINGS

(Sheet 3 of 3)

STANDARD 760001-05

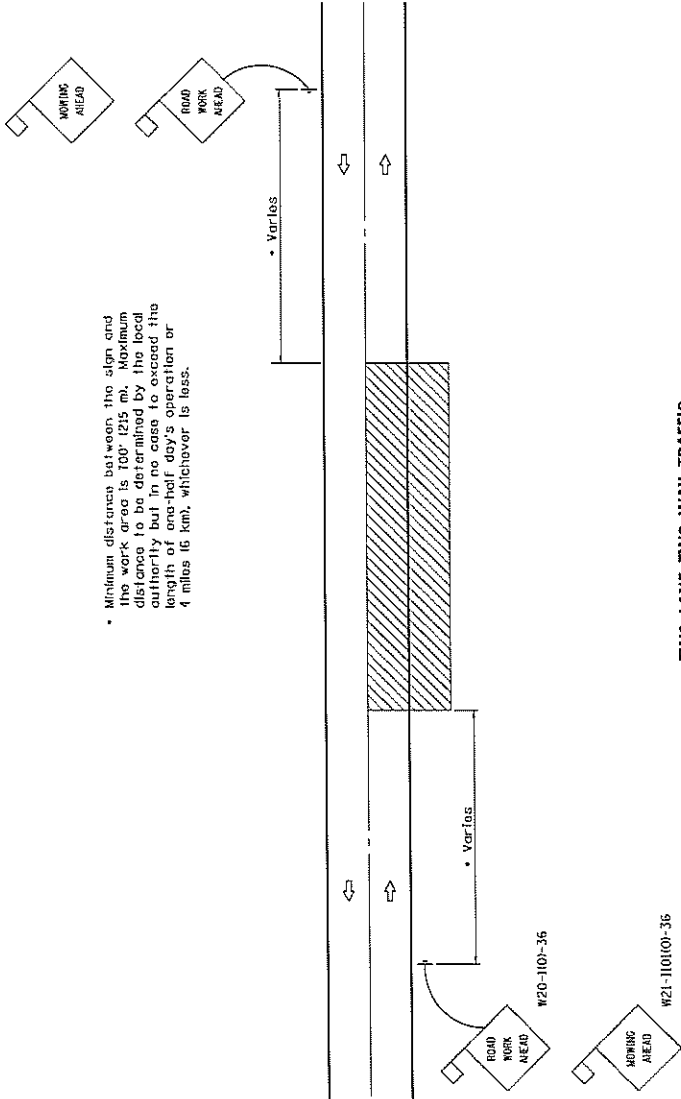

- Minimum distance between the sign and the work area is 700' (215 m). Maximum distance to be determined by the local authority but in no case to exceed the length of one-half day's operation or 4 miles (6 km), whichever is less.

**TWO-LANE, TWO-WAY TRAFFIC
RURAL OPERATIONS ONLY
DAY OPERATIONS ONLY**

SYMBOLS

- Mark area
- Sign with 18x18 (450x450) mm or orange flag attached.

TYPICAL APPLICATIONS

- MORNING
- SPREADING AGGREGATE
- WEED SPRAYING
- SURFACE MAINTENANCE
- BITUMINOUS RESURFACING
- CRACK POURING
- SHOULDER REPAIR
- CLEANING DITCHES

GENERAL NOTES

Maintenance operations shall be confined to one traffic lane, leaving the opposite lane open to traffic. At least 500' (150 m) of both traffic lanes shall be available for traffic movement between work areas at intervals not greater than 1000' (300 m).

When operations are on the pavement and stationary or moving at a speed less than 4 mph (6 kph), a ONE LANE AHEAD, or other appropriate sign, shall be installed in each direction between the ROAD WORK AHEAD sign and the work area. The distance between this sign and the work area shall be a minimum of 400' (120 m) but in no case to exceed the length of one-half day's operation or 4 miles (6 km), whichever is less. The distance between the two signs shall be approximately 400' (120 m).

All signs are to be removed at completion of the day's operation.

Any unattended obstacle, excavation, or pavement drop off greater than 3 (75) in the work area shall be protected by Type I or Type II barricades with flashing lights.

Longitudinal dimensions may be adjusted slightly to fit field conditions.

All vehicles, equipment, men, and their activities are restricted at all times to one side of the pavement.

Flashing lights or rotating beacons are required for all maintenance vehicles while in operation.

Applicable operations illustrated in Standard 701301 and 701302 when operations do not exceed 15 minutes on the pavement or 60 minutes on the shoulder respectively.

All warning signs shall have minimum dimensions of 36x36 (900x900) and have black legend on an orange reflectorized background.

When fluorescent signs are used, orange flags are not required.

This case is for use on rural local roads where the local authority considers this protection to be appropriate for the specific job conditions.

All dimensions are in inches (millimeters) unless otherwise shown.

DATE	REVISIONS
1-1-35	Corrected RWA sign number.
1-1-09	Switched units to English metric. Moved one General Note.

**TRAFFIC CONTROL DEVICES—
DAY LABOR MAINTENANCE**

STANDARD B.L.R. 16-6

Illinois Department of Transportation
 APPROVED January 1, 2005
 ENGINEER OF DESIGN AND CONSTRUCTION
 APPROVED January 1, 2005
 ENGINEER OF DESIGN AND CONSTRUCTION
 ISSUED 1-1-97

CONDITION II
APPROACH TRAFFIC
DOES NOT STOP

CONDITION I
APPROACH TRAFFIC STOPPED

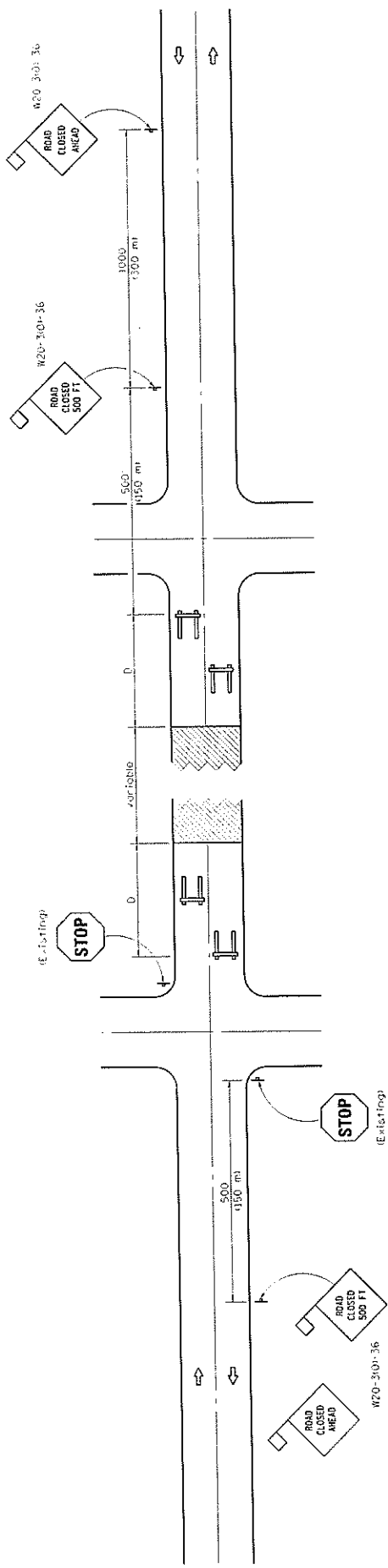

SYMBOLS

- Work area
- Type III Barricade
- Sign with 18x18 (450x450) min. orange flag attached

GENERAL NOTES

Type III Barricades and RII-4-6030 signs shall be positioned as shown in the Road Closure to All Traffic detail on Highway Standard 701901. If the distance to exceed 500 ft (150 m), an additional set of barricades and RII-4-6030 shall be placed at each end of the work area.

Two Type A Low Intensity Flashing Lights shall be used on each approach in advance of the work area. One light shall be installed above each barricade. If only one barricade is required, the other light shall be installed above the first advance warning sign.

All warning signs shall have minimum dimensions of 36 x 36 (900 x 900) and have a black legend on an orange reflectorized background.

When fluorescent signs are used, orange flags are not required.

Longitudinal dimensions may be adjusted to fit field conditions.

All dimensions are in inches (millimeters), unless other wise shown.

DATE	REVISIONS
1-1-12	Omitted two notes from GENERAL NOTES.
1-1-03	Revised General Note's and switched units to English metrics.

TYPICAL APPLICATION OF TRAFFIC CONTROL DEVICES FOR CONSTRUCTION ON RURAL LOCAL HIGHWAYS (TWO-LANE TWO WAY TRAFFIC) (ROAD CLOSED TO TRU TRAFFIC)

STANDARD B.L.R.-22-7

Mississippi Department of Transportation

APPROVED: _____ DATE: 012

ENGINEER OF TRUCK ROADS AND SURVEY

APPROVED: _____ DATE: 011

ENGINEER OF TRUCK ROADS AND SURVEY

ISSUED: 1: 97

REQUIRED CONTRACT PROVISIONS FEDERAL-AID CONSTRUCTION CONTRACTS

- I. General
- II. Nondiscrimination
- III. Nonsegregated Facilities
- IV. Davis-Bacon and Related Act Provisions
- V. Contract Work Hours and Safety Standards Act Provisions
- VI. Subletting or Assigning the Contract
- VII. Safety: Accident Prevention
- VIII. False Statements Concerning Highway Projects
- IX. Implementation of Clean Air Act and Federal Water Pollution Control Act
- X. Compliance with Governmentwide Suspension and Debarment Requirements
- XI. Certification Regarding Use of Contract Funds for Lobbying

ATTACHMENTS

A. Employment and Materials Preference for Appalachian Development Highway System or Appalachian Local Access Road Contracts (included in Appalachian contracts only)

I. GENERAL

1. Form FHWA-1273 must be physically incorporated in each construction contract funded under Title 23 (excluding emergency contracts solely intended for debris removal). The contractor (or subcontractor) must insert this form in each subcontract and further require its inclusion in all lower tier subcontracts (excluding purchase orders, rental agreements and other agreements for supplies or services).

The applicable requirements of Form FHWA-1273 are incorporated by reference for work done under any purchase order, rental agreement or agreement for other services. The prime contractor shall be responsible for compliance by any subcontractor, lower-tier subcontractor or service provider.

Form FHWA-1273 must be included in all Federal-aid design-build contracts, in all subcontracts and in lower tier subcontracts (excluding subcontracts for design services, purchase orders, rental agreements and other agreements for supplies or services). The design-builder shall be responsible for compliance by any subcontractor, lower-tier subcontractor or service provider.

Contracting agencies may reference Form FHWA-1273 in bid proposal or request for proposal documents, however, the Form FHWA-1273 must be physically incorporated (not referenced) in all contracts, subcontracts and lower-tier subcontracts (excluding purchase orders, rental agreements and other agreements for supplies or services related to a construction contract).

2. Subject to the applicability criteria noted in the following sections, these contract provisions shall apply to all work performed on the contract by the contractor's own organization and with the assistance of workers under the contractor's immediate superintendence and to all work performed on the contract by piecework, station work, or by subcontract.

3. A breach of any of the stipulations contained in these Required Contract Provisions may be sufficient grounds for withholding of progress payments, withholding of final payment, termination of the contract, suspension / debarment or any other action determined to be appropriate by the contracting agency and FHWA.

4. Selection of Labor: During the performance of this contract, the contractor shall not use convict labor for any purpose within the limits of a construction project on a Federal-aid highway unless it is labor performed by convicts who are on parole, supervised release, or probation. The term Federal-aid highway does not include roadways functionally classified as local roads or rural minor collectors.

II. NONDISCRIMINATION

The provisions of this section related to 23 CFR Part 230 are applicable to all Federal-aid construction contracts and to all related construction subcontracts of \$10,000 or more. The provisions of 23 CFR Part 230 are not applicable to material supply, engineering, or architectural service contracts.

In addition, the contractor and all subcontractors must comply with the following policies: Executive Order 11246, 41 CFR 60, 29 CFR 1625-1627, Title 23 USC Section 140, the Rehabilitation Act of 1973, as amended (29 USC 794), Title VI of the Civil Rights Act of 1964, as amended, and related regulations including 49 CFR Parts 21, 26 and 27; and 23 CFR Parts 200, 230, and 633.

The contractor and all subcontractors must comply with: the requirements of the Equal Opportunity Clause in 41 CFR 60-1.4(b) and, for all construction contracts exceeding \$10,000, the Standard Federal Equal Employment Opportunity Construction Contract Specifications in 41 CFR 60-4.3.

Note: The U.S. Department of Labor has exclusive authority to determine compliance with Executive Order 11246 and the policies of the Secretary of Labor including 41 CFR 60, and 29 CFR 1625-1627. The contracting agency and the FHWA have the authority and the responsibility to ensure compliance with Title 23 USC Section 140, the Rehabilitation Act of 1973, as amended (29 USC 794), and Title VI of the Civil Rights Act of 1964, as amended, and related regulations including 49 CFR Parts 21, 26 and 27; and 23 CFR Parts 200, 230, and 633.

The following provision is adopted from 23 CFR 230, Appendix A, with appropriate revisions to conform to the U.S. Department of Labor (US DOL) and FHWA requirements.

1. Equal Employment Opportunity: Equal employment opportunity (EEO) requirements not to discriminate and to take affirmative action to assure equal opportunity as set forth under laws, executive orders, rules, regulations (28 CFR 35, 29 CFR 1630, 29 CFR 1625-1627, 41 CFR 60 and 49 CFR 27) and orders of the Secretary of Labor as modified by the provisions prescribed herein, and imposed pursuant to 23 U.S.C. 140 shall constitute the EEO and specific affirmative action standards for the contractor's project activities under this contract. The provisions of the Americans with Disabilities Act of 1990 (42 U.S.C. 12101 et seq.) set forth under 28 CFR 35 and 29 CFR 1630 are incorporated by reference in this contract. In the execution of this contract, the contractor agrees to comply with the following minimum specific requirement activities of EEO:

a. The contractor will work with the contracting agency and the Federal Government to ensure that it has made every good faith effort to provide equal opportunity with respect to all of its terms and conditions of employment and in their review of activities under the contract.

b. The contractor will accept as its operating policy the following statement:

"It is the policy of this Company to assure that applicants are employed, and that employees are treated during employment, without regard to their race, religion, sex, color, national origin, age or disability. Such action shall include: employment, upgrading, demotion, or transfer; recruitment or recruitment advertising; layoff or termination; rates of pay or other forms of compensation; and selection for training, including apprenticeship, pre-apprenticeship, and/or on-the-job training."

2. EEO Officer: The contractor will designate and make known to the contracting officers an EEO Officer who will have the responsibility for and must be capable of effectively administering and promoting an active EEO program and who must be assigned adequate authority and responsibility to do so.

3. Dissemination of Policy: All members of the contractor's staff who are authorized to hire, supervise, promote, and discharge employees, or who recommend such action, or who are substantially involved in such action, will be made fully cognizant of, and will implement, the contractor's EEO policy and contractual responsibilities to provide EEO in each grade and classification of employment. To ensure that the above agreement will be met, the following actions will be taken as a minimum:

a. Periodic meetings of supervisory and personnel office employees will be conducted before the start of work and then not less often than once every six months, at which time the contractor's EEO policy and its implementation will be reviewed and explained. The meetings will be conducted by the EEO Officer.

b. All new supervisory or personnel office employees will be given a thorough indoctrination by the EEO Officer, covering all major aspects of the contractor's EEO obligations within thirty days following their reporting for duty with the contractor.

c. All personnel who are engaged in direct recruitment for the project will be instructed by the EEO Officer in the contractor's procedures for locating and hiring minorities and women.

d. Notices and posters setting forth the contractor's EEO policy will be placed in areas readily accessible to employees, applicants for employment and potential employees.

e. The contractor's EEO policy and the procedures to implement such policy will be brought to the attention of employees by means of meetings, employee handbooks, or other appropriate means.

4. Recruitment: When advertising for employees, the contractor will include in all advertisements for employees the notation: "An Equal Opportunity Employer." All such advertisements will be placed in publications having a large circulation among minorities and women in the area from which the project work force would normally be derived.

a. The contractor will, unless precluded by a valid bargaining agreement, conduct systematic and direct recruitment through public and private employee referral sources likely to yield qualified minorities and women. To meet this requirement, the contractor will identify sources of potential minority group employees, and establish with such identified sources procedures whereby minority and women applicants may be referred to the contractor for employment consideration.

b. In the event the contractor has a valid bargaining agreement providing for exclusive hiring hall referrals, the contractor is expected to observe the provisions of that agreement to the extent that the system meets the contractor's compliance with EEO contract provisions. Where implementation of such an agreement has the effect of discriminating against minorities or women, or obligates the contractor to do the same, such implementation violates Federal nondiscrimination provisions.

c. The contractor will encourage its present employees to refer minorities and women as applicants for employment. Information and procedures with regard to referring such applicants will be discussed with employees.

5. Personnel Actions: Wages, working conditions, and employee benefits shall be established and administered, and personnel actions of every type, including hiring, upgrading, promotion, transfer, demotion, layoff, and termination, shall be taken without regard to race, color, religion, sex, national origin, age or disability. The following procedures shall be followed:

a. The contractor will conduct periodic inspections of project sites to insure that working conditions and employee facilities do not indicate discriminatory treatment of project site personnel.

b. The contractor will periodically evaluate the spread of wages paid within each classification to determine any evidence of discriminatory wage practices.

c. The contractor will periodically review selected personnel actions in depth to determine whether there is evidence of discrimination. Where evidence is found, the contractor will promptly take corrective action. If

the review indicates that the discrimination may extend beyond the actions reviewed, such corrective action shall include all affected persons.

d. The contractor will promptly investigate all complaints of alleged discrimination made to the contractor in connection with its obligations under this contract, will attempt to resolve such complaints, and will take appropriate corrective action within a reasonable time. If the investigation indicates that the discrimination may affect persons other than the complainant, such corrective action shall include such other persons. Upon completion of each investigation, the contractor will inform every complainant of all of their avenues of appeal.

6. Training and Promotion:

a. The contractor will assist in locating, qualifying, and increasing the skills of minorities and women who are applicants for employment or current employees. Such efforts should be aimed at developing full journey level status employees in the type of trade or job classification involved.

b. Consistent with the contractor's work force requirements and as permissible under Federal and State regulations, the contractor shall make full use of training programs, i.e., apprenticeship, and on-the-job training programs for the geographical area of contract performance. In the event a special provision for training is provided under this contract, this subparagraph will be superseded as indicated in the special provision. The contracting agency may reserve training positions for persons who receive welfare assistance in accordance with 23 U.S.C. 140(a).

c. The contractor will advise employees and applicants for employment of available training programs and entrance requirements for each.

d. The contractor will periodically review the training and promotion potential of employees who are minorities and women and will encourage eligible employees to apply for such training and promotion.

7. Unions: If the contractor relies in whole or in part upon unions as a source of employees, the contractor will use good faith efforts to obtain the cooperation of such unions to increase opportunities for minorities and women. Actions by the contractor, either directly or through a contractor's association acting as agent, will include the procedures set forth below:

a. The contractor will use good faith efforts to develop, in cooperation with the unions, joint training programs aimed toward qualifying more minorities and women for membership in the unions and increasing the skills of minorities and women so that they may qualify for higher paying employment.

b. The contractor will use good faith efforts to incorporate an EEO clause into each union agreement to the end that such union will be contractually bound to refer applicants without regard to their race, color, religion, sex, national origin, age or disability.

c. The contractor is to obtain information as to the referral practices and policies of the labor union except that to the extent such information is within the exclusive possession of the labor union and such labor union refuses to furnish such information to the contractor, the contractor shall so certify to the contracting agency and shall set forth what efforts have been made to obtain such information.

d. In the event the union is unable to provide the contractor with a reasonable flow of referrals within the time limit set forth in the collective bargaining agreement, the contractor will, through independent recruitment efforts, fill the employment vacancies without regard to race, color, religion, sex, national origin, age or disability; making full efforts to obtain qualified and/or qualifiable minorities and women. The failure of a union to provide sufficient referrals (even though it is obligated to provide exclusive referrals under the terms of a collective bargaining agreement) does not relieve the contractor from the requirements of this paragraph. In the event the union referral practice prevents the contractor from meeting the obligations pursuant to Executive Order 11246, as amended, and these special provisions, such contractor shall immediately notify the contracting agency.

8. Reasonable Accommodation for Applicants / Employees with Disabilities: The contractor must be familiar with the requirements for and comply with the Americans with Disabilities Act and all rules and regulations established there under. Employers must provide reasonable accommodation in all employment activities unless to do so would cause an undue hardship.

9. Selection of Subcontractors, Procurement of Materials and Leasing of Equipment: The contractor shall not discriminate on the grounds of race, color, religion, sex, national origin, age or disability in the selection and retention of subcontractors, including procurement of materials and leases of equipment. The contractor shall take all necessary and reasonable steps to ensure nondiscrimination in the administration of this contract.

a. The contractor shall notify all potential subcontractors and suppliers and lessors of their EEO obligations under this contract.

b. The contractor will use good faith efforts to ensure subcontractor compliance with their EEO obligations.

10. Assurance Required by 49 CFR 26.13(b):

a. The requirements of 49 CFR Part 26 and the State DOT's U.S. DOT-approved DBE program are incorporated by reference.

b. The contractor or subcontractor shall not discriminate on the basis of race, color, national origin, or sex in the performance of this contract. The contractor shall carry out applicable requirements of 49 CFR Part 26 in the award and administration of DOT-assisted contracts. Failure by the contractor to carry out these requirements is a material breach of this contract, which may result in the termination of this contract or such other remedy as the contracting agency deems appropriate.

11. Records and Reports: The contractor shall keep such records as necessary to document compliance with the EEO requirements. Such records shall be retained for a period of three years following the date of the final payment to the contractor for all contract work and shall be available at reasonable times and places for inspection by authorized representatives of the contracting agency and the FHWA.

a. The records kept by the contractor shall document the following:

(1) The number and work hours of minority and non-minority group members and women employed in each work classification on the project;

(2) The progress and efforts being made in cooperation with unions, when applicable, to increase employment opportunities for minorities and women; and

(3) The progress and efforts being made in locating, hiring, training, qualifying, and upgrading minorities and women;

b. The contractors and subcontractors will submit an annual report to the contracting agency each July for the duration of the project, indicating the number of minority, women, and non-minority group employees currently engaged in each work classification required by the contract work. This information is to be reported on [Form FHWA-1391](#). The staffing data should represent the project work force on board in all or any part of the last payroll period preceding the end of July. If on-the-job training is being required by special provision, the contractor will be required to collect and report training data. The employment data should reflect the work force on board during all or any part of the last payroll period preceding the end of July.

III. NONSEGREGATED FACILITIES

This provision is applicable to all Federal-aid construction contracts and to all related construction subcontracts of \$10,000 or more.

The contractor must ensure that facilities provided for employees are provided in such a manner that segregation on the basis of race, color,

religion, sex, or national origin cannot result. The contractor may neither require such segregated use by written or oral policies nor tolerate such use by employee custom. The contractor's obligation extends further to ensure that its employees are not assigned to perform their services at any location, under the contractor's control, where the facilities are segregated. The term "facilities" includes waiting rooms, work areas, restaurants and other eating areas, time clocks, restrooms, washrooms, locker rooms, and other storage or dressing areas, parking lots, drinking fountains, recreation or entertainment areas, transportation, and housing provided for employees. The contractor shall provide separate or single-user restrooms and necessary dressing or sleeping areas to assure privacy between sexes.

IV. Davis-Bacon and Related Act Provisions

This section is applicable to all Federal-aid construction projects exceeding \$2,000 and to all related subcontracts and lower-tier subcontracts (regardless of subcontract size). The requirements apply to all projects located within the right-of-way of a roadway that is functionally classified as Federal-aid highway. This excludes roadways functionally classified as local roads or rural minor collectors, which are exempt. Contracting agencies may elect to apply these requirements to other projects.

The following provisions are from the U.S. Department of Labor regulations in 29 CFR 5.5 "Contract provisions and related matters" with minor revisions to conform to the FHWA-1273 format and FHWA program requirements.

1. Minimum wages

a. All laborers and mechanics employed or working upon the site of the work, will be paid unconditionally and not less often than once a week, and without subsequent deduction or rebate on any account (except such payroll deductions as are permitted by regulations issued by the Secretary of Labor under the Copeland Act (29 CFR part 3)), the full amount of wages and bona fide fringe benefits (or cash equivalents thereof) due at time of payment computed at rates not less than those contained in the wage determination of the Secretary of Labor which is attached hereto and made a part hereof, regardless of any contractual relationship which may be alleged to exist between the contractor and such laborers and mechanics.

Contributions made or costs reasonably anticipated for bona fide fringe benefits under section 1(b)(2) of the Davis-Bacon Act on behalf of laborers or mechanics are considered wages paid to such laborers or mechanics, subject to the provisions of paragraph 1.d. of this section; also, regular contributions made or costs incurred for more than a weekly period (but not less often than quarterly) under plans, funds, or programs which cover the particular weekly period, are deemed to be constructively made or incurred during such weekly period. Such laborers and mechanics shall be paid the appropriate wage rate and fringe benefits on the wage determination for the classification of work actually performed, without regard to skill, except as provided in 29 CFR 5.5(a)(4). Laborers or mechanics performing work in more than one classification may be compensated at the rate specified for each classification for the time actually worked therein: Provided, That the employer's payroll records accurately set forth the time spent in each classification in which work is performed. The wage determination (including any additional classification and wage rates conformed under paragraph 1.b. of this section) and the Davis-Bacon poster (WH-1321) shall be posted at all times by the contractor and its subcontractors at the site of the work in a prominent and accessible place where it can be easily seen by the workers.

b.(1) The contracting officer shall require that any class of laborers or mechanics, including helpers, which is not listed in the wage determination and which is to be employed under the contract shall be classified in conformance with the wage determination. The contracting officer shall approve an additional classification and wage rate and fringe benefits therefore only when the following criteria have been met:

(i) The work to be performed by the classification requested is not performed by a classification in the wage determination; and

(ii) The classification is utilized in the area by the construction industry; and

(iii) The proposed wage rate, including any bona fide fringe benefits, bears a reasonable relationship to the wage rates contained in the wage determination.

(2) If the contractor and the laborers and mechanics to be employed in the classification (if known), or their representatives, and the contracting officer agree on the classification and wage rate (including the amount designated for fringe benefits where appropriate), a report of the action taken shall be sent by the contracting officer to the Administrator of the Wage and Hour Division, Employment Standards Administration, U.S. Department of Labor, Washington, DC 20210. The Administrator, or an authorized representative, will approve, modify, or disapprove every additional classification action within 30 days of receipt and so advise the contracting officer or will notify the contracting officer within the 30-day period that additional time is necessary.

(3) In the event the contractor, the laborers or mechanics to be employed in the classification or their representatives, and the contracting officer do not agree on the proposed classification and wage rate (including the amount designated for fringe benefits, where appropriate), the contracting officer shall refer the questions, including the views of all interested parties and the recommendation of the contracting officer, to the Wage and Hour Administrator for determination. The Wage and Hour Administrator, or an authorized representative, will issue a determination within 30 days of receipt and so advise the contracting officer or will notify the contracting officer within the 30-day period that additional time is necessary.

(4) The wage rate (including fringe benefits where appropriate) determined pursuant to paragraphs 1.b.(2) or 1.b.(3) of this section, shall be paid to all workers performing work in the classification under this contract from the first day on which work is performed in the classification.

c. Whenever the minimum wage rate prescribed in the contract for a class of laborers or mechanics includes a fringe benefit which is not expressed as an hourly rate, the contractor shall either pay the benefit as stated in the wage determination or shall pay another bona fide fringe benefit or an hourly cash equivalent thereof.

d. If the contractor does not make payments to a trustee or other third person, the contractor may consider as part of the wages of any laborer or mechanic the amount of any costs reasonably anticipated in providing bona fide fringe benefits under a plan or program, Provided, That the Secretary of Labor has found, upon the written request of the contractor, that the applicable standards of the Davis-Bacon Act have been met. The Secretary of Labor may require the contractor to set aside in a separate account assets for the meeting of obligations under the plan or program.

2. Withholding

The contracting agency shall upon its own action or upon written request of an authorized representative of the Department of Labor, withhold or cause to be withheld from the contractor under this contract, or any other Federal contract with the same prime contractor, or any other federally-assisted contract subject to Davis-Bacon prevailing wage requirements, which is held by the same prime contractor, so much of the accrued payments or advances as may be considered necessary to pay laborers and mechanics, including apprentices, trainees, and helpers, employed by the contractor or any subcontractor the full amount of wages required by the contract. In the event of failure to pay any laborer or mechanic, including any apprentice, trainee, or helper, employed or working on the site of the work, all or part of the wages required by the contract, the contracting agency may, after written notice to the contractor, take such

action as may be necessary to cause the suspension of any further payment, advance, or guarantee of funds until such violations have ceased.

3. Payrolls and basic records

a. Payrolls and basic records relating thereto shall be maintained by the contractor during the course of the work and preserved for a period of three years thereafter for all laborers and mechanics working at the site of the work. Such records shall contain the name, address, and social security number of each such worker, his or her correct classification, hourly rates of wages paid (including rates of contributions or costs anticipated for bona fide fringe benefits or cash equivalents thereof of the types described in section 1(b)(2)(B) of the Davis-Bacon Act), daily and weekly number of hours worked, deductions made and actual wages paid. Whenever the Secretary of Labor has found under 29 CFR 5.5(a)(1)(iv) that the wages of any laborer or mechanic include the amount of any costs reasonably anticipated in providing benefits under a plan or program described in section 1(b)(2)(B) of the Davis-Bacon Act, the contractor shall maintain records which show that the commitment to provide such benefits is enforceable, that the plan or program is financially responsible, and that the plan or program has been communicated in writing to the laborers or mechanics affected, and records which show the costs anticipated or the actual cost incurred in providing such benefits. Contractors employing apprentices or trainees under approved programs shall maintain written evidence of the registration of apprenticeship programs and certification of trainee programs, the registration of the apprentices and trainees, and the ratios and wage rates prescribed in the applicable programs.

b. (1) The contractor shall submit weekly for each week in which any contract work is performed a copy of all payrolls to the contracting agency. The payrolls submitted shall set out accurately and completely all of the information required to be maintained under 29 CFR 5.5(a)(3)(i), except that full social security numbers and home addresses shall not be included on weekly transmittals. Instead the payrolls shall only need to include an individually identifying number for each employee (e.g. , the last four digits of the employee's social security number). The required weekly payroll information may be submitted in any form desired. Optional Form WH-347 is available for this purpose from the Wage and Hour Division Web site at <http://www.dol.gov/esa/whd/forms/wh347instr.htm> or its successor site. The prime contractor is responsible for the submission of copies of payrolls by all subcontractors. Contractors and subcontractors shall maintain the full social security number and current address of each covered worker, and shall provide them upon request to the contracting agency for transmission to the State DOT, the FHWA or the Wage and Hour Division of the Department of Labor for purposes of an investigation or audit of compliance with prevailing wage requirements. It is not a violation of this section for a prime contractor to require a subcontractor to provide addresses and social security numbers to the prime contractor for its own records, without weekly submission to the contracting agency..

(2) Each payroll submitted shall be accompanied by a "Statement of Compliance," signed by the contractor or subcontractor or his or her agent who pays or supervises the payment of the persons employed under the contract and shall certify the following:

(i) That the payroll for the payroll period contains the information required to be provided under §5.5 (a)(3)(ii) of Regulations, 29 CFR part 5, the appropriate information is being maintained under §5.5 (a)(3)(i) of Regulations, 29 CFR part 5, and that such information is correct and complete;

(ii) That each laborer or mechanic (including each helper, apprentice, and trainee) employed on the contract during the payroll period has been paid the full weekly wages earned, without rebate, either directly or indirectly, and that no deductions have been made either directly or indirectly from the full wages earned, other than permissible deductions as set forth in Regulations, 29 CFR part 3;

(iii) That each laborer or mechanic has been paid not less than the applicable wage rates and fringe benefits or cash equivalents for the classification of work performed, as specified in the applicable wage determination incorporated into the contract.

(3) The weekly submission of a properly executed certification set forth on the reverse side of Optional Form WH-347 shall satisfy the requirement for submission of the "Statement of Compliance" required by paragraph 3.b.(2) of this section.

(4) The falsification of any of the above certifications may subject the contractor or subcontractor to civil or criminal prosecution under section 1001 of title 18 and section 231 of title 31 of the United States Code.

c. The contractor or subcontractor shall make the records required under paragraph 3.a. of this section available for inspection, copying, or transcription by authorized representatives of the contracting agency, the State DOT, the FHWA, or the Department of Labor, and shall permit such representatives to interview employees during working hours on the job. If the contractor or subcontractor fails to submit the required records or to make them available, the FHWA may, after written notice to the contractor, the contracting agency or the State DOT, take such action as may be necessary to cause the suspension of any further payment, advance, or guarantee of funds. Furthermore, failure to submit the required records upon request or to make such records available may be grounds for debarment action pursuant to 29 CFR 5.12.

4. Apprentices and trainees

a. Apprentices (programs of the USDOL).

Apprentices will be permitted to work at less than the predetermined rate for the work they performed when they are employed pursuant to and individually registered in a bona fide apprenticeship program registered with the U.S. Department of Labor, Employment and Training Administration, Office of Apprenticeship Training, Employer and Labor Services, or with a State Apprenticeship Agency recognized by the Office, or if a person is employed in his or her first 90 days of probationary employment as an apprentice in such an apprenticeship program, who is not individually registered in the program, but who has been certified by the Office of Apprenticeship Training, Employer and Labor Services or a State Apprenticeship Agency (where appropriate) to be eligible for probationary employment as an apprentice.

The allowable ratio of apprentices to journeymen on the job site in any craft classification shall not be greater than the ratio permitted to the contractor as to the entire work force under the registered program. Any worker listed on a payroll at an apprentice wage rate, who is not registered or otherwise employed as stated above, shall be paid not less than the applicable wage rate on the wage determination for the classification of work actually performed. In addition, any apprentice performing work on the job site in excess of the ratio permitted under the registered program shall be paid not less than the applicable wage rate on the wage determination for the work actually performed. Where a contractor is performing construction on a project in a locality other than that in which its program is registered, the ratios and wage rates (expressed in percentages of the journeyman's hourly rate) specified in the contractor's or subcontractor's registered program shall be observed.

Every apprentice must be paid at not less than the rate specified in the registered program for the apprentice's level of progress, expressed as a percentage of the journeymen hourly rate specified in the applicable wage determination. Apprentices shall be paid fringe benefits in accordance with the provisions of the apprenticeship program. If the apprenticeship program does not specify fringe benefits, apprentices must be paid the full amount of fringe benefits listed on the wage determination for the applicable classification. If the Administrator determines that a different practice prevails for the applicable apprentice classification, fringes shall be paid in accordance with that determination.

In the event the Office of Apprenticeship Training, Employer and Labor Services, or a State Apprenticeship Agency recognized by the Office, withdraws approval of an apprenticeship program, the contractor will no longer be permitted to utilize apprentices at less than the applicable predetermined rate for the work performed until an acceptable program is approved.

b. Trainees (programs of the USDOL).

Except as provided in 29 CFR 5.16, trainees will not be permitted to work at less than the predetermined rate for the work performed unless they are employed pursuant to and individually registered in a program which has received prior approval, evidenced by formal certification by the U.S. Department of Labor, Employment and Training Administration.

The ratio of trainees to journeymen on the job site shall not be greater than permitted under the plan approved by the Employment and Training Administration.

Every trainee must be paid at not less than the rate specified in the approved program for the trainee's level of progress, expressed as a percentage of the journeyman hourly rate specified in the applicable wage determination. Trainees shall be paid fringe benefits in accordance with the provisions of the trainee program. If the trainee program does not mention fringe benefits, trainees shall be paid the full amount of fringe benefits listed on the wage determination unless the Administrator of the Wage and Hour Division determines that there is an apprenticeship program associated with the corresponding journeyman wage rate on the wage determination which provides for less than full fringe benefits for apprentices. Any employee listed on the payroll at a trainee rate who is not registered and participating in a training plan approved by the Employment and Training Administration shall be paid not less than the applicable wage rate on the wage determination for the classification of work actually performed. In addition, any trainee performing work on the job site in excess of the ratio permitted under the registered program shall be paid not less than the applicable wage rate on the wage determination for the work actually performed.

In the event the Employment and Training Administration withdraws approval of a training program, the contractor will no longer be permitted to utilize trainees at less than the applicable predetermined rate for the work performed until an acceptable program is approved.

c. Equal employment opportunity. The utilization of apprentices, trainees and journeymen under this part shall be in conformity with the equal employment opportunity requirements of Executive Order 11246, as amended, and 29 CFR part 30.

d. Apprentices and Trainees (programs of the U.S. DOT).

Apprentices and trainees working under apprenticeship and skill training programs which have been certified by the Secretary of Transportation as promoting EEO in connection with Federal-aid highway construction programs are not subject to the requirements of paragraph 4 of this Section IV. The straight time hourly wage rates for apprentices and trainees under such programs will be established by the particular programs. The ratio of apprentices and trainees to journeymen shall not be greater than permitted by the terms of the particular program.

5. Compliance with Copeland Act requirements. The contractor shall comply with the requirements of 29 CFR part 3, which are incorporated by reference in this contract.

6. Subcontracts. The contractor or subcontractor shall insert Form FHWA-1273 in any subcontracts and also require the subcontractors to include Form FHWA-1273 in any lower tier subcontracts. The prime contractor shall be responsible for the compliance by any subcontractor or lower tier subcontractor with all the contract clauses in 29 CFR 5.5.

7. Contract termination: debarment. A breach of the contract clauses in 29 CFR 5.5 may be grounds for termination of the contract, and for

debarment as a contractor and a subcontractor as provided in 29 CFR 5.12.

8. Compliance with Davis-Bacon and Related Act requirements. All rulings and interpretations of the Davis-Bacon and Related Acts contained in 29 CFR parts 1, 3, and 5 are herein incorporated by reference in this contract.

9. Disputes concerning labor standards. Disputes arising out of the labor standards provisions of this contract shall not be subject to the general disputes clause of this contract. Such disputes shall be resolved in accordance with the procedures of the Department of Labor set forth in 29 CFR parts 5, 6, and 7. Disputes within the meaning of this clause include disputes between the contractor (or any of its subcontractors) and the contracting agency, the U.S. Department of Labor, or the employees or their representatives.

10. Certification of eligibility.

a. By entering into this contract, the contractor certifies that neither it (nor he or she) nor any person or firm who has an interest in the contractor's firm is a person or firm ineligible to be awarded Government contracts by virtue of section 3(a) of the Davis-Bacon Act or 29 CFR 5.12(a)(1).

b. No part of this contract shall be subcontracted to any person or firm ineligible for award of a Government contract by virtue of section 3(a) of the Davis-Bacon Act or 29 CFR 5.12(a)(1).

c. The penalty for making false statements is prescribed in the U.S. Criminal Code, 18 U.S.C. 1001.

V. CONTRACT WORK HOURS AND SAFETY STANDARDS ACT

The following clauses apply to any Federal-aid construction contract in an amount in excess of \$100,000 and subject to the overtime provisions of the Contract Work Hours and Safety Standards Act. These clauses shall be inserted in addition to the clauses required by 29 CFR 5.5(a) or 29 CFR 4.6. As used in this paragraph, the terms laborers and mechanics include watchmen and guards.

1. Overtime requirements. No contractor or subcontractor contracting for any part of the contract work which may require or involve the employment of laborers or mechanics shall require or permit any such laborer or mechanic in any workweek in which he or she is employed on such work to work in excess of forty hours in such workweek unless such laborer or mechanic receives compensation at a rate not less than one and one-half times the basic rate of pay for all hours worked in excess of forty hours in such workweek.

2. Violation; liability for unpaid wages; liquidated damages. In the event of any violation of the clause set forth in paragraph (1.) of this section, the contractor and any subcontractor responsible therefor shall be liable for the unpaid wages. In addition, such contractor and subcontractor shall be liable to the United States (in the case of work done under contract for the District of Columbia or a territory, to such District or to such territory), for liquidated damages. Such liquidated damages shall be computed with respect to each individual laborer or mechanic, including watchmen and guards, employed in violation of the clause set forth in paragraph (1.) of this section, in the sum of \$10 for each calendar day on which such individual was required or permitted to work in excess of the standard workweek of forty hours without payment of the overtime wages required by the clause set forth in paragraph (1.) of this section.

3. Withholding for unpaid wages and liquidated damages. The FHWA or the contacting agency shall upon its own action or upon written request of an authorized representative of the Department of Labor withhold or cause to be withheld, from any moneys payable on account of work performed by the contractor or subcontractor under any such

contract or any other Federal contract with the same prime contractor, or any other federally-assisted contract subject to the Contract Work Hours and Safety Standards Act, which is held by the same prime contractor, such sums as may be determined to be necessary to satisfy any liabilities of such contractor or subcontractor for unpaid wages and liquidated damages as provided in the clause set forth in paragraph (2.) of this section.

4. Subcontracts. The contractor or subcontractor shall insert in any subcontracts the clauses set forth in paragraph (1.) through (4.) of this section and also a clause requiring the subcontractors to include these clauses in any lower tier subcontracts. The prime contractor shall be responsible for compliance by any subcontractor or lower tier subcontractor with the clauses set forth in paragraphs (1.) through (4.) of this section.

VI. SUBLETTING OR ASSIGNING THE CONTRACT

This provision is applicable to all Federal-aid construction contracts on the National Highway System.

1. The contractor shall perform with its own organization contract work amounting to not less than 30 percent (or a greater percentage if specified elsewhere in the contract) of the total original contract price, excluding any specialty items designated by the contracting agency. Specialty items may be performed by subcontract and the amount of any such specialty items performed may be deducted from the total original contract price before computing the amount of work required to be performed by the contractor's own organization (23 CFR 635.116).

a. The term "perform work with its own organization" refers to workers employed or leased by the prime contractor, and equipment owned or rented by the prime contractor, with or without operators. Such term does not include employees or equipment of a subcontractor or lower tier subcontractor, agents of the prime contractor, or any other assignees. The term may include payments for the costs of hiring leased employees from an employee leasing firm meeting all relevant Federal and State regulatory requirements. Leased employees may only be included in this term if the prime contractor meets all of the following conditions:

(1) the prime contractor maintains control over the supervision of the day-to-day activities of the leased employees;

(2) the prime contractor remains responsible for the quality of the work of the leased employees;

(3) the prime contractor retains all power to accept or exclude individual employees from work on the project; and

(4) the prime contractor remains ultimately responsible for the payment of predetermined minimum wages, the submission of payrolls, statements of compliance and all other Federal regulatory requirements.

b. "Specialty Items" shall be construed to be limited to work that requires highly specialized knowledge, abilities, or equipment not ordinarily available in the type of contracting organizations qualified and expected to bid or propose on the contract as a whole and in general are to be limited to minor components of the overall contract.

2. The contract amount upon which the requirements set forth in paragraph (1) of Section VI is computed includes the cost of material and manufactured products which are to be purchased or produced by the contractor under the contract provisions.

3. The contractor shall furnish (a) a competent superintendent or supervisor who is employed by the firm, has full authority to direct performance of the work in accordance with the contract requirements, and is in charge of all construction operations (regardless of who performs the work) and (b) such other of its own organizational resources (supervision, management, and engineering services) as the contracting officer determines is necessary to assure the performance of the contract.

4. No portion of the contract shall be sublet, assigned or otherwise disposed of except with the written consent of the contracting officer, or authorized representative, and such consent when given shall not be construed to relieve the contractor of any responsibility for the fulfillment of the contract. Written consent will be given only after the contracting agency has assured that each subcontract is evidenced in writing and that it contains all pertinent provisions and requirements of the prime contract.

5. The 30% self-performance requirement of paragraph (1) is not applicable to design-build contracts; however, contracting agencies may establish their own self-performance requirements.

VII. SAFETY: ACCIDENT PREVENTION

This provision is applicable to all Federal-aid construction contracts and to all related subcontracts.

1. In the performance of this contract the contractor shall comply with all applicable Federal, State, and local laws governing safety, health, and sanitation (23 CFR 635). The contractor shall provide all safeguards, safety devices and protective equipment and take any other needed actions as it determines, or as the contracting officer may determine, to be reasonably necessary to protect the life and health of employees on the job and the safety of the public and to protect property in connection with the performance of the work covered by the contract.

2. It is a condition of this contract, and shall be made a condition of each subcontract, which the contractor enters into pursuant to this contract, that the contractor and any subcontractor shall not permit any employee, in performance of the contract, to work in surroundings or under conditions which are unsanitary, hazardous or dangerous to his/her health or safety, as determined under construction safety and health standards (29 CFR 1926) promulgated by the Secretary of Labor, in accordance with Section 107 of the Contract Work Hours and Safety Standards Act (40 U.S.C. 3704).

3. Pursuant to 29 CFR 1926.3, it is a condition of this contract that the Secretary of Labor or authorized representative thereof, shall have right of entry to any site of contract performance to inspect or investigate the matter of compliance with the construction safety and health standards and to carry out the duties of the Secretary under Section 107 of the Contract Work Hours and Safety Standards Act (40 U.S.C.3704).

VIII. FALSE STATEMENTS CONCERNING HIGHWAY PROJECTS

This provision is applicable to all Federal-aid construction contracts and to all related subcontracts.

In order to assure high quality and durable construction in conformity with approved plans and specifications and a high degree of reliability on statements and representations made by engineers, contractors, suppliers, and workers on Federal-aid highway projects, it is essential that all persons concerned with the project perform their functions as carefully, thoroughly, and honestly as possible. Willful falsification, distortion, or misrepresentation with respect to any facts related to the project is a violation of Federal law. To prevent any misunderstanding regarding the seriousness of these and similar acts, Form FHWA-1022 shall be posted on each Federal-aid highway project (23 CFR 635) in one or more places where it is readily available to all persons concerned with the project:

18 U.S.C. 1020 reads as follows:

"Whoever, being an officer, agent, or employee of the United States, or of any State or Territory, or whoever, whether a person, association, firm, or corporation, knowingly makes any false statement, false representation, or false report as to the character, quality, quantity, or cost of the material used or to be used, or the quantity or quality of the work performed or to be performed, or the cost thereof in connection with the submission of plans, maps, specifications, contracts, or costs of construction on any highway or related project submitted for approval to the Secretary of Transportation; or

Whoever knowingly makes any false statement, false representation, false report or false claim with respect to the character, quality, quantity, or cost of any work performed or to be performed, or materials furnished or to be furnished, in connection with the construction of any highway or related project approved by the Secretary of Transportation; or

Whoever knowingly makes any false statement or false representation as to material fact in any statement, certificate, or report submitted pursuant to provisions of the Federal-aid Roads Act approved July 1, 1916, (39 Stat. 355), as amended and supplemented;

Shall be fined under this title or imprisoned not more than 5 years or both."

IX. IMPLEMENTATION OF CLEAN AIR ACT AND FEDERAL WATER POLLUTION CONTROL ACT

This provision is applicable to all Federal-aid construction contracts and to all related subcontracts.

By submission of this bid/proposal or the execution of this contract, or subcontract, as appropriate, the bidder, proposer, Federal-aid construction contractor, or subcontractor, as appropriate, will be deemed to have stipulated as follows:

1. That any person who is or will be utilized in the performance of this contract is not prohibited from receiving an award due to a violation of Section 508 of the Clean Water Act or Section 306 of the Clean Air Act.

2. That the contractor agrees to include or cause to be included the requirements of paragraph (1) of this Section X in every subcontract, and further agrees to take such action as the contracting agency may direct as a means of enforcing such requirements.

X. CERTIFICATION REGARDING DEBARMENT, SUSPENSION, INELIGIBILITY AND VOLUNTARY EXCLUSION

This provision is applicable to all Federal-aid construction contracts, design-build contracts, subcontracts, lower-tier subcontracts, purchase orders, lease agreements, consultant contracts or any other covered transaction requiring FHWA approval or that is estimated to cost \$25,000 or more – as defined in 2 CFR Parts 180 and 1200.

1. Instructions for Certification – First Tier Participants:

a. By signing and submitting this proposal, the prospective first tier participant is providing the certification set out below.

b. The inability of a person to provide the certification set out below will not necessarily result in denial of participation in this covered transaction. The prospective first tier participant shall submit an explanation of why it cannot provide the certification set out below. The certification or explanation will be considered in connection with the department or agency's determination whether to enter into this transaction. However, failure of the prospective first tier participant to furnish a certification or an explanation shall disqualify such a person from participation in this transaction.

c. The certification in this clause is a material representation of fact upon which reliance was placed when the contracting agency determined to enter into this transaction. If it is later determined that the prospective participant knowingly rendered an erroneous certification, in addition to other remedies available to the Federal Government, the contracting agency may terminate this transaction for cause of default.

d. The prospective first tier participant shall provide immediate written notice to the contracting agency to whom this proposal is submitted if any time the prospective first tier participant learns that its certification was erroneous when submitted or has become erroneous by reason of changed circumstances.

e. The terms "covered transaction," "debarred," "suspended," "ineligible," "participant," "person," "principal," and "voluntarily excluded,"

as used in this clause, are defined in 2 CFR Parts 180 and 1200. "First Tier Covered Transactions" refers to any covered transaction between a grantee or subgrantee of Federal funds and a participant (such as the prime or general contract). "Lower Tier Covered Transactions" refers to any covered transaction under a First Tier Covered Transaction (such as subcontracts). "First Tier Participant" refers to the participant who has entered into a covered transaction with a grantee or subgrantee of Federal funds (such as the prime or general contractor). "Lower Tier Participant" refers any participant who has entered into a covered transaction with a First Tier Participant or other Lower Tier Participants (such as subcontractors and suppliers).

f. The prospective first tier participant agrees by submitting this proposal that, should the proposed covered transaction be entered into, it shall not knowingly enter into any lower tier covered transaction with a person who is debarred, suspended, declared ineligible, or voluntarily excluded from participation in this covered transaction, unless authorized by the department or agency entering into this transaction.

g. The prospective first tier participant further agrees by submitting this proposal that it will include the clause titled "Certification Regarding Debarment, Suspension, Ineligibility and Voluntary Exclusion-Lower Tier Covered Transactions," provided by the department or contracting agency, entering into this covered transaction, without modification, in all lower tier covered transactions and in all solicitations for lower tier covered transactions exceeding the \$25,000 threshold.

h. A participant in a covered transaction may rely upon a certification of a prospective participant in a lower tier covered transaction that is not debarred, suspended, ineligible, or voluntarily excluded from the covered transaction, unless it knows that the certification is erroneous. A participant is responsible for ensuring that its principals are not suspended, debarred, or otherwise ineligible to participate in covered transactions. To verify the eligibility of its principals, as well as the eligibility of any lower tier prospective participants, each participant may, but is not required to, check the Excluded Parties List System website (<https://www.epls.gov/>), which is compiled by the General Services Administration.

i. Nothing contained in the foregoing shall be construed to require the establishment of a system of records in order to render in good faith the certification required by this clause. The knowledge and information of the prospective participant is not required to exceed that which is normally possessed by a prudent person in the ordinary course of business dealings.

j. Except for transactions authorized under paragraph (f) of these instructions, if a participant in a covered transaction knowingly enters into a lower tier covered transaction with a person who is suspended, debarred, ineligible, or voluntarily excluded from participation in this transaction, in addition to other remedies available to the Federal Government, the department or agency may terminate this transaction for cause or default.

* * * * *

2. Certification Regarding Debarment, Suspension, Ineligibility and Voluntary Exclusion – First Tier Participants:

a. The prospective first tier participant certifies to the best of its knowledge and belief, that it and its principals:

(1) Are not presently debarred, suspended, proposed for debarment, declared ineligible, or voluntarily excluded from participating in covered transactions by any Federal department or agency;

(2) Have not within a three-year period preceding this proposal been convicted of or had a civil judgment rendered against them for commission of fraud or a criminal offense in connection with obtaining, attempting to obtain, or performing a public (Federal, State or local) transaction or contract under a public transaction; violation of Federal or State antitrust statutes or commission of embezzlement, theft, forgery, bribery, falsification or destruction of records, making false statements, or receiving stolen property;

(3) Are not presently indicted for or otherwise criminally or civilly charged by a governmental entity (Federal, State or local) with

commission of any of the offenses enumerated in paragraph (a)(2) of this certification; and

(4) Have not within a three-year period preceding this application/proposal had one or more public transactions (Federal, State or local) terminated for cause or default.

b. Where the prospective participant is unable to certify to any of the statements in this certification, such prospective participant shall attach an explanation to this proposal.

2. Instructions for Certification - Lower Tier Participants:

(Applicable to all subcontracts, purchase orders and other lower tier transactions requiring prior FHWA approval or estimated to cost \$25,000 or more - 2 CFR Parts 180 and 1200)

a. By signing and submitting this proposal, the prospective lower tier is providing the certification set out below.

b. The certification in this clause is a material representation of fact upon which reliance was placed when this transaction was entered into. If it is later determined that the prospective lower tier participant knowingly rendered an erroneous certification, in addition to other remedies available to the Federal Government, the department, or agency with which this transaction originated may pursue available remedies, including suspension and/or debarment.

c. The prospective lower tier participant shall provide immediate written notice to the person to which this proposal is submitted if at any time the prospective lower tier participant learns that its certification was erroneous by reason of changed circumstances.

d. The terms "covered transaction," "debarred," "suspended," "ineligible," "participant," "person," "principal," and "voluntarily excluded," as used in this clause, are defined in 2 CFR Parts 180 and 1200. You may contact the person to which this proposal is submitted for assistance in obtaining a copy of those regulations. "First Tier Covered Transactions" refers to any covered transaction between a grantee or subgrantee of Federal funds and a participant (such as the prime or general contract). "Lower Tier Covered Transactions" refers to any covered transaction under a First Tier Covered Transaction (such as subcontracts). "First Tier Participant" refers to the participant who has entered into a covered transaction with a grantee or subgrantee of Federal funds (such as the prime or general contractor). "Lower Tier Participant" refers any participant who has entered into a covered transaction with a First Tier Participant or other Lower Tier Participants (such as subcontractors and suppliers).

e. The prospective lower tier participant agrees by submitting this proposal that, should the proposed covered transaction be entered into, it shall not knowingly enter into any lower tier covered transaction with a person who is debarred, suspended, declared ineligible, or voluntarily excluded from participation in this covered transaction, unless authorized by the department or agency with which this transaction originated.

f. The prospective lower tier participant further agrees by submitting this proposal that it will include this clause titled "Certification Regarding Debarment, Suspension, Ineligibility and Voluntary Exclusion-Lower Tier Covered Transaction," without modification, in all lower tier covered transactions and in all solicitations for lower tier covered transactions exceeding the \$25,000 threshold.

g. A participant in a covered transaction may rely upon a certification of a prospective participant in a lower tier covered transaction that is not debarred, suspended, ineligible, or voluntarily excluded from the covered transaction, unless it knows that the certification is erroneous. A participant is responsible for ensuring that its principals are not suspended, debarred, or otherwise ineligible to participate in covered transactions. To verify the eligibility of its principals, as well as the eligibility of any lower tier prospective participants, each participant may, but is not required to, check the Excluded Parties List System website (<https://www.epls.gov/>), which is compiled by the General Services Administration.

h. Nothing contained in the foregoing shall be construed to require establishment of a system of records in order to render in good faith the

certification required by this clause. The knowledge and information of participant is not required to exceed that which is normally possessed by a prudent person in the ordinary course of business dealings.

i. Except for transactions authorized under paragraph e of these instructions, if a participant in a covered transaction knowingly enters into a lower tier covered transaction with a person who is suspended, debarred, ineligible, or voluntarily excluded from participation in this transaction, in addition to other remedies available to the Federal Government, the department or agency with which this transaction originated may pursue available remedies, including suspension and/or debarment.

* * * * *

Certification Regarding Debarment, Suspension, Ineligibility and Voluntary Exclusion--Lower Tier Participants:

1. The prospective lower tier participant certifies, by submission of this proposal, that neither it nor its principals is presently debarred, suspended, proposed for debarment, declared ineligible, or voluntarily excluded from participating in covered transactions by any Federal department or agency.

2. Where the prospective lower tier participant is unable to certify to any of the statements in this certification, such prospective participant shall attach an explanation to this proposal.

* * * * *

XI. CERTIFICATION REGARDING USE OF CONTRACT FUNDS FOR LOBBYING

This provision is applicable to all Federal-aid construction contracts and to all related subcontracts which exceed \$100,000 (49 CFR 20).

1. The prospective participant certifies, by signing and submitting this bid or proposal, to the best of his or her knowledge and belief, that:

a. No Federal appropriated funds have been paid or will be paid, by or on behalf of the undersigned, to any person for influencing or attempting to influence an officer or employee of any Federal agency, a Member of Congress, an officer or employee of Congress, or an employee of a Member of Congress in connection with the awarding of any Federal contract, the making of any Federal grant, the making of any Federal loan, the entering into of any cooperative agreement, and the extension, continuation, renewal, amendment, or modification of any Federal contract, grant, loan, or cooperative agreement.

b. If any funds other than Federal appropriated funds have been paid or will be paid to any person for influencing or attempting to influence an officer or employee of any Federal agency, a Member of Congress, an officer or employee of Congress, or an employee of a Member of Congress in connection with this Federal contract, grant, loan, or cooperative agreement, the undersigned shall complete and submit Standard Form-LLL, "Disclosure Form to Report Lobbying," in accordance with its instructions.

2. This certification is a material representation of fact upon which reliance was placed when this transaction was made or entered into. Submission of this certification is a prerequisite for making or entering into this transaction imposed by 31 U.S.C. 1352. Any person who fails to file the required certification shall be subject to a civil penalty of not less than \$10,000 and not more than \$100,000 for each such failure.

3. The prospective participant also agrees by submitting its bid or proposal that the participant shall require that the language of this certification be included in all lower tier subcontracts, which exceed \$100,000 and that all such recipients shall certify and disclose accordingly.

Contract Provision - Cargo Preference Requirements

In accordance with Title 46 CFR § 381.7 (b), the contractor agrees—

“(1) To utilize privately owned United States-flag commercial vessels to ship at least 50 percent of the gross tonnage (computed separately for dry bulk carriers, dry cargo liners, and tankers) involved, whenever shipping any equipment, material, or commodities pursuant to this contract, to the extent such vessels are available at fair and reasonable rates for United States-flag commercial vessels.

(2) To furnish within 20 days following the date of loading for shipments originating within the United States or within 30 working days following the date of loading for shipments originating outside the United States, a legible copy of a rated, ‘on-board’ commercial ocean bill-of-lading in English for each shipment of cargo described in paragraph (b) (1) of this section to both the Contracting Officer (through the prime contractor in the case of subcontractor bills-of-lading) and to the Division of National Cargo, Office of Market Development, Maritime Administration, Washington, DC 20590.

(3) To insert the substance of the provisions of this clause in all subcontracts issued pursuant to this contract.”

Provisions (1) and (2) apply to materials or equipment that are acquired solely for the project. The two provisions do not apply to goods or materials that come into inventories independent of the project, such as shipments of Portland cement, asphalt cement, or aggregates, when industry suppliers and contractors use these materials to replenish existing inventories.

**MINIMUM WAGES FOR FEDERAL AND FEDERALLY
ASSISTED CONSTRUCTION CONTRACTS**

This project is funded, in part, with Federal-aid funds and, as such, is subject to the provisions of the Davis-Bacon Act of March 3, 1931, as amended (46 Sta. 1494, as amended, 40 U.S.C. 276a) and of other Federal statutes referred to in a 29 CFR Part 1, Appendix A, as well as such additional statutes as may from time to time be enacted containing provisions for the payment of wages determined to be prevailing by the Secretary of Labor in accordance with the Davis-Bacon Act and pursuant to the provisions of 29 CFR Part 1. The prevailing rates and fringe benefits shown in the General Wage Determination Decisions issued by the U.S. Department of Labor shall, in accordance with the provisions of the foregoing statutes, constitute the minimum wages payable on Federal and federally assisted construction projects to laborers and mechanics of the specified classes engaged on contract work of the character and in the localities described therein.

General Wage Determination Decisions, modifications and supersedes decisions thereto are to be used in accordance with the provisions of 29 CFR Parts 1 and 5. Accordingly, the applicable decision, together with any modifications issued, must be made a part of every contract for performance of the described work within the geographic area indicated as required by an applicable DBRA Federal prevailing wage law and 29 CFR Part 5. The wage rates and fringe benefits contained in the General Wage Determination Decision shall be the minimum paid by contractors and subcontractors to laborers and mechanics.