

BID PROPOSAL INSTRUCTIONS

ABOUT IDOT PROPOSALS: All proposals are potential bidding proposals. Each proposal contains all certifications and affidavits, a proposal signature sheet and a proposal bid bond.

PREQUALIFICATION

Any contractor who desires to become pre-qualified to bid on work advertised by IDOT must submit the properly completed pre-qualification forms to the Bureau of Construction no later than 4:30 p.m. prevailing time twenty-one days prior to the letting of interest. This pre-qualification requirement applies to first time contractors, contractors renewing expired ratings, contractors maintaining continuous pre-qualification or contractors requesting revised ratings. To be eligible to bid, existing pre-qualification ratings must be effective through the date of letting.

WHO CAN BID ?

Bids will be accepted from only those companies that request and receive written Authorization to Bid from IDOT's Central Bureau of Construction.

REQUESTS FOR AUTHORIZATION TO BID

Contractors wanting to bid on items included in a particular letting must submit the properly completed "Request for Authorization to Bid/or Not For Bid Status" (BDE 124) and the ORIGINAL "Affidavit of Availability" (BC 57) to the proper office no later than 4:30 p.m. prevailing time, three (3) days prior to the letting date.

WHAT CONSTITUTES WRITTEN AUTHORIZATION TO BID?

When a prospective prime bidder submits a "Request for Authorization to Bid/or Not For Bid Status"(BDE 124) he/she must indicate at that time which items are being requested For Bidding purposes. Only those items requested For Bidding will be analyzed. After the request has been analyzed, the bidder will be issued an **Authorization to Bid or Not for Bid Report**, approved by the Central Bureau of Construction and the Chief Procurement Officer that indicates which items have been approved For Bidding. If **Authorization to Bid** cannot be approved, the **Authorization to Bid or Not for Bid Report** will indicate the reason for denial.

ABOUT AUTHORIZATION TO BID

Firms that have not received an Authorization to Bid or Not For Bid Report within a reasonable time of complete and correct original document submittal should contact the Department as to the status. Firms unsure as to authorization status should call the Prequalification Section of the Bureau of Construction at the number listed at the end of these instructions.

ADDENDA AND REVISIONS

It is the bidder's responsibility to determine which, if any, addenda or revisions pertain to any project they may be bidding. Failure to incorporate all relevant addenda or revisions may cause the bid to be declared unacceptable.

Each addendum or revision will be included with the Electronic Plans and Proposals. Addenda and revisions will also be placed on the Addendum/Revision Checklist and each subscription service subscriber will be notified by e-mail of each addendum and revision issued.

The Internet is the Department's primary way of doing business. The subscription service emails are an added courtesy the Department provides. It is suggested that bidders check IDOT's website at <http://www.idot.illinois.gov/doing-business/procurements/construction-services/construction-bulletins/transportation-bulletin/index#TransportationBulletin> before submitting final bid information.

IDOT IS NOT RESPONSIBLE FOR ANY E-MAIL FAILURES.

Addenda questions may be directed to the Contracts Office at (217)782-7806 or DOT.D&Econtracts@illinois.gov

Technical questions about downloading these files may be directed to Tim Garman at (217)524-1642 or Timothy.Garman@illinois.gov.

STANDARD GUIDELINES FOR SUBMITTING BIDS

- All pages should be single sided.
- Use the Cover Page that is provided in the Bid Proposal (posted on the IDOT Web Site) as the first page of your submitted bid. It has the item number in large bold type in the upper left-hand corner and lines provided for your company name and address in the upper right-hand corner.
- Do not use report covers, presentation folders or special bindings and do not staple multiple times on left side like a book. Use only 1 staple in the upper left hand corner. Make sure all elements of your bid are stapled together including the bid bond or guaranty check (if required).
- **Do not include any certificates of eligibility, your authorization to bid, Addendum Letters or affidavit of availability.**
- Do not include the Subcontractor Documentation with your bid (pages i – iii and pages a – g). This documentation is required only if you are awarded the project.
- Use the envelope cover sheet (provided with the proposal) as the cover for the proposal envelope.
- Do not rely on overnight services to deliver your proposal prior to 10 AM on letting day. It will not be read if it is delivered after 10 AM.
- Do not submit your Substance Abuse Prevention Program (SAPP) with your bid. If you are awarded the contract this form is to be submitted to the district engineer at the pre-construction conference.

BID SUBMITTAL CHECKLIST

- Cover page** (the sheet that has the item number on it) – This should be the first page of your bid proposal, **followed by your bid (the Schedule of Prices/Pay Items)**. If you are using special software or CBID to generate your schedule of prices, do not include the blank pages of the schedule of prices that came with the proposal package.
- Page 4 (Item 9)** – Check “YES” if you will use a subcontractor(s) with an annual value over \$50,000. Include the subcontractor(s) name, address, general type of work to be performed and the dollar amount. If you will use subcontractor(s) but are uncertain who or the dollar amount; check “YES” but leave the lines blank.
- After page 4** – Insert the following documents: Cost Adjustments for Steel, Bituminous and Fuel (if applicable) and the Contractor Letter of Assent (if applicable). The general rule should be, if you don’t know where it goes, put it after page 4.
- Page 10 (Paragraph J)** – Check “YES” or “NO” whether your company has any business in Iran.
- Page 10 (Paragraph K)** – (Not applicable to federally funded projects) List the name of the apprenticeship and training program sponsor holding the certificate of registration from the US Department of Labor. If no applicable program exists, please indicate the work/job category. Do not include certificates with your bid. Keep the certificates in your office in case they are requested by IDOT.
- Page 11 (Paragraph L)** – A copy of your State Board of Elections certificate of registration is no longer required with your bid.
- Page 11 (Paragraph M)** – Indicate if your company has hired a lobbyist in connection with the job for which you are submitting the bid proposal.
- Page 12 (Paragraph C)** – This is a work sheet to determine if a completed Form A is required. It is not part of the form and you do not need to make copies for each completed Form A.
- Pages 14-17 (Form A)** – One Form A (4 pages) is required for each applicable person in your company. Copies of the forms can be used and only need to be changed when the information changes. The certification signature and date must be original for each letting. **Do not staple the forms together.** If you answered “NO” to all of the questions in Paragraph C (page 12), complete the first section (page 14) with your company information and then sign and date the Not Applicable statement on page 17.
- Page 18 (Form B)** - If you check “YES” to having other current or pending contracts it is acceptable to use the phrase, “See Affidavit of Availability on file”. **Ownership Certification** (at the bottom of the page) - Check N/A if the Form A(s) you submitted accounts for 100 percent of the company ownership. Check YES if any percentage of ownership falls outside of the parameters that require reporting on the Form A. Checking NO indicates that the Form A(s) you submitted is not correct and you will be required to submit a revised Form A.
- Page 20 (Workforce Projection)** – Be sure to include the Duration of the Project. It is acceptable to use the phrase “Per Contract Specifications”.

Proposal Bid Bond – (Insert after the proposal signature page) Submit your proposal Proposal Bid Bond (if applicable) using the current Proposal Bid Bond form provided in the proposal package. The Power of Attorney page should be stapled to the Proposal Bid Bond. If you are using an electronic bond, include your bid bond number on the Proposal Bid Bond and attach the Proof of Insurance printed from the Surety’s Web Site.

Disadvantaged Business Utilization Plan and/or Good Faith Effort – The last items in your bid should be the DBE Utilization Plan (SBE 2026), followed by the DBE Participation Statement (SBE 2025) and supporting paperwork. If you have documentation of a Good Faith Effort, it is to follow the SBE Forms.

The Bid Letting is now available in streaming Audio/Video from the IDOT Web Site. A link to the stream will be placed on the main page of the current letting on the day of the Letting. The stream will not begin until 10 AM. The actual reading of the bids does not begin until approximately 10:30 AM.

Following the Letting, the As-Read Tabulation of Bids will be posted by the end of the day. You will find the link on the main Web page for the current letting.

QUESTIONS: pre-letting up to execution of the contract

Contractor pre-qualification	217-782-3413
Small Business, Disadvantaged Business Enterprise (DBE)	217-785-4611
Contracts, Bids, Letting process or Internet downloads	217-782-7806
Estimates Unit.....	217-785-3483
Aeronautics.....	217-785-8515
IDNR (Land Reclamation, Water Resources, Natural Resources).....	217-782-6302

QUESTIONS: following contract execution

Subcontractor documentation, payments	217-782-3413
Railroad Insurance	217-785-0275

RETURN WITH BID

139

Proposal Submitted By
Name
Address
City

Letting March 4, 2016

NOTICE TO PROSPECTIVE BIDDERS

This proposal can be used for bidding purposes by only those companies that request and receive written AUTHORIZATION TO BID from IDOT's Central Bureau of Construction.

BIDDERS NEED NOT RETURN THE ENTIRE PROPOSAL

**Notice to Bidders,
Specifications,
Proposal, Contract
and Contract Bond**



**Illinois Department
of Transportation**

Springfield, Illinois 62764

**Contract No. 61A39
DUPAGE County
Section 13-00046-00-LS (Oak Brook)
Route FAU 1453 (West 22nd Street)
Project TE-00D1(943)
District 1 Construction Funds**

PLEASE MARK THE APPROPRIATE BOX BELOW:

- A Bid Bond is included.
- A Cashier's Check or a Certified Check is included
- An Annual Bid Bond is included or is on file with IDOT.

Prepared by

Checked by

F

Page intentionally left blank

RETURN WITH BID



PROPOSAL

TO THE DEPARTMENT OF TRANSPORTATION

1. Proposal of _____

Taxpayer Identification Number (Mandatory) _____

For the improvement identified and advertised for bids in the Invitation for Bids as:

**Contract No. 61A39
DUPAGE County
Section 13-00046-00-LS (Oak Brook)
Project TE-00D1(943)
Route FAU 1453 (West 22nd Street)
District 1 Construction Funds**

Sidewalk construction, landscaping and decorative lighting along West 22nd Street from Salt Creek to I-294/I-88 spur ramp in the Village of Oak Brook.

2. The undersigned bidder will furnish all labor, material and equipment to complete the above described project in a good and workmanlike manner as provided in the contract documents provided by the Department of Transportation. This proposal will become part of the contract and the terms and conditions contained in the contract documents will govern performance and payments.

RETURN WITH BID

3. **ASSURANCE OF EXAMINATION AND INSPECTION/WAIVER.** The undersigned bidder further declares that he/she has carefully examined the proposal, plans, specifications, addenda form of contract and contract bond, and special provisions, and that he/she has inspected in detail the site of the proposed work, and that he/she has familiarized themselves with all of the local conditions affecting the contract and the detailed requirements of construction, and understands that in making this bid proposal he/she waives all right to plead any misunderstanding regarding the same.

4. **EXECUTION OF CONTRACT AND CONTRACT BOND.** The undersigned bidder further agrees to execute a contract for this work and present the same to the department within fifteen (15) days after the contract has been mailed to him/her. The undersigned further agrees that he/she and his/her surety will execute and present within fifteen (15) days after the contract has been mailed to him/her contract bond satisfactory to and in the form prescribed by the Department of Transportation, in the penal sum of the full amount of the contract, or as specified in the special provisions, guaranteeing the faithful performance of the work in accordance with the terms of the contract.

5. **PROPOSAL GUARANTY.** Accompanying this proposal is either a bid bond on the department form, executed by a corporate surety company satisfactory to the department, or a proposal guaranty check consisting of a bank cashier's check or a properly certified check for not less than 5 per cent of the amount bid or for the amount specified in the following schedule:

<u>Amount of Bid</u>		<u>Proposal Guaranty</u>	<u>Amount of Bid</u>		<u>Proposal Guaranty</u>	
Up to	\$5,000	\$150	\$2,000,000	to	\$3,000,000	\$100,000
\$5,000	to \$10,000	\$300	\$3,000,000	to	\$5,000,000	\$150,000
\$10,000	to \$50,000	\$1,000	\$5,000,000	to	\$7,500,000	\$250,000
\$50,000	to \$100,000	\$3,000	\$7,500,000	to	\$10,000,000	\$400,000
\$100,000	to \$150,000	\$5,000	\$10,000,000	to	\$15,000,000	\$500,000
\$150,000	to \$250,000	\$7,500	\$15,000,000	to	\$20,000,000	\$600,000
\$250,000	to \$500,000	\$12,500	\$20,000,000	to	\$25,000,000	\$700,000
\$500,000	to \$1,000,000	\$25,000	\$25,000,000	to	\$30,000,000	\$800,000
\$1,000,000	to \$1,500,000	\$50,000	\$30,000,000	to	\$35,000,000	\$900,000
\$1,500,000	to \$2,000,000	\$75,000	over		\$35,000,000	\$1,000,000

Bank cashier's checks or properly certified checks accompanying bid proposals will be made payable to the Treasurer, State of Illinois.

If a combination bid is submitted, the proposal guaranties which accompany the individual bid proposals making up the combination will be considered as also covering the combination bid.

The amount of the proposal guaranty check is _____ \$(_____). If this proposal is accepted and the undersigned will fail to execute a contract bond as required herein, it is hereby agreed that the amount of the proposal guaranty will become the property of the State of Illinois, and shall be considered as payment of damages due to delay and other causes suffered by the State because of the failure to execute said contract and contract bond; otherwise, the bid bond will become void or the proposal guaranty check will be returned to the undersigned.

Attach Cashier's Check or Certified Check Here

In the event that one proposal guaranty check is intended to cover two or more bid proposals, the amount must be equal to the sum of the proposal guaranties which would be required for each individual bid proposal. If the guaranty check is placed in another bid proposal, state below where it may be found.

The proposal guaranty check will be found in the bid proposal for:

Item _____

Section No. _____

County _____

Mark the proposal cover sheet as to the type of proposal guaranty submitted.

RETURN WITH BID

6. **COMBINATION BIDS.** The undersigned bidder further agrees that if awarded the contract for the sections contained in the following combination, he/she will perform the work in accordance with the requirements of each individual contract comprising the combination bid specified in the schedule below, and that the combination bid shall be prorated against each section in proportion to the bid submitted for the same. If an error is found to exist in the gross sum bid for one or more of the individual sections included in a combination, the combination bid shall be corrected as provided in the specifications.

When a combination bid is submitted, the schedule below must be completed in each proposal comprising the combination.

If alternate bids are submitted for one or more of the sections comprising the combination, a combination bid must be submitted for each alternate.

Schedule of Combination Bids

Combination No.	Sections Included in Combination	Combination Bid	
		Dollars	Cents

7. **SCHEDULE OF PRICES.** The undersigned bidder submits herewith, in accordance with the rules and instructions, a schedule of prices for the items of work for which bids are sought. The unit prices bid are in U.S. dollars and cents, and all extensions and summations have been made. The bidder understands that the quantities appearing in the bid schedule are approximate and are provided for the purpose of obtaining a gross sum for the comparison of bids. If there is an error in the extension of the unit prices, the unit prices will govern. Payment to the contractor awarded the contract will be made only for actual quantities of work performed and accepted or materials furnished according to the contract. The scheduled quantities of work to be done and materials to be furnished may be increased, decreased or omitted as provided elsewhere in the contract.
8. **AUTHORITY TO DO BUSINESS IN ILLINOIS.** Section 20-43 of the Illinois Procurement Code (the Code) (30 ILCS 500/20-43) provides that a person (other than an individual acting as a sole proprietor) must be a legal entity authorized to transact business or conduct affairs in the State of Illinois prior to submitting the bid.
9. **EXECUTION OF CONTRACT:** The Department of Transportation will, in accordance with the rules governing Department procurements, execute the contract and shall be the sole entity having the authority to accept performance and make payments under the contract. Execution of the contract by the Chief Procurement Officer (CPO) or the State Purchasing Officer (SPO) is for approval of the procurement process and execution of the contract by the Department. Neither the CPO nor the SPO shall be responsible for administration of the contract or determinations respecting performance or payment there under except as otherwise permitted in the Code.
10. **The services of a subcontractor will be used.**

Check box Yes
 Check box No

For known subcontractors with subcontracts with an annual value of more than \$50,000, the contract shall include their name, address, general type of work to be performed, and the dollar allocation for each subcontractor.
 (30 ILCS 500/20-120)

STATE JOB # - C-91-037-14
 PPS NBR -

SCHEDULE OF PRICES
 CONTRACT NUMBER - 61A39

RUN DATE - 02/03/16
 RUN TIME - 183041

COUNTY NAME	CODE	DIST	SECTION NUMBER	PROJECT NUMBER	ROUTE
DUPAGE	043	01	13-00046-00-LS (OAK BROOK)	TE-00D1/943/000	FAU 1453

ITEM NUMBER	PAY ITEM DESCRIPTION	UNIT OF MEASURE	QUANTITY	UNIT PRICE		TOTAL PRICE	
				DOLLARS	CENTS	DOLLARS	CTS
A2000118	T-ACERX FREM AB 3	EACH	7.000	X	=		
A2002924	T-CELTIS OCCID 3	EACH	9.000	X	=		
A2004515	T-GINKGO BIL AG 3	EACH	17.000	X	=		
A2004824	T-GLED TRI-I SK 3	EACH	14.000	X	=		
A2005042	T-GYMNOC DE JFS 3	EACH	10.000	X	=		
A2006524	T-QUERCUS BICOL 3	EACH	4.000	X	=		
A2007122	T-QUERCUS RUBRA 3	EACH	4.000	X	=		
A2008124	T-TILIA CORD GS 3	EACH	9.000	X	=		
A2008517	T-ULMUS JAP X WIL 2.5	EACH	15.000	X	=		
B2000769	T-AMEL X GF AB SF 8'	EACH	5.000	X	=		
B2001167	T-CERCIS CAN (E R) 8'	EACH	5.000	X	=		
B2006370	T-SYRG RET IS CL 8'	EACH	10.000	X	=		
C2C03724	S-HYPER KALM 2'C	EACH	34.000	X	=		
C2C06402	S-ROSA AMBER ROSE 24C	EACH	112.000	X	=		
C2C09918	S-SPIREA X BUM GF 18C	EACH	82.000	X	=		

ITEM NUMBER	PAY ITEM DESCRIPTION	UNIT OF MEASURE	QUANTITY	UNIT PRICE		TOTAL PRICE	
				DOLLARS	CENTS	DOLLARS	CTS
C2003930	S-ILEX VERT JD 24BB	EACH	6.000 X	=	=	=	=
C2003936	S-ILEX VERT WR 3'	EACH	62.000 X	=	=	=	=
D2015401	E-JUNIP CHIN KC 24	EACH	44.000 X	=	=	=	=
K0012990	P PL ORNAMENT T GAL P	UNIT	34.590 X	=	=	=	=
K1001988	IRRIGATION SYSTEM SPL	L SUM	1.000 X	=	=	=	=
XX003668	PRECONSTRUCT VID TAP	L SUM	1.000 X	=	=	=	=
XX007797	LUMINAIRE SPL	EACH	78.000 X	=	=	=	=
XX009088	LT P SPL BANNER ARM	EACH	47.000 X	=	=	=	=
XX009089	HOL SUB LT PAN ASMBLY	EACH	2.000 X	=	=	=	=
XX009090	REM LUMINAIRE SALVAGE	EACH	10.000 X	=	=	=	=
X0326146	SOIL CONDITIONER	SQ YD	2,528.000 X	=	=	=	=
X2130010	EXPLOR TRENCH SPL	FOOT	135.000 X	=	=	=	=
X4240430	PC CONC SIDEWALK 5 SP	SQ FT	9,138.000 X	=	=	=	=
X4240460	PC CONC SIDEWALK 8 SP	SQ FT	720.000 X	=	=	=	=
X5620035	WAT SER CONN 1 1/2	EACH	1.000 X	=	=	=	=

ITEM NUMBER	PAY ITEM DESCRIPTION	UNIT OF MEASURE	QUANTITY	UNIT PRICE		TOTAL PRICE	
				DOLLARS	CENTS	DOLLARS	CTS
X8300001	LIGHT POLE SPECIAL	EACH	29.000 X	=		=	
Z0013798	CONSTRUCTION LAYOUT	L SUM	1.000 X	=		=	
Z0017400	DRAIN UTIL STR ADJ	EACH	5.000 X	=		=	
Z0033028	MAINTAIN LIGHTING SYS	CAL MO	4.000 X	=		=	
Z0076870	UNDR CONNECT TO STR	EACH	4.000 X	=		=	
20100110	TREE REMOV 6-15	UNIT	24.000 X	=		=	
20100210	TREE REMOV OVER 15	UNIT	30.000 X	=		=	
20200100	EARTH EXCAVATION	CU YD	1,235.000 X	=		=	
21101505	TOPSOIL EXC & PLAC	CU YD	618.000 X	=		=	
21101625	TOPSOIL F & P 6	SQ YD	860.000 X	=		=	
21101665	TOPSOIL F & P 18	SQ YD	1,010.000 X	=		=	
21101685	TOPSOIL F & P 24	SQ YD	352.000 X	=		=	
25000400	NITROGEN FERT NUTR	POUND	25.000 X	=		=	
25000500	PHOSPHORUS FERT NUTR	POUND	25.000 X	=		=	
25000600	POTASSIUM FERT NUTR	POUND	25.000 X	=		=	

ITEM NUMBER	PAY ITEM DESCRIPTION	UNIT OF MEASURE	QUANTITY	UNIT PRICE		TOTAL PRICE	
				DOLLARS	CENTS	DOLLARS	CTS
25200110	SODDING SALT TOLERANT	SQ YD	935.000 X	=	=	=	=
25200200	SUPPLE WATERING	UNIT	12.000 X	=	=	=	=
35101400	AGG BASE CSE B	TON	177.000 X	=	=	=	=
44000100	PAVEMENT REM	SQ YD	20.000 X	=	=	=	=
60100080	FRENCH DRAINS	CU YD	8.000 X	=	=	=	=
60100085	GEO FAB-FRENCH DRAIN	SQ YD	48.000 X	=	=	=	=
60109510	P UNDR FAB LINE TR 4	FOOT	2,948.000 X	=	=	=	=
60603451	PRECAST CONC CURB	FOOT	575.000 X	=	=	=	=
66900200	NON SPL WASTE DISPOSL	CU YD	1,600.000 X	=	=	=	=
66900450	SPL WASTE PLNS/REPORT	L SUM	1.000 X	=	=	=	=
66900530	SOIL DISPOSAL ANALY	EACH	3.000 X	=	=	=	=
67100100	MOBILIZATION	L SUM	1.000 X	=	=	=	=
70102625	TR CONT & PROT 701606	L SUM	1.000 X	=	=	=	=
70102630	TR CONT & PROT 701601	L SUM	1.000 X	=	=	=	=
70102635	TR CONT & PROT 701701	L SUM	1.000 X	=	=	=	=

ITEM NUMBER	PAY ITEM DESCRIPTION	UNIT OF MEASURE	QUANTITY	UNIT PRICE		TOTAL PRICE	
				DOLLARS	CENTS	DOLLARS	CTS
70102640	TR CONT & PROT 701801	L SUM	1.000 X				
70103815	TR CONT SURVEILLANCE	CAL DA	80.000 X				
81028200	UNDRGRD C GALVS 2	FOOT	94.000 X				
81028210	UNDRGRD C GALVS 2 1/2	FOOT	714.000 X				
81028240	UNDRGRD C GALVS 4	FOOT	361.000 X				
81400100	HANDHOLE	EACH	2.000 X				
81603035	UD 2#6 #6G XLPUSE 1	FOOT	554.000 X				
81603102	UD 4#6#6GXLPHDP 1 1/4	FOOT	5,945.000 X				
81603178	UD 6#4 #6G XLPUSE 2	FOOT	3,660.000 X				
81603598	UD 6#6 #8G XLPUSE 1.5	FOOT	6,221.000 X				
82102400	LUM SV HOR MT 400W	EACH	8.000 X				
83600300	LIGHT POLE FDN 30D	FOOT	532.000 X				
84200500	REM LT UNIT SALV	EACH	83.000 X				
84200804	REM POLE FDN	EACH	83.000 X				

TOTAL \$

NOTE:
 *** PLEASE TURN PAGE FOR IMPORTANT NOTES ***

FAU 1453
13-00046-00-LS (OAK BROOK)
DUPAGE

ILLINOIS DEPARTMENT OF TRANSPORTATION
SCHEDULE OF PRICES
CONTRACT NUMBER - 61A39

ECMS002 DTGECM03 ECMR003 PAGE
RUN DATE - 02/03/16
RUN TIME - 183041

NOTE:

1. EACH PAY ITEM SHOULD HAVE A UNIT PRICE AND A TOTAL PRICE.
2. THE UNIT PRICE SHALL GOVERN IF NO TOTAL PRICE IS SHOWN OR IF THERE IS A DISCREPANCY BETWEEN THE PRODUCT OF THE UNIT PRICE MULTIPLIED BY THE QUANTITY.
3. IF A UNIT PRICE IS OMITTED, THE TOTAL PRICE WILL BE DIVIDED BY THE QUANTITY IN ORDER TO ESTABLISH A UNIT PRICE.
4. A BID MAY BE DECLARED UNACCEPTABLE IF NEITHER A UNIT PRICE NOR A TOTAL PRICE IS SHOWN.

RETURN WITH BID

STATE REQUIRED ETHICAL STANDARDS GOVERNING CONTRACT PROCUREMENT: ASSURANCES, CERTIFICATIONS AND DISCLOSURES

I. GENERAL

A. Article 50 of the Code establishes the duty of all State CPOs, SPOs, and their designees to maximize the value of the expenditure of public moneys in procuring goods, services, and contracts for the State of Illinois and to act in a manner that maintains the integrity and public trust of State government. In discharging this duty, they are charged by law to use all available information, reasonable efforts, and reasonable actions to protect, safeguard, and maintain the procurement process of the State of Illinois.

B. In order to comply with the provisions of Article 50 and to carry out the duty established therein, all bidders are to adhere to ethical standards established for the procurement process, and to make such assurances, disclosures and certifications required by law. Except as otherwise required in subsection III, paragraphs J-M, by execution of the Proposal Signature Sheet, the bidder indicates that each of the mandated assurances have been read and understood, that each certification is made and understood, and that each disclosure requirement has been understood and completed.

C. In addition to all other remedies provided by law, failure to comply with any assurance, failure to make any disclosure or the making of a false certification shall be grounds for the CPO to void the contract, and may result in the suspension or debarment of the bidder or subcontractor. If a false certification is made by a subcontractor the contractor's submitted bid and the executed contract may not be declared void unless the contractor refuses to terminate the subcontract upon the State's request after a finding that the subcontractor's certification was false.

I acknowledge, understand and accept these terms and conditions.

II. ASSURANCES

The assurances hereinafter made by the bidder are each a material representation of fact upon which reliance is placed should the Department enter into the contract with the bidder.

A. Conflicts of Interest

Section 50-13. Conflicts of Interest.

(a) Prohibition. It is unlawful for any person holding an elective office in this State, holding a seat in the General Assembly, or appointed to or employed in any of the offices or agencies of state government and who receives compensation for such employment in excess of 60% of the salary of the Governor of the State of Illinois, or who is an officer or employee of the Capital Development Board or the Illinois State Toll Highway Authority, or who is the spouse or minor child of any such person to have or acquire any contract, or any direct pecuniary interest in any contract therein, whether for stationery, printing, paper, or any services, materials, or supplies, that will be wholly or partially satisfied by the payment of funds appropriated by the General Assembly of the State of Illinois or in any contract of the Capital Development Board or the Illinois State Toll Highway Authority.

(b) Interests. It is unlawful for any firm, partnership, association or corporation, in which any person listed in subsection (a) is entitled to receive (i) more than 7 1/2% of the total distributable income or (ii) an amount in excess of the salary of the Governor, to have or acquire any such contract or direct pecuniary interest therein.

(c) Combined interests. It is unlawful for any firm, partnership, association, or corporation, in which any person listed in subsection (a) together with his or her spouse or minor children is entitled to receive (i) more than 15%, in the aggregate, of the total distributable income or (ii) an amount in excess of 2 times the salary of the Governor, to have or acquire any such contract or direct pecuniary interest therein.

(d) Securities. Nothing in this Section invalidates the provisions of any bond or other security previously offered or to be offered for sale or sold by or for the State of Illinois.

(e) Prior interests. This Section does not affect the validity of any contract made between the State and an officer or employee of the State or member of the General Assembly, his or her spouse, minor child or any combination of those persons if that contract was in existence before his or her election or employment as an officer, member, or employee. The contract is voidable, however, if it cannot be completed within 365 calendar days after the officer, member, or employee takes office or is employed. The current salary of the Governor is \$177,412.00. Sixty percent of the salary is \$106,447.20.

RETURN WITH BID

The bidder assures the Department that the award and execution of the contract would not cause a violation of Section 50-13, or that an effective exemption has been issued by the Board of Ethics to any individual subject to the Section 50-13 prohibitions pursuant to the provisions of Section 50-20 of the Code. Information concerning the exemption process is available from the Department upon request.

B. Negotiations

Section 50-15. Negotiations.

It is unlawful for any person employed in or on a continual contractual relationship with any of the offices or agencies of State government to participate in contract negotiations on behalf of that office or agency with any firm, partnership, association, or corporation with whom that person has a contract for future employment or is negotiating concerning possible future employment.

The bidder assures the Department that the award and execution of the contract would not cause a violation of Section 50-15, and that the bidder has no knowledge of any facts relevant to the kinds of acts prohibited therein.

C. Inducements

Section 50-25. Inducement.

Any person who offers or pays any money or other valuable thing to any person to induce him or her not to provide a submission to a vendor portal or to bid for a State contract or as recompense for not having bid on a State contract is guilty of a Class 4 felony. Any person who accepts any money or other valuable thing for not bidding for a State contract, not making a submission to a vendor portal, or who withholds a bid or submission to a vendor portal in consideration of the promise for the payment of money or other valuable thing is guilty of a Class 4 felony.

The bidder assures the Department that the award and execution of the contract would not cause a violation of Section 50-25, and that the bidder has no knowledge of any facts relevant to the kinds of acts prohibited therein.

D. Revolving Door Prohibition

Section 50-30. Revolving door prohibition.

CPOs, SPOs, procurement compliance monitors, their designees whose principal duties are directly related to State procurement, and executive officers confirmed by the Senate are expressly prohibited for a period of 2 years after terminating an affected position from engaging in any procurement activity relating to the State agency most recently employing them in an affected position for a period of at least 6 months. The prohibition includes, but is not limited to: lobbying the procurement process; specifying; bidding; proposing bid, proposal, or contract documents; on their own behalf or on behalf of any firm, partnership, association, or corporation. This Section applies only to persons who terminate an affected position on or after January 15, 1999.

The bidder assures the Department that the award and execution of the contract would not cause a violation of Section 50-30, and that the bidder has no knowledge of any facts relevant to the kinds of acts prohibited therein.

E. Reporting Anticompetitive Practices

Section 50-40. Reporting anticompetitive practices.

When, for any reason, any vendor, bidder, contractor, CPO, SPO, designee, elected official, or State employee suspects collusion or other anticompetitive practice among any bidders, offerors, contractors, proposers, or employees of the State, a notice of the relevant facts shall be transmitted to the Attorney General and the CPO.

The bidder assures the Department that it has not failed to report any relevant facts concerning the practices addressed in Section 50-40 which may involve the contract for which the bid or submission to a vendor portal is submitted.

F. Confidentiality

Section 50-45. Confidentiality.

Any CPO, SPO, designee, or executive officer who willfully uses or allows the use of specifications, competitive bid documents, proprietary competitive information, proposals, contracts, or selection information to compromise the fairness or integrity of the procurement, bidding, or contract process shall be subject to immediate dismissal, regardless of the Personnel code, any contract, or any collective bargaining agreement, and may in addition be subject to criminal prosecution.

The bidder assures the Department that it has no knowledge of any fact relevant to the practices addressed in Section 50-45 which may involve the contract for which the bid is submitted.

RETURN WITH BID

G. Insider Information

Section 50-50. Insider information.

It is unlawful for any current or former elected or appointed State official or State employee to knowingly use confidential information available only by virtue of that office or employment for actual or anticipated gain for themselves or another person.

The bidder assures the Department that it has no knowledge of any facts relevant to the practices addressed in Section 50-50 which may involve the contract for which the bid is submitted.

I acknowledge, understand and accept these terms and conditions for the above assurances.

III. CERTIFICATIONS

The certifications hereinafter made by the bidder are each a material representation of fact upon which reliance is placed should the Department enter into the contract with the bidder. Section 50-2 of the Code provides that every person that has entered into a multi-year contract and every subcontractor with a multi-year subcontract shall certify, by July 1 of each fiscal year covered by the contract after the initial fiscal year, to the responsible CPO whether it continues to satisfy the requirements of Article 50 pertaining to the eligibility for a contract award. If a contractor or subcontractor is not able to truthfully certify that it continues to meet all requirements, it shall provide with its certification a detailed explanation of the circumstances leading to the change in certification status. A contractor or subcontractor that makes a false statement material to any given certification required under Article 50 is, in addition to any other penalties or consequences prescribed by law, subject to liability under the Whistleblower Reward and Protection Act for submission of a false claim.

A. Bribery

Section 50-5. Bribery.

(a) Prohibition. No person or business shall be awarded a contract or subcontract under this Code who:

(1) has been convicted under the laws of Illinois or any other state of bribery or attempting to bribe an officer or employee of the State of Illinois or any other state in that officer's or employee's official capacity; or

(2) has made an admission of guilt of that conduct that is a matter of record but has not been prosecuted for that conduct.

(b) Businesses. No business shall be barred from contracting with any unit of State or local government, or subcontracting under such a contract, as a result of a conviction under this Section of any employee or agent of the business if the employee or agent is no longer employed by the business and:

(1) the business has been finally adjudicated not guilty; or

(2) the business demonstrates to the governmental entity with which it seeks to contract, or which is signatory to the contract which the subcontract relates, and that entity finds that the commission of the offense was not authorized, requested, commanded, or performed by a director, officer, or high managerial agent on behalf of the business as provided in paragraph (2) of subsection (a) of Section 5-4 of the Criminal Code of 2012.

(c) Conduct on behalf of business. For purposes of this Section, when an official, agent, or employee of a business committed the bribery or attempted bribery on behalf of the business and in accordance with the direction or authorization of a responsible official of the business, the business shall be chargeable with the conduct.

(d) Certification. Every bid submitted to and contract executed by the State, and every subcontract subject to Section 20-120 of the Code shall contain a certification by the contractor or the subcontractor, respectively, that the contractor or subcontractor is not barred from being awarded a contract or subcontract under this Section and acknowledges that the CPO may declare the related contract void if any certifications required by this Section are false. A contractor who makes a false statement, material to the certification, commits a Class 3 felony.

The contractor or subcontractor certifies that it is not barred from being awarded a contract under Section 50-5.

B. Felons

Section 50-10. Felons.

(a) Unless otherwise provided, no person or business convicted of a felony shall do business with the State of Illinois or any State agency, or enter into a subcontract, from the date of conviction until 5 years after the date of completion of the sentence for that felony, unless no person held responsible by a prosecutorial office for the facts upon which the conviction was based continues to have any involvement with the business.

(b) Certification. Every bid submitted to and contract executed by the State and every subcontract subject to Section 20-120 of the Code and every vendor's submission to a vendor portal shall contain a certification by the bidder or contractor or subcontractor, respectively, that the bidder, contractor, or subcontractor is not barred from being awarded a contract or subcontract under this Section and acknowledges that the CPO may declare the related contract void if any of the certifications required by this Section are false.

RETURN WITH BID

C. Debt Delinquency

Section 50-11 and 50-12. Debt Delinquency.

The contractor or bidder or subcontractor, respectively, certifies that it, or any affiliate, is not barred from being awarded a contract or subcontract under the Code. Section 50-11 prohibits a person from entering into a contract with a State agency, or entering into a subcontract, if it knows or should know that it, or any affiliate, is delinquent in the payment of any debt to the State as defined by the Debt Collection Board. Section 50-12 prohibits a person from entering into a contract with a State agency, or entering into a subcontract, if it, or any affiliate, has failed to collect and remit Illinois Use Tax on all sales of tangible personal property into the State of Illinois in accordance with the provisions of the Illinois Use Tax Act. The bidder or contractor or subcontractor, respectively, further acknowledges that the CPO may declare the related contract void if this certification is false or if the bidder, contractor, or subcontractor, or any affiliate, is determined to be delinquent in the payment of any debt to the State during the term of the contract.

D. Prohibited Bidders, Contractors and Subcontractors

Section 50-10.5 and 50-60(c). Prohibited bidders, contractors and subcontractors.

The bidder or contractor or subcontractor, respectively, certifies in accordance with Section 50-10.5 that no officer, director, partner or other managerial agent of the contracting business has been convicted of a felony under the Sarbanes-Oxley Act of 2002 or a Class 3 or Class 2 felony under the Illinois Securities Law of 1953 or if in violation of Subsection (c) for a period of five years from the date of conviction. Every bid submitted to and contract executed by the State and every subcontract subject to Section 20-120 of the Code shall contain a certification by the bidder, contractor, or subcontractor, respectively, that the bidder, contractor, or subcontractor is not barred from being awarded a contract or subcontract under this Section and acknowledges that the CPO shall declare the related contract void if any of the certifications completed pursuant to this Section are false.

E. Section 42 of the Environmental Protection Act

Section 50-14 Environmental Protection Act violations.

The bidder or contractor or subcontractor, respectively, certifies in accordance with Section 50-14 that the bidder, contractor, or subcontractor, is not barred from being awarded a contract or entering into a subcontract under this Section which prohibits the bidding on or entering into contracts with the State of Illinois or a State agency, or entering into any subcontract, that is subject to the Code by a person or business found by a court or the Pollution Control Board to have committed a willful or knowing violation of Section 42 of the Environmental Protection Act for a period of five years from the date of the order. The bidder or contractor or subcontractor, respectively, acknowledges that the CPO may declare the contract void if this certification is false.

F. Educational Loan

Section 3 of the Educational Loan Default Act, 5 ILCS 385/3.

Pursuant to the Educational Loan Default Act no State agency shall contract with an individual for goods or services if that individual is in default on an educational loan.

The bidder, if an individual as opposed to a corporation, partnership or other form of business organization, certifies that the bidder is not in default on an educational loan as provided in Section 3 of the Act.

G. Bid-Rigging/Bid Rotating

Section 33E-11 of the Criminal Code of 2012, 720 ILCS 5/3BE-11.

(a) Every bid submitted to and public contract executed pursuant to such bid by the State or a unit of local government shall contain a certification by the prime contractor that the prime contractor is not barred from contracting with any unit of State or local government as a result of a violation of either Section 33E-3 or 33E-4 of this Article.

(b) A contractor who makes a false statement, material to the certification, commits a Class 3 felony.

A violation of Section 33E-3 would be represented by a conviction of the crime of bid-rigging which, in addition to Class 3 felony sentencing, provides that any person convicted of this offense or any similar offense of any state or the United States which contains the same elements as this offense shall be barred for 5 years from the date of conviction from contracting with any unit of State or local government. No corporation shall be barred from contracting with any unit of State or local government as a result of a conviction under this Section of any employee or agent of such corporation if the employee so convicted is no longer employed by the corporation and: (1) it has been finally adjudicated not guilty or (2) if it demonstrates to the governmental entity with which it seeks to contract and that entity finds that the commission of the offense was neither authorized, requested, commanded, nor performed by a director, officer or a high managerial agent in behalf of the corporation.

The bidder certifies that it is not barred from contracting with the Department by reason of a violation of either Section 33E-3 or Section 33E-4.

RETURN WITH BID

H. International Anti-Boycott

Section 5 of the International Anti-Boycott Certification Act provides every contract entered into by the State of Illinois for the manufacture, furnishing, or purchasing of supplies, material, or equipment or for the furnishing of work, labor, or services, in an amount exceeding the threshold for small purchases according to the purchasing laws of this State or \$10,000.00, whichever is less, shall contain certification, as a material condition of the contract, by which the contractor agrees that neither the contractor nor any substantially-owned affiliated company is participating or shall participate in an international boycott in violation of the provisions of the U.S. Export Administration Act of 1979 or the regulations of the U.S. Department of Commerce promulgated under that Act.

The bidder makes the certification set forth in Section 5 of the Act.

I. Drug Free Workplace

The Illinois "Drug Free Workplace Act" applies to this contract and it is necessary to comply with the provisions of the "Act" if the contractor is a corporation, partnership, or other entity (including a sole proprietorship) which has 25 or more employees.

The bidder certifies that if awarded a contract in excess of \$5,000 it will provide a drug free workplace in compliance with the provisions of the Act.

J. Disclosure of Business Operations in Iran

Section 50-36 of the Code provides that each bid, offer, or proposal submitted for a State contract shall include a disclosure of whether or not the Company acting as the bidder, offeror, or proposing entity, or any of its corporate parents or subsidiaries, within the 24 months before submission of the bid, offer, or proposal had business operations that involved contracts with or provision of supplies or services to the Government of Iran, companies in which the Government of Iran has any direct or indirect equity share, consortiums or projects commissioned by the Government of Iran, or companies involved in consortiums or projects commissioned by the Government of Iran and either of the following conditions apply:

- (1) More than 10% of the Company's revenues produced in or assets located in Iran involve oil-related activities or mineral-extraction activities; less than 75% of the Company's revenues produced in or assets located in Iran involve contracts with or provision of oil-related or mineral-extraction products or services to the Government of Iran or a project or consortium created exclusively by that government; and the Company has failed to take substantial action.
- (2) The Company has, on or after August 5, 1996, made an investment of \$20 million or more, or any combination of investments of at least \$10 million each that in the aggregate equals or exceeds \$20 million in any 12-month period, which directly or significantly contributes to the enhancement of Iran's ability to develop petroleum resources of Iran.

The terms "Business operations", "Company", "Mineral-extraction activities", "Oil-related activities", "Petroleum resources", and "Substantial action" are all defined in the Code.

Failure to make the disclosure required by the Code may cause the bid, offer or proposal to be considered not responsive. The disclosure will be considered when evaluating the bid or awarding the contract. The name of each Company disclosed as doing business or having done business in Iran will be provided to the State Comptroller.

Check the appropriate statement:

Company has no business operations in Iran to disclose.

Company has business operations in Iran as disclosed on the attached document.

RETURN WITH BID

K. Apprenticeship and Training Certification (Does not apply to federal aid projects)

In accordance with the provisions of Section 30-22 (6) of the Code, the bidder certifies that it is a participant, either as an individual or as part of a group program, in the approved apprenticeship and training programs applicable to each type of work or craft that the bidder will perform with its own forces. The bidder further certifies for work that will be performed by subcontract that each of its subcontractors submitted for approval either (a) is, at the time of such bid, participating in an approved, applicable apprenticeship and training program; or (b) will, prior to commencement of performance of work pursuant to this contract, begin participation in an approved apprenticeship and training program applicable to the work of the subcontract. The Department, at any time before or after award, may require the production of a copy of each applicable Certificate of Registration issued by the United States Department of Labor evidencing such participation by the contractor and any or all of its subcontractors. Applicable apprenticeship and training programs are those that have been approved and registered with the United States Department of Labor. The bidder shall list in the space below, the official name of the program sponsor holding the Certificate of Registration for all of the types of work or crafts in which the bidder is a participant and that will be performed with the bidder's forces. Types of work or craft work that will be subcontracted shall be included and listed as subcontract work. The list shall also indicate any type of work or craft job category that does not have an applicable apprenticeship or training program. **The bidder is responsible for making a complete report and shall make certain that each type of work or craft job category that will be utilized on the project as reported on the Construction Employee Workforce Projection (Form BC-1256) and returned with the bid is accounted for and listed.**

Additionally, Section 30-22 of the Code requires that the bidder certify that an Illinois office be maintained as the primary place of employment for persons employed for this contract.

NA-FEDERAL

The requirements of these certifications and disclosures are a material part of the contract, and the contractor shall require these certification provisions to be included in all approved subcontracts. In order to fulfill this requirement, it shall not be necessary that an applicable program sponsor be currently taking, or that it will take applications for apprenticeship, training or employment during the performance of the work of this contract.

RETURN WITH BID

L. Political Contributions and Registration with the State Board of Elections

Sections 20-160 and 50-37 of the Code regulate political contributions from business entities and any affiliated entities or affiliated persons bidding on or contracting with the state. Generally under Section 50-37, any business entity, and any affiliated entity or affiliated person of the business entity, whose current year contracts with all state agencies exceed an awarded value of \$50,000, are prohibited from making any contributions to any political committees established to promote the candidacy of the officeholder responsible for the awarding of the contracts or any other declared candidate for that office for the duration of the term of office of the incumbent officeholder or a period 2 years after the termination of the contract, whichever is longer. Any business entity and affiliated entities or affiliated persons whose state contracts in the current year do not exceed an awarded value of \$50,000, but whose aggregate pending bids and proposals on state contracts exceed \$50,000, either alone or in combination with contracts not exceeding \$50,000, are prohibited from making any political contributions to any political committee established to promote the candidacy of the officeholder responsible for awarding the pending contract during the period beginning on the date the invitation for bids or request for proposals or any other procurement opportunity is issued and ending on the day after the date of award or selection if the entity was not awarded or selected. Section 20-160 requires certification of registration of affected business entities in accordance with procedures found in Section 9-35 of The Election Code.

By submission of a bid, the contractor business entity acknowledges and agrees that it has read and understands Sections 20-160 and 50-37 of the Code, and that it makes the following certification:

The undersigned bidder certifies that it has registered as a business with the State Board of Elections and acknowledges a continuing duty to update the registration in accordance with the above referenced statutes. If the business entity is required to register, the CPO shall verify that it is in compliance on the date the bid or proposal is due. The CPO shall not accept a bid or proposal if the business entity is not in compliance with the registration requirements.

These requirements and compliance with the above referenced statutory sections are a material part of the contract, and any breach thereof shall be cause to void the contract under Section 50-60 of the Code. This provision does not apply to Federal-aid contracts.

M. Lobbyist Disclosure

Section 50-38 of the Code requires that any bidder or offeror on a State contract that hires a person required to register under the Lobbyist Registration Act to assist in obtaining a contract shall:

- (i) Disclose all costs, fees, compensation, reimbursements, and other remunerations paid or to be paid to the lobbyist related to the contract,
- (ii) Not bill or otherwise cause the State of Illinois to pay for any of the lobbyist's costs, fees, compensation, reimbursements, or other remuneration, and
- (iii) Sign a verification certifying that none of the lobbyist's costs, fees, compensation, reimbursements, or other remuneration were billed to the State.

This information, along with all supporting documents, shall be filed with the agency awarding the contract and with the Secretary of State. The CPO shall post this information, together with the contract award notice, in the online Procurement Bulletin.

Pursuant to Subsection (c) of this Section, no person or entity shall retain a person or entity to attempt to influence the outcome of a procurement decision made under the Code for compensation contingent in whole or in part upon the decision or procurement. Any person who violates this subsection is guilty of a business offense and shall be fined not more than \$10,000.

Bidder acknowledges that it is required to disclose the hiring of any person required to register pursuant to the Illinois Lobbyist Registration Act (25 ILCS 170) in connection with this contract.

Bidder has not hired any person required to register pursuant to the Illinois Lobbyist Registration Act in connection with this contract.

Or

Bidder has hired the following persons required to register pursuant to the Illinois Lobbyist Registration Act in connection with the contract:

Name and address of person: _____
All costs, fees, compensation, reimbursements and other remuneration paid to said person: _____

I acknowledge, understand and accept these terms and conditions for the above certifications.

RETURN WITH BID

IV. DISCLOSURES

- A. The disclosures hereinafter made by the bidder are each a material representation of fact upon which reliance is placed should the Department enter into the contract with the bidder. The bidder further certifies that the Department has received the disclosure forms for each bid.

The CPO may void the bid, or contract, respectively, if it is later determined that the bidder or subcontractor rendered a false or erroneous disclosure. A contractor or subcontractor may be suspended or debarred for violations of the Code. Furthermore, the CPO may void the contract and the surety providing the performance bond shall be responsible for completion of the contract.

B. Financial Interests and Conflicts of Interest

1. Section 50-35 of the Code provides that all bids of more than \$50,000 and all submissions to a vendor portal shall be accompanied by disclosure of the financial interests of the bidder. This disclosed information for the successful bidder, will be maintained as public information subject to release by request pursuant to the Freedom of Information Act, filed with the Procurement Policy Board, and shall be incorporated as a material term of the contract. Furthermore, pursuant to Section 5-5, the Procurement Policy Board may review a proposal, bid, or contract and issue a recommendation to void a contract or reject a proposal or bid based on any violation of the Code or the existence of a conflict of interest as provided in subsections (b) and (d) of Section 50-35.

The financial interests to be disclosed shall include ownership or distributive income share that is in excess of 5%, or an amount greater than 60% of the annual salary of the Governor, of the bidding entity or its parent entity, whichever is less, unless the contractor or bidder is a publicly traded entity subject to Federal 10K reporting, in which case it may submit its 10K disclosure in place of the prescribed disclosure. If a bidder is a privately held entity that is exempt from Federal 10K reporting, but has more than 100 shareholders, it may submit the information that Federal 10K companies are required to report, and list the names of any individual or entity holding any ownership share that is in excess of 5%. The disclosure shall include the names, addresses, and dollar or proportionate share of ownership of each individual making the disclosure, their instrument of ownership or beneficial relationship, and notice of any potential conflict of interest resulting from the current ownership or beneficial interest of each individual making the disclosure having any of the relationships identified in Section 50-35 and on the disclosure form.

The current annual salary of the Governor is \$177,412.00.

In addition, all disclosures shall indicate any other current or pending contracts, proposals, leases, or other ongoing procurement relationships the bidding entity has with any other unit of state government and shall clearly identify the unit and the contract, proposal, lease, or other relationship.

2. Disclosure Forms. Disclosure Form A is attached for use concerning the individuals meeting the above ownership or distributive share requirements. A separate Disclosure Form A must be submitted with the bid for each individual meeting the above requirements. In addition, a second form (Disclosure Form B) provides for the disclosure of current or pending procurement relationships with other (non-IDOT) state agencies and a total ownership certification. **The forms must be included with each bid.**

C. Disclosure Form Instructions

Form A Instructions for Financial Information & Potential Conflicts of Interest

If the bidder is a publicly traded entity subject to Federal 10K reporting, the 10K Report may be submitted to meet the requirements of Form A. If a bidder is a privately held entity that is exempt from Federal 10K reporting, but has more than 100 shareholders, it may submit the information that Federal 10K companies are required to report, and list the names of any individual or entity holding any ownership share that is in excess of 5%. If a bidder is not subject to Federal 10K reporting, the bidder must determine if any individuals are required by law to complete a financial disclosure form. To do this, the bidder should answer each of the following questions. A "YES" answer indicates Form A must be completed. If the answer to each of the following questions is "NO", then the NOT APPLICABLE STATEMENT on Form A must be signed and dated by an individual that is authorized to execute contracts for the bidding company. Note: These questions are for assistance only and are not required to be completed.

1. Does anyone in your organization have a direct or beneficial ownership share of greater than 5% of the bidding entity or parent entity? YES ___ NO ___
2. Does anyone in your organization have a direct or beneficial ownership share of less than 5%, but which has a value greater than 60% of the annual salary of the Governor? YES ___ NO ___
3. Does anyone in your organization receive more than 60% of the annual salary of the Governor of the bidding entity's or parent entity's distributive income? YES ___ NO ___
4. Does anyone in your organization receive greater than 5% of the bidding entity's or parent entity's total distributive income, but which is less than 60% of the annual salary of the Governor? YES ___ NO ___

(Note: Only one set of forms needs to be completed per individual per bid even if a specific individual would require a yes answer to more than one question.)

A "YES" answer to any of these questions requires the completion of Form A. The bidder must determine each individual in the bidding entity or the bidding entity's parent company that would cause the questions to be answered "Yes". Each form must be signed and dated by an individual that is authorized to execute contracts for your organization. The individual signing can be, but does not have to be, the individual for which the form is being completed. The bidder is responsible for the accuracy of any information provided.

If the answer to each of the above questions is "NO", then the NOT APPLICABLE STATEMENT of Form A must be signed and dated by an individual that is authorized to execute contracts for your company.

RETURN WITH BID

Form B: Instructions for Identifying Other Contracts & Procurement Related Information

Disclosure Form B must be completed for each bid submitted by the bidding entity. *Note: Checking the NOT APPLICABLE STATEMENT on Form A does not allow the bidder to ignore Form B. Form B must be completed, checked, and dated or the bidder may be considered nonresponsive and the bid will not be accepted.*

The Bidder shall identify, by checking Yes or No on Form B, whether it has any pending contracts (including leases), bids, proposals, or other ongoing procurement relationship with any other (non-IDOT) State of Illinois agency. If "No" is checked, the bidder only needs to complete the check box on the bottom of Form B. If "Yes" is checked, the bidder must do one of the following:

Option I: If the bidder did not submit an Affidavit of Availability to obtain authorization to bid, the bidder must list all non-IDOT State of Illinois agency pending contracts, leases, bids, proposals, and other ongoing procurement relationships. These items may be listed on Form B or on an attached sheet(s). Do not include IDOT contracts. Contracts with cities, counties, villages, etc. are not considered State of Illinois agency contracts and are not to be included. Contracts with other State of Illinois agencies such as the Department of Natural Resources or the Capital Development Board must be included. Bidders who submit Affidavits of Availability are suggested to use Option II.

Option II: If the bidder is required and has submitted an Affidavit of Availability in order to obtain authorization to bid, the bidder may write or type "See Affidavit of Availability" which indicates that the Affidavit of Availability is incorporated by reference and includes all non-IDOT State of Illinois agency pending contracts, leases, bids, proposals, and other ongoing procurement relationships. For any contracts that are not covered by the Affidavit of Availability, the bidder must identify them on Form B or on an attached sheet(s). These might be such things as leases.

RETURN WITH BID

ILLINOIS DEPARTMENT OF TRANSPORTATION

Form A Financial Information & Potential Conflicts of Interest Disclosure

Contractor Name
Legal Address
City, State, Zip
Telephone Number Email Address Fax Number (if available)

Disclosure of the information contained in this Form is required by Section 50-35 of the Code (30 ILCS 500). Vendors desiring to enter into a contract with the State of Illinois must disclose the financial information and potential conflict of interest information as specified in this Disclosure Form. This information shall become part of the publicly available contract file. This Form A must be completed for bids in excess of \$50,000, and for all open-ended contracts. A publicly traded company may submit a 10K disclosure (or equivalent if applicable) in satisfaction of the requirements set forth in Form A. See Disclosure Form Instructions.

The current annual salary of the Governor is \$177,412.00.

DISCLOSURE OF FINANCIAL INFORMATION

- 1. Disclosure of Financial Information. The individual named below has an interest in the BIDDER (or its parent) in terms of ownership or distributive income share in excess of 5%, or an interest which has a value of more than 60% of the annual salary of the Governor. (Make copies of this form as necessary and attach a separate Disclosure Form A for each individual meeting these requirements)

FOR INDIVIDUAL (type or print information)
NAME:
ADDRESS
Type of ownership/distributable income share:
stock sole proprietorship Partnership other: (explain on separate sheet):
% or \$ value of ownership/distributable income share:

- 2. Disclosure of Potential Conflicts of Interest. Check "Yes" or "No" to indicate which, if any, of the following potential conflict of interest relationships apply. If the answer to any question is "Yes", please attach additional pages and describe.

(a) State employment, currently or in the previous 3 years, including contractual employment of services. Yes ___ No ___

If your answer is yes, please answer each of the following questions.

- 1. Are you currently an officer or employee of either the Capitol Development Board or the Illinois State Toll Highway Authority? Yes ___ No ___
2. Are you currently appointed to or employed by any agency of the State of Illinois? If you are currently appointed to or employed by any agency of the State of Illinois, and your annual salary exceeds 60% of the annual salary of the Governor provide the name the State agency for which you are employed and your annual salary.

RETURN WITH BID

3. If you are currently appointed to or employed by any agency of the State of Illinois, and your annual salary exceeds 60% of the annual salary of the Governor, are you entitled to receive (i) more than 7 1/2% of the total distributable income of your firm, partnership, association or corporation, or (ii) an amount in excess of 100% of the annual salary of the Governor? Yes ___ No ___
4. If you are currently appointed to or employed by any agency of the State of Illinois, and your annual salary exceeds 60% of the annual salary of the Governor, are you and your spouse or minor children entitled to receive (i) more than 15% in aggregate of the total distributable income of your firm, partnership, association or corporation, or (ii) an amount in excess of two times the salary of the Governor? Yes ___ No ___

(b) State employment of spouse, father, mother, son, or daughter, including contractual employment for services in the previous 2 years.

Yes ___ No ___

If your answer is yes, please answer each of the following questions.

1. Is your spouse or any minor children currently an officer or employee of the Capitol Development Board or the Illinois State Toll Highway Authority? Yes ___ No ___
2. Is your spouse or any minor children currently appointed to or employed by any agency of the State of Illinois? If your spouse or minor children is/are currently appointed to or employed by any agency of the State of Illinois, and his/her annual salary exceeds 60% of the annual salary of the Governor, provide the name of the spouse and/or minor children, the name of the State agency for which he/she is employed and his/her annual salary. _____

-
3. If your spouse or any minor children is/are currently appointed to or employed by any agency of the State of Illinois, and his/her annual salary exceeds 60% of the annual salary of the Governor, are you entitled to receive (i) more than 7 1/2% of the total distributable income of your firm, partnership, association or corporation, or (ii) an amount in excess 100% of the annual salary of the Governor? Yes ___ No ___
4. If your spouse or any minor children are currently appointed to or employed by any agency of the State of Illinois, and his/her annual salary exceeds 60% of the annual salary of the Governor, are you and your spouse or any minor children entitled to receive (i) more than 15% in the aggregate of the total distributable income from your firm, partnership, association or corporation, or (ii) an amount in excess of two times the salary of the Governor? Yes ___ No ___

(c) Elective status; the holding of elective office of the State of Illinois, the government of the United States, any unit of local government authorized by the Constitution of the State of Illinois or the statutes of the State of Illinois currently or in the previous 3 years. Yes ___ No ___

(d) Relationship to anyone holding elective office currently or in the previous 2 years; spouse, father, mother, son, or daughter. Yes ___ No ___

(e) Appointive office; the holding of any appointive government office of the State of Illinois, the United State of America, or any unit of local government authorized by the Constitution of the State of Illinois or the statutes of the State of Illinois, which office entitles the holder to compensation in excess of the expenses incurred in the discharge of that office currently or in the previous 3 years. Yes ___ No ___

(f) Relationship to anyone holding appointive office currently or in the previous 2 years; spouse, father, mother, son, or daughter. Yes ___ No ___

(g) Employment, currently or in the previous 3 years, as or by any registered lobbyist of the State government. Yes ___ No ___

RETURN WITH BID

(h) Relationship to anyone who is or was a registered lobbyist in the previous 2 years; spouse, father, mother, son, or daughter. Yes ___ No ___

(i) Compensated employment, currently or in the previous 3 years, by any registered election or reelection committee registered with the Secretary of State or any county clerk of the State of Illinois, or any political action committee registered with either the Secretary of State or the Federal Board of Elections. Yes ___ No ___

(j) Relationship to anyone; spouse, father, mother, son, or daughter; who was a compensated employee in the last 2 years by any registered election or re-election committee registered with the Secretary of State or any county clerk of the State of Illinois, or any political action committee registered with either the Secretary of State or the Federal Board of Elections. Yes ___ No ___

3. Communication Disclosure.

Disclose the name and address of each lobbyist and other agent of the bidder or offeror who is not identified in Section 2 of this form, who is has communicated, is communicating, or may communicate with any State officer or employee concerning the bid or offer. This disclosure is a continuing obligation and must be promptly supplemented for accuracy throughout the process and throughout the term of the contract. If no person is identified, enter "None" on the line below:

Name and address of person(s): _____

RETURN WITH BID

4. Suspension or Debarment Disclosure. For each of the persons identified under Sections 2 and 3 of this form, disclose whether any of the following has occurred within the previous 10 years: suspension or debarment from contracting with any governmental entity; professional licensure discipline; bankruptcies; adverse civil judgments and administrative findings; and criminal felony convictions. This disclosure is a continuing obligation and must be promptly supplemented for accuracy throughout the procurement process and term of the contract. If no person is identified, enter "None" on the line below:

Name of person(s): _____

Nature of disclosure: _____

APPLICABLE STATEMENT

This Disclosure Form A is submitted on behalf of the INDIVIDUAL named on previous page. Under penalty of perjury, I certify the contents of this disclosure to be true and accurate to the best of my knowledge.

Completed by: _____ Date _____
Signature of Individual or Authorized Representative

NOT APPLICABLE STATEMENT

Under penalty of perjury, I have determined that no individuals associated with this organization meet the criteria that would require the completion of this Form A.

This Disclosure Form A is submitted on behalf of the CONTRACTOR listed on the previous page.

_____ Date _____
Signature of Authorized Representative

The bidder has a continuing obligation to supplement these disclosures under Sec. 50-35 of the Code.

RETURN WITH BID

ILLINOIS DEPARTMENT OF TRANSPORTATION

Form B Other Contracts & Financial Related Information Disclosure

Contractor Name, Legal Address, City, State, Zip, Telephone Number, Email Address, Fax Number (if available)

Disclosure of the information contained in this Form is required by Section 50-35 of the Code (30 ILCS 500). This information shall become part of the publicly available contract file. This Form B must be completed for all bids.

DISCLOSURE OF OTHER CONTRACTS AND PROCUREMENT RELATED INFORMATION

1. Identifying Other Contracts & Procurement Related Information. The BIDDER shall identify whether it has any pending contracts (including leases), bids, proposals, or other ongoing procurement relationship with any other State of Illinois agency: Yes ___ No ___ If "No" is checked, the bidder only needs to complete the signature box on this page.

2. If "Yes" is checked. Identify each such relationship by showing State of Illinois agency name and other descriptive information such as bid or project number (attach additional pages as necessary). SEE DISCLOSURE FORM INSTRUCTIONS:

THE FOLLOWING STATEMENT MUST BE CHECKED

Signature of Authorized Representative, Date

OWNERSHIP CERTIFICATION

Please certify that the following statement is true if the individuals for all submitted Form A disclosures do not total 100% of ownership.

Any remaining ownership interest is held by individuals receiving less than \$106,447.20 of the bidding entity's or parent entity's distributive income or holding less than a 5% ownership interest.

Yes No N/A (Form A disclosure(s) established 100% ownership)

RETURN WITH BID

SPECIAL NOTICE TO CONTRACTORS

The following requirements of the Illinois Department of Human Rights Act are applicable to bidders on all construction contracts advertised by the Illinois Department of Transportation:

CONSTRUCTION EMPLOYEE UTILIZATION PROJECTION

- (a) All bidders on construction contracts shall complete and submit, along with and as part of their bids, a Bidder's Employee Utilization Form (Form BC-1256) setting forth a projection and breakdown of the total workforce intended to be hired and/or allocated to such contract work by the bidder including a projection of minority and female employee utilization in all job classifications on the contract project.
- (b) The Department of Transportation shall review the Employee Utilization Form, and workforce projections contained therein, of the contract awardee to determine if such projections reflect an underutilization of minority persons and/or women in any job classification in accordance with the Equal Employment Opportunity Clause and Title 44, Illinois Administrative Code, Section 750.120. If it is determined that the contract awardee's projections reflect an underutilization of minority persons and/or women in any job classification, it shall be advised in writing of the manner in which it is underutilizing and such awardee shall be considered to be in breach of the contract unless, prior to commencement of work on the contract project, it submits revised satisfactory projections or an acceptable written affirmative action plan to correct such underutilization including a specific timetable geared to the completion stages of the contract.
- (c) The Department of Transportation shall provide to the Department of Human Rights a copy of the contract awardee's Employee Utilization Form, a copy of any required written affirmative action plan, and any written correspondence related thereto. The Department of Human Rights may review and revise any action taken by the Department of Transportation with respect to these requirements.



RETURN WITH BID

Contract No. 61A39
DUPAGE County
Section 13-00046-00-LS (Oak Brook)
Project TE-00D1(943)
Route FAU 1453 (West 22nd Street)
District 1 Construction Funds

PART I. IDENTIFICATION

Dept. of Human Rights # _____ Duration of Project: _____

Name of Bidder: _____

PART II. WORKFORCE PROJECTION

A. The undersigned bidder has analyzed minority group and female populations, unemployment rates and availability of workers for the location in which this contract work is to be performed, and for the locations from which the bidder recruits employees, and hereby submits the following workforce projection including a projection for minority and female employee utilization in all job categories in the workforce to be allocated to this contract:

TOTAL Workforce Projection for Contract													TABLE B CURRENT EMPLOYEES TO BE ASSIGNED TO CONTRACT			
JOB CATEGORIES	TOTAL EMPLOYEES		MINORITY EMPLOYEES						TRAINEES				TOTAL EMPLOYEES		MINORITY EMPLOYEES	
			BLACK		HISPANIC		*OTHER MINOR.		APPRENTICES		ON THE JOB TRAINEES					
	M	F	M	F	M	F	M	F	M	F	M	F	M	F	M	F
OFFICIALS (MANAGERS)																
SUPERVISORS																
FOREMEN																
CLERICAL																
EQUIPMENT OPERATORS																
MECHANICS																
TRUCK DRIVERS																
IRONWORKERS																
CARPENTERS																
CEMENT MASONS																
ELECTRICIANS																
PIPEFITTERS, PLUMBERS																
PAINTERS																
LABORERS, SEMI-SKILLED																
LABORERS, UNSKILLED																
TOTAL																

TABLE C TOTAL Training Projection for Contract								
EMPLOYEES IN TRAINING	TOTAL EMPLOYEES		BLACK		HISPANIC		*OTHER MINOR.	
	M	F	M	F	M	F	M	F
APPRENTICES								
ON THE JOB TRAINEES								

FOR DEPARTMENT USE ONLY

*Other minorities are defined as Asians (A) or Native Americans (N).
Please specify race of each employee shown in Other Minorities column.

Note: See instructions on page 2

RETURN WITH BID

**Contract No. 61A39
DUPAGE County
Section 13-00046-00-LS (Oak Brook)
Project TE-00D1(943)
Route FAU 1453 (West 22nd Street)
District 1 Construction Funds**

PART II. WORKFORCE PROJECTION - continued

- B. Included in "Total Employees" under Table A is the total number of **new hires** that would be employed in the event the undersigned bidder is awarded this contract.

The undersigned bidder projects that: (number) _____ new hires would be recruited from the area in which the contract project is located; and/or (number) _____ new hires would be recruited from the area in which the bidder's principal office or base of operation is located.

- C. Included in "Total Employees" under Table A is a projection of numbers of persons to be employed directly by the undersigned bidder as well as a projection of numbers of persons to be employed by subcontractors.

The undersigned bidder estimates that (number) _____ persons will be directly employed by the prime contractor and that (number) _____ persons will be employed by subcontractors.

PART III. AFFIRMATIVE ACTION PLAN

- A. The undersigned bidder understands and agrees that in the event the foregoing minority and female employee utilization projection included under **PART II** is determined to be an underutilization of minority persons or women in any job category, and in the event that the undersigned bidder is awarded this contract, he/she will, prior to commencement of work, develop and submit a written Affirmative Action Plan including a specific timetable (geared to the completion stages of the contract) whereby deficiencies in minority and/or female employee utilization are corrected. Such Affirmative Action Plan will be subject to approval by the contracting agency and the **Illinois Department of Human Rights**.
- B. The undersigned bidder understands and agrees that the minority and female employee utilization projection submitted herein, and the goals and timetable included under an Affirmative Action Plan if required, are deemed to be part of the contract specifications.

Company _____ Telephone Number _____

Address _____

NOTICE REGARDING SIGNATURE

The Bidder's signature on the Proposal Signature Sheet will constitute the signing of this form. The following signature block needs to be completed only if revisions are required.

Signature: _____ Title: _____ Date: _____

- Instructions: All tables must include subcontractor personnel in addition to prime contractor personnel.
- Table A - Include both the number of employees that would be hired to perform the contract work and the total number currently employed (Table B) that will be allocated to contract work, and include all apprentices and on-the-job trainees. The "Total Employees" column should include all employees including all minorities, apprentices and on-the-job trainees to be employed on the contract work.
 - Table B - Include all employees currently employed that will be allocated to the contract work including any apprentices and on-the-job trainees currently employed.
 - Table C - Indicate the racial breakdown of the total apprentices and on-the-job trainees shown in Table A.

RETURN WITH BID

ADDITIONAL FEDERAL REQUIREMENTS

In addition to the Required Contract Provisions for Federal-Aid Construction Contracts (FHWA 1273), all bidders make the following certifications.

- A. By the execution of this proposal, the signing bidder certifies that the bidding entity has not, either directly or indirectly, entered into any agreement, participated in any collusion, or otherwise taken any action, in restraint of free competitive bidding in connection with the submitted bid. This statement made by the undersigned bidder is true and correct under penalty of perjury under the laws of the United States.
- B. CERTIFICATION, EQUAL EMPLOYMENT OPPORTUNITY:
1. Have you participated in any previous contracts or subcontracts subject to the equal opportunity clause. YES _____ NO _____
 2. If answer to #1 is yes, have you filed with the Joint Reporting Committee, the Director of OFCC, any Federal agency, or the former President's Committee on Equal Employment Opportunity, all reports due under the applicable filing requirements of those organizations?
YES _____ NO _____

RETURN WITH BID

**Contract No. 61A39
DUPAGE County
Section 13-00046-00-LS (Oak Brook)
Project TE-00D1(943)
Route FAU 1453 (West 22nd Street)
District 1 Construction Funds**

PROPOSAL SIGNATURE SHEET

The undersigned bidder hereby makes and submits this bid on the subject Proposal, thereby assuring the Department that all requirements of the Invitation for Bids and rules of the Department have been met, that there is no misunderstanding of the requirements of paragraph 3 of this Proposal, and that the contract will be executed in accordance with the rules of the Department if an award is made on this bid.

(IF AN INDIVIDUAL)

Firm Name _____
Signature of Owner _____
Business Address _____

(IF A CO-PARTNERSHIP)

Firm Name _____
By _____
Business Address _____
Name and Address of All Members of the Firm: _____

(IF A CORPORATION)

Corporate Name _____
By _____
Signature of Authorized Representative _____
Typed or printed name and title of Authorized Representative _____
Attest _____
Signature _____
(IF A JOINT VENTURE, USE THIS SECTION FOR THE MANAGING PARTY AND THE SECOND PARTY SHOULD SIGN BELOW)
Business Address _____

(IF A JOINT VENTURE)

Corporate Name _____
By _____
Signature of Authorized Representative _____
Typed or printed name and title of Authorized Representative _____
Attest _____
Signature _____
Business Address _____

If more than two parties are in the joint venture, please attach an additional signature sheet.



This Annual Proposal Bid Bond shall become effective at 12:01 AM (CDST) on _____ and shall be valid until _____ 11:59 PM (CDST).

KNOW ALL PERSONS BY THESE PRESENTS, That We _____

as PRINCIPAL, and _____

as SURETY, and held jointly, severally and firmly bound unto the STATE OF ILLINOIS in the penal sum of 5 percent of the total bid price, or for the amount specified in the bid proposal under "Proposal Guaranty" in effect on the date of the Invitation for Bids, whichever is the lesser sum, well and truly to be paid unto said STATE OF ILLINOIS, for the payment of which we bind ourselves, our heirs, executors, administrators, successors and assigns.

THE CONDITION OF THE FOREGOING OBLIGATION IS SUCH that whereas, the PRINCIPAL may submit bid proposal(s) to the STATE OF ILLINOIS, acting through the Department of Transportation, for various improvements published in the Transportation Bulletin during the effective term indicated above.

NOW, THEREFORE, if the Department shall accept the bid proposal(s) of the PRINCIPAL; and if the PRINCIPAL shall, within the time and as specified in the bidding and contract documents; and if, after award by the Department, the PRINCIPAL shall enter into a contract in accordance with the terms of the bidding and contract documents including evidence of the required insurance coverages and providing such bond as specified with good and sufficient surety for the faithful performance of such contract and for the prompt payment of labor and material furnished in the prosecution thereof; or if, in the event of the failure of the PRINCIPAL to enter into such contract and to give the specified bond, the PRINCIPAL pays to the Department the difference not to exceed the penalty hereof between the amount specified in the bid proposal and such larger amount for which the Department may contract with another party to perform the work covered by said bid proposal, then this obligation shall be null and void, otherwise, it shall remain in full force and effect.

IN THE EVENT the Department determines the PRINCIPAL has failed to comply with any requirement as set forth in the preceding paragraph, then Surety shall pay the penal sum to the Department within fifteen (15) days of written demand therefor. If Surety does not make full payment within such period of time, the Department may bring an action to collect the amount owed. Surety is liable to the Department for all its expenses, including attorney's fees, incurred in any litigation in which it prevails either in whole or in part.

In TESTIMONY WHEREOF, the said PRINCIPAL has caused this instrument to be signed by its officer _____ day of _____ A.D., _____

In TESTIMONY WHEREOF, the said SURETY has caused this instrument to be signed by its officer _____ day of _____ A.D., _____

(Company Name)

(Company Name)

By _____
(Signature and Title)

By _____
(Signature of Attorney-in-Fact)

Notary for PRINCIPAL

Notary for SURETY

STATE OF _____
COUNTY OF _____

STATE OF _____
COUNTY OF _____

Signed and attested before me on _____ (date)

Signed and attested before me on _____ (date)

by _____
(Name of Notary Public)

by _____
(Name of Notary Public)

(Seal) _____
(Signature of Notary Public)

(Seal) _____
(Signature of Notary Public)

(Date Commission Expires)

(Date Commission Expires)

In lieu of completing the above section of the Annual Proposal Bid Bond form, the Principal may file an Electronic Bid Bond. By signing the proposal(s) the Principal is ensuring the identified electronic bid bond has been executed and the Principal and Surety are firmly bound unto the State of Illinois under the conditions of the bid bond as shown above.

Electronic Bid Bond ID #	Company/Bidder Name	Signature and Title
--------------------------	---------------------	---------------------

This bond may be terminated, at Surety's request, upon giving not less than thirty (30) days prior written notice of the cancellation/termination of the bond. Said written notice shall be issued to the Illinois Department of Transportation, Chief Contracts Official, 2300 South Dirksen Parkway, Springfield, Illinois, 62764, and shall be served in person, by receipted courier delivery or certified or registered mail, return receipt requested. Said notice period shall commence on the first calendar day following the Department's receipt of written cancellation/termination notice. Surety shall remain firmly bound to all obligations herein for proposals submitted prior to the cancellation/termination. Surety shall be released and discharged from any obligation(s) for proposals submitted for any letting or date after the effective date of cancellation/termination.



Return with Bid

Division of Highways
Proposal Bid Bond

Item No. _____

Letting Date _____

KNOW ALL PERSONS BY THESE PRESENTS, That We _____

as PRINCIPAL, and _____

as SURETY, and held jointly, severally and firmly bound unto the STATE OF ILLINOIS in the penal sum of 5 percent of the total bid price, or for the amount specified in the bid proposal under "Proposal Guaranty" in effect on the date of the Invitation for Bids, whichever is the lesser sum, well and truly to be paid unto said STATE OF ILLINOIS, for the payment of which we bind ourselves, our heirs, executors, administrators, successors and assigns.

THE CONDITION OF THE FOREGOING OBLIGATION IS SUCH that whereas, the PRINCIPAL has submitted a bid proposal to the STATE OF ILLINOIS, acting through the Department of Transportation, for the improvement designated by the Transportation Bulletin Item Number and Letting Date indicated above.

NOW, THEREFORE, if the Department shall accept the bid proposal of the PRINCIPAL; and if the PRINCIPAL shall, within the time and as specified in the bidding and contract documents; and if, after award by the Department, the PRINCIPAL shall enter into a contract in accordance with the terms of the bidding and contract documents including evidence of the required insurance coverages and providing such bond as specified with good and sufficient surety for the faithful performance of such contract and for the prompt payment of labor and material furnished in the prosecution thereof; or if, in the event of the failure of the PRINCIPAL to enter into such contract and to give the specified bond, the PRINCIPAL pays to the Department the difference not to exceed the penalty hereof between the amount specified in the bid proposal and such larger amount for which the Department may contract with another party to perform the work covered by said bid proposal, then this obligation shall be null and void, otherwise, it shall remain in full force and effect.

IN THE EVENT the Department determines the PRINCIPAL has failed to comply with any requirement as set forth in the preceding paragraph, then Surety shall pay the penal sum to the Department within fifteen (15) days of written demand therefor. If Surety does not make full payment within such period of time, the Department may bring an action to collect the amount owed. Surety is liable to the Department for all its expenses, including attorney's fees, incurred in any litigation in which it prevails either in whole or in part.

In TESTIMONY WHEREOF, the said PRINCIPAL has caused this instrument to be signed by its officer _____ day of _____ A.D., _____

In TESTIMONY WHEREOF, the said SURETY has caused this instrument to be signed by its officer _____ day of _____ A.D., _____

(Company Name)

(Company Name)

By _____ (Signature and Title)

By _____ (Signature of Attorney-in-Fact)

Notary for PRINCIPAL

Notary for SURETY

STATE OF _____
COUNTY OF _____

STATE OF _____
COUNTY OF _____

Signed and attested before me on _____ (date)
by _____

Signed and attested before me on _____ (date)
by _____

(Name of Notary Public)

(Name of Notary Public)

(Seal) _____ (Signature of Notary Public)

(Seal) _____ (Signature of Notary Public)

(Date Commission Expires)

(Date Commission Expires)

In lieu of completing the above section of the Proposal Bid Bond form, the Principal may file an Electronic Bid Bond. By signing the proposal the Principal is ensuring the identified electronic bid bond has been executed and the Principal and Surety are firmly bound unto the State of Illinois under the conditions of the bid bond as shown above.

Electronic Bid Bond ID # _____ Company/Bidder Name _____ Signature and Title _____

(1) Policy

It is public policy that disadvantageded businesses as defined in 49 CFR Part 26 and the Special Provision shall have the maximum opportunity to participate in the performance of contracts financed in whole or in part with Federal or State funds. Consequently the requirements of 49 CFR Part 26 apply to this contract.

(2) Obligation

The contractor agrees to ensure that disadvantageded businesses as defined in 49 CFR Part 26 and the Special Provision have the maximum opportunity to participate in the performance of contracts or subcontracts financed in whole or in part with Federal or State funds. The contractor shall take all necessary and reasonable steps in accordance with 49 CFR Part 26 and the Special Provision to ensure that said businesses have the maximum opportunity to compete for and perform under this contract. The contractor shall not discriminate on the basis of race, color, national origin or sex in the award and performance of contracts.

(3) Project and Bid Identification

Complete the following information concerning the project and bid:

Route _____	Total Bid _____
Section _____	Contract DBE Goal _____ (Percent) _____ (Dollar Amount)
Project _____	
County _____	
Letting Date _____	
Contract No. _____	
Letting Item No. _____	

(4) Assurance

I, acting in my capacity as an officer of the undersigned bidder (or bidders if a joint venture), hereby assure the Department that on this project my company : (check one)

- Meets or exceeds contract award goals and has provided documented participation as follows:
Disadvantaged Business Participation _____ percent

Attached are the signed participation statements, forms SBE 2025, required by the Special Provision evidencing availability and use of each business participating in this plan and assuring that each business will perform a commercially useful function in the work of the contract.

- Failed to meet contract award goals and has included good faith effort documentation to meet the goals and that my company has provided participation as follows:

Disadvantaged Business Participation _____ percent

The contract goals should be accordingly modified or waived. Attached is all information required by the Special Provision in support of this request including good faith effort. Also attached are the signed participation statements, forms SBE 2025, required by the Special Provision evidencing availability and use of each business participating in this plan and assuring that each business will perform a commercially useful function in the work of the contract.

Company

By _____

Title _____

Date _____

The "as read" Low Bidder is required to comply with the Special Provision.

Submit only one utilization plan for each project. The utilization plan shall be submitted in accordance with the special provision.

Bureau of Small Business Enterprises
2300 South Dirksen Parkway
Springfield, Illinois 62764

Local Let Projects
Submit forms to the
Local Agency



Subcontractor Registration Number _____

Letting _____

Participation Statement

Item No. _____

(1) Instructions

Contract No. _____

This form must be completed for each disadvantaged business participating in the Utilization Plan. This form shall be submitted in accordance with the special provision and will be attached to the Utilization Plan form. If additional space is needed complete an additional form for the firm. Trucking participation items; description must list what is anticipated towards goal credit.

(2) Work:

Please indicate: J/V _____ Manufacturer _____ Supplier (60%) _____ Subcontractor _____ Trucking _____

Pay Item No.	Description (Anticipated items for trucking)*	Quantity	Unit Price	Total
Total				

(3) Partial Payment Items (For any of the above items which are partial pay items)

Description must be sufficient to determine a Commercially Useful Function, specifically describe the work and subcontract dollar amount:

*Applies to trucking only

(4) Commitment

When a DBE is to be a second-tier subcontractor, or if the first-tier DBE subcontractor is going to be subcontracting a portion of its subcontract, it must be clearly indicated on the DBE Participation Statement, and the details of the transaction fully explained.

In the event a DBE subcontractor second-tiers a portion of its subcontract to one or more subcontractors during the work of a contract, the prime must submit a DBE Participation Statement, with the details of the transaction(s) fully explained.

The undersigned certify that the information included herein is true and correct, and that the DBE firm listed below has agreed to perform a commercially useful function in the work of the contract item(s) listed above and to execute a contract with the prime contractor or 1st Tier subcontractor. The undersigned further understand that no changes to this statement may be made without prior approval from the Department's Bureau of Small Business Enterprises and that complete and accurate information regarding actual work performed on this project and the payment therefore must be provided to the Department.

Signature for Contractor __ 1st Tier __ 2nd Tier

Date _____

Contact Person _____

Title _____

Firm Name _____

Address _____

City/State/Zip _____

Phone _____

Email Address _____

Signature for DBE Firm __ 1st Tier __ 2nd Tier

Date _____

Contact Person _____

Title _____

Firm Name _____

Address _____

City/State/Zip _____

Phone _____

Email Address _____

E _____

WC _____

The Department of Transportation is requesting disclosure of information that is necessary to accomplish the statutory purpose as outlined under the state and federal law. Disclosure of this information is **REQUIRED**. Failure to provide any information will result in the contract not being awarded. This form has been approved by the State Forms Management Center.

PROPOSAL ENVELOPE



PROPOSALS

for construction work advertised for bids by the
Illinois Department of Transportation

Item No.	Item No.	Item No.

Submitted By:

Name:
Address:
Phone No.

Bidders should use an IDOT proposal envelope or affix this form to the front of a 10" x 13" envelope for the submittal of bids. If proposals are mailed, they should be enclosed in a second or outer envelope addressed to:

Engineer of Design and Environment - Room 326
Illinois Department of Transportation
2300 South Dirksen Parkway
Springfield, Illinois 62764

NOTICE

Individual bids, including Bid Bond and/or supplemental information if required, should be securely stapled.

CONTRACTOR OFFICE COPY OF CONTRACT SPECIFICATIONS

NOTICE

None of the following material needs to be returned with the bid package unless the special provisions require documentation and/or other information to be submitted.

**Contract No. 61A39
DUPAGE County
Section 13-00046-00-LS (Oak Brook)
Project TE-00D1(943)
Route FAU 1453 (West 22nd Street)
District 1 Construction Funds**



Illinois Department of Transportation

SUBCONTRACTOR DOCUMENTATION

Public Acts 96-0795, 96-0920, and 97-0895 enacted substantial changes to the provisions of the Code (30 ILCS 500). Among the changes are provisions affecting subcontractors. The Contractor awarded this contract will be required as a material condition of the contract to implement and enforce the contract requirements applicable to subcontractors that entered into a contractual agreement with a total value of \$50,000 or more with a person or entity who has a contract subject to the Code and approved in accordance with article 108.01 of the Standard Specifications for Road and Bridge Construction.

If the Contractor seeks approval of subcontractors to perform a portion of the work, and approval is granted by the Department, the Contractor shall provide a copy of the subcontract to the Illinois Department of Transportation's CPO upon request within 15 calendar days after execution of the subcontract.

Financial disclosures required pursuant to Sec. 50-35 of the Code must be submitted for all applicable subcontractors. The subcontract shall contain the certifications required to be made by subcontractors pursuant to Article 50 of the Code. This Notice to Bidders includes a document incorporating all required subcontractor certifications and disclosures for use by the Contractor in compliance with this mandate. The document is entitled State Required Ethical Standards Governing Subcontractors.

RETURN WITH SUBCONTRACT

STATE ETHICAL STANDARDS GOVERNING SUBCONTRACTORS

Article 50 of the Code establishes the duty of all State CPOs, SPOs, and their designees to maximize the value of the expenditure of public moneys in procuring goods, services, and contracts for the State of Illinois and to act in a manner that maintains the integrity and public trust of State government. In discharging this duty, they are charged by law to use all available information, reasonable efforts, and reasonable actions to protect, safeguard, and maintain the procurement process of the State of Illinois.

The certifications hereinafter made by the subcontractor are each a material representation of fact upon which reliance is placed should the Department approve the subcontractor. The CPO may terminate or void the contract approval if it is later determined that the bidder or subcontractor rendered a false or erroneous certification. If a false certification is made by a subcontractor the contractor's submitted bid and the executed contract may not be declared void unless the contractor refuses to terminate the subcontract upon the State's request after a finding that the subcontractor's certification was false.

Section 50-2 of the Code provides that every person that has entered into a multi-year contract and every subcontractor with a multi-year subcontract shall certify, by July 1 of each fiscal year covered by the contract after the initial fiscal year, to the responsible CPO whether it continues to satisfy the requirements of Article 50 pertaining to the eligibility for a contract award. If a contractor or subcontractor is not able to truthfully certify that it continues to meet all requirements, it shall provide with its certification a detailed explanation of the circumstances leading to the change in certification status. A contractor or subcontractor that makes a false statement material to any given certification required under Article 50 is, in addition to any other penalties or consequences prescribed by law, subject to liability under the Whistleblower Reward and Protection Act for submission of a false claim.

A. Bribery

Section 50-5. Bribery.

(a) Prohibition. No person or business shall be awarded a contract or subcontract under this Code who:

(1) has been convicted under the laws of Illinois or any other state of bribery or attempting to bribe an officer or employee of the State of Illinois or any other state in that officer's or employee's official capacity; or

(2) has made an admission of guilt of that conduct that is a matter of record but has not been prosecuted for that conduct.

(b) Businesses. No business shall be barred from contracting with any unit of State or local government, or subcontracting under such a contract, as a result of a conviction under this Section of any employee or agent of the business if the employee or agent is no longer employed by the business and:

(1) the business has been finally adjudicated not guilty; or

(2) the business demonstrates to the governmental entity with which it seeks to contract, or which is signatory to the contract to which the subcontract relates, and that entity finds that the commission of the offense was not authorized, requested, commanded, or performed by a director, officer, or high managerial agent on behalf of the business as provided in paragraph (2) of subsection (a) of Section 5-4 of the Criminal Code of 2012.

(c) Conduct on behalf of business. For purposes of this Section, when an official, agent, or employee of a business committed the bribery or attempted bribery on behalf of the business and in accordance with the direction or authorization of a responsible official of the business, the business shall be chargeable with the conduct.

(d) Certification. Every bid submitted to and contract executed by the State, and every subcontract subject to Section 20-120 of the Code shall contain a certification by the contractor or the subcontractor, respectively, that the contractor or subcontractor is not barred from being awarded a contract or subcontract under this Section and acknowledges that the CPO may declare the related contract void if any certifications required by this Section are false. A contractor who makes a false statement, material to the certification, commits a Class 3 felony.

The contractor or subcontractor certifies that it is not barred from being awarded a contract under Section 50-5.

B. Felons

Section 50-10. Felons.

(a) Unless otherwise provided, no person or business convicted of a felony shall do business with the State of Illinois or any State agency, or enter into a subcontract, from the date of conviction until 5 years after the date of completion of the sentence for that felony, unless no person held responsible by a prosecutorial office for the facts upon which the conviction was based continues to have any involvement with the business.

(b) Certification. Every bid submitted to and contract executed by the State and every subcontract subject to Section 20-120 of the Code shall contain a certification by the bidder or contractor or subcontractor, respectively, that the bidder, contractor, or subcontractor is not barred from being awarded a contract or subcontract under this Section and acknowledges that the CPO may declare the related contract void if any of the certifications required by this Section are false.

RETURN WITH SUBCONTRACT

C. Debt Delinquency

Section 50-11 and 50-12. Debt Delinquency.

The contractor or bidder or subcontractor, respectively, certifies that it, or any affiliate, is not barred from being awarded a contract or subcontract under the Code. Section 50-11 prohibits a person from entering into a contract with a State agency, or entering into a subcontract, if it knows or should know that it, or any affiliate, is delinquent in the payment of any debt to the State as defined by the Debt Collection Board. Section 50-12 prohibits a person from entering into a contract with a State agency, or entering into a subcontract, if it, or any affiliate, has failed to collect and remit Illinois Use Tax on all sales of tangible personal property into the State of Illinois in accordance with the provisions of the Illinois Use Tax Act. The bidder or contractor or subcontractor, respectively, further acknowledges that the CPO may declare the related contract void if this certification is false or if the bidder, contractor, or subcontractor, or any affiliate, is determined to be delinquent in the payment of any debt to the State during the term of the contract.

D. Prohibited Bidders, Contractors and Subcontractors

Section 50-10.5 and 50-60(c). Prohibited bidders, contractors and subcontractors.

The bidder or contractor or subcontractor, respectively, certifies in accordance with 30 ILCS 500/50-10.5 that no officer, director, partner or other managerial agent of the contracting business has been convicted of a felony under the Sarbanes-Oxley Act of 2002 or a Class 3 or Class 2 felony under the Illinois Securities Law of 1953 or if in violation of Subsection (c) for a period of five years from the date of conviction. Every bid submitted to and contract executed by the State and every subcontract subject to Section 20-120 of the Code shall contain a certification by the bidder, contractor, or subcontractor, respectively, that the bidder, contractor, or subcontractor is not barred from being awarded a contract or subcontract under this Section and acknowledges that the CPO shall declare the related contract void if any of the certifications completed pursuant to this Section are false.

E. Section 42 of the Environmental Protection Act

The bidder or contractor or subcontractor, respectively, certifies in accordance with 30 ILCS 500/50-14 that the bidder, contractor, or subcontractor, is not barred from being awarded a contract or entering into a subcontract under this Section which prohibits the bidding on or entering into contracts with the State of Illinois or a State agency, or entering into any subcontract, that is subject to the Code by a person or business found by a court or the Pollution Control Board to have committed a willful or knowing violation of Section 42 of the Environmental Protection Act for a period of five years from the date of the order. The bidder or contractor or subcontractor, respectively, acknowledges that the CPO may declare the contract void if this certification is false.

The undersigned, on behalf of the subcontracting company, has read and understands the above certifications and makes the certifications as required by law.

Name of Subcontracting Company

Authorized Officer

Date

RETURN WITH SUBCONTRACT
SUBCONTRACTOR DISCLOSURES

I. DISCLOSURES

A. The disclosures hereinafter made by the subcontractor are each a material representation of fact upon which reliance is placed. The subcontractor further certifies that the Department has received the disclosure forms for each subcontract.

The CPO may void the bid, contract, or subcontract, respectively, if it is later determined that the bidder or subcontractor rendered a false or erroneous disclosure. A contractor or subcontractor may be suspended or debarred for violations of the Code. Furthermore, the CPO may void the contract.

B. Financial Interests and Conflicts of Interest

1. Section 50-35 of the Code provides that all subcontracts with a total value of \$50,000 or more, from subcontractors identified in Section 20-120 of the Code, shall be accompanied by disclosure of the financial interests of the subcontractor. This disclosed information for the subcontractor, will be maintained as public information subject to release by request pursuant to the Freedom of Information Act, filed with the Procurement Policy Board, and shall be incorporated as a material term of the Prime Contractor's contract. Furthermore, pursuant to this Section, the Procurement Policy Board may recommend to allow or void a contract or subcontract based on a potential conflict of interest.

The financial interests to be disclosed shall include ownership or distributive income share that is in excess of 5%, or an amount greater than 60% of the annual salary of the Governor, of the subcontracting entity or its parent entity, whichever is less, unless the subcontractor is a publicly traded entity subject to Federal 10K reporting, in which case it may submit its 10K disclosure in place of the prescribed disclosure. If a subcontractor is a privately held entity that is exempt from Federal 10K reporting, but has more than 100 shareholders, it may submit the information that Federal 10K companies are required to report, and list the names of any individual or entity holding any ownership share that is in excess of 5%. The disclosure shall include the names, addresses, and dollar or proportionate share of ownership of each individual making the disclosure, their instrument of ownership or beneficial relationship, and notice of any potential conflict of interest resulting from the current ownership or beneficial interest of each individual making the disclosure having any of the relationships identified in Section 50-35 and on the disclosure form.

The current annual salary of the Governor is \$177,412.00.

In addition, all disclosures shall indicate any other current or pending contracts, subcontracts, proposals, leases, or other ongoing procurement relationships the subcontracting entity has with any other unit of state government and shall clearly identify the unit and the contract, subcontract, proposal, lease, or other relationship.

2. Disclosure Forms. Disclosure Form A is attached for use concerning the individuals meeting the above ownership or distributive share requirements. A separate Disclosure Form A must be submitted with the bid for each individual meeting the above requirements. In addition, a second form (Disclosure Form B) provides for the disclosure of current or pending procurement relationships with other (non-IDOT) state agencies and a total ownership certification.

C. Disclosure Form Instructions

Form A Instructions for Financial Information & Potential Conflicts of Interest

If the subcontractor is a publicly traded entity subject to Federal 10K reporting, the 10K Report may be submitted to meet the requirements of Form A. If a subcontractor is a privately held entity that is exempt from Federal 10K reporting, but has more than 100 shareholders, it may submit the information that Federal 10K companies are required to report, and list the names of any individual or entity holding any ownership share that is in excess of 5%. If a subcontractor is not subject to Federal 10K reporting, the subcontractor must determine if any individuals are required by law to complete a financial disclosure form. To do this, the subcontractor should answer each of the following questions. A "YES" answer indicates Form A must be completed. If the answer to each of the following questions is "NO", then the NOT APPLICABLE STATEMENT on the second page of Form A must be signed and dated by an individual that is authorized to execute contracts for the subcontracting company. Note: These questions are for assistance only and are not required to be completed.

1. Does anyone in your organization have a direct or beneficial ownership share of greater than 5% of the bidding entity or parent entity? YES ___ NO ___
2. Does anyone in your organization have a direct or beneficial ownership share of less than 5%, but which has a value greater than 60% of the annual salary of the Governor? YES ___ NO ___
3. Does anyone in your organization receive more than 60% of the annual salary of the Governor of the subcontracting entity's or parent entity's distributive income? YES ___ NO ___

(Note: Distributive income is, for these purposes, any type of distribution of profits. An annual salary is not distributive income.)

4. Does anyone in your organization receive greater than 5% of the subcontracting entity's or parent entity's total distributive income, but which is less than 60% of the annual salary of the Governor? YES ___ NO ___

(Note: Only one set of forms needs to be completed per individual per subcontract even if a specific individual would require a yes answer to more than one question.)

A "YES" answer to any of these questions requires the completion of Form A. The subcontractor must determine each individual in the subcontracting entity or the subcontracting entity's parent company that would cause the questions to be answered "Yes". Each form must be signed and dated by an individual that is authorized to execute contracts for your organization. The individual signing can be, but does not have to be, the individual for which the form is being completed. The subcontractor is responsible for the accuracy of any information provided.

If the answer to each of the above questions is "NO", then the NOT APPLICABLE STATEMENT on page 2 of Form A must be signed and dated by an individual that is authorized to execute contracts for your company.

RETURN WITH SUBCONTRACT

Form B: Instructions for Identifying Other Contracts & Procurement Related Information

Disclosure Form B must be completed for each subcontract submitted by the subcontracting entity. *Note: Checking the NOT APPLICABLE STATEMENT on Form A does not allow the subcontractor to ignore Form B. Form B must be completed, checked, and dated or the subcontract will not be approved.*

The Subcontractor shall identify, by checking Yes or No on Form B, whether it has any pending contracts, subcontracts, leases, bids, proposals, or other ongoing procurement relationship with any other (non-IDOT) State of Illinois agency. If "No" is checked, the subcontractor only needs to complete the check box on the bottom of Form B. If "Yes" is checked, the subcontractor must list all non-IDOT State of Illinois agency pending contracts, subcontracts, leases, bids, proposals, and other ongoing procurement relationships. These items may be listed on Form B or on an attached sheet(s). Contracts with cities, counties, villages, etc. are not considered State of Illinois agency contracts and are not to be included. Contracts or subcontracts with other State of Illinois agencies such as the Department of Natural Resources or the Capital Development Board must be included.

**ILLINOIS DEPARTMENT
OF TRANSPORTATION**

**Form A
Subcontractor: Financial
Information & Potential Conflicts
of Interest Disclosure**

Subcontractor Name		
Legal Address		
City, State, Zip		
Telephone Number	Email Address	Fax Number (if available)

Disclosure of the information contained in this Form is required by Section 50-35 of the Code (30 ILCS 500). Subcontractors desiring to enter into a subcontract of a State of Illinois contract must disclose the financial information and potential conflict of interest information as specified in this Disclosure Form. This information shall become part of the publicly available contract file. This Form A must be completed for subcontracts with a total value of \$50,000 or more, from subcontractors identified in Section 20-120 of the Code, and for all open-ended contracts. **A publicly traded company may submit a 10K disclosure (or equivalent if applicable) in satisfaction of the requirements set forth in Form A. See Disclosure Form Instructions.**

The current annual salary of the Governor is \$177,412.00.

DISCLOSURE OF FINANCIAL INFORMATION

1. Disclosure of Financial Information. The individual named below has an interest in the SUBCONTRACTOR (or its parent) in terms of ownership or distributive income share in excess of 5%, or an interest which has a value of more than 60% of the annual salary of the Governor. **(Make copies of this form as necessary and attach a separate Disclosure Form A for each individual meeting these requirements)**

FOR INDIVIDUAL (type or print information)	
NAME:	_____
ADDRESS	_____
Type of ownership/distributable income share:	
stock _____ sole proprietorship _____ Partnership _____ other: (explain on separate sheet):	
% or \$ value of ownership/distributable income share:	_____

2. Disclosure of Potential Conflicts of Interest. Check "Yes" or "No" to indicate which, if any, of the following potential conflict of interest relationships apply. If the answer to any question is "Yes", please attach additional pages and describe.

(a) State employment, currently or in the previous 3 years, including contractual employment of services.

Yes ___ No ___

If your answer is yes, please answer each of the following questions.

1. Are you currently an officer or employee of either the Capitol Development Board or the Illinois State Toll Highway Authority? Yes ___ No ___

2. Are you currently appointed to or employed by any agency of the State of Illinois? If you are currently appointed to or employed by any agency of the State of Illinois, and your annual salary exceeds 60% of the annual salary of the Governor, provide the name the State agency for which you are employed and your annual salary. _____

RETURN WITH SUBCONTRACT

3. If you are currently appointed to or employed by any agency of the State of Illinois, and your annual salary exceeds 60% of the annual salary of the Governor, are you entitled to receive (i) more than 7 1/2% of the total distributable income of your firm, partnership, association or corporation, or (ii) an amount in excess of 100% of the annual salary of the Governor?
Yes ___ No ___

4. If you are currently appointed to or employed by any agency of the State of Illinois, and your annual salary exceeds 60% of the annual salary of the Governor, are you and your spouse or minor children entitled to receive (i) more than 15 % in the aggregate of the total distributable income of your firm, partnership, association or corporation, or (ii) an amount in excess of two times the salary of the Governor?
Yes ___ No ___

(b) State employment of spouse, father, mother, son, or daughter, including contractual employment services in the previous 2 years.

Yes ___ No ___

If your answer is yes, please answer each of the following questions.

1. Is your spouse or any minor children currently an officer or employee of the Capitol Development Board or the Illinois State Toll Highway Authority?
Yes ___ No ___

2. Is your spouse or any minor children currently appointed to or employed by any agency of the State of Illinois? If your spouse or minor children is/are currently appointed to or employed by any agency of the State of Illinois, and his/her annual salary exceeds 60% of the annual salary of the Governor, provide the name of your spouse and/or minor children, the name of the State agency for which he/she is employed and his/her annual salary. _____

3. If your spouse or any minor children is/are currently appointed to or employed by any agency of the State of Illinois, and his/her annual salary exceeds 60% of the annual salary of the Governor, are you entitled to receive (i) more than 7 1/2% of the total distributable income of your firm, partnership, association or corporation, or (ii) an amount in excess of 100% of the annual salary of the Governor?
Yes ___ No ___

4. If your spouse or any minor children are currently appointed to or employed by any agency of the State of Illinois, and his/her annual salary exceeds 60% of the annual salary of the Governor, are you and your spouse or minor children entitled to receive (i) more than 15 % in the aggregate of the total distributable income of your firm, partnership, association or corporation, or (ii) an amount in excess of two times the salary of the Governor?
Yes ___ No ___

(c) Elective status; the holding of elective office of the State of Illinois, the government of the United States, any unit of local government authorized by the Constitution of the State of Illinois or the statutes of the State of Illinois currently or in the previous 3 years.
Yes ___ No ___

(d) Relationship to anyone holding elective office currently or in the previous 2 years; spouse, father, mother, son, or daughter.
Yes ___ No ___

(e) Appointive office; the holding of any appointive government office of the State of Illinois, the United States of America, or any unit of local government authorized by the Constitution of the State of Illinois or the statutes of the State of Illinois, which office entitles the holder to compensation in excess of the expenses incurred in the discharge of that office currently or in the previous 3 years.
Yes ___ No ___

(f) Relationship to anyone holding appointive office currently or in the previous 2 years; spouse, father, mother, son, or daughter.
Yes ___ No ___

(g) Employment, currently or in the previous 3 years, as or by any registered lobbyist of the State government.
Yes ___ No ___

RETURN WITH SUBCONTRACT

(h) Relationship to anyone who is or was a registered lobbyist in the previous 2 years; spouse, father, mother, son, or daughter. Yes ___ No ___

(i) Compensated employment, currently or in the previous 3 years, by any registered election or reelection committee registered with the Secretary of State or any county clerk of the State of Illinois, or any political action committee registered with either the Secretary of State or the Federal Board of Elections. Yes ___ No ___

(j) Relationship to anyone; spouse, father, mother, son, or daughter; who was a compensated employee in the last 2 years by any registered election or re-election committee registered with the Secretary of State or any county clerk of the State of Illinois, or any political action committee registered with either the Secretary of State or the Federal Board of Elections. Yes ___ No ___

3 Communication Disclosure.

Disclose the name and address of each lobbyist and other agent of the bidder or offeror who is not identified in Section 2 of this form, who is has communicated, is communicating, or may communicate with any State officer or employee concerning the bid or offer. This disclosure is a continuing obligation and must be promptly supplemented for accuracy throughout the process and throughout the term of the contract. If no person is identified, enter "None" on the line below:

Name and address of person(s): _____

RETURN WITH SUBCONTRACT

4. Suspension or Debarment Disclosure. For each of the persons identified under Sections 2 and 3 of this form, disclose whether any of the following has occurred within the previous 10 years: suspension or debarment from contracting with any governmental entity; professional licensure discipline; bankruptcies; adverse civil judgments and administrative findings; and criminal felony convictions. This disclosure is a continuing obligation and must be promptly supplemented for accuracy throughout the procurement process and term of the contract. If no person is identified, enter "None" on the line below:

Name of person(s): _____

Nature of disclosure: _____

APPLICABLE STATEMENT

This Disclosure Form A is submitted on behalf of the INDIVIDUAL named on previous page. Under penalty of perjury, I certify the contents of this disclosure to be true and accurate to the best of my knowledge.

Completed by: _____ Date _____
Signature of Individual or Authorized Officer

NOT APPLICABLE STATEMENT

Under penalty of perjury, I have determined that no individuals associated with this organization meet the criteria that would require the completion of this Form A.

This Disclosure Form A is submitted on behalf of the SUBCONTRACTOR listed on the previous page.

_____ Date _____
Signature of Authorized Officer

RETURN WITH SUBCONTRACT

ILLINOIS DEPARTMENT OF TRANSPORTATION

Form B Subcontractor: Other Contracts & Financial Related Information Disclosure

Form with fields: Subcontractor Name, Legal Address, City, State, Zip, Telephone Number, Email Address, Fax Number (if available)

Disclosure of the information contained in this Form is required by Section 50-35 of the Code (30 ILCS 500). This information shall become part of the publicly available contract file. This Form B must be completed for subcontracts with a total value of \$50,000 or more, from subcontractors identified in Section 20-120 of the Code, and for all open-ended contracts.

DISCLOSURE OF OTHER CONTRACTS, SUBCONTRACTS, AND PROCUREMENT RELATED INFORMATION

1. Identifying Other Contracts & Procurement Related Information. The SUBCONTRACTOR shall identify whether it has any pending contracts, subcontracts, including leases, bids, proposals, or other ongoing procurement relationship with any other State of Illinois agency: Yes ___ No ___ If "No" is checked, the subcontractor only needs to complete the signature box on this page.

2. If "Yes" is checked. Identify each such relationship by showing State of Illinois agency name and other descriptive information such as bid or project number (attach additional pages as necessary). SEE DISCLOSURE FORM INSTRUCTIONS:

THE FOLLOWING STATEMENT MUST BE CHECKED

Signature box with fields: Signature of Authorized Officer, Date

OWNERSHIP CERTIFICATION

Please certify that the following statement is true if the individuals for all submitted Form A disclosures do not total 100% of ownership

Any remaining ownership interest is held by individuals receiving less than \$106,447.20 of the bidding entity's or parent entity's distributive income or holding less than a 5% ownership interest.

Yes No N/A (Form A disclosure(s) established 100% ownership)



- 1. TIME AND PLACE OF OPENING BIDS.** Sealed proposals for the improvement described herein will be received by the Department of Transportation. Electronic bids are to be submitted to the electronic bidding system (iCX-Integrated Contractors Exchange). Paper-based bids are to be submitted to the Chief Procurement Officer for the Department of Transportation in care of the Chief Contracts Official at the Harry R. Hanley Building, 2300 South Dirksen Parkway, in Springfield, Illinois until 10:00 a.m. March 4, 2016. All bids will be gathered, sorted, publicly opened and read in the auditorium at the Department of Transportation's Harry R. Hanley Building shortly after 10:00 a.m.
- 2. DESCRIPTION OF WORK.** The proposed improvement is identified and advertised for bids in the Invitation for Bids as:

**Contract No. 61A39
DUPAGE County
Section 13-00046-00-LS (Oak Brook)
Project TE-00D1(943)
Route FAU 1453 (West 22nd Street)
District 1 Construction Funds**

Sidewalk construction, landscaping and decorative lighting along West 22nd Street from Salt Creek to I-294/I-88 spur ramp in the Village of Oak Brook.

- 3. INSTRUCTIONS TO BIDDERS.** (a) This Notice, the invitation for bids, proposal and letter of award shall, together with all other documents in accordance with Article 101.09 of the Standard Specifications for Road and Bridge Construction, become part of the contract. Bidders are cautioned to read and examine carefully all documents, to make all required inspections, and to inquire or seek explanation of the same prior to submission of a bid.

(b) State law, and, if the work is to be paid wholly or in part with Federal-aid funds, Federal law requires the bidder to make various certifications as a part of the proposal and contract. By execution and submission of the proposal, the bidder makes the certification contained therein. A false or fraudulent certification shall, in addition to all other remedies provided by law, be a breach of contract and may result in termination of the contract.
- 4. AWARD CRITERIA AND REJECTION OF BIDS.** This contract will be awarded to the lowest responsive and responsible bidder considering conformity with the terms and conditions established by the Department in the rules, Invitation for Bids and contract documents. The issuance of plans and proposal forms for bidding based upon a prequalification rating shall not be the sole determinant of responsibility. The Department reserves the right to determine responsibility at the time of award, to reject any or all proposals, to readvertise the proposed improvement, and to waive technicalities.

By Order of the
Illinois Department of Transportation

Randall S. Blankenhorn,
Secretary

**INDEX
FOR
SUPPLEMENTAL SPECIFICATIONS
AND RECURRING SPECIAL PROVISIONS**

Adopted January 1, 2015

This index contains a listing of SUPPLEMENTAL SPECIFICATIONS, frequently used RECURRING SPECIAL PROVISIONS, and LOCAL ROADS AND STREETS RECURRING SPECIAL PROVISIONS.

ERRATA Standard Specifications for Road and Bridge Construction (Adopted 1-1-12) (Revised 1-1-15)

SUPPLEMENTAL SPECIFICATIONS

<u>Std. Spec. Sec.</u>	<u>Page No.</u>
101 Definition of Terms	1
102 Advertisement, Bidding, Award, and Contract Execution	2
105 Control of Work	3
106 Control of Materials	5
107 Legal Regulations and Responsibility to Public	6
108 Prosecution and Progress	14
109 Measurement and Payment	15
202 Earth and Rock Excavation	17
211 Topsoil and Compost	19
250 Seeding	20
253 Planting Woody Plants	21
280 Temporary Erosion and Sediment Control	23
312 Stabilized Subbase	24
406 Hot-Mix Asphalt Binder and Surface Course	25
407 Hot-Mix Asphalt Pavement (Full-Depth)	28
420 Portland Cement Concrete Pavement	32
424 Portland Cement Concrete Sidewalk	34
440 Removal of Existing Pavement and Appurtenances	35
502 Excavation for Structures	36
503 Concrete Structures	37
504 Precast Concrete Structures	40
506 Cleaning and Painting New Steel Structures	41
512 Piling	42
516 Drilled Shafts	43
521 Bearings	44
540 Box Culverts	45
588 Bridge Relief Joint System	46
589 Elastic Joint Sealer	48
602 Catch Basin, Manhole, Inlet, Drainage Structure, and Valve Vault Construction, Adjustment, and Reconstruction	49
603 Adjusting Frames and Grates of Drainage and Utility Structures	50
606 Concrete Gutter, Curb, Median, and Paved Ditch	52
610 Shoulder Inlets with Curb	53
639 Precast Prestressed Concrete Sight Screen	54
642 Shoulder Rumble Strips	55
643 Impact Attenuators	56
644 High Tension Cable Median Barrier	58
669 Removal and Disposal of Regulated Substances	60
670 Engineer's Field Office and Laboratory	64

<u>Std. Spec. Sec.</u>	<u>Page No.</u>
701 Work Zone Traffic Control and Protection	65
706 Impact Attenuators, Temporary	68
707 Movable Traffic Barrier	71
708 Temporary Water Filled Barrier	73
730 Wood Sign Support	75
780 Pavement Striping	76
816 Unit Duct	81
836 Pole Foundation	82
860 Master Controller	83
1001 Cement	84
1003 Fine Aggregates	85
1004 Coarse Aggregates	87
1006 Metals	91
1011 Mineral Filler	93
1017 Packaged, Dry, Combined Materials for Mortar	94
1018 Packaged Rapid Hardening Mortar or Concrete	95
1019 Controlled Low-Strength Material (CLSM)	96
1020 Portland Cement Concrete	97
1024 Grout and Nonshrink Grout	136
1030 Hot-Mix Asphalt	137
1040 Drain Pipe, Tile, Drainage Mat, and Wall Drain	142
1042 Precast Concrete Products	143
1069 Pole and Tower	144
1070 Foundation and Breakaway Devices	145
1073 Controller	146
1081 Materials for Planting	147
1082 Preformed Bearing Pads	148
1083 Elastomeric Bearings	149
1088 Wireway and Conduit System	150
1095 Pavement Markings	152
1101 General Equipment	155
1102 Hot-Mix Asphalt Equipment	157
1103 Portland Cement Concrete Equipment	159
1105 Pavement Marking Equipment	160
1106 Work Zone Traffic Control Devices	161

RECURRING SPECIAL PROVISIONS

The following RECURRING SPECIAL PROVISIONS indicated by an "X" are applicable to this contract and are included by reference:

<u>CHECK SHEET #</u>	<u>PAGE NO.</u>
1 X Additional State Requirements for Federal-Aid Construction Contracts	163
2 X Subletting of Contracts (Federal-Aid Contracts)	166
3 X EEO	167
4 Specific EEO Responsibilities Non Federal-Aid Contracts	177
5 Required Provisions - State Contracts	182
6 Asbestos Bearing Pad Removal	188
7 Asbestos Waterproofing Membrane and Asbestos HMA Surface Removal	189
8 Temporary Stream Crossings and In-Stream Work Pads	190
9 Construction Layout Stakes Except for Bridges	191
10 X Construction Layout Stakes	194
11 Use of Geotextile Fabric for Railroad Crossing	197
12 Subsealing of Concrete Pavements	199
13 Hot-Mix Asphalt Surface Correction	203
14 Pavement and Shoulder Resurfacing	205
15 Reserved	206
16 Patching with Hot-Mix Asphalt Overlay Removal	207
17 Polymer Concrete	208
18 PVC Pipeliner	210
19 X Pipe Underdrains	211
20 Guardrail and Barrier Wall Delineation	212
21 Bicycle Racks	216
22 Reserved	218
23 Temporary Portable Bridge Traffic Signals	219
24 Work Zone Public Information Signs	221
25 X Nighttime Inspection of Roadway Lighting	222
26 English Substitution of Metric Bolts	223
27 English Substitution of Metric Reinforcement Bars	224
28 Calcium Chloride Accelerator for Portland Cement Concrete	225
29 Reserved	226
30 Quality Control of Concrete Mixtures at the Plant	227
31 X Quality Control/Quality Assurance of Concrete Mixtures	235
32 Digital Terrain Modeling for Earthwork Calculations	251
33 Pavement Marking Removal	253
34 Preventive Maintenance – Bituminous Surface Treatment	254
35 Preventive Maintenance – Cape Seal	260
36 Preventive Maintenance – Micro-Surfacing	275
37 Preventive Maintenance – Slurry Seal	286
38 Temporary Raised Pavement Markers	296
39 Restoring Bridge Approach Pavements Using High-Density Foam	297

LOCAL ROADS AND STREETS RECURRING SPECIAL PROVISIONS

The following LOCAL ROADS AND STREETS RECURRING SPECIAL PROVISIONS indicated by an "X" are applicable to this contract and are included by reference:

Table of Contents

<u>CHECK SHEET #</u>	<u>PAGE NO.</u>
LRS 1 Reserved	301
LRS 2 <input type="checkbox"/> Furnished Excavation	302
LRS 3 <input checked="" type="checkbox"/> Work Zone Traffic Control Surveillance	303
LRS 4 <input checked="" type="checkbox"/> Flaggers in Work Zones	304
LRS 5 <input type="checkbox"/> Contract Claims	305
LRS 6 <input type="checkbox"/> Bidding Requirements and Conditions for Contract Proposals	306
LRS 7 <input type="checkbox"/> Bidding Requirements and Conditions for Material Proposals	312
LRS 8 Reserved	318
LRS 9 <input type="checkbox"/> Bituminous Surface Treatments	319
LRS 10 Reserved	320
LRS 11 <input type="checkbox"/> Employment Practices	321
LRS 12 <input type="checkbox"/> Wages of Employees on Public Works	323
LRS 13 <input type="checkbox"/> Selection of Labor	325
LRS 14 <input type="checkbox"/> Paving Brick and Concrete Paver Pavements and Sidewalks	326
LRS 15 <input type="checkbox"/> Partial Payments	329
LRS 16 <input type="checkbox"/> Protests on Local Lettings	330
LRS 17 <input type="checkbox"/> Substance Abuse Prevention Program.....	331
LRS 18 <input type="checkbox"/> Multigrade Cold Mix Asphalt	332

INDEX OF SPECIAL PROVISIONS

<u>Item</u>	<u>Page</u>
Opening Paragraph of Special Provisions	1
Location and Description of Project	1
Traffic Control Plan	1
Damage to Traffic Signal System	2
Coarse Aggregate for Backfill, Trench Backfill and Bedding (D-1)	2
Maintenance of Roadways	2
Public Convenience and Safety (D-1)	3
General Electric Requirements	3
Luminaire	7
Maintenance of Lighting Systems	14
Status of Utilities to be Adjusted	18
Underground Raceways	19
Unit Duct	20
Wire and Cable	21
Structure Adjustments	22
Earth Excavation	23
Topsoil and Soil Conditioner	23
Sodding, Salt Tolerant	25
Precast Concrete Curb	25
Planting Woody Plants	27
Planting Perennial Plants	27
Irrigation System	28
P.C.C. Sidewalk 5 Inch, P.C.C. Sidewalk 8 Inch	42
Pre-Construction Video Taping	42
Exploratory Excavation	43
Water Service Connections	43
Pavement Removal	44
Underdrain Connect to Structure	44
Luminaire Special	45
Light Pole Special	45
Holiday Sub Lighting Panel Assembly	46
Removal and Disposal of Regulated Substances	47
Appendix A- Village Lighting Standards	51
Removal of Luminaire, Salvage	58A

INDEX LOCAL ROADS AND STREETS SPECIAL PROVISIONS

<u>LR #</u>	<u>Pg #</u>	<u>Special Provision Title</u>	<u>Effective</u>	<u>Revised</u>
LR SD12		<input type="checkbox"/> Slab Movement Detection Device	Nov. 11, 1984	Jan. 1, 2007
LR SD13		<input type="checkbox"/> Required Cold Milled Surface Texture	Nov. 1, 1987	Jan. 1, 2007
LR 107-2		<input type="checkbox"/> Railroad Protective Liability Insurance for Local Lettings	Mar. 1, 2005	Jan. 1, 2006
LR 107-4	59	<input checked="" type="checkbox"/> Insurance	Feb. 1, 2007	Aug. 1, 2007
LR 108		<input type="checkbox"/> Combination Bids	Jan. 1, 1994	Mar. 1, 2005
LR 109		<input type="checkbox"/> Equipment Rental Rates	Jan. 1, 2012	
LR 212		<input type="checkbox"/> Shaping Roadway	Aug. 1, 1969	Jan. 1, 2002
LR 355-1		<input type="checkbox"/> Bituminous Stabilized Base Course, Road Mix or Traveling Plant Mix	Oct. 1, 1973	Jan. 1, 2007
LR 355-2		<input type="checkbox"/> Bituminous Stabilized Base Course, Plant Mix	Feb. 20, 1963	Jan. 1, 2007
LR 400-1		<input type="checkbox"/> Bituminous Treated Earth Surface	Jan. 1, 2007	Apr. 1, 2012
LR 400-2		<input type="checkbox"/> Bituminous Surface Plant Mix (Class B)	Jan. 1, 2008	
LR 400-3		<input type="checkbox"/> Hot In-Place Recycling (HIR) – Surface Recycling	Jan. 1, 2012	
LR 400-4		<input type="checkbox"/> Full-Depth Reclamation (FDR) with Emulsified Asphalt	Apr. 1, 2012	Jun. 1, 2012
LR 400-5		<input type="checkbox"/> Cold In-Place Recycling (CIR) With Emulsified Asphalt	Apr. 1, 2012	Jun. 1, 2012
LR 400-6		<input type="checkbox"/> Cold In Place Recycling (CIR) with Foamed Asphalt	June 1, 2012	
LR 400-7		<input type="checkbox"/> Full-Depth Reclamation (FDR) with Foamed Asphalt	June 1, 2012	
LR 402		<input type="checkbox"/> Salt Stabilized Surface Course	Feb. 20, 1963	Jan. 1, 2007
LR 403-1		<input type="checkbox"/> Surface Profile Milling of Existing, Recycled or Reclaimed Flexible Pavement	Apr. 1, 2012	Jun. 1, 2012
LR 403-2		<input type="checkbox"/> Bituminous Hot Mix Sand Seal Coat	Aug. 1, 1969	Jan. 1, 2007
LR 406		<input type="checkbox"/> Filling HMA Core Holes with Non-shrink Grout	Jan. 1, 2008	
LR 420		<input type="checkbox"/> PCC Pavement (Special)	May 12, 1964	Jan. 2, 2007
LR 442		<input type="checkbox"/> Bituminous Patching Mixtures for Maintenance Use	Jan. 1, 2004	Jun. 1, 2007
LR 451		<input type="checkbox"/> Crack Filling Bituminous Pavement with Fiber-Asphalt	Oct. 1, 1991	Jan. 1, 2007
LR 503-1		<input type="checkbox"/> Furnishing Class SI Concrete	Oct. 1, 1973	Jan. 1, 2002
LR 503-2		<input type="checkbox"/> Furnishing Class SI Concrete (Short Load)	Jan. 1, 1989	Jan. 1, 2002
LR 542		<input type="checkbox"/> Pipe Culverts, Type _____ (Furnished)	Sep. 1, 1964	Jan. 1, 2007
LR 663		<input type="checkbox"/> Calcium Chloride Applied	Jun. 1, 1958	Jan. 1, 2007
LR 702		<input type="checkbox"/> Construction and Maintenance Signs	Jan. 1, 2004	Jun. 1, 2007
LR 1000-1		<input type="checkbox"/> Cold In-Place Recycling (CIR) and Full Depth Reclamation (FDR) with Emulsified Asphalt Mix Design Procedures	Apr. 1, 2012	Jun. 1, 2012
LR 1000-2		<input type="checkbox"/> Cold In-Place Recycling (CIR) and Full Depth Reclamation (FDR) with Foamed Asphalt Mix Design Procedures	June 1, 2012	
LR 1004		<input type="checkbox"/> Coarse Aggregate for Bituminous Surface Treatment	Jan. 1, 2002	Jan. 1, 2007
LR 1030		<input type="checkbox"/> Growth Curve	Mar. 1, 2008	Jan. 1, 2010
LR 1032-1		<input type="checkbox"/> Emulsified Asphalts	Jan. 1, 2007	Feb. 7, 2008
LR 1102		<input type="checkbox"/> Road Mix or Traveling Plan Mix Equipment	Jan. 1, 2007	

BDE SPECIAL PROVISIONS

The following special provisions indicated by an "x" are applicable to this contract. An * indicates a new or revised special provision for the letting.

<u>File Name</u>	<u>Pg.</u>	<u>Special Provision Title</u>	<u>Effective</u>	<u>Revised</u>
80240		Above Grade Inlet Protection	July 1, 2009	Jan. 1, 2012
80099		Accessible Pedestrian Signals (APS)	April 1, 2003	Jan. 1, 2014
* 80274		Aggregate Subgrade Improvement	April 1, 2012	Jan. 1, 2016
80192		Automated Flagger Assistance Device	Jan. 1, 2008	
80173		Bituminous Materials Cost Adjustments	Nov. 2, 2006	July 1, 2015
80241		Bridge Demolition Debris	July 1, 2009	
50261		Building Removal-Case I (Non-Friable and Friable Asbestos)	Sept. 1, 1990	April 1, 2010
50481		Building Removal-Case II (Non-Friable Asbestos)	Sept. 1, 1990	April 1, 2010
50491		Building Removal-Case III (Friable Asbestos)	Sept. 1, 1990	April 1, 2010
50531		Building Removal-Case IV (No Asbestos)	Sept. 1, 1990	April 1, 2010
80360	60	X Coarse Aggregate Quality	July 1, 2015	
80310		Coated Galvanized Steel Conduit	Jan. 1, 2013	Jan. 1, 2015
80341	62	X Coilable Nonmetallic Conduit	Aug. 1, 2014	Jan. 1, 2015
80198		Completion Date (via calendar days)	April 1, 2008	
80199		Completion Date (via calendar days) Plus Working Days	April 1, 2008	
80293		Concrete Box Culverts with Skews > 30 Degrees and Design Fills ≤ 5 Feet	April 1, 2012	April 1, 2015
80294		Concrete Box Culverts with Skews ≤ 30 Degrees Regardless of Design Fill and Skews > 30 Degrees with Design Fills > 5 Feet	April 1, 2012	April 1, 2014
80311		Concrete End Sections for Pipe Culverts	Jan. 1, 2013	
80334	63	X Concrete Gutter, Curb, Median, and Paved Ditch	April 1, 2014	Aug. 1, 2014
80277		Concrete Mix Design – Department Provided	Jan. 1, 2012	Jan. 1, 2014
80261	64	X Construction Air Quality – Diesel Retrofit	June 1, 2010	Nov. 1, 2014
80335	67	X Contract Claims	April 1, 2014	
* 80029	68	X Disadvantaged Business Enterprise Participation	Sept. 1, 2000	Jan. 2, 2016
80358	79	X Equal Employment Opportunity	April 1, 2015	
80265		Friction Aggregate	Jan. 1, 2011	Nov. 1, 2014
80229		Fuel Cost Adjustment	April 1, 2009	July 1, 2015
80329		Glare Screen	Jan. 1, 2014	
80304		Grooving for Recessed Pavement Markings	Nov. 1, 2012	Aug. 1, 2014
80246		Hot-Mix Asphalt – Density Testing of Longitudinal Joints	Jan. 1, 2010	April 1, 2012
80322		Hot-Mix Asphalt – Mixture Design Composition and Volumetric Requirements	Nov. 1, 2013	Nov. 1, 2014
80323		Hot-Mix Asphalt – Mixture Design Verification and Production	Nov. 1, 2013	Nov. 1, 2014
80347		Hot-Mix Asphalt – Pay for Performance Using Percent Within Limits – Jobsite Sampling	Nov. 1, 2014	July 1, 2015
80348		Hot-Mix Asphalt – Prime Coat	Nov. 1, 2014	
80315		Insertion Lining of Culverts	Jan. 1, 2013	Nov. 1, 2013
80351		Light Tower	Jan. 1, 2015	
80336		Longitudinal Joint and Crack Patching	April 1, 2014	
80324		LRFD Pipe Culvert Burial Tables	Nov. 1, 2013	April 1, 2015
80325		LRFD Storm Sewer Burial Tables	Nov. 1, 2013	April 1, 2015
80045		Material Transfer Device	June 15, 1999	Aug. 1, 2014
80342		Mechanical Side Tie Bar Inserter	Aug. 1, 2014	Jan. 1, 2015
80165		Moisture Cured Urethane Paint System	Nov. 1, 2006	Jan. 1, 2010
80361		Overhead Sign Structures Certification of Metal Fabricator	Nov. 1, 2015	
80337		Paved Shoulder Removal	April 1, 2014	
80349		Pavement Marking Blackout Tape	Nov. 1, 2014	
80298		Pavement Marking Tape Type IV	April 1, 2012	
80254		Pavement Patching	Jan. 1, 2010	

<u>File Name</u>	<u>Pg.</u>	<u>Special Provision Title</u>	<u>Effective</u>	<u>Revised</u>
80352		Pavement Striping - Symbols	Jan. 1, 2015	
80359		Portland Cement Concrete Bridge Deck Curing	April 1, 2015	
80353		Portland Cement Concrete Inlay or Overlay	Jan. 1, 2015	April 1, 2015
80338		Portland Cement Concrete Partial Depth Hot-Mix Asphalt Patching	April 1, 2014	
80343	83	X Precast Concrete Handhole	Aug. 1, 2014	
80300		Preformed Plastic Pavement Marking Type D - Inlaid	April 1, 2012	
80328	84	X Progress Payments	Nov. 2, 2013	
34261		Railroad Protective Liability Insurance	Dec. 1, 1986	Jan. 1, 2006
80157		Railroad Protective Liability Insurance (5 and 10)	Jan. 1, 2006	
80306		Reclaimed Asphalt Pavement (RAP) and Reclaimed Asphalt Shingles (RAS)	Nov. 1, 2012	Jan. 2, 2015
80350		Retroreflective Sheeting for Highway Signs	Nov. 1, 2014	
80327	85	X Reinforcement Bars	Nov. 1, 2013	
80344	87	X Rigid Metal Conduit	Aug. 1, 2014	
80354	88	X Sidewalk, Corner, or Crosswalk Closure	Jan. 1, 2015	April 1, 2015
80340		Speed Display Trailer	April 2, 2014	
80127		Steel Cost Adjustment	April 2, 2004	July 1, 2015
* 80362		Steel Slag in Trench Backfill	Jan. 1, 2016	
80317		Surface Testing of Hot-Mix Asphalt Overlays	Jan. 1, 2013	
80355		Temporary Concrete Barrier	Jan. 1, 2015	July 1, 2015
80301	89	X Tracking the Use of Pesticides	Aug. 1, 2012	
80356		Traffic Barrier Terminals Type 6 or 6B	Jan. 1, 2015	
20338		Training Special Provisions	Oct. 15, 1975	
80318		Traversable Pipe Grate	Jan. 1, 2013	April 1, 2014
80345		Underpass Luminaire	Aug. 1, 2014	April 1, 2015
80357		Urban Half Road Closure with Mountable Median	Jan. 1, 2015	July 1, 2015
80346		Waterway Obstruction Warning Luminaire	Aug. 1, 2014	April 1, 2015
80288		Warm Mix Asphalt	Jan. 1, 2012	Nov. 1, 2014
80302	90	X Weekly DBE Trucking Reports	June 2, 2012	April 2, 2015
80289		Wet Reflective Thermoplastic Pavement Marking	Jan. 1, 2012	
80071	91	X Working Days	Jan. 1, 2002	

The following special provisions are in the 2015 Supplemental Specifications and Recurring Special Provisions:

<u>File Name</u>	<u>Special Provision Title</u>	<u>New Location</u>	<u>Effective</u>	<u>Revised</u>
80292	Coarse Aggregate in Bridge Approach Slabs/Footings	Articles 1004.01(b) and 1004.02(f)	April 1, 2012	April 1, 2013
80303	Granular Materials	Articles 1003.04, 1003.04(c), and 1004.05(c)	Nov. 1, 2012	
80330	Pavement Marking for Bike Symbol	Article 780.14	Jan. 1, 2014	
80331	Payrolls and Payroll Records	Recurring CS #1 and #5	Jan. 1, 2014	
80332	Portland Cement Concrete – Curing of Abutments and Piers	Article 1020.13	Jan. 1, 2014	
80326	Portland Cement Concrete Equipment	Article 1103.03(a)(5)	Nov. 1, 2013	
80281	Quality Control/Quality Assurance of Concrete Mixtures	Recurring CS #31	Jan. 1, 2012	Jan. 1, 2014
80283	Removal and Disposal of Regulated Substances	Articles 669.01, 669.08, 669.09, 669.14, and 669.16	Jan. 1, 2012	Nov. 2, 2012
80319	Removal and Disposal of Surplus Materials	Article 202.03	Nov. 2, 2012	
80307	Seeding	Article 250.07	Nov. 1, 2012	
80339	Stabilized Subbase	Article 312.06	April 1, 2014	
80333	Traffic Control Setup and Removal Freeway/Expressway	Articles 701.18(I) and 701.19(a)	Jan. 1, 2014	

The following special provisions require additional information from the designer. The additional information needs to be included in a separate document attached to this check sheet. The Project Development and Implementation section will then include the information in the applicable special provision. The Special Provisions are:

- Bridge Demolition Debris
- Building Removal-Case I
- Building Removal-Case II
- Building Removal-Case III
- Building Removal-Case IV
- Completion Date
- Completion Date Plus Working Days
- DBE Participation
- Material Transfer Device
- Railroad Protective Liability Insurance
- Training Special Provisions
- Working Days

STATE OF ILLINOIS

SPECIAL PROVISIONS

The following Special Provisions supplement the "Standard Specifications for Road and Bridge Construction", adopted January 1, 2012, the latest edition of the "Manual on Uniform Traffic Control Devices for Streets and Highways", and the "Manual of Test Procedures for Materials" in effect on the date of invitation for bids; and the "Supplemental Specifications and Recurring Special Provisions" indicated on the Check Sheet included herein which apply to and govern the proposed improvement designated as

West 22nd Street Streetscape Enhancements
Section No.: 13-00046-00-LS
Project No.: TE-00D1 (943)
Job No.: C-91-037-14
Contract No.: 61A39

In case of conflict with any part or parts of said Specifications, the said Special Provisions shall take precedence and shall govern.

LOCATION OF PROJECT

The project is located in the Village of Oak Brook, DuPage County, Illinois. The proposed work is located within the right-of-way along FAU 1453 (West 22nd Street) from Salt Creek to I-294/I-88 Spur Ramp. The gross and net length of the project is 6,950 feet (1.32 miles).

DESCRIPTION OF PROJECT

The work consists of earth excavation, P.C.C. sidewalk, raised precast concrete planter curbs, landscaping, lighting, and construction of an automatic irrigation system including providing the necessary electrical service and connections to existing stubbed-out water services. This work shall include all the incidental and collateral work necessary to complete the project as shown on the plans and as described herein.

TRAFFIC CONTROL PLAN

Effective: September 30, 1985
Revised: January 1, 2007

Traffic Control shall be according to the applicable sections of the Standard Specifications, the Supplemental Specifications, the "Illinois Manual on Uniform Traffic Control Devices for Streets and Highways", any special details and Highway Standards contained in the plans, and the Special Provisions contained herein.

Special attention is called to Article 107.09 of the Standard Specifications and the following Highway Standards, Details, Quality Standard for Work Zone Traffic Control Devices, Recurring Special Provisions and Special Provisions contained herein, relating to traffic control.

The Contractor shall contact the District One Bureau of Traffic at least 72 hours in advance of beginning work.

STANDARDS: 000001-06, 701101-04, 701106-02, 701427-03, 701601-09
701606-10, 701701-09, 701801-05, 701901-04, 814006-02,
878001-10

DETAILS: Sheet 2, Traffic Control Notes

SPECIAL PROVISIONS: Public Convenience and Safety (District 1), Temporary Information
Signing, Maintenance of Roadways, TC-10, TC-22

DAMAGE TO TRAFFIC SIGNAL SYSTEM

Any traffic signal control equipment damaged or not operating properly from any cause whatsoever shall be repaired with new equipment provided by the Contractor at no additional cost to the Contract and or owner of the traffic signal system, all as approved by the Engineer. Final repairs or replacement of damaged equipment must meet the approval of the Engineer prior to or at the time of final inspection otherwise the traffic signal installation will not be accepted. Cable splices outside the controller cabinet shall not be allowed.

Automatic Traffic Enforcement equipment, such as Red Light Enforcement cameras, detectors, and peripheral equipment, damaged or not operating properly from any cause whatsoever, shall be the responsibility of the municipality or the Automatic Traffic Enforcement company per Permit agreement.

COARSE AGGREGATE FOR BACKFILL, TRENCH BACKFILL AND (D-1)

Effective: November 1, 2011

Revised: November 1, 2013

This work shall be according to Section 1004.05 of the Standard Specifications except for the following:

Reclaimed Asphalt Pavement (RAP) maybe blended with gravel, crushed gravel, crushed stone crushed concrete, crushed slag, chats, crushed sand stone or wet bottom boiler slag. The RAP used shall be according to the current Bureau of Materials and Physical Research Policy Memorandum, "Reclaimed Asphalt Pavement (RAP) for Aggregate Applications". The RAP shall be uniformly graded and shall pass the 1.0 in. (25 mm) screen. When RAP is blended with any of the coarse aggregate listed above, the blending shall be done mechanically with calibrated feeders. The feeders shall have an accuracy of ± 2.0 percent of the actual quantity of material delivered. The final blended product shall not contain more than 40 percent by weight RAP.

The coarse aggregate listed above shall meet CA 6 and CA 10 gradations prior to being blended with the processed and uniformly graded RAP. Gradation deleterious count shall not exceed 10% of total RAP and 5% of other by total weight.

MAINTENANCE OF ROADWAYS

Effective: September 30, 1985

Revised: November 1, 1996

Beginning on the date that work begins on this project, the Contractor shall assume responsibility for normal maintenance of all existing roadways within the limits of the improvement. This normal maintenance shall include all repair work deemed necessary by the Engineer, but shall not include snow

removal operations. Traffic control and protection for maintenance of roadways will be provided by the Contractor as required by the Engineer.

If items of work have not been provided in the contract, or otherwise specified for payment, such items, including the accompanying traffic control and protection required by the Engineer, will be paid for in accordance with Article 109.04 of the Standard Specifications.

PUBLIC CONVENIENCE AND SAFETY (D-1)

Effective: May 1, 2012

Revised: July 15, 2012

Add the following to the end of the fourth paragraph of Article 107.09:

“If the holiday is on a Saturday or Sunday, and is legally observed on a Friday or Monday, the length of the Holiday Period for Monday or Friday shall apply. “

Add the following sentence after the Holiday Period table in the fourth paragraph of Article 107.09:

“The Length of Holiday Period for Thanksgiving shall be from 5:00 AM the Wednesday prior to 11:59 PM the Sunday After.”

Delete the fifth paragraph of Article 107.09 of the Standard Specifications:

“On weekends excluding holidays, roadways with Average Daily Traffic of 25,000 or greater, all lanes shall be open to traffic from 3:00 PM Friday to midnight Sunday except where structure construction or major rehabilitation makes it impractical”

GENERAL ELECTRIC REQUIREMENTS

Effective: January 1, 2012

Add the following to Article 801 of the Standard Specifications:

“Maintenance transfer and Preconstruction Inspection:

General. Before performing any excavation, removal, or installation work (electrical or otherwise) at the site, the Contractor shall request a maintenance transfer and preconstruction site inspection, to be held in the presence of the Engineer and a representative of the party or parties responsible for maintenance of any lighting and/or traffic control systems which may be affected by the work. The request for the maintenance transfer and preconstruction inspection shall be made no less than seven (7) calendar days prior to the desired inspection date. The maintenance transfer and preconstruction inspection shall:

Establish the procedures for formal transfer of maintenance responsibility required for the construction period.

Establish the approximate location and operating condition of lighting and/or traffic control systems which may be affected by the work

Marking of Existing Cable Systems. The party responsible for maintenance of any existing lighting and/or traffic control systems at the project site will, at the Contractor's request, mark and/or stake, once per location, all underground cable routes owned or maintained by the State. A project may involve multiple "locations" where separated electrical systems are involved (i.e. different controllers). The markings shall be taken to have a horizontal tolerance of at least 304.8 mm (one (1) foot) to either side.. The request for the cable locations and marking shall be made at the same time the request for the maintenance transfer and preconstruction inspection is made. The Contractor shall exercise extreme caution where existing buried cable runs are involved. The markings of existing systems are made strictly for assistance to the Contractor and this does not relieve the Contractor of responsibility for the repair or replacement of any cable run damaged in the course of his work, as specified elsewhere herein. Note that the contractor shall be entitled to only one request for location marking of existing systems and that multiple requests may only be honored at the contractor's expense. No locates will be made after maintenance is transferred, unless it is at the contractor's expense.

Condition of Existing Systems. The Contractor shall conduct an inventory of all existing electrical system equipment within the project limits, which may be affected by the work, making note of any parts which are found broken or missing, defective or malfunctioning. Megger and load readings shall be taken for all existing circuits which will remain in place or be modified. If a circuit is to be taken out in its entirety, then readings do not have to be taken. The inventory and test data shall be reviewed with and approved by the Engineer and a record of the inventory shall be submitted to the Engineer for the record. Without such a record, all systems transferred to the Contractor for maintenance during construction shall be returned at the end of construction in complete, fully operating condition."

Add the following to the 1st paragraph of Article 801.05(a) of the Standard Specifications:

"Items from multiple disciplines shall not be combined on a single submittal and transmittal. Items for lighting, signals, surveillance and CCTV must be in separate submittals since they may be reviewed by various personnel in various locations."

Revise the second sentence of the 5th paragraph of Article 801.05(a) of the Standard Specifications to read:

"The Engineer will stamp the submittals indicating their status as 'Approved', 'Approved as Noted', 'Disapproved', or 'Information Only'.

Revise the 6th paragraph of Article 801.05(a) of the Standard Specifications to read:

Resubmittals. All submitted items reviewed and marked 'Approved as Noted', or 'Disapproved' are to be resubmitted in their entirety with a disposition of previous

comments to verify contract compliance at no additional cost to the state unless otherwise indicated within the submittal comments.”

Revise Article 801.11(a) of the Standard Specifications to read:

“Lighting Operation and Maintenance Responsibility. The scope of work shall include the assumption of responsibility for the continuing operation and maintenance of the existing, proposed, temporary, sign and navigation lighting, or other lighting systems and all appurtenances affected by the work as specified elsewhere herein. Maintenance of lighting systems is specified elsewhere and will be paid for separately

Energy and Demand Charges. The payment of basic energy and demand charges by the electric utility for existing lighting which remains in service will continue as a responsibility of the Owner, unless otherwise indicated. Unless otherwise indicated or required by the Engineer duplicate lighting systems (such as temporary lighting and proposed new lighting) shall not be operated simultaneously at the Owner’s expense and lighting systems shall not be kept in operation during long daytime periods at the Owner’s expense. Upon written authorization from the Engineer to place a proposed new lighting system in service, whether the system has passed final acceptance or not, (such as to allow temporary lighting to be removed), the Owner will accept responsibility for energy and demand charges for such lighting, effective the date of authorization. All other energy and demand payments to the utility shall be the responsibility of the Contractor until final acceptance.”

Add the following to Section 801 of the Standard Specifications:

“Lighting Cable Identification. Each wire installed shall be identified with its complete circuit number at each termination, splice, junction box or other location where the wire is accessible.”

“Lighting Cable Fuse Installation. Standard fuse holders shall be used on non-frangible (non-breakaway) light pole installations and quick-disconnect fuse holders shall be used on frangible (breakaway) light pole installations. Wires shall be carefully stripped only as far as needed for connection to the device. Over-stripping shall be avoided. An oxide inhibiting lubricant shall be applied to the wire for minimum connection resistance before the terminals are crimped-on. Crimping shall be performed in accordance with the fuse holder manufacturer’s recommendations. The exposed metal connecting portion of the assembly shall be taped with two half-lapped wraps of electrical tape and then covered by the specified insulating boot. The fuse holder shall be installed such that the fuse side is connected to the pole wire (load side) and the receptacle side of the holder is connected to the line side.”

Revise the 2nd paragraph of Article 801.16 of the Standard Specifications to read:

“When the work is complete, and seven days before the request for a final inspection, the full-size set of contract drawings. Stamped “RECORD DRAWINGS”, shall be submitted to the Engineer for review and approval and shall be stamped with the date and the signature of the Contractor’s

supervising Engineer or electrician. The record drawings shall be submitted in PDF format on CDROM as well as hardcopy for review and approval. In addition to the record drawings, copies of the final catalog cuts which have been Approved or Approved as Noted shall be submitted in PDF format along with the record drawings. The PDF files shall clearly indicate either by filename or PDF table of contents the respective pay item number. Specific part or model numbers of items which have been selected shall be clearly visible.”

Add the following to Article 801.16 of the Standard Specifications:

“In addition to the specified record drawings, the Contactor shall record GPS coordinates of the following electrical components being installed, modified or being affected in other ways by this contract:

- Last light pole on each circuit
- Handholes
- Conduit roadway crossings
- Controllers
- Control Buildings
- Structures with electrical connections, i.e. DMS, lighted signs.
- Electric Service locations
- CCTV Camera installations
- Fiber Optic Splice Locations

Datum to be used shall be North American 1983.

Data shall be provided electronically and in print form. The electronic format shall be compatible with MS Excel. Latitude and Longitude shall be in decimal degrees with a minimum of 6 decimal places. Each coordinate shall have the following information:

1. Description of item
2. Designation or approximate station if the item is undesignated
3. Latitude
4. Longitude

Examples:

Equipment Description	Equipment Designation	Latitude	Longitude
CCTV Camera pole	ST42	41.580493	-87.793378
FO mainline splice handhole	HHL-ST31	41.558532	-87.792571
Handhole	HH at STA 234+35	41.765532	-87.543571
Electric Service	Elec Srv	41.602248	-87.794053
Conduit crossing	SB IL83 to EB I290 ramp SIDE A	41.584593	-87.793378
Conduit crossing	SB IL83 to EB I290 ramp SIDE B	41.584600	-87.793432
Light Pole	DA03	41.558532	-87.792571

Lighting Controller	X	41.651848	-87.762053
Sign Structure	FGD	41.580493	-87.793378
Video Collection Point	VCP-IK	41.558532	-87.789771
Fiber splice connection	Toll Plaza34	41.606928	-87.794053

Prior to the collection of data, the contractor shall provide a sample data collection of at least six data points of known locations to be reviewed and verified by the Engineer to be accurate within 100 feet. Upon verification, data collection can begin. Data collection can be made as construction progresses, or can be collected after all items are installed. If the data is unacceptable the contractor shall make corrections to the data collection equipment and or process and submit the data for review and approval as specified.

Accuracy. Data collected is to be mapping grade. A handheld mapping grade GPS device shall be used for the data collection. The receiver shall support differential correction and data shall have a minimum 5 meter accuracy after post processing.

GPS receivers integrated into cellular communication devices, recreational and automotive GPS devices are not acceptable.

The GPS shall be the product of an established major GPS manufacturer having been in the business for a minimum of 6 years.”

LUMINAIRE

Effective: January 1, 2012

Add the following to first paragraph of Article 1067(c) of the Standard Specifications:

“The reflector shall not be altered by paint or other opaque coatings which would cover or coat the reflecting surface. Control of the light distribution by any method other than the reflecting material and the aforementioned clear protective coating that will alter the reflective properties of the reflecting surface is unacceptable”

Add the following to Article 1067(f) of the Standard Specifications:

“The ballast shall be a High Pressure Sodium, high power factor, constant wattage auto-regulator, lead type (CWA) for operation on a nominal 240 volt system.”

Revise Article 1067(f)(1) of the Standard Specifications to read:

“The high pressure sodium, auto-regulator, lead type (CWA) ballast shall be designed to ANSI Standards and shall be designed and rated for operation on a nominal 240 volt system. The ballast shall provide positive lamp ignition at the input voltage of 216 volts. It shall operate the lamp over a range of input voltages from 216 to 264 volts without damage to the ballast. It shall provide lamp operation within lamp specifications for rated lamp life at input design voltage range. Operating characteristics shall produce output regulation not exceeding the following values:

Nominal Ballast Wattage	Maximum Ballast Regulation
750	25%
400	26%
310	26%
250	26%
150	24%
70	18%

For this measure, regulation shall be defined as the ratio of the lamp watt difference between the upper and lower operating curves to the nominal lamp watts; with the lamp watt difference taken within the ANSI trapezoid at the nominal lamp operating voltage point parallel to the minimum lamp volt line:

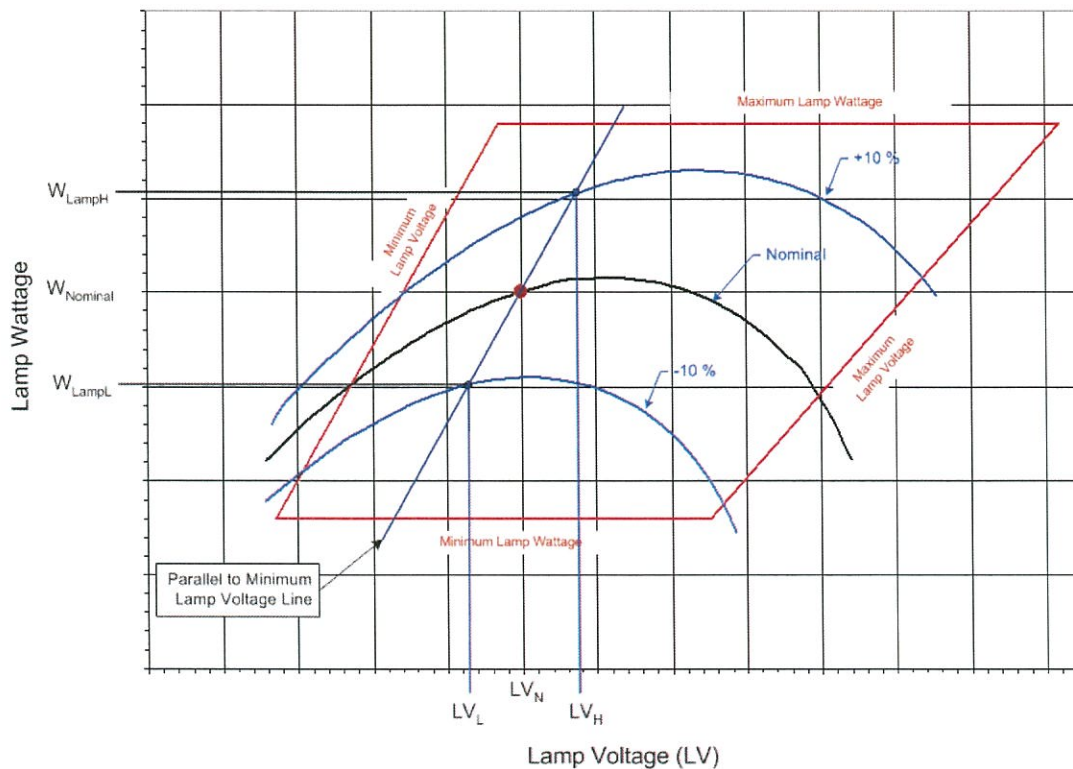

$$\text{Ballast Regulation} = \frac{W_{LampH} - W_{LampL}}{W_{LampN}} \times 100$$

where:

W_{LampH} = lamp watts at +10% line voltage when Lamp voltage = LV_H

W_{LampL} = lamp watts at - 10% line voltage when lamp voltage = LV_L

W_{lampN} = lamp watts at nominal lamp operating voltage = LV_N

Wattage	Nominal Lamp Voltage, LV_N	LV_L	LV_H
750	120v	115v	125v
400	100v	95v	105v
310	100v	95v	105v
250	100v	95v	105v
150	55v	50v	60v
70	52v	47v	57v

Ballast losses, based on cold bench tests, shall not exceed the following values:

Nominal Ballast Wattage	Maximum Ballast Losses
750	15%
400	20%
310	21%
250	24%
150	26%
70	34%

Ballast losses shall be calculated based on input watts and lamp watts at nominal system voltage as indicated in the following equation:

$$\text{Ballast Losses} = \frac{W_{Line} - W_{Lamp}}{W_{Lamp}} \times 100$$

where:

W_{line} = line watts at nominal system voltage

W_{lamp} = lamp watts at nominal system voltage

Ballast output to lamp. At nominal system voltage and nominal lamp voltage, the ballast shall deliver lamp wattage with the variation specified in the following table.

Nominal Ballast Wattage	Output to lamp variation
750	± 7.5%
400	± 7.5%
310	± 7.5%
250	± 7.5%
150	± 7.5%
70	± 7.5%

Example: For a 400w luminaire, the ballast shall deliver 400 watts ±7.5% at a lamp voltage of 100v for the nominal system voltage of 240v which is the range of 370w to 430w.

Ballast output over lamp life. Over the life of the lamp the ballast shall produce average output wattage of the nominal lamp rating as specified in the following table. Lamp wattage readings shall be taken at 5-volt increments throughout the ballast trapezoid. Reading shall begin at the lamp voltage (LV) specified in the table and continue at 5 volt increments until the right side of the trapezoid is reached. The lamp wattage values shall then be averaged and shall be within the specified value of the nominal ballast rating. Submittal documents shall include a tabulation of the lamp wattage vs. lamp voltage readings.

Nominal Ballast Wattage	LV Readings begin at	Maximum Wattage Variation
750	110v	± 7.5%
400	90v	± 7.5%
310	90v	± 7.5%
250	90v	± 7.5%
150	50v	± 7.5%
70	45v	± 7.5%

Example: For a 400w luminaire, the averaged lamp wattage reading shall not exceed the range of ±7.5% which is 370w to 430w”

Add the following to Article 1067(h) of the Standard Specifications:

“Independent Testing. Independent testing of luminaires shall be required whenever the pay item quantity of luminaires of a given pay item, as indicated on the plans, is 50 or

more. For each luminaire type to be so tested, one luminaire plus one luminaire for each 50 luminaires shall be tested. Example: *A plan pay item quantity of 75 luminaires for a specific pay item would dictate that 2 be tested; 135 luminaires would dictate that three be tested.* If the luminaire performance table is missing from the contract documents, the luminaire(s) shall be tested and the test results shall be evaluated against the manufacturer's data as provided in the approved material submittal. The test luminaire(s) results shall be equal to or better than the published data. If the test results indicated performance not meeting the published data, the test luminaire will be designated as failed and corrective action as described herein shall be performed.

The Contractor shall be responsible for all costs associated with the specified testing, including but not limited to shipping, travel and lodging costs as well as the costs of the tests themselves, all as part of the bid unit price for this item. Travel, lodging and other associated costs for travel by the Engineer shall be direct-billed to or shall be pre-paid by the Contractor, requiring no direct reimbursement to the Engineer or the independent witness, as applicable”

The Contractor shall select one of the following options for the required testing with the Engineer's approval:

- a. Engineer Factory Selection for Independent Lab: The Contractor may select this option if the luminaire manufacturing facility is within the state of Illinois. The Contractor shall propose an independent test laboratory for approval by the Engineer. The selected luminaires shall be marked by the Engineer and shipped to the independent laboratory for tests.
- b. Engineer Witness of Independent Lab Test: The Contractor may select this option if the independent testing laboratory is within the state of Illinois. The Engineer shall select, from the project luminaires at the manufacturer's facility or at the Contractor's storage facility, luminaires for testing by the independent laboratory.
- c. Independent Witness of Manufacturer Testing: The independent witness shall select from the project luminaires at the manufacturers facility or at the Contractor's storage facility, the luminaires for testing. The Contractor shall propose a qualified independent agent, familiar with the luminaire requirements and test procedures, for approval by the Engineer, to witness the required tests as performed by the luminaire manufacturer.

The independent witness shall as a minimum meet the following requirements:

- ▶ Have been involved with roadway lighting design for at least 15 years.
- ▶ Not have been the employee of a luminaire or ballast manufacturer within the last 5 years.
- ▶ Not associated in any way (plan preparation, construction or supply) with the particular project being tested.
- ▶ Be a member of IESNA in good standing.
- ▶ Provide a list of professional references.

This list is not an all inclusive list and the Engineer will make the final determination as to the acceptability of the proposed independent witness.

- d. Engineer Factory Selection and Witness of Manufacturer Testing: The Contractor may select this option if the luminaire manufacturing facility is within the state of Illinois. At the Manufacturer's facility, the Engineer shall select the luminaires to be tested and shall be present during the testing process. The Contractor shall schedule travel by the Engineer to and from the Manufacturer's laboratory to witness the performance of the required tests.

Should any of the tested luminaires fail to satisfy the specifications and perform according to approved submittal information, the luminaire shall be unacceptable and be replaced by alternate equipment meeting the specifications with the submittal and testing process repeated in their entirety; or corrections made to achieve required performance. In the case of corrections, the Contractor shall advise the Engineer of corrections made and shall request a repeat of the specified testing and, if the corrections are deemed reasonable by the Engineer, the testing process shall be repeated. The number of luminaires to be tested shall be the same quantity as originally tested; i.e. if three luminaires were tested originally, one, two or three failed, another three must be tested after corrective action is taken.

Revise Article 1067.06(a)(1) of the Standard Specifications to read:

"The lamps shall be of the clear type and shall have a color of 1900° to 2200° Kelvin."

Add the following table(s) to Article 1067 of the Standard Specifications:

IDOT DISTRICT 1 LUMINAIRE PERFORMANCE TABLE

GIVEN CONDITIONS		
ROADWAY DATA	Pavement Width	72 (ft)
	Number of Lanes	6
	I.E.S. Surface Classification	R3
	Q-Zero Value	.07
LIGHT POLE DATA	Mounting Height	45.17 (ft)
	Mast Arm Length	8 (ft)
	Pole Set-Back From Edge of Pavement	4 (ft)
LUMINAIRE DATA	Lamp Type	HPS
	Lamp Lumens	50000
	I.E.S. Vertical Distribution	Medium
	I.E.S. Control Of Distribution	Cutoff
	I.E.S. Lateral Distribution	Type III
	Total Light Loss Factor	.7
LAYOUT DATA	Spacing	185 (ft)
	Configuration	Opposite
	Luminaire Overhang over edge of pavement	2 (ft)

NOTE: Variations from the above specified I.E.S. distribution pattern may be requested and acceptance of variations will be subject to review by the Engineer based on how well the performance requirements are met.

PERFORMANCE REQUIREMENTS		
--------------------------	--	--

NOTE: These performance requirements shall be the minimum acceptable standards of photometric performance for the luminaire, based on the given conditions listed above.

LUMINANCE	Average Luminance, L_{AVE}	0.90 Cd/m ²
	Uniformity Ratio, L_{AVE}/L_{MIN}	2.25 (Max)
	Uniformity Ratio, L_{MAX}/L_{MIN}	4.5 (Max)
	Veiling Luminance Ratio, L_V/L_{AVE}	0.20 (Max)

MAINTENANCE OF LIGHTING SYSTEMS

Effective: January 1, 2012

Replace Article 801.11 and 801.12 of the Standard Specifications with the following:

Effective the date the Contractor's activities (electrical or otherwise) at the job site begin, the Contractor shall be responsible for the proper operation and maintenance of all existing and proposed lighting systems which are part of, or which may be affected by the work until final acceptance or as otherwise determined by the Engineer.

Before performing any excavation, removal, or installation work (electrical or otherwise) at the site, the Contractor shall initiate a request for a maintenance transfer and preconstruction inspection, as specified elsewhere herein, to be held in the presence of the Engineer and a representative of the party or parties responsible for maintenance of any lighting systems which may be affected by the work. The request for the maintenance preconstruction inspection shall be made no less than seven (7) calendar days prior to the desired inspection date.

Existing lighting systems, when depicted on the plans, are intended only to indicate the general equipment installation of the systems involved and shall not be construed as an exact representation of the field conditions. It remains the Contractor's responsibility to visit the site to confirm and ascertain the exact condition of the electrical equipment and systems to be maintained.

Maintenance of Existing Lighting Systems

Existing lighting systems. Existing lighting systems shall be defined as any lighting system or part of a lighting system in service at the time of contract Letting. The contract drawings indicate the general extent of any existing lighting, but whether indicated or not, it remains the Contractor's responsibility to ascertain the extent of effort required for compliance with these specifications and failure to do so will not be justification for extra payment or reduced responsibilities.

Extent of Maintenance.

Partial Maintenance. Unless otherwise indicated, if the number of circuits affected by the contract is equal to or less than 40% of the total number of circuits in a given controller and the controller is not part of the contract work, the Contractor needs only to maintain the affected circuits. The affected circuits shall be isolated by means of in-line waterproof fuse holders as specified elsewhere and as approved by the Engineer.

Full Maintenance. If the number of circuits affected by the contract is greater than 40% of the total number of circuits in a given controller, or if the controller is modified in any way under the contract work, the Contractor shall maintain the entire controller and all associated circuits.

Maintenance of Proposed Lighting Systems

Proposed Lighting Systems. Proposed lighting systems shall be defined as any lighting system or part of a lighting system, temporary or permanent, which is to be constructed under this contract.

The Contractor shall be fully responsible for maintenance of all items installed under this contract. Maintenance shall include, but not be limited to, any equipment failures or malfunctions as well as equipment damage either by the motoring public, Contractor operations, vandalism, or other means. The potential cost of replacing or repairing any malfunctioning, damaged, or vandalized equipment shall be included in the bid price of this item and will not be paid for separately.

Lighting System Maintenance Operations

The Contractor's responsibility shall include all applicable responsibilities of the Electrical Maintenance Contract, State of Illinois, Department of Transportation, Division of Highways, District One and the Village of Oak Brook. Current maintenance responsibilities are established as follows:

22nd Street at York Road: Both traffic signals and combination luminaires are maintained by IDOT. Relamping is performed by IDOT. The electrical feed for the combination luminaires come from the IDOT traffic signal cabinet.

22nd Street at Windsor Drive: Traffic signals are maintained by IDOT. The luminaires on the combination poles are maintained by the Village of Oak Brook. Relamping is done by the Village. The electrical feed for the combination luminaires comes from the IDOT traffic signal cabinet.

York Road and Dover: Both the traffic signals and the luminaires on the combination poles are maintained by the Village of Oak Brook. The electrical feed for the combination luminaires comes from the traffic signal cabinet.

York Road at Clearwater: Both the traffic signals and the luminaires on the combination poles are maintained by the Village of Oak Brook. The electrical feed for the combination luminaires comes from the traffic signal cabinet.

Maintenance responsibilities shall include the maintenance of lighting units (including sign lighting), cable runs and lighting controls. In the case of a pole knockdown or sign light damage, the Contractor shall promptly clear the lighting unit and circuit discontinuity and restore the system to service. The equipment shall then be re-set by the contractor within the time limits specified herein.

If the equipment damaged by normal vehicular traffic, not contractor operations, is beyond repair and cannot be re-set, the contractor shall replace the equipment in kind with payment made for such equipment under Article 109.04. If the equipment damaged by any construction operations, not normal vehicular traffic, is beyond repair and cannot be re-set, the contractor shall replace the equipment in kind and the cost of the equipment shall be included in the cost of this pay item and shall not be paid for separately.

Responsibilities shall also include weekly night-time patrol of the lighting system, with patrol reports filed immediately with the Engineer and with deficiencies corrected within 24 hours of the patrol. Patrol reports shall be presented on standard forms as designated by the Engineer. Uncorrected deficiencies may be designated by the Engineer as necessitating emergency repairs as described elsewhere herein.

The following chart lists the maximum response, service restoration, and permanent repair time the Contractor will be allowed to perform corrective action on specific lighting system equipment.

INCIDENT OR PROBLEM	SERVICE RESPONSE TIME	SERVICE RESTORATION TIME	PERMANENT REPAIR TIME
Control cabinet out	1 hour	4 hours	7 Calendar days
Hanging mast arm	1 hour to clear	na	7 Calendar days
Radio problem	1 hour	4 hours	7 Calendar days
Motorist caused damage or leaning light pole 10 degrees or more	1 hour to clear	4 hours	7 Calendar days
Circuit out – Needs to reset breaker	1 hour	4 hours	na
Circuit out – Cable trouble	1 hour	24 hours	21 Calendar days
Outage of 3 or more successive lights	1 hour	4 hours	na
Outage of 75% of lights on one tower	1 hour	4 hours	na
Outage of light nearest RR crossing approach, Islands and gores	1 hour	4 hours	na
Outage (single or multiple) found on night outage survey or reported to EMC	na	na	7 Calendar days
Navigation light outage	na	na	24 hours

- **Service Response Time** -- amount of time from the initial notification to the Contractor until a patrolman physically arrives at the location.
- **Service Restoration Time** – amount of time from the initial notification to the Contractor until the time the system is fully operational again (In cases of motorist caused damage the undamaged portions of the system are operational.)
- **Permanent Repair Time** – amount of time from initial notification to the Contractor until the time permanent repairs are made if the Contractor was required to make temporary repairs to meet the service restoration requirement.

Failure to provide this service will result in liquidated damages of \$500 per day per occurrence. In addition, the Department and/or the Village of Oak Brook reserve the right to assign any work not completed within this timeframe to the Electrical Maintenance Contractor and/or the Village of Oak Brook. All costs associated to repair this uncompleted work shall be the responsibility of the Contractor. Failure to pay these costs to the Electrical Maintenance Contractor and/or Village of Oak Brook within one month after the incident will result in additional liquidated damages of \$500 per month per occurrence. Unpaid bills will be deducted from any monies owed to the Contractor. Repeated failures and/or a gross failure of maintenance shall result in the State's Electrical Maintenance Contractor and/or the Village of Oak Brook being directed to correct all deficiencies and the resulting costs deducted from any monies owed the contractor.

Damage caused by the Contractor's operations shall be repaired at no additional cost to the Contract.

Operation of Lighting

The lighting shall be operational every night, dusk to dawn. Duplicate lighting systems (such as temporary lighting and proposed new lighting) shall not be operated simultaneously. Lighting systems shall not be kept in operation during long daytime periods.

Method of Measurement

The contractor shall demonstrate to the satisfaction of the Engineer that the lighting system is fully operational prior to submitting a pay request. Failure to do so will be grounds for denying the pay request. Months in which the lighting systems are not maintained and not operational will not be paid for. Payment shall not be made retroactively for months in which lighting systems were not operational.

Basis of Payment. Maintenance of lighting systems shall be paid for at the contract unit price per calendar month for **MAINTENANCE OF LIGHTING SYSTEM**, which shall include all work as described herein.

STATUS OF UTILITIES TO BE ADJUSTED

Effective: January 30, 1987
 Revised: January 24, 2013

Utilities companies involved in this project have provided the following estimated durations:

Name of Utility	Type	Location	Estimated Duration of Time for the Completion of
-----------------	------	----------	--

			Relocation or Adjustments
Nicor Gas Utility Consultant 630-388-2362	Gas	Underground	No Adjustments Required
ComEd Design Stage 630-576-7094	Electric	Underground	No Adjustments Required
AT&T Carl Donahue 847-420-9115	Telephone	Underground	No Adjustments Required
Village of Oak Brook Engineering Department 630-368-5130	Water/Sanitary	Underground	No Adjustments Required
DuPage Water Commission Michael Schweizer 630-834-0100	Water	Underground	No Adjustments Required
Comcast Martha Gieras 630-600-6352	Cable TV	Underground	No Adjustments Required
MCI Dean Boyers 972-729-6322	Communications	Underground	No Adjustments Required
BP Pipelines Brad Krabel 630-536-2729	Petroleum	Underground	No Adjustments Required
Flagg Creek Water Reclamation District Jim Liubicich 630-323-3299	Sanitary	Underground	No Adjustments Required

The above represents the best information available to the Department and is included for the convenience of the bidder. The applicable portions of Articles 105.07 and 107.31 of the Standard Specifications shall apply.

In accordance with 605 ILCS 5/9-113 of the Illinois Compiled Statutes, utility companies have 90 days to complete the relocation of their facilities after receipt of written notice from the Department. The 90-day written notice will be sent to the utility companies after the following occurs:

- 1) Proposed right of way is clear for contract award.
- 2) Final plans have been sent to and received by the utility company.
- 3) Utility permit is received by the Department and the Department is ready to issue said permit.
- 4) If a permit has not been submitted, a 15 day letter is sent to the utility company notifying them they have 15 days to provide their permit application. After allowing 15 days for submission of the permit the 90 day notice is sent to the utility company.

- 5) Any time within the 90 day relocation period the utility company may request a waiver for additional time to complete their relocation. The Department has 10 days to review and respond to a waiver request.

UNDERGROUND RACEWAYS

Effective: January 1, 2012

Revise Article 810.04 of the Standard Specifications to read:

“Installation. All underground conduit shall have a minimum depth of 30-inches (700 mm) below the finished grade.”

Add the following to Article 810.04 of the Standard Specifications:

“All metal conduit installed underground shall be Rigid Steel Conduit unless otherwise indicated on the plans.”

Add the following to Article 810.04 of the Standard Specifications:

“All raceways which extend outside of a structure or duct bank but are not terminated in a cabinet, junction box, pull box, handhole, post, pole, or pedestal shall extend a minimum of 300 mm (12”) or the length shown on the plans beyond the structure or duct bank. The end of this extension shall be capped and sealed with a cap designed for the conduit to be capped. The ends of rigid metal conduit to be capped shall be threaded, the threads protected with full galvanizing, and capped with a threaded galvanized steel cap. The ends of rigid nonmetallic conduit and coilable nonmetallic conduit shall be capped with a rigid PVC cap of not less than 3 mm (0.125”) thick. The cap shall be sealed to the conduit using a room-temperature-vulcanizing (RTV) sealant compatible with the material of both the cap and the conduit. A washer or similar metal ring shall be glued to the inside center of the cap with epoxy, and the pull cord shall be tied to this ring.”

Add the following to Article 810.04(c) of the Standard Specifications:

“Coilable non-metallic conduit shall be machine straightened to remove the longitudinal curvature caused by coiling the conduit onto reels prior to installing in trench, encasing in concrete or embedding in structure. The straightening shall not deform the cross-section of the conduit such that any two measured outside diameters, each from any location and at any orientation around the longitudinal axis along the conduit differ by more than 6 mm (0.25”).” The longitudinal axis of the straightened conduit shall not deviate by more than 20 mm per meter (0.25” per foot” from a straight line. The HDPE and straightening mechanism manufacturer operating temperatures shall be followed.

UNIT DUCT

Effective: January 1, 2012

Revise the first paragraph of Article 810.04 to read:

“The unit duct shall be installed at a minimum depth of 30-inches (760 mm) unless otherwise directed by the Engineer.”

Revise Article 1088.01(c) to read:

“(c) Coilable Nonmetallic Conduit.

General:

The duct shall be a plastic duct which is intended for underground use and which can be manufactured and coiled or reeled in continuous transportable lengths and uncoiled for further processing and/or installation without adversely affecting its properties of performance. The duct shall be a plastic duct which is intended for underground use and can be manufactured and coiled or reeled in continuous transportable lengths and uncoiled for further processing and/or installation without adversely affecting its properties of performance.

The duct shall be made of high density polyethylene which shall meet the requirements of ASTM D 2447, for schedule 40. The duct shall be composed of black high density polyethylene meeting the requirements of ASTM D 3350, Class C, Grade P33. The wall thickness shall be in accordance with Table 2 for ASTM D 2447.

The duct shall be UL Listed per 651-B for continuous length HDPE coiled conduit. The duct shall also comply with NEC Article 354.100 and 354.120.

Submittal information shall demonstrate compliance with the details of these requirements.

Dimensions:

Duct dimensions shall conform to the standards listed in ASTM D2447. Submittal information shall demonstrate compliance with these requirements.

Nominal Size		Nominal I.D.		Nominal O.D.		Minimum Wall	
mm	in	mm	in	mm	in	mm	in
31.75	1.25	35.05	1.38	42.16	1.66	3.556	0.140
						+0.51	+0.020
38.1	1.50	40.89	1.61	48.26	1.90	3.683	0.145
						+0.51	+0.020

Nominal Size		Pulled Tensile	
mm	in	N	lbs
31.75	1.25	3322	747
38.1	1.50	3972	893

Marking:

As specified in NEMA Standard Publication No. TC-7, the duct shall be clearly and durably marked at least every 3.05 meters (10 feet) with the material designation (HDPE for high density polyethylene), nominal size of the duct and the name and/or trademark of the manufacturer.

Performance Tests:

Polyethylene Duct testing procedures and test results shall meet the requirements of UL 651. Certified copies of the test report shall be submitted to the Engineer prior to the installation of the duct. Duct crush test results shall meet or exceed the following requirements:

Duct Diameter		Min. force required to deform sample 50%	
mm	in	N	lbs
35	1.25	4937	1110
41	1.5	4559	1025

WIRE AND CABLE

Effective: January 1, 2012

Add the following to the first paragraph of Article 1066.02(a):

“The cable shall be rated at a minimum of 90°C dry and 75°C wet and shall be suitable for installation in wet and dry locations, and shall be resistant to oils and chemicals.”

Revise the Aerial Electric Cable Properties table of Article 1066.03(a)(3) to read:

Aerial Electric Cable Properties

Phase Conductor		Messenger wire			
Size AWG	Stranding	Average Insulation Thickness		Minimum Size AWG	Stranding
		mm	mils		
6	7	1.1	(45)	6	6/1
4	7	1.1	(45)	4	6/1
2	7	1.1	(45)	2	6/1
1/0	19	1.5	(60)	1/0	6/1
2/0	19	1.5	(60)	2/0	6/1
3/0	19	1.5	(60)	3/0	6/1
4/0	19	1.5	(60)	4/0	6/1

Add the following to Article 1066.03(b) of the Standard Specifications:

“Cable sized No. 2 AWG and smaller shall be U.L. listed Type RHH/RHW and may be Type RHH/RHW/USE. Cable sized larger than No. 2 AWG shall be U.L. listed Type RHH/RHW/USE.”

Revise Article 1066.04 to read:

“Aerial Cable Assembly. The aerial cable shall be an assembly of insulated aluminum conductors according to Section 1066.02 and 1066.03. Unless otherwise indicated, the cable assembly shall be composed of three insulated conductors and a steel reinforced bare aluminum conductor (ACSR) to be used as the ground conductor. Unless otherwise indicated, the code word designation of this cable assembly is “Palomino”. The steel reinforced aluminum conductor shall conform to ASTM B-232. The cable shall be assembled according to ANSI/ICEA S-76-474.”

Revise the second paragraph of Article 1066.05 to read:

“The tape shall have reinforced metallic detection capabilities consisting of a woven reinforced polyethylene tape with a metallic core or backing.”

STRUCTURE ADJUSTMENTS

Description. This work shall include all materials, labor and equipment necessary to adjust existing utility structures within the median as depicted in the plans. This work shall be completed in accordance with Section 602 of the Standard Specifications.

Basis of Payment. This work shall be paid for at the contract unit price per each for DRAINAGE & UTILITY STRUCTURES TO BE ADJUSTED and no additional compensation will be allowed.

EARTH EXCAVATION

Description. This work shall consist of the stockpiling, transportation, and disposal of excavated material, if required, in accordance with Section 202 of the Standard Specifications except as specified herein, as shown on the plans, and as directed by the Engineer.

Construction. This work shall be performed in accordance with Section 202 of the Standard Specifications except as modified herein.

After all topsoil has been excavated and stockpiled, excavate areas within existing landscaped medians to the additional depths necessary to construct the improvements as shown on the plans and details. Stockpile materials on-site that are suitable for re-use. Backfill precast concrete planter curbs with suitable materials as directed by the Engineer. Dispose of all unsuitable materials off-site in accordance

with the Standard Specifications. It shall be the Contractor's responsibility to locate a site that will accept this material.

Measurement. The contract unit price for earth excavation will be measured in its original position, and the volumes in cubic yards computed by the method of average end areas. Earth moved more than once due to stage of construction or any other reason will not be measured for payment. Topsoil excavation will be paid for separately.

Basis of Payment. This work will be paid for at the contract unit price per cubic yard for EARTH EXCAVATION, which price shall include all other items of work included under the Standard Specifications general heading of Earthwork for which no payment item is included in the contract. Earth moved more than once due to stage of construction or any other reason will not be paid for separately and shall be included in the contract unit price for EARTH EXCAVATION.

Removal and disposal of unsuitable material will not be paid for separately and shall be included in the contract unit price for EARTH EXCAVATION.

TOPSOIL AND SOIL CONDITIONER

Description. This work shall consist of excavating or furnishing, transporting, preparing, conditioning, and placing topsoil from within the site or imported from offsite sources. The work shall be completed in accordance with Section 211 of the Standard Specifications except as specified herein, as shown on the plans, and as directed by the Engineer.

Materials. Topsoil shall be provided in accordance with Article 1081.05 of the Standard Specifications with the exception that the minimum organic content shall be 4 percent.

Import topsoil from offsite sources if required. Obtain topsoil displaced from naturally well-drained construction or mining sites where topsoil occurs at least 4 inches deep; do not obtain from agricultural land, bogs or marshes.

Amend topsoil for all shrub and perennial beds with Soil Conditioner. Soil Conditioner shall be a mixture of Compost, Peat, Sand, Wood Derivatives, and Manure as an amendment to available topsoil, in order to create a moist, well drained planting mix:

1. Compost: Well-composted, stable, and weed-free organic matter, pH range of 5.5 to 8; moisture content 35 to 55 percent by weight; 100 percent passing through 1-inch sieve. (1 part)
2. Peat: Finely divided or granular texture, with a pH range of 6 to 7.5, containing partially decomposed moss peat, native peat, or reed-sedge peat and having a water-absorbing capacity of 1100 to 2000 percent. (1 part)
3. Sand: Clean, washed, FA2 (course sand), free of toxic materials (2 parts)
4. Wood Derivatives: Decomposed, nitrogen-treated sawdust, ground bark, or wood waste; of uniform texture, free of chips, stones, sticks, soil, or toxic materials. (4 parts)
5. Manure: Well-rotted, unleached, stable or cattle manure containing not more than 25 percent by volume of straw, sawdust, or other bedding materials; free of toxic substances, stones, sticks, soil, weed seed, and material harmful to plant growth. (1 part)

Soil Conditioner shall also include a commercial-grade complete fertilizer of neutral character, consisting of fast- and slow-release nitrogen, 50 percent derived from natural organic sources of urea formaldehyde, phosphorous, and potassium in the following composition:

1. Composition: 1 lb/1000 sq. ft. of actual nitrogen, 4 percent phosphorous, and 2 percent potassium, by weight.

Construction. This work shall be performed in accordance with Articles 211.04 and 211.05 of the Standard Specifications except as modified herein.

Place topsoil and complete finish grading to meet grades as shown on the plans. Place topsoil to a depth of 6 inches in all sod areas. Backfill all raised precast concrete planter curb areas to a depth of 24 inches as indicated on the plans and details. Place topsoil to a depth of 18 inches in all other planting bed areas. Amend topsoil in all planting bed areas with a 6" depth of Soil Conditioner to meet the requirements specified herein.

Measurement. The topsoil related items shall be measured as follows:

TOPSOIL EXCAVATION AND PLACEMENT, shall include excavating the top 6 inches of material, stockpiling this material at a location designated by the Engineer and then placing this material in raised precast concrete planter curbs to the depths to meet finish grades as indicated on the plans and details, to a depth of 6 inches in all sod areas, and to a depth of 18 inches in all other planting bed areas, including all materials, labor, or equipment required to complete this work.

TOPSOIL FURNISH AND PLACE shall include importing and placing topsoil to a depth of 6 inches in all sod areas, to a depth of 24 inches in all raised precast concrete planter curb areas, and to a depth of 18 inches in all other planting bed areas, including all materials, labor, or equipment required to complete this work.

SOIL CONDITIONER shall include providing soil conditioner to a 6 inch depth for all planting beds including all materials, labor, or equipment required to complete this work.

Basis of Payment. This work shall be paid for at the contract unit price per cubic yard for TOPSOIL EXCAVATION AND PLACEMENT; and per square yard for TOPSOIL FURNISH AND PLACE, 6", TOPSOIL FURNISH AND PLACE, 18", TOPSOIL FURNISH AND PLACE, 24", and SOIL CONDITIONER, and no additional compensation will be allowed.

SODDING, SALT TOLERANT

Description. This work shall consist of furnishing, transporting, and placing sod in accordance with Section 252 of the Standard Specifications except as specified herein, as shown on the plans, and as directed by the Engineer. The work shall include transporting, placing, fertilizing, watering, resodding when required, mowing, and maintaining sodded areas until the project completion date, including all materials, labor, and equipment required to complete this work.

Materials. Materials provided for sodding shall be provided in accordance with Article 252.02 and Article 1081.03(b) of the Standard Specifications except as specified herein, as shown on the plans, and as directed by the Engineer.

Sod shall be salt tolerant sod as identified in the Standard Specifications.

Fertilizer for sod areas shall be provided and applied in accordance with the standard specifications.

Construction. This work shall be performed in accordance with Section 252 of the Standard Specifications.

Measurement. The contract unit price for sodding shall include furnishing, transporting, placing, fertilizing, watering, resodding when required, mowing, and maintaining sodded areas until the project completion date, including all materials, labor, and equipment required to complete this work.

Basis of Payment. This work shall be paid for at the contract unit price per square yard for SODDING, SALT TOLERANT and no additional compensation will be allowed.

PRECAST CONCRETE CURB

Description. This work shall consist of fabricating, furnishing, transporting, and placing precast architectural concrete as specified herein, as shown on the plans, and as directed by the Engineer. Work shall include preparation of shop drawings, fabrication, placement, mortar, anchoring, caulk, and cleanup necessary for construction of precast concrete curb.

Materials. Precast concrete curb shall be 5,000 PSI concrete with 6%-8% air entrainment, limestone type finish as indicated on the plans. Color to be buff, to be approved by Engineer prior to fabrication. Dimensions to be as shown on the plans.

Provide Type S mortar suitable for exterior precast concrete curb work. Submit mortar manufacturer's product data to Engineer for approval prior to ordering. Engineer to select mortar color from manufacturer's full range of color options.

Provide caulk and backer rod suitable for exterior precast concrete curb work. Submit manufacturer's product data to Engineer for approval prior to ordering. Engineer to select caulk color from manufacturer's full range of color options.

Provide galvanized metal attachment anchors as recommended by the fabricator or as shown on the plans.

Fabrication. Prior to fabrication, prepare and submit shop drawings for each type of precast concrete curb based on field measurements. Fabricator to be a qualified company that assumes responsibility for engineering precast concrete curb units to comply with the required performance requirements.

Fabricate precast concrete curb units straight and true to size and shape as shown on the plans.

Provide reinforcement to resist handling, transportation, and erection stresses and cast-in anchorage hardware as required for applications as shown on the plans.

Place concrete in a continuous operation to prevent seams or planes of weakness from forming in precast concrete units. Thoroughly consolidate placed concrete by internal and external vibration without

dislocating or damaging reinforcement and built-in items, and minimize pour lines, honeycombing, or entrapped air on surfaces.

Cure concrete by moisture retention without heat, or by accelerated heat curing using low-pressure live steam, or radiant heat and moisture. Cure units until compressive strength is high enough to ensure that stripping does not have an effect on performance or appearance of final product.

Construction. Erect precast concrete curb level, plumb, and square within specified allowable tolerances. Provide temporary supports and bracing as required to maintain position, stability, and alignment as units are being permanently connected. Maintain horizontal and vertical joint alignment and uniform joint width as erection progresses. Unless otherwise indicated, provide for uniform joint widths of 3/4 inch.

Connect precast concrete curb units in position by grouting or as otherwise indicated on shop drawings. Remove temporary shims, wedges, and spacers as soon as practical after connecting and grouting are completed.

Grout connections where required or indicated. Retain grout in place until hard enough to support itself. Pack spaces with stiff grout material, tamping until voids are completely filled. Place grout to finish smooth, level, and plumb with adjacent concrete surfaces. Keep grouted joints damp for not less than 24 hours after initial set. Promptly remove grout material from exposed surfaces before it affects finishes or hardens.

Install backer rod and caulk joints as shown on plans.

Measurement. The contract unit price for precast concrete curb shall include preparation of shop drawings, fabrication, placement, mortar, anchoring, caulk, cleanup, and all other materials, labor, and equipment required to complete this work.

Basis of Payment. This work shall be paid for at the contract unit price per foot for PRECAST CONCRETE CURB, and no additional compensation will be allowed.

PLANTING WOODY PLANTS

Description. This work shall consist of furnishing, transporting, and planting trees and shrubs in accordance with Section 253 of the Standard Specifications except as specified herein, as shown on the plans, and as directed by the Engineer. The work shall include all bracing, wrapping, watering, weeding, replacement of plants when required, including all materials, labor, and equipment required to complete this work.

Materials. Provide trees, shrubs, and accessories in accordance with Section 253 and Article 1081.01 of the Standard Specifications except as modified herein.

Provide quality, size, genus, species, and variety of trees and shrubs as shown on the plans in compliance with the "American Standard for Nursery Stock" latest edition.

All trees to be provided balled and burlapped. All shrubs to be provided either balled and burlapped or container grown.

Mulch shall be six-month old, well rotted, shredded, native hardwood bark mulch, not larger than 4 inches in length and ½ inches in width, free of wood chips and sawdust.

Construction. This work shall be performed in accordance with Article 253 of the Standard Specifications.

Measurement. The contract unit price for trees and shrubs shall include furnishing, transporting, and planting trees and shrubs including bracing, wrapping, watering, mulching, weeding, replacement of plants when required and all materials, labor, or equipment required to complete this work.

Basis of Payment. This work shall be paid for at the contract unit price per each for TREES (PER INDIVIDUAL PLANT CODE PAY ITEM), SHRUBS (PER INDIVIDUAL PLANT CODE PAY ITEM) and EVERGREEN (PER INDIVIDUAL PLANT CODE PAY ITEM) and no additional compensation will be allowed. Refer to material list on planting plans for individual tree and shrub species.

PLANTING PERENNIAL PLANTS

Description. This work shall consist of furnishing, transporting, and planting perennial plants in accordance with Section 254 of the Standard Specifications except as specified herein, as shown on the plans, and as directed by the Engineer. The work shall include preparing the planting area, planting, watering, weeding, replacement of plants when required, and maintaining perennial areas until the project completion date, including all materials, labor, and equipment required to complete this work.

Materials. Provide perennial plants and accessories in accordance with Article 1081.02 of the Standard Specifications except as modified herein.

Provide container grown perennial plants for ornamental planting areas as indicated on the plans of the quality, size, genus, species, and variety as shown on the plans in compliance with the "American Standard for Nursery Stock" latest edition.

Construction. This work shall be performed in accordance with Section 254 of the Standard Specifications except as modified herein.

Trees and shrubs must be installed prior to installation of perennials to establish proper layout and to avoid damage to perennial plantings.

Plant perennial plants equally spaced throughout ornamental planting areas as shown on the plans.

Measurement. The contract unit price for perennial plants shall include furnishing, transporting, preparing the planting area, planting, watering, mulching, weeding, replacement of plants when required, and maintaining perennial areas until the project completion date, including all materials, labor, and equipment required to complete this work.

Basis of Payment. This work shall be paid for at the contract unit price per unit (one unit equals 100 plants) for PERENNIAL PLANTS, ORNAMENTAL TYPE, GALLON POT, and no additional compensation will be allowed. Refer to material list on planting plans for individual perennial plant species.

IRRIGATION SYSTEM

Description. This work includes installation of the irrigation system as indicated on the drawings and as specified herein.

Contractor shall submit required shop drawings for approval by the Engineer and the Owner prior to commencement of any work on this item that has changed from the original design.

This work shall include all labor, material, equipment, tools, transportation, permits, and services to construct the irrigation system as designed and per approved shop drawings, in accordance with sections 561, 562, 563, and 565 of the Standard Specification for Road and Bridge Construction and the Standard Construction Details, except as herein modified.

Sprinkler lines shown on the drawings are essentially diagrammatic. Spacing of the sprinkler heads or quick coupling valves are shown on the drawings and shall be exceeded only with the permission of the Engineer.

The irrigation system shall include a controlled valve distribution system. Contractor shall furnish and install equipment as common in the industry, associated piping and incidentals as shown and specified.

The system shall be designed such that water at no time run off or spray onto the pavement. Contractor is responsible for field adjustments and final spray head nozzle selections.

This work shall include monitoring and adjusting the completed system to assure healthy plant development.

Water Services.

Work described in the items WATER TAP, WATER VALVE ASSEMBLY, WATER METER, BACKFLOW PREVENTER (R.P.Z.), and WATER SERVICE LINE will collectively be described as WATER SERVICE CONNECTIONS within this specification. A 2" line will be provided at the taps. Field verify sizes and notify the owner if they are not 2". All other components should be included in the unit price for the irrigation system. The water meter installation, enclosures backflow preventer and curb stop will be the responsibility of the irrigation contractor. The water meter will be provided by the owner, contact Don Lange with the City at 630-368-5280 to coordinate. Contractor is responsible for all installations.

Water Service Components must be installed prior to the installation of the irrigation system. A self draining curb stop is required after the tap to allow for winterization from the tap up to the water meter.

The Water Service Components to be provided by others are shown on the plans. The number of water services and sizes shown on the plans have been designed to provide an adequate amount of water supply to service the areas to be irrigated (based on average water main pressure). Contractor is to verify existing water pressure at the main and notify the Engineer in writing if it is less than 60 psi static pressure.

The locations of Water Service Components are shown on the plans schematically. The location the Water Service Components will need to be verified in the field.

Electrical Services.

A 120v power wire will be provided to the controller locations. Coordinate with the Engineer for exact locations of service tap at the controller location. The irrigation contractor will be responsible to make the connections from the controller to the wire source provided by others.

Codes and Standards.

Codes: All plumbing work shall be installed within applicable provisions of the Village of Oak Brook building codes.

All devices and their installation must be in accordance with the Village of Oak Brook Plumbing Code which incorporates Illinois Plumbing Code 2004 and Chicago Plumbing Code 2003.

Standards: Items listed to conform to ASTM, ANSI, or manufactures recommendations, for installation.

Any permits for the installation or construction of the work included under this contract which are required by any of the legally constituted authorities having jurisdiction, shall be obtained and paid for by the Contractor, each at the proper time. He shall also arrange for and pay all costs concerning any inspections and examinations required by these authorities.

In all cases where inspection of the sprinkler system work is required and/or where portions of the work are specified to be performed under the direction and/inspection of the Engineer, the Contractor shall notify the Engineer at least 48 hours in advance of the time and such inspection and/or direction is required.

Any necessary re-excavation or alterations to the system needed because of failure of the Contractor to have the required inspections, in the opinion of the Engineer, shall be performed at the "Contractor's" own expense.

Submittals.

Any required shop drawings for design changes shall be prepared by the Contractor. Submit samples unless directed otherwise by the Engineer.

Material Sample List: Include backflow device, valves, sprinklers, controllers, enclosures, wire, wire connectors, pipe, fittings, valve boxes, swing joints and quick couplers to be used on the project prior to purchasing materials. Quantities of material need not be included.

Manufacturer's Data: Submit manufacturer's catalog cuts, specifications, and operating instructions for the equipment mentioned above and equipment shown on the materials list.

Project Record (As-Built) Drawings.

The Contractor is to provide the Owner a scaled drawing of the completed field "As-Built" of the system.

All components of the system are to be drawn and referenced to a fixed location on the site.

Components of the system but not limited to, sprinkler heads, electric valves, isolation valves, all PVC piping, quick couplers, PVC pipe sizing, grounding, power wire routes and size and 24v wire routes or decoder routes from the controller to the electric valves including common runs.

All PVC piping shall be referenced in the trench for lengths of run, change in direction and distance and locations of all components referenced in feet from a known point.

Two final hard copies of the overall drawings with dimension and notes are to be provided to the Owner and one copy of the As-Built in AutoCad 2013 digital format at the same scale drawing as provided to the Contractor. The Contractor is to provide individual controller sequencing sheets in a 24" x 36" size and 8 ½" x 11" format. Both submittals shall be laminated and placed as directed by the Engineer.

Rules and Regulations.

Work and materials shall be in accordance with the latest edition of the National Electric Code, the Uniform Plumbing Code, and applicable laws and regulations of the governing authorities.

When the contract documents call for materials or construction of a better quality or larger size than required by the above-mentioned rules and regulations, provide the quality and size required by the contract documents.

Quality Assurance.

The Contractor shall maintain continuously a competent superintendent, satisfactory to the Engineer, with authority to act for him in all matters pertaining to the work. The Contractor shall coordinate his work with the other trades.

The Contractor shall confine his operations to the area to be improved and to the areas allotted him by the Engineer for material and equipment storage.

The Contractor shall have a minimum of 5 years experience installing irrigation systems of comparable size and complexity. The contractor shall also have suitable financial status to meet obligations for this project.

Delivery, Storage and Handling.

Deliver irrigation system components in manufacturer's original undamaged and unopened containers with labels intact and legible.

Deliver plastic piping in bundles, packaged to provide adequate protection of pipe ends either threaded or plain. Store and handle materials to prevent damage and deterioration.

Provide secure, locked storage for valves, sprinkler heads and similar components that cannot be immediately replaced, to prevent installation delays.

Materials.

Manufacturers and Minimum Requirements.

Use materials that are new and without flaws or defects of any type, and which are the best of their class and kind. All material overages at the completion of the installation are the property of the Contractor and are to be removed from the site.

Each major component of equipment shall have manufacturer's name, address, catalog and serial number permanently attached in a conspicuous place.

The same brand or manufacturer shall be used for each specific application of valves, fittings, controls, and other equipment.

All materials shall be new and of the quality specified.

All equipment shall be listed, approved or rated by a nationally recognized testing and rating bureau of recognized manufacturer's association responsible for setting industry standards. All electrical equipment and apparatus shall be U.L. listed.

Acceptable irrigation manufacturers – Hunter, RainBird or Toro.

It is the intent of this specification to establish a uniform equipment pallet for this and phases of the project. Substitutions will only be allowed by the Engineer.

PVC or Polyethylene Piping & Fittings.

PVC Mainline Piping and Open Trench Sleeving: Use rigid, unplasticized polyvinyl chloride (PVC) 1120, 1220 National Sanitation Foundation (NSF) approved pipe, extruded from material meeting the requirements of Cell Classification 12454-A or 12454-B, ASTM Standard D1784, with an integral belled end. Use Class 200, SDR-21, conforming to the dimensions and tolerances established by ASTM Standard D2241 for all main lines and sleeving within the median. Sleeving under concrete or roadways is to be galvanized steel. Pipe sleeving shall be equal to twice that of the pipe being sleeved. Minimum wire sleeve shall be 2" or as indicated.

Use solvent weld pipe for mainline pipe with a nominal diameter 2 1/2" inches and less or where a pipe connection occurs in a sleeve. Use Schedule 40, Type 1, PVC solvent weld fittings conforming to ASTM Standard D2466 and D1784. Use primer approved by the pipe manufacturer. Solvent cement to conform to ASTM Standard D2564.

Provide pipe homogeneous throughout and free from visible cracks, holes, foreign materials, blisters, wrinkles and dents.

Provide pipe continuously and permanently marked with manufacturer's name and trademark, size schedule and type of pipe working pressure at 73 degrees F. and (NSF) approval.

Pipe sizes referenced in the construction documents are minimum sizes, and may be increased at the option of the Contractor at no cost to the Owner.

All pipes damaged or rejected because of defects shall be removed from the site at the time of said rejection.

Polyethylene Pipe-PE Lateral Lines: All polyethylene (PE) pipe shall be virgin, high impact, polyethylene pipe, having minimum 100 PSI working pressure rating. All polyethylene pipe shall be continuously and permanently marked with manufacturer's name, material, size, and schedule of type.

Pipe shall conform to U.S. Department of Commerce Commercial Standard CS207-60, at latest revision. Material shall conform to all requirements of Commercial Standard (CS256-63), at latest revision.

Polyethylene insert pipe fittings shall be constructed of Schedule 80 and shall conform to ASTM D2466. Polyethylene pipe shall be secured to fitting by means of two(2) stainless steel hose clamps for fittings of 1.5" and 2". Fittings 1" and smaller shall use one(1) stainless steel crimp clamp or approved methods.

If conditions are appropriate and rock free for vibratory plowing, the contractor may plow lateral piping, but must get the Engineer's approval prior to installation.

All road bores are to be Galvanized steel pipe.

Specialized Pipe and Fittings:

All above grade pipe shall be copper pipe: Use Type "M" rigid conforming to ASTM Standard B88. Use wrought copper or cast bronze fitting, soldered or threaded per the installation details. Use 95% tin and 5% antimony solder.

Galvanized steel pipe: Use Schedule 40 conforming to ASTM Standard A120. Use galvanized, threaded, standard weight malleable iron fittings.

S-80 PVC fittings may be used and may be threaded or solvent weld. S-80 TOE nipples with S-80 couplings for plastic to metal connections. S-80 nipples cut in half will not be allowed.

Low-Density Polyethylene Hose: Use pipe specifically intended for use as a flexible swing joint, such as Funny Pipe or Swing Joint. Color: Black.

Use spiral barb fittings supplied by the same manufacturer as the hose.

Assemblies calling for threaded pipe connections shall use PVC Schedule 80 nipples and PVC Schedule 40 threaded fittings.

Use only Teflon-type tape on plastic threads.

Irrigation Controller.

Controller – Hunter I-Core OR RainBird ESP-LX Modular OR Toro TMC-424E.

Controller shall have a pedestal mount. The controller shall be mounted as directed by the Engineer. See plans for controller size. Timing shall be accomplished by solid-state means. Controller expansion shall be by module expansion units.

Power to the controllers will be provided by others to a tap location at the controller. The contractor will be responsible for making the connection from the power drop to the controller. The controller will be mounted as directed by the Owner. Provide and install a Intermatic AG2401 lightning surge arrester on the power to the controller.

Provide a Hunter Roam XL OR RainBird LIMR OR Toro TMR-1 receiver at each controller and provide one transmitter per project or approved equal. Mount receiver inside of the pedestal.

Provide a Hunter RainClik OR RainBird RSD Rain Sensor OR Toro Wired Rain Sensor at each controller location. Mount the sensor on the outside of the pedestal.

Grounding

The contractor will be responsible to provide earth grounding of the Controller. The contractor is to provide a ground rod with welded conductor. The contractor is to have the supplying distributor confirm in writing that the grounding has been completed per manufacturers recommendations.

Electric Control Valves.

All valves shall be of globe or globe/angle configuration with a female pipe thread inlet and outlet connections. Diaphragm assembly shall be sonically welded to form a solid-piece component. The diaphragm shall be of rubber construction to retain flexibility and provide maximum sealing throughout it's area.

Electric valves shall be 1" & 1.5" Hunter PGV Globe series electric valve series, RainBird PGA 1" & 1.5" or Toro 252 1" & 1.5". The valve shall have a manual flow control with a hand-operated, rising-type flow control stem with control wheel/handle and an internal manual bleed assembly. Size per plan.

All parts shall be serviceable without removing valve from line. Valve may be installed at any angle without affecting valve operation.

22" solenoid lead wires shall be attached to a 24 VAC solenoid with waterproof molded coil capable of being removed by turning coil. Valve shall be held normally closed by internal water pressure with manual bleed screw.

The legend and flow arrow shall be applied at all valve locations. Valve numbering shall be located so as to be conspicuous and legible. The controller and valve numbering can be engraved in black on a yellow plastic tag. The tag size shall be standard size of 2.25" x 2.66".

Heads, Spray, Swing Joints.

The spray head sprinklers shall be a 12" RainBird 1812 PRS-SAM Series OR Hunter PROS-12-CV OR Toro 570Z-12PCOM for spray heads in planting areas and 4" RainBird 1804 PRS-SAM Series OR Hunter PROS-04-PRS30-CV OR Toro 570Z-4P PRX COM for spray heads in turf areas. Sprinkler shall be mounted flush with final finish grade.

Retraction shall be achieved by a heavy-duty stainless steel retraction spring. Sprinkler shall have a riser seal and a wiper. Sprinkler housing shall be of high impact molded plastic. Sprinkler shall have a large strainer so as to prevent nozzle clogging. Sprinkler shall be constructed such that it is serviceable from top in that drive assembly, screen, and all internal components are accessible throughout top of sprinkler without disturbing case installation. The sprinkler shall have a built-in pressure regulation devise to regulate nozzle pressure regardless of the inlet pressure. The sprinkler shall have a drain check valve for up to 10 feet of elevation change.

Type and location of nozzles shall be Rain Bird XPCN Nozzles, MPR or Toro MPR Plus. Nozzles vary.

Solvent Weld Fittings.

Solvent weld PVC fittings shall be Schedule 40, ASTM D-2466 and ASTM D-1784. PVC Schedule-40 fittings shall be produced from PVC Type 1, Cell Classification 1245B. All solvents and cements shall be that recommended by the fittings manufacturer.

S-80 PVC fittings may be used and may be threaded or solvent weld. S-80 TOE Nipples with S-80 couplings for plastic to metal connections. (S-80 nipples cut in half will not be allowed)

Gate Valves.

Isolation valves 3" and smaller shall be bronze gate valves. The gate valve shall be 200lb rated WOG non-shock, solid disc, non-rising stem with threaded ends. Valves shall have a bronze cross handle.

Valve sizes shall be as shown on plan. Connections to the piping shall be made with a S-80 TOE nipple and a S-80 Coupling.

Control Wiring.

Use American Wire Gage #14 AWG standard direct burial wire. All signal wire shall include a solid copper conductor and polyethylene (PE) or PVC insulation. It shall be rated for 600 volts. All common wires shall be #14 AWG direct bury.

Color: Wire color shall be continuous over its entire length. See drawing for color coding of control wire.

Splices: Use 3M DBY, 3M DBR connectors with waterproof sealant. Wire connector to be of plastic construction.

Wire markers: pre-numbered or labeled with indelible non-fading ink, made of permanent, non-fading material.

All wiring to be installed following existing local and state codes.

Valve Boxes.

Valve boxes shall be manufactured by Armor, Carson or RainBird and shall be rectangular, 12" /w 6" extension or 6" and 10" round and have "T" lid tops.

Valve box shall be of a size that provides adequate space for valve repairs. For decoder systems, one valve per 12" rectangular box, for 24v systems, a maximum of 2 electric valves per 12" rectangular valve box. A 10" round valve box may be used for isolation valves, quick couplers and wire drops only.

The valve box cover shall have the component markings engraved or heat stamped into the cover. Use the following symbols for corresponding components in the valve box.

GV – for Gate Valves
EV – for Electric Valves
WS – for Wire Splice
EW – for Extra Wire Drop
GR - for Grounding

The final valve numbering shall also be branded into the tops with electric valves.

The lids and boxes will be green.

Controller / Back Flow Enclosures / Meter Enclosures.

The enclosure is to have 1 1/4" Sch 40 steel pipe for end frames. 1" x1/8" steel angle iron base, raised 3/8" above slab. Mesh to be 1/2" #13 ga. Diamond pattern flat rolled expanded steel with all welded construction 4" OC. Expanded metal die formed for uniformity. Enclosures are to have locking devices.

The enclosure will be powder coated with a five part metal cleaning process and iron phosphate solution treatment. Units preheated before applying 1.5 to 2.0 mil thickness Polyester powder, green in color. Backflow/meter enclosures are to be installed on a concrete pad; size to be determined by enclosure manufacturer.

Contractor is responsible to ensure the devices fit within the enclosures.

The backflow unit and water meter are to be in one enclosure.

BackFlow Unit/ Water Meter enclosure

Install backflow unit per state and local codes. See plans for tap size. Contractor to coordinate with local authorities for approved back flow unit. Maximum pressure loss allowed through RPZ is 12psi.

Coordinate with local authorities for water meter installation procedure. Contractor is responsible for acquiring meter from owner and installing appropriate water meter to local codes. Enclosure shall be a GS-4 installed on an EP-4 ENCPAD.

Controller Enclosure

Install controller in enclosure GS-NP-1. Contractor is to verify that the enclosure will fit over the controller and pedestal and order the correct size. Install on concrete pad with a minimum dimension of 36" x 48"x 6".

Other Components.

Tools and Extra Equipment: The Contractor is to provide to the Owner, two (2) sets of tools to repair and work on all equipment specified in this irrigation section.

The Contractor is to provide the Owner with two (2) sprinkler heads of each type specified, (1) electric valve of each size used.

The Contractor shall provide to the Owner, one (1) 4' wrench for the gate valve.

Other Materials: Provide imported fill material as required to complete this work at the Contractor's cost. Provide other materials or equipment shown on the drawings or installation details, which are part of the irrigation system, although such items may not have been referenced in these specifications.

Construction.

Inspection and Reviews.

Site Inspections: The bidder acknowledges that he has examined the site, plans and specifications, and the submission of a proposal shall be considered evidence that examination has been made.

Verify construction site conditions and note irregularities affecting work of this section. It shall be the contracting installer's responsibility to report to the Owner's authorized representative any deviations between drawings, specifications and the site. Failure to do so before the installing of equipment and resulting in replacing and/or relocation of equipment shall be done at the Contractor's expense.

Examine final grades and installation conditions. Do not start irrigation system work until unsatisfactory conditions are corrected.

Beginning work of this section implies acceptance of existing conditions.

Utility Locations: The exact location of all existing utilities and structures and underground utilities are not indicated on the drawings; their locations shall be determined by the Contractor, and he shall conduct his work so as to prevent interruption of service or damage to them.

Arrange for and coordinate with local authorities the location of all underground utilities. Repair any underground utilities damaged during construction. Make repairs at no additional cost above the contract price.

The Contractor shall protect existing structures and utility services and be responsible for their replacement if damaged by him.

Excavation, Trenching and Backfilling.

Excavating shall be considered unclassified and shall include all materials encountered, except materials that cannot be excavated by normal mechanical means.

Excavate to permit the pipes to be laid at the intended elevations and to permit work space for installing connections and fittings.

Minimum cover (distance from top of pipe or control wire to finish grade):

12-inch over mainline pipe.

6-inch over control wire, follow local and state requirements if they dictate a deeper bury depth.

12-inch over lateral pipe to sprinklers with PE piping.

PVC mainlines or PVC, PE lateral pipes 2 1/2" and smaller may be pulled into the soil using a vibratory plow device specifically manufactured for pipe pulling, if in the opinion of the Engineer that conditions are suitable. Minimum burial depths equals minimum cover listed above provided soil moisture content and other conditions are suitable to allow for full depth of the right to determine suitability or conditions.

Backfill only after lines have been reviewed and tested.

Excavated material is generally satisfactory for backfill. Backfill shall be free from rubbish, vegetable matter, and stones larger than 2 inches in maximum dimension. Remove material not suitable for backfill. Backfill placed next to pipe shall be free of sharp objects, which may damage the pipe.

Backfill unsleeved pipe by depositing the backfill material equally on both sides of the pipe in 6-inch layers and compacting each layer to 95% Standard Proctor Density, ASTM D698-78. Use of water for compaction, "puddling," will not be permitted.

Enclose pipe and wiring beneath roadways, walks, curbs, etc., in sleeves. Minimum compaction of backfill for sleeves shall be 95% Standard Proctor Density. ASTM D698-78. Use of water for compaction around sleeve, "puddling," will not be permitted.

Dress backfilled areas to original grade. Incorporate excess backfill into existing site grades.

Where utilities conflict with irrigation trenching and pipe work, contact the Engineer for trench depth adjustments.

Provide approved fine grained earth fill or sand to point 4" above the top of pipe where soil conditions are rocky or otherwise objectionable.

Excavate trenches and install piping and backfill during the same working day. Do not leave open trenches or partially-filled trenches open overnight.

The Contractor will be responsible for all finish and fine grading of trenches, disturbed areas around sprinklers heads, electric valves and any other excavated or disturbed areas by the Contractor. Contractor will also be responsible for all trench settling throughout the project during the one-year warranty period. If settling occurs, the contractor will repair and bring back to originally set grade.

When additional backfill material is needed to replace the unsuitable materials, it will be the Contractor's responsibility and expense to supply such material. It will also be the Contractor's responsibility to dispose of the unsuitable material.

Assembling pipe and Fittings.

General: Keep pipe free from dirt and pipe scale. Cut pipe ends square and debur. Clean pipe ends. Keep ends of assembled pipe capped. Removed caps only when necessary to continue assembly.

All mainline and continuously pressurized pipe is to be installed using open trenches. Lateral pipe may be installed by "Plowing" if soil conditions permit, and soils do not contain gravel, rock, construction debris, or other potential damaging material.

Trenches may be curved to change direction or avoid obstructions within the limits of the curvature of the pipe.

Mainline and Fittings: Use only strap-type friction wrenches for threaded plastic pipe.

PVC Solvent Weld Pipe: Use a primer and solvent cement. Join pipe in a manner recommended by the manufacturer and in accordance with accepted industry practices.

Cure for 30 minutes before handling and 24 hours before allowing water in pipe. Snake pipe from side to side within the trench.

Fittings: The uses of cross type fittings are not permitted.

Lateral Pipe and Fittings: Use only strap-type friction wrenches for threaded plastic pipe.

PVC Pipe: Join pipe in the manner recommended by manufacturer and in accordance with accepted industry practice. Snake pipe from side to side within the trench.

Installation of Sprinkler and Irrigation Components.

Remote Control Valve (RCV) Assembly: Flush mainline before installation of RCV assembly.

Install where indicated on the drawing. Wire connectors and waterproof sealant shall be used to connect control wires to remote control valve wire. Install connectors and sealant per the manufacturer's recommendations.

Install only one RCV to a valve box. Locate valve box at least 12 inches from and align with nearby walls and edges of paved areas. Group RCV assemblies together where practical. Arrange grouped valve boxes in rectangular patterns. Allow at least 12 inches between valve boxes.

Adjust RCV to regulate the downstream operating pressure. Attach ID tag with controller station number to control wiring.

Sprinkler Assembly: Flush lateral pipe before installing sprinkler assembly. Install per the installation details at locations shown on the drawings.

Locate rotor sprinklers 6 inches from adjacent walls, fences or edges of paved areas. Locate spray sprinklers 3 inches from adjacent walls, fences or edges of paved areas. Install sprinklers perpendicular to the finish grade.

Supply appropriate nozzle or adjust arc of coverage of each sprinkler for best performance. Adjust the radius of throw of each sprinkler for best performance.

Installation of Control System Components.

Irrigation Controller Unit: The location of the controller unit as depicted on the drawings is approximate. The Engineer will determine the exact site location during sprinkler layout review.

Attach wire markers to the ends of control wires inside the controller unit housing. Label wires with the identification numbers (see drawings) of the remote control valve to which the control wire is connected. Connect control wires to the corresponding controller terminal.

Control Wire: For 24 v systems, bundle control wires where two or more are in the same trench. Bundle with pipe wrapping tape at 15-foot intervals.

Control wiring may be chiseled into the soil using a vibratory plow device specifically manufactured for pipe pulling and wire installation. Appropriate chisel must be used so that wire is fed into a chute on the chisel, and wire is not subject to pulling tension. Minimum burial depth must equal minimum cover previously listed.

Provide a 24-inch excess length of wire in an 8-inch diameter loop at each 90-degree change of direction, at both ends of sleeves and at 100-foot intervals along continuous runs of wiring. Do not tie wiring loop.

Coil 24-inch length of wire within each remote control valve box.

For 24 v systems, install common ground wire and one control wire for each remote control valve. Multiple valves on a single control wire are not permitted.

If a control wire must be spliced, make splice with wire connectors and waterproof sealant, installed per the manufacturer's instructions. Locate splice in a valve box that contains an irrigation valve assembly, or in a separate 10-inch round valve box.

Use same procedure for connection to valves as for in-line splices.

Protect wire not installed with PVC mainline pipe with a continuous run of warning tape placed in the backfill six inches above the wiring.

Installation of Other Components.

Tools and Spare Parts: Prior to the review at completion of construction, supply to the owner operating keys, servicing tools, spare parts, test equipment and any other items indicated in general notes on the drawings.

Other Materials: Install other materials or equipment shown on the drawings or installation details which are part of the irrigation system, even though such items may not have been referenced in these specifications.

Balancing and Adjusting.

The Contractor will be responsible for the balancing and adjustments of the various components of the system so the overall operation of the system is the most efficient. Including, but not limited to, the synchronization of the controllers, valves and sprinkler adjustments. Coordinate controller setup with the Engineer.

Requirements for Substantial Completion.

Cleaning Equipment and Premises: Thoroughly clean all parts of the piping, valves and equipment. Remove all construction debris, excess materials and equipment.

Operating and Maintenance Manuals: Contractor shall furnish to Owner, two operating manuals for furnished equipment. Information sheets shall be bound in standard three-ring binders labeled to show Contractor's name, address, regular business phone number, emergency phone number and date. Operating manuals shall be submitted prior to completion of work to allow time for review. Manual shall contain following information:

List (keyed with identification numbers used) each item of equipment which requires service, giving the name of the item, model number, manufacturer's name and address, and providing the name, address and phone number of the nearest representative of authorized service organization.

Cut sheets to be included for the following, but not limited to: electric valves, isolation valves, swing joints, valve boxes, controllers and sprinkler heads.

A copy of the shop drawing if changes in the design are required.

A complete operating and maintenance manual, parts list, wiring diagrams, lubrication requirements, and service instructions for each major item.

Complete control diagrams with description of all operation sequences and control devices.

Properly executed registrations and registered manufacturer's warranties.

After completion of work and when Owner has had sufficient time to examine operating manuals and become somewhat familiar with operation of equipment, a meeting will be arranged by the Contractor with the Owner for purpose of instructing Owner in proper maintenance of system and to answer

questions he/she may have regarding it's operation. Prior to this meeting, contractor shall have programmed a base program for all stations and run times.

It will be the responsibility of the Irrigation Contractor to provide a reliable communication system (i.e.: Two way radios or remote radio control activation system) for Substantial Completion, final acceptance and all periodic site visits. Once the controllers are operational, the contractor will be required to have a tablet devise on site to operate the system. This tablet is to be accessible to the designer for any walk troughs that are scheduled.

Acceptance

Instruct the Engineer and Owner's designated personnel in the operation of the system, including adjustment of sprinklers, controller(s), valves, pump controls and moisture sensing controls, etc.... Once contractor has trained the Engineer and Owner, the system is fully operational and has completed the punch list, the project will be accepted. A written acceptance and date will be provided, which will begin the warranty and maintenance periods.

Hydrostatic Testing.

Notify the Engineer three days in advance of testing.

Pipelines jointed with rubber gaskets or threaded connections may be subjected to a pressure test at any time after partial completion of backfill. Pipelines jointed with solvent-welded PVC joints shall be allowed to cure at least 24 hours before testing.

Subsections of mainline pipe may be tested independently, subject to the review of the Engineer.

Furnish clean, clear water, pumps, labor, fittings, and equipment necessary to conduct test or retests.

Cap riser of mainline components for volumetric pressure tests. Backfill to prevent pipe from moving under pressure. Expose coupling and fitting. Purge all air from the pipeline before test.

Subject mainline pipe to the anticipated operating pressure for two hours. Maintain constant pressure. Test complete system under full line pressure. Pressure must be maintained with less than 2lbs loss in the system for 4 hours. If the system does not hold pressure, repair leaks and retest system until the system maintains pressure.

All necessary testing equipment shall be furnished by the Contractor. Cement or caulking to seal leaks is prohibited.

Activate each remote control valve in sequence from controller. Replace defective remote control valve, solenoid, wiring, or appurtenance to correct operational deficiencies.

Replace, adjust, or move water emission devices to correct operational or coverage deficiencies.

Repeat test(s) until each lateral passes all tests. Repeat tests, replace components, and correct deficiencies at no additional cost to the owner.

Guarantee / warranty and Replacement.

It shall be the Contractor's responsibility to ensure and guarantee satisfactory operation of the entire system and the workmanship and restoration of the area. The entire system shall be guaranteed to be complete and perfect in every detail on the date it's accepted.

Minor maintenance and adjustment shall be by the Owner.

Make repairs within seven (7) days of notification from the Engineer.

Contract documents govern replacements identically as with new work. Make replacements at no additional cost to the contract price.

Guarantee/warranty applies to originally installed materials, equipment, and replacements made during the guarantee/warranty period.

Demonstration, Winterization and Spring Start-up.

Coordinate the winterization and start-up with the Engineer and Owner's landscape maintenance personal.

Contractor shall winterize the system the first year as part of this contract, and will provide written instructions to the Owner for future service and maintenance.

Return to the site within ten (10) days of spring start-up and demonstrate to the Owner the proper procedures for the system start-up, operation and proper maintenance. Repair any damage caused in improper winterization at no additional cost to the owner.

After completion, testing and acceptance of the system, the Contractor will instruct the Engineer and Owner's personnel in the operation and maintenance of the system.

Measurement. The contract unit price for irrigation system shall be measured per complete system installed and tested.

Basis of Payment. This work shall be paid for at the contract unit price per lump sum for IRRIGATION SYSTEM SPECIAL including all labor, material, equipment, and services necessary for providing the landscape irrigation systems in a serviceable, fully operational manner, including, but not limited to, excavation, backfilling, sprinkler heads, solenoid control valves, isolation valves, valve boxes, automatic controls, system testing, owner personnel training, piping, equipment identification, plumbing permits, inspection fees, valve tags, charts, supports, sleeves, fittings, valves, and accessories.

PORTLAND CEMENT CONCRETE SIDEWALK 5 INCH, SPECIAL, AND PORTLAND CEMENT CONCRETE SIDEWALK 8 INCH, SPECIAL

Description. This work shall consist of subgrade preparation, formwork, reinforcement, finishing, and cleanup necessary for construction of Portland Cement Concrete sidewalk in accordance with Section 424 of the Standard Specifications, as described herein, and as depicted on the plan and detail sheets.

Construction. Construct Portland Cement Concrete Sidewalk in accordance with the Standard Specifications. Refer to layout plans and details for specific construction configurations and accessories.

Work shall include subgrade preparation and all reinforcement, accessories, and finishing as shown on the plans and details.

Measurement. The contract unit price for Portland Cement Concrete Sidewalk 5 Inch and Portland Cement Concrete Sidewalk 8 Inch shall include all subgrade preparation, formwork, reinforcement, accessories, finishing, cleanup, and all other materials, labor, and equipment required to complete this work.

Earth excavation and aggregate base course material as necessary to establish the specified grades will be measured for payment separately in accordance with these special provisions and Sections 202 and 351 of the Standard Specifications.

Basis of Payment. This work shall be paid for at the contract unit price per square foot for PORTLAND CEMENT CONCRETE SIDEWALK 5 INCH, SPECIAL and PORTLAND CEMENT CONCRETE SIDEWALK 8 INCH, SPECIAL and no additional compensation will be allowed.

Earth excavation and aggregate base course material will be paid for separately at the contract unit prices for EARTH EXCAVATION and AGGREGATE BASE COURSE, TYPE B and no additional compensation will be allowed.

PRE-CONSTRUCTION VIDEO TAPING

Description: The Contractor shall prepare pre-construction video documentation of all features in the areas affected by construction. All video cameras, recorders, tapes, accessories and appurtenances shall be high quality DVD format equipment. Pre-construction video documentation shall consist of a series of high resolution color audio-video tapes showing all areas affected by construction. All pertinent features within the construction's zone of influence shall be shown in sufficient detail to document its pre-construction condition. Features to be shown shall include, but not be limited to, pavements, landscaping, light posts, and equipment, etc. View orientation shall be maintained by audio commentary on the audio track of each DVD to help explain what is being viewed. The pre-construction video taping shall be completed and copies of the DVD's submitted to the Engineer before commencing with any construction activities.

Basis of Payment: This work will be paid for at the contract lump sum price for PRE-CONSTRUCTION VIDEO TAPING.

EXPLORATORY EXCAVATION

This work shall be performed in accordance with Section 213 of the Standard Specifications with the following alterations.

213.01 Description. Delete the entire paragraph and replace with "This work shall consist of constructing a trench or excavation for the purpose of locating existing underground facilities within the limits of the proposed improvement."

213.02 General. Delete sentence one from paragraph two and replace with the following "The trench or excavation shall be of sufficient depth to locate farm drains or other underground facilities. The trench shall be excavated deep enough to allow proper investigation of the entire excavation but not more than one foot deeper than the proposed pipe or structure". Delete sentence one of paragraph four and replace with the following: "After inspection by the Engineer, the exploration trench shall be backfilled with CA-6 and compacted. Prior to commencing with the work, the Contractor and Engineer shall agree on the excavator bucket size to be used for the work."

213.04 Basis of Payment. Delete paragraph one and two and replace with the following; "This work will be paid for at the contract unit price per foot for EXPLORATORY EXCAVATION, which price shall include all labor, equipment and materials to complete the work as specified herein. The cost of compacted backfill will not be measured separately for payment, but shall be included in the pay item for EXPLORATORY EXCAVATION."

WATER SERVICE CONNECTIONS

Description. This work shall consist of constructing water service connections of the specified size as per the detail and at locations shown on the plans and as directed by the Engineer. Included in this item is the excavation, directional boring for services, water service line, tapping, saddles, corporation stops, curb stops, domestic water service boxes, pipe fittings, joint materials, trench backfill, and all necessary and collateral work required to complete the work as specified herein.

Water service line shall be copper, Type K, soft temper for underground service, unless otherwise specified, conforming to the requirements of ASTM Standards B88 and B251. The pipe shall be marked with the manufacturer's name or trade mark and a mark indicative of the type of pipe. The outside diameter of the pipe shall conform to ASTM Standard B251, Table 2.

Trench backfill shall be selected granular backfill conforming to the requirements of these Special Provisions.

Corporation stops and curb stops shall be fabricated of brass and provided with outlets suitable for copper connection in accordance with the requirements of AWWA Standard C-800. Curb stops shall be of the round-way type. Fittings for water service lines shall be copper and of the compression type. Domestic water service boxes shall be cast iron, screw-type, with the base set over the curb stop and of such construction that it can be extended in length to fit the particular location with 18" of adjustment left. The cover of the domestic water service box shall be marked "WATER".

Water service connections shall be installed in accordance with the requirements of Sections 41-2.12 and 41-2.13 of the Standard Specifications for Water and Sewer Construction in Illinois and the details included in the plans. The proposed water main shall be tapped at an angle of 45 degrees with the vertical, and the stop turned so that the T-handle is on top. The water service line shall extend horizontally at right angles with the water main to the proposed curb stop at the R.O.W. The copper tubing shall be one continuous length (no coupling of the new copper tubing will be allowed) laid in the trench sufficiently weaving to allow not less than one (1) foot of extra length between the corporation and curb stops. A new domestic water service box shall be set over the proposed curb stop at the location shown on the plans or as directed by the Engineer. The new copper water service line shall be flushed to remove all debris before it is coupled to the existing service line approximately eighteen inches (18") beyond the

round-way type. Fittings for water service lines shall be copper and of the compression type. Domestic water service boxes shall be cast iron, screw-type, with the base set over the curb stop and of such construction that it can be extended in length to fit the particular location with 18" of adjustment left. The cover of the domestic water service box shall be marked "WATER".

Water service connections shall be installed in accordance with the requirements of Sections 41-2.12 and 41-2.13 of the Standard Specifications for Water and Sewer Construction in Illinois and the details included in the plans. The proposed water main shall be tapped at an angle of 45 degrees with the vertical, and the stop turned so that the T-handle is on top. The water service line shall extend horizontally at right angles with the water main to the proposed curb stop at the R.O.W. The copper tubing shall be one continuous length (no coupling of the new copper tubing will be allowed) laid in the trench sufficiently weaving to allow not less than one (1) foot of extra length between the corporation and curb stops. A new domestic water service box shall be set over the proposed curb stop at the location shown on the plans or as directed by the Engineer. The new copper water service line shall be flushed to remove all debris before it is coupled to the existing service line approximately eighteen inches (18") beyond the new curb stop. Existing curb stops and water service boxes shall be removed and legally disposed off-site after the new water service connection is completed.

Construction Requirements. Closing of the existing valves to isolate the connections, if required, shall be coordinated by the Contractor and performed by the Village. To reduce the inconvenience to the public, the Contractor shall procure all material for the connection in advance and perform as much preparation work as possible prior to requesting a shutdown of the existing water main section.

Basis of Payment. This work will be paid for at the contract unit price per each WATER SERVICE CONNECTION, of the diameter specified, which price shall include the cost of all excavation, copper water line, directional boring, tapping, saddles, corporation stops, curb stops, domestic water service boxes, pipe fittings, joint materials, trench backfill, backfilling and removal and disposal of all materials.

PAVEMENT REMOVAL

Description. This work shall consist of the removal of existing pavement in accordance with Section 440 of the Standard Specifications, as described herein, and as depicted on the plan and detail sheets.

Measurement. The contract unit price for Pavement Removal shall include all saw cutting and all other materials, labor, and equipment required to complete this work.

Basis of Payment. This work shall be paid for at the contract unit price per square yard for PAVEMENT REMOVAL.

UNDERDRAIN CONNECTION TO STRUCTURE

Description. This work shall consist of connecting the proposed under drains to the existing storm structures in accordance with Section 602.13 of the Standard Specifications, as described herein, and as depicted on the plans.

Construction Requirements. The contractor will be required to core the existing structure for the connection.

Basis of Payment. This work shall be paid for at the contract unit price per each for UNDERDRAIN CONNECTION TO STRUCTURE.

LUMINAIRE SPECIAL

Description. This work shall consist of the material, labor, testing and equipment necessary to furnish and install the Village of Oak Brook Standard decorative roadway luminaire as indicated on the plans, according to the type specified. The luminaires shall be installed on existing or proposed light standards complete with wire, fuses, fuseholders, ground connection and splice connections to make ready for use and in accordance with the plan details and the following requirements. This work shall be performed according to applicable sections of Division 800 of the State Specifications.

Materials: The luminaires shall be as specified herein, as detailed in the Plans, and Oak Brook Lighting Standards.

Model Type: Lumec Transit Series
Wattage: High Pressure Sodium, 400 Watt
Ballast: 240V/120V Multi-tap

Construction Requirements. The contractor will be required to furnish and install luminaires, pole wiring, and any other appurtenances required per the Plans and Appendix A (Oak Brook Lighting Standards). Upon completion of the initial installation an evaluation of the light distribution shall be performed at each signalized intersection to determine proper light distribution. The contractor shall make the appropriate adjustments, as needed to obtain necessary light levels.

Basis of Payment. This work shall be paid for at the contract unit price per each for LUMINAIRE, SPECIAL, which price will be payment in full for furnishing luminaires, lamps, electric cable within the pole, fuse holder and fuse, electrical connections and splices, stainless steel mounting hardware and all other materials and incidentals required, specified, or shown on the plans.

LIGHT POLE SPECIAL

Description. This work shall consist of the material, equipment and labor required to furnish and install the Village of Oak Brook Standard decorative light poles, of the size and type specified with or without banner arms. The light poles shall be furnished with datum, festoon receptacles and banner arm receivers. Banner poles shall be furnished and installed at the locations indicated on the plans. This work shall be performed according to applicable sections of Division 800 of the State Specifications.

Materials: The light pole shall be listed or classified such as UL, ETL, or approved equivalent testing laboratory for the specified use. The pole shall be rated for a minimum wind loading of 90 mph fully assembled complete with specified accessories.

Manufacturer: Valmont
Pole Type: Aluminum, 10-inch diameter to 6-inch diameter taper, minimum 0.25 inch wall thickness.
Breakaway Transformer Base: Aluminum
Datum Arm: Aluminum, Ornamental per plan detail

Festoon Outlets: 15A GFI receptacle with Single-Gang, Vertical GFI aluminum cover
Specified Accessories: 24-inch long banner arms
Finish: Powder coated, Black

Construction Requirements. The contractor will be required to furnish and install pole, mast arm, pole wiring, and any other appurtenances required per the Plans and Appendix A (Oak Brook Lighting Standards). The pole shall be vertically plumb.

Basis of Payment. This work shall be paid for at the contract unit price per each for LIGHT POLE, SPECIAL, with or without BANNER ARMS which price will be payment in full for furnish the poles, transformer base, anchor bolts, GFI receptacles, covers, wiring, fuses, fuseholders, grounding and all other materials and incidentals required, specified, or shown on the plans, and furnishing all labor, tools, and equipment necessary for the assembly of all equipment, wired, erected, and otherwise complete and in operation.

HOLIDAY SUB LIGHTING PANEL ASSEMBLY

Description. This item shall consist of the equipment, material and labor necessary to furnish and install an aluminum enclosure, electrical control equipment, grounding material, anchoring hardware , and concrete foundation a shown on the plans and at the locations shown on the plans for as designated by the Engineer in the field. All work shall be done in accordance with Sections 801 and Section 825 of the IDOT Standard Specifications and the details shown on the Plans.

The contractor shall submit for review catalog cut information for the proposed electronic components, enclosure and hardware specified on the plans and according to the specifications for the item. The lighting panel assembly shall be UL listed for 508A designation. The cabinet shall have a NEMA 3R rating fabricated from 0.125 inch type 5052-H32 aluminum. All external hardware shall be made of stainless steel. The enclosure shall be finished with powder coating paint according to the color approved by the Village based upon color samples.

This work shall include the material, labor and equipment necessary to connect the existing lighting controller cabinet's available breaker. All modifications required to the existing cabinet in order to connect the proposed lighting panel is incidental to this work.

Basis of Payment. This work shall be paid for at the contract unit price per each for HOLIDAY SUB LIGHTING PANEL ASSEMBLY, which price will be payment in full for furnish the enclosure, electrical components, wiring, connections, grounding, conduit, concrete foundation and all other required materials and furnish all labor, tools, and equipment necessary for the assembly of all equipment, wired, erected, to otherwise complete, test and fully operate this item.

REMOVAL AND DISPOSAL OF REGULATED SUBSTANCES

This work shall be according to Article 669 of the Standard Specifications and the following:

Qualifications. The term environmental firm shall mean an environmental firm with at least five (5) documented leaking underground storage tank (LUST) cleanups or that is pre-qualified in hazardous waste by the Department. Documentation includes but not limited to verifying remediation and special waste operations for sites contaminated with gasoline, diesel, or waste oil in accordance with all Federal, State, or local regulatory requirements and shall be provided to the Engineer for approval. The environmental firm selected shall not be a former or current consultant or have any ties with any of the properties contained within and/or adjacent to this construction project.

General. This Special Provision will likely require the Contractor to subcontract for the execution of certain activities.

All contaminated materials shall be managed as either "uncontaminated soil" or non-special waste. This work shall include monitoring and potential sampling, analytical testing, and management of a material contaminated by regulated substances. The Environmental Firm shall continuously monitor all soil excavation for worker protection and soil contamination. Phase I Preliminary Engineering information is available through the District's Environmental Studies Unit. Soil samples or analysis without the approval of the Engineer will be at no additional cost to the Department. The lateral distance is measured from centerline and the farthest distance is the offset distance or construction limit whichever is less.

The Contractor shall manage any excavated soils and sediment within the following areas:

Site 3018-9 (Oak Brook Sports Core)

- Station 2139+40 to Station 2142+25 (CL 22nd Street), 0 to 85 feet RT (Oak Brook Sports Core, PESA Site 3018-9, 2606 York Road and 600-800 Block Oak Brook Road, Oak Brook). This material meets the criteria of Article 669.09(b)(1) and shall be managed in accordance to Article 669.09. Contaminants of concern sampling parameters: Manganese.
- Station 2142+25 to Station 2144+05 (CL 22nd Street), 0 to 85 feet RT (Oak Brook Sports Core, PESA Site 3018-9, 2606 York Road and 600-800 Block Oak Brook Road, Oak Brook). This material meets the criteria of Article 669.09(a)(2) and shall be managed in accordance to Article 669.09. Contaminants of concern sampling parameters: Manganese.
- Station 2144+05 to Station 2145+95 (CL 22nd Street), 0 to 85 feet RT (Oak Brook Sports Core, PESA Site 3018-9, 2606 York Road and 600-800 Block Oak Brook Road, Oak Brook). This material meets the criteria of Article 669.09(a)(3) and shall be managed in accordance to Article 669.09. Contaminants of concern sampling parameters: Benzo(a)pyrene, and Manganese.
- Station 2145+95 to Station 2147+80 (CL 22nd Street), 0 to 85 feet RT (Oak Brook Sports Core, PESA Site 3018-9, 2606 York Road and 600-800 Block Oak Brook Road, Oak Brook). This material meets the criteria of Article 669.09(a)(3) and shall be managed in accordance to Article 669.09. Contaminants of concern sampling parameters: Arsenic.
- Station 2147+80 to Station 2151+50 (CL 22nd Street), 0 to 85 feet RT (Oak Brook Sports Core, PESA Site 3018-9, 2606 York Road and 600-800 Block Oak Brook Road, Oak Brook). This material meets the criteria of Article 669.09(a)(5) and shall be managed in accordance to Article 669.09. Contaminants of concern sampling parameters: Benzo(a)anthracene, Benzo(a)pyrene, Benzo(b)fluoranthene, Dibenzo(a,h)anthracene, Indeno(1,2,3-cd)pyrene, and Manganese.

- Station 2153+30 to Station 2155+05 (CL 22nd Street), 0 to 80 feet RT (Oak Brook Sports Core, PESA Site 3018-9, 2606 York Road and 600-800 Block Oak Brook Road, Oak Brook). This material meets the criteria of Article 669.09(a)(4) and shall be managed in accordance to Article 669.09. Contaminants of concern sampling parameters: Benzo(a)anthracene, Benzo(a)pyrene, Benzo(b)fluoranthene, Dibenzo(a,h)anthracene, and Manganese.
- Station 2155+05 to Station 2156+25 (CL 22nd Street), 0 to 80 feet RT (Oak Brook Sports Core, PESA Site 3018-9, 2606 York Road and 600-800 Block Oak Brook Road, Oak Brook). This material meets the criteria of Article 669.09(a)(5) and shall be managed in accordance to Article 669.09. Contaminants of concern sampling parameters: Benzo(a)pyrene, Mercury, and Manganese.
- Station 2156+25 to Station 2157+70 (CL 22nd Street), 0 to 160 feet RT (Oak Brook Sports Core, PESA Site 3018-9, 2606 York Road and 600-800 Block Oak Brook Road, Oak Brook). This material meets the criteria of Article 669.09(a)(5) and shall be managed in accordance to Article 669.09. Contaminants of concern sampling parameters: Benzo(a)pyrene, Mercury, and Manganese.

Site 3018-13 (Vacant Lot)

- Station 2139+50 to Station 2142+25 (CL 22nd Street), 0 to 90 feet LT (Vacant Lot, PESA Site 3018-13, 615 West 22nd Street, Oak Brook). This material meets the criteria of Article 669.09(a)(2) and shall be managed in accordance to Article 669.09. Contaminants of concern sampling parameters: Manganese.

Site 3018-12 (Office Building)

- Station 2142+25 to Station 2145+95 (CL 22nd Street), 0 to 110 feet LT (Office Building, PESA Site 3018-12, 600 West 22nd Street, Oak Brook). This material meets the criteria of Article 669.09(a)(3) and shall be managed in accordance to Article 669.09. Contaminants of concern sampling parameters: Benzo(a)pyrene, and Manganese.

Site 3018-10 (Charles Schwab)

- Station 2145+95 to Station 2147+80 (CL 22nd Street), 0 to 110 feet LT (Charles Schwab, PESA Site 3018-10, 500 West 22nd Street, Oak Brook). This material meets the criteria of Article 669.09(a)(5) and shall be managed in accordance to Article 669.09. Contaminants of concern sampling parameters: Arsenic.
- Station 2147+80 to Station 2149+65 (CL 22nd Street), 0 to 80 feet LT (Charles Schwab, PESA Site 3018-10, 500 West 22nd Street, Oak Brook). This material meets the criteria of Article 669.09(a)(4) and shall be managed in accordance to Article 669.09. Contaminants of concern sampling parameters: Benzo(a)anthracene, Benzo(a)pyrene, Benzo(b)fluoranthene, Dibenzo(a,h)anthracene, and Manganese.

Site 3018-8 (Office Building)

- Station 2149+65 to Station 2151+50 (CL 22nd Street), 0 to 80 feet LT (Office Building, PESA Site 3018-8, 2122 York Road, Oak Brook). This material meets the criteria of Article 669.09(a)(2) and shall be managed in accordance to Article 669.09. Contaminants of concern sampling parameters: Manganese.
- Station 2151+50 to Station 2153+30 (CL 22nd Street), 0 to 80 feet LT (Office Building, PESA Site 3018-8, 2122 York Road, Oak Brook). This material meets the criteria of Article 669.09(a)(1) and shall be managed in accordance to Article 669.09. Contaminants of concern sampling parameters: Manganese.
- Station 2153+30 to Station 2156+60 (CL 22nd Street), 0 to 110 feet LT (Office Building, PESA Site 3018-8, 2122 York Road, Oak Brook). This material meets the criteria of Article 669.09(a)(2) and shall be managed in accordance to Article 669.09. Contaminants of concern sampling parameters: Lead, and Manganese.

- Station 2156+60 to Station 2157+70 (CL 22nd Street), 0 to 160 feet LT (Office Building, PESA Site 3018-8, 2122 York Road, Oak Brook). This material meets the criteria of Article 669.09(a)(3) and shall be managed in accordance to Article 669.09. Contaminants of concern sampling parameters: Benzo(a)pyrene, and Manganese.

Site 3018-7 (Drake Oak Brook Office Plaza)

- Station 2157+70 to Station 2158+60 (CL 22nd Street), 0 to 160 feet RT (Drake Oak Brook Office Plaza, PESA Site 3018-7, 2211-2215 York Road, Oak Brook). This material meets the criteria of Article 669.09(a)(3) and shall be managed in accordance to Article 669.09. Contaminants of concern sampling parameters: Benzo(a)pyrene, Lead, and Manganese.
- Station 2158+60 to Station 2159+05 (CL 22nd Street), 80 to 120 feet RT (Drake Oak Brook Office Plaza, PESA Site 3018-7, 2211-2215 York Road, Oak Brook). This material meets the criteria of Article 669.09(a)(3) and shall be managed in accordance to Article 669.09. Contaminants of concern sampling parameters: Benzo(a)pyrene, Lead, and Manganese.
- Station 2158+60 to Station 2160+55 (CL 22nd Street), 0 to 80 feet RT (Drake Oak Brook Office Plaza, PESA Site 3018-7, 2211-2215 York Road, Oak Brook). This material meets the criteria of Article 669.09(a)(5) and shall be managed in accordance to Article 669.09. Contaminants of concern sampling parameters: Benzo(a)pyrene, Lead, and Manganese.
- Station 2160+55 to Station 2164+35 (CL 22nd Street), 0 to 80 feet RT (Drake Oak Brook Office Plaza, PESA Site 3018-7, 2211-2215 York Road, Oak Brook). This material meets the criteria of Article 669.09(a)(2) and shall be managed in accordance to Article 669.09. Contaminants of concern sampling parameters: Lead, and Manganese.

Site 3018-6 (The International Lions Club)

- Station 2157+70 to Station 2164+35 (CL 22nd Street), 0 to 160 feet LT (The International Lions Club, PESA Site 3018-6, 300 West 22nd Street, Oak Brook). This material meets the criteria of Article 669.09(a)(2) and shall be managed in accordance to Article 669.09. Contaminants of concern sampling parameters: Lead, and Manganese.
- Station 2164+35 to Station 2165+90 (CL 22nd Street), 0 to 125 feet LT (The International Lions Club, PESA Site 3018-6, 300 West 22nd Street, Oak Brook). This material meets the criteria of Article 669.09(a)(3) and shall be managed in accordance to Article 669.09. Contaminants of concern sampling parameters: Benzo(a)pyrene, and Manganese.

Site 3018-5 (Windsor Office Plaza)

- Station 2165+90 to Station 2167+45 (CL 22nd Street), 0 to 125 feet LT (Windsor Office Plaza, PESA Site 3018-5, 210 West 22nd Street, Oak Brook). This material meets the criteria of Article 669.09(a)(5) and shall be managed in accordance to Article 669.09. Contaminants of concern sampling parameters: Mercury, Lead, and Manganese.
- Station 2167+45 to Station 2170+95 (CL 22nd Street), 0 to 80 feet LT (Windsor Office Plaza, PESA Site 3018-5, 210 West 22nd Street, Oak Brook). This material meets the criteria of Article 669.09(a)(2) and shall be managed in accordance to Article 669.09. Contaminants of concern sampling parameters: Manganese.

Site 3018-4 (Westex by Miliken)

- Station 2170+95 to Station 2172+70 (CL 22nd Street), 0 to 80 feet LT (Westex by Miliken, PESA Site 3018-4, 122 West 22nd Street, Oak Brook). This material meets the criteria of Article 669.09(a)(3) and shall be managed in accordance to Article 669.09. Contaminants of concern sampling parameters: Benzo(a)pyrene, Lead, and Manganese.

Site 3018-3 (Residences)

- Station 2164+35 to Station 2165+90 (CL 22nd Street), 0 to 70 feet RT (Residences, PESA Site 3018-3, 31-43 Croydon Lane and 69 Windsor Drive, Oak Brook). This material meets

the criteria of Article 669.09(a)(3) and shall be managed in accordance to Article 669.09. Contaminants of concern sampling parameters: Benzo(a)pyrene, and Manganese.

- Station 2165+90 to Station 2167+45 (CL 22nd Street), 0 to 70 feet RT (Residences, PESA Site 3018-3, 31-43 Croydon Lane and 69 Windsor Drive, Oak Brook). This material meets the criteria of Article 669.09(a)(1) and shall be managed in accordance to Article 669.09. Contaminants of concern sampling parameters: Benzo(a)pyrene, Arsenic and Manganese.
- Station 2167+45 to Station 2172+70 (CL 22nd Street), 0 to 70 feet RT (Residences, PESA Site 3018-3, 31-43 Croydon Lane and 69 Windsor Drive, Oak Brook). This material meets the criteria of Article 669.09(a)(2) and shall be managed in accordance to Article 669.09. Contaminants of concern sampling parameters: Manganese.
- Station 2172+70 to Station 2174+50 (CL 22nd Street), 0 to 110 feet RT (Residences, PESA Site 3018-3, 31-43 Croydon Lane and 69 Windsor Drive, Oak Brook). This material meets the criteria of Article 669.09(a)(5) and shall be managed in accordance to Article 669.09. Contaminants of concern sampling parameters: Arsenic, and Manganese.
- Station 2174+50 to Station 2177+00 (CL 22nd Street), 0 to 110 feet RT (Residences, PESA Site 3018-3, 31-43 Croydon Lane and 69 Windsor Drive, Oak Brook). This material meets the criteria of Article 669.09(a)(2) and shall be managed in accordance to Article 669.09. Contaminants of concern sampling parameters: Manganese.

Site 3018-2 (Office Building)

- Station 2172+70 to Station 2174+50 (CL 22nd Street), 0 to 115 feet LT (Office Building, PESA Site 3018-2, 120 West 22nd Street, Oak Brook). This material meets the criteria of Article 669.09(a)(1) and shall be managed in accordance to Article 669.09. Contaminants of concern sampling parameters: Lead, and Manganese.
- Station 2174+50 to Station 2177+00 (CL 22nd Street), 0 to 115 feet LT (Office Building, PESA Site 3018-2, 120 West 22nd Street, Oak Brook). This material meets the criteria of Article 669.09(a)(5) and shall be managed in accordance to Article 669.09. Contaminants of concern sampling parameters: Benzo(a)pyrene, Mercury, and Manganese.

Appendix A

**Village of Oak Brook
Lighting Standards**

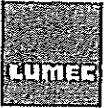

640, Curé-Boivin
 Boisbriand (Québec)
 Canada, J7G 2A7

Presentation

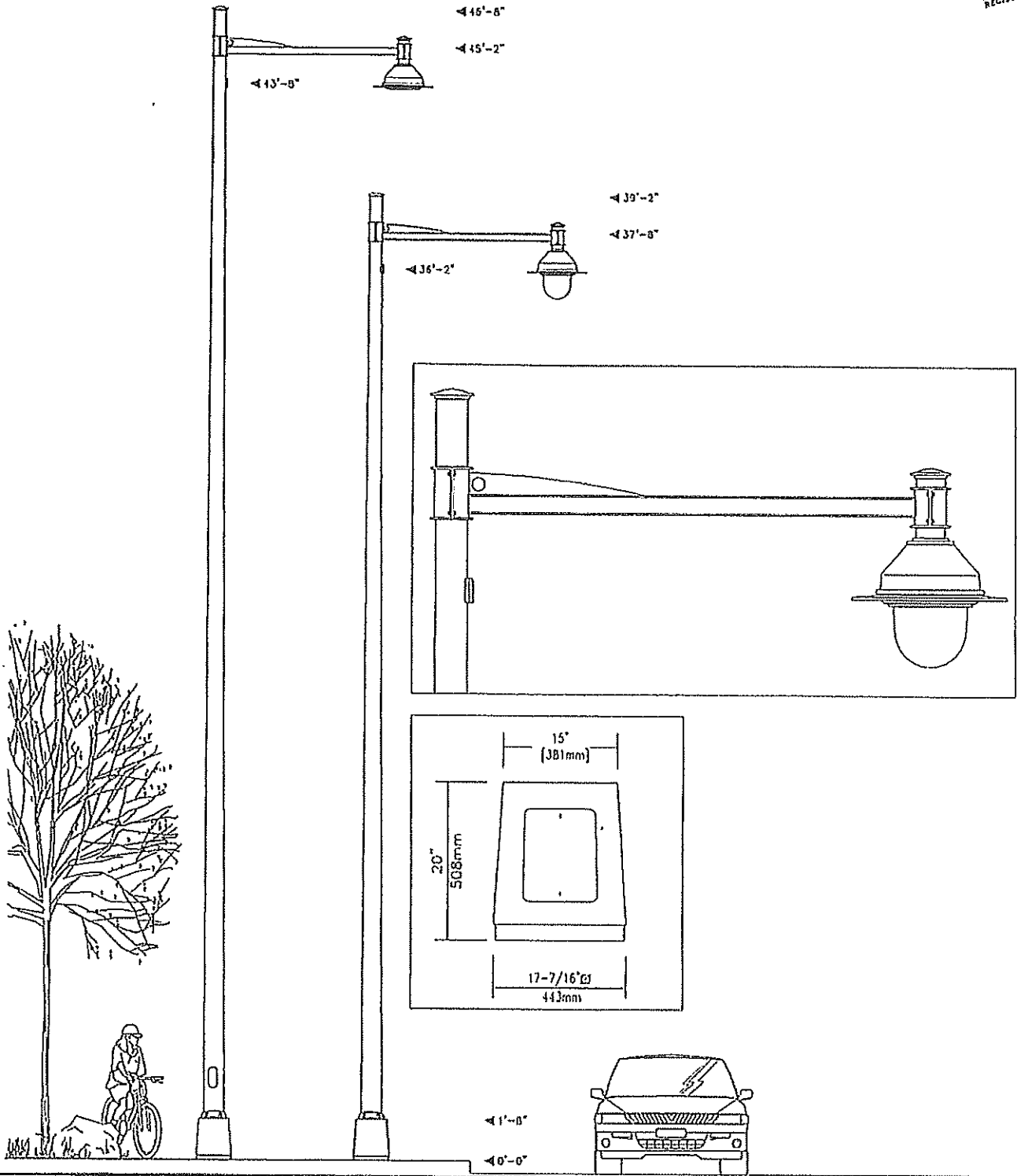
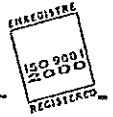

Oak Brook Village of (51867)
 TR20-250HPS-SHA3M-PC-QTA/120-UN-1A-ATR106V-37.5-BA-GFI-1 1/4X48-14 1/2-DEC-BT-COLTX-LMS50089A
 TR20-400HPS-SG3-QTA/120-UN-1A-ATR106V-45-BA-GFI-1 1/4X48-14 1/2-SEC-BT-COLTX-LMS50089B

TR20-TA-50089A0-51867-CC 29071019_115329.DOC

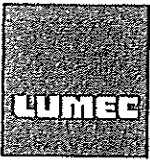

640, Curé-Boivin
Bolsbriand (Québec)
Canada, J7G 2A7

Oak Brook Village of (51867)

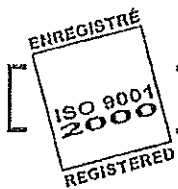
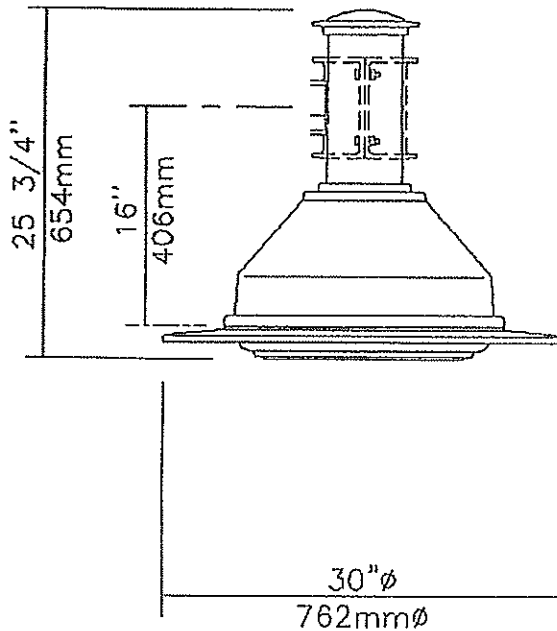

Qty 20 Luminaire TR20-400HPS-SG3-QTA/120-COLTX-LMS50089B

Description of Components:

Hood: Cast 356 aluminum dome, mechanically assembled on the luminaire.

Skirt: Spun 1100-0 aluminum, mechanically assembled on the luminaire.

Lamp: (not included), 400 Watt High Pressure Sodium (ANSI Code S51), ED 18 bulb, mogul base.

Optical System: (SG3), I.E.S. type III (asymmetrical). Reflector composed of a chemically brightened multi-faceted anodized aluminum, mounted on a white frame. This assembly allows for a full rotation of the optical system in 90 degree increments.

Ballast: High power factor of 90%. Primary voltage 120/208/240/277 volts, connected to 120 volts. Lamp starting capacity -40F(-40C) degrees. Assembled on a unitized removable tray with quick disconnect plug.

REMOTE BALLAST: Located inside transition base.

Access-Mechanism: A die cast A360 aluminum technical ring with latch and hinge. The mechanism shall offer toolfree access to the inside of the luminaire. An embedded memory-retentive gasket shall ensure weatherproofing.

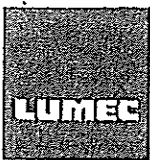

Oak Brook Village of (51867)

640, Curé-Boivin
Bolsbriand (Québec)
Canada, J7G 2A7

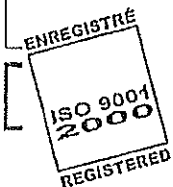
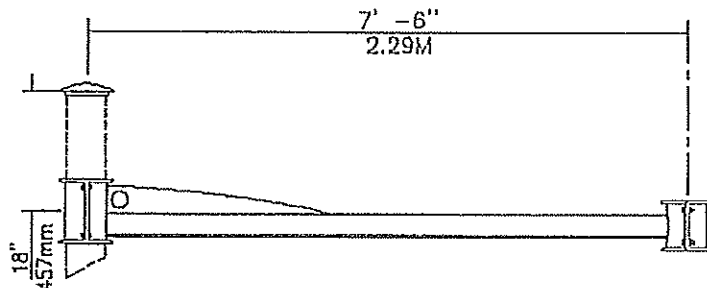
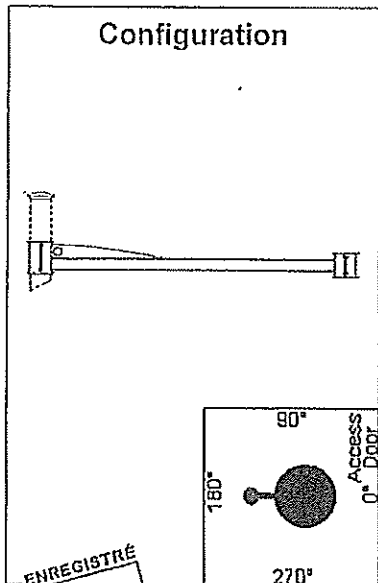

Qty	20	Bracket	UN-1A-COLT-X-LMS50089B
-----	----	---------	------------------------

Description of Components:

Arm: Shall be made from extruded aluminum 6063-T4, welded.

Adaptor: Clamps made of cast 356 aluminum, mechanically fastened on the pole by stainless steel bolts and nuts. Clamps are for a 6" (152mm) outside diameter pole shaft.

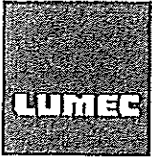

640, Curé-Bolvin
Boisbriand (Québec)
Canada, J7G 2A7

Oak Brook Village of (51867)

Base & Bolts Information

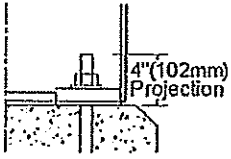

4" (102mm) Projection

Comes with 4 steel anchor bolts, 1 1/4" X 44" + 4", 4 nuts and 4 washers. Important: Do not obstruct space between anchor plate and concrete base.

Anchor Plate Free opening

Transition Base Details

- Material: Cast Aluminum
- NOTE: Bolt Circle Allowed: 15" to 17 1/4" 381mm to 438mm

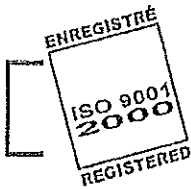
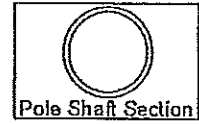

Qty	20	Pole	ATR106V-45-BAS24(2)-GFI-COLTX-LMS50089B
-----	----	------	---

Description of Components:

Pole Shaft: Shall be made from spun aluminum 6063-T4, tempered to T6 after welding, having a base diameter of 10" (254mm) and top diameter of 6" (152mm) wall thickness 0.250" (6.4mm) welded to both the bottom and top of the anchor plate. Complete with a 24" long straight section at the top

Transition Base: Cast Aluminum base complete with a hinged door.

Maintenance Opening: The pole shall have a 4" x 8" (102mm x 203mm) maintenance opening centered 20" (508mm) from the bottom of the anchor plate, complete with a weatherproof cast 356 aluminum cover and a copper ground lug.

Nut cover: Made from spun aluminum.

Pole Options: (BA) Single, upper and lower arms (2), fixed standard type, made of steel tubing, 1 1/16" (27mm) outside diameter, mechanically assembled to the pole, complete with a standard cast aluminum decorative ball.
(GFI) Duplex receptacle, 120 volts, ground fault interruptor, complete with a weatherproof aluminum cover. 15 amp.

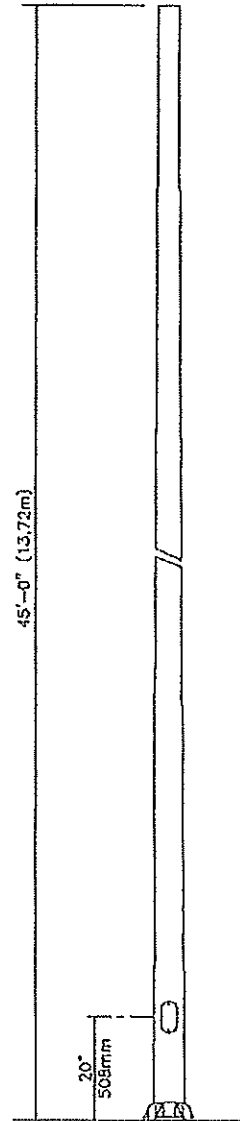

55

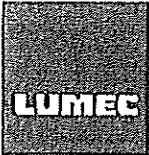

Oak Brook Village of (51867)

640, Curé-Boivin
Boisbriand (Québec)
Canada, J7G 2A7

Qty	20	Miscellaneous BT-COLTX-LMS50089B
-----	----	----------------------------------

Description of Components:

Wiring: Gauge (#14) TEW wires, 6" (152mm) minimum exceeding top of pole.

Hardware: All exposed screws will be in stainless steel. All seals and sealing devices are made and/or lined with EPDM and/or silicone.

Finish: Textured color to be advised (Standard Lumec color): _____ (COLTX). Application of a polyester powder coat paint. (4 mils/100 microns). The chemical composition provides a highly durable UV and salt spray resistant finish in accordance to the ASTM-B117-73 standard and humidity proof in accordance to the ASTM-D2247-68 standard.

Note: **IMPORTANT: All missing details must be clearly specified on the return of these approval drawings. Thank you for your cooperation.**

COLOR: _____

56



540, Curé-Bolvin
Boisbriand (Québec)
Canada, J7G 2A7

Parametric Options Illustration
(schematic pole shown, for actual pole representation please refer to previous pages)

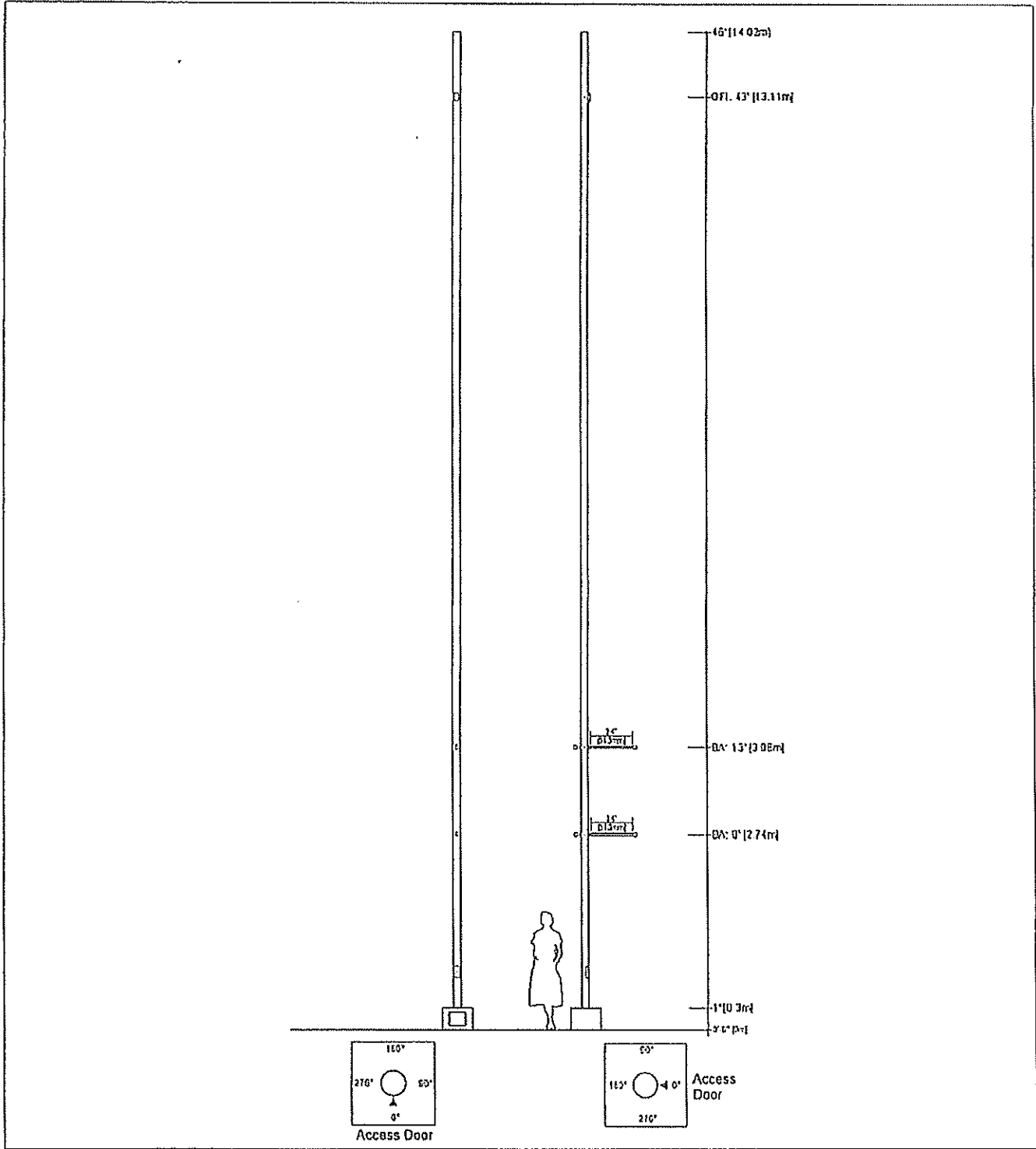

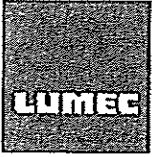

640, Curé-Bolvin
Boisbriand (Québec)
Canada, J7G 2A7

TRANSITION BASE

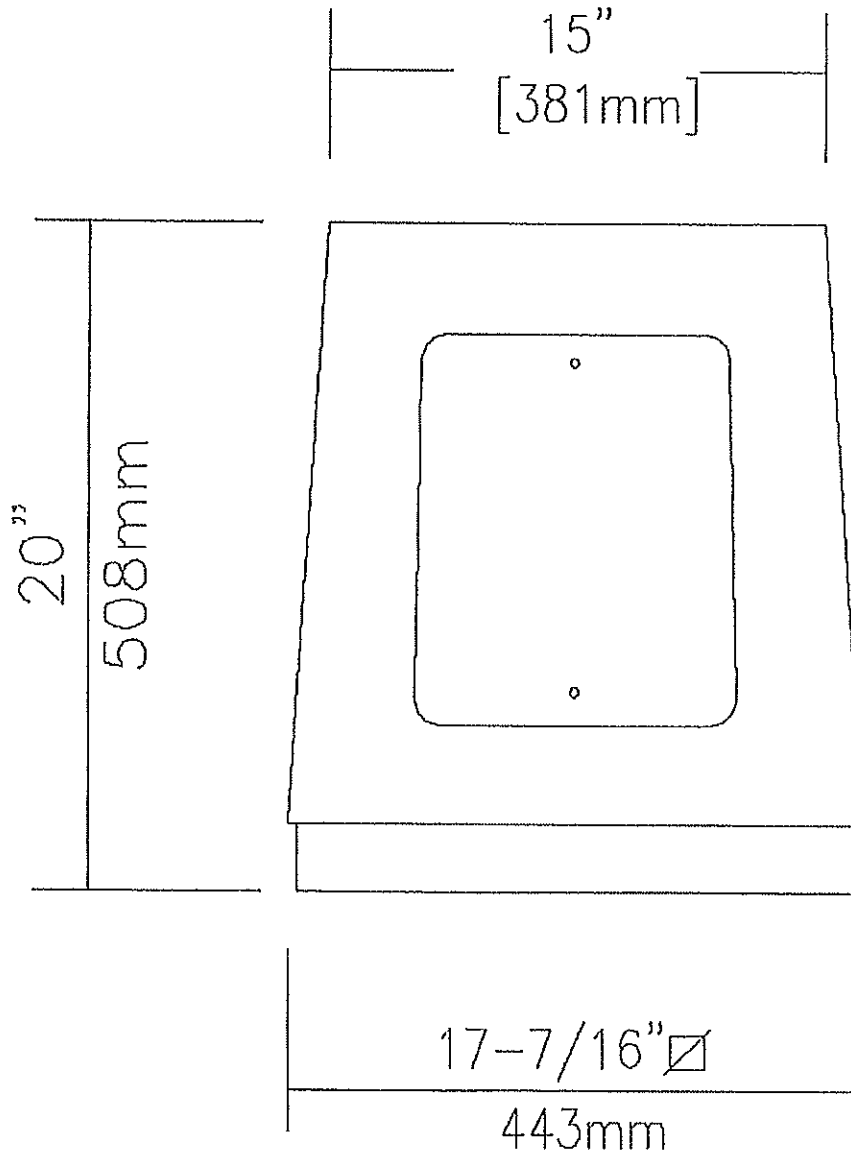

REMOVAL OF LUMINAIRE, SALVAGE

Description. This work includes the labor and equipment necessary for the removal and disposal of the existing roadway luminaires as shown on the plans. This work shall be completed in accordance to Section 842 of the Standard Specifications.

The Luminaires and all associated hardware shall remain the property of the Village of Oak Brook and shall be delivered to a Village of Oak Brook site, as directed by the Engineer. Removed luminaires shall be boxed and labeled prior to delivery.

Basis of Payment. This work will be paid for at the contract unit price per EACH for REMOVAL OF LUMINAIRE, SALVAGE and shall be measured for payment once the fixture are delivered in satisfactory condition to the Village storage facility.

State of Illinois
Department of Transportation
Bureau of Local Roads and Streets

SPECIAL PROVISION
FOR
INSURANCE

Effective: February 1, 2007
Revised: August 1, 2007

All references to Sections or Articles in this specification shall be construed to mean specific Section or Article of the Standard Specifications for Road and Bridge Construction, adopted by the Department of Transportation.

The Contractor shall name the following entities as additional insured under the Contractor's general liability insurance policy in accordance with Article 107.27:

Village of Oak Brook

The entities listed above and their officers, employees, and agents shall be indemnified and held harmless in accordance with Article 107.26.

COARSE AGGREGATE QUALITY (BDE)

Effective: July 1, 2015

Revise Article 1004.01(b) of the Standard Specifications to read:

“(b) Quality. The coarse aggregate shall be according to the quality standards listed in the following table.

COARSE AGGREGATE QUALITY				
QUALITY TEST	CLASS			
	A	B	C	D
Na ₂ SO ₄ Soundness 5 Cycle, ITP 104 ^{1/} , % Loss max.	15	15	20	25 ^{2/}
Los Angeles Abrasion, ITP 96 ^{11/} , % Loss max.	40 ^{3/}	40 ^{4/}	40 ^{5/}	45
Minus No. 200 (75 µm) Sieve Material, ITP 11	1.0 ^{6/}	---	2.5 ^{7/}	---
Deleterious Materials ^{10/}				
Shale, % max.	1.0	2.0	4.0 ^{8/}	---
Clay Lumps, % max.	0.25	0.5	0.5 ^{8/}	---
Coal & Lignite, % max.	0.25	---	---	---
Soft & Unsound Fragments, % max.	4.0	6.0	8.0 ^{8/}	---
Other Deleterious, % max.	4.0 ^{9/}	2.0	2.0 ^{8/}	---
Total Deleterious, % max.	5.0	6.0	10.0 ^{8/}	---
Oil-Stained Aggregate ^{10/} , % max	5.0	---	---	---

1/ Does not apply to crushed concrete.

2/ For aggregate surface course and aggregate shoulders, the maximum percent loss shall be 30.

3/ For portland cement concrete, the maximum percent loss shall be 45.

4/ Does not apply to crushed slag or crushed steel slag.

5/ For hot-mix asphalt (HMA) binder mixtures, except when used as surface course, the maximum percent loss shall be 45.

6/ For crushed aggregate, if the material finer than the No. 200 (75 µm) sieve consists of the dust from fracture, essentially free from clay or silt, this percentage may be increased to 2.5.

- 7/ Does not apply to aggregates for HMA binder mixtures.
- 8/ Does not apply to Class A seal and cover coats.
- 9/ Includes deleterious chert. In gravel and crushed gravel aggregate, deleterious chert shall be the lightweight fraction separated in a 2.35 heavy media separation. In crushed stone aggregate, deleterious chert shall be the lightweight fraction separated in a 2.55 heavy media separation. Tests shall be run according to ITP 113.
- 10/ Test shall be run according to ITP 203.
- 11/ Does not apply to crushed slag.

All varieties of chert contained in gravel coarse aggregate for portland cement concrete, whether crushed or uncrushed, pure or impure, and irrespective of color, will be classed as chert and shall not be present in the total aggregate in excess of 25 percent by weight (mass).

Aggregates used in Class BS concrete (except when poured on subgrade), Class PS concrete, and Class PC concrete (bridge superstructure products only, excluding the approach slab) shall contain no more than two percent by weight (mass) of deleterious materials. Deleterious materials shall include substances whose disintegration is accompanied by an increase in volume which may cause spalling of the concrete.”

80360

COILABLE NONMETALLIC CONDUIT (BDE)

Effective: August 1, 2014

Revised: January 1, 2015

Revise Article 1088.01(c) of the Standard Specifications to read:

“(c) Coilable Nonmetallic Conduit. The conduit shall be a high density polyethylene duct which is intended for underground use can be manufactured and coiled or reeled in continuous transportable lengths and uncoiled for further processing and/or installation without adversely affecting its properties or performance. The conduit and its manufacture shall be according to UL 651A for Schedule 40 conduit, except Schedule 80 shall be used under pavement, stabilized shoulder, paved median, paved driveway, curb and/or gutter and sidewalk.

Performance Tests. Testing procedures and test results shall meet the requirements of UL 651A. Certified copies of the test report shall be submitted to the Engineer prior to the installation of the conduit.”

80341

CONCRETE GUTTER, CURB, MEDIAN, AND PAVED DITCH (BDE)

Effective: April 1, 2014

| Revised: August 1, 2014

Add the following to Article 606.02 of the Standard Specifications:

“(i) Polyurethane Joint Sealant 1050.04”

Revise the fifth paragraph of Article 606.07 of the Standard Specifications to read:

“Transverse contraction and longitudinal construction joints shall be sealed according to Article 420.12, except transverse joints in concrete curb and gutter shall be sealed with polysulfide or polyurethane joint sealant.”

Add the following to Section 1050 of the Standard Specifications:

| **1050.04 Polyurethane Joint Sealant.** The joint sealant shall be a polyurethane sealant, Type S, Grade NS, Class 25 or better, Use T (T₁ or T₂), according to ASTM C 920.”

80334

CONSTRUCTION AIR QUALITY – DIESEL RETROFIT (BDE)

Effective: June 1, 2010
 Revised: November 1, 2014

The reduction of emissions of particulate matter (PM) for off-road equipment shall be accomplished by installing retrofit emission control devices. The term "equipment" refers to diesel fuel powered devices rated at 50 hp and above, to be used on the jobsite in excess of seven calendar days over the course of the construction period on the jobsite (including rental equipment).

Contractor and subcontractor diesel powered off-road equipment assigned to the contract shall be retrofitted using the phased in approach shown below. Equipment that is of a model year older than the year given for that equipment's respective horsepower range shall be retrofitted:

Effective Dates	Horsepower Range	Model Year
June 1, 2010 ^{1/}	600-749	2002
	750 and up	2006
June 1, 2011 ^{2/}	100-299	2003
	300-599	2001
	600-749	2002
	750 and up	2006
June 1, 2012 ^{2/}	50-99	2004
	100-299	2003
	300-599	2001
	600-749	2002
	750 and up	2006

1/ Effective dates apply to Contractor diesel powered off-road equipment assigned to the contract.

2/ Effective dates apply to Contractor and subcontractor diesel powered off-road equipment assigned to the contract.

The retrofit emission control devices shall achieve a minimum PM emission reduction of 50 percent and shall be:

- a) Included on the U.S. Environmental Protection Agency (USEPA) *Verified Retrofit Technology List* (<http://www.epa.gov/cleandiesel/verification/verif-list.htm>), or verified by the California Air Resources Board (CARB) (<http://www.arb.ca.gov/diesel/verdev/vt/cvt.htm>); or
- b) Retrofitted with a non-verified diesel retrofit emission control device if verified retrofit emission control devices are not available for equipment proposed to be used on the project, and if the Contractor has obtained a performance certification from the retrofit

device manufacturer that the emission control device provides a minimum PM emission reduction of 50 percent.

Note: Large cranes (Crawler mounted cranes) which are responsible for critical lift operations are exempt from installing retrofit emission control devices if such devices adversely affect equipment operation.

Diesel powered off-road equipment with engine ratings of 50 hp and above, which are unable to be retrofitted with verified emission control devices or if performance certifications are not available which will achieve a minimum 50 percent PM reduction, may be granted a waiver by the Department if documentation is provided showing good faith efforts were made by the Contractor to retrofit the equipment.

Construction shall not proceed until the Contractor submits a certified list of the diesel powered off-road equipment that will be used, and as necessary, retrofitted with emission control devices. The list(s) shall include (1) the equipment number, type, make, Contractor/rental company name; and (2) the emission control devices make, model, USEPA or CARB verification number, or performance certification from the retrofit device manufacturer. Equipment reported as fitted with emissions control devices shall be made available to the Engineer for visual inspection of the device installation, prior to being used on the jobsite.

The Contractor shall submit an updated list of retrofitted off-road construction equipment as retrofitted equipment changes or comes on to the jobsite. The addition or deletion of any diesel powered equipment shall be included on the updated list.

If any diesel powered off-road equipment is found to be in non-compliance with any portion of this special provision, the Engineer will issue the Contractor a diesel retrofit deficiency deduction.

Any costs associated with retrofitting any diesel powered off-road equipment with emission control devices shall be considered as included in the contract unit prices bid for the various items of work involved and no additional compensation will be allowed. The Contractor's compliance with this notice and any associated regulations shall not be grounds for a claim.

Diesel Retrofit Deficiency Deduction

When the Engineer determines that a diesel retrofit deficiency exists, a daily monetary deduction will be imposed for each calendar day or fraction thereof the deficiency continues to exist. The calendar day(s) will begin when the time period for correction is exceeded and end with the Engineer's written acceptance of the correction. The daily monetary deduction will be \$1,000.00 for each deficiency identified.

The deficiency will be based on lack of diesel retrofit emissions control.

If a Contractor accumulates three diesel retrofit deficiency deductions for the same piece of equipment in a contract period, the Contractor will be shutdown until the deficiency is corrected.

Such a shutdown will not be grounds for any extension of the contract time, waiver of penalties, or be grounds for any claim.

80261

CONTRACT CLAIMS (BDE)

Effective: April 1, 2014

Revise the first paragraph of Article 109.09(a) of the Standard Specifications to read:

“(a) Submission of Claim. All claims filed by the Contractor shall be in writing and in sufficient detail to enable the Department to ascertain the basis and amount of the claim. As a minimum, the following information must accompany each claim submitted.”

Revise Article 109.09(e) of the Standard Specifications to read:

“(e) Procedure. The Department provides two administrative levels for claims review.

Level I Engineer of Construction

Level II Chief Engineer/Director of Highways or Designee

- (1) Level I. All claims shall first be submitted at Level I. Two copies each of the claim and supporting documentation shall be submitted simultaneously to the District and the Engineer of Construction. The Engineer of Construction, in consultation with the District, will consider all information submitted with the claim and render a decision on the claim within 90 days after receipt by the Engineer of Construction. Claims not conforming to this Article will be returned without consideration. The Engineer of Construction may schedule a claim presentation meeting if in the Engineer of Construction's judgment such a meeting would aid in resolution of the claim, otherwise a decision will be made based on the claim documentation submitted. If a Level I decision is not rendered within 90 days of receipt of the claim, or if the Contractor disputes the decision, an appeal to Level II may be made by the Contractor.
- (2) Level II. An appeal to Level II shall be made in writing to the Engineer of Construction within 45 days after the date of the Level I decision. Review of the claim at Level II shall be conducted as a full evaluation of the claim. A claim presentation meeting may be scheduled if the Chief Engineer/Director of Highways determines that such a meeting would aid in resolution of the claim, otherwise a decision will be made based on the claim documentation submitted. A Level II final decision will be rendered within 90 days of receipt of the written request for appeal.

Full compliance by the Contractor with the provisions specified in this Article is a contractual condition precedent to the Contractor's right to seek relief in the Court of Claims. The Director's written decision shall be the final administrative action of the Department. Unless the Contractor files a claim for adjudication by the Court of Claims within 60 days after the date of the written decision, the failure to file shall constitute a release and waiver of the claim.”

80335

DISADVANTAGED BUSINESS ENTERPRISE PARTICIPATION (DBE)

Effective: September 1, 2000

Revised: January 2, 2016

FEDERAL OBLIGATION. The Department of Transportation, as a recipient of federal financial assistance, is required to take all necessary and reasonable steps to ensure nondiscrimination in the award and administration of contracts. Consequently, the federal regulatory provisions of 49 CFR Part 26 apply to this contract concerning the utilization of disadvantaged business enterprises. For the purposes of this Special Provision, a disadvantaged business enterprise (DBE) means a business certified by the Department in accordance with the requirements of 49 CFR Part 26 and listed in the Illinois Unified Certification Program (IL UCP) DBE Directory.

STATE OBLIGATION. This Special Provision will also be used by the Department to satisfy the requirements of the Business Enterprise for Minorities, Females, and Persons with Disabilities Act, 30 ILCS 575. When this Special Provision is used to satisfy state law requirements on 100 percent state-funded contracts, the federal government has no involvement in such contracts (not a federal-aid contract) and no responsibility to oversee the implementation of this Special Provision by the Department on those contracts. DBE participation on 100 percent state-funded contracts will not be credited toward fulfilling the Department's annual overall DBE goal required by the US Department of Transportation to comply with the federal DBE program requirements.

CONTRACTOR ASSURANCE. The Contractor makes the following assurance and agrees to include the assurance in each subcontract that the Contractor signs with a subcontractor.

The Contractor, subrecipient, or subcontractor shall not discriminate on the basis of race, color, national origin, or sex in the performance of this contract. The Contractor shall carry out applicable requirements of 49 CFR Part 26 in the award and administration of contracts funded in whole or in part with federal or state funds. Failure by the Contractor to carry out these requirements is a material breach of this contract, which may result in the termination of this contract or such other remedy as the recipient deems appropriate, which may include, but is not limited to:

- (a) Withholding progress payments;
- (b) Assessing sanctions;
- (c) Liquidated damages; and/or
- (d) Disqualifying the Contractor from future bidding as non-responsible.

OVERALL GOAL SET FOR THE DEPARTMENT. As a requirement of compliance with 49 CFR Part 26, the Department has set an overall goal for DBE participation in its federally assisted contracts. That goal applies to all federal-aid funds the Department will expend in its federally assisted contracts for the subject reporting fiscal year. The Department is required to make a

good faith effort to achieve the overall goal. The dollar amount paid to all approved DBE companies performing work called for in this contract is eligible to be credited toward fulfillment of the Department's overall goal.

CONTRACT GOAL TO BE ACHIEVED BY THE CONTRACTOR. This contract includes a specific DBE utilization goal established by the Department. The goal has been included because the Department has determined that the work of this contract has subcontracting opportunities that may be suitable for performance by DBE companies. The determination is based on an assessment of the type of work, the location of the work, and the availability of DBE companies to do a part of the work. The assessment indicates that, in the absence of unlawful discrimination, and in an arena of fair and open competition, DBE companies can be expected to perform 22.00% of the work. This percentage is set as the DBE participation goal for this contract. Consequently, in addition to the other award criteria established for this contract, the Department will only award this contract to a bidder who makes a good faith effort to meet this goal of DBE participation in the performance of the work. A bidder makes a good faith effort for award consideration if either of the following is done in accordance with the procedures set for in this Special Provision:

- (a) The bidder documents that enough DBE participation has been obtained to meet the goal or,
- (b) The bidder documents that a good faith effort has been made to meet the goal, even though the effort did not succeed in obtaining enough DBE participation to meet the goal.

DBE LOCATOR REFERENCES. Bidders shall consult the IL UCP DBE Directory as a reference source for DBE-certified companies. In addition, the Department maintains a letting and item specific DBE locator information system whereby DBE companies can register their interest in providing quotes on particular bid items advertised for letting. Information concerning DBE companies willing to quote work for particular contracts may be obtained by contacting the Department's Bureau of Small Business Enterprises at telephone number (217) 785-4611, or by visiting the Department's website at:

<http://www.idot.illinois.gov/doing-business/certifications/disadvantaged-business-enterprise-certification/il-ucp-directory/index>.

BIDDING PROCEDURES. Compliance with this Special Provision is required prior to the award of the contract and the failure of the low bidder to comply will render the bid not responsive.

In order to assure the timely award of the contract, the low bidder shall submit:

- (a) The bidder shall submit a Disadvantaged Business Utilization Plan on completed Department forms SBE 2025 and 2026.
 - (1) The final Utilization Plan must be submitted within five calendar days after the date of the letting.

- (2) To meet the five day requirement, the bidder may send the Utilization Plan electronically by scanning and sending to DOT.DBE.UP@illinois.gov or faxing to (217) 785-1524. The subject line must include the bid Item Number and the Letting date. The Utilization Plan should be sent as one .pdf file, rather than multiple files and emails for the same Item Number. It is the responsibility of the bidder to obtain confirmation of email or fax delivery.

Alternatively, the Utilization Plan may be sent by certified mail or delivery service within the five calendar day period. If a question arises concerning the mailing date of a Utilization Plan, the mailing date will be established by the U.S. Postal Service postmark on the original certified mail receipt from the U.S. Postal Service or the receipt issued by a delivery service. It is the responsibility of the bidder to ensure the postmark or receipt date is affixed within the five days if the bidder intends to rely upon mailing or delivery to satisfy the submission day requirement. The Utilization Plan is to be submitted to:

Illinois Department of Transportation
Bureau of Small Business Enterprises
Contract Compliance Section
2300 South Dirksen Parkway, Room 319
Springfield, Illinois 62764

The Department will not accept a Utilization Plan if it does not meet the five day submittal requirement and the bid will be declared not responsive. In the event the bid is declared not responsive due to a failure to submit a Utilization Plan or failure to comply with the bidding procedures set forth herein, the Department may elect to cause the forfeiture of the penal sum of the bidder's proposal guaranty, and may deny authorization to bid the project if re-advertised for bids. The Department reserves the right to invite any other bidder to submit a Utilization Plan at any time for award consideration or to extend the time for award.

- (b) The Utilization Plan shall indicate that the bidder either has obtained sufficient DBE participation commitments to meet the contract goal or has not obtained enough DBE participation commitments in spite of a good faith effort to meet the goal. The Utilization Plan shall further provide the name, telephone number, and telefax number of a responsible official of the bidder designated for purposes of notification of Utilization Plan approval or disapproval under the procedures of this Special Provision.
- (c) The Utilization Plan shall include a DBE Participation Commitment Statement, Department form SBE 2025, for each DBE proposed for the performance of work to achieve the contract goal. For bidding purposes, submission of the completed SBE 2025 forms, signed by the DBEs and scanned or faxed to the bidder will be acceptable as long as the original is available and provided upon request. All elements of information indicated on the said form shall be provided, including but not limited to the following:

- (1) The names and addresses of DBE firms that will participate in the contract;
- (2) A description, including pay item numbers, of the work each DBE will perform;
- (3) The dollar amount of the participation of each DBE firm participating. The dollar amount of participation for identified work shall specifically state the quantity, unit price, and total subcontract price for the work to be completed by the DBE. If partial pay items are to be performed by the DBE, indicate the portion of each item, a unit price where appropriate and the subcontract price amount;
- (4) DBE Participation Commitment Statements, form SBE 2025, signed by the bidder and each participating DBE firm documenting the commitment to use the DBE subcontractors whose participation is submitted to meet the contract goal;
- (5) If the bidder is a joint venture comprised of DBE companies and non-DBE companies, the Utilization Plan must also include a clear identification of the portion of the work to be performed by the DBE partner(s); and,
- (6) If the contract goal is not met, evidence of good faith efforts; the documentation of good faith efforts must include copies of each DBE and non-DBE subcontractor quote submitted to the bidder when a non-DBE subcontractor is selected over a DBE for work on the contract.

GOOD FAITH EFFORT PROCEDURES. The contract will not be awarded until the Utilization Plan submitted by the apparent successful bidder is approved. All information submitted by the bidder must be complete, accurate and adequately document that enough DBE participation has been obtained or document that good faith efforts of the bidder, in the event enough DBE participation has not been obtained, before the Department will commit to the performance of the contract by the bidder. The Utilization Plan will be approved by the Department if the Utilization Plan documents sufficient commercially useful DBE work to meet the contract goal or the bidder submits sufficient documentation of a good faith effort to meet the contract goal pursuant to 49 CFR Part 26, Appendix A. The Utilization Plan will not be approved by the Department if the Utilization Plan does not document sufficient DBE participation to meet the contract goal unless the apparent successful bidder documented in the Utilization Plan that it made a good faith effort to meet the goal. This means that the bidder must show that all necessary and reasonable steps were taken to achieve the contract goal. Necessary and reasonable steps are those which, by their scope, intensity and appropriateness to the objective, could reasonably be expected to obtain sufficient DBE participation, even if they were not successful. The Department will consider the quality, quantity, and intensity of the kinds of efforts that the bidder has made. Mere *pro forma* efforts, in other words, efforts done as a matter of form, are not good faith efforts; rather, the bidder is expected to have taken genuine efforts that would be reasonably expected of a bidder actively and aggressively trying to obtain DBE participation sufficient to meet the contract goal.

- (a) The following is a list of types of action that the Department will consider as part of the evaluation of the bidder's good faith efforts to obtain participation. These listed factors

are not intended to be a mandatory checklist and are not intended to be exhaustive. Other factors or efforts brought to the attention of the Department may be relevant in appropriate cases, and will be considered by the Department.

- (1) Soliciting through all reasonable and available means (e.g. attendance at pre-bid meetings, advertising and/or written notices) the interest of all certified DBE companies that have the capability to perform the work of the contract. The bidder must solicit this interest within sufficient time to allow the DBE companies to respond to the solicitation. The bidder must determine with certainty if the DBE companies are interested by taking appropriate steps to follow up initial solicitations.
- (2) Selecting portions of the work to be performed by DBE companies in order to increase the likelihood that the DBE goals will be achieved. This includes, where appropriate, breaking out contract work items into economically feasible units to facilitate DBE participation, even when the prime Contractor might otherwise prefer to perform these work items with its own forces.
- (3) Providing interested DBE companies with adequate information about the plans, specifications, and requirements of the contract in a timely manner to assist them in responding to a solicitation.
- (4) a. Negotiating in good faith with interested DBE companies. It is the bidder's responsibility to make a portion of the work available to DBE subcontractors and suppliers and to select those portions of the work or material needs consistent with the available DBE subcontractors and suppliers, so as to facilitate DBE participation. Evidence of such negotiation includes the names, addresses, and telephone numbers of DBE companies that were considered; a description of the information provided regarding the plans and specifications for the work selected for subcontracting; and evidence as to why additional agreements could not be reached for DBE companies to perform the work.
 - b. A bidder using good business judgment would consider a number of factors in negotiating with subcontractors, including DBE subcontractors, and would take a firm's price and capabilities as well as contract goals into consideration. However, the fact that there may be some additional costs involved in finding and using DBE companies is not in itself sufficient reason for a bidder's failure to meet the contract DBE goal, as long as such costs are reasonable. Also the ability or desire of a bidder to perform the work of a contract with its own organization does not relieve the bidder of the responsibility to make good faith efforts. Bidders are not, however, required to accept higher quotes from DBE companies if the price difference is excessive or unreasonable. In accordance with subsection (c)(6) of the above Bidding Procedures, the documentation of good faith efforts must include copies of each DBE and non-DBE subcontractor quote submitted to the bidder when a non-DBE subcontractor was selected over a DBE for work on the contract.

- (5) Not rejecting DBE companies as being unqualified without sound reasons based on a thorough investigation of their capabilities. The bidder's standing within its industry, membership in specific groups, organizations, or associations and political or social affiliations (for example union vs. non-union employee status) are not legitimate causes for the rejection or non-solicitation of bids in the bidder's efforts to meet the project goal.
 - (6) Making efforts to assist interested DBE companies in obtaining bonding, lines of credit, or insurance as required by the recipient or Contractor.
 - (7) Making efforts to assist interested DBE companies in obtaining necessary equipment, supplies, materials, or related assistance or services.
 - (8) Effectively using the services of available minority/women community organizations; minority/women contractors' groups; local, state, and federal minority/women business assistance offices; and other organizations as allowed on a case-by-case basis to provide assistance in the recruitment and placement of DBE companies.
- (b) If the Department determines that the apparent successful bidder has made a good faith effort to secure the work commitment of DBE companies to meet the contract goal, the Department will award the contract provided that it is otherwise eligible for award. If the Department determines that the bidder has failed to meet the requirements of this Special Provision or that a good faith effort has not been made, the Department will notify the responsible company official designated in the Utilization Plan that the bid is not responsive. The notification shall include a statement of reasons for the determination. If the Utilization Plan is not approved because it is deficient as a technical matter, unless waived by the Department, the bidder will be notified and will be allowed no more than a five calendar day period in order to cure the deficiency.
- (c) The bidder may request administrative reconsideration of a determination adverse to the bidder within the five working days after the receipt of the notification date of the determination by delivering the request to the Department of Transportation, Bureau of Small Business Enterprises, Contract Compliance Section, 2300 South Dirksen Parkway, Room 319, Springfield, Illinois 62764 (Telefax: (217) 785-1524). Deposit of the request in the United States mail on or before the fifth business day shall not be deemed delivery. The determination shall become final if a request is not made and delivered. A request may provide additional written documentation or argument concerning the issues raised in the determination statement of reasons, provided the documentation and arguments address efforts made prior to submitting the bid. The request will be forwarded to the Department's Reconsideration Officer. The Reconsideration Officer will extend an opportunity to the bidder to meet in person in order to consider all issues of documentation and whether the bidder made a good faith effort to meet the goal. After the review by the Reconsideration Officer, the bidder will be sent a written decision within ten working days after receipt of the request for consideration, explaining the basis for finding that the bidder did or did not meet the goal or make adequate good faith efforts to do so. A final decision by the Reconsideration

Officer that a good faith effort was made shall approve the Utilization Plan submitted by the bidder and shall clear the contract for award. A final decision that a good faith effort was not made shall render the bid not responsive.

CALCULATING DBE PARTICIPATION. The Utilization Plan values represent work anticipated to be performed and paid for upon satisfactory completion. The Department is only able to count toward the achievement of the overall goal and the contract goal the value of payments made for the work actually performed by DBE companies. In addition, a DBE must perform a commercially useful function on the contract to be counted. A commercially useful function is generally performed when the DBE is responsible for the work and is carrying out its responsibilities by actually performing, managing, and supervising the work involved. The Department and Contractor are governed by the provisions of 49 CFR Part 26.55(c) on questions of commercially useful functions as it affects the work. Specific counting guidelines are provided in 49 CFR Part 26.55, the provisions of which govern over the summary contained herein.

- (a) DBE as the Contractor: 100 percent goal credit for that portion of the work performed by the DBE's own forces, including the cost of materials and supplies. Work that a DBE subcontracts to a non-DBE does not count toward the DBE goals.
- (b) DBE as a joint venture Contractor: 100 percent goal credit for that portion of the total dollar value of the contract equal to the distinct, clearly defined portion of the work performed by the DBE's own forces.
- (c) DBE as a subcontractor: 100 percent goal credit for the work of the subcontract performed by the DBE's own forces, including the cost of materials and supplies, excluding the purchase of materials and supplies or the lease of equipment by the DBE subcontractor from the prime Contractor or its affiliates. Work that a DBE subcontractor in turn subcontracts to a non-DBE does not count toward the DBE goal.
- (d) DBE as a trucker: 100 percent goal credit for trucking participation provided the DBE is responsible for the management and supervision of the entire trucking operation for which it is responsible. At least one truck owned, operated, licensed, and insured by the DBE must be used on the contract. Credit will be given for the following:
 - (1) The DBE may lease trucks from another DBE firm, including an owner-operator who is certified as a DBE. The DBE who leases trucks from another DBE receives credit for the total value of the transportation services the lessee DBE provides on the contract.
 - (2) The DBE may also lease trucks from a non-DBE firm, including from an owner-operator. The DBE who leases trucks from a non-DBE is entitled to credit only for the fee or commission it receives as a result of the lease arrangement.
- (e) DBE as a material supplier:

- (1) 60 percent goal credit for the cost of the materials or supplies purchased from a DBE regular dealer.
- (2) 100 percent goal credit for the cost of materials of supplies obtained from a DBE manufacturer.
- (3) 100 percent credit for the value of reasonable fees and commissions for the procurement of materials and supplies if not a DBE regular dealer or DBE manufacturer.

CONTRACT COMPLIANCE. Compliance with this Special Provision is an essential part of the contract. The Department is prohibited by federal regulations from crediting the participation of a DBE included in the Utilization Plan toward either the contract goal or the Department's overall goal until the amount to be applied toward the goals has been paid to the DBE. The following administrative procedures and remedies govern the compliance by the Contractor with the contractual obligations established by the Utilization Plan. After approval of the Utilization Plan and award of the contract, the Utilization Plan and individual DBE Participation Statements become part of the contract. If the Contractor did not succeed in obtaining enough DBE participation to achieve the advertised contract goal, and the Utilization Plan was approved and contract awarded based upon a determination of good faith, the total dollar value of DBE work calculated in the approved Utilization Plan as a percentage of the awarded contract value shall become the amended contract goal. All work indicated for performance by an approved DBE shall be performed, managed, and supervised by the DBE executing the DBE Participation Commitment Statement.

- (a) NO AMENDMENT. No amendment to the Utilization Plan may be made without prior written approval from the Department's Bureau of Small Business Enterprises. All requests for amendment to the Utilization Plan shall be submitted to the Department of Transportation, Bureau of Small Business Enterprises, Contract Compliance Section, 2300 South Dirksen Parkway, Room 319, Springfield, Illinois 62764. Telephone number (217) 785-4611. Telefax number (217) 785-1524.
- (b) CHANGES TO WORK. Any deviation from the DBE condition-of-award or contract plans, specifications, or special provisions must be approved, in writing, by the Department as provided elsewhere in the Contract. The Contractor shall notify affected DBEs in writing of any changes in the scope of work which result in a reduction in the dollar amount condition-of-award to the contract. Where the revision includes work committed to a new DBE subcontractor, not previously involved in the project, then a Request for Approval of Subcontractor, Department form BC 260A or AER 260A, must be signed and submitted. If the commitment of work is in the form of additional tasks assigned to an existing subcontract, then a new Request for Approval of Subcontractor shall not be required. However, the Contractor must document efforts to assure that the existing DBE subcontractor is capable of performing the additional work and has agreed in writing to the change.

(c) SUBCONTRACT. The Contractor must provide DBE subcontracts to IDOT upon request. Subcontractors shall ensure that all lower tier subcontracts or agreements with DBEs to supply labor or materials be performed in accordance with this Special Provision.

(d) ALTERNATIVE WORK METHODS. In addition to the above requirements for reductions in the condition of award, additional requirements apply to the two cases of Contractor-initiated work substitution proposals. Where the contract allows alternate work methods which serve to delete or create underruns in condition of award DBE work, and the Contractor selects that alternate method or, where the Contractor proposes a substitute work method or material that serves to diminish or delete work committed to a DBE and replace it with other work, then the Contractor must demonstrate one of the following:

(1) That the replacement work will be performed by the same DBE (as long as the DBE is certified in the respective item of work) in a modification of the condition of award; or

(2) That the DBE is aware that its work will be deleted or will experience underruns and has agreed in writing to the change. If this occurs, the Contractor shall substitute other work of equivalent value to a certified DBE or provide documentation of good faith efforts to do so; or

(3) That the DBE is not capable of performing the replacement work or has declined to perform the work at a reasonable competitive price. If this occurs, the Contractor shall substitute other work of equivalent value to a certified DBE or provide documentation of good faith efforts to do so.

(e) TERMINATION AND REPLACEMENT PROCEDURES. The Contractor shall not terminate or replace a DBE listed on the approved Utilization Plan, or perform with other forces work designated for a listed DBE except as provided in this Special Provision. The Contractor shall utilize the specific DBEs listed to perform the work and supply the materials for which each is listed unless the Contractor obtains the Department's written consent as provided in subsection (a) of this part. Unless Department consent is provided for termination of a DBE subcontractor, the Contractor shall not be entitled to any payment for work or material unless it is performed or supplied by the DBE in the Utilization Plan.

As stated above, the Contractor shall not terminate or replace a DBE subcontractor listed in the approved Utilization Plan without prior written consent. This includes, but is not limited to, instances in which the Contractor seeks to perform work originally designated for a DBE subcontractor with its own forces or those of an affiliate, a non-DBE firm, or with another DBE firm. Written consent will be granted only if the Bureau of Small Business Enterprises agrees, for reasons stated in its concurrence document, that the Contractor has good cause to terminate or replace the DBE firm. Before transmitting to the Bureau of Small Business Enterprises any request to terminate and/or substitute a DBE subcontractor, the Contractor shall give notice in writing to the DBE subcontractor,

with a copy to the Bureau, of its intent to request to terminate and/or substitute, and the reason for the request. The Contractor shall give the DBE five days to respond to the Contractor's notice. The DBE so notified shall advise the Bureau and the Contractor of the reasons, if any, why it objects to the proposed termination of its subcontract and why the Bureau should not approve the Contractor's action. If required in a particular case as a matter of public necessity, the Bureau may provide a response period shorter than five days.

For purposes of this paragraph, good cause includes the following circumstances:

- (1) The listed DBE subcontractor fails or refuses to execute a written contract;
- (2) The listed DBE subcontractor fails or refuses to perform the work of its subcontract in a way consistent with normal industry standards. Provided, however, that good cause does not exist if the failure or refusal of the DBE subcontractor to perform its work on the subcontract results from the bad faith or discriminatory action of the prime contractor;
- (3) The listed DBE subcontractor fails or refuses to meet the prime Contractor's reasonable, nondiscriminatory bond requirements;
- (4) The listed DBE subcontractor becomes bankrupt, insolvent, or exhibits credit unworthiness;
- (5) The listed DBE subcontractor is ineligible to work on public works projects because of suspension and debarment proceedings pursuant 2 CFR Parts 180, 215 and 1200 or applicable state law.
- (6) You have determined that the listed DBE subcontractor is not a responsible contractor;
- (7) The listed DBE subcontractor voluntarily withdraws from the projects and provides to you written notice of its withdrawal;
- (8) The listed DBE is ineligible to receive DBE credit for the type of work required;
- (9) A DBE owner dies or becomes disabled with the result that the listed DBE contractor is unable to complete its work on the contract;
- (10) Other documented good cause that compels the termination of the DBE subcontractor. Provided, that good cause does not exist if the prime Contractor seeks to terminate a DBE it relied upon to obtain the contract so that the prime Contractor can self-perform the work for which the DBE contractor was engaged or so that the prime Contractor can substitute another DBE or non-DBE contractor after contract award.

When a DBE is terminated, or fails to complete its work on the Contract for any reason the Contractor shall make a good faith effort to find another DBE to substitute for the original DBE to perform at least the same amount of work under the contract as the terminated DBE to the extent needed to meet the established Contract goal. The good faith efforts shall be documented by the Contractor. If the Department requests documentation under this provision, the Contractor shall submit the documentation within seven days, which may be extended for an additional seven days if necessary at the request of the Contractor. The Department shall provide a written determination to the Contractor stating whether or not good faith efforts have been demonstrated.

- (f) PAYMENT RECORDS. The Contractor shall maintain a record of payments for work performed to the DBE participants. The records shall be made available to the Department for inspection upon request. After the performance of the final item of work or delivery of material by a DBE and final payment therefore to the DBE by the Contractor, but not later than thirty calendar days after payment has been made by the Department to the Contractor for such work or material, the Contractor shall submit a DBE Payment Agreement on Department form SBE 2115 to the Resident Engineer. If full and final payment has not been made to the DBE, the DBE Payment Agreement shall indicate whether a disagreement as to the payment required exists between the Contractor and the DBE or if the Contractor believes that the work has not been satisfactorily completed. If the Contractor does not have the full amount of work indicated in the Utilization Plan performed by the DBE companies indicated in the Utilization Plan and after good faith efforts are reviewed, the Department may deduct from contract payments to the Contractor the amount of the goal not achieved as liquidated and ascertained damages. The Contractor may request an administrative reconsideration of any amount deducted as damages pursuant to subsection (h) of this part.
- (g) ENFORCEMENT. The Department reserves the right to withhold payment to the Contractor to enforce the provisions of this Special Provision. Final payment shall not be made on the contract until such time as the Contractor submits sufficient documentation demonstrating achievement of the goal in accordance with this Special Provision or after liquidated damages have been determined and collected.
- (h) RECONSIDERATION. Notwithstanding any other provision of the contract, including but not limited to Article 109.09 of the Standard Specifications, the Contractor may request administrative reconsideration of a decision to deduct the amount of the goal not achieved as liquidated damages. A request to reconsider shall be delivered to the Contract Compliance Section and shall be handled and considered in the same manner as set forth in paragraph (c) of "Good Faith Effort Procedures" of this Special Provision, except a final decision that a good faith effort was not made during contract performance to achieve the goal agreed to in the Utilization Plan shall be the final administrative decision of the Department. The result of the reconsideration process is not administratively appealable to the U.S. Department of Transportation.

EQUAL EMPLOYMENT OPPORTUNITY (BDE)

Effective: April 1, 2015

FEDERAL AID CONTRACTS. Revise the following section of Check Sheet #1 of the Recurring Special Provisions to read:

"EQUAL EMPLOYMENT OPPORTUNITY

In the event of the Contractor's noncompliance with the provisions of this Equal Employment Opportunity Clause, the Illinois Human Rights Act, or the Illinois Department of Human Rights Rules and Regulations, the Contractor may be declared ineligible for future contracts or subcontracts with the State of Illinois or any of its political sub-divisions or municipal corporations, and the contract may be cancelled or voided in whole or in part, and such other sanctions or penalties may be imposed or remedies invoked as provided by statute or regulation.

During the performance of this Contract, the Contractor agrees as follows:

- (1) That it will not discriminate against any employee or applicant for employment because of race, color, religion, sex, sexual orientation, marital status, order of protection status, national origin or ancestry, citizenship status, age, physical or mental disability unrelated to ability, military status, or an unfavorable discharge from military service; and further that it will examine all job classifications to determine if minority persons or women are underutilized and will take appropriate affirmative action to rectify any such underutilization.
- (2) That, if it hires additional employees in order to perform this contract or any portion hereof, it will determine the availability (according to the Illinois Department of Human Rights Rules and Regulations) of minorities and women in the area(s) from which it may reasonably recruit and it will hire for each job classification for which employees are hired in such a way that minorities and women are not underutilized.
- (3) That, in all solicitations or advertisements for employees placed by it or on its behalf, it will state that all applicants will be afforded equal opportunity without discrimination because of race, color, religion, sex, sexual orientation, marital status, order of protection status, national origin or ancestry, citizenship status, age, physical or mental disability unrelated to ability, military status or an unfavorable discharge from military service.
- (4) That it will send to each labor organization or representative of workers with which it has or is bound by a collective bargaining or other agreement or understanding, a notice advising such labor organization or representative of the Contractor's obligations under the Illinois Human Rights Act and the Illinois Department of Human Rights Rules and Regulations. If any labor organization or representative fails or refuses to cooperate with the Contractor in its efforts to comply with such Act and Rules and Regulations, the

Contractor will promptly so notify the Illinois Department of Human Rights and IDOT and will recruit employees from other sources when necessary to fulfill its obligations thereunder.

- (5) That it will submit reports as required by the Illinois Department of Human Rights Rules and Regulations, furnish all relevant information as may from time to time be requested by the Illinois Department of Human Rights or IDOT, and in all respects comply with the Illinois Human Rights Act and the Illinois Department of Human Rights Rules and Regulations.
- (6) That it will permit access to all relevant books, records, accounts, and work sites by personnel of IDOT and the Illinois Department of Human Rights for purposes of investigation to ascertain compliance with the Illinois Human Rights Act and the Illinois Department of Human Rights Rules and Regulations.
- (7) That it will include verbatim or by reference the provisions of this clause in every subcontract it awards under which any portion of the contract obligations are undertaken or assumed, so that the provisions will be binding upon the subcontractor. In the same manner as with other provisions of this contract, the Contractor will be liable for compliance with applicable provisions of this clause by subcontractors; and further it will promptly notify IDOT and the Illinois Department of Human Rights in the event any subcontractor fails or refuses to comply with these provisions. In addition, the Contractor will not utilize any subcontractor declared by the Illinois Human Rights Commission to be ineligible for contracts or subcontracts with the State of Illinois or any of its political subdivisions or municipal corporations."

STATE CONTRACTS. Revise Section II of Check Sheet #5 of the Recurring Special Provisions to read:

"II. EQUAL EMPLOYMENT OPPORTUNITY

In the event of the Contractor's noncompliance with the provisions of this Equal Employment Opportunity Clause, the Illinois Human Rights Act or the Illinois Department of Human Rights Rules and Regulations, the Contractor may be declared ineligible for future contracts or subcontracts with the State of Illinois or any of its political sub-divisions or municipal corporations, and the contract may be cancelled or voided in whole or in part, and such other sanctions or penalties may be imposed or remedies invoked as provided by statute or regulation.

During the performance of this Contract, the Contractor agrees as follows:

1. That it will not discriminate against any employee or applicant for employment because of race, color, religion, sex, sexual orientation, marital status, order of protection status, national origin or ancestry, citizenship status, age, physical or mental disability unrelated to ability, military status, or an unfavorable discharge from military service; and further

that it will examine all job classifications to determine if minority persons or women are underutilized and will take appropriate affirmative action to rectify any such underutilization.

2. That, if it hires additional employees in order to perform this contract or any portion hereof, it will determine the availability (according to the Illinois Department of Human Rights Rules and Regulations) of minorities and women in the area(s) from which it may reasonably recruit and it will hire for each job classification for which employees are hired in such a way that minorities and women are not underutilized.
3. That, in all solicitations or advertisements for employees placed by it or on its behalf, it will state that all applicants will be afforded equal opportunity without discrimination because of race, color, religion, sex, sexual orientation, marital status, order of protection status, national origin or ancestry, citizenship status, age, physical or mental disability unrelated to ability, military status, or an unfavorable discharge from military service.
4. That it will send to each labor organization or representative of workers with which it has or is bound by a collective bargaining or other agreement or understanding, a notice advising such labor organization or representative of the Contractor's obligations under the Illinois Human Rights Act and the Illinois Department of Human Rights Rules and Regulations. If any labor organization or representative fails or refuses to cooperate with the Contractor in its efforts to comply with such Act and Rules and Regulations, the Contractor will promptly so notify the Illinois Department of Human Rights and IDOT and will recruit employees from other sources when necessary to fulfill its obligations thereunder.
5. That it will submit reports as required by the Illinois Department of Human Rights Rules and Regulations, furnish all relevant information as may from time to time be requested by the Illinois Department of Human Rights or IDOT, and in all respects comply with the Illinois Human Rights Act and the Illinois Department of Human Rights Rules and Regulations.
6. That it will permit access to all relevant books, records, accounts and work sites by personnel of IDOT and the Illinois Department of Human Rights for purposes of investigation to ascertain compliance with the Illinois Human Rights Act and the Illinois Department of Human Rights Rules and Regulations.
7. That it will include verbatim or by reference the provisions of this clause in every subcontract it awards under which any portion of the contract obligations are undertaken or assumed, so that the provisions will be binding upon the subcontractor. In the same manner as with other provisions of this contract, the Contractor will be liable for compliance with applicable provisions of this clause by subcontractors; and further it will promptly notify IDOT and the Illinois Department of Human Rights in the event any subcontractor fails or refuses to comply with these provisions. In addition, the Contractor will not utilize any subcontractor declared by the Illinois Human Rights

Commission to be ineligible for contracts or subcontracts with the State of Illinois or any of its political subdivisions or municipal corporations.”

80358

PRECAST CONCRETE HANDHOLE (BDE)

Effective: August 1, 2014

Revise the third paragraph of Article 814.03 of the Standard Specifications to read:

“Handholes shall be constructed as shown on the plans and shall be cast-in-place, composite concrete, or precast units. Heavy duty handholes shall be either cast-in-place or precast units.”

Add the following to Article 814.03 of the Standard Specifications:

“(c) Precast Concrete. Precast concrete handholes shall be fabricated according to Article 1042.17. Where a handhole is contiguous to a sidewalk, preformed joint filler of 1/2 inch (13 mm) thickness shall be placed between the handhole and the sidewalk.”

Add the following to Section 1042 of the Standard Specifications:

“**1042.17 Precast Concrete Handholes.** Precast concrete handholes shall be according to Articles 1042.03(a)(c)(d)(e).”

80343

PROGRESS PAYMENTS (BDE)

Effective: November 2, 2013

Revise Article 109.07(a) of the Standard Specifications to read:

“(a) Progress Payments. At least once each month, the Engineer will make a written estimate of the quantity of work performed in accordance with the contract, and the value thereof at the contract unit prices. The amount of the estimate approved as due for payment will be vouchered by the Department and presented to the State Comptroller for payment. No amount less than \$1000.00 will be approved for payment other than the final payment.

Progress payments may be reduced by liens filed pursuant to Section 23(c) of the Mechanics' Lien Act, 770 ILCS 60/23(c).

If a Contractor or subcontractor has defaulted on a loan issued under the Department's Disadvantaged Business Revolving Loan Program (20 ILCS 2705/2705-610), progress payments may be reduced pursuant to the terms of that loan agreement. In such cases, the amount of the estimate related to the work performed by the Contractor or subcontractor, in default of the loan agreement, will be offset, in whole or in part, and vouchered by the Department to the Working Capital Revolving Fund or designated escrow account. Payment for the work shall be considered as issued and received by the Contractor or subcontractor on the date of the offset voucher. Further, the amount of the offset voucher shall be a credit against the Department's obligation to pay the Contractor, the Contractor's obligation to pay the subcontractor, and the Contractor's or subcontractor's total loan indebtedness to the Department. The offset shall continue until such time as the entire loan indebtedness is satisfied. The Department will notify the Contractor and Fund Control Agent in a timely manner of such offset. The Contractor or subcontractor shall not be entitled to additional payment in consideration of the offset.

The failure to perform any requirement, obligation, or term of the contract by the Contractor shall be reason for withholding any progress payments until the Department determines that compliance has been achieved.”

80328

REINFORCEMENT BARS (BDE)

Effective: November 1, 2013

Revise the first and second paragraphs of Article 508.05 of the Standard Specifications to read:

“508.05 Placing and Securing. All reinforcement bars shall be placed and tied securely at the locations and in the configuration shown on the plans prior to the placement of concrete. Manual welding of reinforcement may only be permitted on precast concrete products as indicated in the current Bureau of Materials and Physical Research Policy Memorandum “Quality Control / Quality Assurance Program for Precast Concrete Products”, and for precast prestressed concrete products as indicated in the Department’s current “Manual for Fabrication of Precast Prestressed Concrete Products”. Reinforcement bars shall not be placed by sticking or floating into place or immediately after placement of the concrete.

Bars shall be tied at all intersections, except where the center to center dimension is less than 1 ft (300 mm) in each direction, in which case alternate intersections shall be tied. Molded plastic clips may be used in lieu of wire to secure bar intersections, but shall not be permitted in horizontal bar mats subject to construction foot traffic or to secure longitudinal bar laps. Plastic clips shall adequately secure the reinforcement bars, and shall permit the concrete to flow through and fully encase the reinforcement. Plastic clips may be recycled plastic, and shall meet the approval of the Engineer. The number of ties as specified shall be doubled for lap splices at the stage construction line of concrete bridge decks when traffic is allowed on the first completed stage during the pouring of the second stage.”

Revise the fifth paragraph of Article 508.05 of the Standard Specifications to read:

“Supports for reinforcement in bridge decks shall be metal. For all other concrete construction the supports shall be metal or plastic. Metal bar supports shall be made of cold-drawn wire, or other approved material and shall be either epoxy coated, galvanized or plastic tipped. When the reinforcement bars are epoxy coated, the metal supports shall be epoxy coated. Plastic supports may be recycled plastic. Supports shall be provided in sufficient number and spaced to provide the required clearances. Supports shall adequately support the reinforcement bars, and shall permit the concrete to flow through and fully encase the reinforcement. The legs of supports shall be spaced to allow an opening that is a minimum 1.33 times the nominal maximum aggregate size used in the concrete. Nominal maximum aggregate size is defined as the largest sieve which retains any of the aggregate sample particles. All supports shall meet the approval of the Engineer.”

Revise the first sentence of the eighth paragraph of Article 508.05 of the Standard Specifications to read:

“Epoxy coated reinforcement bars shall be tied with plastic coated wire, epoxy coated wire, or molded plastic clips where allowed.”

Add the following sentence to the end of the first paragraph of Article 508.06(c) of the Standard Specifications:

“In addition, the total slip of the bars within the splice sleeve of the connector after loading in tension to 30 ksi (207 MPa) and relaxing to 3 ksi (20.7 MPa) shall not exceed 0.01 in. (254 microns).”

Revise Article 1042.03(d) of the Standard Specifications to read:

“(d) Reinforcement and Accessories: The concrete cover over all reinforcement shall be within $\pm 1/4$ in. (± 6 mm) of the specified cover.

Welded wire fabric shall be accurately bent and tied in place.

Miscellaneous accessories to be cast into the concrete or for forming holes and recesses shall be carefully located and rigidly held in place by bolts, clamps, or other effective means. If paper tubes are used for vertical dowel holes, or other vertical holes which require grouting, they shall be removed before transportation to the construction site.”

80327

RIGID METAL CONDUIT (BDE)

Effective: August 1, 2014

Add the following to Article 1088.01(a) of the Standard Specifications:

"(6) Stainless Steel Conduit. The conduit shall be Type 304 or Type 316 stainless steel, shall be manufactured according to UL Standard 6A, and shall meet ANSI Standard C80.1. Conduit fittings shall be Type 304 or Type 316 stainless steel and shall be manufactured according to UL Standard 514B.

All conduit supports, straps, clamps. And other attachments shall be Type 304 or Type 316 stainless steel. Attachment hardware shall be stainless steel according to Article 1006.31."

80344

SIDEWALK, CORNER, OR CROSSWALK CLOSURE (BDE)

Effective: January 1, 2015

| Revised: April 1, 2015

Revise the first sentence of Article 1106.02(m) of the Supplemental Specifications to read:

“The top and bottom panels shall have alternating white and orange stripes sloping 45 degrees on both sides.”

80354

TRACKING THE USE OF PESTICIDES (BDE)

Effective: August 1, 2012

Add the following paragraph after the first paragraph of Article 107.23 of the Standard Specifications:

“Within 48 hours of the application of pesticides, including but not limited to herbicides, insecticides, algaecides, and fungicides, the Contractor shall complete and return to the Engineer, Operations form “OPER 2720”.”

80301

WEEKLY DBE TRUCKING REPORTS (BDE)

Effective: June 2, 2012

Revised: April 2, 2015

The Contractor shall submit a weekly report of Disadvantaged Business Enterprise (DBE) trucks hired by the Contractor or subcontractors (i.e. not owned by the Contractor or subcontractors) that are used for DBE goal credit.

The report shall be submitted to the Engineer on Department form "SBE 723" within ten business days following the reporting period. The reporting period shall be Monday through Sunday for each week reportable trucking activities occur.

Any costs associated with providing weekly DBE trucking reports shall be considered as included in the contract unit prices bid for the various items of work involved and no additional compensation will be allowed.

80302

WORKING DAYS (BDE)

Effective: January 1, 2002

The Contractor shall complete the work within 60 working days.

80071

REQUIRED CONTRACT PROVISIONS FEDERAL-AID CONSTRUCTION CONTRACTS

- I. General
- II. Nondiscrimination
- III. Nonsegregated Facilities
- IV. Davis-Bacon and Related Act Provisions
- V. Contract Work Hours and Safety Standards Act Provisions
- VI. Subletting or Assigning the Contract
- VII. Safety: Accident Prevention
- VIII. False Statements Concerning Highway Projects
- IX. Implementation of Clean Air Act and Federal Water Pollution Control Act
- X. Compliance with Governmentwide Suspension and Debarment Requirements
- XI. Certification Regarding Use of Contract Funds for Lobbying

ATTACHMENTS

A. Employment and Materials Preference for Appalachian Development Highway System or Appalachian Local Access Road Contracts (included in Appalachian contracts only)

I. GENERAL

1. Form FHWA-1273 must be physically incorporated in each construction contract funded under Title 23 (excluding emergency contracts solely intended for debris removal). The contractor (or subcontractor) must insert this form in each subcontract and further require its inclusion in all lower tier subcontracts (excluding purchase orders, rental agreements and other agreements for supplies or services).

The applicable requirements of Form FHWA-1273 are incorporated by reference for work done under any purchase order, rental agreement or agreement for other services. The prime contractor shall be responsible for compliance by any subcontractor, lower-tier subcontractor or service provider.

Form FHWA-1273 must be included in all Federal-aid design-build contracts, in all subcontracts and in lower tier subcontracts (excluding subcontracts for design services, purchase orders, rental agreements and other agreements for supplies or services). The design-builder shall be responsible for compliance by any subcontractor, lower-tier subcontractor or service provider.

Contracting agencies may reference Form FHWA-1273 in bid proposal or request for proposal documents, however, the Form FHWA-1273 must be physically incorporated (not referenced) in all contracts, subcontracts and lower-tier subcontracts (excluding purchase orders, rental agreements and other agreements for supplies or services related to a construction contract).

2. Subject to the applicability criteria noted in the following sections, these contract provisions shall apply to all work performed on the contract by the contractor's own organization and with the assistance of workers under the contractor's immediate superintendence and to all work performed on the contract by piecework, station work, or by subcontract.

3. A breach of any of the stipulations contained in these Required Contract Provisions may be sufficient grounds for withholding of progress payments, withholding of final payment, termination of the contract, suspension / debarment or any other action determined to be appropriate by the contracting agency and FHWA.

4. Selection of Labor: During the performance of this contract, the contractor shall not use convict labor for any purpose within the limits of a construction project on a Federal-aid highway unless it is labor performed by convicts who are on parole, supervised release, or probation. The term Federal-aid highway does not include roadways functionally classified as local roads or rural minor collectors.

II. NONDISCRIMINATION

The provisions of this section related to 23 CFR Part 230 are applicable to all Federal-aid construction contracts and to all related construction subcontracts of \$10,000 or more. The provisions of 23 CFR Part 230 are not applicable to material supply, engineering, or architectural service contracts.

In addition, the contractor and all subcontractors must comply with the following policies: Executive Order 11246, 41 CFR 60, 29 CFR 1625-1627, Title 23 USC Section 140, the Rehabilitation Act of 1973, as amended (29 USC 794), Title VI of the Civil Rights Act of 1964, as amended, and related regulations including 49 CFR Parts 21, 26 and 27; and 23 CFR Parts 200, 230, and 633.

The contractor and all subcontractors must comply with: the requirements of the Equal Opportunity Clause in 41 CFR 60-1.4(b) and, for all construction contracts exceeding \$10,000, the Standard Federal Equal Employment Opportunity Construction Contract Specifications in 41 CFR 60-4.3.

Note: The U.S. Department of Labor has exclusive authority to determine compliance with Executive Order 11246 and the policies of the Secretary of Labor including 41 CFR 60, and 29 CFR 1625-1627. The contracting agency and the FHWA have the authority and the responsibility to ensure compliance with Title 23 USC Section 140, the Rehabilitation Act of 1973, as amended (29 USC 794), and Title VI of the Civil Rights Act of 1964, as amended, and related regulations including 49 CFR Parts 21, 26 and 27; and 23 CFR Parts 200, 230, and 633.

The following provision is adopted from 23 CFR 230, Appendix A, with appropriate revisions to conform to the U.S. Department of Labor (US DOL) and FHWA requirements.

1. Equal Employment Opportunity: Equal employment opportunity (EEO) requirements not to discriminate and to take affirmative action to assure equal opportunity as set forth under laws, executive orders, rules, regulations (28 CFR 35, 29 CFR 1630, 29 CFR 1625-1627, 41 CFR 60 and 49 CFR 27) and orders of the Secretary of Labor as modified by the provisions prescribed herein, and imposed pursuant to 23 U.S.C. 140 shall constitute the EEO and specific affirmative action standards for the contractor's project activities under this contract. The provisions of the Americans with Disabilities Act of 1990 (42 U.S.C. 12101 et seq.) set forth under 28 CFR 35 and 29 CFR 1630 are incorporated by reference in this contract. In the execution of this contract, the contractor agrees to comply with the following minimum specific requirement activities of EEO:

a. The contractor will work with the contracting agency and the Federal Government to ensure that it has made every good faith effort to provide equal opportunity with respect to all of its terms and conditions of employment and in their review of activities under the contract.

b. The contractor will accept as its operating policy the following statement:

"It is the policy of this Company to assure that applicants are employed, and that employees are treated during employment, without regard to their race, religion, sex, color, national origin, age or disability. Such action shall include: employment, upgrading, demotion, or transfer; recruitment or recruitment advertising; layoff or termination; rates of pay or other forms of compensation; and selection for training, including apprenticeship, pre-apprenticeship, and/or on-the-job training."

2. EEO Officer: The contractor will designate and make known to the contracting officers an EEO Officer who will have the responsibility for and must be capable of effectively administering and promoting an active EEO program and who must be assigned adequate authority and responsibility to do so.

3. Dissemination of Policy: All members of the contractor's staff who are authorized to hire, supervise, promote, and discharge employees, or who recommend such action, or who are substantially involved in such action, will be made fully cognizant of, and will implement, the contractor's EEO policy and contractual responsibilities to provide EEO in each grade and classification of employment. To ensure that the above agreement will be met, the following actions will be taken as a minimum:

a. Periodic meetings of supervisory and personnel office employees will be conducted before the start of work and then not less often than once every six months, at which time the contractor's EEO policy and its implementation will be reviewed and explained. The meetings will be conducted by the EEO Officer.

b. All new supervisory or personnel office employees will be given a thorough indoctrination by the EEO Officer, covering all major aspects of the contractor's EEO obligations within thirty days following their reporting for duty with the contractor.

c. All personnel who are engaged in direct recruitment for the project will be instructed by the EEO Officer in the contractor's procedures for locating and hiring minorities and women.

d. Notices and posters setting forth the contractor's EEO policy will be placed in areas readily accessible to employees, applicants for employment and potential employees.

e. The contractor's EEO policy and the procedures to implement such policy will be brought to the attention of employees by means of meetings, employee handbooks, or other appropriate means.

4. Recruitment: When advertising for employees, the contractor will include in all advertisements for employees the notation: "An Equal Opportunity Employer." All such advertisements will be placed in publications having a large circulation among minorities and women in the area from which the project work force would normally be derived.

a. The contractor will, unless precluded by a valid bargaining agreement, conduct systematic and direct recruitment through public and private employee referral sources likely to yield qualified minorities and women. To meet this requirement, the contractor will identify sources of potential minority group employees, and establish with such identified sources procedures whereby minority and women applicants may be referred to the contractor for employment consideration.

b. In the event the contractor has a valid bargaining agreement providing for exclusive hiring hall referrals, the contractor is expected to observe the provisions of that agreement to the extent that the system meets the contractor's compliance with EEO contract provisions. Where implementation of such an agreement has the effect of discriminating against minorities or women, or obligates the contractor to do the same, such implementation violates Federal nondiscrimination provisions.

c. The contractor will encourage its present employees to refer minorities and women as applicants for employment. Information and procedures with regard to referring such applicants will be discussed with employees.

5. Personnel Actions: Wages, working conditions, and employee benefits shall be established and administered, and personnel actions of every type, including hiring, upgrading, promotion, transfer, demotion, layoff, and termination, shall be taken without regard to race, color, religion, sex, national origin, age or disability. The following procedures shall be followed:

a. The contractor will conduct periodic inspections of project sites to insure that working conditions and employee facilities do not indicate discriminatory treatment of project site personnel.

b. The contractor will periodically evaluate the spread of wages paid within each classification to determine any evidence of discriminatory wage practices.

c. The contractor will periodically review selected personnel actions in depth to determine whether there is evidence of discrimination. Where evidence is found, the contractor will promptly take corrective action. If

the review indicates that the discrimination may extend beyond the actions reviewed, such corrective action shall include all affected persons.

d. The contractor will promptly investigate all complaints of alleged discrimination made to the contractor in connection with its obligations under this contract, will attempt to resolve such complaints, and will take appropriate corrective action within a reasonable time. If the investigation indicates that the discrimination may affect persons other than the complainant, such corrective action shall include such other persons. Upon completion of each investigation, the contractor will inform every complainant of all of their avenues of appeal.

6. Training and Promotion:

a. The contractor will assist in locating, qualifying, and increasing the skills of minorities and women who are applicants for employment or current employees. Such efforts should be aimed at developing full journey level status employees in the type of trade or job classification involved.

b. Consistent with the contractor's work force requirements and as permissible under Federal and State regulations, the contractor shall make full use of training programs, i.e., apprenticeship, and on-the-job training programs for the geographical area of contract performance. In the event a special provision for training is provided under this contract, this subparagraph will be superseded as indicated in the special provision. The contracting agency may reserve training positions for persons who receive welfare assistance in accordance with 23 U.S.C. 140(a).

c. The contractor will advise employees and applicants for employment of available training programs and entrance requirements for each.

d. The contractor will periodically review the training and promotion potential of employees who are minorities and women and will encourage eligible employees to apply for such training and promotion.

7. Unions: If the contractor relies in whole or in part upon unions as a source of employees, the contractor will use good faith efforts to obtain the cooperation of such unions to increase opportunities for minorities and women. Actions by the contractor, either directly or through a contractor's association acting as agent, will include the procedures set forth below:

a. The contractor will use good faith efforts to develop, in cooperation with the unions, joint training programs aimed toward qualifying more minorities and women for membership in the unions and increasing the skills of minorities and women so that they may qualify for higher paying employment.

b. The contractor will use good faith efforts to incorporate an EEO clause into each union agreement to the end that such union will be contractually bound to refer applicants without regard to their race, color, religion, sex, national origin, age or disability.

c. The contractor is to obtain information as to the referral practices and policies of the labor union except that to the extent such information is within the exclusive possession of the labor union and such labor union refuses to furnish such information to the contractor, the contractor shall so certify to the contracting agency and shall set forth what efforts have been made to obtain such information.

d. In the event the union is unable to provide the contractor with a reasonable flow of referrals within the time limit set forth in the collective bargaining agreement, the contractor will, through independent recruitment efforts, fill the employment vacancies without regard to race, color, religion, sex, national origin, age or disability; making full efforts to obtain qualified and/or qualifiable minorities and women. The failure of a union to provide sufficient referrals (even though it is obligated to provide exclusive referrals under the terms of a collective bargaining agreement) does not relieve the contractor from the requirements of this paragraph. In the event the union referral practice prevents the contractor from meeting the obligations pursuant to Executive Order 11246, as amended, and these special provisions, such contractor shall immediately notify the contracting agency.

8. Reasonable Accommodation for Applicants / Employees with Disabilities: The contractor must be familiar with the requirements for and comply with the Americans with Disabilities Act and all rules and regulations established there under. Employers must provide reasonable accommodation in all employment activities unless to do so would cause an undue hardship.

9. Selection of Subcontractors, Procurement of Materials and Leasing of Equipment: The contractor shall not discriminate on the grounds of race, color, religion, sex, national origin, age or disability in the selection and retention of subcontractors, including procurement of materials and leases of equipment. The contractor shall take all necessary and reasonable steps to ensure nondiscrimination in the administration of this contract.

a. The contractor shall notify all potential subcontractors and suppliers and lessors of their EEO obligations under this contract.

b. The contractor will use good faith efforts to ensure subcontractor compliance with their EEO obligations.

10. Assurance Required by 49 CFR 26.13(b):

a. The requirements of 49 CFR Part 26 and the State DOT's U.S. DOT-approved DBE program are incorporated by reference.

b. The contractor or subcontractor shall not discriminate on the basis of race, color, national origin, or sex in the performance of this contract. The contractor shall carry out applicable requirements of 49 CFR Part 26 in the award and administration of DOT-assisted contracts. Failure by the contractor to carry out these requirements is a material breach of this contract, which may result in the termination of this contract or such other remedy as the contracting agency deems appropriate.

11. Records and Reports: The contractor shall keep such records as necessary to document compliance with the EEO requirements. Such records shall be retained for a period of three years following the date of the final payment to the contractor for all contract work and shall be available at reasonable times and places for inspection by authorized representatives of the contracting agency and the FHWA.

a. The records kept by the contractor shall document the following:

(1) The number and work hours of minority and non-minority group members and women employed in each work classification on the project;

(2) The progress and efforts being made in cooperation with unions, when applicable, to increase employment opportunities for minorities and women; and

(3) The progress and efforts being made in locating, hiring, training, qualifying, and upgrading minorities and women;

b. The contractors and subcontractors will submit an annual report to the contracting agency each July for the duration of the project, indicating the number of minority, women, and non-minority group employees currently engaged in each work classification required by the contract work. This information is to be reported on [Form FHWA-1391](#). The staffing data should represent the project work force on board in all or any part of the last payroll period preceding the end of July. If on-the-job training is being required by special provision, the contractor will be required to collect and report training data. The employment data should reflect the work force on board during all or any part of the last payroll period preceding the end of July.

III. NONSEGREGATED FACILITIES

This provision is applicable to all Federal-aid construction contracts and to all related construction subcontracts of \$10,000 or more.

The contractor must ensure that facilities provided for employees are provided in such a manner that segregation on the basis of race, color,

religion, sex, or national origin cannot result. The contractor may neither require such segregated use by written or oral policies nor tolerate such use by employee custom. The contractor's obligation extends further to ensure that its employees are not assigned to perform their services at any location, under the contractor's control, where the facilities are segregated. The term "facilities" includes waiting rooms, work areas, restaurants and other eating areas, time clocks, restrooms, washrooms, locker rooms, and other storage or dressing areas, parking lots, drinking fountains, recreation or entertainment areas, transportation, and housing provided for employees. The contractor shall provide separate or single-user restrooms and necessary dressing or sleeping areas to assure privacy between sexes.

IV. Davis-Bacon and Related Act Provisions

This section is applicable to all Federal-aid construction projects exceeding \$2,000 and to all related subcontracts and lower-tier subcontracts (regardless of subcontract size). The requirements apply to all projects located within the right-of-way of a roadway that is functionally classified as Federal-aid highway. This excludes roadways functionally classified as local roads or rural minor collectors, which are exempt. Contracting agencies may elect to apply these requirements to other projects.

The following provisions are from the U.S. Department of Labor regulations in 29 CFR 5.5 "Contract provisions and related matters" with minor revisions to conform to the FHWA-1273 format and FHWA program requirements.

1. Minimum wages

a. All laborers and mechanics employed or working upon the site of the work, will be paid unconditionally and not less often than once a week, and without subsequent deduction or rebate on any account (except such payroll deductions as are permitted by regulations issued by the Secretary of Labor under the Copeland Act (29 CFR part 3)), the full amount of wages and bona fide fringe benefits (or cash equivalents thereof) due at time of payment computed at rates not less than those contained in the wage determination of the Secretary of Labor which is attached hereto and made a part hereof, regardless of any contractual relationship which may be alleged to exist between the contractor and such laborers and mechanics.

Contributions made or costs reasonably anticipated for bona fide fringe benefits under section 1(b)(2) of the Davis-Bacon Act on behalf of laborers or mechanics are considered wages paid to such laborers or mechanics, subject to the provisions of paragraph 1.d. of this section; also, regular contributions made or costs incurred for more than a weekly period (but not less often than quarterly) under plans, funds, or programs which cover the particular weekly period, are deemed to be constructively made or incurred during such weekly period. Such laborers and mechanics shall be paid the appropriate wage rate and fringe benefits on the wage determination for the classification of work actually performed, without regard to skill, except as provided in 29 CFR 5.5(a)(4). Laborers or mechanics performing work in more than one classification may be compensated at the rate specified for each classification for the time actually worked therein: Provided, That the employer's payroll records accurately set forth the time spent in each classification in which work is performed. The wage determination (including any additional classification and wage rates conformed under paragraph 1.b. of this section) and the Davis-Bacon poster (WH-1321) shall be posted at all times by the contractor and its subcontractors at the site of the work in a prominent and accessible place where it can be easily seen by the workers.

b.(1) The contracting officer shall require that any class of laborers or mechanics, including helpers, which is not listed in the wage determination and which is to be employed under the contract shall be classified in conformance with the wage determination. The contracting officer shall approve an additional classification and wage rate and fringe benefits therefore only when the following criteria have been met:

(i) The work to be performed by the classification requested is not performed by a classification in the wage determination; and

(ii) The classification is utilized in the area by the construction industry; and

(iii) The proposed wage rate, including any bona fide fringe benefits, bears a reasonable relationship to the wage rates contained in the wage determination.

(2) If the contractor and the laborers and mechanics to be employed in the classification (if known), or their representatives, and the contracting officer agree on the classification and wage rate (including the amount designated for fringe benefits where appropriate), a report of the action taken shall be sent by the contracting officer to the Administrator of the Wage and Hour Division, Employment Standards Administration, U.S. Department of Labor, Washington, DC 20210. The Administrator, or an authorized representative, will approve, modify, or disapprove every additional classification action within 30 days of receipt and so advise the contracting officer or will notify the contracting officer within the 30-day period that additional time is necessary.

(3) In the event the contractor, the laborers or mechanics to be employed in the classification or their representatives, and the contracting officer do not agree on the proposed classification and wage rate (including the amount designated for fringe benefits, where appropriate), the contracting officer shall refer the questions, including the views of all interested parties and the recommendation of the contracting officer, to the Wage and Hour Administrator for determination. The Wage and Hour Administrator, or an authorized representative, will issue a determination within 30 days of receipt and so advise the contracting officer or will notify the contracting officer within the 30-day period that additional time is necessary.

(4) The wage rate (including fringe benefits where appropriate) determined pursuant to paragraphs 1.b.(2) or 1.b.(3) of this section, shall be paid to all workers performing work in the classification under this contract from the first day on which work is performed in the classification.

c. Whenever the minimum wage rate prescribed in the contract for a class of laborers or mechanics includes a fringe benefit which is not expressed as an hourly rate, the contractor shall either pay the benefit as stated in the wage determination or shall pay another bona fide fringe benefit or an hourly cash equivalent thereof.

d. If the contractor does not make payments to a trustee or other third person, the contractor may consider as part of the wages of any laborer or mechanic the amount of any costs reasonably anticipated in providing bona fide fringe benefits under a plan or program, Provided, That the Secretary of Labor has found, upon the written request of the contractor, that the applicable standards of the Davis-Bacon Act have been met. The Secretary of Labor may require the contractor to set aside in a separate account assets for the meeting of obligations under the plan or program.

2. Withholding

The contracting agency shall upon its own action or upon written request of an authorized representative of the Department of Labor, withhold or cause to be withheld from the contractor under this contract, or any other Federal contract with the same prime contractor, or any other federally-assisted contract subject to Davis-Bacon prevailing wage requirements, which is held by the same prime contractor, so much of the accrued payments or advances as may be considered necessary to pay laborers and mechanics, including apprentices, trainees, and helpers, employed by the contractor or any subcontractor the full amount of wages required by the contract. In the event of failure to pay any laborer or mechanic, including any apprentice, trainee, or helper, employed or working on the site of the work, all or part of the wages required by the contract, the contracting agency may, after written notice to the contractor, take such

action as may be necessary to cause the suspension of any further payment, advance, or guarantee of funds until such violations have ceased.

3. Payrolls and basic records

a. Payrolls and basic records relating thereto shall be maintained by the contractor during the course of the work and preserved for a period of three years thereafter for all laborers and mechanics working at the site of the work. Such records shall contain the name, address, and social security number of each such worker, his or her correct classification, hourly rates of wages paid (including rates of contributions or costs anticipated for bona fide fringe benefits or cash equivalents thereof of the types described in section 1(b)(2)(B) of the Davis-Bacon Act), daily and weekly number of hours worked, deductions made and actual wages paid. Whenever the Secretary of Labor has found under 29 CFR 5.5(a)(1)(iv) that the wages of any laborer or mechanic include the amount of any costs reasonably anticipated in providing benefits under a plan or program described in section 1(b)(2)(B) of the Davis-Bacon Act, the contractor shall maintain records which show that the commitment to provide such benefits is enforceable, that the plan or program is financially responsible, and that the plan or program has been communicated in writing to the laborers or mechanics affected, and records which show the costs anticipated or the actual cost incurred in providing such benefits. Contractors employing apprentices or trainees under approved programs shall maintain written evidence of the registration of apprenticeship programs and certification of trainee programs, the registration of the apprentices and trainees, and the ratios and wage rates prescribed in the applicable programs.

b. (1) The contractor shall submit weekly for each week in which any contract work is performed a copy of all payrolls to the contracting agency. The payrolls submitted shall set out accurately and completely all of the information required to be maintained under 29 CFR 5.5(a)(3)(i), except that full social security numbers and home addresses shall not be included on weekly transmittals. Instead the payrolls shall only need to include an individually identifying number for each employee (e.g., the last four digits of the employee's social security number). The required weekly payroll information may be submitted in any form desired. Optional Form WH-347 is available for this purpose from the Wage and Hour Division Web site at <http://www.dol.gov/esa/whd/forms/wh347instr.htm> or its successor site. The prime contractor is responsible for the submission of copies of payrolls by all subcontractors. Contractors and subcontractors shall maintain the full social security number and current address of each covered worker, and shall provide them upon request to the contracting agency for transmission to the State DOT, the FHWA or the Wage and Hour Division of the Department of Labor for purposes of an investigation or audit of compliance with prevailing wage requirements. It is not a violation of this section for a prime contractor to require a subcontractor to provide addresses and social security numbers to the prime contractor for its own records, without weekly submission to the contracting agency..

(2) Each payroll submitted shall be accompanied by a "Statement of Compliance," signed by the contractor or subcontractor or his or her agent who pays or supervises the payment of the persons employed under the contract and shall certify the following:

(i) That the payroll for the payroll period contains the information required to be provided under §5.5 (a)(3)(ii) of Regulations, 29 CFR part 5, the appropriate information is being maintained under §5.5 (a)(3)(i) of Regulations, 29 CFR part 5, and that such information is correct and complete;

(ii) That each laborer or mechanic (including each helper, apprentice, and trainee) employed on the contract during the payroll period has been paid the full weekly wages earned, without rebate, either directly or indirectly, and that no deductions have been made either directly or indirectly from the full wages earned, other than permissible deductions as set forth in Regulations, 29 CFR part 3;

(iii) That each laborer or mechanic has been paid not less than the applicable wage rates and fringe benefits or cash equivalents for the classification of work performed, as specified in the applicable wage determination incorporated into the contract.

(3) The weekly submission of a properly executed certification set forth on the reverse side of Optional Form WH-347 shall satisfy the requirement for submission of the "Statement of Compliance" required by paragraph 3.b.(2) of this section.

(4) The falsification of any of the above certifications may subject the contractor or subcontractor to civil or criminal prosecution under section 1001 of title 18 and section 231 of title 31 of the United States Code.

c. The contractor or subcontractor shall make the records required under paragraph 3.a. of this section available for inspection, copying, or transcription by authorized representatives of the contracting agency, the State DOT, the FHWA, or the Department of Labor, and shall permit such representatives to interview employees during working hours on the job. If the contractor or subcontractor fails to submit the required records or to make them available, the FHWA may, after written notice to the contractor, the contracting agency or the State DOT, take such action as may be necessary to cause the suspension of any further payment, advance, or guarantee of funds. Furthermore, failure to submit the required records upon request or to make such records available may be grounds for debarment action pursuant to 29 CFR 5.12.

4. Apprentices and trainees

a. Apprentices (programs of the USDOL).

Apprentices will be permitted to work at less than the predetermined rate for the work they performed when they are employed pursuant to and individually registered in a bona fide apprenticeship program registered with the U.S. Department of Labor, Employment and Training Administration, Office of Apprenticeship Training, Employer and Labor Services, or with a State Apprenticeship Agency recognized by the Office, or if a person is employed in his or her first 90 days of probationary employment as an apprentice in such an apprenticeship program, who is not individually registered in the program, but who has been certified by the Office of Apprenticeship Training, Employer and Labor Services or a State Apprenticeship Agency (where appropriate) to be eligible for probationary employment as an apprentice.

The allowable ratio of apprentices to journeymen on the job site in any craft classification shall not be greater than the ratio permitted to the contractor as to the entire work force under the registered program. Any worker listed on a payroll at an apprentice wage rate, who is not registered or otherwise employed as stated above, shall be paid not less than the applicable wage rate on the wage determination for the classification of work actually performed. In addition, any apprentice performing work on the job site in excess of the ratio permitted under the registered program shall be paid not less than the applicable wage rate on the wage determination for the work actually performed. Where a contractor is performing construction on a project in a locality other than that in which its program is registered, the ratios and wage rates (expressed in percentages of the journeyman's hourly rate) specified in the contractor's or subcontractor's registered program shall be observed.

Every apprentice must be paid at not less than the rate specified in the registered program for the apprentice's level of progress, expressed as a percentage of the journeymen hourly rate specified in the applicable wage determination. Apprentices shall be paid fringe benefits in accordance with the provisions of the apprenticeship program. If the apprenticeship program does not specify fringe benefits, apprentices must be paid the full amount of fringe benefits listed on the wage determination for the applicable classification. If the Administrator determines that a different practice prevails for the applicable apprentice classification, fringes shall be paid in accordance with that determination.

In the event the Office of Apprenticeship Training, Employer and Labor Services, or a State Apprenticeship Agency recognized by the Office, withdraws approval of an apprenticeship program, the contractor will no longer be permitted to utilize apprentices at less than the applicable predetermined rate for the work performed until an acceptable program is approved.

b. Trainees (programs of the USDOL).

Except as provided in 29 CFR 5.16, trainees will not be permitted to work at less than the predetermined rate for the work performed unless they are employed pursuant to and individually registered in a program which has received prior approval, evidenced by formal certification by the U.S. Department of Labor, Employment and Training Administration.

The ratio of trainees to journeymen on the job site shall not be greater than permitted under the plan approved by the Employment and Training Administration.

Every trainee must be paid at not less than the rate specified in the approved program for the trainee's level of progress, expressed as a percentage of the journeyman hourly rate specified in the applicable wage determination. Trainees shall be paid fringe benefits in accordance with the provisions of the trainee program. If the trainee program does not mention fringe benefits, trainees shall be paid the full amount of fringe benefits listed on the wage determination unless the Administrator of the Wage and Hour Division determines that there is an apprenticeship program associated with the corresponding journeyman wage rate on the wage determination which provides for less than full fringe benefits for apprentices. Any employee listed on the payroll at a trainee rate who is not registered and participating in a training plan approved by the Employment and Training Administration shall be paid not less than the applicable wage rate on the wage determination for the classification of work actually performed. In addition, any trainee performing work on the job site in excess of the ratio permitted under the registered program shall be paid not less than the applicable wage rate on the wage determination for the work actually performed.

In the event the Employment and Training Administration withdraws approval of a training program, the contractor will no longer be permitted to utilize trainees at less than the applicable predetermined rate for the work performed until an acceptable program is approved.

c. Equal employment opportunity. The utilization of apprentices, trainees and journeymen under this part shall be in conformity with the equal employment opportunity requirements of Executive Order 11246, as amended, and 29 CFR part 30.

d. Apprentices and Trainees (programs of the U.S. DOT).

Apprentices and trainees working under apprenticeship and skill training programs which have been certified by the Secretary of Transportation as promoting EEO in connection with Federal-aid highway construction programs are not subject to the requirements of paragraph 4 of this Section IV. The straight time hourly wage rates for apprentices and trainees under such programs will be established by the particular programs. The ratio of apprentices and trainees to journeymen shall not be greater than permitted by the terms of the particular program.

5. Compliance with Copeland Act requirements. The contractor shall comply with the requirements of 29 CFR part 3, which are incorporated by reference in this contract.

6. Subcontracts. The contractor or subcontractor shall insert Form FHWA-1273 in any subcontracts and also require the subcontractors to include Form FHWA-1273 in any lower tier subcontracts. The prime contractor shall be responsible for the compliance by any subcontractor or lower tier subcontractor with all the contract clauses in 29 CFR 5.5.

7. Contract termination: debarment. A breach of the contract clauses in 29 CFR 5.5 may be grounds for termination of the contract, and for

debarment as a contractor and a subcontractor as provided in 29 CFR 5.12.

8. Compliance with Davis-Bacon and Related Act requirements. All rulings and interpretations of the Davis-Bacon and Related Acts contained in 29 CFR parts 1, 3, and 5 are herein incorporated by reference in this contract.

9. Disputes concerning labor standards. Disputes arising out of the labor standards provisions of this contract shall not be subject to the general disputes clause of this contract. Such disputes shall be resolved in accordance with the procedures of the Department of Labor set forth in 29 CFR parts 5, 6, and 7. Disputes within the meaning of this clause include disputes between the contractor (or any of its subcontractors) and the contracting agency, the U.S. Department of Labor, or the employees or their representatives.

10. Certification of eligibility.

a. By entering into this contract, the contractor certifies that neither it (nor he or she) nor any person or firm who has an interest in the contractor's firm is a person or firm ineligible to be awarded Government contracts by virtue of section 3(a) of the Davis-Bacon Act or 29 CFR 5.12(a)(1).

b. No part of this contract shall be subcontracted to any person or firm ineligible for award of a Government contract by virtue of section 3(a) of the Davis-Bacon Act or 29 CFR 5.12(a)(1).

c. The penalty for making false statements is prescribed in the U.S. Criminal Code, 18 U.S.C. 1001.

V. CONTRACT WORK HOURS AND SAFETY STANDARDS ACT

The following clauses apply to any Federal-aid construction contract in an amount in excess of \$100,000 and subject to the overtime provisions of the Contract Work Hours and Safety Standards Act. These clauses shall be inserted in addition to the clauses required by 29 CFR 5.5(a) or 29 CFR 4.6. As used in this paragraph, the terms laborers and mechanics include watchmen and guards.

1. Overtime requirements. No contractor or subcontractor contracting for any part of the contract work which may require or involve the employment of laborers or mechanics shall require or permit any such laborer or mechanic in any workweek in which he or she is employed on such work to work in excess of forty hours in such workweek unless such laborer or mechanic receives compensation at a rate not less than one and one-half times the basic rate of pay for all hours worked in excess of forty hours in such workweek.

2. Violation; liability for unpaid wages; liquidated damages. In the event of any violation of the clause set forth in paragraph (1.) of this section, the contractor and any subcontractor responsible therefor shall be liable for the unpaid wages. In addition, such contractor and subcontractor shall be liable to the United States (in the case of work done under contract for the District of Columbia or a territory, to such District or to such territory), for liquidated damages. Such liquidated damages shall be computed with respect to each individual laborer or mechanic, including watchmen and guards, employed in violation of the clause set forth in paragraph (1.) of this section, in the sum of \$10 for each calendar day on which such individual was required or permitted to work in excess of the standard workweek of forty hours without payment of the overtime wages required by the clause set forth in paragraph (1.) of this section.

3. Withholding for unpaid wages and liquidated damages. The FHWA or the contacting agency shall upon its own action or upon written request of an authorized representative of the Department of Labor withhold or cause to be withheld, from any moneys payable on account of work performed by the contractor or subcontractor under any such

contract or any other Federal contract with the same prime contractor, or any other federally-assisted contract subject to the Contract Work Hours and Safety Standards Act, which is held by the same prime contractor, such sums as may be determined to be necessary to satisfy any liabilities of such contractor or subcontractor for unpaid wages and liquidated damages as provided in the clause set forth in paragraph (2.) of this section.

4. Subcontracts. The contractor or subcontractor shall insert in any subcontracts the clauses set forth in paragraph (1.) through (4.) of this section and also a clause requiring the subcontractors to include these clauses in any lower tier subcontracts. The prime contractor shall be responsible for compliance by any subcontractor or lower tier subcontractor with the clauses set forth in paragraphs (1.) through (4.) of this section.

VI. SUBLETTING OR ASSIGNING THE CONTRACT

This provision is applicable to all Federal-aid construction contracts on the National Highway System.

1. The contractor shall perform with its own organization contract work amounting to not less than 30 percent (or a greater percentage if specified elsewhere in the contract) of the total original contract price, excluding any specialty items designated by the contracting agency. Specialty items may be performed by subcontract and the amount of any such specialty items performed may be deducted from the total original contract price before computing the amount of work required to be performed by the contractor's own organization (23 CFR 635.116).

a. The term "perform work with its own organization" refers to workers employed or leased by the prime contractor, and equipment owned or rented by the prime contractor, with or without operators. Such term does not include employees or equipment of a subcontractor or lower tier subcontractor, agents of the prime contractor, or any other assignees. The term may include payments for the costs of hiring leased employees from an employee leasing firm meeting all relevant Federal and State regulatory requirements. Leased employees may only be included in this term if the prime contractor meets all of the following conditions:

(1) the prime contractor maintains control over the supervision of the day-to-day activities of the leased employees;

(2) the prime contractor remains responsible for the quality of the work of the leased employees;

(3) the prime contractor retains all power to accept or exclude individual employees from work on the project; and

(4) the prime contractor remains ultimately responsible for the payment of predetermined minimum wages, the submission of payrolls, statements of compliance and all other Federal regulatory requirements.

b. "Specialty Items" shall be construed to be limited to work that requires highly specialized knowledge, abilities, or equipment not ordinarily available in the type of contracting organizations qualified and expected to bid or propose on the contract as a whole and in general are to be limited to minor components of the overall contract.

2. The contract amount upon which the requirements set forth in paragraph (1) of Section VI is computed includes the cost of material and manufactured products which are to be purchased or produced by the contractor under the contract provisions.

3. The contractor shall furnish (a) a competent superintendent or supervisor who is employed by the firm, has full authority to direct performance of the work in accordance with the contract requirements, and is in charge of all construction operations (regardless of who performs the work) and (b) such other of its own organizational resources (supervision, management, and engineering services) as the contracting officer determines is necessary to assure the performance of the contract.

4. No portion of the contract shall be sublet, assigned or otherwise disposed of except with the written consent of the contracting officer, or authorized representative, and such consent when given shall not be construed to relieve the contractor of any responsibility for the fulfillment of the contract. Written consent will be given only after the contracting agency has assured that each subcontract is evidenced in writing and that it contains all pertinent provisions and requirements of the prime contract.

5. The 30% self-performance requirement of paragraph (1) is not applicable to design-build contracts; however, contracting agencies may establish their own self-performance requirements.

VII. SAFETY: ACCIDENT PREVENTION

This provision is applicable to all Federal-aid construction contracts and to all related subcontracts.

1. In the performance of this contract the contractor shall comply with all applicable Federal, State, and local laws governing safety, health, and sanitation (23 CFR 635). The contractor shall provide all safeguards, safety devices and protective equipment and take any other needed actions as it determines, or as the contracting officer may determine, to be reasonably necessary to protect the life and health of employees on the job and the safety of the public and to protect property in connection with the performance of the work covered by the contract.

2. It is a condition of this contract, and shall be made a condition of each subcontract, which the contractor enters into pursuant to this contract, that the contractor and any subcontractor shall not permit any employee, in performance of the contract, to work in surroundings or under conditions which are unsanitary, hazardous or dangerous to his/her health or safety, as determined under construction safety and health standards (29 CFR 1926) promulgated by the Secretary of Labor, in accordance with Section 107 of the Contract Work Hours and Safety Standards Act (40 U.S.C. 3704).

3. Pursuant to 29 CFR 1926.3, it is a condition of this contract that the Secretary of Labor or authorized representative thereof, shall have right of entry to any site of contract performance to inspect or investigate the matter of compliance with the construction safety and health standards and to carry out the duties of the Secretary under Section 107 of the Contract Work Hours and Safety Standards Act (40 U.S.C.3704).

VIII. FALSE STATEMENTS CONCERNING HIGHWAY PROJECTS

This provision is applicable to all Federal-aid construction contracts and to all related subcontracts.

In order to assure high quality and durable construction in conformity with approved plans and specifications and a high degree of reliability on statements and representations made by engineers, contractors, suppliers, and workers on Federal-aid highway projects, it is essential that all persons concerned with the project perform their functions as carefully, thoroughly, and honestly as possible. Willful falsification, distortion, or misrepresentation with respect to any facts related to the project is a violation of Federal law. To prevent any misunderstanding regarding the seriousness of these and similar acts, Form FHWA-1022 shall be posted on each Federal-aid highway project (23 CFR 635) in one or more places where it is readily available to all persons concerned with the project:

18 U.S.C. 1020 reads as follows:

"Whoever, being an officer, agent, or employee of the United States, or of any State or Territory, or whoever, whether a person, association, firm, or corporation, knowingly makes any false statement, false representation, or false report as to the character, quality, quantity, or cost of the material used or to be used, or the quantity or quality of the work performed or to be performed, or the cost thereof in connection with the submission of plans, maps, specifications, contracts, or costs of construction on any highway or related project submitted for approval to the Secretary of Transportation; or

Whoever knowingly makes any false statement, false representation, false report or false claim with respect to the character, quality, quantity, or cost of any work performed or to be performed, or materials furnished or to be furnished, in connection with the construction of any highway or related project approved by the Secretary of Transportation; or

Whoever knowingly makes any false statement or false representation as to material fact in any statement, certificate, or report submitted pursuant to provisions of the Federal-aid Roads Act approved July 1, 1916, (39 Stat. 355), as amended and supplemented;

Shall be fined under this title or imprisoned not more than 5 years or both."

IX. IMPLEMENTATION OF CLEAN AIR ACT AND FEDERAL WATER POLLUTION CONTROL ACT

This provision is applicable to all Federal-aid construction contracts and to all related subcontracts.

By submission of this bid/proposal or the execution of this contract, or subcontract, as appropriate, the bidder, proposer, Federal-aid construction contractor, or subcontractor, as appropriate, will be deemed to have stipulated as follows:

1. That any person who is or will be utilized in the performance of this contract is not prohibited from receiving an award due to a violation of Section 508 of the Clean Water Act or Section 306 of the Clean Air Act.

2. That the contractor agrees to include or cause to be included the requirements of paragraph (1) of this Section X in every subcontract, and further agrees to take such action as the contracting agency may direct as a means of enforcing such requirements.

X. CERTIFICATION REGARDING DEBARMENT, SUSPENSION, INELIGIBILITY AND VOLUNTARY EXCLUSION

This provision is applicable to all Federal-aid construction contracts, design-build contracts, subcontracts, lower-tier subcontracts, purchase orders, lease agreements, consultant contracts or any other covered transaction requiring FHWA approval or that is estimated to cost \$25,000 or more – as defined in 2 CFR Parts 180 and 1200.

1. Instructions for Certification – First Tier Participants:

a. By signing and submitting this proposal, the prospective first tier participant is providing the certification set out below.

b. The inability of a person to provide the certification set out below will not necessarily result in denial of participation in this covered transaction. The prospective first tier participant shall submit an explanation of why it cannot provide the certification set out below. The certification or explanation will be considered in connection with the department or agency's determination whether to enter into this transaction. However, failure of the prospective first tier participant to furnish a certification or an explanation shall disqualify such a person from participation in this transaction.

c. The certification in this clause is a material representation of fact upon which reliance was placed when the contracting agency determined to enter into this transaction. If it is later determined that the prospective participant knowingly rendered an erroneous certification, in addition to other remedies available to the Federal Government, the contracting agency may terminate this transaction for cause of default.

d. The prospective first tier participant shall provide immediate written notice to the contracting agency to whom this proposal is submitted if any time the prospective first tier participant learns that its certification was erroneous when submitted or has become erroneous by reason of changed circumstances.

e. The terms "covered transaction," "debarred," "suspended," "ineligible," "participant," "person," "principal," and "voluntarily excluded,"

as used in this clause, are defined in 2 CFR Parts 180 and 1200. "First Tier Covered Transactions" refers to any covered transaction between a grantee or subgrantee of Federal funds and a participant (such as the prime or general contract). "Lower Tier Covered Transactions" refers to any covered transaction under a First Tier Covered Transaction (such as subcontracts). "First Tier Participant" refers to the participant who has entered into a covered transaction with a grantee or subgrantee of Federal funds (such as the prime or general contractor). "Lower Tier Participant" refers any participant who has entered into a covered transaction with a First Tier Participant or other Lower Tier Participants (such as subcontractors and suppliers).

f. The prospective first tier participant agrees by submitting this proposal that, should the proposed covered transaction be entered into, it shall not knowingly enter into any lower tier covered transaction with a person who is debarred, suspended, declared ineligible, or voluntarily excluded from participation in this covered transaction, unless authorized by the department or agency entering into this transaction.

g. The prospective first tier participant further agrees by submitting this proposal that it will include the clause titled "Certification Regarding Debarment, Suspension, Ineligibility and Voluntary Exclusion-Lower Tier Covered Transactions," provided by the department or contracting agency, entering into this covered transaction, without modification, in all lower tier covered transactions and in all solicitations for lower tier covered transactions exceeding the \$25,000 threshold.

h. A participant in a covered transaction may rely upon a certification of a prospective participant in a lower tier covered transaction that is not debarred, suspended, ineligible, or voluntarily excluded from the covered transaction, unless it knows that the certification is erroneous. A participant is responsible for ensuring that its principals are not suspended, debarred, or otherwise ineligible to participate in covered transactions. To verify the eligibility of its principals, as well as the eligibility of any lower tier prospective participants, each participant may, but is not required to, check the Excluded Parties List System website (<https://www.epls.gov/>), which is compiled by the General Services Administration.

i. Nothing contained in the foregoing shall be construed to require the establishment of a system of records in order to render in good faith the certification required by this clause. The knowledge and information of the prospective participant is not required to exceed that which is normally possessed by a prudent person in the ordinary course of business dealings.

j. Except for transactions authorized under paragraph (f) of these instructions, if a participant in a covered transaction knowingly enters into a lower tier covered transaction with a person who is suspended, debarred, ineligible, or voluntarily excluded from participation in this transaction, in addition to other remedies available to the Federal Government, the department or agency may terminate this transaction for cause or default.

* * * * *

2. Certification Regarding Debarment, Suspension, Ineligibility and Voluntary Exclusion – First Tier Participants:

a. The prospective first tier participant certifies to the best of its knowledge and belief, that it and its principals:

(1) Are not presently debarred, suspended, proposed for debarment, declared ineligible, or voluntarily excluded from participating in covered transactions by any Federal department or agency;

(2) Have not within a three-year period preceding this proposal been convicted of or had a civil judgment rendered against them for commission of fraud or a criminal offense in connection with obtaining, attempting to obtain, or performing a public (Federal, State or local) transaction or contract under a public transaction; violation of Federal or State antitrust statutes or commission of embezzlement, theft, forgery, bribery, falsification or destruction of records, making false statements, or receiving stolen property;

(3) Are not presently indicted for or otherwise criminally or civilly charged by a governmental entity (Federal, State or local) with

commission of any of the offenses enumerated in paragraph (a)(2) of this certification; and

(4) Have not within a three-year period preceding this application/proposal had one or more public transactions (Federal, State or local) terminated for cause or default.

b. Where the prospective participant is unable to certify to any of the statements in this certification, such prospective participant shall attach an explanation to this proposal.

2. Instructions for Certification - Lower Tier Participants:

(Applicable to all subcontracts, purchase orders and other lower tier transactions requiring prior FHWA approval or estimated to cost \$25,000 or more - 2 CFR Parts 180 and 1200)

a. By signing and submitting this proposal, the prospective lower tier is providing the certification set out below.

b. The certification in this clause is a material representation of fact upon which reliance was placed when this transaction was entered into. If it is later determined that the prospective lower tier participant knowingly rendered an erroneous certification, in addition to other remedies available to the Federal Government, the department, or agency with which this transaction originated may pursue available remedies, including suspension and/or debarment.

c. The prospective lower tier participant shall provide immediate written notice to the person to which this proposal is submitted if at any time the prospective lower tier participant learns that its certification was erroneous by reason of changed circumstances.

d. The terms "covered transaction," "debarred," "suspended," "ineligible," "participant," "person," "principal," and "voluntarily excluded," as used in this clause, are defined in 2 CFR Parts 180 and 1200. You may contact the person to which this proposal is submitted for assistance in obtaining a copy of those regulations. "First Tier Covered Transactions" refers to any covered transaction between a grantee or subgrantee of Federal funds and a participant (such as the prime or general contract). "Lower Tier Covered Transactions" refers to any covered transaction under a First Tier Covered Transaction (such as subcontracts). "First Tier Participant" refers to the participant who has entered into a covered transaction with a grantee or subgrantee of Federal funds (such as the prime or general contractor). "Lower Tier Participant" refers any participant who has entered into a covered transaction with a First Tier Participant or other Lower Tier Participants (such as subcontractors and suppliers).

e. The prospective lower tier participant agrees by submitting this proposal that, should the proposed covered transaction be entered into, it shall not knowingly enter into any lower tier covered transaction with a person who is debarred, suspended, declared ineligible, or voluntarily excluded from participation in this covered transaction, unless authorized by the department or agency with which this transaction originated.

f. The prospective lower tier participant further agrees by submitting this proposal that it will include this clause titled "Certification Regarding Debarment, Suspension, Ineligibility and Voluntary Exclusion-Lower Tier Covered Transaction," without modification, in all lower tier covered transactions and in all solicitations for lower tier covered transactions exceeding the \$25,000 threshold.

g. A participant in a covered transaction may rely upon a certification of a prospective participant in a lower tier covered transaction that is not debarred, suspended, ineligible, or voluntarily excluded from the covered transaction, unless it knows that the certification is erroneous. A participant is responsible for ensuring that its principals are not suspended, debarred, or otherwise ineligible to participate in covered transactions. To verify the eligibility of its principals, as well as the eligibility of any lower tier prospective participants, each participant may, but is not required to, check the Excluded Parties List System website (<https://www.epls.gov/>), which is compiled by the General Services Administration.

h. Nothing contained in the foregoing shall be construed to require establishment of a system of records in order to render in good faith the

certification required by this clause. The knowledge and information of participant is not required to exceed that which is normally possessed by a prudent person in the ordinary course of business dealings.

i. Except for transactions authorized under paragraph e of these instructions, if a participant in a covered transaction knowingly enters into a lower tier covered transaction with a person who is suspended, debarred, ineligible, or voluntarily excluded from participation in this transaction, in addition to other remedies available to the Federal Government, the department or agency with which this transaction originated may pursue available remedies, including suspension and/or debarment.

* * * * *

Certification Regarding Debarment, Suspension, Ineligibility and Voluntary Exclusion--Lower Tier Participants:

1. The prospective lower tier participant certifies, by submission of this proposal, that neither it nor its principals is presently debarred, suspended, proposed for debarment, declared ineligible, or voluntarily excluded from participating in covered transactions by any Federal department or agency.

2. Where the prospective lower tier participant is unable to certify to any of the statements in this certification, such prospective participant shall attach an explanation to this proposal.

* * * * *

XI. CERTIFICATION REGARDING USE OF CONTRACT FUNDS FOR LOBBYING

This provision is applicable to all Federal-aid construction contracts and to all related subcontracts which exceed \$100,000 (49 CFR 20).

1. The prospective participant certifies, by signing and submitting this bid or proposal, to the best of his or her knowledge and belief, that:

a. No Federal appropriated funds have been paid or will be paid, by or on behalf of the undersigned, to any person for influencing or attempting to influence an officer or employee of any Federal agency, a Member of Congress, an officer or employee of Congress, or an employee of a Member of Congress in connection with the awarding of any Federal contract, the making of any Federal grant, the making of any Federal loan, the entering into of any cooperative agreement, and the extension, continuation, renewal, amendment, or modification of any Federal contract, grant, loan, or cooperative agreement.

b. If any funds other than Federal appropriated funds have been paid or will be paid to any person for influencing or attempting to influence an officer or employee of any Federal agency, a Member of Congress, an officer or employee of Congress, or an employee of a Member of Congress in connection with this Federal contract, grant, loan, or cooperative agreement, the undersigned shall complete and submit Standard Form-LLL, "Disclosure Form to Report Lobbying," in accordance with its instructions.

2. This certification is a material representation of fact upon which reliance was placed when this transaction was made or entered into. Submission of this certification is a prerequisite for making or entering into this transaction imposed by 31 U.S.C. 1352. Any person who fails to file the required certification shall be subject to a civil penalty of not less than \$10,000 and not more than \$100,000 for each such failure.

3. The prospective participant also agrees by submitting its bid or proposal that the participant shall require that the language of this certification be included in all lower tier subcontracts, which exceed \$100,000 and that all such recipients shall certify and disclose accordingly.

Contract Provision - Cargo Preference Requirements

In accordance with Title 46 CFR § 381.7 (b), the contractor agrees—

“(1) To utilize privately owned United States-flag commercial vessels to ship at least 50 percent of the gross tonnage (computed separately for dry bulk carriers, dry cargo liners, and tankers) involved, whenever shipping any equipment, material, or commodities pursuant to this contract, to the extent such vessels are available at fair and reasonable rates for United States-flag commercial vessels.

(2) To furnish within 20 days following the date of loading for shipments originating within the United States or within 30 working days following the date of loading for shipments originating outside the United States, a legible copy of a rated, ‘on-board’ commercial ocean bill-of-lading in English for each shipment of cargo described in paragraph (b) (1) of this section to both the Contracting Officer (through the prime contractor in the case of subcontractor bills-of-lading) and to the Division of National Cargo, Office of Market Development, Maritime Administration, Washington, DC 20590.

(3) To insert the substance of the provisions of this clause in all subcontracts issued pursuant to this contract.”

Provisions (1) and (2) apply to materials or equipment that are acquired solely for the project. The two provisions do not apply to goods or materials that come into inventories independent of the project, such as shipments of Portland cement, asphalt cement, or aggregates, when industry suppliers and contractors use these materials to replenish existing inventories.

**MINIMUM WAGES FOR FEDERAL AND FEDERALLY
ASSISTED CONSTRUCTION CONTRACTS**

This project is funded, in part, with Federal-aid funds and, as such, is subject to the provisions of the Davis-Bacon Act of March 3, 1931, as amended (46 Sta. 1494, as amended, 40 U.S.C. 276a) and of other Federal statutes referred to in a 29 CFR Part 1, Appendix A, as well as such additional statutes as may from time to time be enacted containing provisions for the payment of wages determined to be prevailing by the Secretary of Labor in accordance with the Davis-Bacon Act and pursuant to the provisions of 29 CFR Part 1. The prevailing rates and fringe benefits shown in the General Wage Determination Decisions issued by the U.S. Department of Labor shall, in accordance with the provisions of the foregoing statutes, constitute the minimum wages payable on Federal and federally assisted construction projects to laborers and mechanics of the specified classes engaged on contract work of the character and in the localities described therein.

General Wage Determination Decisions, modifications and supersedes decisions thereto are to be used in accordance with the provisions of 29 CFR Parts 1 and 5. Accordingly, the applicable decision, together with any modifications issued, must be made a part of every contract for performance of the described work within the geographic area indicated as required by an applicable DBRA Federal prevailing wage law and 29 CFR Part 5. The wage rates and fringe benefits contained in the General Wage Determination Decision shall be the minimum paid by contractors and subcontractors to laborers and mechanics.