

CONNECTION DETAIL A
NOT TO SCALE

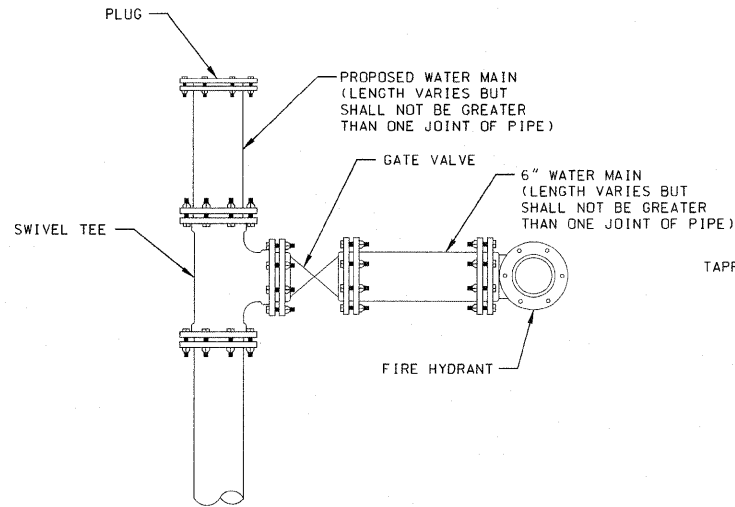

CONNECTION DETAIL B
NOT TO SCALE

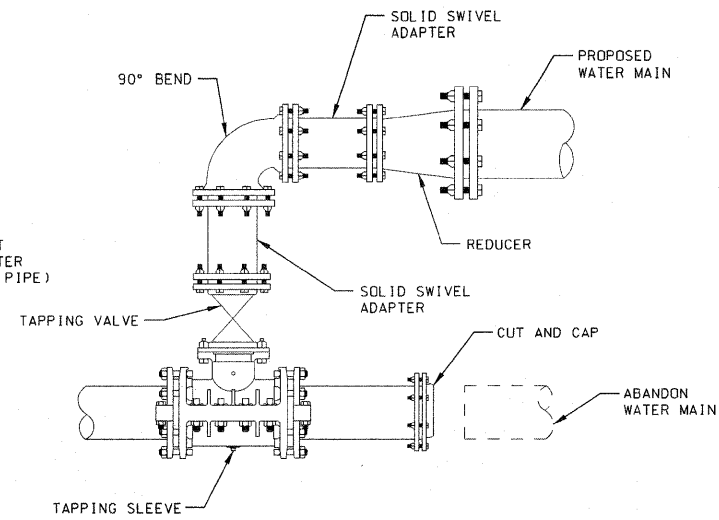

CONNECTION DETAIL C
NOT TO SCALE

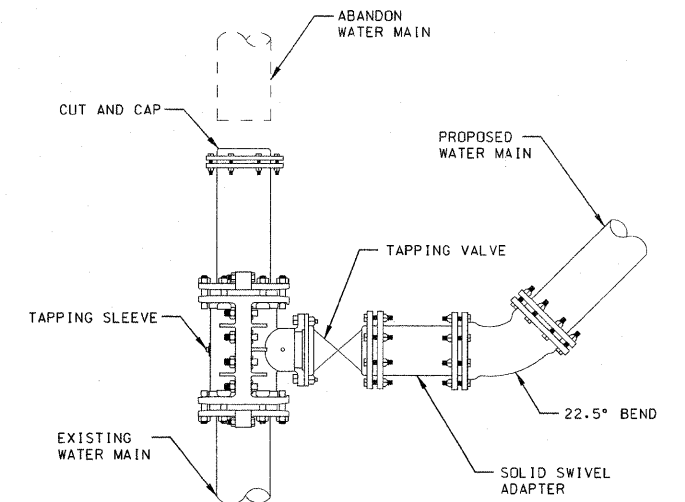

CONNECTION DETAIL H
NOT TO SCALE

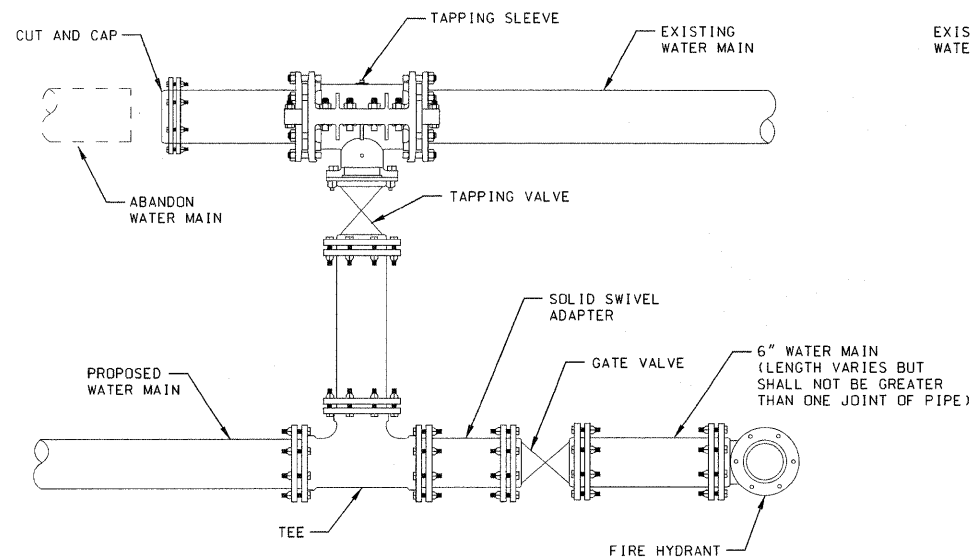

CONNECTION DETAIL D
NOT TO SCALE

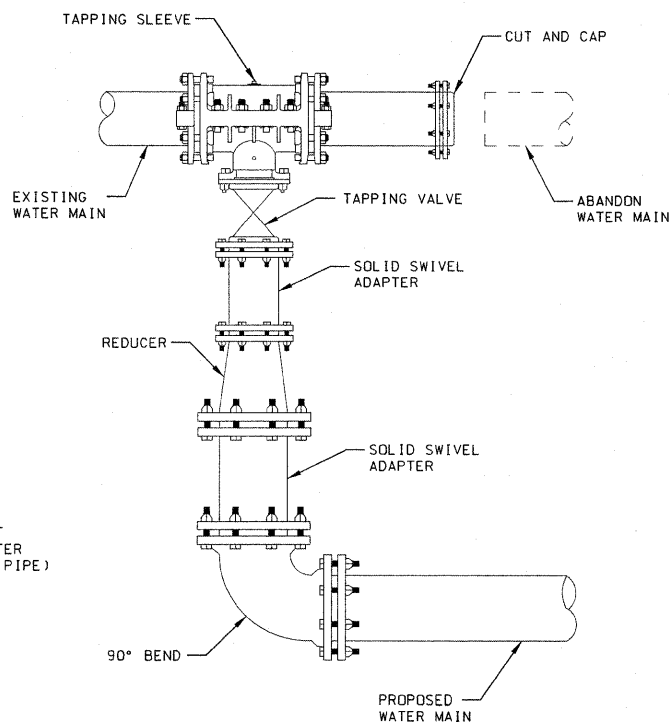

CONNECTION DETAIL E
NOT TO SCALE

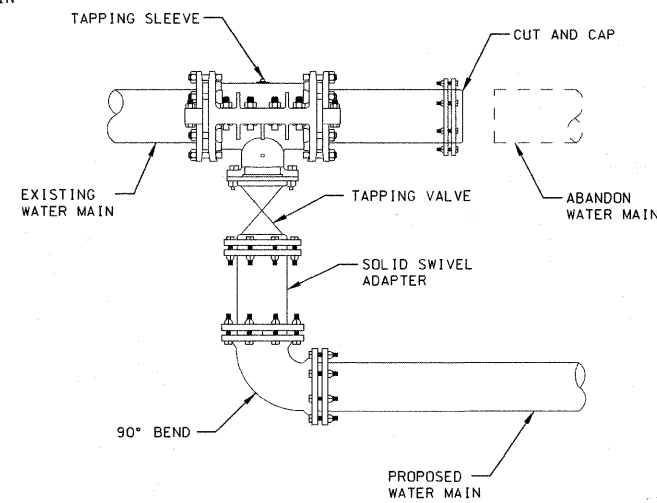

CONNECTION DETAIL F
NOT TO SCALE

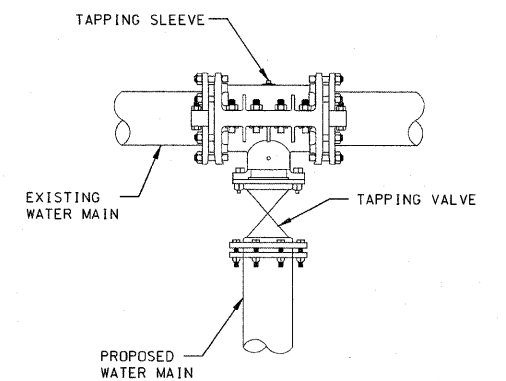

CONNECTION DETAIL G
NOT TO SCALE

NOTES:

HYDRANTS ARE TO BE SET ON 6" LATERALS. ISOLATED BY A GATE VALVE WITH BOX, AND RESTRAINED WITH SET SCREW RETAINER GLANDS, AND CONCRETE THRUST BLOCKS.

FIRE HYDRANT ASSEMBLY TO INCLUDE 6" GATE VALVE, VALVE BOX, 6" LEAD PIPE, AND 6" FIRE HYDRANT.

LINE ENDS ARE TO BE CAPPED WITH MECHANICAL JOINT CAP AND A SET SCREW RETAINER GLAND, LESS THAN ONE LENGTH OF PIPE PAST THE GATE VALVE OR TAPPING SLEEVE.

ALL VALVES AND FITTINGS SUCH AS TEES, CROSSES, REDUCERS, ELBOWS, CAPS, PLUGS, ETC., SHALL BE DUCTILE IRON WITH MECHANICAL JOINTS AND INCLUDE TRANSITION GASKETS, AND THEY SHALL BE RESTRAINED WITH SET SCREW RETAINER GLANDS AND CONCRETE THRUST BLOCKS.

FILE NAME = #FILEL#	USER NAME = #USER#	DESIGNED -	REVISED -	STATE OF ILLINOIS DEPARTMENT OF TRANSPORTATION	WATER MAIN CONNECTION DETAILS			F.A.P. RTE.	SECTION	COUNTY	TOTAL SHEETS	SHEET NO.	
	PLOT SCALE = #SCALE#	DRAWN -	REVISED -		SCALE:	SHEET NO. 1 OF 4 SHEETS	STA	TO STA	600	60-(30,31,128)-1		399	134
	PLOT DATE = #DATE#	CHECKED -	REVISED -										
		DATE -	REVISED -						FED. ROAD DIST. NO.	ILLINOIS FED. AID PROJECT			CONTRACT NO. 76830