

VIEW B-B

22'-0"

16'-0" MIN. PAINT LIMITS - PAINT ALL SURFACES

3'-4 1/16"

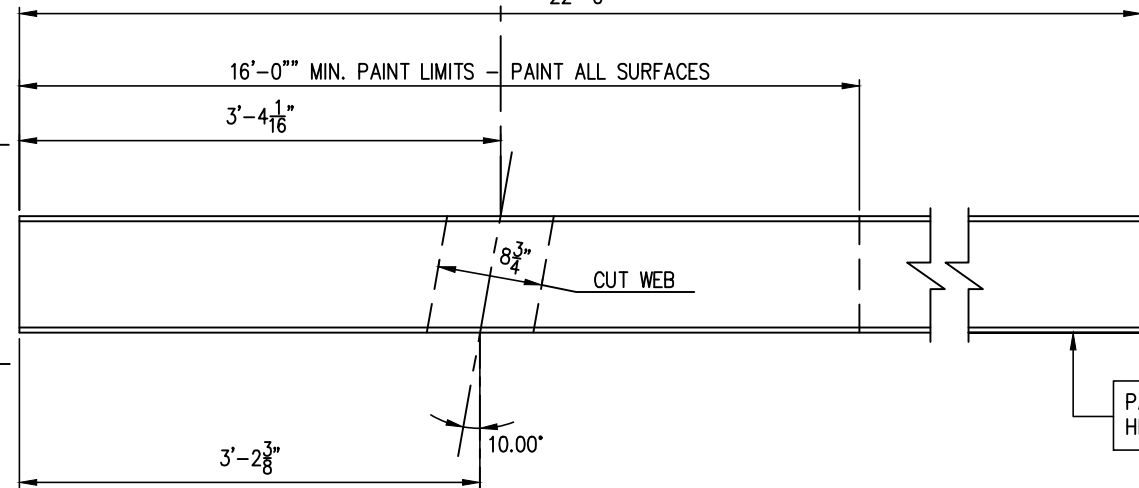

PAINT PILE MARK  
HERE THIS FLANGE

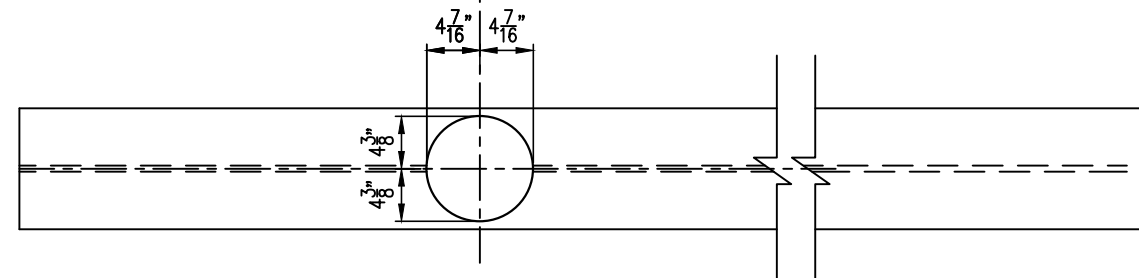

VIEW A-A

HP10 x 42 PILE - MARK P20  
STR 050-8802

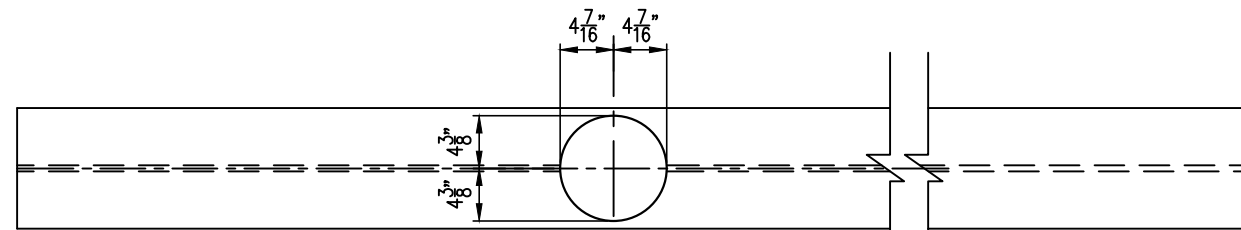

VIEW B-B

LENGTH

MIN. PAINT LIMITS - PAINT ALL SURFACES

4'-1 11/16"

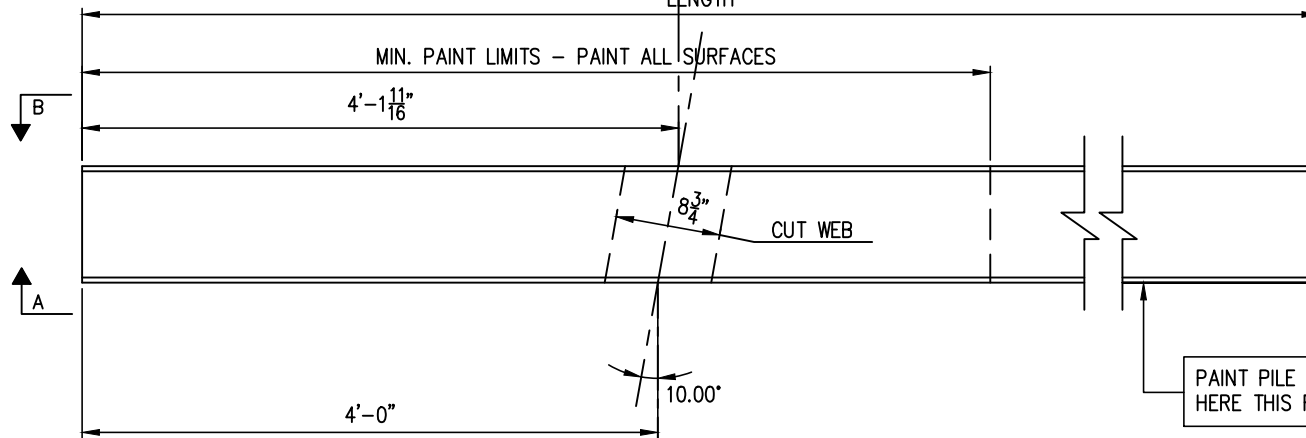

PAINT PILE MARK  
HERE THIS FLANGE

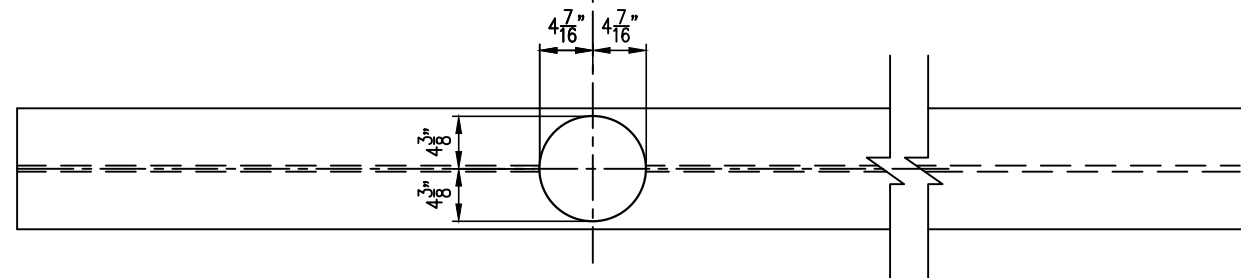

VIEW A-A

HP10 x 42 PILES  
STR 050-8802

PILE MARK	LENGTH		MIN. PAINT LIMIT
	FT.	IN.	
P19	22	9	17'-0"
P21	20	11	15'-0"



**FOR INFORMATION ONLY**

SEE DRAWING # 1 FOR SLEEVE FIT UP AND WELD DETAILS

**FOR APPROVAL**  
4/23/19

TRIAD METALS INTERNATIONAL 3480 GRAND AVE. PITTSBURGH, PA 15225				
PROJECT: RAUSCH INFRASTRUCTURE LLC ILLINOIS DEPARTMENT OF TRANSPORTATION IDOT #20 PERU, IL 1-80 SLOPE STABILIZATION DETAIL(S): SOLDIER PILE WALL				
PREPARED BY	DATE	CHECKED BY	DATE	DWG SCALE
RLP	4/19/19	NB	4/22/19	N/T/S
REV.	DESCRIPTION	DATE	BY	CHK'D
WORK ORDER #: XXXXXX			DWG. #: 6	REV. 6

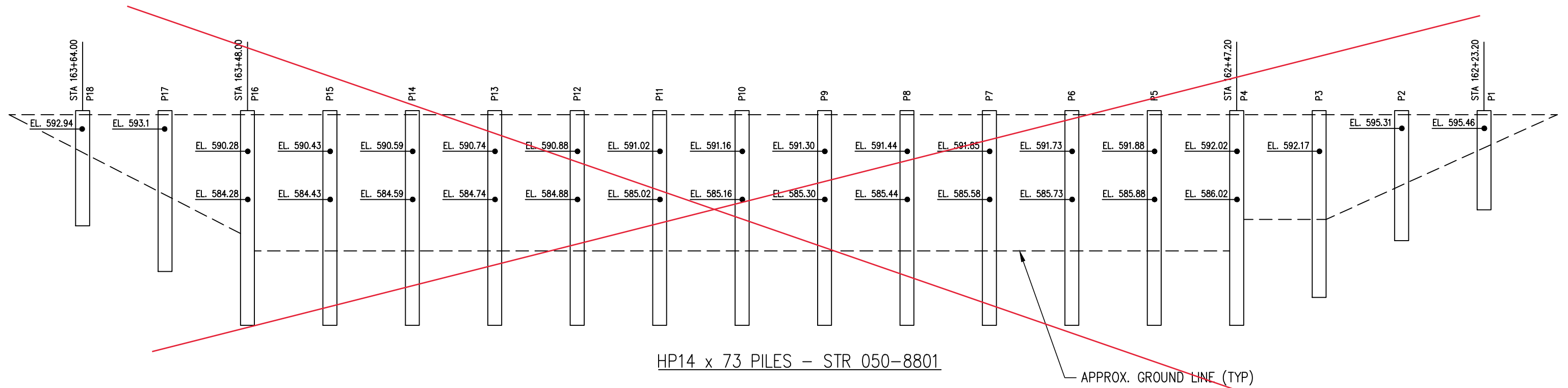

**FOR INFORMATION ONLY**

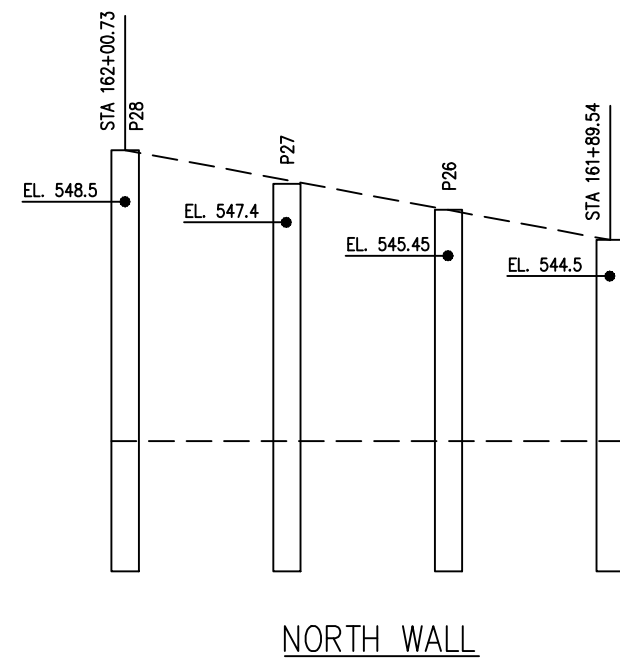
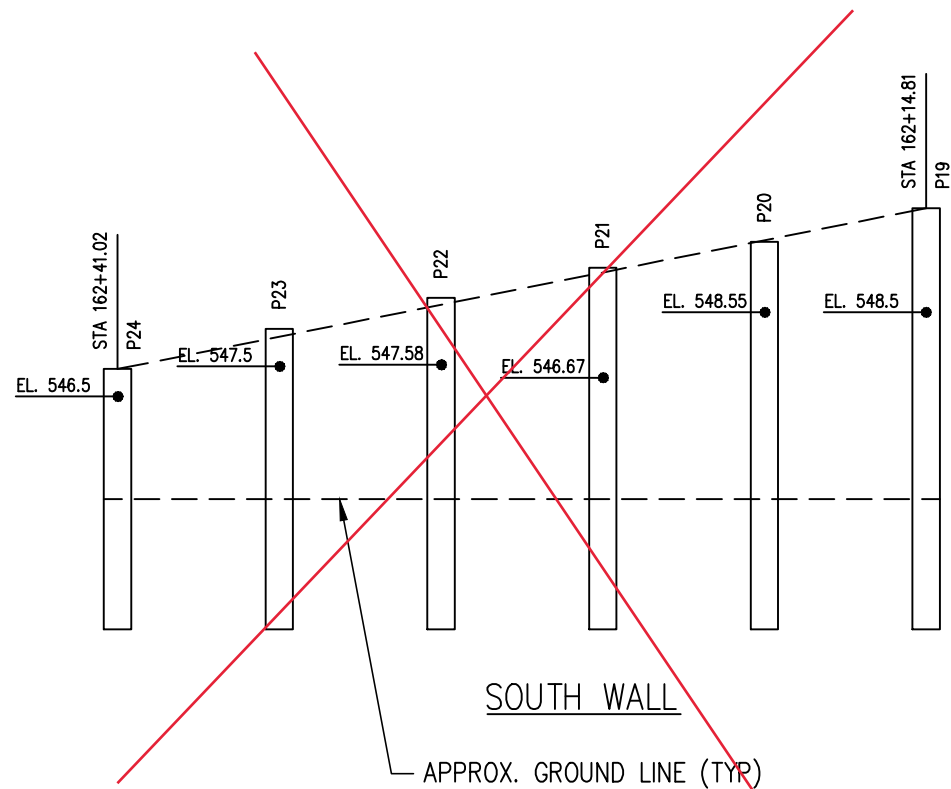

**FOR APPROVAL**  
4/23/19



HP10 x 42 PILES - STR 050-8802

REV.	DESCRIPTION	DATE	BY	CHK'D

PREPARED BY	DATE	CHECKED BY	DATE	DWG SCALE
RLP	4/19/19	NB	4/22/19	N/T/S

WORK ORDER #:	XXXXXX	DWG. #:	E1	REV.	△
---------------	--------	---------	----	------	---

TRIAD METALS INTERNATIONAL  
3480 GRAND AVE.  
PITTSBURGH, PA 15225

PROJECT: RAUSCH INFRASTRUCTURE LLC  
ILLINOIS DEPARTMENT OF TRANSPORTATION  
IDOT #20 PERU, IL  
1-80 SLOPE STABILIZATION  
DETAIL(S): SOLDIER PILE WALL