

STATE OF ILLINOIS
DEPARTMENT OF TRANSPORTATION

F.A.S. RTE.	SECTION	COUNTY	TOTAL SHEETS	SHEET NO.
723	(16,17)RS-8	MONTGOMERY	30	1
		ILLINOIS	CONTRACT NO. 72L91	

FOR INDEX OF SHEETS, SEE SHEET NO.

HIGHWAY CLASSIFICATION

FAS 723 (NOKOMIS BLACKTOP)
ADT - 946 (2015)
PROJECTED ADT - 1,155 (2036)
DESIGN SPEED - 55 MPH
POSTED SPEED - 55 MPH
CLASSIFICATION - MAJOR COLLECTOR
CRS - 6.5 (2019)
PV = 81.12%
SV = 9.24%
MU = 8.64%

PROPOSED
HIGHWAY PLANS

FAS ROUTE 723 (NOKOMIS BLACKTOP)
SECTION (16,17) RS-8
PROJECT STP-SXYW(165)
RESURFACING - SINGLE PASS MICROSURFACE
MONTGOMERY COUNTY

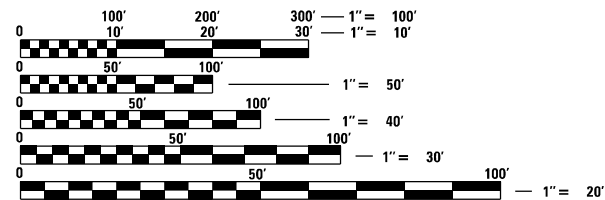
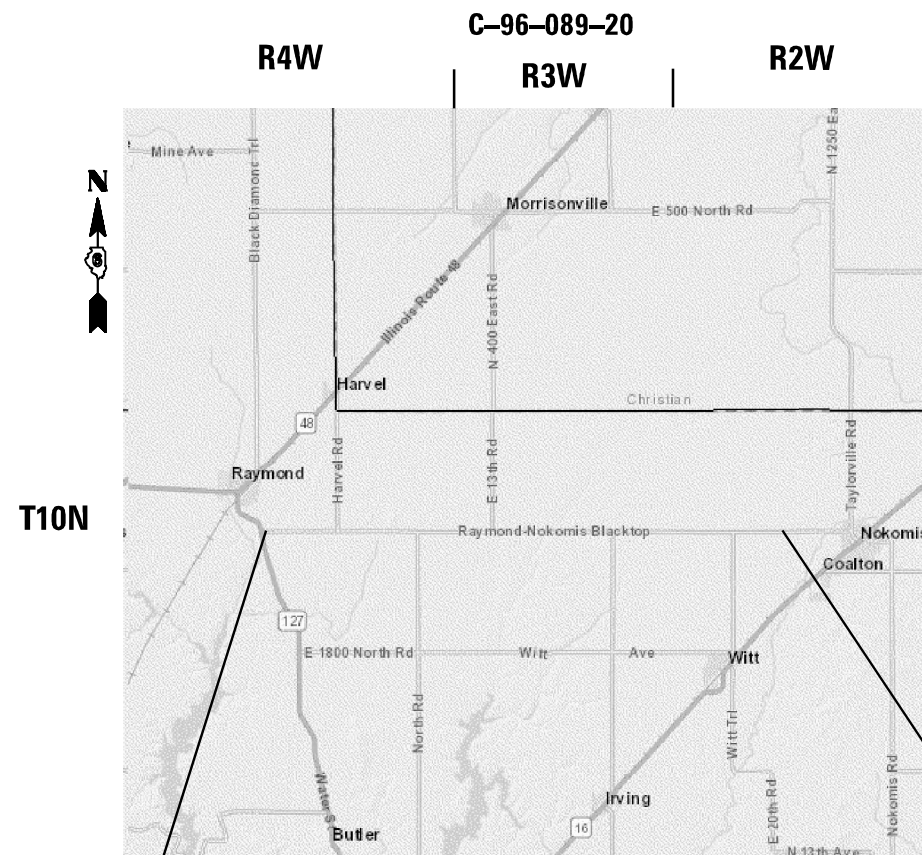
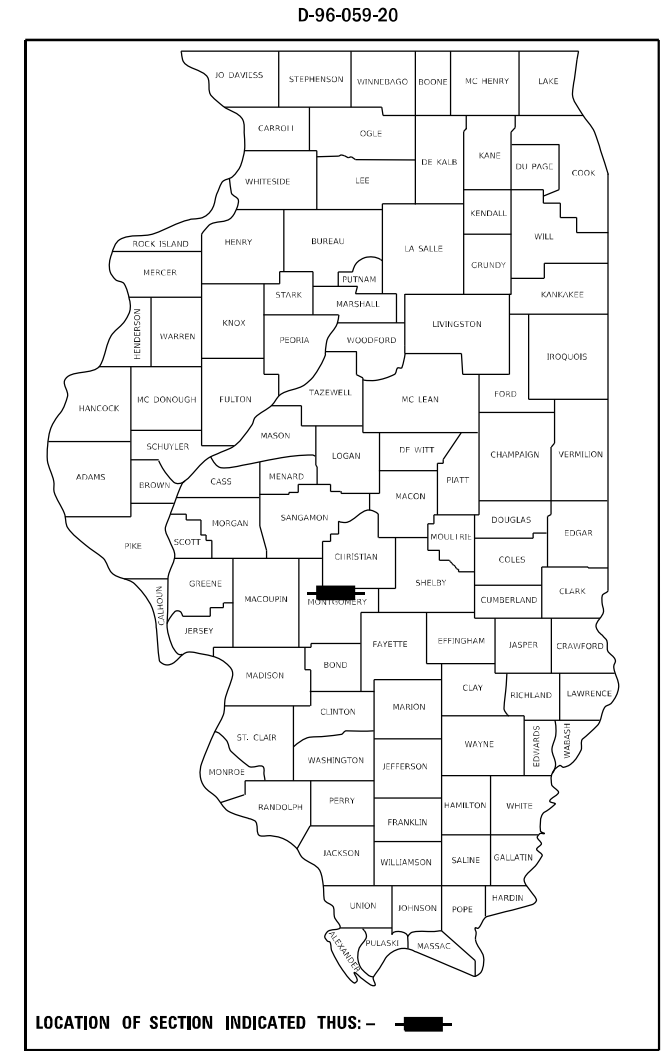

FULL SIZE PLANS HAVE BEEN PREPARED USING STANDARD ENGINEERING SCALES. REDUCED SIZED PLANS WILL NOT CONFORM TO STANDARD SCALES. IN MAKING MEASUREMENTS ON REDUCED PLANS, THE ABOVE SCALES MAY BE USED.

J.U.L.I.E.
JOINT UTILITY LOCATION INFORMATION FOR EXCAVATORS
1-800-892-0123
OR 811

LIMITS OF PAVING
IMPROVEMENT ENDS AT
STA. 5+09
NOKOMIS BLACKTOP

LIMITS OF PAVING
IMPROVEMENT STARTS AT
STA. 697+33
NOKOMIS BLACKTOP

PROJECT ENGINEER: JAY EDWARDS (217) 785-0597
PROJECT MANAGER: JONATHAN COX (217) 782-1378

GROSS LENGTH = 69224 FT. = 13.11 MILE
NET LENGTH = 69224 FT. = 13.11 MILE

CONTRACT NO. 72L91

STATE OF ILLINOIS
DEPARTMENT OF TRANSPORTATION

SUBMITTED December 10 20 20

Jay P. Myers
REGIONAL ENGINEER

January 29, 2021
Scott A. Clark
ENGINEER OF DESIGN AND ENVIRONMENT

January 29, 2021
James J. Jan
DIRECTOR OF HIGHWAYS PROJECT IMPLEMENTATION 13

PRINTED BY THE AUTHORITY
OF THE STATE OF ILLINOIS

STANDARDS

- 000001-08 STANDARD SYMBOLS, ABBREVIATIONS, AND PATTERNS
- 701301-04 LANE CLOSURE, 2L, 2W, SHORT TIME OPERATIONS
- 701306-04 LANE CLOSURE, 2L, 2W, SLOW MOVING OPERATIONS, DAY ONLY, FOR SPEEDS ≥ 45 MPH
- 701311-03 LANE CLOSURE, 2L, 2W, MOVING OPERATIONS, DAY ONLY
- 701901-08 TRAFFIC CONTROL DEVICES
- 780001-05 TYPICAL PAVEMENT MARKINGS
- 781001-04 TYPICAL APPLICATIONS RAISED REFLECTIVE PAVEMENT MARKERS

INDEX OF SHEETS

- 1 COVER SHEET
- 2 INDEX OF SHEETS, LISTS OF STANDARDS, GENERAL NOTES AND COMMITMENTS
- 3 SUMMARY OF QUANTITIES
- 4 SCHEDULE OF QUANTITIES
- 5-6 TYPICAL SECTIONS (2)
- 7-30 PLAN SHEETS (24)

GENERAL NOTES



- 1 "NO PASSING ZONES" TO BE FIELD VERIFIED BY THE BUREAU OF OPERATIONS, THE RESIDENT ENGINEER SHALL NOTIFY THE BUREAU OF OPERATIONS AT LEAST 14 DAYS PRIOR TO PLACEMENT OF FINAL PERMANENT MARKING. (PH: 217-785-5312)
- 2 MIXTURE FOR CRACKS, JOINTS, & FLANGWAYS SHALL BE USED TO FILL IN THE VOID LEFT BY THE RAISED REFLECTIVE PAVEMENT MARKER REMOVAL. THE VOID SHALL BE FILLED BEFORE THE PLACEMENT OF MICROSURFACE APPLICATION.
- 3 AS PER THE BDE SPECIAL PROVISION FOR MICRO-SURFACING AND SLURRY SEALING , RAISED REFLECTIVE PAVEMENT MARKERS SHALL BE REMOVED ACCORDING TO ARTICLE 783.03(B) AND HOLES FILLED WITH HMA, RUT FILLING MIX, OR OTHER MATERIAL APPROVED BY THE ENGINEER. THIS SHALL NOT BE PAID FOR SEPARATELY, BUT CONSIDERED AS PART OF THE WORK FOR MICRO SURFACING SINGLE PASS.

RATE TABLE

THE FOLLOWING RATES OF APPLICATION HAVE BEEN ASSUMED IN CALCULATING PLAN QUANTITIES.
 BITUMINOUS MATERIALS (TACK COAT): 0.025 LBS/SQ FT (HMA LIFTS)

COMMITMENTS

NONE

STATE OF ILLINOIS DEPARTMENT OF TRANSPORTATION DIVISION OF HIGHWAYS DISTRICT 6	
EXAMINED	November 23 20 20
	
ENGINEER OF OPERATIONS	
EXAMINED	November 25 20 20
	
ENGINEER OF PROJECT IMPLEMENTATION	
EXAMINED	November 25 20 20
	
ENGINEER OF PROGRAM DEVELOPMENT	

MODEL: Default
 FILE: \\nlsr-pub\pubroom\data\illinois.gov\PWIDOT\Documents\DOT_Offices\District_6\Projects\0672191\CADD\data\CAD\Sheets\0672191-2-ht-999999.dgn

	USER NAME = coxjw PLOT SCALE = 100.0000' / in. PLOT DATE = 12/1/2020	DESIGNED - BNB DRAWN - CHECKED - DATE -	REVISED - REVISED - REVISED - REVISED -	STATE OF ILLINOIS DEPARTMENT OF TRANSPORTATION	INDEX OF SHEETS, GENERAL NOTES, RATE TABLE, & COMMITMENTS	F.A.S. RTE. 723 SECTION (16,17) RS-8 COUNTY MONTGOMERY TOTAL SHEETS 30 SHEET NO. 2 CONTRACT NO. 72L91	ILLINOIS FED. AID PROJECT
SCALE:					SHEET 1 OF 1 SHEETS STA. TO STA.		

6-01216-0000
 80% FEDERAL
 20% STATE
 ROADWAY
 0005
 RURAL

CODE NO.	ITEM	UNIT	TOTAL QUANTITY	
40400118	MICRO-SURFACING, SINGLE PASS	SQ YD	171960	171960
40600290	BITUMINOUS MATERIALS (TACK COAT)	POUND	38691	38691
67000400	ENGINEER'S FIELD OFFICE, TYPE A	CAL MO	6	6
67100100	MOBILIZATION	L SUM	1	1
70100460	TRAFFIC CONTROL AND PROTECTION, STANDARD 701306	L SUM	1	1
70300100	SHORT TERM PAVEMENT MARKING	FOOT	13845	13845
70300150	SHORT TERM PAVEMENT MARKING REMOVAL	SQ FT	4615	4615
* 78001120	PAINT PAVEMENT MARKING - LINE 5"	FOOT	162261	162261
* 78100100	RAISED REFLECTIVE PAVEMENT MARKER	EACH	871	871
Ø Z0076600	TRAINEES	HOUR	500	500
Ø 78300200	RAISED REFLECTIVE PAVEMENT MARKER REMOVAL	EACH	871	871
Ø Z0076604	TRAINEES TRAINING PROGRAM GRADUATE	HOUR	500	500
X0327979	PAVEMENT MARKING REMOVAL - GRINDING	SQ FT	67609	67609

* SPECIALTY ITEM

Ø 0042

REV. - MS

MODEL: Default
 FILE NAME: p:\pjancom.dct\illinois.gov\PWIDOT\Documents\DOT_Offices\District_8\Projects\0672191\CAD\data\CAD\sheet\0672191.rpt-500.dgn

USER NAME = coxjw	DESIGNED -	REVISED -
	DRAWN -	REVISED -
PLOT SCALE = 100.0000' / in.	CHECKED -	REVISED -
PLOT DATE = 12/10/2020	DATE -	REVISED -

STATE OF ILLINOIS
 DEPARTMENT OF TRANSPORTATION

SUMMARY OF QUANTITIES

SCALE: SHEET OF SHEETS STA. TO STA.

F.A.S. RTE.	SECTION	COUNTY	TOTAL SHEETS	SHEET NO.
723	(16.17) RS-8	MONTGOMERY	30	3
			CONTRACT NO. 72L91	
ILLINOIS FED. AID PROJECT				

MICRO-SURFACING, SINGLE PASS, SIDE ROADS								40400118	40600290
Station	ROAD NAME	Side	Type	WIDTH (FOOT)	LENGTH 1 (EOP) (FOOT)	LENGTH 2 (FOOT)	AREA (SQ FT)	MICRO-SURFACING, SINGLE PASS (SQ YD)	BITUMINOUS MATERIAL (TACK COAT) (POUND)
FAS 723 (NOKOMIS BLACKTOP)									
54+22	Well Lane	LT	AGG	22	35	12	517		
54+29	E 8TH RD	RT	HMA	24	56	17	876	97.3	21.90
107+26	HARVEL RD	RT	HMA	31	60	18	1209	134.3	30.23
		LT		11	58	35	511.5	56.8	12.79
160+30	E 10TH RD	RT	HMA	8	50	23	292	32.4	7.30
		LT		17	56	17	620.5	68.9	15.51
213+40	N RD	RT	HMA	12	77	49	756	84.0	18.90
		LT		18	56	29	765	85.0	19.13
262+61	E 12TH RD	RT	HMA	22	44	14	638	70.9	15.95
		LT		5	50	29	197.5	21.9	4.94
312+65	E 13TH RD	RT	HMA	14	62	30	644	71.6	16.10
		LT		9	52	21	328.5	36.5	8.21
366+16	E 14TH RD	RT	HMA	9	54	32	387	43.0	9.68
		LT		21	53	22	787.5	87.5	19.69
419+24	E 15TH RD	RT	HMA	26	54	20	962	106.9	24.05
		LT		17	61	23	714	79.3	17.85
472+52	E 16TH RD	RT	HMA	25	83	37	1500	166.7	37.5
		LT		26	62	21	1079	119.9	26.975
525+69	E 17TH RD	RT	HMA	10	52	29	405	45.0	10.125
		LT		32	50	23	1168	129.8	29.2
579+31	E 18TH RD	RT	HMA	11	50	26	418	46.4	10.45
		LT		10	50	29	395	43.9	9.875
632+21	E 19TH RD	RT	HMA	10	76	58	670	74.4	16.75
		LT		30	78	24	1530	170.0	38.25
685+14	E 20TH RD	LT	HMA	20	45	20	650	72.2	16.25
685+29	E 20TH RD	RT	HMA	10	52	28	400	44.4	10
SUBTOTAL								1989	448

MICRO-SURFACING, SINGLE PASS						40400118	40600290
LOCATION	LENGTH (FOOT)	WIDTH (FOOT)	MICRO-SURFACING, SINGLE PASS (SQ YD)	BITUMINOUS MATERIAL (TACK COAT) (POUND)			
FAS 723 (NOKOMIS BLACKTOP)							
5+09.00	TO	407+50.00	40241	22	98366.89	22132.55	
407+50.00	TO	411+75.00	425	30	1416.67	318.75	
411+75.00	TO	412+67.00	92	30	306.67	69.00	
412+67.00	TO	416+00.00	333	30	1110.00	249.75	
416+00.00	TO	697+33.00	28133	22	68769.56	15473.15	
HMA ENTRANCES & SIDEROADS SUBTOTAL						1989	448
TOTAL						171960	38691

SHORT TERM PAVEMENT MARKING				70300100	70300150
LOCATION	LENGTH (FOOT)	SHORT TERM PAVT MK (FOOT)	SHT TERM PAVT MK REM (SQ FT)		
FAS 723 (NOKOMIS BLACKTOP)					
HMA LIFT					
5+09.00	TO	697+33.00	69224.00	6922.40	2307.47
SECOND APPLICATION					
5+09.00	TO	697+33.00	69224.00	6922.40	2307.47
TOTAL				13845	4615

RAISED REFLECTIVE PAVEMENT MARKING					78100100	78300200
LOCATION	LENGTH (FOOT)	WIDTH (FOOT)	RAISED REFL PM REMOV (EACH)	RAISED REFL PAVT MK (EACH)		
FAS 723 (NOKOMIS BLACKTOP)						
5+09.00	TO	407+50.00	40241	22	504.01	504.01
407+50.00	TO	411+75.00	425	30	6.31	6.31
411+75.00	TO	412+67.00	92	30	2.15	2.15
412+67.00	TO	416+00.00	333	30	5.16	5.16
416+00.00	TO	697+33.00	28133	22	352.66	352.66
TOTAL					871	871

PAVEMENT MARKING SCHEDULE					78001120	78300201
LOCATION	SIDE	TYPE	PAINT PAVEMENT MARKING 5" (FOOT)		PAVT. MK. REM. GRIND (SQ FT)	
			WHITE	YELLOW		
FAS 723 (NOKOMIS BLACKTOP)						
5+09.00	TO	697+33.00	BOTH	SKIP DASH	17306	7211
5+09.00	TO	697+33.00	BOTH	EDGE LINE	138448	57687
6+50.00	TO	15+36.00	RT	NO PASS ZONE	886	369
17+17.00	TO	24+81.00	LT	NO PASS ZONE	764	318
25+44.00	TO	34+75.00	RT	NO PASS ZONE	931	388
36+36.00	TO	45+74.00	LT	NO PASS ZONE	938	391
170+72.00	TO	177+98.00	RT	NO PASS ZONE	726	303
180+16.00	TO	188+35.00	LT	NO PASS ZONE	819	341
296+29.00	TO	304+71.00	RT	NO PASS ZONE	842	351
307+70.00	TO	313+24.00	LT	NO PASS ZONE	554	231
432+86.00	TO	441+30.00	RT	NO PASS ZONE	844	352
443+93.00	TO	450+37.00	LT	NO PASS ZONE	644	268
DEDUCTION FOR SR				EDGE LINE	-1441	-600
SUBTOTALS					137007	67609
TOTAL					162261	67609

MODEL: Default
 FILE: Model: Pavement.dwg
 PROJECT: 12/10/2020
 USER: coxjw
 DESIGNED: -
 DRAWN: -
 CHECKED: -
 DATE: -
 REVISED: -
 REVISED: -
 REVISED: -
 REVISED: -

STATE OF ILLINOIS
DEPARTMENT OF TRANSPORTATION

SCHEDULE OF QUANTITIES

SCALE: SHEET 1 OF 2 SHEETS STA. TO STA.

F.A.S. RTE.	SECTION	COUNTY	TOTAL SHEETS	SHEET NO.
723	(16,17) RS-8	MONTGOMERY	30	4
CONTRACT NO. 72L91				
ILLINOIS FED. AID PROJECT				

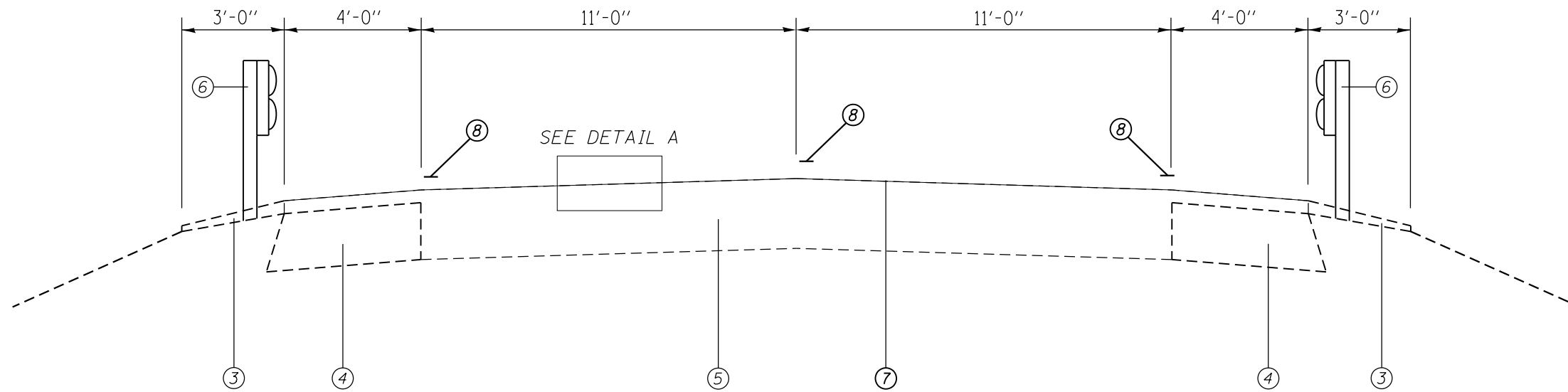

LEGEND

- ① EX. AGG. BASE
- ② EX. BITUMINOUS SURFACE
- ③ EX. AGG. SHOULDER
- ④ EX. BITUMINOUS CONC. BASE COURSE WIDENING 10"
- ⑤ EX. BITUMINOUS CONC. BASE COURSE, 10"
- ⑥ EX. GUARD RAIL
- ⑦ PR. MICROSURFACING, SINGLE PASS, 3/8"
- ⑧ PR. PAINT PAVEMENT MARKING, 5"

TYPICAL SECTION

(5) STA 411+75.00 TO STA 412+67.00 (SN 068-2506) (92')

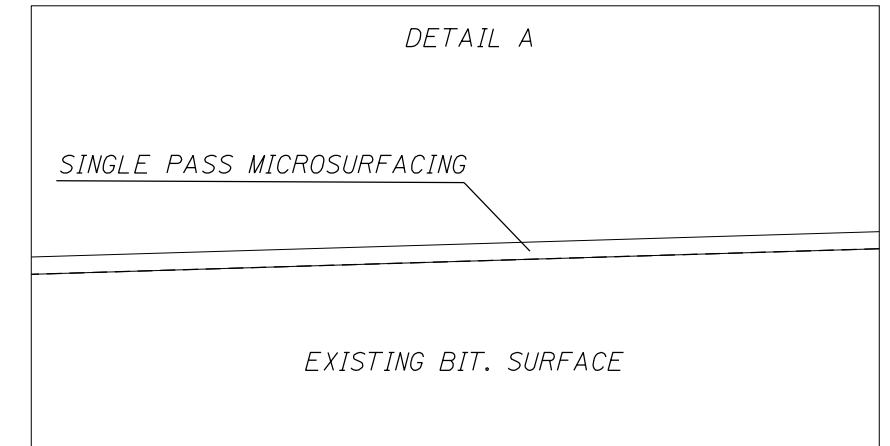

MODEL: Default
 FILE: \\nrcs-pub\pubroom\data\illinois.gov\PWIDOT\Documents\DOT_Offices\District_6\Projects\0672191\CAD\data\CAD\Sheets\0672191_rht\typical.dgn

USER NAME = coxjw	DESIGNED BNB	REVISED -
	DRAWN -	REVISED -
PLOT SCALE = 100.0000' / in.	CHECKED -	REVISED -
PLOT DATE = 12/10/2020	DATE -	REVISED -

**STATE OF ILLINOIS
DEPARTMENT OF TRANSPORTATION**

TYPICAL SECTIONS	
SCALE:	SHEET 2 OF 2 SHEETS STA. TO STA.

F.A.S. RTE.	SECTION	COUNTY	TOTAL SHEETS	SHEET NO.
723	(16,17) RS-8	MONTGOMERY	30	6
CONTRACT NO. 72L91				
ILLINOIS FED. AID PROJECT				

ALL ENTRANCES & SIDEROADS WILL ALSO GET
MICROSURFACE TREATMENT. SEE SCHEDULES
FOR INFORMATION.



POT Sta 5+14.66

POT Sta 15+00.00

LIMITS OF IMPROVEMENT
STA 5+09.00

PR SINGLE PASS MICROSURFACE

MATCHLINE STA.20+00.00



MATCHLINE STA.20+00.00

20+00

30+00

PR SINGLE PASS MICROSURFACE

MATCHLINE STA.35+00.00

MODEL: Default
FILE: \\nrcs-prod-planningroom.dta\illinois.gov\PI\DOT\Documents\DOT_Offices\District 6\Projects\0672191\CADD\Drawings\CAD\Sheets\0672191_ph-plan.dgn

USER NAME = c0xjw	DESIGNED -	REVISED -
	DRAWN -	REVISED -
PLOT SCALE = 100,0000' / in.	CHECKED -	REVISED -
PLOT DATE = 12/10/2020	DATE -	REVISED -

**STATE OF ILLINOIS
DEPARTMENT OF TRANSPORTATION**

PLAN SHEETS - NOKOMIS BLACKTOP

SCALE: 50 SHEET 1 OF 24 SHEETS STA. 5+09.00 TO STA. 35+00.00

F.A.S. RTE.	SECTION	COUNTY	TOTAL SHEETS	SHEET NO.
723	(16,17) RS-8	MONTGOMERY	30	7
CONTRACT NO. 72L91				
ILLINOIS FED. AID PROJECT				

ALL ENTRANCES & SIDEROADS WILL ALSO GET
MICROSURFACE TREATMENT. SEE SCHEDULES
FOR INFORMATION.



MATCHLINE STA. 35+00.00

MATCHLINE STA. 50+00.00

35+00 36 37 38 39 40+00 41 42 43 44 45+00 46 47 48 49

PR SINGLE PASS MICROSURFACE

MATCHLINE STA. 50+00.00

MATCHLINE STA. 65+00.00



STA 54+22 (NOKOMIS BLACKTOP)
STA 10+00 (E 8TH RD)

STA 54+29 (NOKOMIS BLACKTOP)
STA 10+00 (E 8TH RD)

PR SINGLE PASS MICROSURFACE

50+00 51 52 53 54 55+00 56 57 58 59 60+00 61 62 63 64

MODEL: Default
FILE: \\nls\p\pub\baronm.d\at\illinois.gov\PI\DOT\Documents\DOT_Offices\District 6\Projects\0672191\CADD\Drawings\0672191_ph-plan.dgn

USER NAME = coxjw	DESIGNED -	REVISED -
	DRAWN -	REVISED -
PLOT SCALE = 100,0000' / in.	CHECKED -	REVISED -
PLOT DATE = 12/10/2020	DATE -	REVISED -

**STATE OF ILLINOIS
DEPARTMENT OF TRANSPORTATION**

PLAN SHEETS - NOKOMIS BLACKTOP

SCALE: 50 SHEET 2 OF 24 SHEETS STA. 35+00.00 TO STA. 65+00.00

F.A.S. RTE.	SECTION	COUNTY	TOTAL SHEETS	SHEET NO.
723	(16,17) RS-8	MONTGOMERY	30	8
CONTRACT NO. 72L91				
ILLINOIS FED. AID PROJECT				

ALL ENTRANCES & SIDEROADS WILL ALSO GET
MICROSURFACE TREATMENT. SEE SCHEDULES
FOR INFORMATION.



MATCHLINE STA. 65+00.00

65+00 | 66 | 67 | 68 | 69 | 70+00 | 71 | 72 | 73 | 74 | 75+00 | 76 | 77 | 78 | 79

PR SINGLE PASS MICROSURFACE

MATCHLINE STA. 80+00.00

POT Sta 78+3.150

MATCHLINE STA. 80+00.00



80+00 | 81 | 82 | 83 | 84 | 85+00 | 86 | 87 | 88 | 89 | 90+00 | 91 | 92 | 93 | 94

PR SINGLE PASS MICROSURFACE

MATCHLINE STA. 95+00.00

POT Sta 95+00.00

MODEL: Default
FILE: \\blm\c:\pub\blm\room\dat\illinois\poc\RWIDOT\Documents\DOT_Offices\Director @ Projects\0672191\CADD\Drawings\CAD\Drawings\0672191_91-plan.dgn

USER NAME = coxjw	DESIGNED -	REVISED -
	DRAWN -	REVISED -
PLOT SCALE = 100,0000' / in.	CHECKED -	REVISED -
PLOT DATE = 12/10/2020	DATE -	REVISED -

**STATE OF ILLINOIS
DEPARTMENT OF TRANSPORTATION**

PLAN SHEETS - NOKOMIS BLACKTOP

SCALE: 50 SHEET 3 OF 24 SHEETS STA. 65+00.00 TO STA. 95+00.00

F.A.S. RTE.	SECTION	COUNTY	TOTAL SHEETS	SHEET NO.
723	(16,17) RS-8	MONTGOMERY	30	9
CONTRACT NO. 72L91				
ILLINOIS FED. AID PROJECT				

ALL ENTRANCES & SIDEROADS WILL ALSO GET
MICROSURFACE TREATMENT. SEE SCHEDULES
FOR INFORMATION.



MATCHLINE STA. 95+00.00

95+00 96 97 98 99 100+00 101 111 102 103 104 105+00 106 107+00 108 109

PR SINGLE PASS MICROSURFACE

POT Sta 11+44.13

POT Sta 10+00.00

STA 107+26 (NOKOMIS BLACKTOP)
STA 10+00 (HARVEL RD)

POT Sta 8+89.75

MATCHLINE STA. 110+00.00

MATCHLINE STA. 110+00.00



110+00 111 112 113 114 115+00 116 117 111 118 119 120+00 121 122 123 124

POT Sta 112+37.70

PR SINGLE PASS MICROSURFACE

MATCHLINE STA. 125+00.00

MODEL: Default
FILE: \\nrcs-prod\pub\arooms\data\illinois\pwr\DOT\Documents\DOT_Offices\Director @Projects\0672191\CAD\data\CAD\Sheets\0672191_ph-plan.dgn

USER NAME = c0xjw	DESIGNED -	REVISED -
	DRAWN -	REVISED -
PLOT SCALE = 100,0000' / in.	CHECKED -	REVISED -
PLOT DATE = 12/10/2020	DATE -	REVISED -

**STATE OF ILLINOIS
DEPARTMENT OF TRANSPORTATION**

PLAN SHEETS - NOKOMIS BLACKTOP

SCALE: 50 SHEET 4 OF 24 SHEETS STA. 95+00.00 TO STA. 125+00.00

F.A.S. RTE.	SECTION	COUNTY	TOTAL SHEETS	SHEET NO.
723	(16,17) RS-8	MONTGOMERY	30	10
CONTRACT NO. 72L91				
ILLINOIS FED. AID PROJECT				

ALL ENTRANCES & SIDEROADS WILL ALSO GET
MICROSURFACE TREATMENT. SEE SCHEDULES
FOR INFORMATION.

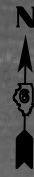

POT Sta 135+79.40

MATCHLINE STA. 125+00.00

125+00 126 127 128 129 130+00 131 132 133 11' 134 135+00 136 137 138 139

PR SINGLE PASS MICROSURFACE

MATCHLINE STA. 140+00.00

MATCHLINE STA. 140+00.00

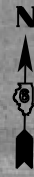

11'
11'

PR SINGLE PASS MICROSURFACE

140+00 141 142 143 144 145+00 146 147 148 149 150+00 151 152 153 154

MATCHLINE STA. 155+00.00

MODEL: Default
FILE: h:\a\c\p\pub\anroom.dwg; illinois.gov; PW\DOT\Documents\DOT_Offices\Director @ Projects\0672191_CAD\data\CAD\sheets\0672191_ph-plan.dgn

USER NAME = coxjw	DESIGNED -	REVISED -
	DRAWN -	REVISED -
PLOT SCALE = 100,0000' / in.	CHECKED -	REVISED -
PLOT DATE = 12/10/2020	DATE -	REVISED -

**STATE OF ILLINOIS
DEPARTMENT OF TRANSPORTATION**

PLAN SHEETS - NOKOMIS BLACKTOP

SCALE: 50 SHEET 5 OF 24 SHEETS STA. 125+00.00 TO STA. 155+00.00

F.A.S. RTE.	SECTION	COUNTY	TOTAL SHEETS	SHEET NO.
723	(16,17) RS-8	MONTGOMERY	30	11
CONTRACT NO. 72L91			ILLINOIS FED. AID PROJECT	

ALL ENTRANCES & SIDEROADS WILL ALSO GET
MICROSURFACE TREATMENT. SEE SCHEDULES
FOR INFORMATION.

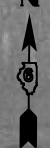

MATCHLINE STA. 155+00.00



MATCHLINE STA. 170+00.00

MATCHLINE STA. 170+00.00



MATCHLINE STA. 185+00.00

MODEL: Default
FILE: Model_C:\pub\baronm.dwg
PROJECTS\DOT\Office\185+00.00\185+00.00\185+00.00.dgn

USER NAME =	coxjw	DESIGNED -		REVISED -	
DRAWN -		REVISOR -		REVISOR -	
PLOT SCALE =	100.0000' / in.	CHECKED -		REVISOR -	
PLOT DATE =	12/10/2020	DATE -		REVISOR -	

**STATE OF ILLINOIS
DEPARTMENT OF TRANSPORTATION**

PLAN SHEETS - NOKOMIS BLACKTOP

SCALE: 50 SHEET 6 OF 24 SHEETS STA. 155+00.00 TO STA. 185+00.00

F.A.S. RTE.	SECTION	COUNTY	TOTAL SHEETS	SHEET NO.
723	(16,17) RS-8	MONTGOMERY	30	12
CONTRACT NO. 72L91				
ILLINOIS FED. AID PROJECT				

ALL ENTRANCES & SIDEROADS WILL ALSO GET
MICROSURFACE TREATMENT. SEE SCHEDULES
FOR INFORMATION.



MATCHLINE STA.185+00.00



MATCHLINE STA.200+00.00

MATCHLINE STA.200+00.00



MATCHLINE STA.215+00.00

MODEL: Default
FILE: \\nrc\p\pub\baronm.d\atl\links\pwr\WIDOT\Documents\DOT_Offices\lhartet_6\Projects\0672191\CADD\data\CAD\Sheets\0672191_ph-plan.dgn

USER NAME = coxjw	DESIGNED -	REVISED -
	DRAWN -	REVISED -
PLOT SCALE = 100,0000 ' / in.	CHECKED -	REVISED -
PLOT DATE = 12/10/2020	DATE -	REVISED -

**STATE OF ILLINOIS
DEPARTMENT OF TRANSPORTATION**

PLAN SHEETS - NOKOMIS BLACKTOP

SCALE: 50 SHEET 7 OF 24 SHEETS STA. 185+00.00 TO STA. 215+00.00

F.A.S. RTE.	SECTION	COUNTY	TOTAL SHEETS	SHEET NO.
723	(16,17) RS-8	MONTGOMERY	30	13
CONTRACT NO. 72L91				
ILLINOIS FED. AID PROJECT				

ALL ENTRANCES & SIDEROADS WILL ALSO GET
MICROSURFACE TREATMENT . SEE SCHEDULES
FOR INFORMATION.

EXIST. CURVE 20
PI STA. = 224+21.40
 Δ = 2° 00' 04" (LT)
D = 0° 06' 00"
R = 57,266.17'
T = 1,000.10'
L = 2,000.00'
E = 8.73'
e = _____
T.R. = _____
S.E. RUN = _____
P.C. STA. = 214+21.30
P.T. STA. = 234+21.30



MATCHLINE STA.215+00.00

MATCHLINE STA.230+00.00



MATCHLINE STA.230+00.00

MATCHLINE STA.245+00.00

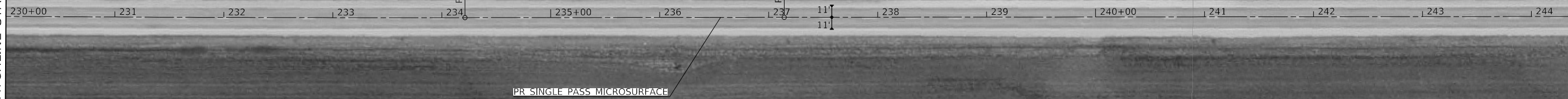

MODEL: Default
FILE: \h:\h:\p:\pub\h\room\da\illinois.gov\PI\DOT\Documents\DOT_Offices\District 6\Projects\0672191\CADD\data\CAD\Sheets\0672191_ph-plan.dgn

USER NAME = coxjw	DESIGNED -	REVISED -
	DRAWN -	REVISED -
PLOT SCALE = 100,0000' / in.	CHECKED -	REVISED -
PLOT DATE = 12/10/2020	DATE -	REVISED -

**STATE OF ILLINOIS
DEPARTMENT OF TRANSPORTATION**

PLAN SHEETS - NOKOMIS BLACKTOP

SCALE: 50 SHEET 8 OF 24 SHEETS STA. 215+00.00 TO STA. 245+00.00

F.A.S. RTE.	SECTION	COUNTY	TOTAL SHEETS	SHEET NO.
723	(16,17) RS-8	MONTGOMERY	30	14
CONTRACT NO. 72L91				
ILLINOIS FED. AID PROJECT				

ALL ENTRANCES & SIDEROADS WILL ALSO GET
MICROSURFACE TREATMENT. SEE SCHEDULES
FOR INFORMATION.



POT Sta 250+01.20

PR SINGLE PASS MICROSURFACE

MATCHLINE STA.245+00.00

MATCHLINE STA.260+00.00

245+00 246 247 248 249 250+00 251 252 11' 253 254 255+00 256 257 258 259



POT Sta 11+11.58

POT Sta 10+00.00

POT Sta 8+87.18

STA 266.65 (NOKOMIS BEAK COOP)
STA 10+00 (E 12TH RD)

PR SINGLE PASS MICROSURFACE

MATCHLINE STA.260+00.00

MATCHLINE STA.275+00.00

260+00 261 262 263 264 265+00 266 10' 267 268 269 11' 270+00 271 272 273 274

MODEL: Default
FILE: \\nrcs-pub\pubroom.dta\illinois.gov\PHWDOT\Documents\DOT_Offices\Director\Projects\0672191\CADD\Drawings\CAD\Drawings\0672191_ph-plan.dgn

USER NAME = coxjw	DESIGNED -	REVISED -
	DRAWN -	REVISED -
PLOT SCALE = 100,0000' / in.	CHECKED -	REVISED -
PLOT DATE = 12/10/2020	DATE -	REVISED -

**STATE OF ILLINOIS
DEPARTMENT OF TRANSPORTATION**

PLAN SHEETS - NOKOMIS BLACKTOP

SCALE: 50 SHEET 9 OF 24 SHEETS STA. 245+00.00 TO STA. 275+00.00

F.A.S. RTE.	SECTION	COUNTY	TOTAL SHEETS	SHEET NO.
723	(16,17) RS-8	MONTGOMERY	30	15
CONTRACT NO. 72L91				
ILLINOIS FED. AID PROJECT				

ALL ENTRANCES & SIDEROADS WILL ALSO GET
MICROSURFACE TREATMENT. SEE SCHEDULES
FOR INFORMATION.



MATCHLINE STA. 275+00.01

275+00 | 276 | 277 | 278 | 279 | 280+00 | 281 | 282 | 11' | 283 | 284 | 285+00 | 286 | 287 | 288 | 289

PR SINGLE PASS MICROSURFACE

POT Sta 288+00.00

MATCHLINE STA. 290+00.00

MATCHLINE STA. 290+00.00



290+00 | 291 | 292 | 293 | 294 | 295+00 | 296 | 11' | 297 | 298 | 299 | 300+00 | 301 | 302 | 303 | 304

PR SINGLE PASS MICROSURFACE

POT Sta 305+00.00

MATCHLINE STA. 305+00.00

MODEL: Default
FILE: \\nrcs-prod-planningroom.dta\illinois.gov\PI\DOT\Documents\DOT_Offices\Director\Projects\0672191_CAD\data\CAD\Sheets\0672191_ph-plan.dgn

USER NAME = coxjw	DESIGNED -	REVISED -
	DRAWN -	REVISED -
PLOT SCALE = 100,0000' / in.	CHECKED -	REVISED -
PLOT DATE = 12/10/2020	DATE -	REVISED -

**STATE OF ILLINOIS
DEPARTMENT OF TRANSPORTATION**

PLAN SHEETS - NOKOMIS BLACKTOP

SCALE: 50 SHEET 10 OF 24 SHEETS STA. 275+00.00 TO STA. 305+00.00

F.A.S. RTE.	SECTION	COUNTY	TOTAL SHEETS	SHEET NO.
723	(16,17) RS-8	MONTGOMERY	30	16
CONTRACT NO. 72L91			ILLINOIS FED. AID PROJECT	

ALL ENTRANCES & SIDEROADS WILL ALSO GET
MICROSURFACE TREATMENT. SEE SCHEDULES
FOR INFORMATION.



MATCHLINE STA. 305+00.00

MATCHLINE STA. 320+00.00



MATCHLINE STA. 320+00.00

MATCHLINE STA. 335+00.00



MODEL: Default
FILE: \\nrcs-prod\pub\baronm.d\at\illinois.gov\PI\DOT\Documents\DOT_Offices\District 6\Projects\0672191\CADD\DATA\CAD\Sheets\0672191_ph-plan.dgn

USER NAME = coxjw	DESIGNED -	REVISED -
	DRAWN -	REVISED -
PLOT SCALE = 100,0000' / in.	CHECKED -	REVISED -
PLOT DATE = 12/10/2020	DATE -	REVISED -

**STATE OF ILLINOIS
DEPARTMENT OF TRANSPORTATION**

PLAN SHEETS - NOKOMIS BLACKTOP

SCALE: 50 SHEET 11 OF 24 SHEETS STA. 305+00.00 TO STA. 335+00.00

F.A.S. RTE.	SECTION	COUNTY	TOTAL SHEETS	SHEET NO.
723	(16,17) RS-8	MONTGOMERY	30	17
CONTRACT NO. 72L91				
ILLINOIS FED. AID PROJECT				

ALL ENTRANCES & SIDEROADS WILL ALSO GET
MICROSURFACE TREATMENT. SEE SCHEDULES
FOR INFORMATION.



MATCHLINE STA. 335+00.00



MATCHLINE STA. 350+00.00



MATCHLINE STA. 350+00.00



MATCHLINE STA. 365+00.00

MODEL: Default
FILE: \\nrcs-pub\pubroom\dat\illinois\poc\PI\DOT\Documents\DOT_Offices\Dir\trc @Projects\0672191\CADD\Drawings\CAD\Drawings\0672191_ph-plan.dgn

USER NAME = coxjw	DESIGNED -	REVISED -
	DRAWN -	REVISED -
PLOT SCALE = 100,0000' / in.	CHECKED -	REVISED -
PLOT DATE = 12/10/2020	DATE -	REVISED -

**STATE OF ILLINOIS
DEPARTMENT OF TRANSPORTATION**

PLAN SHEETS - NOKOMIS BLACKTOP

SCALE: 50 SHEET 12 OF 24 SHEETS STA. 335+00.00 TO STA. 365+00.00

F.A.S. RTE.	SECTION	COUNTY	TOTAL SHEETS	SHEET NO.
723	(16,17) RS-8	MONTGOMERY	30	18
CONTRACT NO. 72L91				
ILLINOIS FED. AID PROJECT				

ALL ENTRANCES & SIDEROADS WILL ALSO GET
MICROSURFACE TREATMENT. SEE SCHEDULES
FOR INFORMATION.

MATCHLINE STA. 365+00.00

MATCHLINE STA. 380+00.00



MATCHLINE STA. 380+00.00

MATCHLINE STA. 395+00.00



MODEL: Default
FILE: \\hpc-1\pub\hpcroom\data\illinois\poc\PI\DOT\Documents\DOT_Offices\District 6\Projects\0672191\CADD\data\CAD\sheet\0672191_ph-plan.dgn

USER NAME = coxjw	DESIGNED -	REVISED -
	DRAWN -	REVISED -
PLOT SCALE = 100,0000' / in.	CHECKED -	REVISED -
PLOT DATE = 12/10/2020	DATE -	REVISED -

STATE OF ILLINOIS
DEPARTMENT OF TRANSPORTATION

PLAN SHEETS - NOKOMIS BLACKTOP

SCALE: 50 SHEET 13 OF 24 SHEETS STA. 365+00.00 TO STA. 395+00.00

F.A.S. RTE.	SECTION	COUNTY	TOTAL SHEETS	SHEET NO.
723	(16,17) RS-8	MONTGOMERY	30	19
CONTRACT NO. 72L91				
ILLINOIS FED. AID PROJECT				

ALL ENTRANCES & SIDEROADS WILL ALSO GET
MICROSURFACE TREATMENT. SEE SCHEDULES
FOR INFORMATION.

EXIST. CURVE 18
PI STA. = 406+01.50
 $\Delta = 0^\circ 56' 31''$ (LT)
D = 0' 09' 25"
R = 36,498.38'
T = 300.00'
L = 599.99'
E = 1.23'
e =
T.R. =

MATCHLINE STA. 395+00.00

MATCHLINE STA. 410+00.00

MATCHLINE STA. 410+00.00

MATCHLINE STA. 425+00.00

PR SINGLE PASS MICROSURFACE

PR SINGLE PASS MICROSURFACE

STA 419+24 (NOKOMIS BLACKTOP)
STA 10+00 (E 15TH RD)

MODEL: Default
FILE: \\hpc-pub\baronm.d\at\links\gov\PI\DOT\Documents\DOT_Offices\District 6\Projects\0672191\CADD\data\CAD\Sheets\0672191_#14-plan.dgn

USER NAME = coxjw	DESIGNED -	REVISED -
	DRAWN -	REVISED -
PLOT SCALE = 100,0000' / in.	CHECKED -	REVISED -
PLOT DATE = 12/10/2020	DATE -	REVISED -

**STATE OF ILLINOIS
DEPARTMENT OF TRANSPORTATION**

PLAN SHEETS - NOKOMIS BLACKTOP

SCALE: 50 SHEET 14 OF 24 SHEETS STA. 395+00.00 TO STA. 425+00.00

F.A.S. RTE.	SECTION	COUNTY	TOTAL SHEETS	SHEET NO.
723	(16,17) RS-8	MONTGOMERY	30	20
CONTRACT NO. 72L91				
ILLINOIS FED. AID PROJECT				

ALL ENTRANCES & SIDEROADS WILL ALSO GET
MICROSURFACE TREATMENT. SEE SCHEDULES
FOR INFORMATION.



MATCHLINE STA. 425+00.00

MATCHLINE STA. 440+00.00

425+00 426 427 428 429 430+00 431 11' 432 433 434 435+00 436 437 438 439

PR SINGLE PASS MICROSURFACE

PC Sta 439+10.78

MATCHLINE STA. 440+00.00

MATCHLINE STA. 455+00.00



440+00 441 442 443 444 445+00 446 11' 447 448 449 450+00 451 452 453 454

PR SINGLE PASS MICROSURFACE

PI Sta 442+10.78

PT Sta 445+10.78

EXIST. CURVE 21
PI STA. = 442+10.78
 $\Delta = 0^\circ 39' 41''$ (RT)
 $D = 0^\circ 06' 37''$
 $R = 51,982.71'$
 $T = 300.00'$
 $L = 599.99'$
 $E = 0.87'$
 $e =$
 $T.R. =$
 $S.E. RUN =$

MODEL: Default
FILE: \h:\a\c\p\pub\h\aroom\dat\illinois\gov\p\w\id\DOT\Documents\IDOT_Offices\IDOT\Projects\0672191\CADD\data\CAD\Sheets\0672191_ph-plan.dgn

USER NAME = c0xjw	DESIGNED -	REVISED -
	DRAWN -	REVISED -
PLOT SCALE = 100,0000' / in.	CHECKED -	REVISED -
PLOT DATE = 12/10/2020	DATE -	REVISED -

**STATE OF ILLINOIS
DEPARTMENT OF TRANSPORTATION**

PLAN SHEETS - NOKOMIS BLACKTOP

SCALE: 50 SHEET 15 OF 24 SHEETS STA. 425+00.00 TO STA. 455+00.00

F.A.S. RTE.	SECTION	COUNTY	TOTAL SHEETS	SHEET NO.
723	(16,17) RS-8	MONTGOMERY	30	21
CONTRACT NO. 72L91				
ILLINOIS FED. AID PROJECT				

ALL ENTRANCES & SIDEROADS WILL ALSO GET
MICROSURFACE TREATMENT. SEE SCHEDULES
FOR INFORMATION.

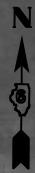

MATCHLINE STA. 455+00.00



MATCHLINE STA. 470+00.00

MATCHLINE STA. 470+00.00



MATCHLINE STA. 485+00.00

MODEL: Default
FILE: \\nrc\p\pub\baronm.d\illinois\p\72191\DOT\Documents\DOT_Offices\12191\CADD\Drawings\Drawings\0672191_16t-Plan.dgn

USER NAME = coxjw	DESIGNED -	REVISED -
	DRAWN -	REVISED -
PLOT SCALE = 100,0000' / in.	CHECKED -	REVISED -
PLOT DATE = 12/10/2020	DATE -	REVISED -

**STATE OF ILLINOIS
DEPARTMENT OF TRANSPORTATION**

PLAN SHEETS - NOKOMIS BLACKTOP

SCALE: 50 SHEET 16 OF 24 SHEETS STA. 455+00.00 TO STA. 485+00.00

F.A.S. RTE.	SECTION	COUNTY	TOTAL SHEETS	SHEET NO.
723	(16,17) RS-8	MONTGOMERY	30	22
CONTRACT NO. 72L91				
ILLINOIS FED. AID PROJECT				

ALL ENTRANCES & SIDEROADS WILL ALSO GET
MICROSURFACE TREATMENT. SEE SCHEDULES
FOR INFORMATION.



MATCHLINE STA. 485+00.00

485+00 486 487 488 489 490+00 491 492 493 494 495+00 496 497 498 499

PR SINGLE PASS MICROSURFACE

PC Sta 497+00.68

MATCHLINE STA. 500+00.00

MATCHLINE STA. 500+00.00

500+00 501 502 503 504 505+00 506 507 508 509 510+00 511 512 513 514

PR SINGLE PASS MICROSURFACE

PT Sta 503+00.67



MATCHLINE STA. 515+00.00

EXIST. CURVE 22
PI STA. = 500+00.68
 $\Delta = 0^\circ 27' 49''$ (RT)
D = 0' 04' 38"
R = 74,167.64'
T = 300.00'
L = 600.00'
E = 0.61'
e = _____
T.R. = _____
S.E. RUN = _____
P.C. STA. = 497+00.68

USER NAME = c0xjw	DESIGNED -	REVISED -
	DRAWN -	REVISED -
PLOT SCALE = 100,0000' / in.	CHECKED -	REVISED -
PLOT DATE = 12/10/2020	DATE -	REVISED -

**STATE OF ILLINOIS
DEPARTMENT OF TRANSPORTATION**

PLAN SHEETS - NOKOMIS BLACKTOP

SCALE: 50 SHEET 17 OF 24 SHEETS STA. 485+00.00 TO STA. 515+00.00

F.A.S. RTE.	SECTION	COUNTY	TOTAL SHEETS	SHEET NO.
723	(16,17) RS-8	MONTGOMERY	30	23
CONTRACT NO. 72L91				
ILLINOIS FED. AID PROJECT				

MODEL: Default
FILE: nokomis_blacktop.dwg
PROJECT: 72L91
DRAWN: c0xjw
CHECKED: c0xjw
DATE: 12/10/2020

ALL ENTRANCES & SIDEROADS WILL ALSO GET
MICROSURFACE TREATMENT. SEE SCHEDULES
FOR INFORMATION.



MATCHLINE STA. 515+00.00



MATCHLINE STA. 530+00.00

MATCHLINE STA. 530+00.00



MATCHLINE STA. 545+00.00

MODEL: Default
FILE: \\nrc\p\pub\baronm.d\at\illinois.gov\PI\DOT\Documents\DOT_Offices\District 6\Projects\0672191\CADD\data\CAD\Sheets\0672191_ph-plan.dgn

USER NAME = coxjw	DESIGNED -	REVISED -
	DRAWN -	REVISED -
PLOT SCALE = 100,0000' / in.	CHECKED -	REVISED -
PLOT DATE = 12/10/2020	DATE -	REVISED -

**STATE OF ILLINOIS
DEPARTMENT OF TRANSPORTATION**

PLAN SHEETS - NOKOMIS BLACKTOP

SCALE: 50 SHEET 18 OF 24 SHEETS STA. 515+00.00 TO STA. 545+00.00

F.A.S. RTE.	SECTION	COUNTY	TOTAL SHEETS	SHEET NO.
723	(16,17) RS-8	MONTGOMERY	30	24
CONTRACT NO. 72L91				
ILLINOIS FED. AID PROJECT				

ALL ENTRANCES & SIDEROADS WILL ALSO GET
MICROSURFACE TREATMENT. SEE SCHEDULES
FOR INFORMATION



MATCHLINE STA. 545+00.00

545+00 546 547 548 549 550+00 551 552 553 11' 11' 554 555+00 556 557 558 559

PR SINGLE PASS MICROSURFACE

MATCHLINE STA. 560+00.00

D = 0° 09' 23"
R = 36,632.22'
T = 300.00'
L = 599.99'
E = 1.23'
e =
T.R. =
S.E. RUN =
P.C. STA. = 562+97.47
P.T. STA. = 568+97.46

PC Sta 562+97.47

PI Sta 565+97.47

PT Sta 568+97.46

560+00 561 562 563 564 565+00 566 567 11' 11' 568 569 570+00 571 572 573 574

PR SINGLE PASS MICROSURFACE

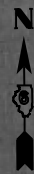

MATCHLINE STA. 560+00.00

MATCHLINE STA. 575+00.00

MODEL: Default
FILE: \\nrcs-prod-planningroom.dfs\illinois.gov\PI\DOT\Documents\DOT_Offices\District 6\Projects\0672191\CADD\DATA\CAD\Sheets\0672191_pln-19a.dgn

USER NAME = coxjw	DESIGNED -	REVISED -
	DRAWN -	REVISED -
PLOT SCALE = 100,0000' / in.	CHECKED -	REVISED -
PLOT DATE = 12/10/2020	DATE -	REVISED -

**STATE OF ILLINOIS
DEPARTMENT OF TRANSPORTATION**

PLAN SHEETS - NOKOMIS BLACKTOP

SCALE: 50 SHEET 19 OF 24 SHEETS STA. 545+00.00 TO STA. 575+00.00

F.A.S. RTE.	SECTION	COUNTY	TOTAL SHEETS	SHEET NO.
723	(16,17) RS-8	MONTGOMERY	30	25
CONTRACT NO. 72L91				
ILLINOIS FED. AID PROJECT				

ALL ENTRANCES & SIDEROADS WILL ALSO GET
MICROSURFACE TREATMENT. SEE SCHEDULES
FOR INFORMATION.

L = 999.93'
E = 3.64'
G =
T.R. =
S.E. RUN =
P.C. STA. = 582+39.66
P.T. STA. = 592+39.59



MATCHLINE STA. 575+00.00

MATCHLINE STA. 590+00.00

575+00 576 577 578 579 580+00 581 582 583 584 585+00 586 587 588 589

POT Sta 11+16.88

POT Sta 10+00.00

POT Sta 8+79.73

PC Sta 582+39.66

Pt Sta 587+39.66

STA 579+31 (NOKOMIS BLACKTOP)
STA 10+00 (E 18TH RD)

PR SINGLE PASS MICROSURFACE

MATCHLINE STA. 590+00.00

MATCHLINE STA. 605+00.00

590+00 591 592 593 594 595+00 596 597 598 599 600+00 601 602 603 604

PT Sta 592+39.59



PR SINGLE PASS MICROSURFACE

MODEL: Default
FILE: \\nrcs\proj\pub\room\dat\illinois\gov\PI\DOT\Documents\DOT_Offices\District 6\Projects\0672191\CADD\Drawings\CAD\Drawings\0672191_#16-plan.dgn

USER NAME = coxjw	DESIGNED -	REVISED -
	DRAWN -	REVISED -
PLOT SCALE = 100.0000' / in.	CHECKED -	REVISED -
PLOT DATE = 12/10/2020	DATE -	REVISED -

**STATE OF ILLINOIS
DEPARTMENT OF TRANSPORTATION**

PLAN SHEETS - NOKOMIS BLACKTOP

SCALE: 50 SHEET 20 OF 24 SHEETS STA. 575+00.00 TO STA. 605+00.00

F.A.S. RTE.	SECTION	COUNTY	TOTAL SHEETS	SHEET NO.
723	(16,17) RS-8	MONTGOMERY	30	26
CONTRACT NO. 72L91				
ILLINOIS FED. AID PROJECT				

ALL ENTRANCES & SIDEROADS WILL ALSO GET
MICROSURFACE TREATMENT. SEE SCHEDULES
FOR INFORMATION.

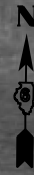

MATCHLINE STA. 605+00.00

605+00 | 606 | 607 | 608 | 609 | 610+00 | 611 | 612 | 613 | 11' | 614 | 615+00 | 616 | 617 | 618 | 619

PR SINGLE PASS MICROSURFACE

POT Sta 616+25.00

MATCHLINE STA. 620+00.00

MATCHLINE STA. 620+00.00

620+00 | 621 | 622 | 623 | 624 | 625+00 | 626 | 627 | 11' | 628 | 629 | 630+00 | 631 | 632+00 | 633 | 634

PR SINGLE PASS MICROSURFACE

POT Sta 11+28.76

POT Sta 10+00.00

POT Sta 8+84.60

STA 632+21 (NOKOMIS BLACKTOP)
STA 10+00 (E 19TH ST)

MATCHLINE STA. 635+00.00

MODEL: Default
FILE: \\nrcs-prod\pub\baronm.d\at\illinois.gov\PI\DOT\Documents\DOT_Offices\IDistrict 6\Projects\0672191\CADD\Drawings\CAD\Drawings\0672191_01c-plan.dgn

USER NAME = coxjw	DESIGNED -	REVISED -
	DRAWN -	REVISED -
PLOT SCALE = 100,0000' / in.	CHECKED -	REVISED -
PLOT DATE = 12/10/2020	DATE -	REVISED -

**STATE OF ILLINOIS
DEPARTMENT OF TRANSPORTATION**

PLAN SHEETS - NOKOMIS BLACKTOP

SCALE: 50 SHEET 21 OF 24 SHEETS STA. 605+00.00 TO STA. 635+00.00

F.A.S. RTE.	SECTION	COUNTY	TOTAL SHEETS	SHEET NO.
723	(16,17) RS-8	MONTGOMERY	30	27
CONTRACT NO. 72L91				
ILLINOIS FED. AID PROJECT				

ALL ENTRANCES & SIDEROADS WILL ALSO GET
MICROSURFACE TREATMENT. SEE SCHEDULES
FOR INFORMATION.



POT Sta 640+00.00

MATCHLINE STA. 635+00.00

MATCHLINE STA. 650+00.00

635+00 636 637 638 639 640+00 641 642 643 644 645+00 646 647 648 649

PR SINGLE PASS MICROSURFACE

MATCHLINE STA. 650+00.00

MATCHLINE STA. 665+00.00

POT Sta 664+00.00

650+00 651 652 653 654 655+00 656 657 658 659 660+00 661 662 663 664

PR SINGLE PASS MICROSURFACE



MODEL: Default
FILE: \\nrcs-prod\pub\anrcm\dat\illinois\poc\PI\DOT\Documents\DOT_Offices\lhartet_6\Projects\0672191\CADD\DATA\CAD\Sheets\0672191_ph-plan.dgn

USER NAME = coxjw	DESIGNED -	REVISED -
	DRAWN -	REVISED -
PLOT SCALE = 100,0000 ' / in.	CHECKED -	REVISED -
PLOT DATE = 12/10/2020	DATE -	REVISED -

**STATE OF ILLINOIS
DEPARTMENT OF TRANSPORTATION**

PLAN SHEETS - NOKOMIS BLACKTOP

SCALE: 50 SHEET 22 OF 24 SHEETS STA. 635+00.00 TO STA. 665+00.00

F.A.S. RTE.	SECTION	COUNTY	TOTAL SHEETS	SHEET NO.
723	(16,17) RS-8	MONTGOMERY	30	28
CONTRACT NO. 72L91				
ILLINOIS FED. AID PROJECT				

ALL ENTRANCES & SIDEROADS WILL ALSO GET
MICROSURFACE TREATMENT. SEE SCHEDULES
FOR INFORMATION.



MATCHLINE STA. 665+00.00

MATCHLINE STA. 680+00.00

665+00 666 667 668 669 670+00 671 11' 11' 672 673 674 675+00 676 677 678 679

PR SINGLE PASS MICROSURFACE

MATCHLINE STA. 680+00.00

MATCHLINE STA. 695+00.00

680+00 681 682 683 684 685+00 686 11' 11' 687 688 689 690+00 691 692 693 694

PR SINGLE PASS MICROSURFACE



EXIST. CURVE 25
PI STA. = 691+04.89
 $\Delta = 0^\circ 21' 17''$ (LT)
 $D = 0^\circ 03' 33''$
 $R = 96,891.60'$
 $T = 300.00'$
 $L = 600.00'$
 $E = 0.46'$
 $e =$
 $T.R. =$
 $S.E. RUN =$
 $P.C. STA. = 688+04.89$
 $P.T. STA. = 694+04.89$

MODEL: Default
FILE: \\nrcs-prod\pub\barcom\data\illinois.gov\PI\DOT\Documents\DOT_Offices\District 6\Projects\0672191\CADD\Drawings\CAD\Drawings\0672191_pht-plan.dgn

USER NAME = coxjw	DESIGNED -	REVISED -
	DRAWN -	REVISED -
PLOT SCALE = 100,0000' / in.	CHECKED -	REVISED -
PLOT DATE = 12/10/2020	DATE -	REVISED -

STATE OF ILLINOIS
DEPARTMENT OF TRANSPORTATION

PLAN SHEETS - NOKOMIS BLACKTOP

SCALE: 50 SHEET 23 OF 24 SHEETS STA. 665+00.00 TO STA. 695+00.00

F.A.S. RTE.	SECTION	COUNTY	TOTAL SHEETS	SHEET NO.
723	(16,17) RS-8	MONTGOMERY	30	29
CONTRACT NO. 72L91				
ILLINOIS FED. AID PROJECT				

ALL ENTRANCES & SIDEROADS WILL ALSO GET
MICROSURFACE TREATMENT. SEE SCHEDULES
FOR INFORMATION.

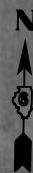

MATCHLINE STA. 695+00.00

695+00 696 11' 697 698 699 700+00 701 702 703 704 705+00 706 707 708 709

POT Sta 709+00.00

PR SINGLE PASS MICROSURFACE

LIMITS OF IMPROVEMENT
STA 697+33.00

MODEL: Default
FILE: \\nrcs-prod\planroom\dat\illinois.gov\PWIDOT\Documents\DOT_Offices\District_6\Projects\0672191\CADD\DATA\CAD\Sheets\0672191_ph-plan.dgn

USER NAME = coxjw	DESIGNED -	REVISED -
	DRAWN -	REVISED -
PLOT SCALE = 100,0000 ' / in.	CHECKED -	REVISED -
PLOT DATE = 12/10/2020	DATE -	REVISED -

**STATE OF ILLINOIS
DEPARTMENT OF TRANSPORTATION**

PLAN SHEETS - NOKOMIS BLACKTOP

SCALE: 50 SHEET 24 OF 24 SHEETS STA. 695+00.00 TO STA. 710+00.00

F.A.S. RTE.	SECTION	COUNTY	TOTAL SHEETS	SHEET NO.
723	(16,17) RS-8	MONTGOMERY	30	30
CONTRACT NO. 72L91				
ILLINOIS FED. AID PROJECT				