

F.A. RTE.	SECTION	COUNTY	TOTAL SHEETS	SHEET NO.
				60
STA.		TO STA.		
FED. ROAD DIST. NO. ILLINOIS FED. AID PROJECT				

89392

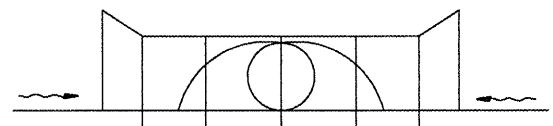

FRONT VIEW

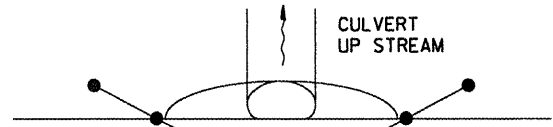

TOP VIEW

UPSTREAM PIPE CULVERT EROSION CONTROL

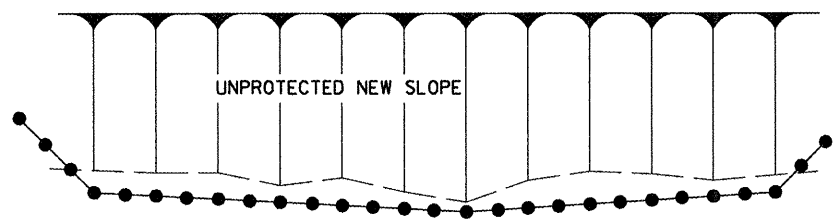

UNPROTECTED NEW SLOPE

TOP VIEW

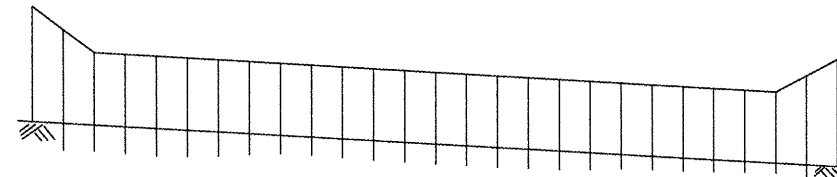

FRONT VIEW

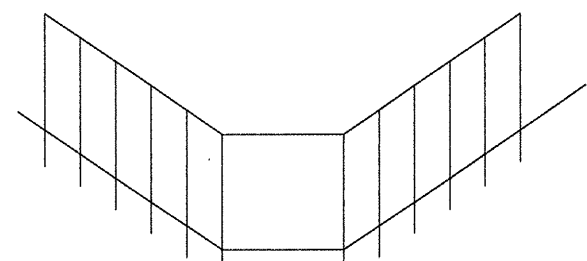

FRONT VIEW



TOP VIEW

DITCH LINE EROSION CONTROL

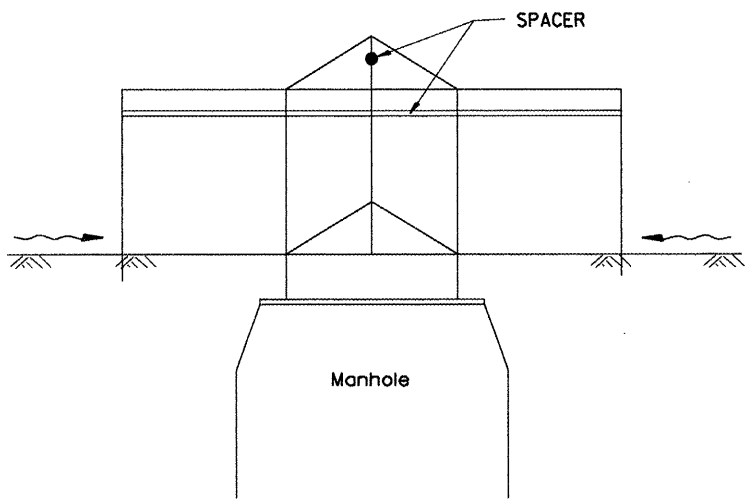

SIDE VIEW

A-A

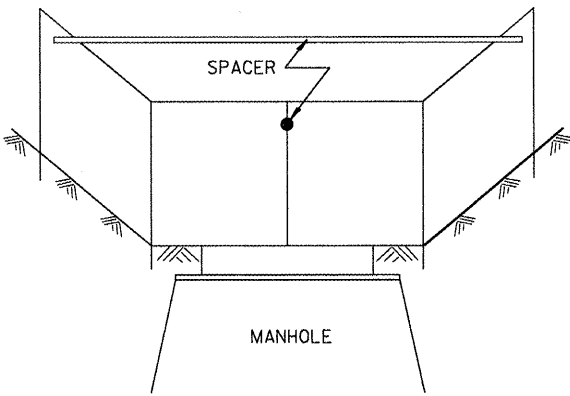

Front View

B-B

EROSION CONTROL AT OPEN GRATE MAN HOLE

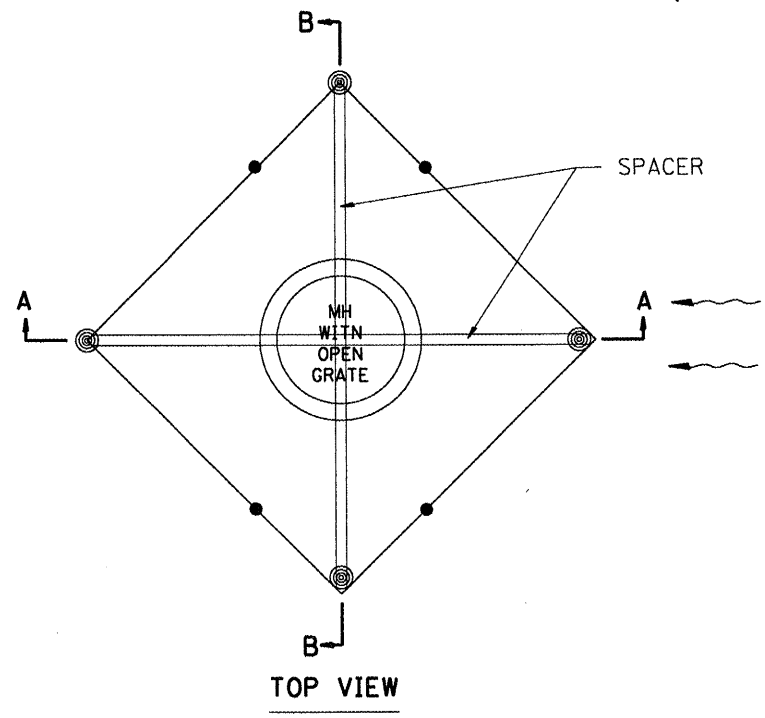

TOP VIEW

GENERAL NOTES:

1. This work shall be performed in accordance with Sections 280 & 1081, of the Standard Specifications.
2. Additional Timber or Metal Post shall be installed, as needed.

All dimensions are in millimeters (inches) unless otherwise noted.

ILLINOIS DEPARTMENT OF TRANSPORTATION	
SPECIAL DETAIL SHEET	
TYPICAL APPLICATION OF SILT FILTER FENCE	
CADD DETAIL 280001-D4	DRAWN BY CADD
SCALE: NOT DRAWN TO SCALE	CHECKED BY
DATE **DATE**	

DATE	REVISIONS	BY
1-1-97	RENUM. A-12.05, NEW REVISION BOX	T.P.

Designer NOTES:  
 1. Designer to modify this Special Detail sheet, as needed, for inclusion in plans.  
 2. Include Highway Standard 280001 "TEMPORARY EROSION CONTROL SYSTEM."

DATE\*\*