

If you plan to submit a bid directly to the Department of Transportation

PREQUALIFICATION

Any contractor who desires to become pre-qualified to bid on work advertised by IDOT must submit the properly completed pre-qualification forms to the Bureau of Construction no later than 4:30 p.m. prevailing time twenty-one days prior to the letting of interest. This pre-qualification requirement applies to first time contractors, contractors renewing expired ratings, contractors maintaining continuous pre-qualification or contractors requesting revised ratings. To be eligible to bid, existing pre-qualification ratings must be effective through the date of letting.

REQUESTS FOR AUTHORIZATION TO BID

Contractors downloading and/or ordering CD-ROM's and are wanting to bid on items included in a particular letting must submit the properly completed "Request for Authorization to Bid/or Not For Bid Status" (BDE 124INT) and the ORIGINAL, signed and notarized, "Affidavit of Availability" (BC 57) to the proper office no later than 4:30 p.m. prevailing time, three (3) days prior to the letting date.

WHO CAN BID ?

Bids will be accepted from only those companies that request and receive written **Authorization to Bid** from IDOT's Central Bureau of Construction.

WHAT CONSTITUTES WRITTEN AUTHORIZATION TO BID? When a prospective prime bidder submits a "Request for Authorization to Bid/or Not For Bid Status"(BDE 124INT) he/she must indicate at that time which items are being requested For Bidding purposes. Only those items requested For Bidding will be analyzed. After the request has been analyzed, the bidder will be issued a **Proposal Denial and/or Authorization Form**, approved by the Central Bureau of Construction, that indicates which items have been approved For Bidding. If **Authorization to Bid** cannot be approved, the **Proposal Denial and/or Authorization Form** will indicate the reason for denial.

ABOUT AUTHORIZATION TO BID: Firms that have not received an authorization form within a reasonable time of complete and correct original document submittal should contact the department as to status. This is critical in the week before the letting. These documents must be received three days before the letting date. Firms unsure as to authorization status should call the Prequalification Section of the Bureau of Construction at the number listed at the end of these instructions.

ADDENDA AND REVISIONS: It is the contractor's responsibility to determine which, if any, addenda or revisions pertain to any project they may be bidding. Failure to incorporate all relevant addenda or revisions may cause the bid to be declared unacceptable.

Each addendum will be placed with the contract number. Addenda and revisions will also be placed on the Addendum/Revision Checklist and each subscription service subscriber will be notified by e-mail of each addendum and revision issued.

The Internet is the Department's primary way of doing business. The subscription server e-mails are an added courtesy the Department provides. It is suggested that bidder check IDOT's website <http://www.dot.il.gov/desenv/delett.html> before submitting final bid information.

IDOT is not responsible for any e-mail related failures.

Addenda Questions may be directed to the Contracts Office at (217)782-7806 or D&Econtracts@dot.il.gov

Technical Questions about downloading these files may be directed to Tim Garman (217)524-1642 or garmantr@dot.il.gov.

WHAT MUST BE INCLUDED WHEN BIDS ARE SUBMITTED?: Bidders need not return the entire proposal when bids are submitted. That portion of the proposal that must be returned includes the following:

1. All documents from the Proposal Cover Sheet through the Proposal Bid Bond
2. Other special documentation and/or information that may be required by the contract special provisions

All proposal documents, including Proposal Guaranty Checks or Proposal Bid Bonds, should be stapled together to prevent loss when bids are processed by IDOT personnel.

ABOUT SUBMITTING BIDS: It is recommended that bidders deliver bids in person to insure they arrive at the proper location prior to the time specified for the receipt of bids. Any bid received at the place of letting after the time specified will not be accepted.

WHO SHOULD BE CALLED IF ASSISTANCE IS NEEDED?

Questions Regarding	Call
Prequalification and/or Authorization to Bid	(217)782-3413
Preparation and submittal of bids	(217)782-7806
Mailing of plans and proposals	(217)782-7806
Electronic plans and proposals	(217)524-1642

ADDENDUMS AND REVISIONS TO THE PROPOSAL FORMS

Planholders should verify that they have received and incorporated the addendum and/or revision prior to submitting their bid. Failure by the bidder to include an addendum could result in a bid being rejected as irregular.

65

RETURN WITH BID

Proposal Submitted By
Name
Address
City

Letting March 7, 2008

BIDDERS NEED NOT RETURN THE ENTIRE PROPOSAL
(See instructions inside front cover)

NOTICE TO PROSPECTIVE BIDDERS
 This proposal can be used for bidding purposes by only those companies that request and receive written AUTHORIZATION TO BID from IDOT's Central Bureau of Construction.
 (SEE INSTRUCTIONS ON THE INSIDE OF COVER)

Notice To Bidders, Specifications, Proposal, Contract and Contract Bond



**Illinois Department
of Transportation**

Springfield, Illinois 62764

**Contract No. 64D44
ROCK ISLAND County
Section D2 SPRING RS 2007-12
District 2 Construction Funds
Route FAU 5773/5855**

PLEASE MARK THE APPROPRIATE BOX BELOW:

A Bid Bond is included.

A Cashier's Check or a Certified Check is included.

Plans Included
Herein

Prepared by	
Checked by	S

(Printed by authority of the State of Illinois)

INSTRUCTIONS

ABOUT IDOT PROPOSALS: All proposals issued by IDOT are potential bidding proposals. Each proposal contains all Certifications and Affidavits, a Proposal Signature Sheet and a Proposal Bid Bond required for Prime Contractors to submit a bid after written **Authorization to Bid** has been issued by IDOT's Central Bureau of Construction.

WHO CAN BID?: Bids will be accepted from only those companies that request and receive written **Authorization to Bid** from IDOT's Central Bureau of Construction. To request authorization, a potential bidder must complete and submit Part B of the Request for Authorization to Bid/or Not For Bid Status form (BDE 124 INT) and submit an original Affidavit of Availability (BC 57).

WHAT CONSTITUTES WRITTEN AUTHORIZATION TO BID?: When a prospective prime bidder submits a "Request for Proposal Forms and Plans" he/she must indicate at that time which items are being requested For Bidding purposes. Only those items requested For Bidding will be analyzed. After the request has been analyzed, the bidder will be issued a **Proposal Denial and/or Authorization Form**, approved by the Central Bureau of Construction, that indicates which items have been approved For Bidding. If **Authorization to Bid** cannot be approved, the **Proposal Denial and/or Authorization Form** will indicate the reason for denial. If a contractor has requested to bid but has not received a **Proposal Denial and/or Authorization Form**, they should contact the Central Bureau of Construction in advance of the letting date.

WHAT MUST BE INCLUDED WHEN BIDS ARE SUBMITTED?: Bidders need not return the entire proposal when bids are submitted. That portion of the proposal that must be returned includes the following:

1. All documents from the Proposal Cover Sheet through the Proposal Bid Bond
2. Other special documentation and/or information that may be required by the contract special provisions

All proposal documents, including Proposal Guaranty Checks or Proposal Bid Bonds, should be stapled together to prevent loss when bids are processed by IDOT personnel.

ABOUT SUBMITTING BIDS: It is recommended that bidders deliver bids in person to insure they arrive at the proper location prior to the time specified for the receipt of bids. Any bid received at the place of letting after the time specified will not be accepted.

WHO SHOULD BE CALLED IF ASSISTANCE IS NEEDED?

Questions Regarding	Call
Prequalification and/or Authorization to Bid	217/782-3413
Preparation and submittal of bids	217/782-7806
Mailing of CD-ROMS	217/782-7806

RETURN WITH BID



PROPOSAL

TO THE DEPARTMENT OF TRANSPORTATION

1. Proposal of _____

Taxpayer Identification Number (Mandatory) _____ a

for the improvement identified and advertised for bids in the Invitation for Bids as:

**Contract No. 64D44
ROCK ISLAND County
Section D2 SPRING RS 2007-12
Route FAU 5773/5855
District 2 Construction Funds**

This project consists of widening, patching, and resurfacing on the south frontage road located between Archer Drive and 7th Street and sidewalk repairs along the north frontage road between Kennedy Road and 7th Street in East Moline.

2. The undersigned bidder will furnish all labor, material and equipment to complete the above described project in a good and workmanlike manner as provided in the contract documents provided by the Department of Transportation. This proposal will become part of the contract and the terms and conditions contained in the contract documents shall govern performance and payments.

RETURN WITH BID

3. **ASSURANCE OF EXAMINATION AND INSPECTION/WAIVER.** The undersigned further declares that he/she has carefully examined the proposal, plans, specifications, form of contract and contract bond, and special provisions, and that he/she has inspected in detail the site of the proposed work, and that he/she has familiarized themselves with all of the local conditions affecting the contract and the detailed requirements of construction, and understands that in making this proposal he/she waives all right to plead any misunderstanding regarding the same.

4. **EXECUTION OF CONTRACT AND CONTRACT BOND.** The undersigned further agrees to execute a contract for this work and present the same to the department within fifteen (15) days after the contract has been mailed to him/her. The undersigned further agrees that he/she and his/her surety will execute and present within fifteen (15) days after the contract has been mailed to him/her contract bond satisfactory to and in the form prescribed by the Department of Transportation, in the penal sum of the full amount of the contract, guaranteeing the faithful performance of the work in accordance with the terms of the contract.

5. **PROPOSAL GUARANTY.** Accompanying this proposal is either a bid bond on the department form, executed by a corporate surety company satisfactory to the department, or a proposal guaranty check consisting of a bank cashier's check or a properly certified check for not less than 5 per cent of the amount bid or for the amount specified in the following schedule:

<u>Amount of Bid</u>		<u>Proposal Guaranty</u>	<u>Amount of Bid</u>		<u>Proposal Guaranty</u>	
Up to	\$5,000	\$150	\$2,000,000	to	\$3,000,000	\$100,000
\$5,000	to \$10,000	\$300	\$3,000,000	to	\$5,000,000	\$150,000
\$10,000	to \$50,000	\$1,000	\$5,000,000	to	\$7,500,000	\$250,000
\$50,000	to \$100,000	\$3,000	\$7,500,000	to	\$10,000,000	\$400,000
\$100,000	to \$150,000	\$5,000	\$10,000,000	to	\$15,000,000	\$500,000
\$150,000	to \$250,000	\$7,500	\$15,000,000	to	\$20,000,000	\$600,000
\$250,000	to \$500,000	\$12,500	\$20,000,000	to	\$25,000,000	\$700,000
\$500,000	to \$1,000,000	\$25,000	\$25,000,000	to	\$30,000,000	\$800,000
\$1,000,000	to \$1,500,000	\$50,000	\$30,000,000	to	\$35,000,000	\$900,000
\$1,500,000	to \$2,000,000	\$75,000	over		\$35,000,000	\$1,000,000

Bank cashier's checks or properly certified checks accompanying proposals shall be made payable to the Treasurer, State of Illinois, when the state is awarding authority; the county treasurer, when a county is the awarding authority; or the city, village, or town treasurer, when a city, village, or town is the awarding authority.

If a combination bid is submitted, the proposal guaranties which accompany the individual proposals making up the combination will be considered as also covering the combination bid.

The amount of the proposal guaranty check is _____ \$(_____). If this proposal is accepted and the undersigned shall fail to execute a contract bond as required herein, it is hereby agreed that the amount of the proposal guaranty shall become the property of the State of Illinois, and shall be considered as payment of damages due to delay and other causes suffered by the State because of the failure to execute said contract and contract bond; otherwise, the bid bond shall become void or the proposal guaranty check shall be returned to the undersigned.

Attach Cashier's Check or Certified Check Here	
In the event that one proposal guaranty check is intended to cover two or more proposals, the amount must be equal to the sum of the proposal guaranties which would be required for each individual proposal. If the guaranty check is placed in another proposal, state below where it may be found.	
The proposal guaranty check will be found in the proposal for:	Item _____
	Section No. _____
	County _____

Mark the proposal cover sheet as to the type of proposal guaranty submitted.

BD 354 (Rev. 11/2001)

RETURN WITH BID

6. **COMBINATION BIDS.** The undersigned further agrees that if awarded the contract for the sections contained in the following combination, he/she will perform the work in accordance with the requirements of each individual proposal comprising the combination bid specified in the schedule below, and that the combination bid shall be prorated against each section in proportion to the bid submitted for the same. If an error is found to exist in the gross sum bid for one or more of the individual sections included in a combination, the combination bid shall be corrected as provided in the specifications.

When a combination bid is submitted, the schedule below must be completed in each proposal comprising the combination.

If alternate bids are submitted for one or more of the sections comprising the combination, a combination bid must be submitted for each alternate.

Schedule of Combination Bids

Combination No.	Sections Included in Combination	Combination Bid	
		Dollars	Cents

7. **SCHEDULE OF PRICES.** The undersigned bidder submits herewith, in accordance with the rules and instructions, a schedule of prices for the items of work for which bids are sought. The unit prices bid are in U.S. dollars and cents, and all extensions and summations have been made. The bidder understands that the quantities appearing in the bid schedule are approximate and are provided for the purpose of obtaining a gross sum for the comparison of bids. If there is an error in the extension of the unit prices, the unit prices shall govern. Payment to the contractor awarded the contract will be made only for actual quantities of work performed and accepted or materials furnished according to the contract. The scheduled quantities of work to be done and materials to be furnished may be increased, decreased or omitted as provided elsewhere in the contract.

8. **CERTIFICATE OF AUTHORITY.** The undersigned bidder, if a business organized under the laws of another State, assures the Department that it will furnish a copy of its certificate of authority to do business in the State of Illinois with the return of the executed contract and bond. Failure to furnish the certificate within the time provided for execution of an awarded contract may be cause for cancellation of the award and forfeiture of the proposal guaranty to the State.

ILLINOIS DEPARTMENT OF TRANSPORTATION
 SCHEDULE OF PRICES
 CONTRACT
 NUMBER -

64D44

State Job # - C-92-096-07
 PPS NBR - 0-00858-2026
 County Name - ROCK ISLAND- -
 Code - 161 - -
 District - 2 - -
 Section Number - D2 SPRING RS 2007-12

Project Number

Route
 FAU 5773
 FAU 5855

Item Number	Pay Item Description	Unit of Measure	Quantity	x	Unit Price	=	Total Price
Z0028415	GEOTECHNICAL REINF	SQ YD	448.000				
Z0028700	GRAN SUBGRADE REPL	CU YD	75.000				
20200600	EXC & GR EX SHOULDER	UNIT	29.700				
21101600	TOPSOIL F & P VAR DP	SQ YD	277.000				
25200100	SODDING	SQ YD	277.000				
40600200	BIT MATLS PR CT	TON	2.700				
40600300	AGG PR CT	TON	14.000				
40600525	LEV BIND HM N50	TON	20.000				
40600625	LEV BIND MM N50	TON	492.000				
40600982	HMA SURF REM BUTT JT	SQ YD	133.000				
40600985	PCC SURF REM BUTT JT	SQ YD	75.000				
40600990	TEMPORARY RAMP	SQ YD	305.000				
40603310	HMA SC "C" N50	TON	616.000				
40800050	INCIDENTAL HMA SURF	TON	39.000				
42300400	PCC DRIVEWAY PAVT 8	SQ YD	207.000				

ILLINOIS DEPARTMENT OF TRANSPORTATION
 SCHEDULE OF PRICES
 CONTRACT
 NUMBER -

64D44

State Job # - C-92-096-07
 PPS NBR - 0-00858-2026
 County Name - ROCK ISLAND- -
 Code - 161 - -
 District - 2 - -
 Section Number - D2 SPRING RS 2007-12

Project Number

Route

FAU 5773

FAU 5855

Item Number	Pay Item Description	Unit of Measure	Quantity	x	Unit Price	=	Total Price
42400100	PC CONC SIDEWALK 4	SQ FT	5,640.000				
42400410	PC CONC SIDEWALK 8	SQ FT	268.000				
44000157	HMA SURF REM 2	SQ YD	512.000				
44000200	DRIVE PAVEMENT REM	SQ YD	207.000				
44000600	SIDEWALK REM	SQ FT	4,636.000				
44201737	CL D PATCH T1 8	SQ YD	3.000				
44201741	CL D PATCH T2 8	SQ YD	15.000				
44201745	CL D PATCH T3 8	SQ YD	42.000				
44201747	CL D PATCH T4 8	SQ YD	388.000				
48101200	AGGREGATE SHLDS B	TON	131.000				
48203100	HMA SHOULDERS	TON	364.000				
67100100	MOBILIZATION	L SUM	1.000				
70102620	TR CONT & PROT 701501	L SUM	1.000				
70102640	TR CONT & PROT 701801	L SUM	1.000				
70300100	SHORT-TERM PAVT MKING	FOOT	955.000				

ILLINOIS DEPARTMENT OF TRANSPORTATION
 SCHEDULE OF PRICES
 CONTRACT
 NUMBER - 64D44

State Job # - C-92-096-07
 PPS NBR - 0-00858-2026
 County Name - ROCK ISLAND- -
 Code - 161 - -
 District - 2 - -
 Section Number - D2 SPRING RS 2007-12

Project Number

Route
 FAU 5773
 FAU 5855

Item Number	Pay Item Description	Unit of Measure	Quantity	x	Unit Price	=	Total Price
70301000	WORK ZONE PAVT MK REM	SQ FT	107.000				
78001110	PAINT PVT MK LINE 4	FOOT	13,508.000				
78001180	PAINT PVT MK LINE 24	FOOT	86.000				
88600100	DET LOOP T1	FOOT	215.000				

CONTRACT NUMBER

64D44

THIS IS THE TOTAL BID

\$ _____

NOTES:

1. Each **PAY ITEM** should have a **UNIT PRICE** and a **TOTAL PRICE**.
2. The **UNIT PRICE** shall govern if no **TOTAL PRICE** is shown or if there is a discrepancy between the product of the **UNIT PRICE** multiplied by the **QUANTITY**.
3. If a **UNIT PRICE** is omitted, the **TOTAL PRICE** will be divided by the **QUANTITY** in order to establish a **UNIT PRICE**.
4. A bid may be declared **UNACCEPTABLE** if neither a unit price nor a total price is shown.

RETURN WITH BID

STATE REQUIRED ETHICAL STANDARDS GOVERNING CONTRACT PROCUREMENT: ASSURANCES, CERTIFICATIONS AND DISCLOSURES

I. GENERAL

A. Article 50 of the Illinois Procurement Code establishes the duty of all State chief procurement officers, State purchasing officers, and their designees to maximize the value of the expenditure of public moneys in procuring goods, services, and contracts for the State of Illinois and to act in a manner that maintains the integrity and public trust of State government. In discharging this duty, they are charged by law to use all available information, reasonable efforts, and reasonable actions to protect, safeguard, and maintain the procurement process of the State of Illinois.

B. In order to comply with the provisions of Article 50 and to carry out the duty established therein, all bidders are to adhere to ethical standards established for the procurement process, and to make such assurances, disclosures and certifications required by law. By execution of the Proposal Signature Sheet, the bidder indicates that each of the mandated assurances has been read and understood, that each certification is made and understood, and that each disclosure requirement has been understood and completed.

C. In addition to all other remedies provided by law, failure to comply with any assurance, failure to make any disclosure or the making of a false certification shall be grounds for termination of the contract and the suspension or debarment of the bidder.

II. ASSURANCES

A. The assurances hereinafter made by the bidder are each a material representation of fact upon which reliance is placed should the Department enter into the contract with the bidder. The Department may terminate the contract if it is later determined that the bidder rendered a false or erroneous assurance, and the surety providing the performance bond shall be responsible for the completion of the contract.

B. Felons

1. The Illinois Procurement Code provides:

Section 50-10. Felons. Unless otherwise provided, no person or business convicted of a felony shall do business with the State of Illinois or any state agency from the date of conviction until 5 years after the date of completion of the sentence for that felony, unless no person held responsible by a prosecutorial office for the facts upon which the conviction was based continues to have any involvement with the business.

2. The bidder assures the Department that the award and execution of the contract would not cause a violation of Section 50-10.

C. Conflicts of Interest

1. The Illinois Procurement Code provides in pertinent part:

Section 50-13. Conflicts of Interest.

(a) Prohibition. It is unlawful for any person holding an elective office in this State, holding a seat in the General Assembly, or appointed to or employed in any of the offices or agencies of state government and who receives compensation for such employment in excess of 60% of the salary of the Governor of the State of Illinois, or who is an officer or employee of the Capital Development Board or the Illinois Toll Highway Authority, or who is the spouse or minor child of any such person to have or acquire any contract, or any direct pecuniary interest in any contract therein, whether for stationery, printing, paper, or any services, materials, or supplies, that will be wholly or partially satisfied by the payment of funds appropriated by the General Assembly of the State of Illinois or in any contract of the Capital Development Board or the Illinois Toll Highway authority.

(b) Interests. It is unlawful for any firm, partnership, association or corporation, in which any person listed in subsection (a) is entitled to receive (i) more than 7 1/2% of the total distributable income or (ii) an amount in excess of the salary of the Governor, to have or acquire any such contract or direct pecuniary interest therein.

(c) Combined interests. It is unlawful for any firm, partnership, association, or corporation, in which any person listed in subsection (a) together with his or her spouse or minor children is entitled to receive (i) more than 15%, in the aggregate, of the total distributable income or (ii) an amount in excess of 2 times the salary of the Governor, to have or acquire any such contract or direct pecuniary interest therein.

(d) Securities. Nothing in this Section invalidates the provisions of any bond or other security previously offered or to be offered for sale or sold by or for the State of Illinois.

(e) Prior interests. This Section does not affect the validity of any contract made between the State and an officer or employee of the State or member of the General Assembly, his or her spouse, minor child or any combination of those persons if that contract was in existence before his or her election or employment as an officer, member, or employee. The contract is voidable, however, if it cannot be completed within 365 days after the officer, member, or employee takes office or is employed.

The current salary of the Governor is \$171,000.00. Sixty percent of the salary is \$102,600.00.

RETURN WITH BID

2. The bidder assures the Department that the award and execution of the contract would not cause a violation of Section 50-13, or that an effective exemption has been issued by the Board of Ethics to any individual subject to the Section 50-13 prohibitions pursuant to the provisions of Section 50-20 of the Code and Executive Order Number 3 (1998). Information concerning the exemption process is available from the Department upon request.

D. Negotiations

1. The Illinois Procurement Code provides in pertinent part:

Section 50-15. Negotiations.

(a) It is unlawful for any person employed in or on a continual contractual relationship with any of the offices or agencies of State government to participate in contract negotiations on behalf of that office or agency with any firm, partnership, association, or corporation with whom that person has a contract for future employment or is negotiating concerning possible future employment.

2. The bidder assures the Department that the award and execution of the contract would not cause a violation of Section 50-15, and that the bidder has no knowledge of any facts relevant to the kinds of acts prohibited therein.

E. Inducements

1. The Illinois Procurement Code provides:

Section 50-25. Inducement. Any person who offers or pays any money or other valuable thing to any person to induce him or her not to bid for a State contract or as recompense for not having bid on a State contract is guilty of a Class 4 felony. Any person who accepts any money or other valuable thing for not bidding for a State contract or who withholds a bid in consideration of the promise for the payment of money or other valuable thing is guilty of a Class 4 felony.

2. The bidder assures the Department that the award and execution of the contract would not cause a violation of Section 50-25, and that the bidder has no knowledge of any facts relevant to the kinds of acts prohibited therein.

F. Revolving Door Prohibition

1. The Illinois Procurement Code provides:

Section 50-30. Revolving door prohibition. Chief procurement officers, associate procurement officers, State purchasing officers, their designees whose principal duties are directly related to State procurement, and executive officers confirmed by the Senate are expressly prohibited for a period of 2 years after terminating an affected position from engaging in any procurement activity relating to the State agency most recently employing them in an affected position for a period of at least 6 months. The prohibition includes, but is not limited to: lobbying the procurement process; specifying; bidding; proposing bid, proposal, or contract documents; on their own behalf or on behalf of any firm, partnership, association, or corporation. This Section applies only to persons who terminate an affected position on or after January 15, 1999.

2. The bidder assures the Department that the award and execution of the contract would not cause a violation of Section 50-30, and that the bidder has no knowledge of any facts relevant to the kinds of acts prohibited therein.

G. Reporting Anticompetitive Practices

1. The Illinois Procurement Code provides:

Section 50-40. Reporting anticompetitive practices. When, for any reason, any vendor, bidder, contractor, chief procurement officer, State purchasing officer, designee, elected official, or State employee suspects collusion or other anticompetitive practice among any bidders, offerors, contractors, proposers, or employees of the State, a notice of the relevant facts shall be transmitted to the Attorney General and the chief procurement officer.

2. The bidder assures the Department that it has not failed to report any relevant facts concerning the practices addressed in Section 50-40 which may involve the contract for which the bid is submitted.

H. Confidentiality

1. The Illinois Procurement Code provides:

Section 50-45. Confidentiality. Any chief procurement officer, State purchasing officer, designee, or executive officer who willfully uses or allows the use of specifications, competitive bid documents, proprietary competitive information, proposals, contracts, or selection information to compromise the fairness or integrity of the procurement, bidding, or contract process shall be subject to immediate dismissal, regardless of the Personnel code, any contract, or any collective bargaining agreement, and may in addition be subject to criminal prosecution.

2. The bidder assures the Department that it has no knowledge of any fact relevant to the practices addressed in Section 50-45 which may involve the contract for which the bid is submitted.

RETURN WITH BID

I. Insider Information

1. The Illinois Procurement Act provides:

Section 50-50. Insider information. It is unlawful for any current or former elected or appointed State official or State employee to knowingly use confidential information available only by virtue of that office or employment for actual or anticipated gain for themselves or another person.

2. The bidder assures the Department that it has no knowledge of any facts relevant to the practices addressed in Section 50-50 which may involve the contract for which the bid is submitted.

III. CERTIFICATIONS

A. The certifications hereinafter made by the bidder are each a material representation of fact upon which reliance is placed should the Department enter into the contract with the bidder. The Department may terminate the contract if it is later determined that the bidder rendered a false or erroneous certification, and the surety providing the performance bond shall be responsible for completion of the contract.

B. Bribery

1. The Illinois Procurement Code provides:

Section 50-5. Bribery.

(a) Prohibition. No person or business shall be awarded a contract or subcontract under this Code who:

(1) has been convicted under the laws of Illinois or any other state of bribery or attempting to bribe an officer or employee of the State of Illinois or any other state in that officer's or employee's official capacity; or

(2) has made an admission of guilt of that conduct that is a matter of record but has not been prosecuted for that conduct.

(b) Businesses. No business shall be barred from contracting with any unit of State or local government as a result of a conviction under this Section of any employee or agent of the business if the employee or agent is no longer employed by the business and:

(1) the business has been finally adjudicated not guilty; or

(2) the business demonstrates to the governmental entity with which it seeks to contract, and that entity finds that the commission of the offense was not authorized, requested, commanded, or performed by a director, officer, or high managerial agent on behalf of the business as provided in paragraph (2) of subsection (a) of Section 5-4 of the Criminal Code of 1961.

(c) Conduct on behalf of business. For purposes of this Section, when an official, agent, or employee of a business committed the bribery or attempted bribery on behalf of the business and in accordance with the direction or authorization of a responsible official of the business, the business shall be chargeable with the conduct.

(d) Certification. Every bid submitted to and contract executed by the State shall contain a certification by the contractor that the contractor is not barred from being awarded a contract or subcontract under this Section. A contractor who makes a false statement, material to the certification, commits a Class 3 felony.

2. The bidder certifies that it is not barred from being awarded a contract under Section 50.5.

C. Educational Loan

1. Section 3 of the Educational Loan Default Act provides:

§ 3. No State agency shall contract with an individual for goods or services if that individual is in default, as defined in Section 2 of this Act, on an educational loan. Any contract used by any State agency shall include a statement certifying that the individual is not in default on an educational loan as provided in this Section.

2. The bidder, if an individual as opposed to a corporation, partnership or other form of business organization, certifies that the bidder is not in default on an educational loan as provided in Section 3 of the Act.

D. Bid-Rigging/Bid Rotating

1. Section 33E-11 of the Criminal Code of 1961 provides:

§ 33E-11. (a) Every bid submitted to and public contract executed pursuant to such bid by the State or a unit of local government shall contain a certification by the prime contractor that the prime contractor is not barred from contracting with any unit of State or local government as a result of a violation of either Section 33E-3 or 33E-4 of this Article. The State and units of local government shall provide the appropriate forms for such certification.

RETURN WITH BID

(b) A contractor who makes a false statement, material to the certification, commits a Class 3 felony.

A violation of Section 33E-3 would be represented by a conviction of the crime of bid-rigging which, in addition to Class 3 felony sentencing, provides that any person convicted of this offense or any similar offense of any state or the United States which contains the same elements as this offense shall be barred for 5 years from the date of conviction from contracting with any unit of State or local government. No corporation shall be barred from contracting with any unit of State or local government as a result of a conviction under this Section of any employee or agent of such corporation if the employee so convicted is no longer employed by the corporation and: (1) it has been finally adjudicated not guilty or (2) if it demonstrates to the governmental entity with which it seeks to contract and that entity finds that the commission of the offense was neither authorized, requested, commanded, nor performed by a director, officer or a high managerial agent in behalf of the corporation.

A violation of Section 33E-4 would be represented by a conviction of the crime of bid-rotating which, in addition to Class 2 felony sentencing, provides that any person convicted of this offense or any similar offense of any state or the United States which contains the same elements as this offense shall be permanently barred from contracting with any unit of State or local government. No corporation shall be barred from contracting with any unit of State or local government as a result of a conviction under this Section of any employee or agent of such corporation if the employee so convicted is no longer employed by the corporation and: (1) it has been finally adjudicated not guilty or (2) if it demonstrates to the governmental entity with which it seeks to contract and that entity finds that the commission of the offense was neither authorized, requested, commanded, nor performed by a director, officer or a high managerial agent in behalf of the corporation.

2. The bidder certifies that it is not barred from contracting with the Department by reason of a violation of either Section 33E-3 or Section 33E-4.

E. International Anti-Boycott

1. Section 5 of the International Anti-Boycott Certification Act provides:

§ 5. State contracts. Every contract entered into by the State of Illinois for the manufacture, furnishing, or purchasing of supplies, material, or equipment or for the furnishing of work, labor, or services, in an amount exceeding the threshold for small purchases according to the purchasing laws of this State or \$10,000.00, whichever is less, shall contain certification, as a material condition of the contract, by which the contractor agrees that neither the contractor nor any substantially-owned affiliated company is participating or shall participate in an international boycott in violation of the provisions of the U.S. Export Administration Act of 1979 or the regulations of the U.S. Department of Commerce promulgated under that Act.

2. The bidder makes the certification set forth in Section 5 of the Act.

F. Drug Free Workplace

1. The Illinois "Drug Free Workplace Act" applies to this contract and it is necessary to comply with the provisions of the "Act" if the contractor is a corporation, partnership, or other entity (including a sole proprietorship) which has 25 or more employees.

2. The bidder certifies that if awarded a contract in excess of \$5,000 it will provide a drug free workplace by:

(a) Publishing a statement notifying employees that the unlawful manufacture, distribution, dispensation, possession or use of a controlled substance, including cannabis, is prohibited in the contractor's workplace; specifying the actions that will be taken against employees for violations of such prohibition; and notifying the employee that, as a condition of employment on such contract, the employee shall abide by the terms of the statement, and notify the employer of any criminal drug statute conviction for a violation occurring in the workplace no later than five (5) days after such conviction.

(b) Establishing a drug free awareness program to inform employees about the dangers of drug abuse in the workplace; the contractor's policy of maintaining a drug free workplace; any available drug counseling, rehabilitation, and employee assistance programs; and the penalties that may be imposed upon employees for drug violations.

(c) Providing a copy of the statement required by subparagraph (1) to each employee engaged in the performance of the contract and to post the statement in a prominent place in the workplace.

(d) Notifying the Department within ten (10) days after receiving notice from an employee or otherwise receiving actual notice of the conviction of an employee for a violation of any criminal drug statute occurring in the workplace.

(e) Imposing or requiring, within 30 days after receiving notice from an employee of a conviction or actual notice of such a conviction, an appropriate personnel action, up to and including termination, or the satisfactory participation in a drug abuse assistance or rehabilitation program approved by a federal, state or local health, law enforcement or other appropriate agency.

(f) Assisting employees in selecting a course of action in the event drug counseling, treatment, and rehabilitation is required and indicating that a trained referral team is in place.

(g) Making a good faith effort to continue to maintain a drug free workplace through implementation of the actions and efforts stated in this certification.

G. Debt Delinquency

1. The Illinois Procurement Code provides:

Section 50-11 and 50-12. Debt Delinquency.

The contractor or bidder certifies that it, or any affiliate, is not barred from being awarded a contract under 30 ILCS 500. Section 50-11 prohibits a person from entering into a contract with a State agency if it knows or should know that it, or any affiliate, is delinquent in the payment of any debt to the State as defined by the Debt Collection Board. Section 50-12 prohibits a person from entering into a contract with a State agency if it, or any affiliate, has failed to collect and remit Illinois Use Tax on all sales of tangible personal property into the State of Illinois in accordance with the provisions of the Illinois Use Tax Act. The contractor further acknowledges that the contracting State agency may declare the contract void if this certification is false or if the contractor, or any affiliate, is determined to be delinquent in the payment of any debt to the State during the term of the contract.

H. Sarbanes-Oxley Act of 2002

1. The Illinois Procurement Code provides:

Section 50-60(c).

The contractor certifies in accordance with 30 ILCS 500/50-10.5 that no officer, director, partner or other managerial agent of the contracting business has been convicted of a felony under the Sarbanes-Oxley Act of 2002 or a Class 3 or Class 2 felony under the Illinois Securities Law of 1953 for a period of five years prior to the date of the bid or contract. The contractor acknowledges that the contracting agency shall declare the contract void if this certification is false.

I. Addenda

The contractor or bidder certifies that all relevant addenda have been incorporated in to this contract. Failure to do so may cause the bid to be declared unacceptable.

J. Section 42 of the Environmental Protection Act

The contractor certifies in accordance with 30 ILCS 500/50-12 that the bidder or contractor is not barred from being awarded a contract under this Section which prohibits the bidding on or entering into contracts with the State of Illinois or a State agency by a person or business found by a court or the Pollution Control Board to have committed a willful or knowing violation of Section 42 of the Environmental Protection Act for a period of five years from the date of the order. The contractor acknowledges that the contracting agency may declare the contract void if this certification is false.

K. Apprenticeship and Training Certification (Does not apply to federal aid projects)

In accordance with the provisions of Section 30-22 (6) of the Illinois Procurement Code, the bidder certifies that it is a participant, either as an individual or as part of a group program, in the approved apprenticeship and training programs applicable to each type of work or craft that the bidder will perform with its own forces. The bidder further certifies for work that will be performed by subcontract that each of its subcontractors submitted for approval either (a) is, at the time of such bid, participating in an approved, applicable apprenticeship and training program; or (b) will, prior to commencement of performance of work pursuant to this contract, begin participation in an approved apprenticeship and training program applicable to the work of the subcontract. The Department, at any time before or after award, may require the production of a copy of each applicable Certificate of Registration issued by the United States Department of Labor evidencing such participation by the contractor and any or all of its subcontractors. Applicable apprenticeship and training programs are those that have been approved and registered with the United States Department of Labor. The bidder shall list in the space below, the official name of the program sponsor holding the Certificate of Registration for all of the types of work or crafts in which the bidder is a participant and that will be performed with the bidder's forces. Types of work or craft work that will be subcontracted shall be included and listed as subcontract work. The list shall also indicate any type of work or craft job category that does not have an applicable apprenticeship or training program. **The bidder is responsible for making a complete report and shall make certain that each type of work or craft job category that will be utilized on the project as reported on the Construction Employee Workforce Projection (Form BC-1256) and returned with the bid is accounted for and listed.**

The requirements of this certification and disclosure are a material part of the contract, and the contractor shall require this certification provision to be included in all approved subcontracts. In order to fulfill this requirement, it shall not be necessary that an applicable program sponsor be currently taking or that it will take applications for apprenticeship, training or employment during the performance of the work of this contract.

L. Executive Order Number 1 (2007) Regarding Lobbying on Government Procurements

The bidder hereby warrants and certifies that they have complied and will comply with the requirements set forth in this Order. The requirements of this warrant and certification are a material part of the contract, and the contractor shall require this warrant and certification provision to be included in all approved subcontracts.

M. Disclosure of Business Operations in Iran

Public Act 95-0616 provides that each bid, offer, or proposal submitted for a State contract shall include a disclosure of whether or not the Company acting as the bidder, offeror, or proposing entity, or any of its corporate parents or subsidiaries, within the 24 months before submission of the bid, offer, or proposal had business operations that involved contracts with or provision of supplies or services to the Government of Iran, companies in which the Government of Iran has any direct or indirect equity share, consortiums or projects commissioned by the Government of Iran, or companies involved in consortiums or projects commissioned by the Government of Iran and either of the following conditions apply:

- (1) More than 10% of the Company's revenues produced in or assets located in Iran involve oil-related activities or mineral-extraction activities; less than 75% of the Company's revenues produced in or assets located in Iran involve contracts with or provision of oil-related or mineral-extraction products or services to the Government of Iran or a project or consortium created exclusively by that government; and the Company has failed to take substantial action.
- (2) The Company has, on or after August 5, 1996, made an investment of \$20 million or more, or any combination of investments of at least \$10 million each that in the aggregate equals or exceeds \$20 million in any 12-month period, which directly or significantly contributes to the enhancement of Iran's ability to develop petroleum resources of Iran.

The terms "Business operations", "Company", "Mineral-extraction activities", "Oil-related activities", "Petroleum resources", and "Substantial action" are all defined in the Act.

Failure to make the disclosure required by the Act shall cause the bid, offer or proposal to be considered not responsive. The disclosure will be considered when evaluating the bid, offer, or proposal or awarding the contract. The name of each Company disclosed as doing business or having done business in Iran will be provided to the State Comptroller.

Check the appropriate statement:

Company has no business operations in Iran to disclose.

Company has business operations in Iran as disclosed the attached document.

TO BE RETURNED WITH BID

IV. DISCLOSURES

A. The disclosures hereinafter made by the bidder are each a material representation of fact upon which reliance is placed should the Department enter into the contract with the bidder. The Department may terminate the contract if it is later determined that the bidder rendered a false or erroneous disclosure, and the surety providing the performance bond shall be responsible for completion of the contract.

B. Financial Interests and Conflicts of Interest

1. Section 50-35 of the Illinois Procurement Code provides that all bids of more than \$10,000 shall be accompanied by disclosure of the financial interests of the bidder. This disclosed information for the successful bidder, will be maintained as public information subject to release by request pursuant to the Freedom of Information Act.

The financial interests to be disclosed shall include ownership or distributive income share that is in excess of 5%, or an amount greater than 60% of the annual salary of the Governor, of the bidding entity or its parent entity, whichever is less, unless the contractor or bidder is a publicly traded entity subject to Federal 10K reporting, in which case it may submit its 10K disclosure in place of the prescribed disclosure. If a bidder is a privately held entity that is exempt from Federal 10K reporting, but has more than 400 shareholders, it may submit the information that Federal 10K companies are required to report, and list the names of any person or entity holding any ownership share that is in excess of 5%. The disclosure shall include the names, addresses, and dollar or proportionate share of ownership of each person making the disclosure, their instrument of ownership or beneficial relationship, and notice of any potential conflict of interest resulting from the current ownership or beneficial interest of each person making the disclosure having any of the relationships identified in Section 50-35 and on the disclosure form.

In addition, all disclosures shall indicate any other current or pending contracts, proposals, leases, or other ongoing procurement relationships the bidding entity has with any other unit of state government and shall clearly identify the unit and the contract, proposal, lease, or other relationship.

2. Disclosure Forms. Disclosure Form A is attached for use concerning the individuals meeting the above ownership or distributive share requirements. Subject individuals should be covered each by one form. In addition, a second form (Disclosure Form B) provides for the disclosure of current or pending procurement relationships with other (non-IDOT) state agencies. **The forms must be included with each bid or incorporated by reference.**

C. Disclosure Form Instructions

Form A: For bidders that have previously submitted the information requested in Form A

The Department has retained the Form A disclosures submitted by all bidders responding to these requirements for the April 24, 1998 or any subsequent letting conducted by the Department. The bidder has the option of submitting the information again or the bidder may check the following certification statement indicating that the information previously submitted by the bidder is, as of the date of submission, current and accurate. Before checking this certification, the bidder should carefully review its prior submissions to ensure the Certification is correct. If the Bidder checks the Certification, the Bidder should proceed to Form B instructions.

CERTIFICATION STATEMENT

I have determined that the Form A disclosure information previously submitted is current and accurate, and all forms are hereby incorporated by reference in this bid. Any necessary additional forms or amendments to previously submitted forms are attached to this bid.

(Bidding Company)



Signature of Authorized Representative

Date

Form A: For bidders who have NOT previously submitted the information requested in Form A

If the bidder is a publicly traded entity subject to Federal 10K reporting, the 10K Report may be submitted to meet the requirements of Form A. If a bidder is a privately held entity that is exempt from Federal 10K reporting, but has more than 400 shareholders, it may submit the information that Federal 10K companies are required to report, and list the names of any person or entity holding any ownership share that is in excess of 5%. If a bidder is not subject to Federal 10K reporting, the bidder must determine if any individuals are required by law to complete a financial disclosure form. To do this, the bidder should answer each of the following questions. A "YES" answer indicates Form A must be completed. If the answer to each of the following questions is "NO", then the NOT APPLICABLE STATEMENT on the second page of Form A must be signed and dated by a person that is authorized to execute contracts for the bidding company. Note: These questions are for assistance only and are not required to be completed.

1. Does anyone in your organization have a direct or beneficial ownership share of greater than 5% of the bidding entity or parent entity? YES ___ NO ___
2. Does anyone in your organization have a direct or beneficial ownership share of less than 5%, but which has a value greater than \$102,600.00? YES ___ NO ___
3. Does anyone in your organization receive more than \$102,600.00 of the bidding entity's or parent entity's distributive income? (Note: Distributive income is, for these purposes, any type of distribution of profits. An annual salary is not distributive income.) YES ___ NO ___
4. Does anyone in your organization receive greater than 5% of the bidding entity's or parent entity's total distributive income, but which is less than \$102,600.00? YES ___ NO ___

(Note: Only one set of forms needs to be completed per person per bid even if a specific individual would require a yes answer to more than one question.)

A "YES" answer to any of these questions requires the completion of Form A. The bidder must determine each individual in the bidding entity or the bidding entity's parent company that would cause the questions to be answered "Yes". Each form must be signed and dated by a person that is authorized to execute contracts for your organization. **Photocopied or stamped signatures are not acceptable.** The person signing can be, but does not have to be, the person for which the form is being completed. The bidder is responsible for the accuracy of any information provided.

If the answer to each of the above questions is "NO", then the NOT APPLICABLE STATEMENT on page 2 of Form A must be signed and dated by a person that is authorized to execute contracts for your company.

Form B: Identifying Other Contracts & Procurement Related Information Disclosure Form B must be completed for each bid submitted by the bidding entity. Note: *Checking the NOT APPLICABLE STATEMENT on Form A does not allow the bidder to ignore Form B. Form B must be completed, checked, and dated or the bidder may be considered nonresponsive and the bid will not be accepted.*

The Bidder shall identify, by checking Yes or No on Form B, whether it has any pending contracts (including leases), bids, proposals, or other ongoing procurement relationship with any other (non-IDOT) State of Illinois agency. If "No" is checked, the bidder only needs to complete the check box on the bottom of Form B. If "Yes" is checked, the bidder must do one of the following:

Option I: If the bidder did not submit an Affidavit of Availability to obtain authorization to bid, the bidder must list all non-IDOT State of Illinois agency pending contracts, leases, bids, proposals, and other ongoing procurement relationships. These items may be listed on Form B or on an attached sheet(s). Do not include IDOT contracts. Contracts with cities, counties, villages, etc. are not considered State of Illinois agency contracts and are not to be included. Contracts with other State of Illinois agencies such as the Department of Natural Resources or the Capital Development Board must be included. Bidders who submit Affidavits of Availability are suggested to use Option II.

Option II: If the bidder is required and has submitted an Affidavit of Availability in order to obtain authorization to bid, the bidder may write or type "See Affidavit of Availability" which indicates that the Affidavit of Availability is incorporated by reference and includes all non-IDOT State of Illinois agency pending contracts, leases, bids, proposals, and other ongoing procurement relationships. For any contracts that are not covered by the Affidavit of Availability, the bidder must identify them on Form B or on an attached sheet(s). These might be such things as leases.

D. Bidders Submitting More Than One Bid

Bidders submitting multiple bids may submit one set of forms consisting of all required Form A disclosures and one Form B for use with all bids. Please indicate in the space provided below the bid item that contains the original disclosure forms and the bid items which incorporate the forms by reference.

- The bid submitted for letting item _____ contains the Form A disclosures or Certification Statement and the Form B disclosures. The following letting items incorporate the said forms by reference:

**ILLINOIS DEPARTMENT
OF TRANSPORTATION**

**Form A
Financial Information &
Potential Conflicts of Interest
Disclosure**

Contractor Name		
Legal Address		
City, State, Zip		
Telephone Number	Email Address	Fax Number (if available)

Disclosure of the information contained in this Form is required by the Section 50-35 of the Illinois Procurement Code (30 ILCS 500). Vendors desiring to enter into a contract with the State of Illinois must disclose the financial information and potential conflict of interest information as specified in this Disclosure Form. This information shall become part of the publicly available contract file. This Form A must be completed for bids in excess of \$10,000, and for all open-ended contracts. **A publicly traded company may submit a 10K disclosure (or equivalent if applicable) in satisfaction of the requirements set forth in Form A. See Disclosure Form Instructions.**

DISCLOSURE OF FINANCIAL INFORMATION

1. Disclosure of Financial Information. The individual named below has an interest in the BIDDER (or its parent) in terms of ownership or distributive income share in excess of 5%, or an interest which has a value of more than \$102,600.00 (60% of the Governor's salary as of 7/1/07). **(Make copies of this form as necessary and attach a separate Disclosure Form A for each individual meeting these requirements)**

FOR INDIVIDUAL (type or print information)

NAME: _____

ADDRESS _____

Type of ownership/distributable income share:

stock _____ sole proprietorship _____ Partnership _____ other: (explain on separate sheet):
% or \$ value of ownership/distributable income share: _____

2. Disclosure of Potential Conflicts of Interest. Check "Yes" or "No" to indicate which, if any, of the following potential conflict of interest relationships apply. If the answer to any question is "Yes", please attach additional pages and describe.

(a) State employment, currently or in the previous 3 years, including contractual employment of services. Yes ___ No ___

If your answer is yes, please answer each of the following questions.

1. Are you currently an officer or employee of either the Capitol Development Board or the Illinois Toll Highway Authority? Yes ___ No ___

2. Are you currently appointed to or employed by any agency of the State of Illinois? If you are currently appointed to or employed by any agency of the State of Illinois, and your annual salary exceeds \$102,600.00, (60% of the Governor's salary as of 7/1/07) provide the name the State agency for which you are employed and your annual salary. _____

RETURN WITH BID/OFFER

- 3. If you are currently appointed to or employed by any agency of the State of Illinois, and your annual salary exceeds \$102,600.00, (60% of the Governor's salary as of 7/1/07) are you entitled to receive (i) more than 7 1/2% of the total distributable income of your firm, partnership, association or corporation, or (ii) an amount in excess of the salary of the Governor? Yes ___ No ___
- 4. If you are currently appointed to or employed by any agency of the State of Illinois, and your annual salary exceeds \$102,600.00, (60% of the Governor's salary as of 7/1/07) are you and your spouse or minor children entitled to receive (i) more than 15 % in the aggregate of the total distributable income of your firm, partnership, association or corporation, or (ii) an amount in excess of 2 times the salary of the Governor? Yes ___ No ___

(b) State employment of spouse, father, mother, son, or daughter, including contractual employment services in the previous 2 years.

Yes ___ No ___

If your answer is yes, please answer each of the following questions.

- 1. Is your spouse or any minor children currently an officer or employee of the Capitol Development Board or the Illinois Toll Highway Authority? Yes ___ No ___
- 2. Is your spouse or any minor children currently appointed to or employed by any agency of the State of Illinois? If your spouse or minor children is/are currently appointed to or employed by any agency of the State of Illinois, and his/her annual salary exceeds \$102,600.00, (60 % of the Governor's salary as of 7/1/07) provide the name of your spouse and/or minor children, the name of the State agency for which he/she is employed and his/her annual salary. _____

- 3. If your spouse or any minor children is/are currently appointed to or employed by any agency of the State of Illinois, and his/her annual salary exceeds \$102,600.00, (60% of the salary of the Governor as of 7/1/07) are you entitled to receive (i) more then 71/2% of the total distributable income of your firm, partnership, association or corporation, or (ii) an amount in excess of the salary of the Governor? Yes ___ No ___
- 4. If your spouse or any minor children are currently appointed to or employed by any agency of the State of Illinois, and his/her annual salary exceeds \$102,600.00, (60% of the Governor's salary as of 7/1/07) are you and your spouse or minor children entitled to receive (i) more than 15 % in the aggregate of the total distributable income of your firm, partnership, association or corporation, or (ii) an amount in excess of 2 times the salary of the Governor? Yes ___ No ___

(c) Elective status; the holding of elective office of the State of Illinois, the government of the United States, any unit of local government authorized by the Constitution of the State of Illinois or the statutes of the State of Illinois currently or in the previous 3 years.

Yes ___ No ___

(d) Relationship to anyone holding elective office currently or in the previous 2 years; spouse, father, mother, son, or daughter.

Yes ___ No ___

(e) Appointive office; the holding of any appointive government office of the State of Illinois, the United States of America, or any unit of local government authorized by the Constitution of the State of Illinois or the statutes of the State of Illinois, which office entitles the holder to compensation in excess of the expenses incurred in the discharge of that office currently or in the previous 3 years.

Yes ___ No ___

(f) Relationship to anyone holding appointive office currently or in the previous 2 years; spouse, father, mother, son, or daughter.

Yes ___ No ___

(g) Employment, currently or in the previous 3 years, as or by any registered lobbyist of the State government.

Yes ___ No ___

RETURN WITH BID/OFFER

(h) Relationship to anyone who is or was a registered lobbyist in the previous 2 years; spouse, father, mother, son, or daughter. Yes ___ No ___

(i) Compensated employment, currently or in the previous 3 years, by any registered election or reelection committee registered with the Secretary of State or any county clerk of the State of Illinois, or any political action committee registered with either the Secretary of State or the Federal Board of Elections. Yes ___ No ___

(j) Relationship to anyone; spouse, father, mother, son, or daughter; who was a compensated employee in the last 2 years by any registered election or re-election committee registered with the Secretary of State or any county clerk of the State of Illinois, or any political action committee registered with either the Secretary of State or the Federal Board of Elections. Yes ___ No ___

APPLICABLE STATEMENT

This Disclosure Form A is submitted on behalf of the INDIVIDUAL named on previous page.

Completed by: _____ Date _____
Signature of Individual or Authorized Representative

NOT APPLICABLE STATEMENT

I have determined that no individuals associated with this organization meet the criteria that would require the completion of this Form A.

This Disclosure Form A is submitted on behalf of the CONTRACTOR listed on the previous page.

_____ Date _____
Signature of Authorized Representative

RETURN WITH BID/OFFER

ILLINOIS DEPARTMENT
OF TRANSPORTATION

Form B
Other Contracts &
Procurement Related Information
Disclosure

Contractor Name		
Legal Address		
City, State, Zip		
Telephone Number	Email Address	Fax Number (if available)

Disclosure of the information contained in this Form is required by the Section 50-35 of the Illinois Procurement Act (30 ILCS 500). This information shall become part of the publicly available contract file. This Form B must be completed for bids in excess of \$10,000, and for all open-ended contracts.

DISCLOSURE OF OTHER CONTRACTS AND PROCUREMENT RELATED INFORMATION

1. Identifying Other Contracts & Procurement Related Information. The BIDDER shall identify whether it has any pending contracts (including leases), bids, proposals, or other ongoing procurement relationship with any other State of Illinois agency: Yes ___ No ___

If "No" is checked, the bidder only needs to complete the signature box on the bottom of this page.

2. If "Yes" is checked. Identify each such relationship by showing State of Illinois agency name and other descriptive information such as bid or project number (attach additional pages as necessary). SEE DISCLOSURE FORM INSTRUCTIONS:

THE FOLLOWING STATEMENT MUST BE CHECKED

<input type="checkbox"/>	_____	_____
	Signature of Authorized Representative	Date

RETURN WITH BID

SPECIAL NOTICE TO CONTRACTORS

The following requirements of the Illinois Department of Human Rights' Rules and Regulations are applicable to bidders on all construction contracts advertised by the Illinois Department of Transportation:

CONSTRUCTION EMPLOYEE UTILIZATION PROJECTION

- (a) All bidders on construction contracts shall complete and submit, along with and as part of their bids, a Bidder's Employee Utilization Form (Form BC-1256) setting forth a projection and breakdown of the total workforce intended to be hired and/or allocated to such contract work by the bidder including a projection of minority and female employee utilization in all job classifications on the contract project.
- (b) The Department of Transportation shall review the Employee Utilization Form, and workforce projections contained therein, of the contract awardee to determine if such projections reflect an underutilization of minority persons and/or women in any job classification in accordance with the Equal Employment Opportunity Clause and Section 7.2 of the Illinois Department of Human Rights' Rules and Regulations for Public Contracts adopted as amended on September 17, 1980. If it is determined that the contract awardee's projections reflect an underutilization of minority persons and/or women in any job classification, it shall be advised in writing of the manner in which it is underutilizing and such awardee shall be considered to be in breach of the contract unless, prior to commencement of work on the contract project, it submits revised satisfactory projections or an acceptable written affirmative action plan to correct such underutilization including a specific timetable geared to the completion stages of the contract.
- (c) The Department of Transportation shall provide to the Department of Human Rights a copy of the contract awardee's Employee Utilization Form, a copy of any required written affirmative action plan, and any written correspondence related thereto. The Department of Human Rights may review and revise any action taken by the Department of Transportation with respect to these requirements.

RETURN WITH BID

**Contract No. 64D44
ROCK ISLAND County
Section D2 SPRING RS 2007-12
Route FAU 5773/5855
District 2 Construction Funds**

PART II. WORKFORCE PROJECTION - continued

- B. Included in "Total Employees" under Table A is the total number of **new hires** that would be employed in the event the undersigned bidder is awarded this contract.

The undersigned bidder projects that: (number) _____ new hires would be recruited from the area in which the contract project is located; and/or (number) _____ new hires would be recruited from the area in which the bidder's principal office or base of operation is located.

- C. Included in "Total Employees" under Table A is a projection of numbers of persons to be employed directly by the undersigned bidder as well as a projection of numbers of persons to be employed by subcontractors.

The undersigned bidder estimates that (number) _____ persons will be directly employed by the prime contractor and that (number) _____ persons will be employed by subcontractors.

PART III. AFFIRMATIVE ACTION PLAN

- A. The undersigned bidder understands and agrees that in the event the foregoing minority and female employee utilization projection included under **PART II** is determined to be an underutilization of minority persons or women in any job category, and in the event that the undersigned bidder is awarded this contract, he/she will, prior to commencement of work, develop and submit a written Affirmative Action Plan including a specific timetable (geared to the completion stages of the contract) whereby deficiencies in minority and/or female employee utilization are corrected. Such Affirmative Action Plan will be subject to approval by the contracting agency and the **Department of Human Rights**.
- B. The undersigned bidder understands and agrees that the minority and female employee utilization projection submitted herein, and the goals and timetable included under an Affirmative Action Plan if required, are deemed to be part of the contract specifications.

Company _____ Telephone Number _____

Address _____

NOTICE REGARDING SIGNATURE		
The Bidder's signature on the Proposal Signature Sheet will constitute the signing of this form. The following signature block needs to be completed if revisions are required.		
Signature: <input type="checkbox"/> _____	Title: _____	Date: _____

- Instructions: All tables must include subcontractor personnel in addition to prime contractor personnel.
- Table A - Include both the number of employees that would be hired to perform the contract work and the total number currently employed (Table B) that will be allocated to contract work, and include all apprentices and on-the-job trainees. The "Total Employees" column should include all employees including all minorities, apprentices and on-the-job trainees to be employed on the contract work.
 - Table B - Include all employees currently employed that will be allocated to the contract work including any apprentices and on-the-job trainees currently employed.
 - Table C - Indicate the racial breakdown of the total apprentices and on-the-job trainees shown in Table A.

RETURN WITH BID

**Contract No. 64D44
ROCK ISLAND County
Section D2 SPRING RS 2007-12
Route FAU 5773/5855
District 2 Construction Funds**

PROPOSAL SIGNATURE SHEET

The undersigned bidder hereby makes and submits this bid on the subject Proposal, thereby assuring the Department that all requirements of the Invitation for Bids and rules of the Department have been met, that there is no misunderstanding of the requirements of paragraph 3 of this Proposal, and that the contract will be executed in accordance with the rules of the Department if an award is made on this bid.

Firm Name _____
(IF AN INDIVIDUAL) Signature of Owner _____
Business Address _____

Firm Name _____
By _____
(IF A CO-PARTNERSHIP) Business Address _____

Name and Address of All Members of the Firm:

Corporate Name _____
By _____
Signature of Authorized Representative _____
Typed or printed name and title of Authorized Representative _____
(IF A CORPORATION) Attest _____
Signature _____
(IF A JOINT VENTURE, USE THIS SECTION
FOR THE MANAGING PARTY AND THE
SECOND PARTY SHOULD SIGN BELOW) Business Address _____

Corporate Name _____
By _____
Signature of Authorized Representative _____
Typed or printed name and title of Authorized Representative _____
(IF A JOINT VENTURE) Attest _____
Signature _____
Business Address _____

If more than two parties are in the joint venture, please attach an additional signature sheet.



**Illinois Department
of Transportation**

Return with Bid

**Division of Highways
Proposal Bid Bond
(Effective November 1, 1992)**

Item No. _____

Letting Date _____

KNOW ALL MEN BY THESE PRESENTS, That We _____

as PRINCIPAL, and _____

_____ as SURETY, are held jointly, severally and firmly bound unto the STATE OF ILLINOIS in the penal sum of 5 percent of the total bid price, or for the amount specified in Article 102.09 of the "Standard Specifications for Road and Bridge Construction" in effect on the date of invitation for bids, whichever is the lesser sum, well and truly to be paid unto said STATE OF ILLINOIS, for the payment of which we bind ourselves, our heirs, executors, administrators, successors and assigns.

THE CONDITION OF THE FOREGOING OBLIGATION IS SUCH, that whereas, the PRINCIPAL has submitted a bid proposal to the STATE OF ILLINOIS, acting through the Department of Transportation, for the improvement designated by the Transportation Bulletin Item Number and Letting Date indicated above.

NOW, THEREFORE, if the Department shall accept the bid proposal of the PRINCIPAL; and if the PRINCIPAL shall, within the time and as specified in the bidding and contract documents, submit a DBE Utilization Plan that is accepted and approved by the Department; and if, after award by the Department, the PRINCIPAL shall enter into a contract in accordance with the terms of the bidding and contract documents including evidence of the required insurance coverages and providing such bond as specified with good and sufficient surety for the faithful performance of such contract and for the prompt payment of labor and material furnished in the prosecution thereof; or if, in the event of the failure of the PRINCIPAL to make the required DBE submission or to enter into such contract and to give the specified bond, the PRINCIPAL pays to the Department the difference not to exceed the penalty hereof between the amount specified in the bid proposal and such larger amount for which the Department may contract with another party to perform the work covered by said bid proposal, then this obligation shall be null and void, otherwise, it shall remain in full force and effect.

IN THE EVENT the Department determines the PRINCIPAL has failed to comply with any requirement as set forth in the preceding paragraph, then Surety shall pay the penal sum to the Department within fifteen (15) days of written demand therefor. If Surety does not make full payment within such period of time, the Department may bring an action to collect the amount owed. Surety is liable to the Department for all its expenses, including attorney's fees, incurred in any litigation in which it prevails either in whole or in part.

In TESTIMONY WHEREOF, the said PRINCIPAL and the said SURETY have caused this instrument to be signed by their respective officers this _____ day of _____ A.D., _____.

PRINCIPAL

(Company Name)

(Company Name)

By: _____
(Signature & Title)

By: _____
(Signature of Attorney-in-Fact)

Notary Certification for Principal and Surety

STATE OF ILLINOIS,

County of _____

I, _____, a Notary Public in and for said County, do hereby certify that

_____ and _____
(Insert names of individuals signing on behalf of PRINCIPAL & SURETY)

who are each personally known to me to be the same persons whose names are subscribed to the foregoing instrument on behalf of PRINCIPAL and SURETY, appeared before me this day in person and acknowledged respectively, that they signed and delivered said instrument as their free and voluntary act for the uses and purposes therein set forth.

Given under my hand and notarial seal this _____ day of _____ A.D. _____

My commission expires _____

Notary Public

In lieu of completing the above section of the Proposal Bid Form, the Principal may file an Electronic Bid Bond. By signing the proposal and marking the check box next to the Signature and Title line below, the Principal is ensuring the identified electronic bid bond has been executed and the Principal and Surety are firmly bound unto the State of Illinois under the conditions of the bid bond as shown above.

Electronic Bid Bond ID#

Company / Bidder Name



Signature and Title

PROPOSAL ENVELOPE



PROPOSALS

for construction work advertised for bids by the
Illinois Department of Transportation

Item No.	Item No.	Item No.

Submitted By:

Name:
Address:
Phone No.

Bidders should use an IDOT proposal envelope or affix this form to the front of a 10" x 13" envelope for the submittal of bids. If proposals are mailed, they should be enclosed in a second or outer envelope addressed to:

Engineer of Design and Environment - Room 326
Illinois Department of Transportation
2300 South Dirksen Parkway
Springfield, Illinois 62764

NOTICE

Individual bids, including Bid Bond and/or supplemental information if required, should be securely stapled.

CONTRACTOR OFFICE COPY OF CONTRACT SPECIFICATIONS

NOTICE

None of the following material needs to be returned with the bid package unless the special provisions require documentation and/or other information to be submitted.

**Contract No. 64D44
ROCK ISLAND County
Section D2 SPRING RS 2007-12
Route FAU 5773/5855
District 2 Construction Funds**



Illinois Department of Transportation



NOTICE TO BIDDERS

- 1. TIME AND PLACE OF OPENING BIDS.** Sealed proposals for the improvement described herein will be received by the Department of Transportation at the Harry R. Hanley Building, 2300 South Dirksen Parkway, in Springfield, Illinois until 10:00 o'clock a.m., March 7, 2008. All bids will be gathered, sorted, publicly opened and read in the auditorium at the Department of Transportation's Harry R. Hanley Building shortly after the 10:00 a.m. cut off time.
- 2. DESCRIPTION OF WORK.** The proposed improvement is identified and advertised for bids in the Invitation for Bids as:

**Contract No. 64D44
ROCK ISLAND County
Section D2 SPRING RS 2007-12
Route FAU 5773/5855
District 2 Construction Funds**

This project consists of widening, patching, and resurfacing on the south frontage road located between Archer Drive and 7th Street and sidewalk repairs along the north frontage road between Kennedy Road and 7th Street in East Moline.

- 3. INSTRUCTIONS TO BIDDERS.** (a) This Notice, the invitation for bids, proposal and letter of award shall, together with all other documents in accordance with Article 101.09 of the Standard Specifications for Road and Bridge Construction, become part of the contract. Bidders are cautioned to read and examine carefully all documents, to make all required inspections, and to inquire or seek explanation of the same prior to submission of a bid.

(b) State law, and, if the work is to be paid wholly or in part with Federal-aid funds, Federal law requires the bidder to make various certifications as a part of the proposal and contract. By execution and submission of the proposal, the bidder makes the certification contained therein. A false or fraudulent certification shall, in addition to all other remedies provided by law, be a breach of contract and may result in termination of the contract.
- 4. AWARD CRITERIA AND REJECTION OF BIDS.** This contract will be awarded to the lowest responsive and responsible bidder considering conformity with the terms and conditions established by the Department in the rules, Invitation for Bids and contract documents. The issuance of plans and proposal forms for bidding based upon a prequalification rating shall not be the sole determinant of responsibility. The Department reserves the right to determine responsibility at the time of award, to reject any or all proposals, to readvertise the proposed improvement, and to waive technicalities.

By Order of the
Illinois Department of Transportation

Milton R. Sees, Secretary

BD 351 (Rev. 01/2003)

INDEX
FOR
SUPPLEMENTAL SPECIFICATIONS
AND RECURRING SPECIAL PROVISIONS

Adopted January 1, 2008

This index contains a listing of SUPPLEMENTAL SPECIFICATIONS and frequently used RECURRING SPECIAL PROVISIONS.

ERRATA Standard Specifications for Road and Bridge Construction (Adopted 1-1-07) (Revised 1-1-08)

SUPPLEMENTAL SPECIFICATIONS

<u>Std. Spec. Sec.</u>	<u>Page No.</u>
205 Embankment	1
251 Mulch	2
253 Planting Woody Plants	3
280 Temporary Erosion Control	5
443 Reflective Crack Control Treatment	6
502 Excavation for Structures	9
503 Concrete Structures	10
505 Steel Structures	11
540 Box Culverts	12
633 Removing and Reerecting Guardrail and Terminals	13
672 Sealing Abandoned Water Wells	14
701 Work Zone Traffic Control and Protection	15
838 Breakaway Devices	16
1004 Coarse Aggregates	17
1020 Portland Cement Concrete	18
1022 Concrete Curing Materials	20
1042 Precast Concrete Products	21
1062 Reflective Crack Control System	22
1069 Pole and Tower	24
1081 Materials for Planting	27
1083 Elastomeric Bearings	29
1102 Hot-Mix Asphalt Equipment	30

RECURRING SPECIAL PROVISIONS

The following RECURRING SPECIAL PROVISIONS indicated by an "X" are applicable to this contract and are included by reference:

<u>CHECK SHEET #</u>	<u>PAGE NO.</u>
1 Additional State Requirements For Federal-Aid Construction Contracts (Eff. 2-1-69) (Rev. 1-1-07)	31
2 Subletting of Contracts (Federal-Aid Contracts) (Eff. 1-1-88) (Rev. 5-1-93)	33
3 X EEO (Eff. 7-21-78) (Rev. 11-18-80)	34
4 X Specific Equal Employment Opportunity Responsibilities Non Federal-Aid Contracts (Eff. 3-20-69) (Rev. 1-1-94)	44
5 X Required Provisions - State Contracts (Eff. 4-1-65) (Rev. 1-1-07)	49
6 Reserved	54
7 Reserved	55
8 Haul Road Stream Crossings, Other Temporary Stream Crossings, and In-Stream Work Pads (Eff. 1-2-92) (Rev. 1-1-98)	56
9 Construction Layout Stakes Except for Bridges (Eff. 1-1-99) (Rev. 1-1-07)	57
10 Construction Layout Stakes (Eff. 5-1-93) (Rev. 1-1-07)	60
11 Use of Geotextile Fabric for Railroad Crossing (Eff. 1-1-95) (Rev. 1-1-07)	63
12 Subsealing of Concrete Pavements (Eff. 11-1-84) (Rev. 1-1-07)	65
13 Hot-Mix Asphalt Surface Removal (Cold Milling) (Eff. 11-1-87) (Rev. 1-1-07)	69
14 Pavement and Shoulder Resurfacing (Eff. 2-1-00) (Rev. 1-1-07)	71
15 PCC Partial Depth Hot-Mix Asphalt Patching (Eff. 1-1-98) (Rev. 1-1-07)	72
16 Patching with Hot-Mix Asphalt Overlay Removal (Eff. 10-1-95) (Rev. 1-1-07)	74
17 Polymer Concrete (Eff. 8-1-95) (Rev. 1-1-08)	75
18 PVC Pipeliner (Eff. 4-1-04) (Rev. 1-1-07)	77
19 Pipe Underdrains (Eff. 9-9-87) (Rev. 1-1-07)	78
20 Guardrail and Barrier Wall Delineation (Eff. 12-15-93) (Rev. 1-1-97)	79
21 Bicycle Racks (Eff. 4-1-94) (Rev. 1-1-07)	83
22 Temporary Modular Glare Screen System (Eff. 1-1-00) (Rev. 1-1-07)	85
23 Temporary Portable Bridge Traffic Signals (Eff. 8-1-03) (Rev. 1-1-07)	87
24 Work Zone Public Information Signs (Eff. 9-1-02) (Rev. 1-1-07)	89
25 Night Time Inspection of Roadway Lighting (Eff. 5-1-96)	90
26 English Substitution of Metric Bolts (Eff. 7-1-96)	91
27 English Substitution of Metric Reinforcement Bars (Eff. 4-1-96) (Rev. 1-1-03)	92
28 Calcium Chloride Accelerator for Portland Cement Concrete (Eff. 1-1-01)	93
29 Quality Control of Concrete Mixtures at the Plant-Single A (Eff. 8-1-00) (Rev. 1-1-04)	94
30 Quality Control of Concrete Mixtures at the Plant-Double A (Eff. 8-1-00) (Rev. 1-1-04)	100
31 Quality Control/Quality Assurance of Concrete Mixtures (Eff. 4-1-92) (Rev. 1-1-07)	108

TABLE OF CONTENTS

LOCATION OF PROJECT	1
DESCRIPTION OF PROJECT	1
TRAFFIC CONTROL PLAN	1
MAINTENANCE OF TRAFFIC.....	2
EXCAVATING AND GRADING EXISTING SHOULDER	3
HOT-MIX ASPHALT SURFACE REMOVAL, 2"	3
TOPSOIL FURNISH AND PLACE, VARIABLE DEPTH	3
CEMENT (BDE)	4
EQUIPMENT RENTAL RATES (BDE).....	6
HOT-MIX ASPHALT - FIELD VOIDS IN THE MINERAL AGGREGATE (BDE)	7
PAYMENTS TO SUBCONTRACTORS (BDE)	9
RECLAIMED ASPHALT PAVEMENT (RAP) (BDE)	10
REFLECTIVE SHEETING ON CHANNELIZING DEVICES (BDE)	16
SUBCONTRACTOR MOBILIZATION PAYMENTS (BDE)	17
WORKING DAYS (BDE)	17
BITUMINOUS MATERIALS COST ADJUSTMENTS (BDE) (RETURN FORM WITH BID)	17
PROJECT LABOR AGREEMENT	20

STATE OF ILLINOIS

SPECIAL PROVISIONS

The following Special Provisions supplement the "Standard Specifications for Road and Bridge Construction," adopted January 1, 2007, the latest edition of the "Manual on Uniform Traffic Control Devices for Streets and Highways," and the "Manual of Test Procedures for Materials" in effect on the date of invitation for bids, and the Supplemental Specifications and Recurring Special Provisions indicated on the Check Sheet included herein which apply to and govern the construction of ROUTE: FAU Route 5773 and 5855, SECTION: D2 SPRING RS 2007-12, COUNTY: Rock Island, CONTRACT: 64D44, and in case of conflict with any part or parts of said Specifications, the said Special Provisions shall take precedence and shall govern.

LOCATION OF PROJECT

Work will be on both the South and the North service roads along Avenue of the Cities between Kennedy Drive and Archer Drive in East Moline.

DESCRIPTION OF PROJECT

Work will include widening, pavement patching and resurfacing, along with some sidewalk improvements on the south service road between Archer Drive and 7th Street and sidewalk repairs along the North service road between Kennedy Drive and 7th Street.

TRAFFIC CONTROL PLAN

Traffic Control shall be according to the applicable sections of the Standard Specifications for Road and Bridge Construction, the applicable guidelines contained in the National Manual on Uniform Traffic Control Devices for Streets and Highways, Illinois Supplement to the National Manual on Uniform Traffic Control Devices, these special provisions, and any special details and Highway Standards contained herein and in the plans.

Special attention is called to Articles 107.09 and 107.14 of the Standard Specifications for Road and Bridge Construction and the following Highway Standards relating to traffic control.

Standards:

701001	701006	701301	701311	701501	701801
701901	720001	720011	728001	729001	

Details:

Typical Pavement Markings (41.1)

Signs:

No bracing shall be allowed on post-mounted signs.

Post-mounted signs shall be installed using standards 720011, 728001, 729001, 4" x 4" wood posts, or any other "break away" connection supported by a FHWA letter provided to the Resident Engineer.

"LOW SHOULDER" signs (W8-9(0)-48 shall be used as directed by the Engineer.

"BUMP" signs (W8-1(0)48) shall be installed as directed by the Engineer.

"UNEVEN LANES" (W8-11(O)48 signs shall be installed as directed by the Engineer.

The cost of furnishing, erecting, maintaining, covering and removing the signs shall be included in the cost of TRAFFIC CONTROL AND PROTECTION STANDARD 701501.

Flaggers:

Flaggers shall comply with all requirements contained in the Department's "Flagger Handbook" With the following exception: The ANSI Class 2 vest will not be supplied by the Department.

In addition to the flaggers shown on applicable standards, on major side roads listed below, flaggers shall be required on all legs of the intersection. Major side roads for this project shall be 11th Street.

MAINTENANCE OF TRAFFIC

The milling operations, pavement patching, and the hot-mix asphalt resurfacing shall be completed using Traffic Control and Protection Standard 701501.

The sidewalk work shall be completed using Traffic Control and Protection Standard 701801. When working on the sidewalks, there is no sidewalk on the other side of the road to direct the pedestrians to. Because of this situation, the mid-block closure with the vertical barricades as shown in Standard 701801 is to be used. The 3' shoulder between the sidewalk and the edge of the pavement shall be used as the temporary sidewalk.

The aggregate shoulder wedge shall be placed using Traffic Control and Protection Standard 701501.

The paint pavement markings shall be completed using Traffic Control and Protection Standard 701311.

Short term pavement marking, placement, and removal shall be completed using Traffic Control and Protection Standard 701501.

The mainline shall be kept open to one-way traffic at all times during working hours and two-way traffic during non-working hours.

EXCAVATING AND GRADING EXISTING SHOULDER

This work shall be completed with the applicable portions of Section 202 of the Standard Specifications, as shown in the plans, as directed by the Engineer, and as specified herein.

The area to be excavated has been mostly covered over by several inches of Asphalt material and several entrances have been extended into this area up to the edge of the pavement. Some of the entrances were constructed with concrete. The contractor will be required to saw cut through these entrances as shown on the plans. The estimated length of saw cuts is 395 feet. Also included in this work will be the removal and proper disposal of these portions of entrances located between the sidewalk and the edge of the pavement.

This work will be paid for at the contract unit price per UNIT for EXCAVATING AND GRADING EXISTING SHOULDER.

HOT-MIX ASPHALT SURFACE REMOVAL, 2”

This work shall be completed with the applicable portions of Section 440 of the Standard Specifications, as shown in the plans, as directed by the Engineer, and as specified herein.

The area where hot-mix asphalt surface removal, 2 inch is required, the transition areas from 0 inch to 2 inches deep and from 2 inches deep back to 0” will also be paid for as two inch removal.

This work will be paid for at the contract unit price per SQ. YD. for HOT-MIX ASPHALT SURFACE REMOVAL, 2”.

TOPSOIL FURNISH AND PLACE, VARIABLE DEPTH

This work shall be completed with the applicable portions of Section 211 of the Standard Specifications, as shown in the plans, as directed by the Engineer, and as specified herein.

The topsoil is to be placed along the newly constructed sidewalk, feathered out to the existing surface at 4 foot from the edge of the sidewalk.

This work will be paid for at the contract unit price per SQ. YD. for TOPSOIL FURNISH AND PLACE, VARIABLE DEPTH.

CEMENT (BDE)

Effective: January 1, 2007

Revised: November 1, 2007

Revise Section 1001 of the Standard Specifications to read:

“SECTION 1001. CEMENT

1001.01 Cement Types. Cement shall be according to the following.

- (a) Portland Cement. Acceptance of portland cement shall be according to the current Bureau of Materials and Physical Research’s Policy Memorandum, “Portland or Blended Cement Acceptance Procedure for Qualified and Non-Qualified Plants”.

Portland cement shall be according to ASTM C 150, and shall meet the standard physical and chemical requirements. Type I or Type II may be used for cast-in-place, precast, and precast prestressed concrete. Type III may be used according to Article 1020.04, or when approved by the Engineer. All other cements referenced in ASTM C 150 may be used when approved by the Engineer.

The total of all organic processing additions shall be a maximum of 1.0 percent by weight (mass) of the cement and the total of all inorganic processing additions shall be a maximum of 4.0 percent by weight (mass) of the cement. Organic processing additions shall be limited to grinding aids that improve the flowability of cement, reduce pack set, and improve grinding efficiency. Inorganic processing additions shall be limited to granulated blast-furnace slag according to the chemical requirements of AASHTO M 302 and Class C fly ash according to the chemical requirements of AASHTO M 295.

- (b) Portland-Pozzolan Cement. Acceptance of portland-pozzolan cement shall be according to the current Bureau of Materials and Physical Research’s Policy Memorandum, “Portland or Blended Cement Acceptance Procedure for Qualified and Non-Qualified Plants”.

Portland-pozzolan cement shall be according to ASTM C 595 and shall meet the standard physical and chemical requirements. Type IP or I(PM) may be used for cast-in-place, precast, and precast prestressed concrete, except when Class PP concrete is used. The pozzolan constituent for Type IP shall be a maximum of 21 percent of the weight (mass) of the portland-pozzolan cement. All other cements referenced in ASTM C 595 may be used when approved by the Engineer.

For cast-in-place construction, portland-pozzolan cements shall not be used in concrete mixtures when the air temperature is below 40 °F (4 °C) without permission of the Engineer. If permission is given, the mix design strength requirement may require the Contractor to increase the cement or eliminate the cement factor reduction for a water-reducing or high range water-reducing admixture which is permitted according to Article 1020.05(b).

The total of all organic processing additions shall be a maximum of 1.0 percent by weight (mass) of the cement. Organic processing additions shall be limited to grinding aids as defined in (a) above. Inorganic processing additions shall not be used.

- (c) Portland Blast-Furnace Slag Cement. Acceptance of portland blast-furnace slag cement shall be according to the current Bureau of Materials and Physical Research's Policy Memorandum, "Portland or Blended Cement Acceptance Procedure for Qualified and Non-Qualified Plants".

Portland blast-furnace slag cement shall be according to ASTM C 595 and shall meet the standard physical and chemical requirements. Type I(SM) slag-modified portland cement may be used for cast-in-place, precast, and precast prestressed concrete, except when Class PP concrete is used. All other cements referenced in ASTM C 595 may be used when approved by the Engineer.

For cast-in-place construction, portland blast-furnace slag cements shall not be used in concrete mixtures when the air temperature is below 40 °F (4 °C) without permission of the Engineer. If permission is given, the mix design strength requirement may require the Contractor to increase the cement or eliminate the cement factor reduction for a water-reducing or high range water-reducing admixture which is permitted according to Article 1020.05(b).

The total of all organic processing additions shall be a maximum of 1.0 percent by weight (mass) of the cement. Organic processing additions shall be limited to grinding aids as defined in (a) above. Inorganic processing additions shall not be used.

- (d) Rapid Hardening Cement. Rapid hardening cement shall be used according to Article 1020.04 or when approved by the Engineer. The cement shall be on the Department's current "Approved List of Packaged, Dry, Rapid Hardening Cementitious Materials for Concrete Repairs", and shall be according to the following.

- (1) The cement shall have a maximum final set of 25 minutes, according to Illinois Modified ASTM C 191.
- (2) The cement shall have a minimum compressive strength of 2000 psi (13,800 kPa) at 3.0 hours, and 4000 psi (27,600 kPa) at 24.0 hours, according to Illinois Modified ASTM C 109.
- (3) The cement shall have a maximum drying shrinkage of 0.050 percent at seven days, according to Illinois Modified ASTM C 596.
- (4) The cement shall have a maximum expansion of 0.020 percent at 14 days, according to Illinois Modified ASTM C 1038.

(5) The cement shall have a minimum 80 percent relative dynamic modulus of elasticity; and shall not have a weight (mass) gain in excess of 0.15 percent or a weight (mass) loss in excess of 1.0 percent, after 100 cycles, according to Illinois Modified AASHTO T 161, Procedure B. At 100 cycles, the specimens are measured and weighed at 73 °F (23 °C).

(e) Calcium Aluminate Cement. Calcium aluminate cement shall be used when specified by the Engineer. The cement shall meet the standard physical requirements for Type I cement according to ASTM C 150, except the time of setting shall not apply. The chemical requirements shall be determined according to ASTM C 114 and shall be as follows: minimum 38 percent aluminum oxide (Al₂O₃), maximum 42 percent calcium oxide (CaO), maximum 1 percent magnesium oxide (MgO), maximum 0.4 percent sulfur trioxide (SO₃), maximum 1 percent loss on ignition, and maximum 3.5 percent insoluble residue.

1001.02 Uniformity of Color. Cement contained in single loads or in shipments of several loads to the same project shall not have visible differences in color.

1001.03 Mixing Brands and Types. Different brands or different types of cement from the same manufacturing plant, or the same brand or type from different plants shall not be mixed or used alternately in the same item of construction unless approved by the Engineer.

1001.04 Storage. Cement shall be stored and protected against damage, such as dampness which may cause partial set or hardened lumps. Different brands or different types of cement from the same manufacturing plant, or the same brand or type from different plants shall be kept separate.”

EQUIPMENT RENTAL RATES (BDE)

Effective: August 2, 2007

Revised: January 2, 2008

Replace the second and third paragraphs of Article 105.07(b)(4)a. of the Standard Specifications with the following:

“Equipment idled which cannot be used on other work, and which is authorized to standby on the project site by the Engineer, will be paid for according to Article 109.04(b)(4).”

Replace Article 109.04(b)(4) of the Standard Specifications with the following:

“(4) Equipment. Equipment used for extra work shall be authorized by the Engineer. The equipment shall be specifically described, be of suitable size and capacity for the work to be performed, and be in good operating condition. For such equipment, the Contractor will be paid as follows.

- a. Contractor Owned Equipment. Contractor owned equipment will be paid for by the hour using the applicable FHWA hourly rate from the “Equipment Watch Rental Rate Blue Book” (Blue Book) in effect when the force account work begins. The FHWA hourly rate is calculated as follows.

$$\text{FHWA hourly rate} = (\text{monthly rate}/176) \times (\text{model year adj.}) \times (\text{Illinois adj.}) + \text{EOC}$$

Where: EOC = Estimated Operating Costs per hour (from the Blue Book)

The time allowed will be the actual time the equipment is operating on the extra work. For the time required to move the equipment to and from the site of the extra work and any authorized idle (standby) time, payment will be made at the following hourly rate: 0.5 x (FHWA hourly rate - EOC).

All time allowed shall fall within the working hours authorized for the extra work.

The rates above include the cost of fuel, oil, lubrication, supplies, small tools, necessary attachments, repairs, overhaul and maintenance of any kind, depreciation, storage, overhead, profits, insurance, and all incidentals. The rates do not include labor.

The Contractor shall submit to the Engineer sufficient information for each piece of equipment and its attachments to enable the Engineer to determine the proper equipment category. If a rate is not established in the Blue Book for a particular piece of equipment, the Engineer will establish a rate for that piece of equipment that is consistent with its cost and use in the industry.

- b. Rented Equipment. Whenever it is necessary for the Contractor to rent equipment to perform extra work, the rental and transportation costs of the equipment plus five percent for overhead will be paid. In no case shall the rental rates exceed those of established distributors or equipment rental agencies.

All prices shall be agreed to in writing before the equipment is used.”

HOT-MIX ASPHALT - FIELD VOIDS IN THE MINERAL AGGREGATE (BDE)

Effective: April 1, 2007

Add the following to the table in Article 1030.05(d)(2)a. of the Standard Specifications:

“Parameter	Frequency of Tests	Frequency of Tests	Test Method See Manual of Test Procedures for Materials
	High ESAL Mixture Low ESAL Mixture	All Other Mixtures	
VMA Note 5.	1 per half day of production for first 2 days and 1 per day thereafter (first sample of the day)	1 per day	Illinois-Modified AASHTO R 35

Note 5. The G_{sb} used in the voids in the mineral aggregate (VMA) calculation shall be the same average G_{sb} value listed in the mix design.”

Add the following to the Control Limits table in Article 1030.05(d)(4) of the Standard Specifications:

"CONTROL LIMITS			
Parameter	High ESAL Low ESAL	High ESAL Low ESAL	All Other
	Individual Test	Moving Avg. of 4	Individual Test
VMA	-0.7 % ^{2/}	-0.5 % ^{2/}	N/A

2/ Allowable limit below minimum design VMA requirement”

Add the following to the table in Article 1030.05(d)(5) of the Standard Specifications:

"CONTROL CHART REQUIREMENTS	High ESAL Low ESAL	All Other
	VMA”	

Revise the heading of Article 1030.05(d)(6)a.1. of the Standard Specifications to read:

“1. Voids, VMA, and Asphalt Binder Content.”

Revise the first sentence of the first paragraph of Article 1030.05(d)(6)a.1.(a.) of the Standard Specifications to read:

“If the retest for voids, VMA, or asphalt binder content exceeds control limits, HMA production shall cease and immediate corrective action shall be instituted by the Contractor.”

Revise the table in Article 1030.05(e) of the Standard Specifications to read:

“Test Parameter	Acceptable Limits of Precision
% Passing: ^{1/}	
½ in. (12.5 mm)	5.0 %
No. 4 (4.75 mm)	5.0 %
No. 8 (2.36 mm)	3.0 %
No. 30 (600 µm)	2.0 %
Total Dust Content No. 200 (75 µm) ^{1/}	2.2 %
Asphalt Binder Content	0.3 %
Maximum Specific Gravity of Mixture	0.026
Bulk Specific Gravity	0.030
VMA	1.4 %
Density (% Compaction)	1.0 % (Correlated)

1/ Based on washed ignition.”

PAYMENTS TO SUBCONTRACTORS (BDE)

Effective: June 1, 2000

Revised: January 1, 2006

Federal regulations found at 49 CFR §26.29 mandate the Department to establish a contract clause to require Contractors to pay subcontractors for satisfactory performance of their subcontracts and to set the time for such payments.

State law also addresses the timing of payments to be made to subcontractors and material suppliers. Section 7 of the Prompt Payment Act, 30 ILCS 540/7, requires that when a Contractor receives any payment from the Department, the Contractor shall make corresponding, proportional payments to each subcontractor and material supplier performing work or supplying material within 15 calendar days after receipt of the Department payment. Section 7 of the Act further provides that interest in the amount of two percent per month, in addition to the payment due, shall be paid to any subcontractor or material supplier by the Contractor if the payment required by the Act is withheld or delayed without reasonable cause. The Act also provides that the time for payment required and the calculation of any interest due applies to transactions between subcontractors and lower-tier subcontractors and material suppliers throughout the contracting chain.

This Special Provision establishes the required federal contract clause, and adopts the 15 calendar day requirement of the State Prompt Payment Act for purposes of compliance with the federal regulation regarding payments to subcontractors. This contract is subject to the following payment obligations.

When progress payments are made to the Contractor according to Article 109.07 of the Standard Specifications, the Contractor shall make a corresponding payment to each subcontractor and material supplier in proportion to the work satisfactorily completed by each subcontractor and for the material supplied to perform any work of the contract. The proportionate amount of partial payment due to each subcontractor and material supplier throughout the contracting chain shall be determined by the quantities measured or otherwise determined as eligible for payment by the Department and included in the progress payment to the Contractor. Subcontractors and material suppliers shall be paid by the Contractor within 15 calendar days after the receipt of payment from the Department. The Contractor shall not hold retainage from the subcontractors. These obligations shall also apply to any payments made by subcontractors and material suppliers to their subcontractors and material suppliers; and to all payments made to lower tier subcontractors and material suppliers throughout the contracting chain. Any payment or portion of a payment subject to this provision may only be withheld from the subcontractor or material supplier to whom it is due for reasonable cause.

This Special Provision does not create any rights in favor of any subcontractor or material supplier against the State or authorize any cause of action against the State on account of any payment, nonpayment, delayed payment, or interest claimed by application of the State Prompt Payment Act. The Department will not approve any delay or postponement of the 15 day requirement except for reasonable cause shown after notice and hearing pursuant to Section 7(b) of the State Prompt Payment Act. State law creates other and additional remedies available to any subcontractor or material supplier, regardless of tier, who has not been paid for work properly performed or material furnished. These remedies are a lien against public funds set forth in Section 23(c) of the Mechanics Lien Act, 770 ILCS 60/23(c), and a recovery on the Contractor's payment bond according to the Public Construction Bond Act, 30 ILCS 550.

RECLAIMED ASPHALT PAVEMENT (RAP) (BDE)

Effective: January 1, 2007

Revised: August 1, 2007

In Article 1030.02(g), delete the last sentence of the first paragraph in (Note 2).

Revise Section 1031 of the Standard Specifications to read:

"SECTION 1031. RECLAIMED ASPHALT PAVEMENT

1031.01 Description. Reclaimed asphalt pavement (RAP) is reclaimed asphalt pavement resulting from cold milling or crushing of an existing dense graded hot-mix asphalt (HMA) pavement. The Contractor shall supply written documentation that the RAP originated from routes or airfields under federal, state, or local agency jurisdiction.

1031.02 Stockpiles. The Contractor shall construct individual, sealed RAP stockpiles meeting one of the following definitions. No additional RAP shall be added to the pile after the pile has been sealed. Stockpiles shall be sufficiently separated to prevent intermingling at the base. Stockpiles shall be identified by signs indicating the type as listed below (i.e. "Homogeneous Surface").

Prior to milling, the Contractor shall request the District to provide verification of the quality of the RAP to clarify appropriate stockpile.

- (a) Homogeneous. Homogeneous RAP stockpiles shall consist of RAP from Class I, Superpave (High ESAL), HMA (High ESAL), or equivalent mixtures and represent: 1) the same aggregate quality, but shall be at least C quality; 2) the same type of crushed aggregate (either crushed natural aggregate, ACBF slag, or steel slag); 3) similar gradation; and 4) similar asphalt binder content. If approved by the Engineer, combined single pass surface/binder millings may be considered "homogenous" with a quality rating dictated by the lowest coarse aggregate quality present in the mixture.
- (b) Conglomerate 5/8. Conglomerate 5/8 RAP stockpiles shall consist of RAP from Class I, Superpave (High ESAL), HMA (High ESAL), or equivalent mixtures. The coarse aggregate in this RAP shall be crushed aggregate and may represent more than one aggregate type and/or quality but shall be at least C quality. This RAP may have an inconsistent gradation and/or asphalt binder content prior to processing. All conglomerate 5/8 RAP shall be processed prior to testing by crushing to where all RAP shall pass the 5/8 in. (16 mm) or smaller screen. Conglomerate 5/8 RAP stockpiles shall not contain steel slag or other expansive material as determined by the Department.
- (c) Conglomerate 3/8. Conglomerate 3/8 RAP stockpiles shall consist of RAP from Class I, Superpave (High ESAL), HMA (High ESAL), or equivalent mixtures. The coarse aggregate in this RAP shall be crushed aggregate and may represent more than one aggregate type and/or quality but shall be at least B quality. This RAP may have an inconsistent gradation and/or asphalt binder content prior to processing. All conglomerate 3/8 RAP shall be processed prior to testing by crushing to where all RAP shall pass the 3/8 in. (9.5 mm) or smaller screen. Conglomerate 3/8 RAP stockpiles shall not contain steel slag or other expansive material as determined by the Department.
- (d) Conglomerate "D" Quality (DQ). Conglomerate DQ RAP stockpiles shall consist of RAP from Class I, Superpave (High or Low ESAL), HMA (High or Low ESAL), or equivalent mixtures. The coarse aggregate in this RAP may be crushed or round but shall be at least D quality. This RAP may have an inconsistent gradation and/or asphalt binder content. Conglomerate DQ RAP stockpiles shall not contain steel slag or other expansive material as determined by the Department.
- (e) Non-Quality. RAP stockpiles that do not meet the requirements of the stockpile categories listed above shall be classified as "Non-Quality".

RAP containing contaminants, such as earth, brick, sand, concrete, sheet asphalt, bituminous surface treatment (i.e. chip seal), pavement fabric, joint sealants, etc., will be unacceptable unless the contaminants are removed to the satisfaction of the Engineer. Sheet asphalt shall be stockpiled separately.

1031.03 Testing. When used in HMA, the RAP shall be sampled and tested either during or after stockpiling.

For testing during stockpiling, washed extraction samples shall be run at the minimum frequency of one sample per 500 tons (450 metric tons) for the first 2000 tons (1800 metric tons) and one sample per 2000 tons (1800 metric tons) thereafter. A minimum of five tests shall be required for stockpiles less than 4000 tons (3600 metric tons).

For testing after stockpiling, the Contractor shall submit a plan for approval to the District proposing a satisfactory method of sampling and testing the RAP pile either in-situ or by restocking. The sampling plan shall meet the minimum frequency required above and detail the procedure used to obtain representative samples throughout the pile for testing.

Before extraction, each field sample shall be split to obtain two samples of test sample size. One of the two test samples from the final split shall be labeled and stored for Department use. The Contractor shall extract the other test sample according to Department procedure. The Engineer reserves the right to test any sample (split or Department-taken) to verify Contractor test results.

- (a) Testing Conglomerate 3/8. In addition to the requirements above, conglomerate 3/8 RAP shall be tested for maximum theoretical specific gravity (G_{mm}) at a frequency of one sample per 500 tons (450 metric tons) for the first 2000 tons (1800 metric tons) and one sample per 2000 tons (1800 metric tons) thereafter. A minimum of five tests shall be required for stockpiles less than 4000 tons (3600 metric tons).
- (b) Evaluation of Test Results. All of the extraction results shall be compiled and averaged for asphalt binder content and gradation and, when applicable G_{mm} . Individual extraction test results, when compared to the averages, will be accepted if within the tolerances listed below.

Parameter	Homogeneous / Conglomerate	Conglomerate "D" Quality
1 in. (25 mm)		± 5 %
1/2 in. (12.5 mm)	± 8 %	± 15 %
No. 4 (4.75 mm)	± 6 %	± 13 %
No. 8 (2.36 mm)	± 5 %	
No. 16 (1.18 mm)		± 15 %
No. 30 (600 μm)	± 5 %	
No. 200 (75 μm)	± 2.0 %	± 4.0 %
Asphalt Binder	± 0.4 % ^{1/}	± 0.5 %
G_{mm}	± 0.02 ^{2/}	

1/ The tolerance for conglomerate 3/8 shall be ± 0.3 %.

2/ Applies only to conglomerate 3/8. When variation of the G_{mm} exceeds the ± 0.02 tolerance, a new conglomerate 3/8 stockpile shall be created which will also require an additional mix design.

If more than 20 percent of the individual sieves are out of the gradation tolerances, or if more than 20 percent of the asphalt binder content test results fall outside the appropriate tolerances, the RAP shall not be used in HMA unless the RAP representing the failing tests is removed from the stockpile. All test data and acceptance ranges shall be sent to the District for evaluation.

With the approval of the Engineer, the ignition oven may be substituted for extractions according to the Illinois Test Procedure, "Calibration of the Ignition Oven for the Purpose of Characterizing Reclaimed Asphalt Pavement (RAP)".

1031.04 Quality Designation of Aggregate in RAP. The quality of the RAP shall be set by the lowest quality of coarse aggregate in the RAP stockpile and are designated as follows.

- (a) RAP from Class I, Superpave (High ESAL), or HMA (High ESAL) surface mixtures are designated as containing Class B quality coarse aggregate.
- (b) RAP from Superpave (Low ESAL)/HMA (Low ESAL) IL-19.0L binder and IL-9.5L surface mixtures are designated as Class D quality coarse aggregate.
- (c) RAP from Class I, Superpave (High ESAL), or HMA (High ESAL) binder mixtures, bituminous base course mixtures, and bituminous base course widening mixtures are designated as containing Class C quality coarse aggregate.
- (d) RAP from bituminous stabilized subbase and BAM shoulders are designated as containing Class D quality coarse aggregate.

1031.05 Use of RAP in HMA. The use of RAP in HMA shall be as follows.

- (a) Coarse Aggregate Size. The coarse aggregate in all RAP shall be equal to or less than the nominal maximum size requirement for the HMA mixture to be produced.
- (b) Steel Slag Stockpiles. RAP stockpiles containing steel slag or other expansive material, as determined by the Department, shall be homogeneous and will be approved for use in HMA (High ESAL and Low ESAL) surface mixtures only.
- (c) Use in HMA Surface Mixtures (High and Low ESAL). RAP stockpiles for use in HMA surface mixtures (High and Low ESAL) shall be either homogeneous or conglomerate 3/8, in which the coarse aggregate is Class B quality or better.
- (d) Use in HMA Binder Mixtures (High and Low ESAL), HMA Base Course, and HMA Base Course Widening. RAP stockpiles for use in HMA binder mixtures (High and Low ESAL), HMA base course, and HMA base course widening shall be homogeneous, conglomerate 5/8, or conglomerate 3/8, in which the coarse aggregate is Class C quality or better.

- (e) Use in Shoulders and Subbase. RAP stockpiles for use in HMA shoulders and stabilized subbase (HMA) shall be homogeneous, conglomerate 5/8, conglomerate 3/8, or conglomerate DQ.
- (f) The use of RAP shall be a contractor's option when constructing HMA in all contracts. When the contractor chooses the RAP option, the percentage of RAP shall not exceed the amounts indicated in the table for a given N Design.

Max RAP Percentage

HMA MIXTURES ^{1/, 3/}	MAXIMUM % RAP		
	Ndesign	Binder/Leveling Binder	Surface
30	30	30	10
50	25	15	10
70	15 / 25 ^{2/}	10 / 15 ^{2/}	10
90	10	10	10
105	10	10	10

- 1/ For HMA Shoulder and Stabilized Sub-Base (HMA) N-30, the amount of RAP shall not exceed 50% of the mixture.
- 2/ Value of Max % RAP if 3/8 RAP is utilized.
- 3/ When RAP exceeds 20%, the high & low virgin asphalt binder grades shall each be reduced by one grade (i.e. 25% RAP would require a virgin asphalt binder grade of PG64-22 to be reduced to a PG58-28).

1031.06 HMA Mix Designs. At the Contractor's option, HMA mixtures may be constructed utilizing RAP material meeting the above detailed requirements.

RAP designs shall be submitted for volumetric verification. If additional RAP stockpiles are tested and found that no more than 20 percent of the results, as defined under "Testing" herein, are outside of the control tolerances set for the original RAP stockpile and HMA mix design, and meets all of the requirements herein, the additional RAP stockpiles may be used in the original mix design at the percent previously verified.

1031.07 HMA Production. The coarse aggregate in all RAP used shall be equal to or less than the nominal maximum size requirement for the HMA mixture being produced.

To remove or reduce agglomerated material, a scalping screen, crushing unit, or comparable sizing device approved by the Engineer shall be used in the RAP feed system to remove or reduce oversized material. If material passing the sizing device adversely affects the mix production or quality of the mix, the sizing device shall be set at a size specified by the Engineer.

If the RAP control tolerances or QC/QA test results require corrective action, the Contractor shall cease production of the mixture containing RAP and either switch to the virgin aggregate design or submit a new RAP design. When producing mixtures containing conglomerate 3/8 RAP, a positive dust control system shall be utilized.

HMA plants utilizing RAP shall be capable of automatically recording and printing the following information.

(a) Dryer Drum Plants.

- (1) Date, month, year, and time to the nearest minute for each print.
- (2) HMA mix number assigned by the Department.
- (3) Accumulated weight of dry aggregate (combined or individual) in tons (metric tons) to the nearest 0.1 ton (0.1 metric ton).
- (4) Accumulated dry weight of RAP in tons (metric tons) to the nearest 0.1 ton (0.1 metric ton).
- (5) Accumulated mineral filler in revolutions, tons (metric tons), etc. to the nearest 0.1 unit.
- (6) Accumulated asphalt binder in gallons (liters), tons (metric tons), etc. to the nearest 0.1 unit.
- (7) Residual asphalt binder in the RAP material as a percent of the total mix to the nearest 0.1 percent.
- (8) Aggregate and RAP moisture compensators in percent as set on the control panel. (Required when accumulated or individual aggregate and RAP are printed in wet condition.)

(b) Batch Plants.

- (1) Date, month, year, and time to the nearest minute for each print.
- (2) HMA mix number assigned by the Department.
- (3) Individual virgin aggregate hot bin batch weights to the nearest pound (kilogram).
- (4) Mineral filler weight to the nearest pound (kilogram).
- (5) RAP weight to the nearest pound (kilogram).
- (6) Virgin asphalt binder weight to the nearest pound (kilogram).

- (7) Residual asphalt binder in the RAP material as a percent of the total mix to the nearest 0.1 percent.

The printouts shall be maintained in a file at the plant for a minimum of one year or as directed by the Engineer and shall be made available upon request. The printing system will be inspected by the Engineer prior to production and verified at the beginning of each construction season thereafter.

1031.08 RAP in Aggregate Surface Course and Aggregate Shoulders. The use of RAP in aggregate surface course and aggregate shoulders shall be as follows.

- (a) Stockpiles and Testing. RAP stockpiles may be any of those listed in Article 1031.02, except "Other". The testing requirements of Article 1031.03 shall not apply.
- (b) Gradation. One hundred percent of the RAP material shall pass the 1 1/2 in. (37.5 mm) sieve. The RAP material shall be reasonably well graded from coarse to fine. RAP material that is gap-graded or single sized will not be accepted."

REFLECTIVE SHEETING ON CHANNELIZING DEVICES (BDE)

Effective: April 1, 2007

Revise the seventh paragraph of Article 1106.02 of the Standard Specifications to read:

"At the time of manufacturing, the retroreflective prismatic sheeting used on channelizing devices shall meet or exceed the initial minimum coefficient of retroreflection as specified in the following table. Measurements shall be conducted according to ASTM E 810, without averaging. Sheeting used on cones, drums and flexible delineators shall be reboundable as tested according to ASTM D 4956. Prestriped sheeting for rigid substrates on barricades shall be white and orange.

Initial Minimum Coefficient of Retroreflection candelas/foot candle/sq ft (candelas/lux/sq m) of material				
Observation Angle (deg.)	Entrance Angle (deg.)	White	Orange	Fluorescent Orange
0.2	-4	365	160	150
0.2	+30	175	80	70
0.5	-4	245	100	95
0.5	+30	100	50	40"

Revise the first sentence of the first paragraph of Article 1106.02(c) of the Standard Specifications to read:

"Barricades and vertical panels shall have alternating white and orange stripes sloping downward at 45 degrees toward the side on which traffic will pass."

Revise the third sentence of the first paragraph of Article 1106.02(d) of the Standard Specifications to read:

“The bottom panels shall be 8 x 24 in. (200 x 600 mm) with alternating white and orange stripes sloping downward at 45 degrees toward the side on which traffic will pass.”

SUBCONTRACTOR MOBILIZATION PAYMENTS (BDE)

Effective: April 2, 2005

To account for the preparatory work and operations necessary for the movement of subcontractor personnel, equipment, supplies, and incidentals to the project site and for all other work or operations that must be performed or costs incurred when beginning work approved for subcontracting in accordance with Article 108.01 of the Standard Specifications, the Contractor shall make a mobilization payment to each subcontractor.

This mobilization payment shall be made at least 14 days prior to the subcontractor starting work. The amount paid shall be equal to 3 percent of the amount of the subcontract reported on form BC 260A submitted for the approval of the subcontractor's work.

This provision shall be incorporated directly or by reference into each subcontract approved by the Department.

WORKING DAYS (BDE)

Effective: January 1, 2002

The Contractor shall complete the work within 25 working days.

BITUMINOUS MATERIALS COST ADJUSTMENTS (BDE) (RETURN FORM WITH BID)

Effective: November 2, 2006

Revised: January 2, 2007

Description. For projects with at least 1200 tons (1100 metric tons) of work involving applicable bituminous materials, cost adjustments will be made to provide additional compensation to the Contractor, or credit to the Department, for fluctuations in the cost of bituminous materials when optioned by the Contractor. The adjustments shall apply to permanent and temporary hot-mix asphalt (HMA) mixtures, bituminous surface treatments (cover and seal coats), and pavement preservation type surface treatments. The adjustments shall not apply to bituminous prime coats, tack coats, crack filling/sealing, or joint filling/sealing.

The bidder shall indicate on the attached form whether or not this special provision will be part of the contract and submit the completed form with his/her bid. Failure to submit the form, or failure to fill out the form completely, shall make this contract exempt of bituminous materials cost adjustments.

Method of Adjustment. Bituminous materials cost adjustments will be computed as follows.

$$CA = (BPI_P - BPI_L) \times (\%AC_V / 100) \times Q$$

- Where: CA = Cost Adjustment, \$.
BPI_P = Bituminous Price Index, as published by the Department for the month the work is performed, \$/ton (\$/metric ton).
BPI_L = Bituminous Price Index, as published by the Department for the month prior to the letting, \$/ton (\$/metric ton).
%AC_V = Percent of virgin Asphalt Cement in the Quantity being adjusted. For HMA mixtures, the % AC_V will be determined from the adjusted job mix formula. For bituminous materials applied, a performance graded or cutback asphalt will be considered to be 100% AC_V and undiluted emulsified asphalt will be considered to be 65% AC_V.
Q = Authorized construction Quantity, tons (metric tons) (see below).

For HMA mixtures measured in square yards: $Q, \text{ tons} = A \times D \times (G_{mb} \times 46.8) / 2000$. For HMA mixtures measured in square meters: $Q, \text{ metric tons} = A \times D \times (G_{mb} \times 24.99) / 1000$. When computing adjustments for full-depth HMA pavement, separate calculations will be made for the binder and surface courses to account for their different G_{mb} and % AC_V.

For bituminous materials measured in gallons: $Q, \text{ tons} = V \times 8.33 \text{ lb/gal} \times SG / 2000$
For bituminous materials measured in liters: $Q, \text{ metric tons} = V \times 1.0 \text{ kg/L} \times SG / 1000$

- Where: A = Area of the HMA mixture, sq yd (sq m).
D = Depth of the HMA mixture, in. (mm).
G_{mb} = Average bulk specific gravity of the mixture, from the approved mix design.
V = Volume of the bituminous material, gal (L).
SG = Specific Gravity of bituminous material as shown on the bill of lading.

Basis of Payment. Bituminous materials cost adjustments may be positive or negative but will only be made when there is a difference between the BPI_L and BPI_P in excess of five percent, as calculated by:

$$\text{Percent Difference} = \{(BPI_L - BPI_P) \div BPI_L\} \times 100$$

Bituminous materials cost adjustments will be calculated for each calendar month in which applicable bituminous material is placed; and will be paid or deducted when all other contract requirements for the items of work are satisfied. The adjustments shall not apply during contract time subject to liquidated damages for completion of the entire contract.

Return With Bid

**ILLINOIS DEPARTMENT
OF TRANSPORTATION**

**OPTION FOR
BITUMINOUS MATERIALS COST ADJUSTMENTS**

The bidder shall submit this completed form with his/her bid. Failure to submit the form, or failure to fill out the form completely, shall make this contract exempt of bituminous materials cost adjustments. After award, this form, when submitted, shall become part of the contract.

Contract No.: _____

Company Name: _____

Contractor's Option:

Is your company opting to include this special provision as part of the contract?

Yes No

Signature: _____ **Date:** _____

Illinois Department of Transportation

PROJECT LABOR AGREEMENT

This Project Labor Agreement ("PLA") is entered into this _____ day of _____, 2007, by and between the Illinois Department of Transportation ("IDOT" or "Department") in its proprietary capacity, and each relevant Illinois AFL-CIO Building Trades Council made signatory hereto by the Illinois AFL-CIO Statewide Project Labor Agreement Committee on behalf of itself and each of its affiliated members (individually and collectively, the "Union"). This PLA shall apply to Construction Work (as defined herein) to be performed by IDOT's Prime Contractor and each of its relevant subcontractors of whatever tier ("Subcontractor" or "Subcontractors") on Contract 64D44 (hereinafter, the "Project").

ARTICLE 1 - INTENT AND PURPOSES

- 1.1. This PLA is entered into in furtherance of Illinois Executive Order No. 2003-13. It is mutually understood and agreed that the terms and conditions of this PLA are intended to promote the public interest in obtaining timely and economical completion of the Project by encouraging productive and efficient construction operations; by establishing a spirit of harmony and cooperation among the parties; and by providing for peaceful and prompt settlement of any and all labor grievances or jurisdictional disputes of any kind without strikes, lockouts, slowdowns, delays or other disruptions to the prosecution of the work.
- 1.2. As a condition of the award of the contract for performance of work on the Project, IDOT's Prime Contractor and each of its Subcontractors shall be required to sign a "Contractor Letter of Assent", in the form attached hereto as Exhibit A, prior to commencing Construction Work on the Project. Each Union affiliate and separate local representing workers engaged in Construction Work on the Project in accordance with this PLA are bound to this agreement by the Illinois AFL-CIO Statewide Project Labor Agreement Committee which is the central committee established with full authority to negotiate and sign PLAs with the State on behalf of all respective crafts. Upon their signing the Letter of Assent, the Prime Contractor, each Subcontractor, and the individual Unions shall thereafter be deemed a party to this PLA. No party signatory to this PLA shall, contract or subcontract, nor permit any other person, firm, company or entity to contract or subcontract for the performance of Construction Work for the Project to any person, firm, company or entity that does not agree in writing to become bound by the terms of this PLA prior to commencing such work.
- 1.3. It is understood that the Prime Contractor(s) and each Subcontractor will be considered and accepted by the Unions as separate employers for the purposes of collective bargaining, and it is further agreed that the employees working under this PLA shall constitute a bargaining unit separate and distinct from all others. The Parties hereto also agree that this PLA shall be applicable solely with respect to this Project, and shall have no bearing on the interpretation of any other collective bargaining agreement or as to the recognition of any bargaining unit other than for the specific purposes of this Project.

- 1.4. In the event of a variance or conflict, whether explicit or implicit, between the terms and conditions of this PLA and the provisions of any other applicable national, area, or local collective bargaining agreement, the terms and conditions of this PLA shall supercede and control. For any work performed under the NTL Articles of Agreement, the National Stack/Chimney Agreement, the National Cooling Tower Agreement, the National Agreement of the International Union of Elevator Constructors, and for any instrument calibration work and loop checking performed under the UA/IBEW Joint National Agreement for Instrument and Control Systems Technicians, the preceding sentence shall apply only with respect to Articles I, II, V, VI, and VII.
- 1.5. Subject to the provisions of paragraph 1.4 of this Article, it is the parties' intent to respect the provisions of any other collective bargaining agreements that may now or hereafter pertain, whether between the Prime Contractor and one or more of the Unions or between a Subcontractor and one or more of the Unions. Accordingly, except and to the extent of any contrary provision set forth in this PLA, the Prime Contractor and each of its Subcontractors agrees to be bound and abide by the terms of the following in order of precedence: (a) the applicable collective bargaining agreement between the Prime Contractor and one or more of the Unions made signatory hereto; (b) the applicable collective bargaining agreement between a Subcontractor and one or more of the Unions made signatory hereto; or (c) the current applicable area collective bargaining agreement for the relevant Union that is the agreement certified by the Illinois Department of Labor for purposes of establishing the Prevailing Wage applicable to the Project. The Union will provide copies of the applicable collective bargaining agreements pursuant to part (c) of the preceding sentence to the Prime Contractor. Assignments by the Contractors amongst the trades shall be consistent with area practices; in the event of unresolved disagreements as to the propriety of such assignments, the provisions of Article VI shall apply.
- 1.6. Subject to the limitations of paragraphs 1.4 and 1.5 of this Article, the terms of each applicable collective bargaining agreement as determined in accordance with paragraph 1.5 are incorporated herein by reference, and the terms of this PLA shall be deemed incorporated into such other applicable collective bargaining agreements only for purposes of their application to the Project.
- 1.7. To the extent necessary to comply with the requirements of any fringe benefit fund to which the Prime Contractor or Subcontractor is required to contribute under the terms of an applicable collective bargaining agreement pursuant to the preceding paragraph, the Prime Contractor or Subcontractor shall execute all "Participation Agreements" as may be reasonably required by the Union to accomplish such purpose; provided, however, that such Participation Agreements shall, when applicable to the Prime Contractor or Subcontractor solely as a result of this PLA, be amended as reasonably necessary to reflect such fact. Upon written notice from any applicable fringe benefit fund, IDOT will withhold from the Prime Contractor payment of any delinquencies arising from this Project.

- 1.8. In the event that the applicable collective bargaining agreement between a Prime Contractor and the Union or between the Subcontractor and the Union expires prior to the completion of this Project, the expired applicable contract's terms will be maintained until a new applicable collective bargaining agreement is ratified. The wages and fringe benefits included in any new applicable collective bargaining agreement will apply on and after the effective date of the newly negotiated collective bargaining agreement, except to the extent wage and fringe benefit retroactivity is specifically agreed upon by the relevant bargaining parties.

ARTICLE II – APPLICABILITY, RECOGNITION, AND COMMITMENTS

- 2.1 The term Construction Work as used herein shall include all “construction, prosecution, completion, or repair” work performed by a “laborer or mechanic” at the “site of the work” for the purpose of “building” the specific structures and improvements that constitute the Project. Terms appearing within quotation marks in the preceding sentence shall have the meaning ascribed to them pursuant to 29 CFR Part 5.
- 2.2 By executing the Letters of Assent, Prime Contractor and each of its Subcontractors recognizes the Unions signatory to this PLA as the sole and exclusive bargaining representatives for their craft employees employed on the jobsite for this Project. Unions who are signatory to this PLA will have recognition on the Project for their craft.
- 2.3 The Prime Contractor and each of its Subcontractors retains and shall be permitted to exercise full and exclusive authority and responsibility for the management of its operations, except as expressly limited by the terms of this PLA or by the terms and conditions of the applicable collective bargaining agreement.
- 2.4 Except to the extent contrary to an express provision of the relevant collective bargaining agreement, equipment or materials used in the Project may be pre-assembled or pre-fabricated, and there shall be no refusal by the Union to handle, transport, install, or connect such equipment or materials. Equipment or materials delivered to the job-site will be unloaded and handled promptly without regard to potential jurisdictional disputes; any such disputes shall be handled in accordance with the provisions of this PLA.
- 2.5 Unions commit to furnishing qualified and skilled craft persons as required by the Prime Contractor and its Subcontractors in fulfillment of their obligations to complete the Project. In order to promote the long-term development of a skilled and knowledgeable work force, the parties are encouraged to utilize apprentices to the maximum extent permitted by the applicable collective bargaining agreement.
- 2.6 The parties are mutually committed to promoting a safe working environment for all personnel at the job site. It shall be the responsibility of each employer to which this PLA applies to provide and maintain safe working conditions for its employees, and to comply with all applicable federal, state, and local health and safety laws and regulations.

- 2.7 The use or furnishing of alcohol or drugs and the conduct of any other illegal activity at the job-site is strictly prohibited. The parties shall take every practical measure consistent with the terms of applicable collective bargaining agreements to ensure that the job-site is free of alcohol and drugs.
- 2.8 All parties to this PLA agree that they shall not discriminate against any employee based on race, creed, color, national origin, union activity, age, or gender as required by all applicable federal, state, and local laws.
- 2.9 The Parties hereto agree that engineering consultants and materials testing employees, to the extent subject to the terms of this PLA, shall be fully expected to objectively and responsibly perform their duties and obligations owed to the Department without regard to the potential union affiliation of such employees or of other employees on the Project.

ARTICLE III - ADMINISTRATION OF AGREEMENT

- 3.1 In order to assure that all parties have a clear understanding of the PLA and to promote harmony, a post-award pre-job conference will be held among the Prime Contractor, all Subcontractors and Union representatives prior to the start of any Construction Work on the Project. No later than the conclusion of such pre-job conference, the parties shall, among other matters, provide to one another contact information for their respective representatives (including name, address, phone number, facsimile number, e-mail). Nothing herein shall be construed to limit the right of the Department to discuss or explain the purpose and intent of this PLA with prospective bidders or other interested parties prior to or following its award of the job.
- 3.2 Representatives of the Prime Contractor and the Unions shall meet as often as reasonably necessary following award until completion of the Project to assure the effective implementation of this PLA.
- 3.3 Not less than once per month, Prime Contractor and all Subcontractors shall make available in writing to the Unions a Project status report that shall include, though not necessarily be limited to, planned activities for the next 30 day period and estimated numbers of employees by craft required for the next 30 day period. The purpose of this Project status report is to promote effective workforce planning and to facilitate resolution of any potential jurisdictional or other problems.
- 3.4 Not later than the earlier of (a) five business days following the pre-job conference, or (b) commencement of Construction Work, the Unions and Prime Contractor (on behalf of itself and all its subcontractors of whatever tier) shall confer and jointly designate a slate of three (3) permanent arbitrators (each a "Permanent Arbitrator") for the purpose of hearing disputes pursuant to Articles V and VII of this PLA. The slate of Permanent Arbitrators shall be selected from among the following individuals: Jack P. Cerone, Thomas F. Gibbons, Thomas G. Pagan, Robert Perkovich, Byron Yaffee, and Glenn A. Zipp. In the event that the Unions and Prime Contractor are not able to agree on a full

slate of three Permanent Arbitrators, the Department, after consultation with the Unions and Prime Contractor, shall designate such additional Permanent Arbitrators as may be necessary to establish the full slate. A single Permanent Arbitrator shall be selected from the slate of three on a rotating basis to adjudicate each arbitrable matter as it arises. In the event a Permanent Arbitrator is not available to adjudicate a particular matter in the order of rotation, the arbitration assignment shall pass to the next available Permanent Arbitrator.

ARTICLE IV - HOURS OF WORK AND GENERAL CONDITIONS

- 4.1 The standard work day for Construction Work on the Project shall be an established consecutive eight (8) hour period between the hours of 7:00 a.m. and 5:00 p.m. with one-half hour designated as unpaid period for lunch. The standard work week shall be five (5) consecutive days of work commencing on Monday. Starting time shall be established at the pre-job conference, and shall be applicable to all craft employees on the Project unless otherwise expressly agreed in writing. In the event Project site or other job conditions dictate a change in the established starting time and/or a staggered lunch period for portions of the Project or for specific crafts, the Prime Contractor, relevant Subcontractors and business managers of the specific crafts involved shall confer and mutually agree to such changes as appropriate. If proposed work schedule changes cannot be mutually agreed upon between the parties, the hours fixed at the time of the pre-job meeting shall prevail.
- 4.2 Shift work may be established and directed by the Prime Contractor or relevant Subcontractor as reasonably necessary or appropriate to fulfill the terms of its contract with the Department. If used, shift hours, rates and conditions shall be as provided in the applicable collective bargaining agreement.
- 4.3 The parties agree that chronic and/or unexcused absenteeism is undesirable and must be controlled in accordance with procedures established by the applicable collective bargaining agreement. Any employee disciplined for absenteeism in accordance with such procedures shall be suspended from all work on the Project for not less than the maximum period permitted under the applicable collective bargaining agreement.
- 4.4 Except as may be otherwise expressly provided by the applicable collective bargaining agreement, employment begins and ends at the Project site; employees shall be at their place of work at the starting time; and employees shall remain at their place of work until quitting time.
- 4.5 Except as may be otherwise expressly provided by the applicable collective bargaining agreement, there shall be no limit on production by workmen, no restrictions on the full use of tools or equipment, and no restrictions on efficient use of manpower or techniques of construction other than as may be required by safety regulations.

- 4.6 The parties recognize that specialized or unusual equipment may be installed on the Project. In such cases, the Union recognizes the right of the Prime Contractor or Subcontractor to involve the equipment supplier or vendor's personnel in supervising the setting up of the equipment, making modifications and final alignment, and performing similar activities that may be reasonably necessary prior to and during the start-up procedure in order to protect factory warranties. The Prime Contractor or Subcontractor shall notify the Union representatives in advance of any work at the job-site by such vendor personnel in order to promote a harmonious relationship between the equipment vendor's personnel and other Project employees.
- 4.7 For the purpose of promoting full and effective implementation of this PLA, authorized Union representatives shall have access to the Project job-site during scheduled work hours. Such access shall be conditioned upon adherence to all reasonable visitor and security rules of general applicability that may be established for the Project site at the pre-job conference or from time to time thereafter.

ARTICLE V - GRIEVANCE AND ARBITRATION PROCEDURES

- 5.1 Except as provided in Articles VI or VII, it is specifically agreed among the parties that any grievance or dispute arising out of the interpretation or application of this PLA shall be settled by means of the expedited arbitration process set forth in Paragraph 5.2 below. No such grievance or dispute shall be recognized unless called to the attention of the Prime Contractor and relevant Subcontractor by the Union or to the Union by the Prime Contractor or relevant Subcontractor within five (5) working days after the alleged violation was committed or discovered by the grieving party.
- 5.2 Grievances shall be settled according to the following procedure:
- 5.2.A. Step 1. The dispute shall be referred to the Steward of the craft union involved and a representative of the Prime Contractor and relevant Subcontractor at the job-site.
- 5.2.B. Step 2. In the event that the Steward and the contractors' representatives at the job-site cannot reach agreement within two (2) working days after a meeting is arranged and held, the matter shall be referred to the Union Business Manager and to executive representatives of the Prime Contractor and relevant Subcontractor.
- 5.2.C. Step 3. In the event the dispute is not resolved within five (5) working days after completion of Step 2, the relevant parties shall request a Permanent Arbitrator as determined in accordance with paragraph 3.4 of this PLA, who shall, within ten (10) working days, hear the grievance and make a written decision. Such decisions shall be final and binding on all parties. The parties shall each pay the expense of their own representative. The expense of the Permanent Arbitrator shall be divided equally between (1) the Prime Contractor and/or relevant Subcontractor, and (2) the involved Union.

- 5.3 Any failure of a party to comply fully with such final and binding decision of the Permanent Arbitrator may result in removal of the non-complying party from the site, in a holdback from the Prime Contractor or Subcontractor of any amounts awarded, or in such other relief as the Department may reasonably determine is necessary to promote final resolution of the dispute.
- 5.4 In the event any dispute or grievance should arise, the parties expressly agree that it shall be resolved without occurrence of any strike, work stoppage, slow-down or other prohibited activities as provided in Article VII of this PLA. Individuals or parties violating this section shall be subject to immediate discharge or other discipline.

ARTICLE VI - JURISDICTIONAL DISPUTES

- 6.1 As used in this Agreement, the term "jurisdictional dispute" shall be defined as any dispute, difference or disagreement involving the assignment of particular work to one class or craft of employees rather than to a different class or craft of employees, regardless of that Contractor's contractual relationship to any other employer, contractor, or organization on the site.
- 6.2 It is agreed by and between the parties to this Agreement that any and all jurisdictional disputes shall be resolved in the following manner; each of the steps hereinafter listed shall be initiated by the parties in sequence as set forth:
- (a) Negotiation by and between the Local Business Representative of the disputing Union and Employer shall take place within two (2) business days. Business days are defined as Monday through Friday excluding contract holidays. Such negotiations shall be pursued until it is apparent that the dispute cannot be resolved at the local level.
 - (b) The International Representatives of the disputing Union shall meet or confer and attempt to resolve said dispute. This meeting shall take place within two (2) business days. Business days are defined as Monday through Friday excluding contract holidays.
 - (c) The parties to the Jurisdictional Dispute shall submit the dispute directly to an Arbitrator after complying with paragraph (2b) above. The parties shall meet with the Arbitrator within three (3) business days. Business days are defined as Monday through Friday excluding contract holidays. An Arbitrator will be selected based on availability from the slate of permanent Arbitrators. The Arbitrator's bench decision will be given the day of the hearing and will be final and legally binding on this project only. The Arbitrator's bench decision will be implemented without delay. The cost of Arbitration will be shared equally by the disputing parties. Any party to the dispute can require that a "long form" written decision be provided from the Arbitrator, however the cost of the "long form" written decision will be the responsibility of the party making the request.

Notes:

- A jurisdictional dispute may be submitted based upon a pre-job assignment.
 - If any party to the jurisdictional disputes does not fully comply with the steps and time limits with each step, then the party in non-compliance will lose by “automatic default”.
 - Time limits at any step can be extended if all parties to the jurisdictional dispute mutually agree in writing.
 - All parties to a jurisdictional dispute can mutually agree to waive the time limits in steps (a) and (b) and proceed directly to an expedited arbitration hearing.
- (d) In rendering his decision, the Arbitrator shall determine:
- (1) First whether a previous agreement of record or applicable agreement, including a disclaimer agreement, between the National or International Unions to the dispute governs;
 - (2) Only if the Arbitrator finds that the dispute is not covered by an appropriate or applicable agreement of record or agreement between the crafts to the dispute, he shall then consider whether there is a previous decision of record governing the case;
 - (3) If the Arbitrator finds that a previous decision of record governs the case, the Arbitrator shall apply the decision of record in rendering his decision except under the following circumstances. After notice to the other parties to the dispute prior to the hearing that it intends to challenge the decision of record, if a trade challenging the decision of record is able to demonstrate that the recognized and established prevailing practice in the locality of the work has been contrary to the applicable decision of record, and that historically in that locality the work in dispute has not been performed by the other craft or crafts, the Arbitrator may rely on such prevailing practice rather than the decision of record. If the craft relying on the decision of record demonstrates that it has performed the work in dispute in the locality of the job, then the Arbitrator shall apply the decision of record in rendering his decision. If the Arbitrator finds that a craft has improperly obtained the prevailing practice in the locality through raiding, the undercutting of wagers or by the use of vertical agreements, the Arbitrator shall rely on the decision of record rather than the prevailing practice in the locality.
 - (4) If no decision of record is applicable, the Arbitrator shall then consider the established trade practice in the industry and prevailing practice in the locality; and

- (5) Only if none of the above criteria is found to exist, the Arbitrator shall then consider that because efficiency, cost or continuity and good management are essential to the well being of the industry, the interest of the consumer or the past practice of the employer shall not be ignored.

The Arbitrator shall set forth the basis for his decision and shall explain his findings regarding the applicability of the above criteria. If lower-ranked criteria are relied upon, the Arbitrator shall explain why the higher-ranked criteria were not deemed applicable. The Arbitrator's decision shall only apply to the job in dispute.

- (6) Agreements of record are applicable only to the party's signatory to such agreements. Decision of record are applicable to all trades.
- (7) The Arbitrator is not authorized to award back pay or any other damages for a mis-assignment of work. Nor may any party bring an independent action for back pay or any other damages, based upon a decision of an Arbitrator.

6.3 The signatory parties to this Agreement agree that jurisdictional disputes cannot and shall not interfere with the efficient and continuous operations required for the successful application of this Agreement. In the event a dispute arises, the Contractor's assignment shall be followed until the dispute is resolved.

6.4 Equipment or material delivered to the job site will be unloaded promptly without regard to jurisdictional disputes which will be handled as per the provisions of this Agreement. The Contractor will supply the Union with delivery schedules, allowing as much time as possible to insure the appropriate crafts will be available to unload the materials or equipment.

6.5 All signatory affiliates agree that upon request, a representative shall be assigned without delay to attempt a settlement in the event of a question on assignments.

ARTICLE VII - WORK STOPPAGES AND LOCKOUTS

7.1 During the term of this PLA, no Union or any of its members, officers, stewards, employees, agents or representatives shall instigate, support, sanction, maintain, or participate in any strike, picketing, walkout, work stoppage, slow down or other activity that interferes with the routine and timely prosecution of work at the Project site or at any other contractor's or supplier's facility that is necessary to performance of work at the Project site. Hand billing at the Project site during the designated lunch period and before commencement or following conclusion of the established standard workday shall not, in itself, be deemed an activity that interferes with the routine and timely prosecution of work on the Project.

- 7.2 Should any activity prohibited by paragraph 7.1 of this Article occur, the Union shall undertake all steps reasonably necessary to promptly end such prohibited activities. No Union complying with its obligations under this Article shall be liable for acts of employees for which it has no responsibility or for the unauthorized acts of employees it represents. Any employee who participates in or encourages any activity prohibited by paragraph 7.1 shall be immediately suspended from all work on the Project for a period equal to the greater of (a) 60 days; or (b) the maximum disciplinary period allowed under the applicable collective bargaining agreement for engaging in comparable unauthorized or prohibited activity.
- 7.3 During the term of this PLA, the Prime Contractor and its Subcontractors shall not engage in any lockout at the Project site of employees covered by this Agreement.
- 7.4 Upon notification of violations of this Article, the principal officer or officers of the local area Building and Construction Trades Council, and the Illinois AFL-CIO Statewide Project Labor Agreement Committee as appropriate, will immediately instruct, order and use their best efforts to cause the affiliated union or unions to cease any violations of this Article. A Trades Council and the Committee otherwise in compliance with the obligations under this paragraph shall not be liable for unauthorized acts of its affiliates.
- 7.5 In the event that activities in violation of this Article are not immediately halted through the efforts of the parties, any aggrieved party may invoke the special arbitration provisions set forth in paragraph 7.6 of this Article.
- 7.6 Upon written notice to the other involved parties by the most expeditious means available, any aggrieved party may institute the following special arbitration procedure when a breach of this Article is alleged:
- 7.6.A The party invoking this procedure shall notify the individual designated as the Permanent Arbitrator pursuant to Article III of the nature of the alleged violation; such notice shall be by the most expeditious means possible. The initiating party may also furnish such additional factual information as may be reasonably necessary for the Permanent Arbitrator to understand the relevant circumstances. Copies of any written materials provided to the arbitrator shall also be contemporaneously provided by the most expeditious means possible to the party alleged to be in violation and to all other involved parties.
 - 7.6.B Upon receipt of said notice the Permanent Arbitrator shall set and hold a hearing within twenty-four (24) hours if it is contended the violation is ongoing, but not before twenty-four (24) hours after the written notice to all parties involved as required above.
 - 7.6.C The Permanent Arbitrator shall notify the parties by facsimile or any other effective written means, of the place and time chosen by the Permanent Arbitrator for this hearing. Said hearing shall be completed in one session. A failure of any party or parties to attend said hearing shall not delay the hearing of evidence or issuance of an Award by the Permanent Arbitrator.

7.6.D The sole issue at the hearing shall be whether a violation of this Article has, in fact, occurred. An Award shall be issued in writing within three (3) hours after the close of the hearing, and may be issued without a written opinion. If any party desires a written opinion, one shall be issued within fifteen (15) days, but its issuance shall not delay compliance with, or enforcement of, the Award. The Permanent Arbitrator may order cessation of the violation of this Article, and such Award shall be served on all parties by hand or registered mail upon issuance.

7.6.E Such Award may be enforced by any court of competent jurisdiction upon the filing of the Award and such other relevant documents as may be required. Facsimile or other hardcopy written notice of the filing of such enforcement proceedings shall be given to the other relevant parties. In a proceeding to obtain a temporary order enforcing the Permanent Arbitrator's Award as issued under this Article, all parties waive the right to a hearing and agree that such proceedings may be ex parte. Such agreement does not waive any party's right to participate in a hearing for a final order of enforcement. The Court's order or orders enforcing the Permanent Arbitrator's Award shall be served on all parties by hand or by delivery to their last known address or by registered mail.

7.7 Individuals found to have violated the provisions of this Article are subject to immediate termination. In addition, IDOT reserves the right to terminate this PLA as to any party found to have violated the provisions of this Article.

7.8 Any rights created by statute or law governing arbitration proceedings inconsistent with the above procedure or which interfere with compliance therewith are hereby waived by parties to whom they accrue.

7.9 The fees and expenses of the Permanent Arbitrator shall be borne by the party or parties found in violation, or in the event no violation is found, such fees and expenses shall be borne by the moving party.

ARTICLE VIII – MISCELLANEOUS

8.1 If any Article or provision of this PLA shall be declared invalid, inoperative or unenforceable by operation of law or by final non-appealable order of any tribunal of competent jurisdiction, such provision shall be deemed severed or limited, but only to the extent required to render the remaining provisions of this PLA enforceable consistent with the intent of the parties. The remainder of this PLA or the application of such Article or provision to persons or circumstances other than those as to which it has been held invalid, inoperative or unenforceable shall not be affected thereby.

8.2 The term of this PLA shall commence as of and from the date of the notice of award to the Prime Contractor and shall end upon final acceptance by IDOT of all work on the Project by the parties hereto.

- 8.3 This PLA may not be changed or modified except by the subsequent written agreement of the parties. All parties represent that they have the full legal authority to enter into this PLA. This PLA may be executed by the parties in one or more counterparts.
- 8.4 Any liability arising out of this PLA shall be several and not joint. IDOT shall not be liable to any person or other party for any violation of this PLA by any other party, and no Contractor or Union shall be liable for any violation of this PLA by any other Contractor or Union.
- 8.5 The failure or refusal of a party to exercise its rights hereunder in one or more instances shall not be deemed a waiver of any such rights in respect of a separate instance of the same or similar nature.

[The Balance of This Page Intentionally Left Blank]

Execution Page

Illinois Department of Transportation

Christine M. Reed, P.E., Director of Highways

Ann Schneider, Director Finance & Administration

Ellen Schanzle-Haskins, Chief Counsel

Milton R. Sees, Secretary

(Date)

Illinois AFL-CIO Statewide Project Labor Agreement Committee, representing the local unions listed below:

(Date)

List Union Locals:

Exhibit A – Contractor Letter of Assent

(Date)

To All Parties:

In accordance with the terms and conditions of the contract for Construction Work on [], this Letter of Assent hereby confirms that the undersigned Prime Contractor or Subcontractor agrees to be bound by the terms and conditions of the Project Labor Agreement established and entered into by the Illinois Department of Transportation in connection with said Project.

It is the understanding and intent of the undersigned party that this Project Labor Agreement shall pertain only to the identified Project. In the event it is necessary for the undersigned party to become signatory to a collective bargaining agreement to which it is not otherwise a party in order that it may lawfully make certain required contributions to applicable fringe benefit funds, the undersigned party hereby expressly conditions its acceptance of and limits its participation in such collective bargaining agreement to its work on the Project.

(Authorized Company Officer)

(Company)

STATE OF ILLINOIS
DEPARTMENT OF TRANSPORTATION
PLANS FOR PROPOSED ROADWORK

Sheet 1 of 32

FAU 5773 & 5855
D2 Spring RS 2007-12
Rock Island County

C-92-096-07
D-92-089-07

INDEX OF SHEETS

1. Cover Sheet
- Index of Sheets
- 2-4 Summary of Quantities
- 5-7 General Notes
- 8-12a Typical Sections
- 13-19 Schedule of Work
- 20-26 Plan Sheets
- 27-28 Detailed Location Maps
29. As Built Plans
- 30-32 District Standards
(41.1)(97.4)

R1W

Begin Work
Sta. 0+00

End Work
Sta. 16+78

EAST MOLINE

Begin Work
Sta. 33+60

REGION 2
DIXON, ILLINOIS

End Work
Sta. 1+77

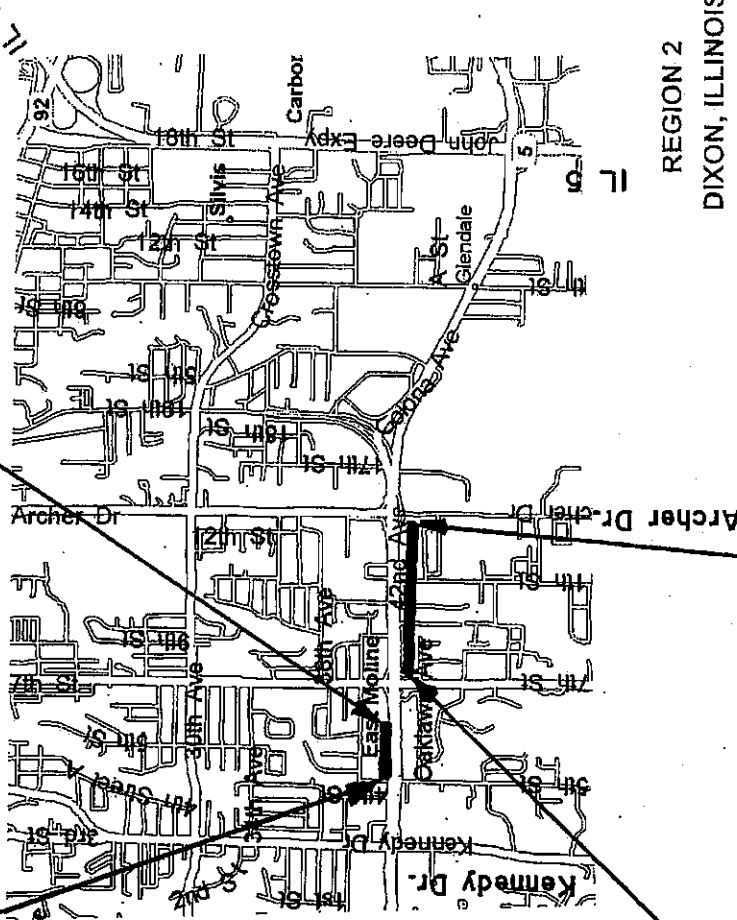

1172

STANDARDS

- 701001-01
- 701006-02
- 701301-02
- 701311-02
- 701501-04
- 701801-03
- 701901
- 720001
- 720011
- 728001
- 729001
- 780001-01

STATE OF ILLINOIS
DEPARTMENT OF TRANSPORTATION
DIVISION OF HIGHWAYS

SUBMITTED Nov 29 2007

George E. Ryan
DEPUTY DIRECTOR OF HIGHWAYS, REGION 2 ENGINEER

CONTRACT NUMBER 64D44
CALL J.U.I.E. BEFORE YOU DIG
800-892-0123

South Moline Twp. - Sec. 1, 2

SUMMARY OF QUANTITIES

1000
100% State

CODE NO.	ITEM	UNIT	QUANTITY	FAU 5773 (So. Road)	FAU 5855 (No. Road)
20200600	EXCAVATING AND GRADING EXISTING SHOULDER	UNIT	29.7	29.7	--
21101600	TOPSOIL FURNISH AND PLACE, VARIABLE DEPTH	SQ YD	277	277	--
25200100	SODDING	SQ YD	277	277	--
40600200	BITUMINOUS MATERIALS (PRIME COAT)	TON	2.7	2.7	--
40600982	HOT-MIX ASPHALT SURFACE REMOVAL - BUTT JOINT	SQ YD	133	133	--
40600990	TEMPORARY RAMP	SQ YD	305	305	--
40600985	PORTLAND CEMENT CONCRETE SURFACE REMOVAL - BUTT JOINT	SQ YD	75	75	--
40600300	AGGREGATE (PRIME COAT)	TON	14	14	--
40600525	LEVELING BINDER (HAND METHOD), N50	TON	20	20	--
40600625	LEVELING BINDER (MACHINE METHOD), N50	TON	492	492	--
40603310	HOT-MIX ASPHALT SURFACE COURSE, MIX "C", N50	TON	616	616	--
40800050	INCIDENTAL HOT-MIX ASPHALT SURFACING	TON	39	39	--
42300400	PORTLAND CEMENT CONCRETE DRIVEWAY PAVEMENT, 8 INCH	SQ YD	207	83	124
42400100	PORTLAND CEMENT CONCRETE SIDEWALK 4 INCH	SQ FT	5,640	2,492	3,148
42400410	PORTLAND CEMENT CONCRETE SIDEWALK 8 INCH	SQ FT	268	--	268

SUMMARY OF QUANTITIES

1000
100% State

CODE NO.	ITEM	UNIT	QUANTITY	FAU 5773 (So. Road)	FAU 5855 (No. Road)
44000200	DRIVEWAY PAVEMENT REMOVAL	SQ YD	207	83	124
44000600	SIDEWALK REMOVAL	SQ FT	4,636	1,220	3,416
44000157	HOT-MIX ASPHALT SURFACE REMOVAL, 2"	SQ YD	512	512	--
44201737	CLASS D PATCHES, TYPE I, 8 INCH	SQ YD	3	3	--
44201741	CLASS D PATCHES, TYPE II, 8 INCH	SQ YD	15	15	--
44201745	CLASS D PATCHES, TYPE III, 8 INCH	SQ YD	42	42	--
44201747	CLASS D PATCHES, TYPE IV, 8 INCH	SQ YD	388	388	--
48101200	AGGREGATE SHOULDERS, TYPE B	TON	131	131	--
48203100	HOT-MIX ASPHALT SHOULDERS	TON	364	364	--
67100100	MOBILIZATION	L SUM	1	0.9	0.1
70102620	TRAFFIC CONTROL AND PROTECTION, STANDARD 701501	L SUM	1	1	--
70102640	TRAFFIC CONTROL AND PROTECTION, STANDARD 701801	L SUM	1	0.5	0.5
70300100	SHORT-TERM PAVEMENT MARKING	FOOT	955	955	--
70301000	WORK ZONE PAVEMENT MARKING REMOVAL	SQ FT	107	107	--

GENERAL NOTES

The millings from Hot-Mix Asphalt Surface Removal shall be used to build up the existing shoulders, as shown on the typical sections and /or as directed by the Engineer. The shoulder shall be rolled and compacted as directed by the Engineer. Excess grindings or large chunks shall be disposed of by the Contractor. No grindings will be allowed on the foreslopes. The cost shall be included in the contract unit price for the HOT-MIX ASPHALT SURFACE REMOVAL specified. The millings from PORTLAND CEMENT CONCRETE SURFACE REMOVAL – BUTT JOINT will become the property of the contractor, to be properly disposed of.

If, during the grinding or resurfacing operations, the existing mailboxes become a hindrance, the Contractor shall be required to carefully remove and reinstall the mailboxes as directed by the Engineer. This work shall be included in the contract unit price per ton for INCIDENTAL HOT-MIX ASPHALT SURFACING.

To help avoid excess drop offs at the edge of pavement, the existing aggregate wedge or shoulder, including all private entrances and gravel side road approaches shall be pulled up and rolled to match the edge of the pavement, as directed by the Engineer, prior to placing any Hot-Mix Asphalt. All costs associated with pulling up the shoulders and rolling shall be considered to be included in the contract unit price per TON for INCIDENTAL HOT-MIX ASPHALT SURFACING.

The following Mixture Requirements are applicable for all locations in this project.

Mixture Uses	Surface	Level Binder	Bottom Shoulder
AC/PG:	PG 64-22	PG 64-22	PG 58-22
RAP % (Max)	15%	25%	30%
Design Air Voids:	4% @ N50	4% @ N50	2% @ N50
Mixture Composition (Gradation Mixture)	IL 9.5 or 12.5	IL 9.5	BAM
Friction Aggregate	C	N/A	N/A

Pavement Markings shall be done according to Standard 780001, except as follows:

- The distance between yellow no-passing lines shall be 8", not 7" as shown in the detail of
- Typical Lane and Edge Lines.

Two applications of paint pavement markings shall be applied to the final pavement surface to match the existing markings and as directed by the Engineer. The second application shall not be applied until the first application has completely dried.

Estimated Paint Pavement Markings on this Project

Location	4" Yellow	4" White	24" White
1 st Application	776	5,978	43
2 nd Application	776	5,978	43
Project Grand Total	1,552	11,956	86

GENERAL NOTES (Continued)

The Contractor will be required to furnish 5-1/2" high brass stencils as approved by the Engineer and install stationing at 250' intervals. Stationing shall be placed on both lanes of 2-lane highways and on the outside lanes in both directions on 4-lane highways. The stations shall be placed 6" inside the pavement marking edge so they can be read from the shoulder. This work will be included in the cost of the final pavement surface.

During the HOT-MIX ASPHALT SURFACE REMOVAL, any hand removal required around gutters, man holes, structures, catch basins, any utility structure, and frames and grates shall be considered to be included in the contract unit price per SQ. YD. for HOT-MIX ASPHALT SURFACE REMOVAL, 2-INCH.

Name & Address of Utility	Type	Telephone	JULIE Member?
Mr. Dave Creen AT&T 635 – 18 th Street Rock Island, IL 61201	TELEPHONE	(309)-793-4456	Yes
Mr. Matthew J. Chancellor MidAmerican Energy Company 2811 5 th Ave. Moline, IL 61201	ELECTRIC	(309)-793-3833	Yes
Mr. Dennis Jarding Mediacom 3900-26 th Avenue Moline, IL 61265	CATV	(309)-743-4750	Yes
Mr. Tim Cammler City of East Moline 1200 – 13 th Avenue East Moline, IL 61244	WATER & SEWER	(309)-752-1595	Yes

Name & Address of Utility	Type	Telephone	JULIE Member?
Mr. Kyle Lorenz IDOT – Region 2 819 Depot Avenue Dixon, IL 61021	GOVT	(815)-284-5469	No

All Borrow/Waste/Use sites must be approved by the Department prior to removing any material from the project or initiating any earthmoving activities, including temporary stockpiling outside the limits of construction.

FAU 5773 & 5855
D2 Spring RS 2007-12
Rock Island County
Sheet 7 of 32
Contract Number: 64D44

GENERAL NOTES (Continued)

Fertilizer shall be applied to all disturbed areas and incorporated into the seedbed prior to seeding or placement of sod at the rate specified in Sections 250 and 252 of the Standard Specifications. This work shall be included in the cost of SODDING.

The disturbed areas along the new sidewalk, along the North service road, shall be filled with topsoil and seeded using class 1A (salt tolerant lawn mixture). This area is where the sidewalk form is removed. The cost of this topsoil and seed shall be considered to be included in the contract unit price per SQ. FT. for PORTLAND CEMENT CONCRETE SIDEWALK of the thickness specified.

The Contractor shall place temporary hot-mix asphalt tapers along all sides of utility structures protruding above the milled surface. The temporary tapers shall extend 2' outside of castings, except for the approach side to traffic shall have a 4' taper length. Hot-mix asphalt meeting the approval of the Engineer shall be used, not cold millings will be allowed. The cost of the material, placement, maintenance, removal and disposal of said work will be included in the Pay Item for Hot-Mix Asphalt Surface Removal.

TYPICAL SECTIONS

Sta. 1+77 - 28+35

FAU 5773 & 5855
 D2 Spring RS 2007-12
 Rock Island County
 Sheet 8 of 32
 Contract Number: 64D44

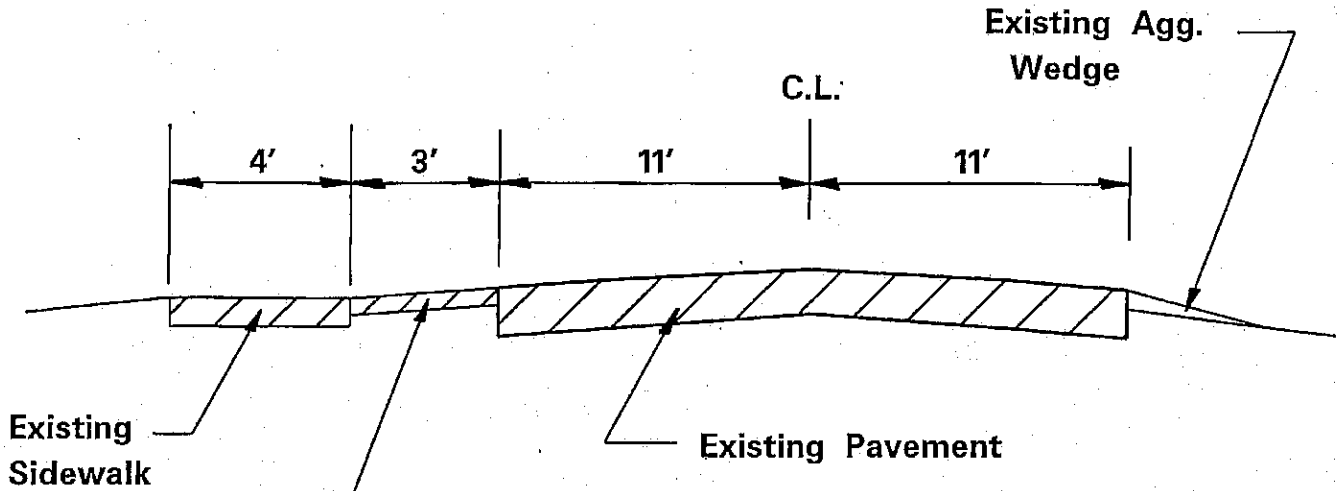

This area has been filled in with Asphalt over the years (90% +/-) and some concrete and asphalt entrances have been constructed into this area.

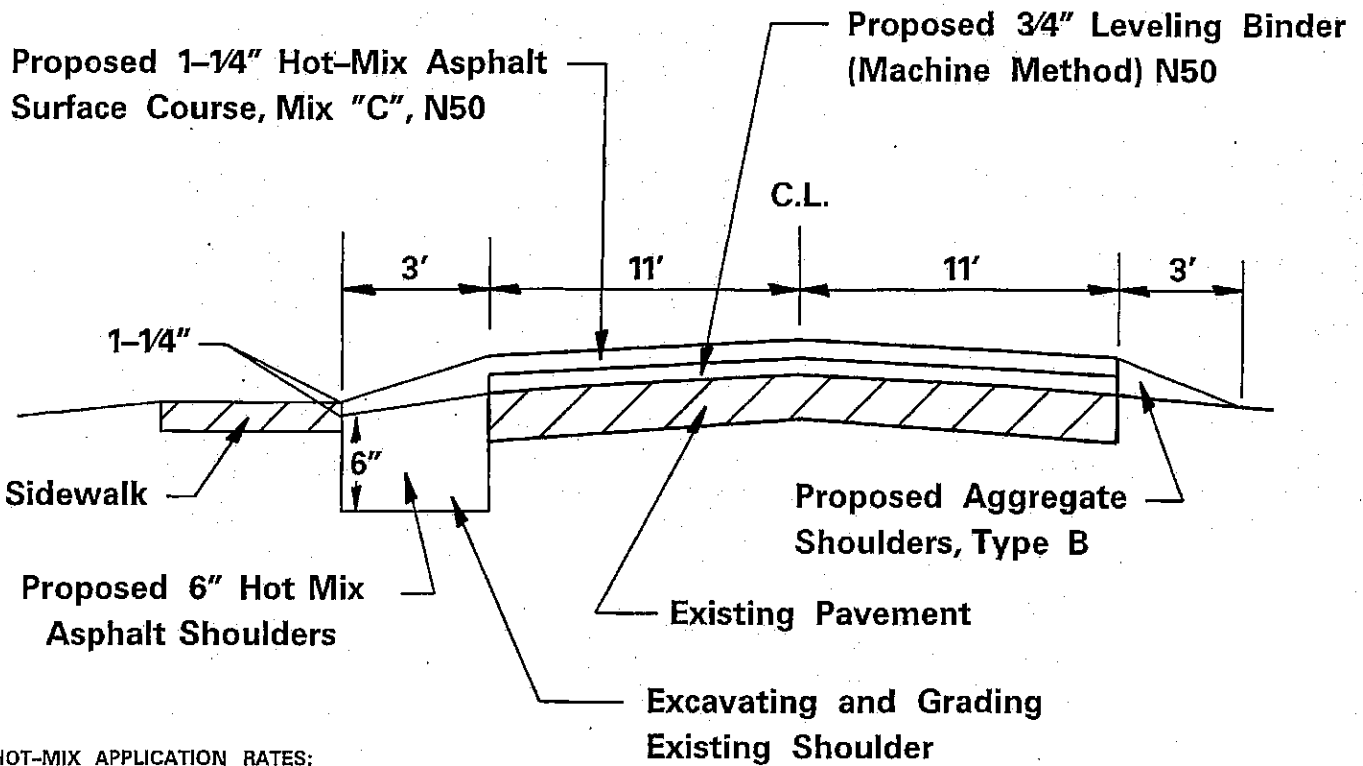

HOT-MIX APPLICATION RATES:

All Hot-Mix Asphalt Mixtures: 112lb/sq. yd/inch

Bituminous Materials (Prime Coat) = 0.000286 Ton/Sq. Yd.

Aggregate (Prime Coat) = 0.0015 Ton/Sq. Yd.

powerdraft: SpringRS2007-12.dgn

TYPICAL SECTIONS

Sta. 28 + 35 - 32 + 18

FAU 5773 & 5855
 D2 Spring RS 2007-12
 Rock Island County
 Sheet 9 of 32
 Contract Number: 64D44

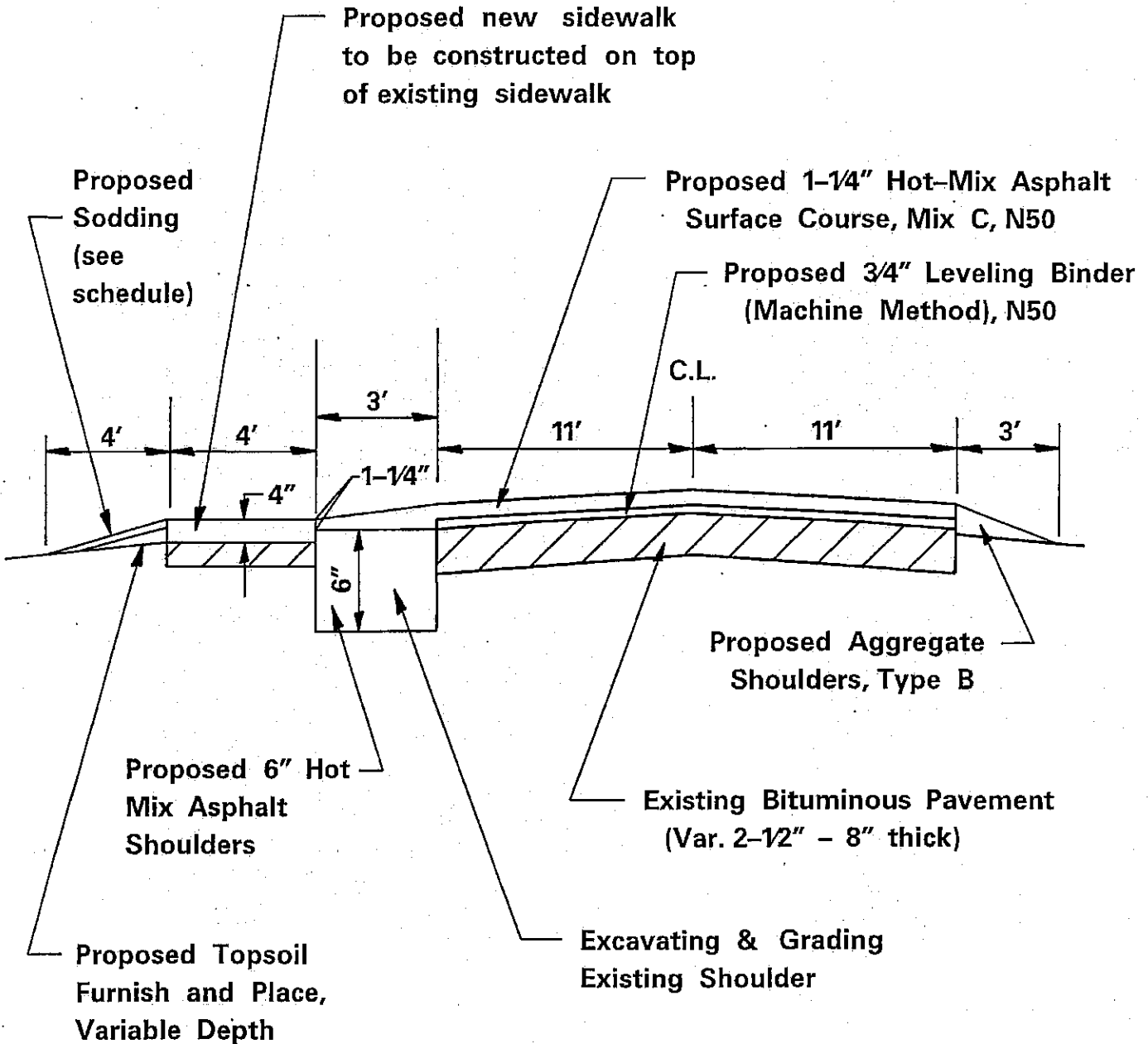

HOT-MIX APPLICATION RATES:

All Hot-Mix Asphalt Mixtures: 112 lb/sq. yd/inch

Bituminous Materials (Prime Coat) = 0.000286 Ton/Sq. Yd.

Aggregate (Prime Coat) = 0.0015 Ton/Sq. Yd.

TYPICAL SECTIONS

Sta. 32+18 - 33+60

FAU 5773 & 5855

D2 Spring RS 2007-12

Rock Island County

Sheet 10 of 32

Contract Number: 64D44

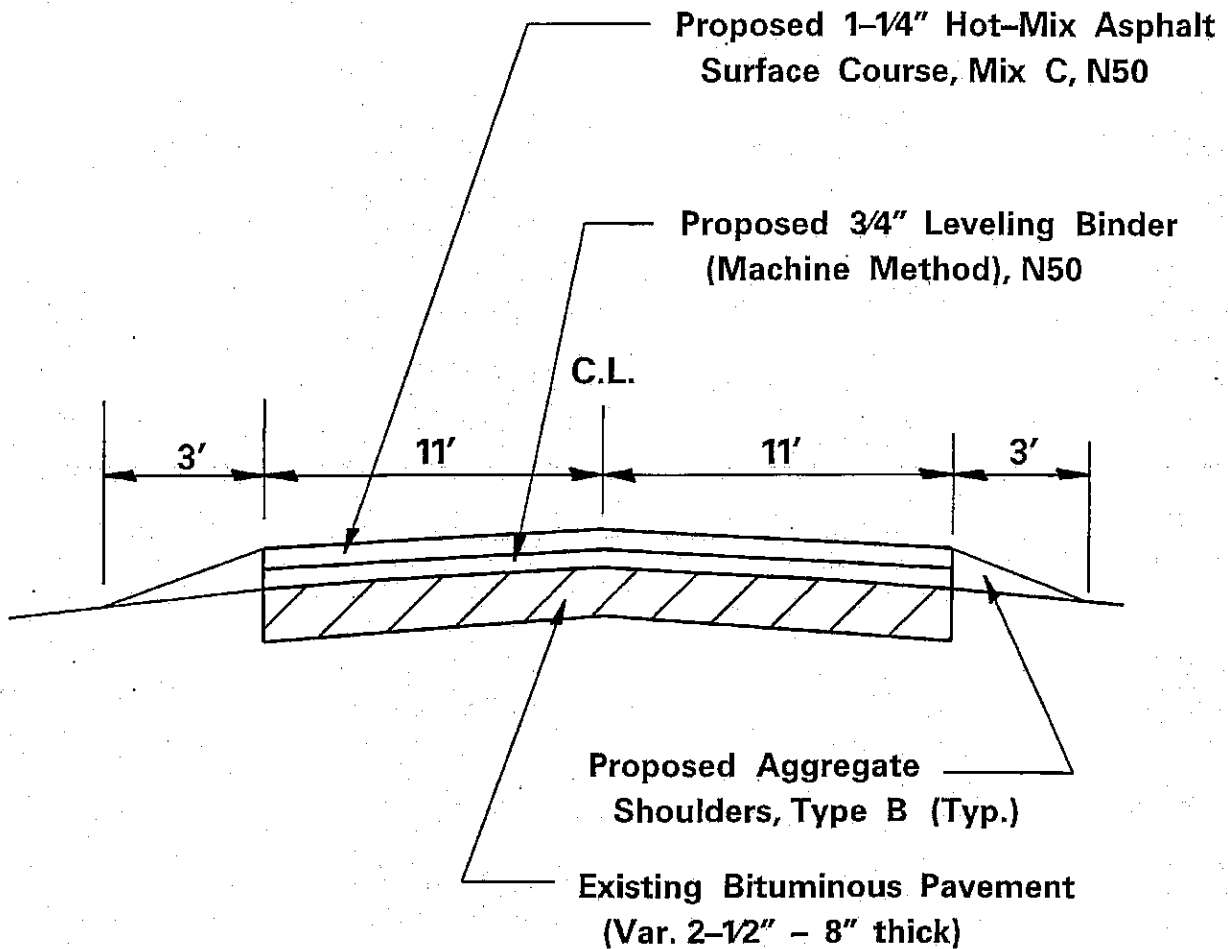

HOT-MIX APPLICATION RATES:

All Hot-Mix Asphalt Mixtures: 112 lb./sq. yd/inch

Bituminous Materials (Prime Coat) = 0.000286 Ton/Sq. Yd.

Aggregate (Prime Coat) = 0.0015 Ton/Sq. Yd.

PCC BUTT JOINT DETAIL

FAU 5773 & 5855
 D2 Spring RS 2007-12
 Rock Island County
 Sheet 11 of 32
 Contract 64D44

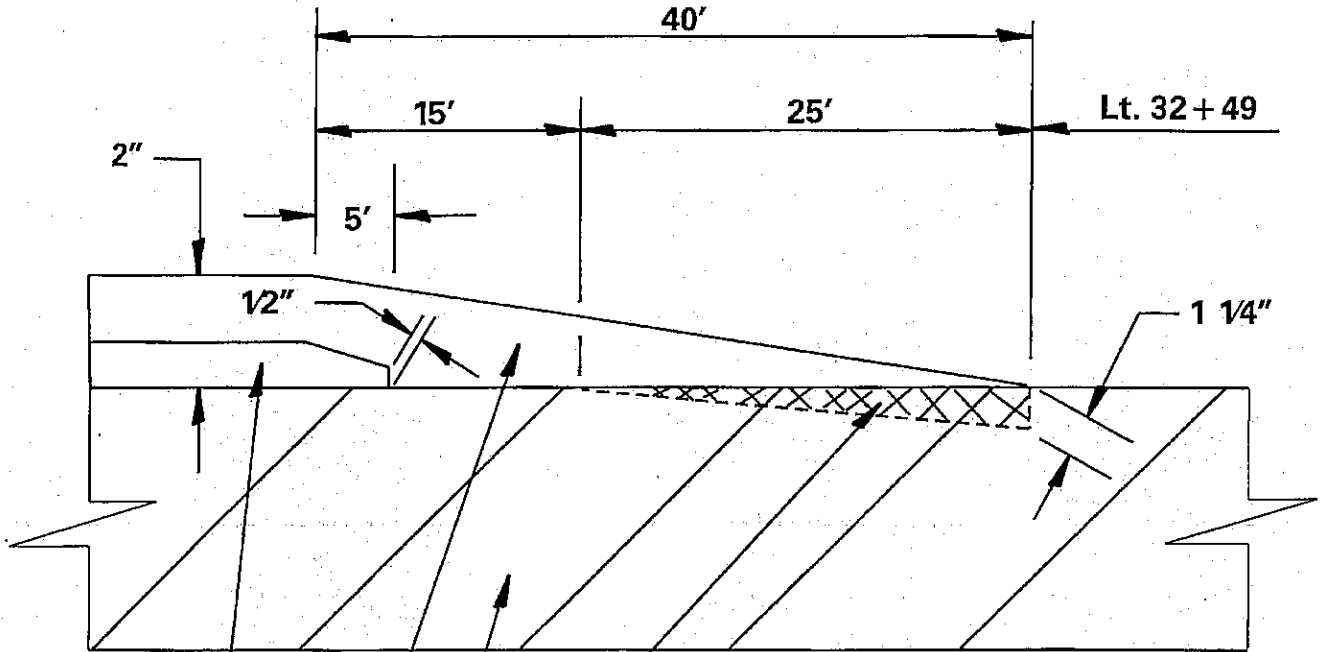

Proposed
 PCC Surface Removal - Butt Joint
 0" - 1 1/4" in 25' - Full Pavement Width

Existing P.C.C. Pavement

Proposed
 Bituminous Concrete Surface
 Course, Superpave, "C", N50

Proposed
 3/4" Level Binder, Machine
 Method, Superpave, N50

HOT-MIX APPLICATION RATES:

All Hot-Mix Asphalt Mixtures: 112 lb/sq. yd/inch
 Bituminous Materials (Prime Coat) = 0.000286 Ton/Sq. Yd.
 Aggregate (Prime Coat) = 0.0015 Ton/Sq. Yd.

HOT-MIX ASPHALT SURFACE REMOVAL - BUTT JOINT

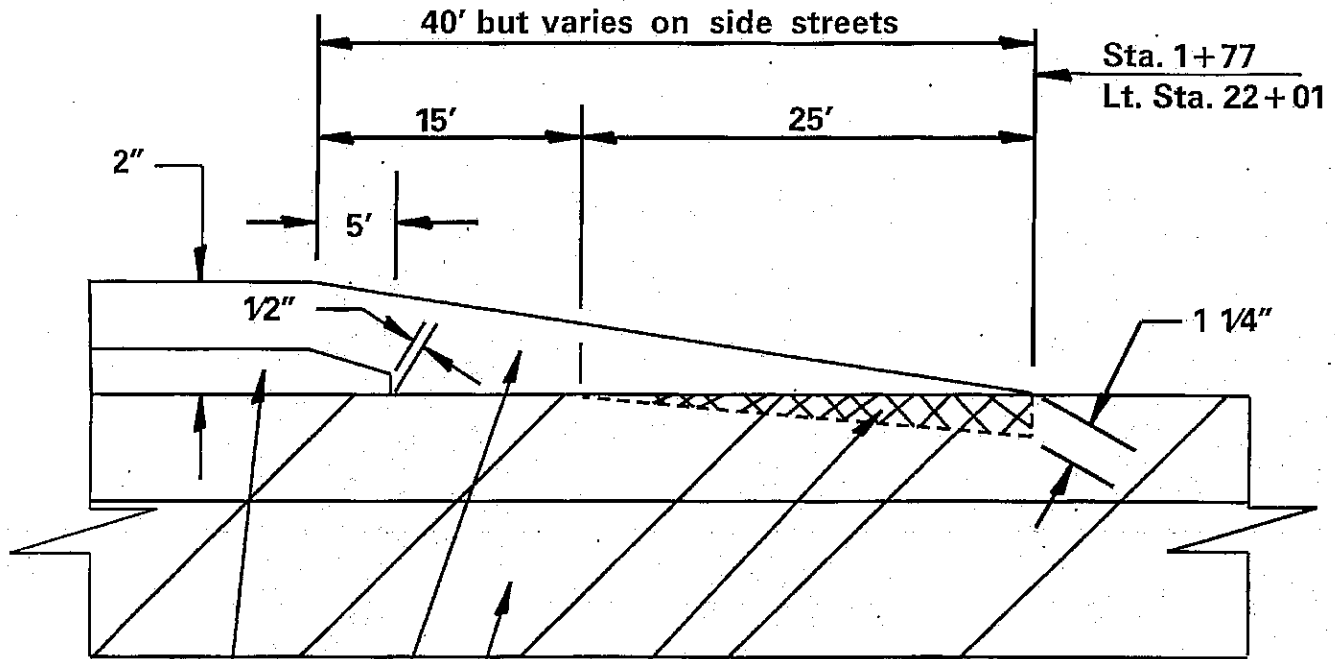

Hot-Mix Asphalt
 Surface Removal - Butt Joint
 0" - 1 1/4" in 25' - Full Pavement Width

Existing Pavement with Bituminous Surface

Hot-Mix Asphalt Surf. Cse., Mix "C", N50

3/4" Leveling Binder,
 (Machine Method), N50

HOT-MIX ASPHALT APPLICATION RATES:
 All Hot-Mix Asphalt Mixtures: 112lb/sq. yd/inch
 Bituminous Materials (Prime Coat) = 0.000286 Ton/Sq. Yd.
 Aggregate (Prime Coat) = 0.0015 Ton/Sq. Yd.

Sidewalk Traffic Control Detail

Also refer to Standard 701801

FAU 5773 & 5855
 D2 Spring MRS 2007-12
 Rock Island County
 Sheet 12a of 32
 Contract Number: 64D44

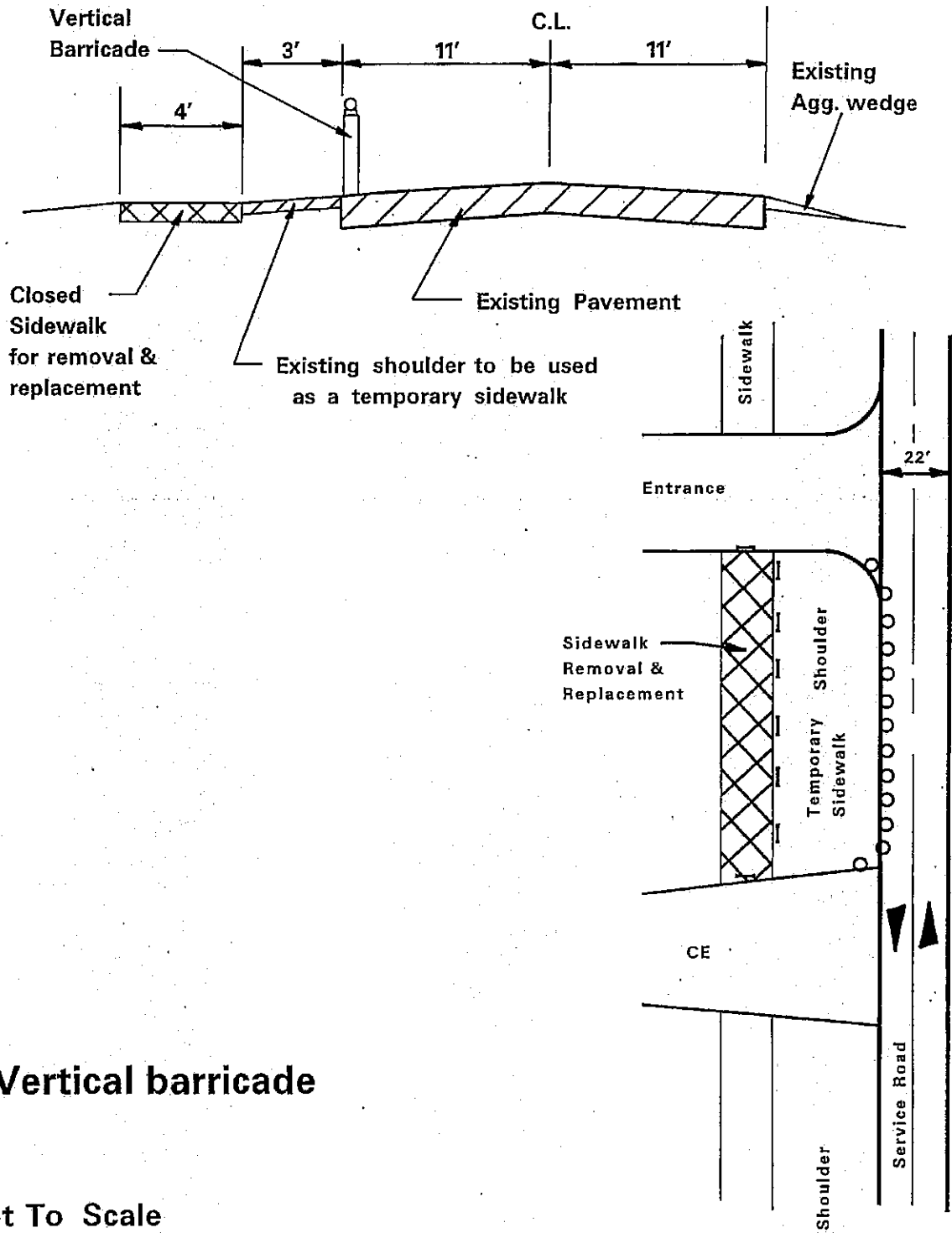

○ Vertical barricade

Not To Scale

powerdraft: sidewalkTCmrs2007-12.dgn

Schedule of Work

EXCAVATING AND GRADING EXISTING SHOULDER

Location	UNIT
FAU 5773 (South Service Road)	
Lt. Sta. 1+77 - 13+35 (3' wide)	11.58
Lt. Sta. 14+00 - 14+26 (7' wide)	0.26
Lt. Sta. 14+26 - 32+18 (3' wide)	<u>17.92</u>
Total	29.70

SIDEWALK REMOVAL

Location	SQ. FT.
FAU 5773 (South Service Road)	
Lt. Sta. 17+98 - 18+38 (40' x 4')	160
Lt. Sta. 19+05 - 19+80 (75' x 4')	300
Lt. Sta. 21+06 - 21+71 (65' x 4')	260
Lt. Sta. 22+34 - 22+94 (60' x 4')	240
Lt. Sta. 28+35 - 29+00 (65' x 4')	260
FAU 5855 (North Service Road)	
Lt. Sta. 2+30 - 2+45 (15' x 4')	60
Lt. Sta. 3+19 - 4+96 (177' x 4')	708
Lt. Sta. 7+00 - 9+63 (263' x 4')	1,052
Lt. Sta. 10+55 - 11+30 (75' x 4')	300
Lt. Sta. 11+63 - 11+83 (20' x 4')	80
Lt. Sta. 12+56 - 12+88 (32' x 4')	128
Lt. Sta. 13+15 - 13+46 (31' x 4')	124
Lt. Sta. 13+87 - 14+27 (40' x 4')	160
Lt. Sta. 14+77 - 16+78 (201' x 4')	<u>804</u>
Total	4,636

HOT-MIX ASPHALT SURFACE REMOVAL - BUTT JOINT

Location	SQ YD
FAU 5773 (South Service Road)	
Sta. 1+77 - 2+02 (25' x 22')	61.1
Lt. Sta. 22+01 (25' x 26')	<u>72.2</u>
Total	133.3

PORTLAND CEMENT CONCRETE SURFACE REMOVAL - BUTT JOINT

Location	SQ YD
FAU 5773 (South Service Road)	
Lt. Sta. 32+49 (27' x 25')	<u>75.0</u>
Total	75.0

Schedule of Work

PORTLAND CEMENT CONCRETE SIDEWALK 4 INCH

Location	SQ. FT.
FAU 5773 (South Service Road)	
Lt. Sta. 17+98 – 18+38 (40' x 4')	160
Lt. Sta. 19+05 – 19+80 (75' x 4')	300
Lt. Sta. 21+06 – 21+71 (65' x 4')	260
Lt. Sta. 22+34 – 22+94 (60' x 4')	240
Lt. Sta. 28+35 – 29+00 (65' X 4')	260
Lt. Sta. 29+00 – 32+18 (318' X 4')	1,272
 FAU 5855 (North Service Road)	
Lt. Sta. 2+30 – 2+45 (15' X 4')	60
Lt. Sta. 3+19 – 4+96 (177' X 4')	708
Lt. Sta. 7+00 – 7+88 (88' X 4')	352
Lt. Sta. 8+22 – 9+30 (108' X 4')	432
Lt. Sta. 10+55 – 11+30 (75' 4')	300
Lt. Sta. 11+63 – 11+83 (20' X 4')	80
Lt. Sta. 12+56 – 12+88 (32' X 4')	128
Lt. Sta. 13+15 – 13+46 (31' X 4')	124
Lt. Sta. 13+87 – 14+27 (40' X 4')	160
Lt. Sta. 14+77 – 16+78 (201' X 4')	<u>804</u>
Total	5,640

PORTLAND CEMENT CONCRETE SIDEWALK 8 INCH

Location	SQ. FT.
FAU 5855 (North Service Road)	
Lt. Sta. 7+88 – 8+22 (34' X 4')	136
Lt. Sta. 9+30 – 9+63 (33' X 4')	<u>132</u>
Total	268

DRIVEWAY PAVEMENT REMOVAL

Location	SQ. YD.
FAU 5773 (South Service Road)	
Lt. Sta. 29+07 – 29+27	24.4
Lt. Sta. 33+04 – 33+24	58.3
FAU 5855 (North Service Road)	
Lt. Sta. 10+24 – 10+55 plus returns	25.1
Lt. Sta. 11+30 – 11+63 plus returns	74.1
Lt. Sta. 12+26 – 12+56 plus returns	<u>25.1</u>
Total	207.0

Schedule of Work

PAINT PAVEMENT MAKING - LINE 4"

Location	FOOT
FAU 5773 (South Service Road)	
Sta. 1+77 – 13+18 (Dashed Centerline)(Yellow)	286
Sta. 14+00 – 33+60 (Dashed Centerline)(Yellow)	490
White Edge lines:	
Lt. & Rt. Sta. 1+77 – 13+18	2,282
Rt. Sta. 14+00 – 33+60	1,960
Lt. Sta. 14+00 – 14+54	54
Lt. Sta. 14+87 – 18+38	351
Lt. Sta. 19+05 – 21+71	266
Lt. Sta. 22+34 – 32+18	984
Lt. Sta. 32+79 – 33+60	<u>81</u>
Sub Total	6,754
2 nd Application	<u>6,754</u>
Total	13,508

PAINT PAVEMENT MAKING - LINE 24"

Location	FOOT
FAU 5773 (South Service Road)	
Rt. Sta. 13+18 (WB at 11 th Street)	15
Lt. Sta. 13+55 (NB on 11 th Street at Service Rd.)	15
Lt. Sta. 14+00 (EB at 11 th Street)	<u>13</u>
Sub Total	43
2 nd Application	<u>43</u>
Total	86

PORTLAND CEMENT CONCRETE DRIVEWAY PAVEMENT, 8 INCH

Location	SQ. YD.
FAU 5773 (South Service Road)	
Lt. Sta. 29+07 – 29+27	24.4
Lt. Sta. 33+04 – 33+24	58.3
FAU 5855 (North Service Road)	
Lt. Sta. 10+24 – 10+55	25.1
Lt. Sta. 11+30 – 11+63	74.1
Lt. Sta. 12+26 – 12+56	<u>25.1</u>
Total	207.0

Schedule of Work

SODDING

Location	SQ. YD.
FAU 5773 (South Service Road)	
Lt. Sta. 17+98 – 18+38 (40' x 4')	17.8
Lt. Sta. 19+05 – 19+80 (75' x 4')	33.3
Lt. Sta. 21+06 – 21+71 (65' x 4')	28.9
Lt. Sta. 22+34 – 22+94 (60' x 4')	26.7
Lt. Sta. 28+35 – 32+18 (383' x 4')	<u>170.2</u>
Total	276.9

TOPSOIL FURNISH AND PLACE, VARIABLE DEPTH

Location	SQ. YD.
FAU 5773 (South Service Road)	
Lt. Sta. 17+98 – 18+38 (40' x 4')	17.8
Lt. Sta. 19+05 – 19+80 (75' x 4')	33.3
Lt. Sta. 21+06 – 21+71 (65' x 4')	28.9
Lt. Sta. 22+34 – 22+94 (60' x 4')	26.7
Lt. Sta. 28+35 – 32+18 (383' x 4')	<u>170.2</u>
Total	276.9

HOT-MIX ASPHALT SURFACE REMOVAL, 2 INCH

Location	SQ. YD.
FAU 5773 (South Service Road)	
Sta. 12+75 – 13+15 (start removal at 0" and taper to 2" deep at 13+15)	97.8
Sta. 13+15 – 14+05 (includes South leg at 11 th St.)	220.0
Sta. 14+05 – 14+45 (remove from 2" and taper removal to 0" at 14+45)	106.7
Lt. Sta. 13+74 (11 th St.)	<u>87.1</u>
Total	511.6

DETECTOR LOOP, TYPE 1

Location	FOOT
FAU 5773 (South Service Road)	
WB (East leg at 11 th St.) (6' x 20')	70
EB (West leg at 11 th St.) (6' x 20')	75
NB (South leg on 11 th St.) (6' x 20')	<u>70</u>
Total	215

Schedule of Work

TEMPORARY RAMP

Location	SQ YD
FAU 5773 (South Service Road)	
Sta. 1+77 (22' x 4.2')	10.3
Lt. Sta. 2+99 (38' x 3')	12.7
Lt. 4+24 (41' x 3')	13.7
Lt. Sta. 4+91 (70' x 3')	23.3
Lt. Sta. 6+32 (40' x 3')	13.3
Lt. Sta. 7+89 (33' x 3')	11.0
Lt. Sta. 8+46 (42' x 3')	14.0
Lt. Sta. 9+55 (71' x 3')	23.7
Lt. Sta. 11+56 (73' x 3')	24.3
Lt. Sta. 12+27 (50' x 3')	16.7
Lt. Sta. 13+07 (35' x 3')	11.7
Lt. Sta. 13+74 (30' x 6.7')	22.3
Rt. Sta 13+74 (96' x 6.7')	71.5
Lt. Sta. 18+68 (26' x 4.2')	12.1
Lt. Sta. 22+01 (26' x 4.2')	12.1
Lt. Sta. 32+49 (27' x 4.2')	<u>12.6</u>
Total	305.3

HOT-MIX ASPHALT SHOULDERS

Location	TON
FAU 5773 (South Service Road)	
Lt. Sta. 1+77 - 13+35	141
Lt. Sta. 13+78 - 14+26	6
Lt. Sta. 14+26 - 28+35	171
Lt. Sta. 28+35 - 32+18	<u>46</u>
Total	364

Plan Sheet (FAU 5773)

FAU 5773 & 5855
D2 Spring RS 2007-12
Rock Island County
Sheet 20 of 32
Contract Number: 64D44

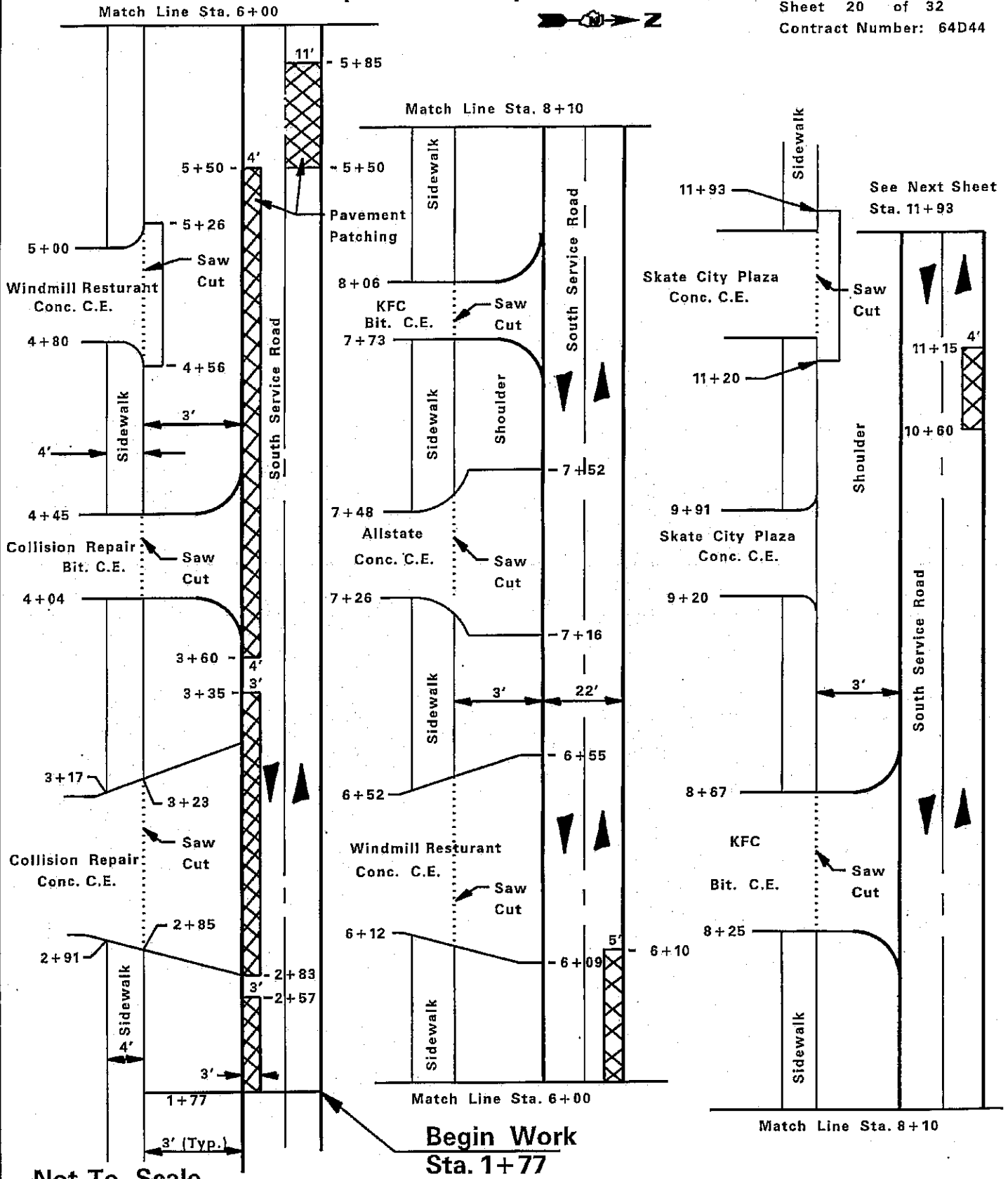

Not To Scale

powerdraft: plansheetmrs2007-12.dgn

Plan Sheet (FAU 5773)

FAU 5773 & 5855
D2 Spring RS 2007-12
Rock Island County
Sheet 21 of 32
Contract Number: 64D44

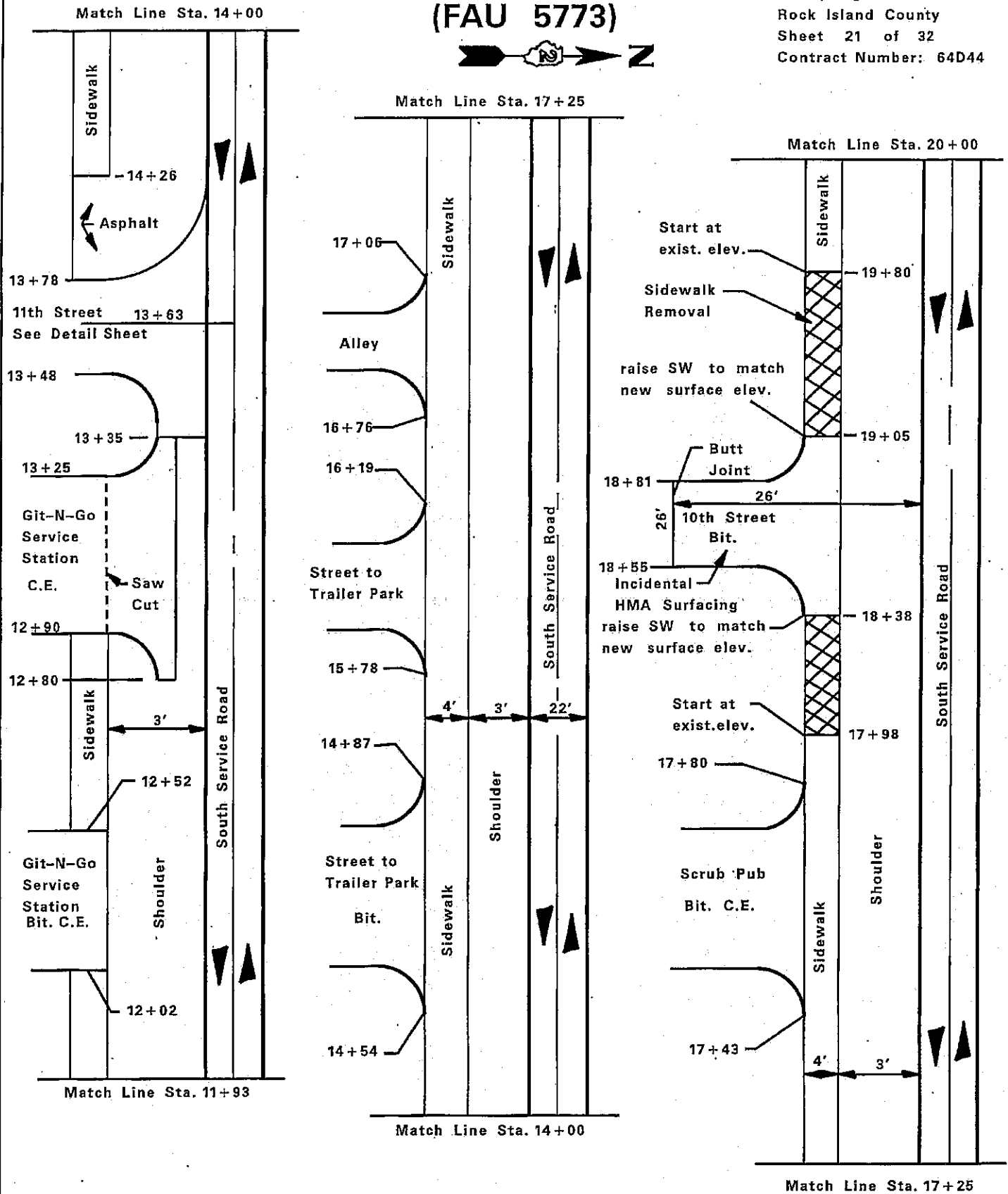

Not To Scale

Plan Sheet (FAU 5773)

FAU 5773 & 5855
D2 Spring RS 2007-12
Rock Island County
Sheet 22 of 32
Contract Number: 64D44



Match Line Sta. 25+50

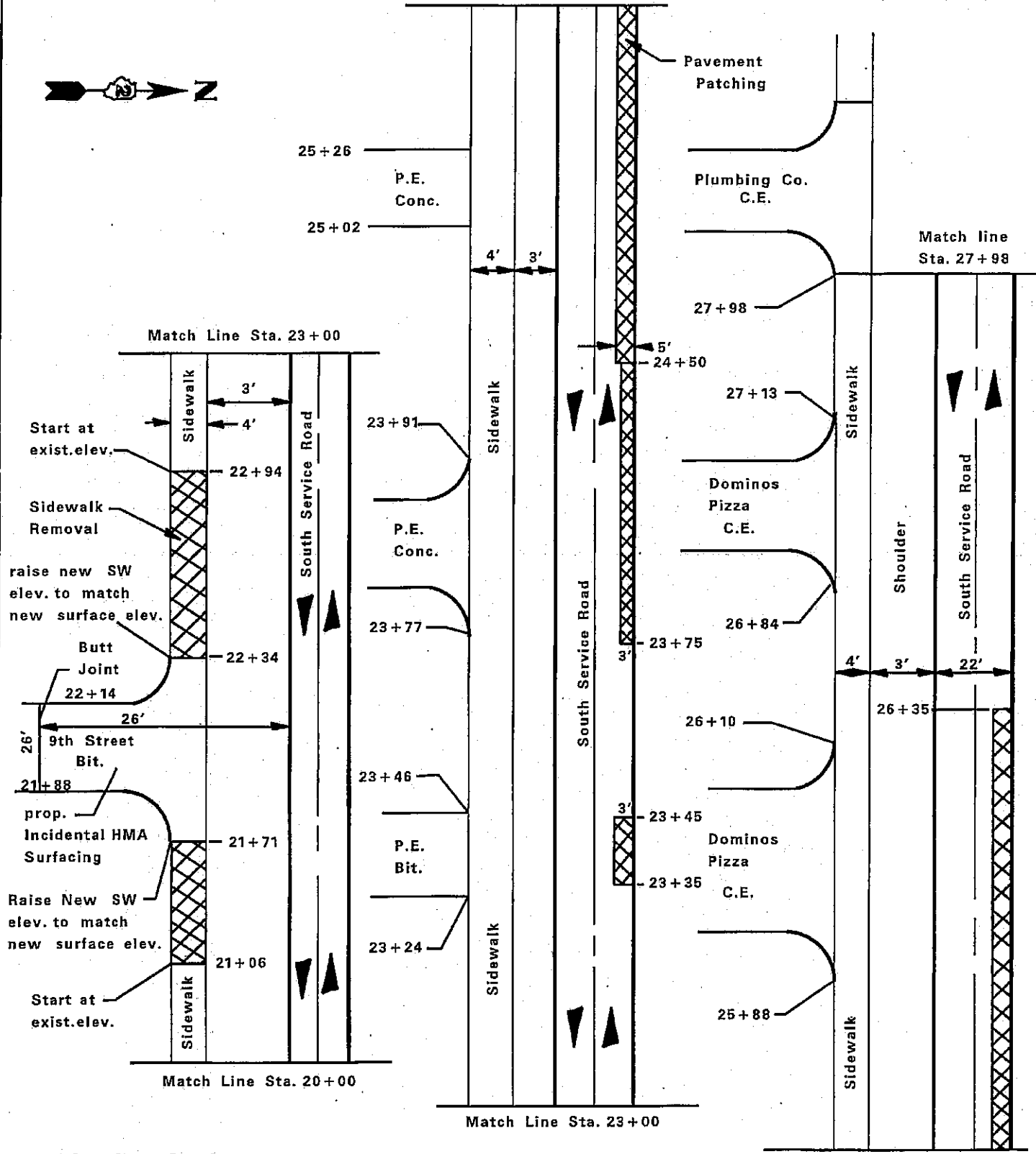

Not To Scale

powerdraft: plansheetpg3mrs2007-12.dgn

Match Line Sta. 25+50

Plan Sheet (FAU 5773)

FAU 5773 & 5855
D2 Spring RS 2007-12
Rock Island County
Sheet 23 of 32
Contract Number: 64D44

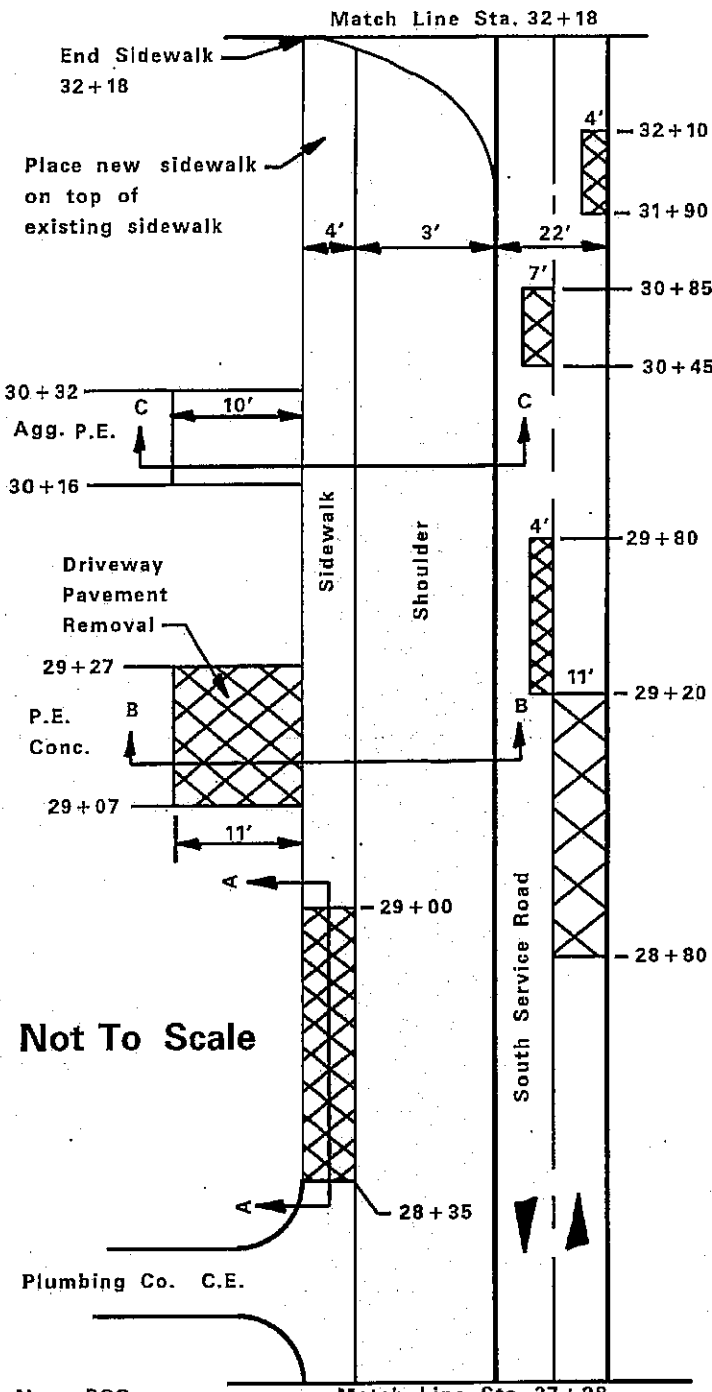

Not To Scale

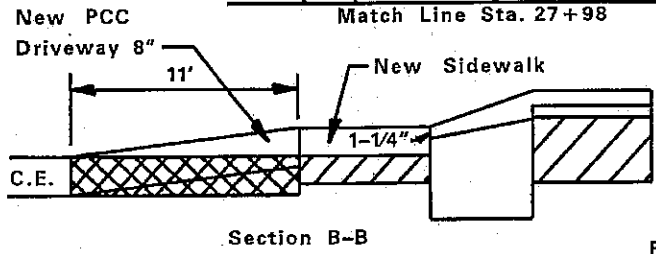

Section B-B

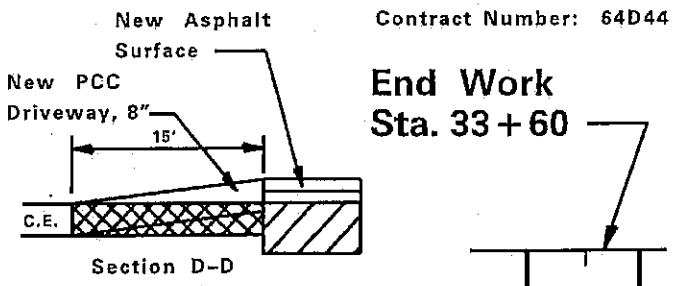

End Work
Sta. 33+60

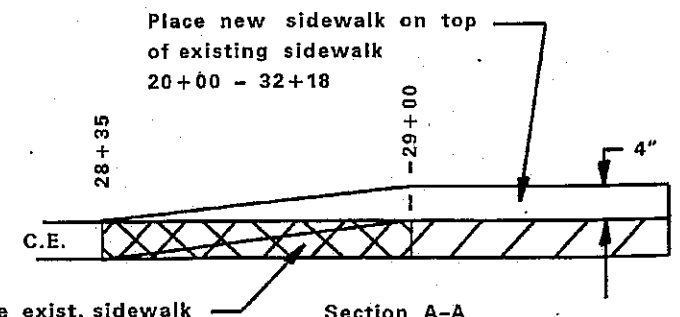
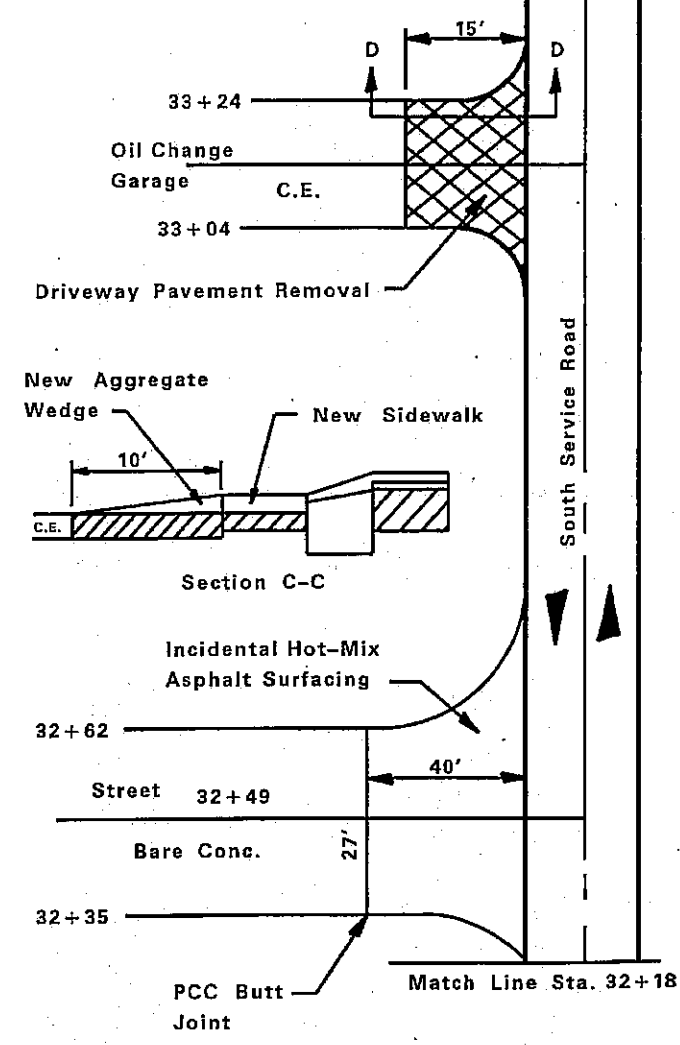

Section A-A

North side of Ave. of the Cities



Plan Sheet FAU 5855

FAU 5773 & 5855
D2 Spring RS 2007-12
Rock Island County
Sheet 24 of 32
Contract Number: 64D44

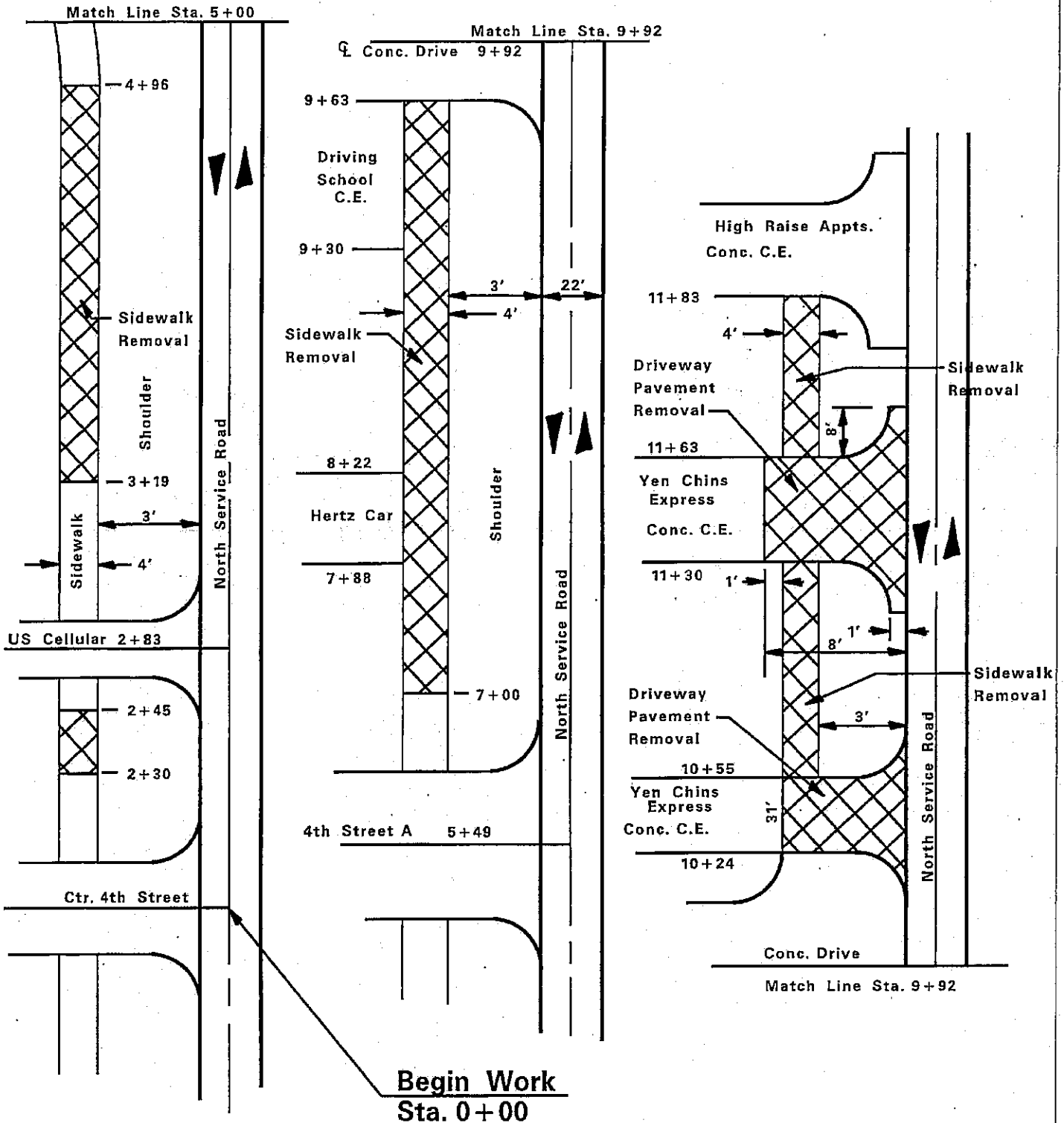

Not To Scale

powerdraft: plansheetsidewalkmrs2007-12.dgn



Plan Sheet

FAU 5855

FAU 5773 & 5855
 D2 Spring MRS 2007-12
 Rock Island County
 Sheet 25 of 32
 Contract Number: 64D44

North side of Ave. of the Cities

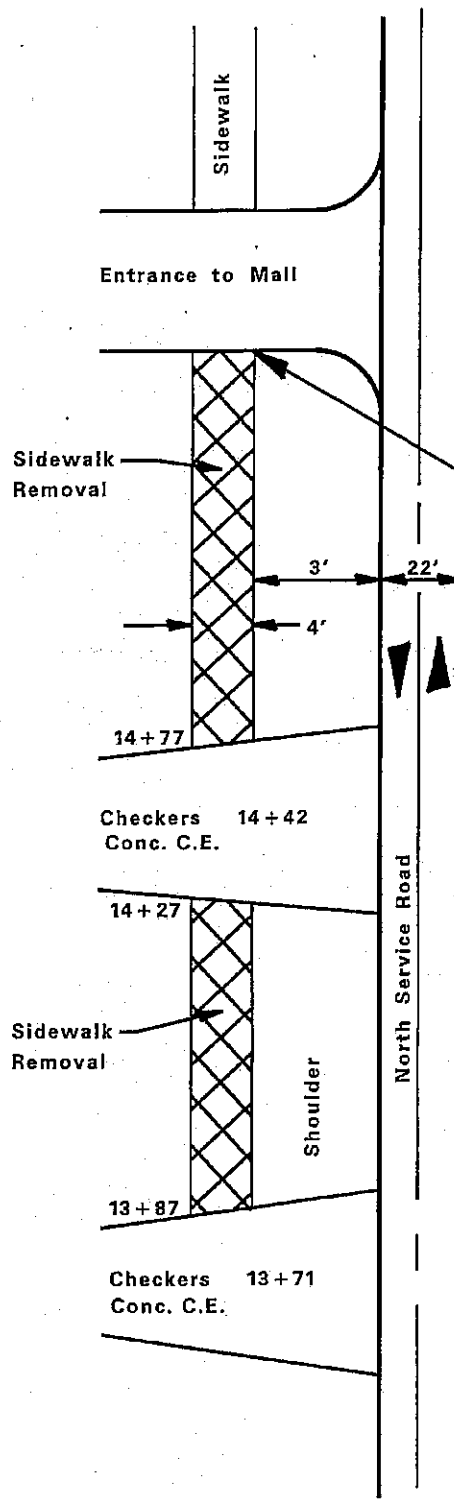
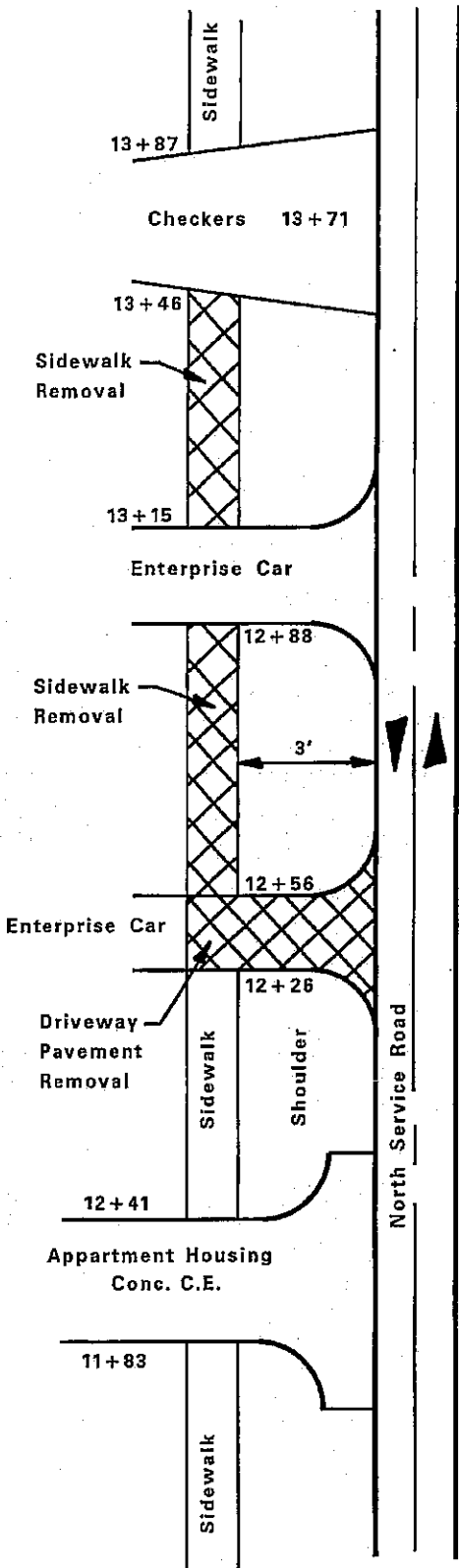

**End Work
 Sta. 16+78**

Not To Scale

powerdraft: plansheetsidewalk1mrs2007-12.dgn

FAU 5773 & 5855
D2 Spring RS 2007-12
Rock Island County
Sheet 26 of 32
Contract Number: 64D44

AVENUE OF THE CITIES

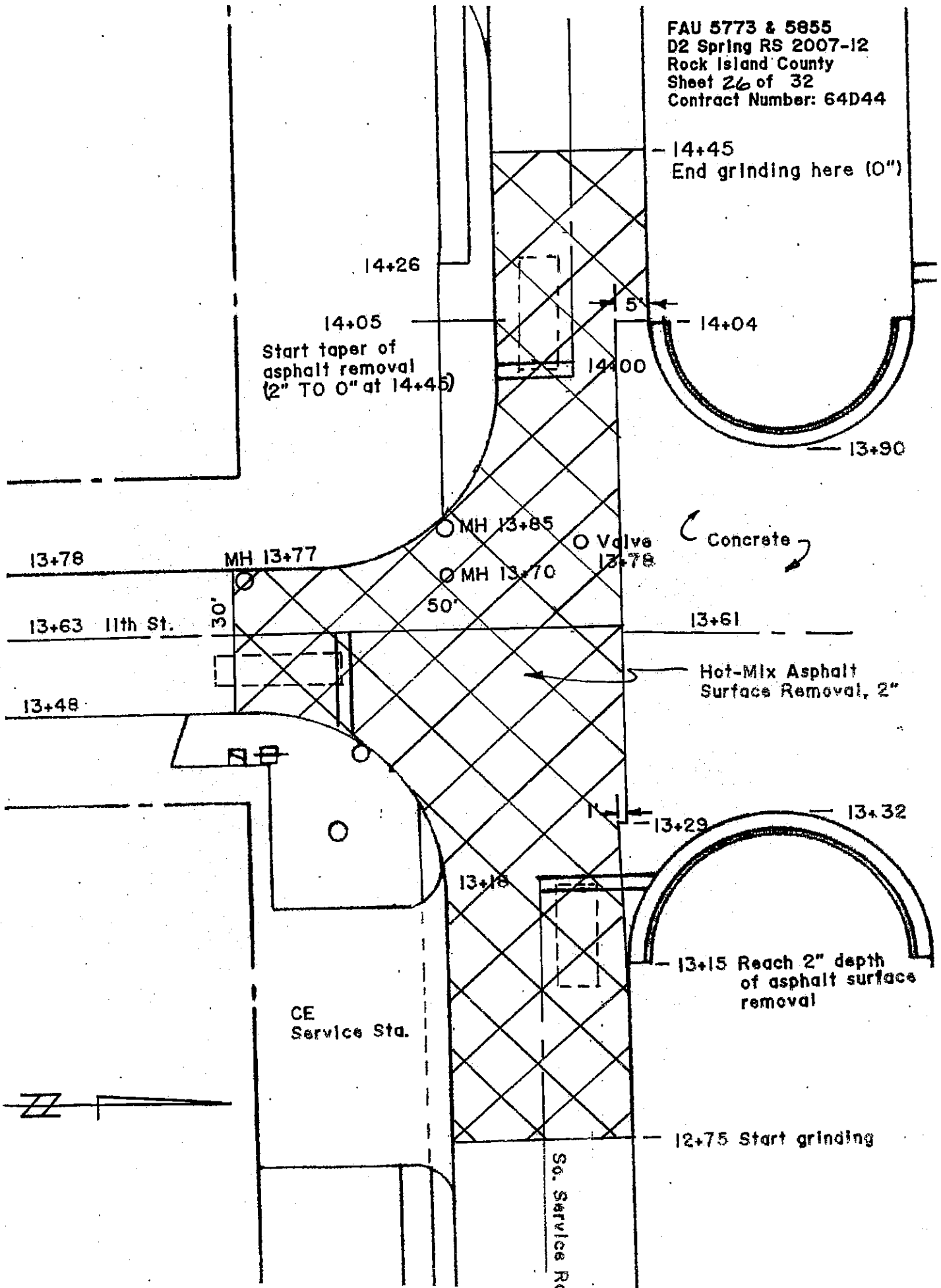

FAU 5773 & 5855
D2 Spring RS 2007-12
Rock Island County
Sheet 27 of 32
Contract Number: 64D44

LOCATION MAP

FAU 5773

South Service Road

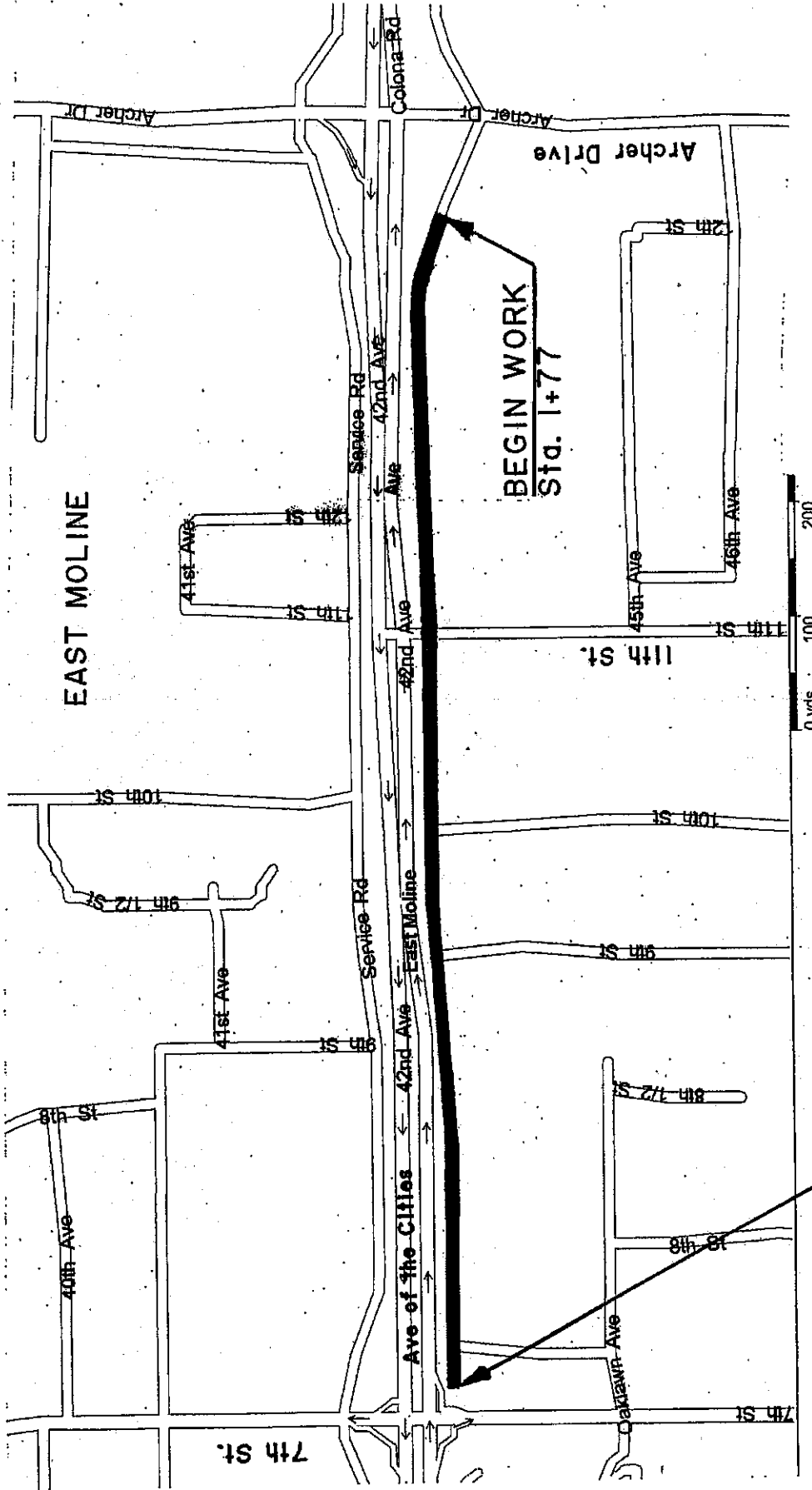

GROSS LENGTH OF FAU 5773 = 3,183' = 0.603 MILE.

FAU 5855

Along the North Service Road
Sidewalk Improvements

FAU 5773 & 5855
D2 Spring RS 2007-12
Rock Island County
Sheet 28 of 32
Contract Number: 64D44

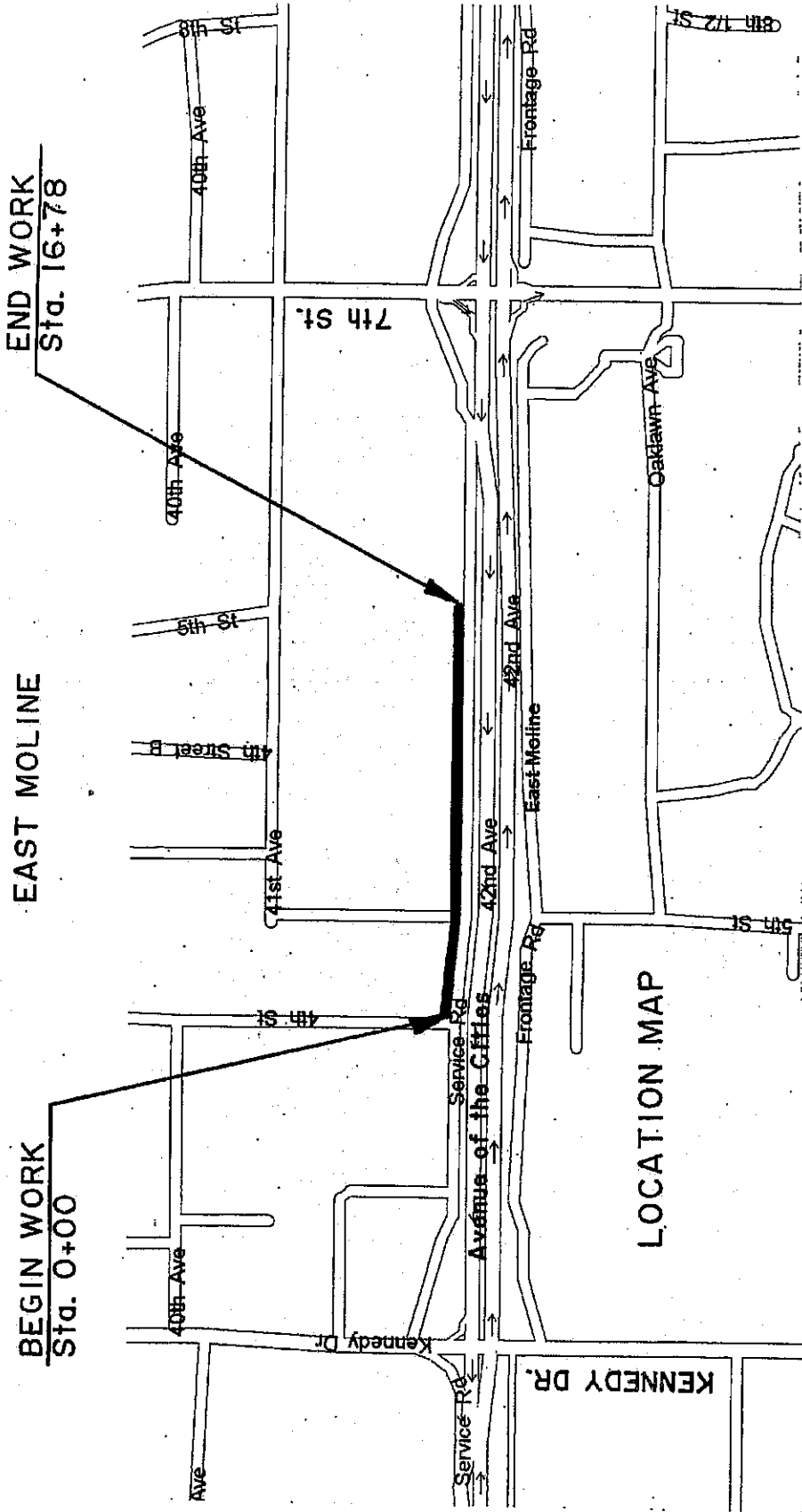

GROSS LENGTH OF FAU 5855 = 1,678' = 0.318 MILE.

FAU 5773 & 5855
 D2 Spring RS 2007-12
 Rock Island County
 Sheet 29 of 32
 Contract Number: 64D44

3507

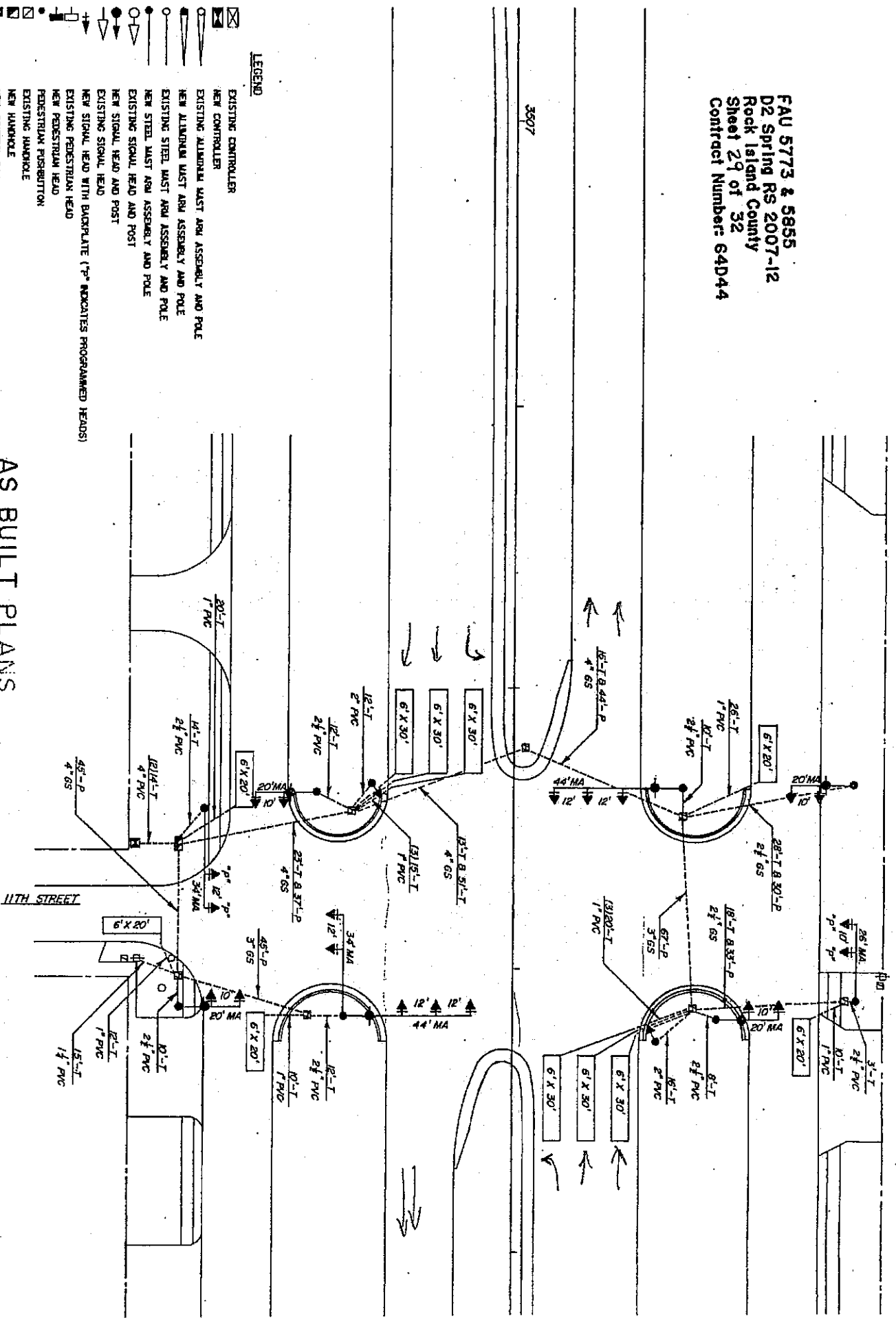

LEGEND

- EXISTING CONTROLLER
- NEW CONTROLLER
- EXISTING ALUMINUM MAST ARM ASSEMBLY AND POLE
- NEW ALUMINUM MAST ARM ASSEMBLY AND POLE
- EXISTING STEEL MAST ARM ASSEMBLY AND POLE
- NEW STEEL MAST ARM ASSEMBLY AND POLE
- EXISTING SIGNAL HEAD AND POST
- NEW SIGNAL HEAD AND POST
- EXISTING SIGNAL HEAD
- NEW SIGNAL HEAD WITH BACKPLATE (1" PRO INDICATES PROGRAMMED HEADS)
- EXISTING PEDESTRIAN HEAD
- NEW PEDESTRIAN HEAD
- PEDESTRIAN PROHIBITION
- EXISTING HANDHOLE
- NEW HANDHOLE
- NEW JUNCTION BOX
- NEW HEAVY-DUTY HANDHOLE
- NEW DOUBLE HANDHOLE
- EXISTING CONDUIT LENGTH AND SIZE
- NEW LAMINAIRE
- NEW GALVANIZED STEEL OR PVC CONDUIT
- UPPER NUMERAL INDICATES LENGTH
- LOWER NUMERAL INDICATES SIZE AND TYPE

AS BUILT PLANS
 FOR INFORMATION ONLY.

FAU 5773 & 5855
 D2 Spring RS 2007-12
 Rock Island County
 Sheet 30 of 32
 Contract Number: 64D-44

SECTION	DATE	BY	CHKD
100 (4) YELLOW	10/10/07
200 (8)	10/10/07
400 (16)	10/10/07
600 (24)	10/10/07
800 (32)	10/10/07
1000 (40)	10/10/07

TYPICAL PAVEMENT MARKINGS

TYPICAL PAVEMENT MARKING FOR FLUSH MEDIAN

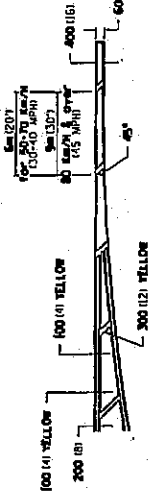
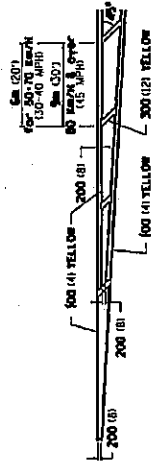

MEDIAN PAVEMENT MARKING

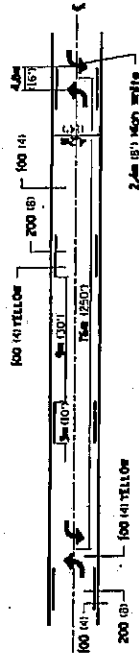

TYPICAL ISLAND OFFSET SHOULDER WIDTH

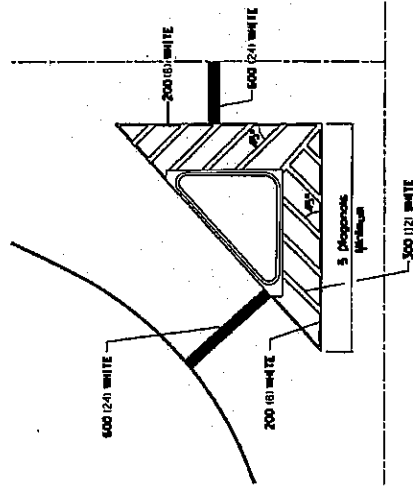

TYPICAL PARKING SPACING

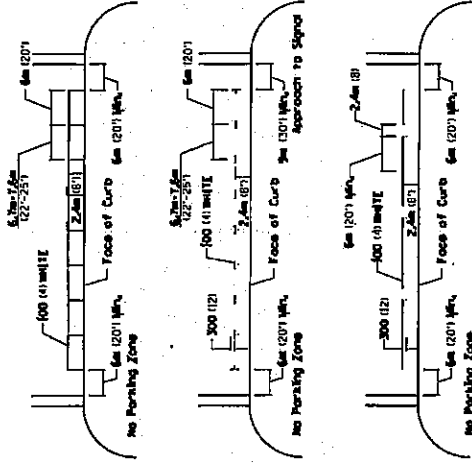

STANDARD CROSSWALK MARKING

See Schedules for Locations

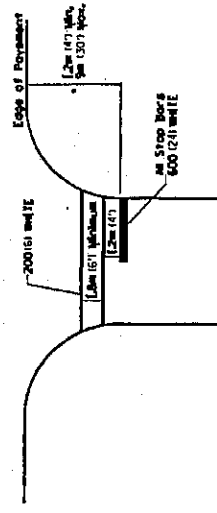

• Distance to the nearest edge of the intersecting roadway in the absence of a marked crosswalk.

FAU 5773 & 5855
 D2 Spring RS 2007-12
 Rock Island County
 Sheet 31 of 32
 Contract Number: 64D44

CONTRACT NO.	SECTION	COUNTY	SHEET NO.
64D44	D2	Rock Island	31
DATE	BY	DATE	BY
12/12/07	...	12/12/07	...

TYPICAL PAVEMENT MARKINGS

TYPICAL PAVEMENT MARKING FOR FLUSH MEDIAN

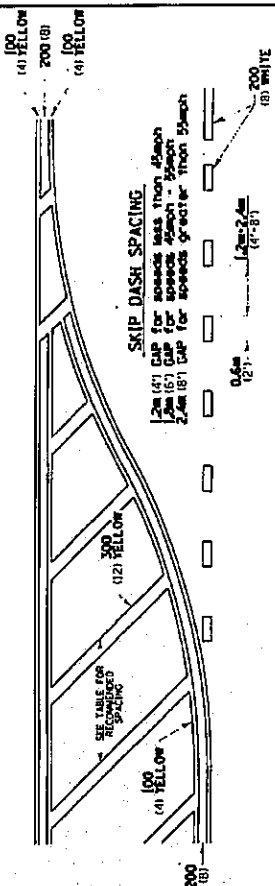

RECOMMENDED SPACING BETWEEN MARKINGS (M FEET)

Speed Limit Range	Continuous Median Area	Intersection Channelization	Objects (Islands)
less than 50km/h (30MPH)	15.3m (50')	4.53m (15')	3.05m (10')
50-60km/h (30-40MPH)	22.9m (75')	6.1m (20')	4.53m (15')
70km/h (45MPH) & over	22.9m (75')	9.05m (30')	6.1m (20')

NOTES: If the spacing recommended in the table does not permit at least five pairs of arrows, the next lowest speed range should be used. The recommended spacing is measured parallel to the pavement center line.

ARROW LAYOUT

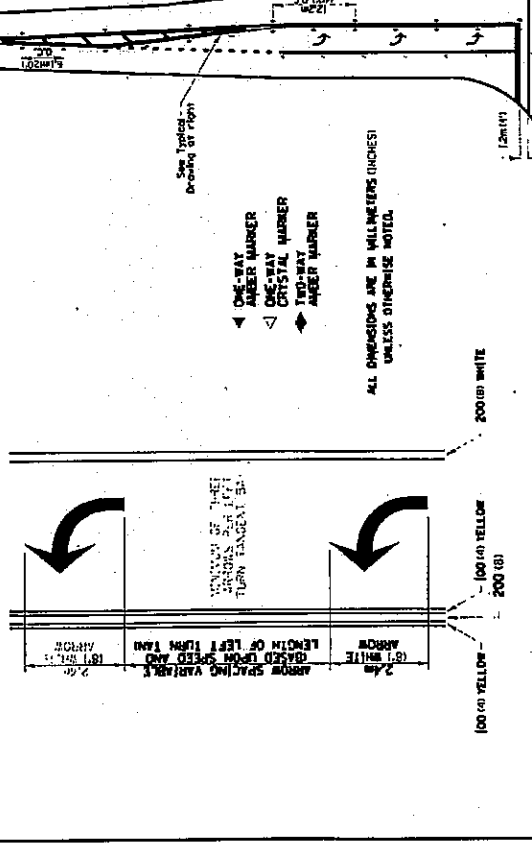

TYPICAL PAVEMENT MARKING FOR TWO LANE SECTION - NO PASSING ZONES

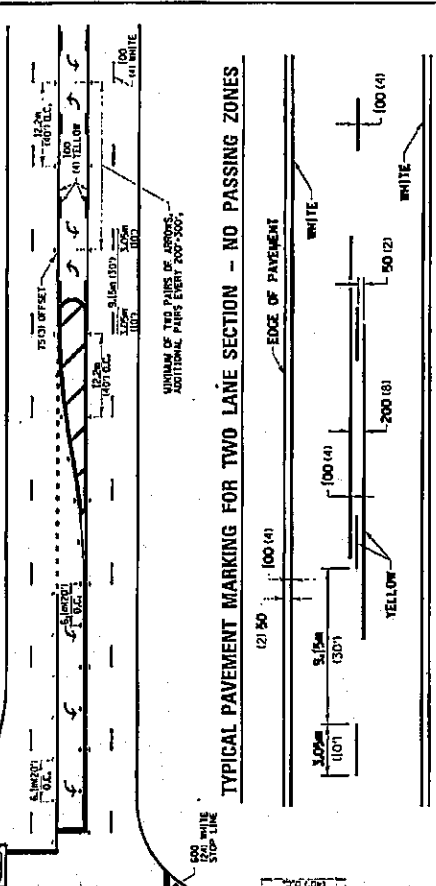

SYMBOLS

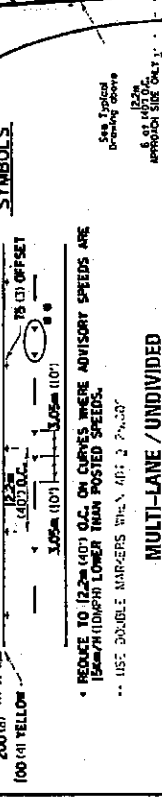

MULTI-LANE / UNDIVIDED

ILLINOIS DEPARTMENT OF LABOR

PREVAILING WAGES FOR ROCK ISLAND COUNTY EFFECTIVE FEBRUARY 2008

The Prevailing rates of wages are included in the Contract proposals which are subject to Check Sheet #5 of the Supplemental Specifications and Recurring Special Provisions. The rates have been ascertained and certified by the Illinois Department of Labor for the locality in which the work is to be performed and for each craft or type of work or mechanic needed to execute the work of the Contract. As required by Prevailing Wage Act (820 ILCS 130/0.01, et seq.) and Check Sheet #5 of the Contract, not less than the rates of wages ascertained by the Illinois Department of Labor and as revised during the performance of a Contract shall be paid to all laborers, workers and mechanics performing work under the Contract. Post the scale of wages in a prominent and easily accessible place at the site of work.

If the Illinois Department of Labor revises the prevailing rates of wages to be paid as listed in the specification of rates, the contractor shall post the revised rates of wages and shall pay not less than the revised rates of wages. Current wage rate information shall be obtained by visiting the Illinois Department of Labor web site at <http://www.state.il.us/agency/idol/> or by calling 312-793-2814. It is the responsibility of the contractor to review the rates applicable to the work of the contract at regular intervals in order to insure the timely payment of current rates. Provision of this information to the contractor by means of the Illinois Department of Labor web site satisfies the notification of revisions by the Department to the contractor pursuant to the Act, and the contractor agrees that no additional notice is required. The contractor shall notify each of its subcontractors of the revised rates of wages.

Rock Island County Prevailing Wage for February 2008

Trade Name	RG	TYP	C	Base	FRMAN	*M-F>8	OSA	OSH	H/W	Pensn	Vac	Trng
=====	==	==	=	=====	=====	=====	==	==	=====	=====	=====	=====
ASBESTOS ABT-GEN		BLD		22.410	22.910	1.5	1.5	2.0	5.300	4.400	0.000	0.600
ASBESTOS ABT-GEN		HWY		23.160	24.160	1.5	1.5	2.0	5.600	4.400	0.000	0.600
ASBESTOS ABT-MEC		BLD		18.750	19.750	1.5	1.5	2.0	4.750	2.000	0.000	0.000
BOILERMAKER		BLD		30.970	33.970	2.0	2.0	2.0	8.270	7.740	0.000	0.300
BRICK MASON		BLD		24.500	25.750	1.5	1.5	2.0	6.650	4.920	0.000	0.390
CARPENTER		BLD		25.750	27.040	1.5	1.5	2.0	5.700	5.360	0.000	0.400
CARPENTER		HWY		26.060	27.810	1.5	1.5	2.0	5.860	7.260	0.000	0.400
CEMENT MASON		BLD		23.440	24.940	1.5	1.5	2.0	5.300	5.700	0.000	0.400
CEMENT MASON		HWY		23.060	24.060	1.5	1.5	2.0	5.300	5.800	0.000	0.500
CERAMIC TILE FNSHER		BLD		17.330	0.000	1.5	1.5	2.0	6.650	4.250	0.000	0.210
ELECTRIC PWR EQMT OP		ALL		24.340	0.000	1.5	1.5	2.0	4.750	6.820	0.000	0.180
ELECTRIC PWR GRNDMAN		ALL		20.350	0.000	1.5	1.5	2.0	4.750	5.700	0.000	0.150
ELECTRIC PWR LINEMAN		ALL		30.690	33.150	1.5	1.5	2.0	4.750	8.590	0.000	0.230
ELECTRICIAN		BLD		29.520	31.520	1.5	1.5	2.0	5.500	7.810	0.000	0.310
ELECTRONIC SYS TECH		BLD		19.800	21.400	1.5	1.5	2.0	5.880	4.040	0.000	0.310
ELEVATOR CONSTRUCTOR		BLD		34.510	38.820	2.0	2.0	2.0	8.775	6.960	2.070	0.000
GLAZIER		BLD		23.670	25.090	1.5	1.5	2.0	5.300	4.150	0.000	0.250
HT/FROST INSULATOR		BLD		25.860	27.060	1.5	1.5	2.0	4.800	7.500	0.000	0.000
IRON WORKER		ALL		24.500	26.460	1.5	1.5	2.0	8.140	8.440	0.000	0.420
LABORER		BLD 1		20.910	21.410	1.5	1.5	2.0	5.300	4.400	0.000	0.600
LABORER		BLD 2		22.410	22.910	1.5	1.5	2.0	5.300	4.400	0.000	0.600
LABORER		BLD 3		23.060	23.560	1.5	1.5	2.0	5.300	4.400	0.000	0.600
LABORER		HWY 1		22.660	23.660	1.5	1.5	2.0	5.600	4.400	0.000	0.600
LABORER		HWY 2		23.160	24.160	1.5	1.5	2.0	5.600	4.400	0.000	0.600
LABORER		HWY 3		23.790	24.790	1.5	1.5	2.0	5.600	4.400	0.000	0.600
LATHER		BLD		25.750	27.040	1.5	1.5	2.0	5.700	5.360	0.000	0.400
MACHINIST		BLD		38.390	40.390	2.0	2.0	2.0	4.880	6.550	2.650	0.000
MARBLE FINISHERS		BLD		17.330	0.000	1.5	1.5	2.0	6.650	4.250	0.000	0.210
MARBLE MASON		BLD		21.670	22.170	1.5	1.5	2.0	6.650	4.250	0.000	0.210
MILLWRIGHT	N	BLD		33.650	37.020	1.5	1.5	2.0	6.100	11.10	0.000	0.560
MILLWRIGHT	S	BLD		26.500	28.200	1.5	1.5	2.0	5.550	8.670	0.000	0.560
OPERATING ENGINEER		BLD 1		26.150	0.000	1.5	1.5	2.0	6.850	5.800	1.500	0.550
OPERATING ENGINEER		BLD 2		23.500	0.000	1.5	1.5	2.0	6.850	5.800	1.500	0.550
OPERATING ENGINEER		BLD 3		22.450	0.000	1.5	1.5	2.0	6.850	5.800	1.500	0.550
OPERATING ENGINEER		HWY 1		26.150	27.150	1.5	1.5	2.0	6.850	5.800	1.500	0.550
OPERATING ENGINEER		HWY 2		24.550	27.150	1.5	1.5	2.0	6.850	5.800	1.500	0.550
OPERATING ENGINEER		HWY 3		23.400	27.150	1.5	1.5	2.0	6.850	5.800	1.500	0.550
PAINTER		ALL		24.270	25.270	1.5	1.5	1.5	4.700	4.850	0.000	0.600
PAINTER OVER 30FT		ALL		25.520	26.520	1.5	1.5	1.5	4.700	4.850	0.000	0.600
PAINTER PWR EQMT		ALL		24.770	25.770	1.5	1.5	1.5	4.700	4.850	0.000	0.600
PILEDRIVER		BLD		25.750	27.040	1.5	1.5	2.0	5.700	5.360	0.000	0.400
PILEDRIVER		HWY		26.060	27.810	1.5	1.5	2.0	5.860	7.260	0.000	0.400
PIPEFITTER		ALL		31.080	34.190	1.5	1.5	2.0	4.950	8.460	0.000	0.550
PLASTERER		BLD		26.000	27.560	1.5	1.5	2.0	4.000	5.000	0.000	0.250
PLUMBER		ALL		31.080	34.190	1.5	1.5	2.0	4.950	8.460	0.000	0.550
ROOFER		BLD		22.850	24.100	1.5	1.5	2.0	5.840	4.870	0.000	0.190
SHEETMETAL WORKER		BLD		27.660	29.420	1.5	1.5	2.0	6.540	7.900	0.000	0.380
SPRINKLER FITTER		BLD		31.240	33.240	1.5	1.5	2.0	6.500	5.350	0.000	0.250
STONE MASON		BLD		24.500	25.750	1.5	1.5	2.0	6.650	4.920	0.000	0.390
TERRAZZO FINISHER		BLD		17.330	0.000	1.5	1.5	2.0	6.650	4.250	0.000	0.210
TERRAZZO MASON		BLD		21.670	22.170	1.5	1.5	2.0	6.650	4.250	0.000	0.210
TILE LAYER		BLD		25.750	27.040	1.5	1.5	2.0	5.700	5.360	0.000	0.400
TILE MASON		BLD		21.670	22.170	1.5	1.5	2.0	6.650	4.250	0.000	0.210
TRUCK DRIVER		ALL 1		26.792	0.000	1.5	1.5	2.0	7.900	3.662	0.000	0.000
TRUCK DRIVER		ALL 2		27.192	0.000	1.5	1.5	2.0	7.900	3.662	0.000	0.000
TRUCK DRIVER		ALL 3		27.392	0.000	1.5	1.5	2.0	7.900	3.662	0.000	0.000
TRUCK DRIVER		ALL 4		27.642	0.000	1.5	1.5	2.0	7.900	3.662	0.000	0.000
TRUCK DRIVER		ALL 5		28.392	0.000	1.5	1.5	2.0	7.900	3.662	0.000	0.000

TRUCK DRIVER	O&C 1	21.430	0.000	1.5	1.5	2.0	7.900	3.662	0.000	0.000
TRUCK DRIVER	O&C 2	21.750	0.000	1.5	1.5	2.0	7.900	3.662	0.000	0.000
TRUCK DRIVER	O&C 3	21.910	0.000	1.5	1.5	2.0	7.900	3.662	0.000	0.000
TRUCK DRIVER	O&C 4	22.110	0.000	1.5	1.5	2.0	7.900	3.662	0.000	0.000
TRUCK DRIVER	O&C 5	22.710	0.000	1.5	1.5	2.0	7.900	3.662	0.000	0.000
TUCKPOINTER	BLD	24.500	25.750	1.5	1.5	2.0	6.650	4.920	0.000	0.390

Legend:

M-F>8 (Overtime is required for any hour greater than 8 worked each day, Monday through Friday.)

OSA (Overtime is required for every hour worked on Saturday)

OSH (Overtime is required for every hour worked on Sunday and Holidays)

H/W (Health & Welfare Insurance)

Pensn (Pension)

Vac (Vacation)

Trng (Training)

Explanations

ROCK ISLAND COUNTY

MILLWRIGHT (SOUTH) - South of Interstate 80.

The following list is considered as those days for which holiday rates of wages for work performed apply: New Years Day, Memorial/Decoration Day, Fourth of July, Labor Day, Veterans Day, Thanksgiving Day, Christmas Day. Generally, any of these holidays which fall on a Sunday is celebrated on the following Monday. This then makes work performed on that Monday payable at the appropriate overtime rate for holiday pay. Common practice in a given local may alter certain days of celebration such as the day after Thanksgiving for Veterans Day. If in doubt, please check with IDOL.

Oil and chip resealing (O&C) means the application of road oils and liquid asphalt to coat an existing road surface, followed by application of aggregate chips or gravel to coated surface, and subsequent rolling of material to seal the surface.

EXPLANATION OF CLASSES

ASBESTOS - GENERAL - removal of asbestos material/mold and hazardous materials from any place in a building, including mechanical systems where those mechanical systems are to be removed. This includes the removal of asbestos materials/mold and hazardous materials from ductwork or pipes in a building when the building is to be demolished at the time or at some close future date.

ASBESTOS - MECHANICAL - removal of asbestos material from mechanical systems, such as pipes, ducts, and boilers, where the mechanical systems are to remain.

CERAMIC TILE FINISHER, MARBLE FINISHER, TERRAZZO FINISHER

Assisting, helping or supporting the tile, marble and terrazzo mechanic by performing their historic and traditional work assignments required to complete the proper installation of the work covered by said crafts. The term "Ceramic" is used for naming the classification only and is in no way a limitation of the product handled. Ceramic takes into consideration most hard tiles.

ELECTRONIC SYSTEMS TECHNICIAN

Installing, assembling and maintaining sound and intercom, protection alarm (security), master antenna television, closed circuit television, computer hardware and software programming and installation to the network's outlet and input (EXCLUDING all cabling, power and cable termination work historically performed by wiremen), door monitoring and control, nurse and emergency call programming and installation to the system's outlet and input (EXCLUDING all cabling, power and cable termination work historically performed by wiremen), clock and timing; and the installation and maintenance of transmit and receive antennas, transmitters, receivers, and associated apparatus which operates in conjunction with the above systems. All work associated with these system installations will be included EXCEPT (1) installation of protective metallic conduit, excluding less than ten-foot runs strictly for protection of cable, and (2) 120 volt AC (or higher) power wiring and associated hardware.

TRUCK DRIVER - BUILDING, HEAVY AND HIGHWAY CONSTRUCTION

Class 1. Drivers on 2 axle trucks hauling less than 9 ton. Air compressor and welding machines and brooms, including those pulled by separate units, truck driver helpers, warehouse employees, mechanic helpers, greasers and tiremen, pickup trucks when hauling materials, tools, or workers to and from and on-the-job site, and fork lifts up to 6,000 lb. capacity.

Class 2. Two or three axle trucks hauling more than 9 ton but hauling less than 16 ton. A-frame winch trucks, hydrolift trucks, vector trucks or similar equipment when used for transportation purposes. Fork lifts over 6,000 lb. capacity, winch trucks, four axle combination units, and ticket writers.

Class 3. Two, three or four axle trucks hauling 16 ton or more. Drivers on water pulls, articulated dump trucks, mechanics and working forepersons, and dispatchers. Five axle or more combination units.

Class 4. Low Boy and Oil Distributors.

Class 5. Drivers who require special protective clothing while employed on hazardous waste work.

TRUCK DRIVER - OIL AND CHIP RESEALING ONLY.

This shall encompass laborers, workers and mechanics who drive contractor or subcontractor owned, leased, or hired pickup, dump, service, or oil distributor trucks. The work includes transporting materials and equipment (including but not limited to, oils, aggregate supplies, parts, machinery and tools) to or from the job site; distributing oil or liquid asphalt and aggregate; stock piling material when in connection with the actual oil and chip contract. The Truck Driver (Oil & Chip Resealing) wage classification does not include supplier delivered materials.

OPERATING ENGINEERS - BUILDING, HEAVY AND HIGHWAY CONSTRUCTION

Class 1. An engineer on Crane, Shovel, Clamshell, Dragline, Backhoe,

Derrick, Tower Crane, Cable Way, Concrete Spreader (servicing two pavers), Asphalt Spreader, Asphalt Mixer, Plant Engineer, Dipper Dredge Operator, Dipper Dredge Craneman, Dual Purpose Truck (boom or winch), Leverman or Engineman (hydraulic dredge), Mechanic, Paving Mixer with tower attached, Pile Driver, Boom Tractor, Stationary, Portable or Floating Mixing Plant, Trenching Machine (over 40 H.P.), Building Hoist (two drums), Hot Paint Wrapping Machine, Cleaning and Priming Machine, Backfiller (throw bucket), Locomotive Engineer, Qualified Welder, Tow or Push Boat, Concrete Paver, Seaman Trav-L-Plant or similar machines, CMI Autograder or similar machines, Slip Form Paver, Caisson Augering Machine, Mucking Machine, Asphalt Heater-Planer Unit, Hydraulic Cranes, Mine Hoists. An engineer on Athey, Barber-Green, Euclid or Haiss Loader, Asphalt Pug Mill, Fireman and Drier, Concrete Pump, Concrete Spreader (servicing one paver) Bulldozer, Endloader, Log Chippers or similar machines, Elevating Grader, Group Equipment Greaser, LeTourneaupul and similar machines, off-road haul units, DW-10 Hyster Winch and similar machines, Motor Patrol, Power Blade, Push Cat, Tractor Pulling elevating Grader or Power Blade, Tractor Operating Scoop or Scraper, Tractor with Power Attachment, Roller on Asphalt or Blacktop, Single Drum Hoist, Jaeger Mix and Place Machine, Pipe Bending Machine, Flexaplane or similar machines, Automatic Curbing Machines, Automatic Cement and Gravel Batch Plants (one stop set-up), Seaman Pulvi-Mixer or similar machines, Blastholer Self-propelled Rotary Drill or similar machines, Work Boat, Combination Concrete Finishing Machine and Float, Self-propelled Sheep Foot Roller or Compactor (used in conjunction with a Grading Spread), Asphalt Spreader Screed Operator, Apsco spreader or similar machine, Slusher, Forklift (over 6000 lb. cap. or working at heights above 28 ft.) Concrete Conveyors, Chip Spreader, Underground Boring Machine (BUILDING ONLY), Straddle Carrier, Hydro-Hammer (BUILDING ONLY), Hydraulic Pumps or Power Units Driven by any power source (except manually), used to hoist or lift machinery or material.

Class 2. An engineer on Asphalt Booster, Fireman and Pump Operator at Asphalt Plant, Mud Jack, Underground Boring Machine (HIGHWAY ONLY), Concrete Finishing Machine, Form Grader with Roller on Earth, Mixers (3 bag to 16E), Power Operated Bull Float, Tractor without Power attachment, Dope Pot (agitating motor), Dope Chop Machine, Distributor (back end), Straddle Carrier, Portable Machine Fireman, Hydro-Hammer (HIGHWAY ONLY), Power Winch on Paving Work, Self-propelled Roller or Compactor (other than provided for above), Pump Operator (more than one well-point pump), Portable Crusher Operator, Trench Machine (under 40 H.P.), Power Subgrader (on forms) or similar machines, Forklift (6000 or less cap.) Gypsum Pump, Conveyor over 20 H.P., Fuller Kenyon Cement Pump or similar machines. An engineer on Air Compressor (400 c.f.m. or over HIGHWAY ONLY), Light Plant, Mixers (1 or 2 bag), Power Batching Machine (Cement Auger or Conveyor), Boiler (Engineer or Fireman), Water Pumps (HIGHWAY ONLY), Mechanical Broom, Automatic Cement and Gravel Batch Plants (two or three stop set-up), Small Rubber-tired Tractors (not including backhoes or endloaders), Self-propelled Curing Machine, Brush Chipper, Driver on Truck Crane or similar machines.

Class 3. Oiler, Mechanic's Helper, Mechanical Heater (other than steam boiler), Belt Machine, Small Outboard Motor Boats (Safety Boat and Life Boat), Engine Driven Welding Machine, and Small Tractors (used to unroll or roll wire mesh), Water pumps (BUILDING ONLY), Air Compressors (BUILDING ONLY), Permanent Automatic Elevators.

LABORER - BUILDING

Class 1: General laborer, carpenter tender, tool cribman, salamander

tender, flagman, form handler, floor sweeper, material handler, fencing laborer, cleaning lumber, landscaper, unloading explosives, laying of sod, planting/removal of trees, wrecking laborer, unloading of Re-Bars, scaffold worker, signal man on crane.

Class 2: Handling of materials treated with creosote, kettle men, prime mover or motorized unit used for wet concrete or handling of building materials, vibrator operator, mortar mixer, power tools used under the jurisdiction of laborers, sand points, gunnite nozzle men, welders, cutters, burners and torchmen, chain saw operator, jackhammer and drill operators, paving breakers, air tamping hammerman, concrete saw operator, concrete burning machine operator, coring machine operator - hod carrier and plasterer tender.

Class 3: Caisson worker after 6 foot depth, dynamite man, asbestos abatement worker, tunnel miners - mixerman (plaster only), pump man.

LABORER - HEAVY & HIGHWAY

Class 1: Rod or chain man, flagman, dumpman, spotter, broom man, landscaper, planting and removal of trees, fencing laborers, dispatcher, ticket writer, scaleman, cleaning of forms or lumber (in bone yard), laying of sod, moving and/or maintenance of flares and barricades.

Class 2: Operation of all hand, electric, air, hydraulic or mechanically powered tools under the jurisdiction of Laborers' including jackhammers, tempers, air spades, augers, concrete saws, chain saws, utility saws, rock drills, vibrators, mortar mixer, power and hand saw (when clearing timber) general laborer (not elsewhere covered), craft-tender, material checker, material handler, form handler, concrete dumper, puddler, form setter helper, explosives handler, dynamite helper, center strip, reinforcing in concrete, wire mesh handler and installer, prime mover or any mechanical device taking the place of concrete buggy or wheelbarrow, sandpoint setter, asphalt kettleman. Sheeting hammer drivers, laying and jointing of telephone conduit, gas distribution men, pipe setter on laterals, drain tiles, culvert pipe, and storm sewer catch basin leads, catch basins, manholes, batch dumpers, tank cleaners, cofferdam workers, bankman on floating plant, jointman with pipelayers. Back-up man (corker, joint maker) with pipe setter on sewer and water mains, batterboard man or laser operator on sewer and water main, labor in ditch, or tunnel, on sewer or water mains and telephone conduit. Cutters, burners, torchman, gravel box man, asphalt plant laborers, concrete plant laborer, deck hand, unloading of steel and rebar, laser beam operator, wrecking laborers.

Class 3: Asphalt raker or luteman, head form setter, head dynamite man (powderman) head string or wireline man (on paving), pipe setter on sewer or water main, gunnite nozzle man, asphalt or concrete curb machine operator, head grade man, head tunnel miner, concrete burning machine operator, coring machine operator, welder.

Other Classifications of Work:

For definitions of classifications not otherwise set out, the Department generally has on file such definitions which are available. If a task to be performed is not subject to one of the classifications of pay set out, the Department will upon being contacted state which neighboring county has such a classification and provide such rate, such rate being deemed to exist by reference in this document. If no neighboring county rate applies to the task, the Department shall undertake a special determination, such special determination being then deemed to have existed under this

determination. If a project requires these, or any classification not listed, please contact IDOL at 618/993-7271 for wage rates or clarifications.

LANDSCAPING

Landscaping work falls under the existing classifications for laborer, operating engineer and truck driver. The work performed by landscape plantsman and landscape laborer is covered by the existing classification of laborer. The work performed by landscape operators (regardless of equipment used or its size) is covered by the classifications of operating engineer. The work performed by landscape truck drivers (regardless of size of truck driven) is covered by the classifications of truck driver.