

STATE OF ILLINOIS
DEPARTMENT OF TRANSPORTATION

ROUTE NO.	SECTION	COUNTY	DISTRICT	SHEET	SHEET NO.
F.A.P. 17	6000 M-1	CARROLL	20	18	15 SHEETS
FED. ROAD DIST. NO. 1	ILLINOIS	FED. AID PROJECT			

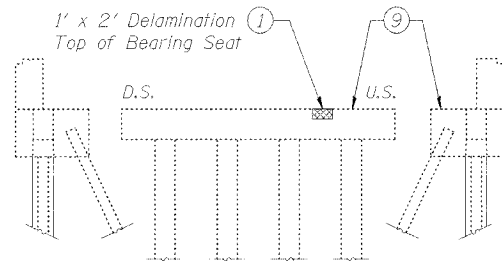

SOUTH ELEVATION EAST ELEVATION NORTH ELEVATION
PILE BENT 1

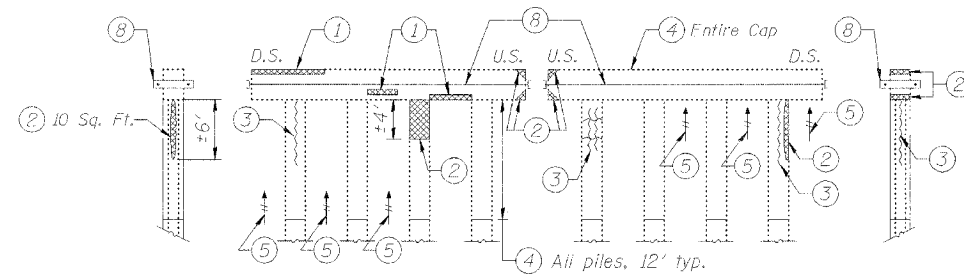

SOUTH ELEVATION EAST ELEVATION WEST ELEVATION NORTH ELEVATION
PILE BENT 4

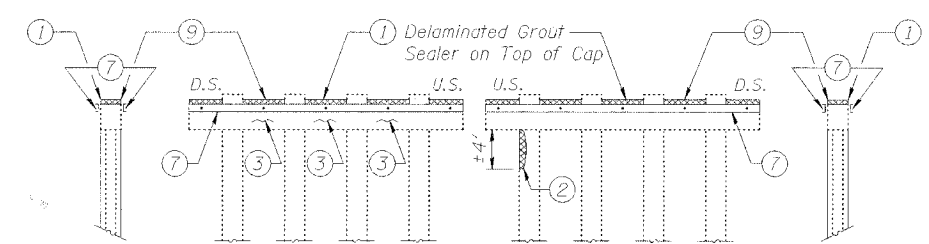

SOUTH ELEVATION EAST ELEVATION WEST ELEVATION NORTH ELEVATION
PILE BENT 7

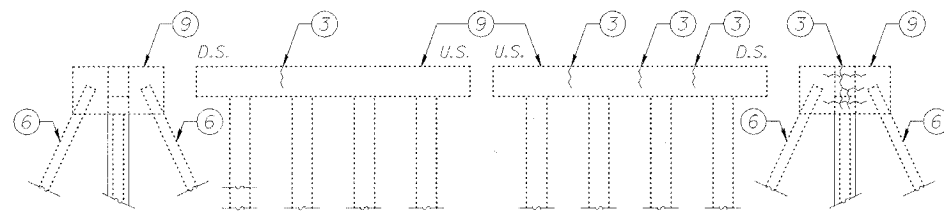

SOUTH ELEVATION EAST ELEVATION WEST ELEVATION NORTH ELEVATION
PILE BENT 2

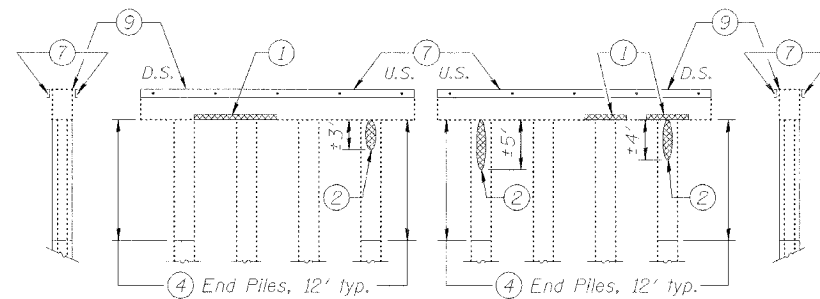

SOUTH ELEVATION EAST ELEVATION WEST ELEVATION NORTH ELEVATION
PILE BENT 5

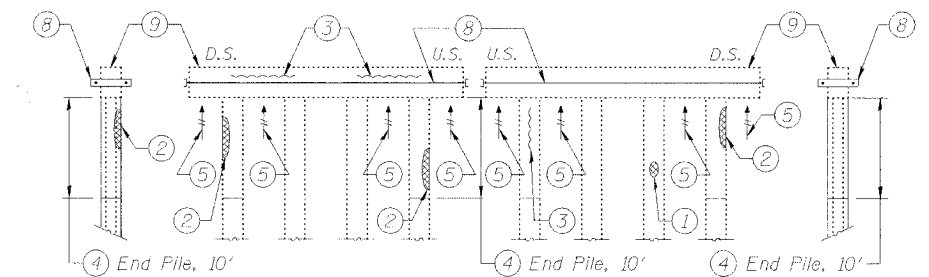

SOUTH ELEVATION EAST ELEVATION WEST ELEVATION NORTH ELEVATION
PILE BENT 8

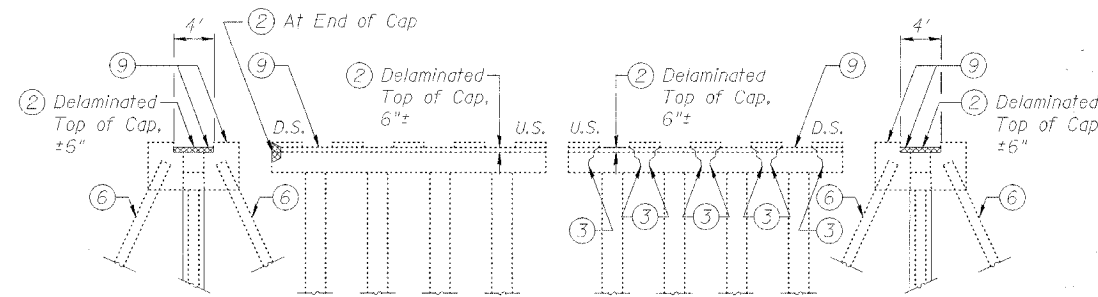

SOUTH ELEVATION EAST ELEVATION WEST ELEVATION NORTH ELEVATION
PILE BENT 6

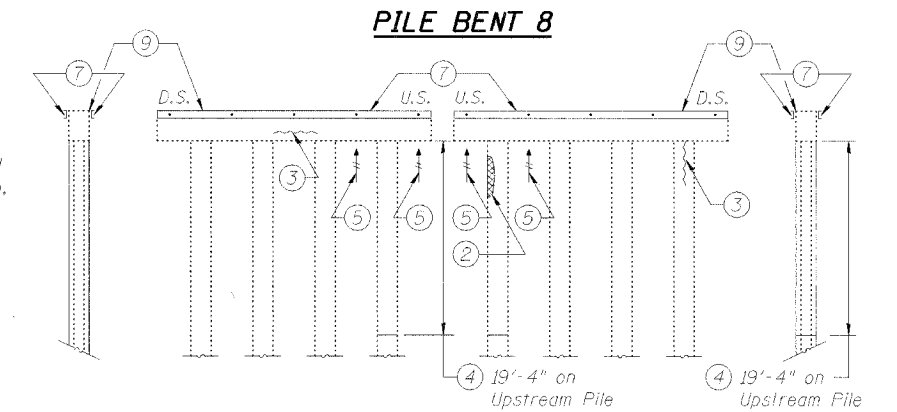

SOUTH ELEVATION EAST ELEVATION WEST ELEVATION NORTH ELEVATION
PILE BENT 12

DESIGNED	PJL
CHECKED	LLV
DRAWN	MGM
CHECKED	PJL

- Note:
- No Concrete Repairs proposed for PB9, PB10, or PB11, except Concrete Sealer (9)
 - No Concrete Repairs proposed for PB3.
 - See Sht. 12 of 15 for corresponding Repair Schedule.

SUBSTRUCTURE CONCRETE REPAIRS
F.A.P. RTE. 17 (US 52/IL 64)
OVER MISSISSIPPI RIVER
SECTION 6000 M-1
CARROLL COUNTY (IL)
JACKSON COUNTY (IA)
STRUCTURE NO. 008-6000

STS CONSULTANTS
111 NE Jefferson Ave.
Peoria, Illinois 61602
Ph(309)676-9464
FAX(309)676-5445
IL Design Firm Reg. No. 184-001518