

F.A.P. RTE.	SECTION	COUNTY	TOTAL SHEETS	SHEET NO.
71	151	DEWITT	20	11

### GENERAL NOTES

1. DITCH CHECKS SHALL BE PAID FOR AT THE CONTRACT UNIT PRICE PER EACH FOR "STONE OR RIPRAP DITCH CHECKS", WHICH PRICE SHALL INCLUDE THE FURNISHING AND PLACING OF ALL MATERIALS FOR A COMPLETE INSTALLATION.
2. INDIVIDUAL STONES OR BROKEN CONCRETE SHALL NOT BE LESS THAN 6" (150 mm) IN THEIR SMALLEST DIMENSION.

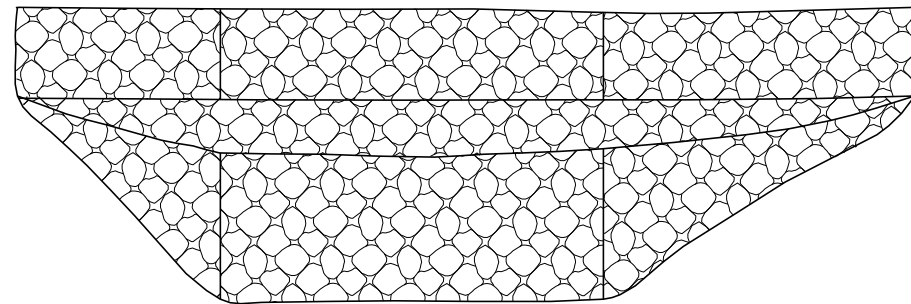

PLAN

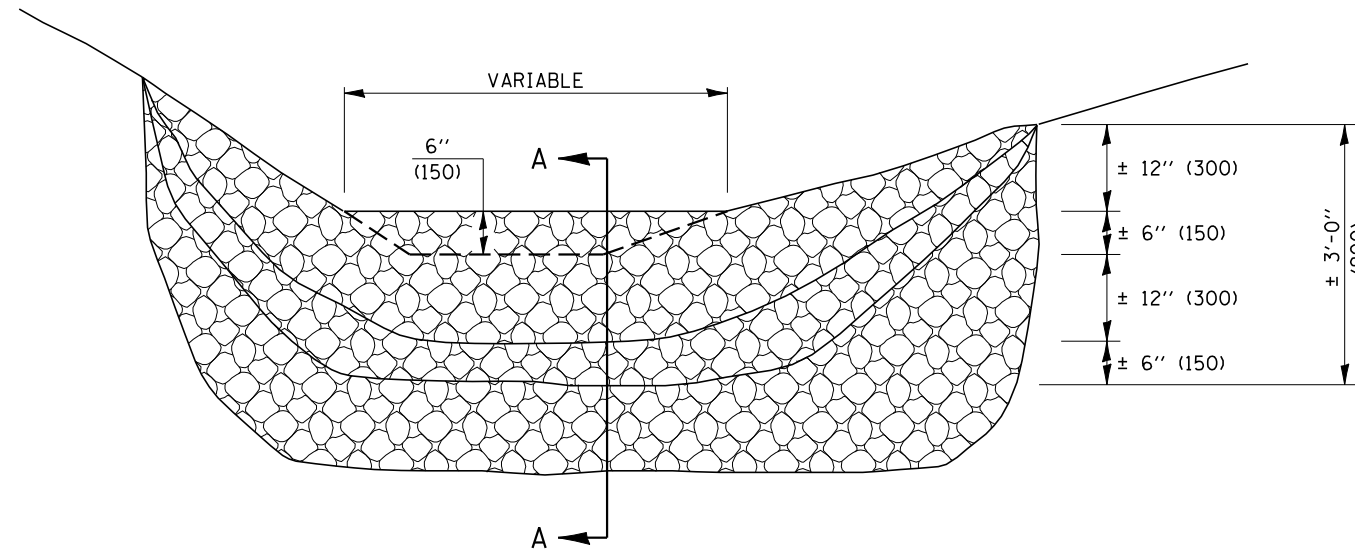

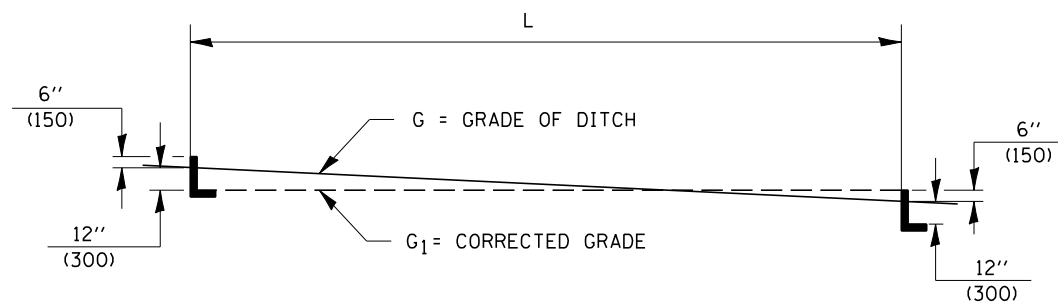

DOWNSTEAM ELEVATION

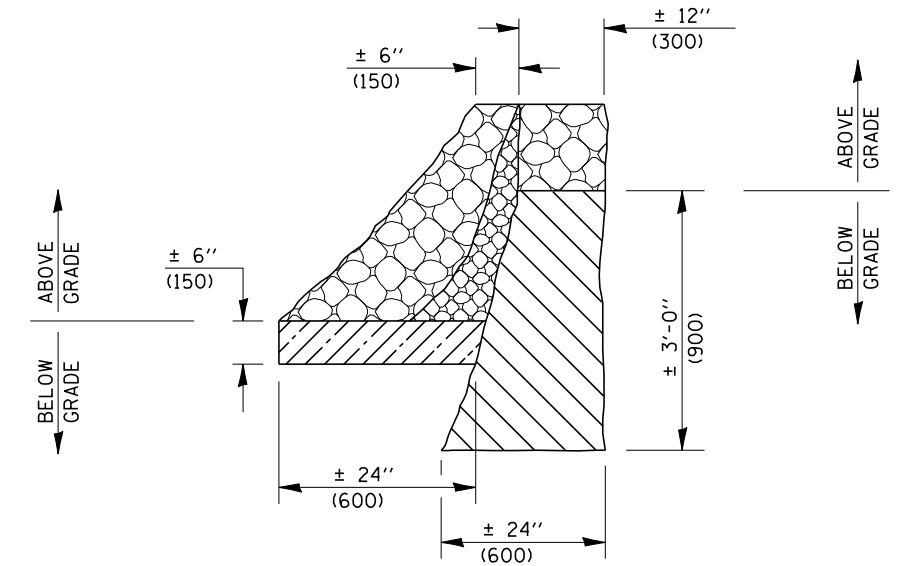

METHOD OF PLACING DITCH CHECKS

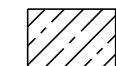

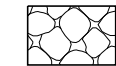
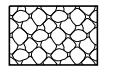
-  RIPRAP CUT IN PLANE OF VIEW
-  RIPRAP CUT IN PLANE OF VIEW
-  RIPRAP ABOVE GROUND BEYOND CUT PLANE
-  RIPRAP ABOVE GROUND BEYOND CUT PLANE

SECTION A-A

Note: All dimensions are in INCHES (millimeters) unless otherwise shown.

DATE	REVISIONS	NAME	ILLINOIS DEPARTMENT OF TRANSPORTATION
11/06	REPLACED DETAIL A-12.15	TJB	<p style="text-align: center;"><b>STONE RIPRAP DITCH CHECKS</b></p> <p style="text-align: center;"><b>DISTRICT 5 DETAIL NO. 28102630</b></p>

PLOT DATE = 12/17/2007  
 FILE NAME = c:\projects\4595587 (v8)\70675detail.dgn  
 PLOT SCALE = 42,352% / IN.  
 USER NAME = collierb