

F.A. RTE.	SECTION	COUNTY	TOTAL SHEETS	SHEET NO.
	03-00026-00-PK 06-00026-01-MS	MADISON	51	3

97331

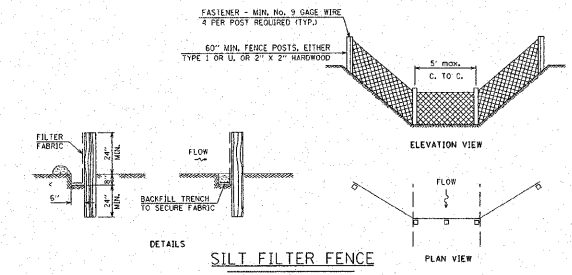

- ALL SILT FENCES SHALL BE PLACED AS CLOSE TO THE CONTOUR AS POSSIBLE, WITH THE ENDS EXTENDING UPSLOPE. THE AREA BELOW THE FENCE MUST BE UNDISTURBED OR STABILIZED.
- WOOD POSTS WILL BE OF SOUND QUALITY WOOD WITH A MIN. CROSS SECTIONAL AREA OF 3.0 SQ. IN. STEEL POSTS WILL BE STANDARD T AND U SECTIONS WEIGHING NOT LESS THAN 1.0 LBS./L.F. THE MAX. SPACING WILL BE 5 FEET. WHEN WIRE BACKING IS USED, THE MAX. SPACING MAY BE INCREASED TO 10 FEET. THE POSTS SHALL BE DRIVEN A MIN. OF 24" INTO THE GROUND. SPACING MAY NEED TO BE ADJUSTED SO THAT POSTS ARE LOCATED IN LOW AREAS WHERE WATER MAY POND.
- WIRE FENCE SHALL BE A MIN. 9 GAUGE TOP AND BOTTOM WIRES WITH A MAX. 6" MESH OPENING, OR AS APPROVED BY THE ENGINEER.
- THE FILTER FABRIC SHOULD BE FURNISHED IN A CONTINUOUS ROLL CUT TO THE LENGTH OF THE SILT FENCE NEEDED TO AVOID SPLICES. WHEN SPLICES ARE NECESSARY, THE FABRIC SHOULD BE SPLICED AT A SUPPORT POST WITH A MIN. 6" OVERLAP, FOLDED OVER AND SECURELY FASTENED.
- THE SILT FENCE SHALL BE ENTRENCHED TO A MIN. DEPTH OF 8", WITH AN ADDITIONAL 6" EXTENDING ALONG THE BOTTOM OF THE TRENCH IN THE UPSLOPE DIRECTION. THE TRENCH SHALL BE BACKFILLED AND THE SOIL COMPACTED OVER THE FABRIC.
- THE FILTER FABRIC AND WIRE SUPPORT, IF USED, MUST BE SECURELY FASTENED TO THE UPSLOPE SIDE OF THE POSTS USING HEAVY DUTY WIRE STAPLES AT LEAST ONE INCH LONG. TIE WIRES OR HOOD RINGS. THE FABRIC SHALL NOT BE STAPLED OR WIRED TO THE WIRE SUPPORT. THE FABRIC SHALL NOT BE STAPLED TO EXISTING TREES.
- INTERMEDIATE WIRE OF MESH SUPPORTS SHALL BE A MIN. OF GAGE NO. 11.
- OPERATION AND MAINTENANCE OF SILT FENCE
 - SILT FENCES SHALL BE REMOVED WHEN THEY HAVE SERVED THEIR USEFULNESS, BUT NOT BEFORE THE UPSLOPE AREAS HAVE BEEN PERMANENTLY STABILIZED.
 - SILT FENCES SHALL BE INSPECTED IMMEDIATELY AFTER EACH RAINFALL AND AT LEAST DAILY DURING PROLONGED RAINFALL.
 - SHOULD THE FABRIC DECOMPOSE OR BECOME INEFFECTIVE PRIOR TO THE END OF THE EXPECTED USABLE LIFE AND THE FENCE STILL IS NECESSARY, THE FABRIC OR THE ENTIRE SYSTEM SHALL BE REPLACED PROMPTLY.
 - SEDIMENT DEPOSITS SHOULD BE REMOVED AFTER EACH RAINFALL. THEY MUST BE REMOVED WHEN THE LEVEL OF DEPOSITION REACHES APPROXIMATELY ONE-HALF THE HEIGHT OF THE BARRIER.
 - ANY SEDIMENT DEPOSITS REMAINING IN PLACE AFTER THE SILT FENCE IS NO LONGER REQUIRED SHALL BE DRESSED TO CONFORM TO THE EXISTING GRADE, A SEEDBED PREPARED AND THE SITE VEGETATED.

THE FOLLOWING EROSION CONTROL MEASURES SHALL BE PROVIDED BY THE CONTRACTOR:

- PERIMETER EROSION BARRIER (SILT FENCE) SHALL BE ERECTED PRIOR TO EXCAVATION AND CLEARING IN THE UPSLOPE AREA.
- THE TEMPORARY EROSION CONTROL SYSTEMS SHALL BE PROPERLY MAINTAINED BY THE CONTRACTOR TO CONTROL SILTATION AT ALL TIMES DURING THE LIFE OF THE CONTRACT.
- AT ALL TIMES, EROSION CONTROL MEASURES SHALL BE EMPLOYED TO PREVENT SILT FROM LEAVING THE SITE. ALL EROSION CONTROL WORK IS TO BE DONE ACCORDING TO THE CURRENT EDITION OF THE STANDARD SPECIFICATIONS AND THE STORM WATER POLLUTION PREVENTION PLAN.
- PRIOR TO THE START OF ANY EARTH MOVING OPERATIONS, THE CONTRACTOR SHALL INSURE THAT A STORM WATER POLLUTION PREVENTION PLAN (SWPPP) AND A NOTICE OF INTENT (NOI) HAVE BEEN PREPARED, SIGNED AND FILED BY THE OWNER ACCORDING TO THE REQUIREMENTS OF THE NATIONAL POLLUTION DISCHARGE ELIMINATION SYSTEM (NPDES) PERMIT IL R 10 WHICH AUTHORIZES THE STORM WATER DISCHARGES ASSOCIATED WITH INDUSTRIAL ACTIVITY FROM THIS CONSTRUCTION SITE.
- ADDITIONAL EROSION PROTECTION DEVICES SHALL BE INSTALLED SHOULD OTHER AREAS OF EROSION IN THE DEVELOPMENT OCCUR, AS DIRECTED BY THE CONSTRUCTION MANAGER.
- SEEDING SHALL BE APPLIED WITHIN 7 DAYS OF FINAL GRADING IN ALL DISTURBED AREAS.
- ALL EROSION CONTROL ITEMS SHALL BE REMOVED AND BECOME THE PROPERTY OF THE CONTRACTOR AT THE COMPLETION OF THE CONTRACT, OR AS DIRECTED BY THE RESIDENT ENGINEER.

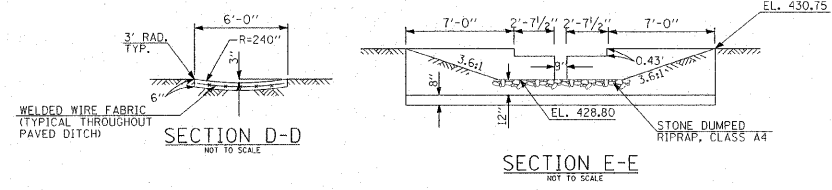
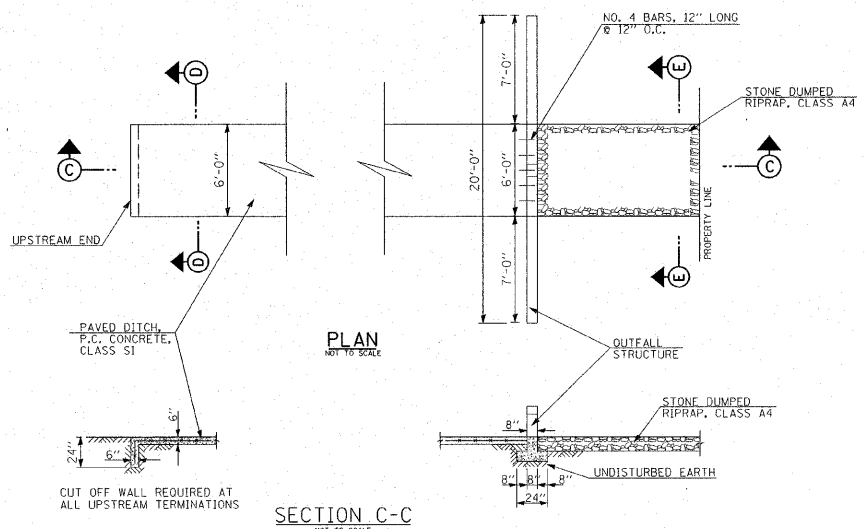

PAVED DITCH & OUTFALL STRUCTURE
NOT TO SCALE
STA. 10+08.50 TO STA. 11+53

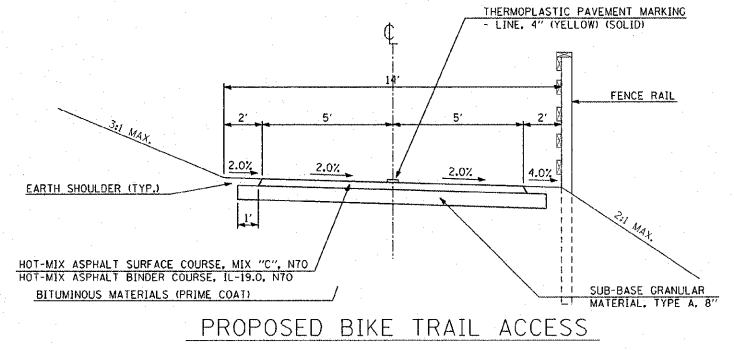

PROPOSED BIKE TRAIL ACCESS
NOT TO SCALE

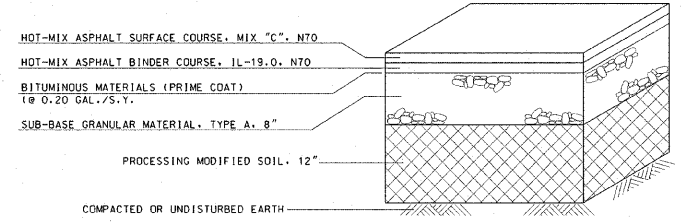

TYPICAL PARKING LOT SECTION
NOT TO SCALE

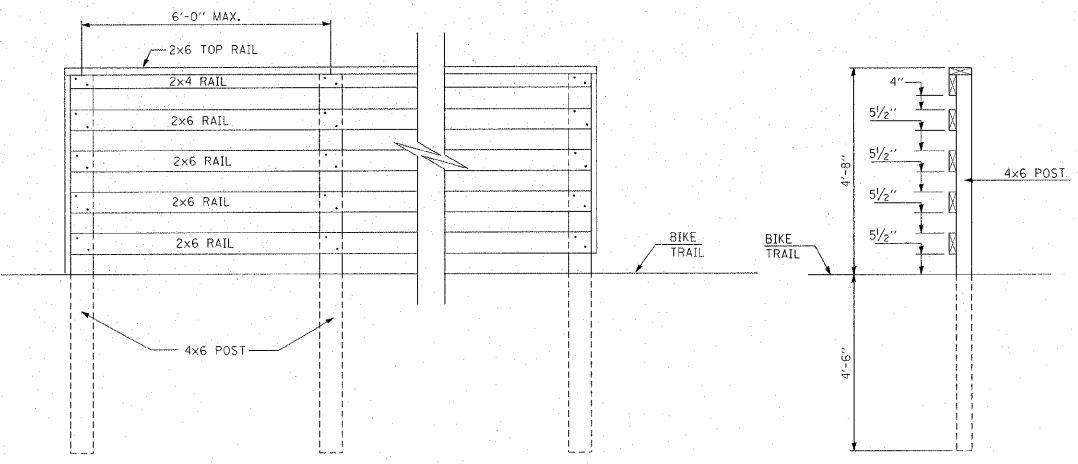

INSIDE RAIL ELEVATION
SECTION A-A
FENCE RAIL DETAILS
STA. 1+11.40 TO STA. 3+67.13

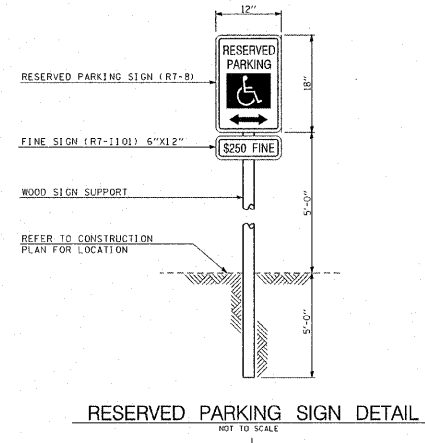

RESERVED PARKING SIGN DETAIL
NOT TO SCALE

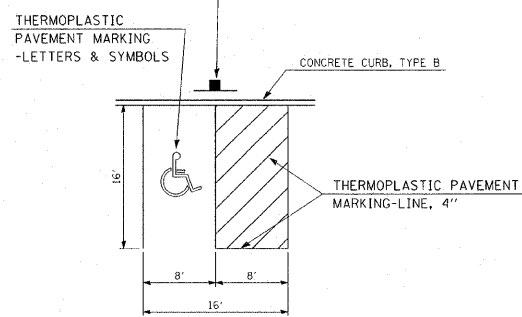

THERMOPLASTIC PAVEMENT MARKING
NOT TO SCALE

THE FOLLOWING MIXTURE REQUIREMENTS ARE APPLICABLE FOR THIS PROJECT:

MIXTURE USE	SURFACE	BINDER
AC/PG	PG 64-22	PG 64-22
RAP % (MAX)	10	15
DESIGN AIR VOIDS	4.0% @ NDES=70	4.0% @ NDES=70
MIX COMPOSITION (GRADATION MIXTURE)	IL 19.0	IL 19.0
FRICTION AGG	MIXTURE C	MIXTURE B

STREET AND PAVEMENT CONSTRUCTION NOTES:

- ALL STREET WORK IS TO BE DONE ACCORDING TO THE ILLINOIS DEPARTMENT OF TRANSPORTATION STANDARD SPECIFICATIONS FOR ROAD AND BRIDGE CONSTRUCTION, ADOPTED JANUARY 1, 2007 AND LATEST REVISIONS.
- ALL CONCRETE PAVEMENT AND DRIVEWAYS SHALL BE POURED SO THAT NO FINISHED PANEL EXCEEDS 15' ALONG ANY EDGE, UNLESS SHOWN OTHERWISE.
- ALL CONSTRUCTION JOINTS SHALL BE TIED USING #6 BARS, 30" LONG AT 24" O.C..
- SAWED TRANSVERSE JOINTS (1/8" X 2") SHALL BE CREATED AT 15' INTERVALS. BARS ARE NOT REQUIRED. JOINTS TO BE SEALED WITH HOT POURED JOINT SEALER IN ALL CONCRETE CONSTRUCTION.
- EMBANKMENT SHALL BE PLACED AS REQUIRED IN SECTION 205 OF THE ILLINOIS DEPARTMENT OF TRANSPORTATION STANDARD SPECIFICATIONS FOR ROAD AND BRIDGE CONSTRUCTION, ADOPTED JANUARY 1, 2007 AND LATEST REVISIONS. CONTRACTOR SHALL SUBMIT TO THE RESIDENT ENGINEER DOCUMENTATION OF COMPACTION TESTS FOR WRITTEN APPROVAL OF SAID COMPACTION PRIOR TO CONSTRUCTION OF ANY PAVEMENT/SIDEWALK.
- CUT SECTIONS SHALL BE PROOF ROLLED AND APPROVED BY THE RESIDENT ENGINEER PRIOR TO CONSTRUCTION OF ANY PAVEMENT/SIDEWALK.

211 North Broadway
Suite 1900
St. Louis, Missouri 63102
PH: (314) 241-9388
FAX: (314) 241-0125



LEWIS AND CLARK
MEMORIAL TOWER
HARTFORD, ILLINOIS 62048

SHEET TITLE:
DETAILS

DATE	
REMARKS	
REV. NO.	

KENNEDY PROJECT NO
10-02048

ISSUE DATE

SHEET NO.

C-02