

F.A.P. RTE. 545	SECTION 114T-1	COUNTY	TOTAL SHEET SHEETS NO. 118 72
STA.	TO STA.	FED. ROAD DIST. NO. ILLINOIS FED. AID PROJECT	
CARROLL & OGLE			

CORRUGATED STEEL PIPE MULTIPLE END SECTIONS

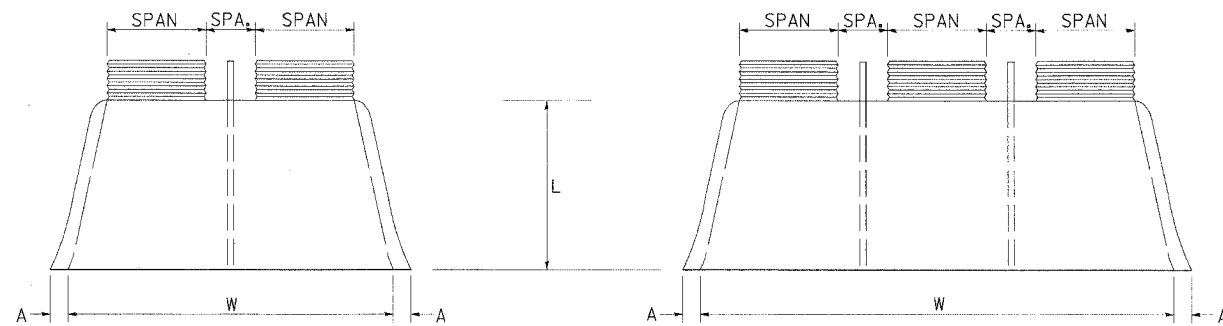

PLAN

PLAN

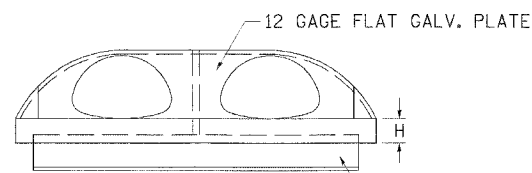

ELEVATION

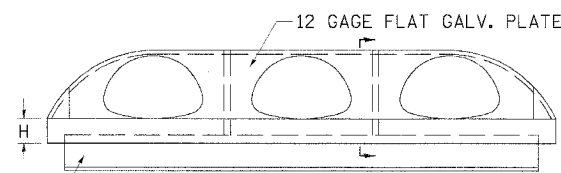

ELEVATION

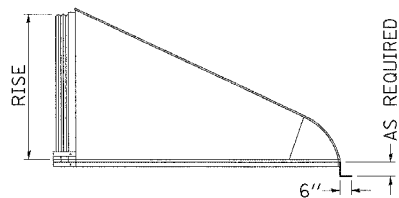

SIDE VIEW

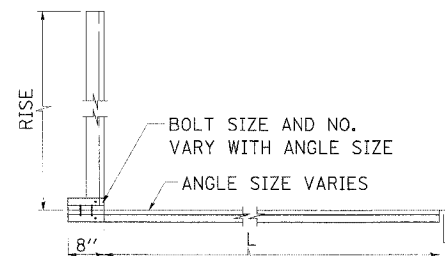

SECTION VIEW

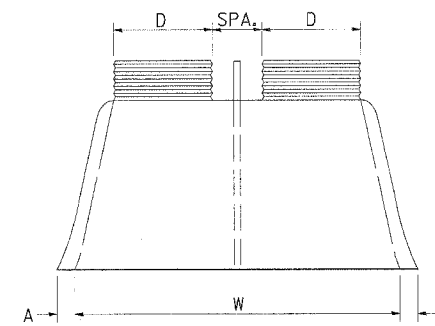

PLAN

PLAN

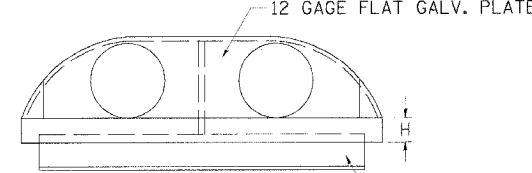

ELEVATION

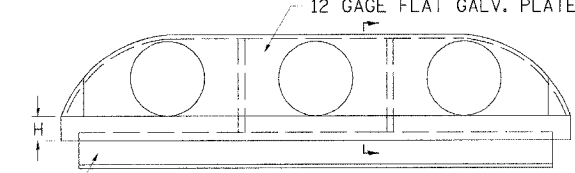

ELEVATION

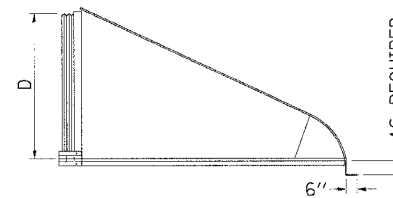

SIDE VIEW

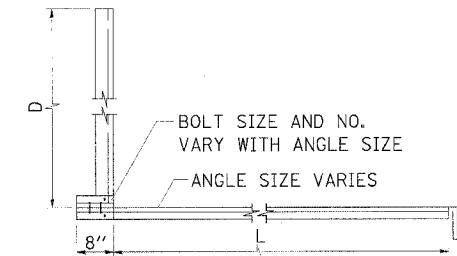

ANGLE SECTION VIEW

PIPE-ARCH MULTIPLE INLET END SECTIONS										
SPAN x RISE 2'-2 3/4" x 1 1/2"	EQUIV. ROUND	GAGE	SPA. (In)	A (In)	H (In)	L (In)	DOUBLE W	TRIPLE W	REINFORCING ANGLE	
17 x 13	15	16	12	6 1/2	6	20	59	88	2 x 2 x 1/4	
21 x 15	18	16	12	7 1/2	6	24	69	102	2 x 2 x 1/4	
24 x 18	21	16	12	8	6	28	78	114	2 x 2 x 1/4	
28 x 20	24	16	12	8	6	32	88	128	5 x 3 x 1/4	
35 x 24	30	14	12	10	6	39	107	154	5 x 3 x 1/4	
42 x 29	36	14	14	12	7 1/2	46	131	187	5 x 3 x 1/4	
49 x 33	42	12	17	13 1/2	9	53	150	216	5 x 3 x 1/4	
57 x 38	48	12	19	18 1/2	12	62	166	242	6 x 4 x 3/8	
64 x 43	54	12	22	18	12	69	188	274	6 x 4 x 3/8	
71 x 47	60	12/10	24	18 1/2	12	77	209	304	6 x 4 x 3/8	
77 x 62	66	12/10	26	18	12	77	229	332	6 x 4 x 3/8	
83 x 67	72	12/10	28	18	12	77	243	354	6 x 4 x 3/8	
SPAN x RISE 3'-x1' & 5'-x1'	EQUIV. ROUND	GAGE	SPA. (In)	A (In)	H (In)	L (In)	DOUBLE W	TRIPLE W	REINFORCING ANGLE	
60 x 46	54	12	20	18	12	70	182	262	6 x 4 x 3/8	
66 x 51	60	12/10	22	18	12	77	202	290	6 x 4 x 3/8	
73 x 55	66	12/10	25	18	12	77	224	322	6 x 4 x 3/8	
81 x 69	72	12/10	27	18	12	77	246	354	6 x 4 x 3/8	

ROUND PIPE MULTIPLE INLET END SECTIONS										
PIPE DIA. (D) (In)	GAGE	SPA. (In)	A (In)	H (In)	L (In)	DOUBLE W	TRIPLE W	REINFORCING ANGLE		
12	16	12	6 1/2	6	21	48	72	2 x 2 x 1/4		
15	16	12	7 1/2	6	26	57	84	2 x 2 x 1/4		
18	16	12	8	6	31	66	96	2 x 2 x 1/4		
21	16	12	10	6	36	75	108	2 x 2 x 1/4		
24	16	12	10	6	41	84	120	5 x 3 x 1/4		
30	14	15	12 1/4	8	51	102	147	5 x 3 x 1/4		
36	14	18	14 1/2	9	60	126	180	5 x 3 x 1/4		
42	12	21	17	10 1/2	69	147	210	5 x 3 x 1/4		
48	12	24	18 1/2	12	79	162	234	6 x 4 x 3/8		
54	12	27	18 1/2	12	84	183	264	6 x 4 x 3/8		
60	12/10	30	18	12	88	204	294	6 x 4 x 3/8		
66	12/10	33	18	12	87	219	318	6 x 4 x 3/8		
72	12/10	36	18	12	88 1/2	228	336	6 x 4 x 3/8		
78	12/10	36	18	12	87 1/2	252	366	6 x 4 x 3/8		
84	12/10	36	18	12	87 1/2	254	384	6 x 4 x 3/8		

NOTE: ALL DIMENSIONS ARE IN INCHES UNLESS OTHERWISE NOTED

PLOT DATE = 12/11/2005
 FILE NAME = M:\P\03\0632\04st 2\04r\11-72\FINAL-dist-standard-dwg
 PLOT SCALE = 50.000 / IN
 REFERENCE = SHEET