

F.A.U. RTE.	SECTION	COUNTY	TOTAL SHEETS	SHEET NO.
1700	05-00045-02-PV	COOK/DUPAGE	103	51
MAST ARM MOUNTED STREET NAME SIGNS				
FED. ROAD DIST. NO. 7 ILLINOIS FED. AID PROJECT M-800315441				

PANEL SIGN DESIGN TYPE 1

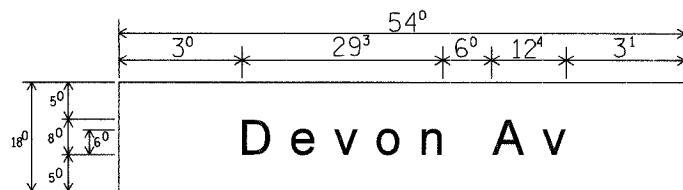

— Sq. M Each
6.75 Sq. Ft. Each
2 Required
Design Series D

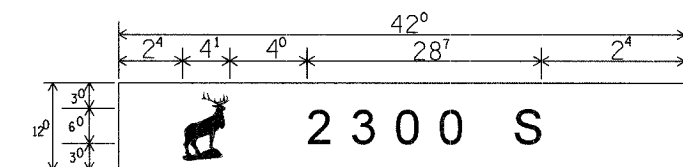

— Sq. M Each
3.5 Sq. Ft. Each
2 Required
Design Series D

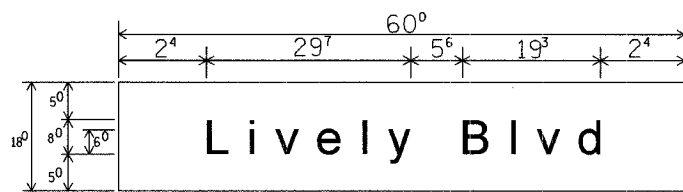

— Sq. M Each
7.5 Sq. Ft. Each
2 Required
Design Series D

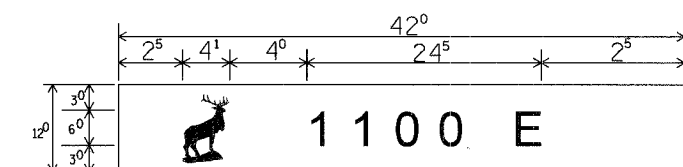

— Sq. M Each
3.5 Sq. Ft. Each
2 Required
Design Series D

NOTE: SIGN DIMENSIONS ARE IN ENGLISH UNITS.

GENERAL NOTES

- WHERE MAST ARM MOUNTED STREET NAME SIGNS ARE SPECIFIED, THE MAST ARM ASSEMBLY AND POLES SHALL BE DESIGNED TO SUPPORT THE LOADINGS CALLED FOR ON STANDARDS 834001, 834006 AND 834011, AS APPLICABLE, PLUS TWO (2) SIGN PANELS 2'-6" X 6'-0" MOUNTED AS SHOWN. THE DESIGN SHALL BE IN ACCORDANCE WITH THE REQUIREMENTS OF THE CURRENT "STANDARD SPECIFICATIONS FOR STRUCTURAL SUPPORTS FOR HIGHWAY SIGNS, LUMINAIRES AND TRAFFIC SIGNALS" AS PUBLISHED BY THE AMERICAN ASSOCIATION OF STATE HIGHWAY AND TRANSPORTATION OFFICIALS FOR 80 M.P.H. WIND VELOCITY.
- ALL SIGNS SHALL HAVE A WHITE REFLECTORIZED LEGEND AND BORDER ON A GREEN REFLECTORIZED BACKGROUND, TYPE AZ REFLECTORIZED SHEETING.
- THE SIGN LENGTH SHOULD BE INCREASED IN 6-INCH INCREMENTS, BUT THE OVERALL LENGTH SHOULD NOT EXCEED 6'-0".
- ALL BORDERS SHALL BE 3/4" WIDE AND CORNER RADIUS SHALL BE 2-1/4".
- SIGNFIX ALUMINUM CHANNEL FRAMING SYSTEM SHALL BE USED FOR ALL SIGNS ATTACHED TO SIGNAL POLES AND POSTS. LOCAL SUPPLIERS OF THE SIGNFIX ALUMINUM CHANNEL FRAMING SYSTEM ARE:

- *A.K.T. CORPORATION SCHALMBURG, IL
- *TUCKER COMPANY, INC. WAUWATOSA, WI
- *AMERICAN FABRICATION CO. CHICAGO HEIGHTS, IL
- *WESTERN TRAFFIC CONTROL, INC. CICERO, IL

- PARTS LISTING:
- SIGN CHANNEL PART #HPN053 (MED. CHANNEL)
 - SIGN SCREWS 1/4" x 14 x 1" H.W.H #3
 - BRACKETS PART #HPN034 (UNIVERSAL)
 - CHANNEL CLAMPS WITH STAINLESS STEEL STRAPPING

OTHER BRANDS OF MOUNTING HARDWARE ARE ACCEPTABLE, BASED UPON THE DEPARTMENT'S APPROVAL AND COMPATIBILITY WITH THE CHANNEL/BACKET OF THE ABOVE PRODUCT.

SUPPORTING CHANNELS

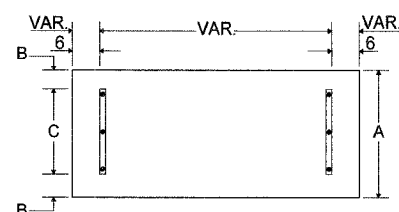

A	B	C
18"	2"	14"

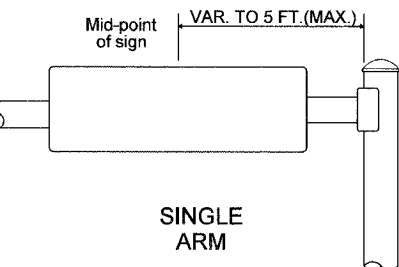

SIGNFIX ALUMINUM CHANNEL FRAMING SYSTEM shall be used. See Note #5.

SUPPORTING CHANNELS

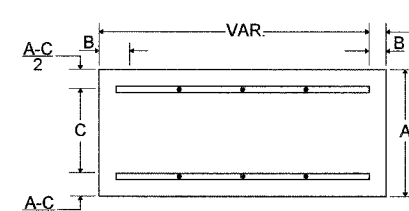

A	B	C
18"	2"	12"
30"	2"	22"

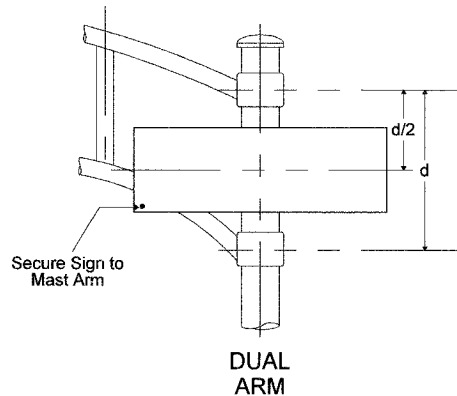

UPPER TO LOWER CASE SPACING CHART 8-6 INCH SERIES "C & D"

EXAMPLE, 2³ DENOTES 3/8"

SERIES	SECOND LETTER															
	o c d e		b h i k		f w		j		s t		v y		x		z	
	g o q	l m n p r u														
A W X	1 ²	1 ⁴	1 ⁴	1 ⁵	1 ²	1 ⁴	0 ⁶	1 ⁰	1 ¹	1 ⁴	0 ⁶	1 ⁰	1 ¹	1 ²	1 ²	1 ⁴
B	1 ⁴	1 ⁵	2 ⁰	2 ¹	1 ⁴	1 ⁵	1 ¹	1 ²	1 ⁴	1 ⁵	1 ²	1 ⁴	1 ²	1 ⁴	1 ⁶	1 ⁷
C E G	1 ⁴	1 ⁵	2 ⁰	2 ¹	1 ²	1 ⁴	0 ⁶	1 ⁰	1 ²	1 ⁴	1 ²	1 ⁴	1 ⁴	1 ⁵	1 ⁴	1 ⁵
D O Q R	1 ⁴	1 ⁵	2 ⁰	2 ¹	1 ⁴	1 ⁵	0 ⁶	1 ⁰	1 ²	1 ⁴	1 ²	1 ⁴	1 ⁴	1 ⁵	1 ⁴	1 ⁵
F	0 ⁵	0 ⁶	1 ⁴	1 ⁵	0 ⁶	1 ⁰	0 ⁵	0 ⁶	0 ⁶	1 ⁰	0 ⁶	1 ⁰	0 ⁶	1 ⁰	1 ¹	1 ²
H I M N	2 ⁰	2 ¹	2 ²	2 ⁴	2 ⁰	2 ¹	1 ⁴	1 ⁵	1 ⁶	1 ⁷	1 ⁶	1 ⁷	2 ⁰	2 ¹	2 ⁰	2 ¹
J U	2 ⁰	2 ¹	2 ⁰	2 ¹	1 ⁶	1 ⁷	1 ⁴	1 ⁵	1 ⁶	1 ⁷	1 ⁶	1 ⁷	1 ⁶	1 ⁷	2 ⁰	2 ¹
K L	1 ¹	1 ²	1 ⁶	1 ⁷	1 ¹	1 ²	0 ⁵	0 ⁶	1 ¹	1 ²	1 ¹	1 ²	1 ¹	1 ²	1 ²	1 ⁴
P	1 ²	1 ⁴	1 ⁴	1 ⁵	1 ²	1 ⁴	0 ⁵	0 ⁶	1 ¹	1 ²	1 ¹	1 ²	1 ¹	1 ²	1 ⁴	1 ²
S	1 ²	1 ⁴	1 ⁶	1 ⁷	1 ²	1 ⁴	0 ⁶	1 ⁰	1 ²	1 ⁴	1 ²	1 ⁴	1 ²	1 ⁴	1 ²	1 ⁴
T	1 ¹	1 ²	1 ⁶	1 ⁷	0 ⁶	1 ⁰	0 ⁶	1 ⁰	1 ¹	1 ²	1 ¹	1 ²	1 ¹	1 ²	1 ²	1 ⁴
V	0 ⁵	1 ⁰	1 ⁴	1 ⁵	1 ¹	1 ²	0 ⁶	1 ⁰	1 ²	1 ⁴	1 ²	1 ⁴	1 ²	1 ⁴	1 ²	1 ⁴
Y	0 ⁵	0 ⁶	1 ⁴	1 ⁵	0 ⁶	1 ⁰	0 ⁵	0 ⁶	0 ⁵	0 ⁷	0 ⁵	0 ⁶	0 ⁶	1 ⁰	1 ¹	1 ²
Z	1 ⁶	1 ⁷	2 ²	2 ⁴	1 ⁶	1 ⁷	1 ²	1 ⁴	1 ⁶	1 ⁷	1 ⁶	1 ⁷	1 ⁶	1 ⁷	2 ⁰	2 ¹

LOWER CASE TO LOWER CASE SPACING CHART 6 INCH SERIES "C" & "D"

SERIES	SECOND LETTER															
	a c d e		b h i k		f w		j		s t		v y		x		z	
	g o q	l m n p r u														
F																
I																
R																
S																
T																
E																
L																
E																
T																
T																
E																
R																

NUMBER TO NUMBER

SPACING CHART 8 INCH SERIES "C" & "D"

SERIES	SECOND NUMBER																			
	0		1		2		3		4		5		6		7		8		9	
	C	D	C	D	C	D	C	D	C	D	C	D	C	D	C	D	C	D	C	D
F																				
I																				
R																				
S																				
T																				
E																				
L																				
E																				
T																				
T																				
E																				
R																				

UPPER AND LOWER CASE LETTER WIDTHS

LETTERS	6 INCH UPPER CASE LETTERS				8 INCH UPPER CASE LETTERS				LETTERS	6 INCH LOWER CASE LETTERS			
	SERIES		SERIES		SERIES		SERIES			SERIES		SERIES	
	C	D	C	D	C	D	C	D		C	D	C	D
A	3 ⁶	5 ⁰	5 ⁰	6 ⁵	o	3 ⁵	4 ²						
B	3 ²	4 ⁰	4 ³	5 ³	b	3 ⁵	4 ²						
C	3 ²	4 ⁰	4 ³	5 ³	c	3 ⁵	4 ¹						
D	3 ²	4 ⁰	4 ³	5 ³	d	3 ⁵	4 ²						
E	3 ⁰	3 ⁵	4 ⁰	4 ⁷	e	3 ⁵	4 ²						
F	3 ⁰	3 ⁵	4 ⁰	4 ⁷	f	2 ³	2 ⁶						
G	3 ²	4 ⁰	4 ³	5 ³	g	3 ⁵	4 ²						
H	3 ²	4 ⁰	4 ³	5 ³	h	3 ⁵	4 ²						
I	0 ⁷	0 ⁷	1 ¹	1 ²	i	1 ¹	1 ¹						
J	3 ⁰	3 ⁶	4 ⁰	5 ⁰	j	2 ⁰	2 ²						
K	3 ²	4 ¹	4 ³	5 ⁴	k	3 ⁵	4 ²						
L	3 ⁰	3 ⁵	4 ⁰	4 ⁷	l	1 ¹	1 ¹						
M	3 ⁷	4 ⁵	5 ¹	6 ¹	m	6 ⁰	7 ⁰						
N	3 ²	4 ⁰	4 ³	5 ³	n	3 ⁵	4 ²						
O	3 ⁴	4 ²	4 ⁵	5 ⁵	o	3 ⁶	4 ³						
P	3 ²	4 ⁰	4 ³	5 ³	p	3 ⁵	4 ²						
Q	3 ⁴	4 ²	4 ⁵	5 ⁵	q	3 ⁵	4 ²						
R	3 ²	4 ⁰	4 ³	5 ³	r	2 ⁶	3 ²						
S	3 ²	4 ⁰	4 ³	5 ³	s	3 ⁶	4 ²						
T	3 ⁰	3 ⁵	4 ⁰	4 ⁷	t	2 ⁷	3 ²						
U	3 ²	4 ⁰	4 ³	5 ³	u	3 ⁵	4 ²						
V	3 ⁵	4 ⁴	4 ⁷	6 ⁰	v	4 ²	4 ⁷						
W	4 ⁴	5 ²	6 ⁰	7 ⁰	w	5 ⁵	6 ⁴						
X	3 ⁴	4 ⁰	4 ⁵	5 ³	x	4 ⁴	5 ¹						
Y	3 ⁶	5 ⁰	5 ⁰	6 ⁶	y	4 ⁶	5 ³						
Z	3 ²	4 ⁰	4 ³	5 ³	z	3 ⁶	4 ³						

NUMBER	6 INCH SERIES		8 INCH SERIES	
	C	D	C	D
1	2 ²	1 ⁴	1 ⁵	2 ⁰
2	3 ²	4 ⁰	4 ³	5 ³
3	3 ²	4 ⁰	4 ³	5 ³
4	3 ⁵	4 ⁰	4 ⁷	5 ⁷
5	3 ²	4 ⁰	4 ³	5 ³
6	3 ²	4 ⁰	4 ³	5 ³
7	3 ²	4 ⁰	4 ³	5 ³
8	3 ²	4 ⁰	4 ³	5 ³
9	3 ²	4 ⁰	4 ³	5 ³
0	3 ⁴	4 ²	4 ⁵	5 ⁵

ILLINOIS DEPARTMENT OF TRANSPORTATION
MAST ARM MOUNTED STREET NAME SIGNS
 DEVON AVENUE & LIVELY BOULEVARD
 DATE: 12/22/06
 DESIGNED BY: BRD
 CHECKED BY: JUE
 NOT TO SCALE