

PANEL SIGN DESIGN TYPE 1

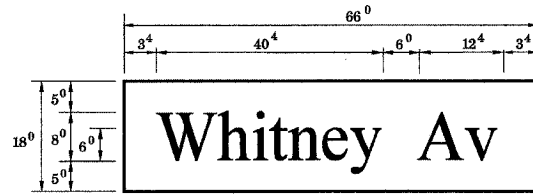

8.25 Sq. Ft. each
 2 Required
 Design Series D

PANEL SIGN DESIGN TYPE 2

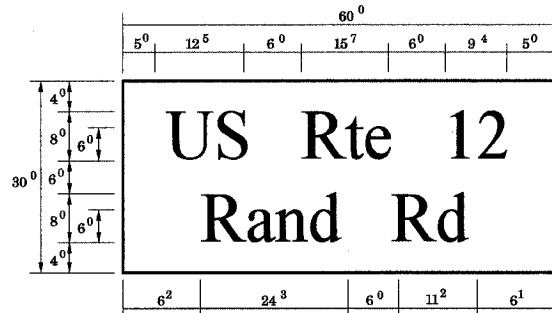

11.25 Sq. Ft. each
 2 Required
 Design Series D

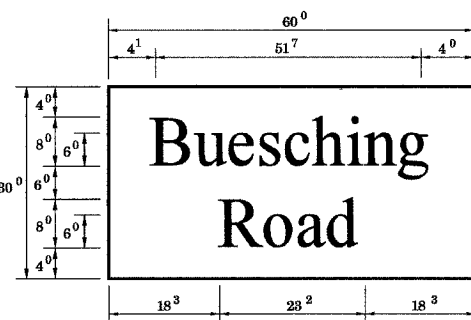

NOTE: SIGN DIMENSIONS ARE IN ENGLISH UNITS

GENERAL NOTES

- WHERE MAST ARM MOUNTED STREET NAME SIGNS ARE SPECIFIED, THE MAST ARM ASSEMBLY AND POLES SHALL BE DESIGNED TO SUPPORT THE LOADINGS CALLED FOR ON STANDARDS 834001, 834006 AND 834011, AS APPLICABLE, PLUS TWO (2) SIGN PANELS 2'-6" x 6'-0" MOUNTED AS SHOWN. THE DESIGN SHALL BE IN ACCORDANCE WITH THE REQUIREMENTS OF THE CURRENT "STANDARD SPECIFICATIONS FOR STRUCTURAL SUPPORTS FOR HIGHWAY SIGNS, LUMINAIRES, AND TRAFFIC SIGNALS" AS PUBLISHED BY THE AMERICAN ASSOCIATION OF STATE HIGHWAY AND TRANSPORTATION OFFICIALS FOR 80 M.P.H. WIND VELOCITY.
 - ALL SIGNS SHALL HAVE A WHITE REFLECTORIZED LEGEND AND BORDER ON A GREEN REFLECTORIZED BACKGROUND, TYPE A SHEETING.
 - THE SIGN LENGTH SHOULD BE INCREASED IN 6-INCH INCREMENTS, BUT THE OVERALL LENGTH SHOULD NOT EXCEED 6'-0".
 - ALL BORDERS SHALL BE 3/4" WIDE AND CORNER RADIUS SHALL BE 2-1/4".
 - SIGNFIX ALUMINUM CHANNEL FRAMING SYSTEM SHALL BE USED FOR ALL SIGNS ATTACHED TO SIGNAL POLES AND POSTS. LOCAL SUPPLIERS OF THE SIGNFIX ALUMINUM CHANNEL FRAMING SYSTEM ARE:
 * A.K.T. CORPORATION * AMERICAN FABRICATION CO.
 SCHAUMBURG, IL CHICAGO HEIGHTS, IL
 * TUCKER COMPANY, INC. * WESTERN TRAFFIC CONTROL INC.
 WAUWATOSA, WI CICERO, IL
- PARTS LISTING:
 SIGN CHANNEL PART #HPN053 (MED. CHANNEL)
 SIGN SCREWS 1/4" x 14 x 1" H.W.H. #3
 BRACKETS SELF TAPPING WITH NEOPRENE WASHER
 CHANNEL CLAMPS WITH STAINLESS STEEL STRAPPING
 OTHER BRANDS OF MOUNTING HARDWARE ARE ACCEPTABLE, BASED UPON THE DEPARTMENT'S APPROVAL AND COMPATIBILITY WITH THE CHANNEL/BACKET OF THE ABOVE PRODUCT.

SUPPORTING CHANNELS

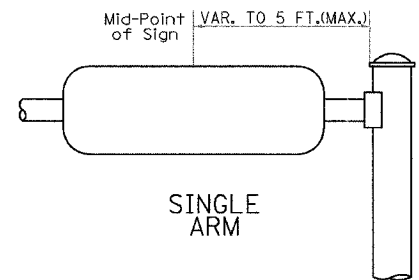
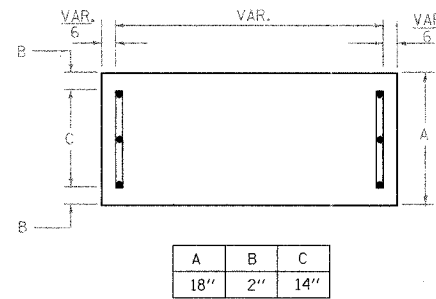

SUPPORTING CHANNELS

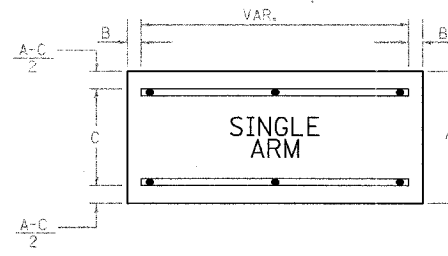

Labels for dual arm channels: A-C, B, C, VAR., A-C

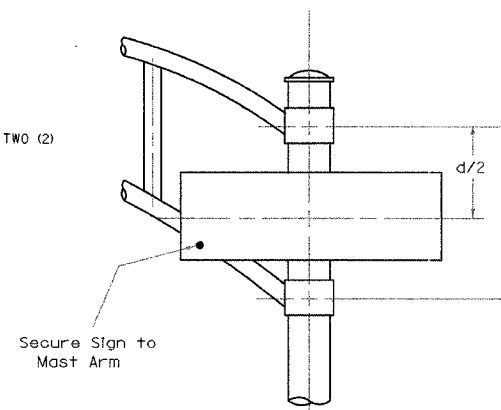

SIGNFIX ALUMINUM CHANNEL FRAMING SYSTEM
 Shall be used. See Note #5.

Upper Case To Lower Case
 Spacing Chart 8-6 Inch Series "C & D"

EXAMPLE, 2³ DENOTES 3/8"

SERIES		SECOND LETTER															
		acde		bhikl		f w		J		s +		v y		x z			
FIRST LETTER	Series	C	D	C	D	C	D	C	D	C	D	C	D	C	D		
A W X		12	14	14	15	12	14	06	10	11	14	06	10	11	12	14	
B		14	15	20	21	14	15	11	12	14	15	12	14	12	14	16	17
C E G		14	15	20	21	12	14	06	10	12	14	12	14	14	15	14	15
D O Q R		14	15	20	21	14	15	06	10	12	14	12	14	14	15	14	15
F		05	06	14	15	06	10	05	06	06	10	06	10	06	10	11	12
H I M N		20	21	22	24	20	21	14	15	16	17	16	17	20	21	20	21
J U		20	21	20	21	16	17	14	15	16	17	16	17	16	17	20	21
K L		11	12	16	17	11	12	05	06	11	12	11	12	11	12	12	14
P		12	14	14	15	12	14	05	06	11	12	11	12	12	14	12	14
S		12	14	16	17	12	14	06	10	12	14	12	14	12	14	12	14
T		11	12	16	17	06	10	06	10	11	12	11	12	11	12	12	14
V		06	10	14	15	11	12	06	10	12	14	12	14	12	14	12	14
Y		05	06	14	15	06	10	05	06	05	07	05	06	06	10	11	12
Z		16	17	22	24	16	17	12	14	16	17	16	17	16	17	20	21

Lower Case To Lower Case
 Spacing Chart 6 Inch Series "C & D"

SERIES		SECOND LETTER															
		acde		bhikl		f w		J		s +		v y		x z			
FIRST LETTER	Series	C	D	C	D	C	D	C	D	C	D	C	D	C	D		
adhgi		16	17	22	24	16	17	12	14	14	15	14	15	16	17	16	17
lmnqu																	
bfkops		12	14	16	17	11	12	05	06	11	12	11	12	12	14	12	14
ce		12	14	16	17	12	14	06	10	12	14	12	14	12	14	12	14
r		06	10	12	14	06	10	03	03	05	06	05	06	06	10	06	10
tz		12	14	16	17	12	14	06	10	11	12	11	12	12	14	12	14
vy		11	12	14	15	11	12	05	06	06	10	06	10	11	12	11	12
w		11	12	14	15	11	12	05	06	11	12	11	12	11	12	12	14
x		12	14	16	17	11	12	05	06	11	12	11	12	11	12	12	14

Number To Number
 Spacing Chart 8 Inch Series "C & D"

SERIES		SECOND NUMBER																			
		0	1	2	3	4	5	6	7	8	9										
0 9		16	17	16	17	14	15	12	14	14	15	14	15	16	17	12	14	16	17	16	17
1		20	21	20	21	20	21	16	17	14	15	20	21	20	21	14	15	20	21	20	21
2 3 4		14	15	14	15	14	15	12	14	12	14	14	15	14	15	11	12	14	15	14	15
5		14	15	14	15	14	15	11	12	11	12	14	15	14	15	11	12	14	15	14	15
6		16	17	14	15	14	15	12	14	14	15	14	15	11	12	14	15	14	15	14	15
7		12	14	12	14	14	15	12	15	05	06	12	14	14	15	11	12	14	15	12	14
8		16	17	16	17	14	15	12	15	12	14	14	15	16	17	12	14	16	17	14	15

UPPER AND LOWER CASE
 LETTER WIDTHS

LETTERS	6 INCH UPPER CASE LETTERS				8 INCH UPPER CASE LETTERS				LETTERS	6 INCH LOWER CASE LETTERS	
	SERIES		SERIES		SERIES		SERIES			C	D
	C	D	C	D	C	D	C	D			
A	36	50	50	65	a	35	42				
B	32	40	43	53	b	35	42				
C	32	40	43	53	c	35	41				
D	32	40	43	53	d	35	42				
E	30	35	40	47	e	35	42				
F	30	35	40	47	f	23	26				
G	32	40	43	53	g	35	42				
H	32	40	43	53	h	35	42				
I	07	07	11	12	i	11	11				
J	30	36	40	50	j	20	22				
K	32	41	43	54	k	35	42				
L	30	35	40	47	l	11	11				
M	37	45	51	61	m	60	70				
N	32	40	43	53	n	35	42				
O	34	42	45	55	o	36	43				
P	32	40	43	53	p	35	42				
Q	34	42	45	55	q	35	42				
R	32	40	43	53	r	26	32				
S	32	40	43	53	s	36	42				
T	30	35	40	47	t	27	32				
U	32	40	43	53	u	35	42				
V	35	44	47	60	v	42	47				
W	44	52	60	70	w	55	64				
X	34	40	45	53	x	44	51				
Y	36	50	50	66	y	46	53				
Z	32	40	43	53	z	36	43				

NUMBER	6 INCH SERIES		8 INCH SERIES	
	C	D	C	D
1	12	14	15	20
2	32	40	43	53
3	32	40	43	53
4	35	43	47	57
5	32	40	43	53
6	32	40	43	53
7	32	40	43	53
8	32	40	43	53
9	32	40	43	53
0	34	42	45	55

REVISIONS

NAME	DATE
D.A.Z./D.A.G.	11/90
	6/98
CADD	10/00

Illinois Department of Transportation
 DISTRICT 1

MAST ARM MOUNTED
 STREET NAME SIGNS

SCALE: NONE
 DATE:

DRAWN BY: ROB
 DESIGNED BY: JHE
 CHECKED BY: DAD