

F.A.I. R/L	SECTION	COUNTY	TOTAL SHEETS	SHEET NO.
90/94	2004-074RS	COOK	63	21
STA.	TO STA.			
FED. ROAD DIST. NO. 1		ILLINOIS	FED. AID PROJECT	

62813

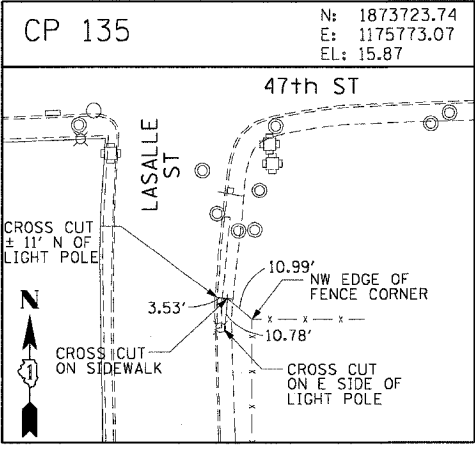
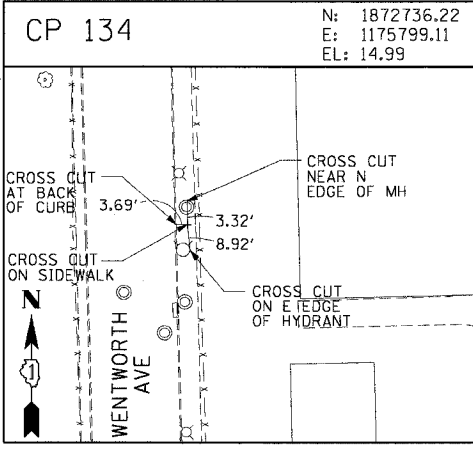
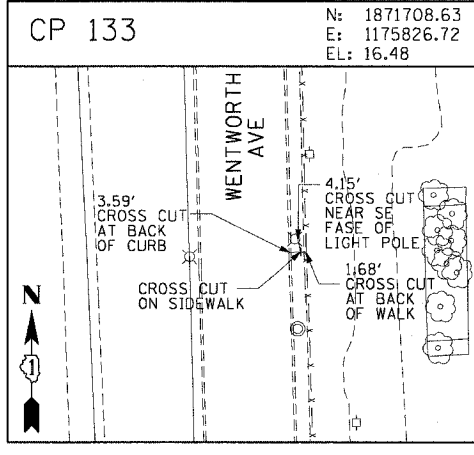
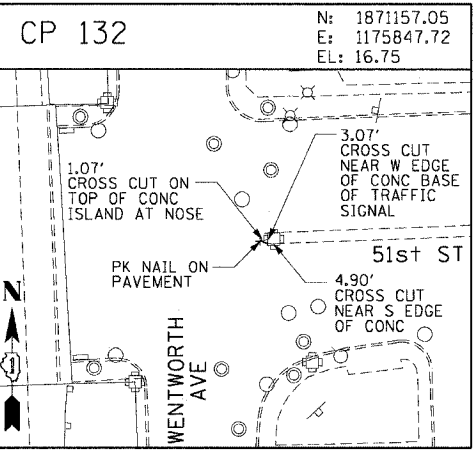
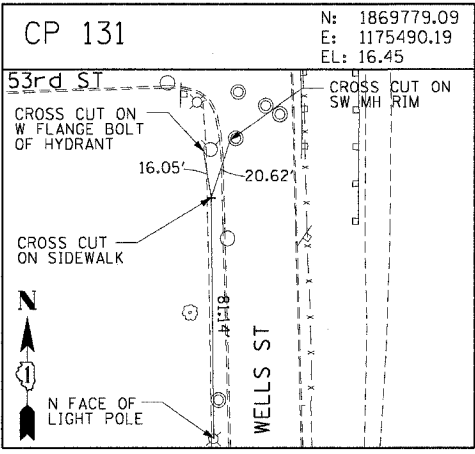
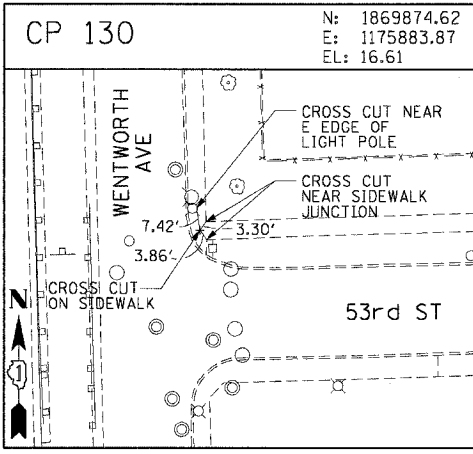
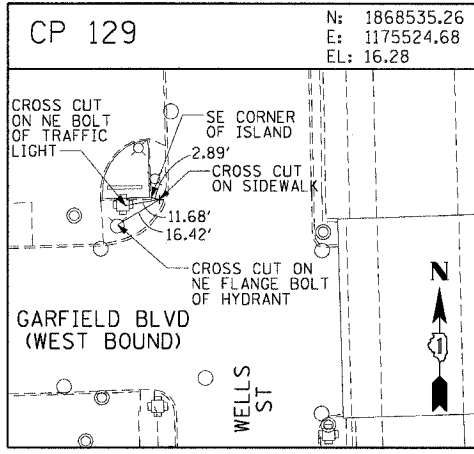
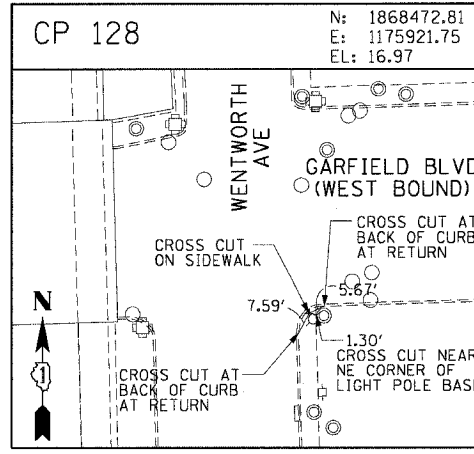
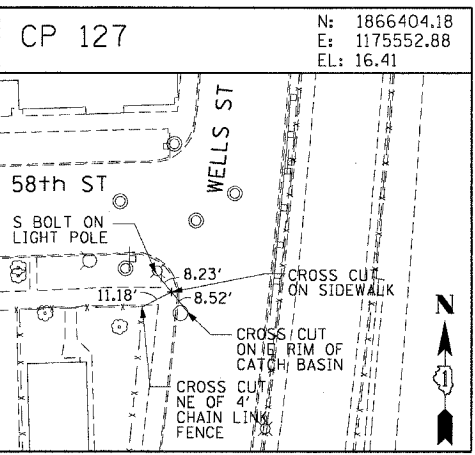
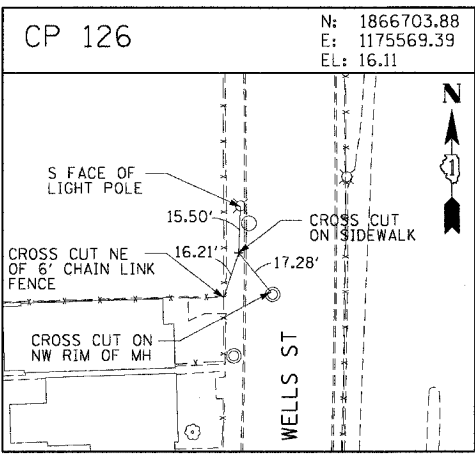
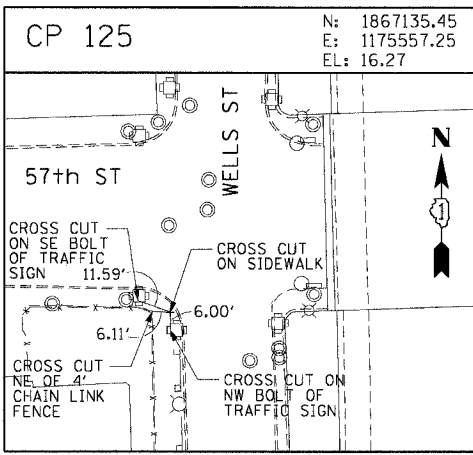
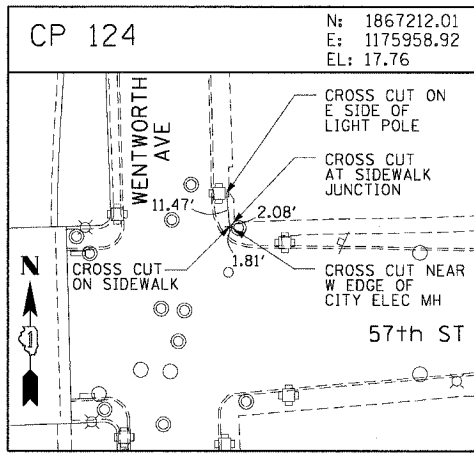
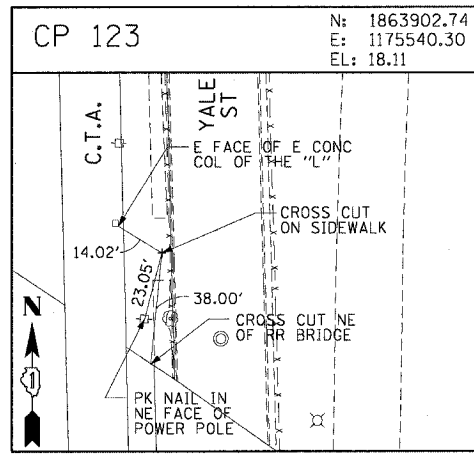
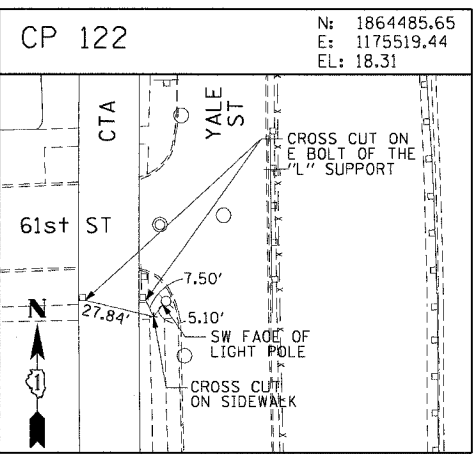
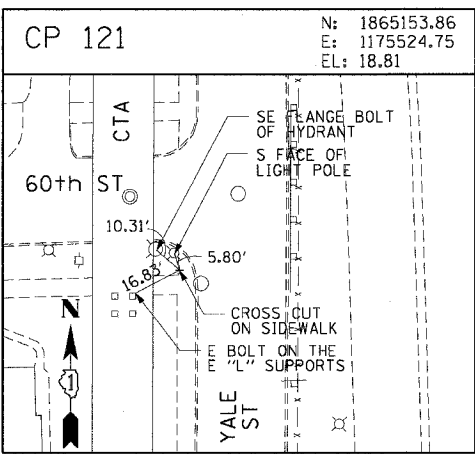
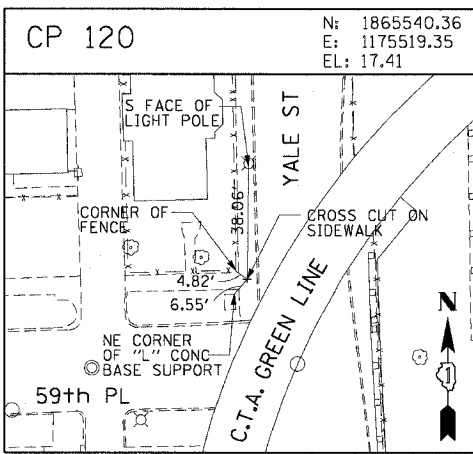
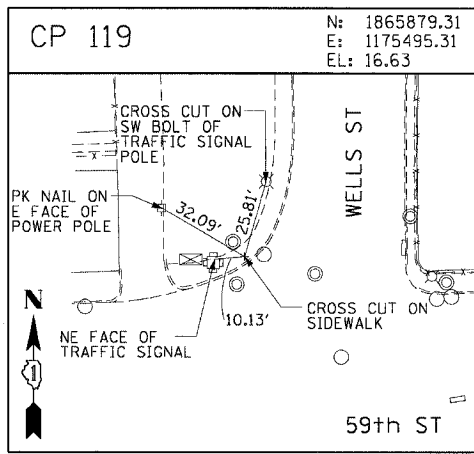
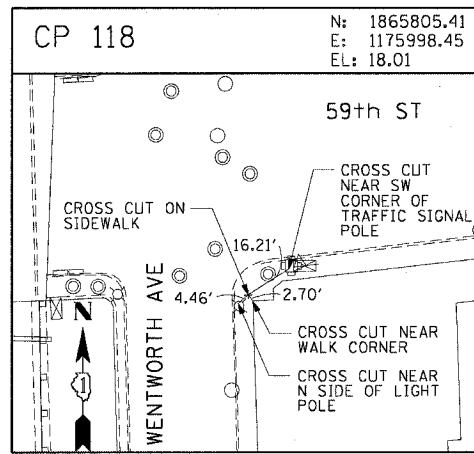

REVISIONS	
NAME	DATE

ILLINOIS DEPARTMENT OF TRANSPORTATION
 F.A.I. 90/94 (DAN RYAN EXPRESSWAY)
 59th ST TO 57th ST (WELLS STREET)
 SURVEY TIES AND CONTROL POINTS

SCALE: 1"=30'
 DATE: December 17, 2004
 DRAWN BY: MRK
 CHECKED BY: JAL



12/14/2004 4:52:43 PM