

SCOUR REPAIR LT. STA. 251+64 5' x 5' BOX CULVERT (W.B.L.) MP 12.0

F.A.I. RYE.	SECTION	COUNTY	TOTAL SHEETS	SHEET NO
24	*	**	189	169
STA.		TO STA.		
FED. ROAD DIST. NO.	ILLINOIS	FED. AID PROJECT		
		* X1-2,44(2,3,4)RS,BSMARTFY04-4		
		** WILLIAMSON/JOHNSON		
		CONTRACT NO. 98758		

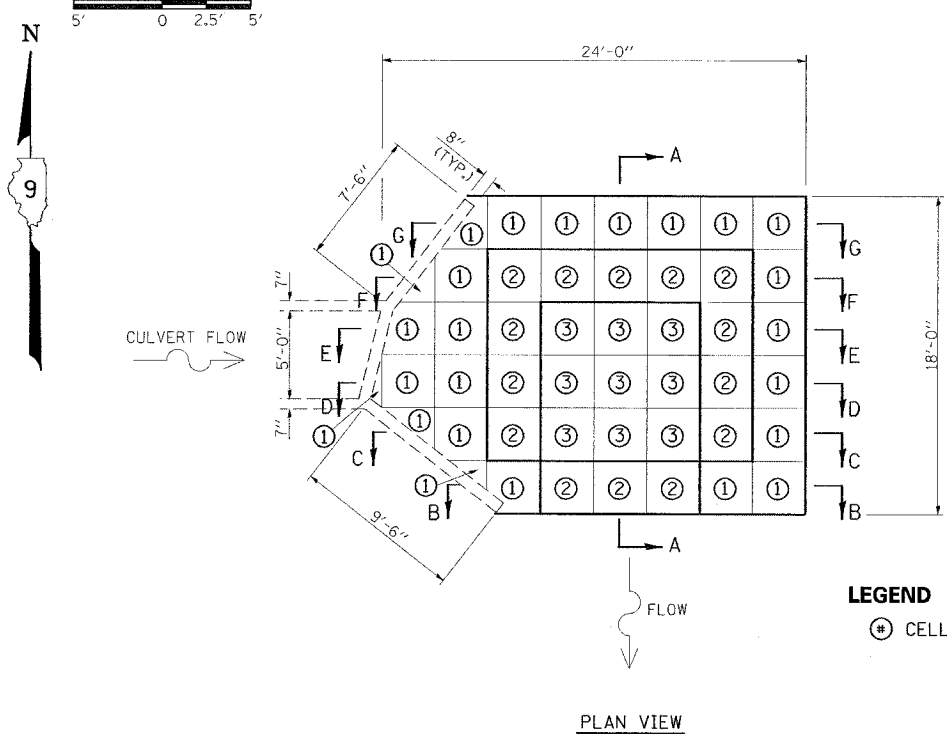

LEGEND
 ⊕ CELL NO. (SEE GABION BASKET CHART)

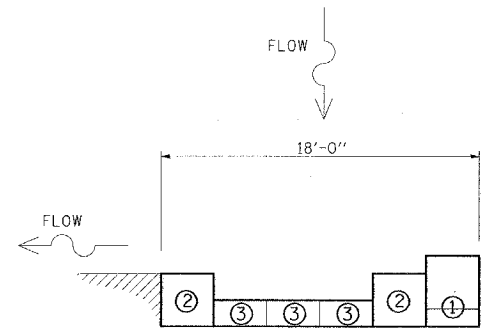

SECTION A-A

GABION BASKET CHART

CELL NO.	NO CELLS	BASKET SIZE	ESTIMATED NO. OF BASKETS
①	1	3' x 3' x 3'	24
	1	3' x 3' x 1'	24
②	1	3' x 3' x 3'	14
③	1	3' x 3' x 1.5'	9

PLAN VIEW

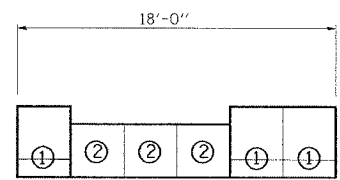

SECTION B-B

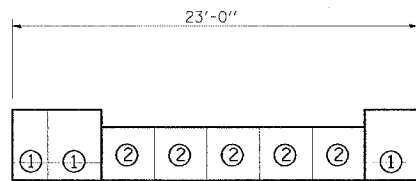

SECTION F-F

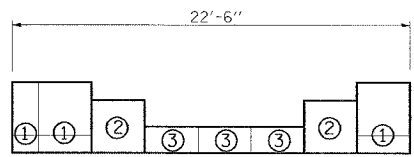

SECTION C-C

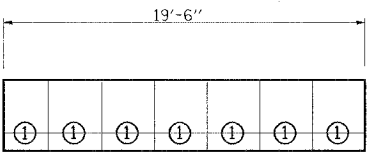

SECTION G-G

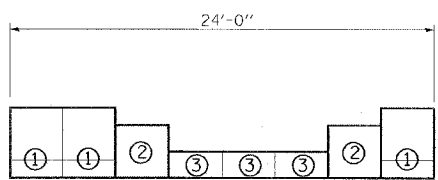

SECTION D-D AND SECTION E-E

THIS WORK INVOLVES THE EXCAVATION OF EARTH AS SHOWN IN THE SKETCH TO THE DIMENSIONS AS SPECIFIED. THE EARTH EXCAVATION WILL BE UTILIZED IN THE ROADWAY EMBANKMENT TO REPAIR ANY FORESLOPE EROSION, AS DIRECTED BY THE ENGINEER.

EARTHWORK WILL BE INCLUDED IN THE COST OF THE GABIONS.

THE LENGTH AND WIDTH OF THE GABION BASKET SHALL BE APPROVED BY THE ENGINEER. CELLS SHALL BE AS LABELED BY CELL NO.

THE GABION BASKET IS TO BE CONSTRUCTED AT THE LOCATION INDICATED ON THE PLAN SHEETS.

THE SIZE OF RIPRAP FOR GABION BASKETS SHALL BE IN ACCORDANCE WITH SECTION 284 OF THE STANDARD SPECIFICATIONS.

THE AVERAGE DIMENSIONS FOR GABIONS ARE AS INDICATED AND NOTED IN THE RIPRAP SCHEDULE.

THE RIPRAP AND BASKETS SHALL BE PAID FOR PER CU. YD. FOR GABIONS.

BEDDING MATERIAL WILL NOT BE REQUIRED.

FILTER FABRIC WILL NOT BE REQUIRED.

Thursday, October 28, 2004 @ 9:37:42 AM
 c:\p\projects\98758\2\west24-1.dgn Lvl1-63