

**LIGHT POLE FOUNDATION DEPTH TABLE**  
40 FT. (12.192 m) TO 47.5 FT. (14.478 m) MOUNTING HEIGHT

SOIL CONDITIONS	DESIGN DEPTH "D" OF FOUNDATION	
	SINGLE ARM POLE	TWIN ARM POLE
SOFT CLAY O <sub>u</sub> = 0.375 TON/SO. FT.	13'-0" (3.96 m)	15'-0" (4.57 m)
MEDIUM CLAY O <sub>u</sub> = 0.75 TON/SO. FT.	9'-6" (2.93 m)	10'-9" (3.23 m)
STIFF CLAY O <sub>u</sub> = 1.50 TON/SO. FT.	7'-0" (2.13 m)	8'-0" (2.44 m)
LOOSE SAND φ = 34°	9'-0" (2.74 m)	10'-0" (3.05 m)
MEDIUM SAND φ = 37.5°	8'-3" (2.52 m)	9'-0" (2.74 m)
DENSE SAND φ = 40°	7'-9" (2.36 m)	9'-0" (2.74 m)

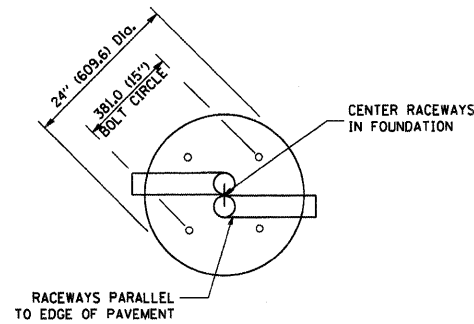

**TOP VIEW**

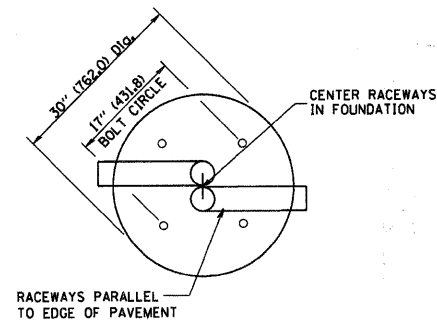

**TOP VIEW**

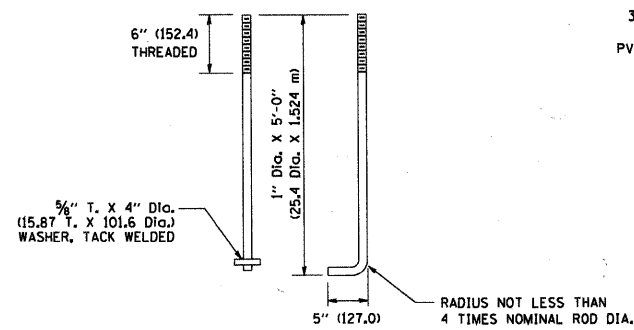

**ANCHOR ROD DETAIL**

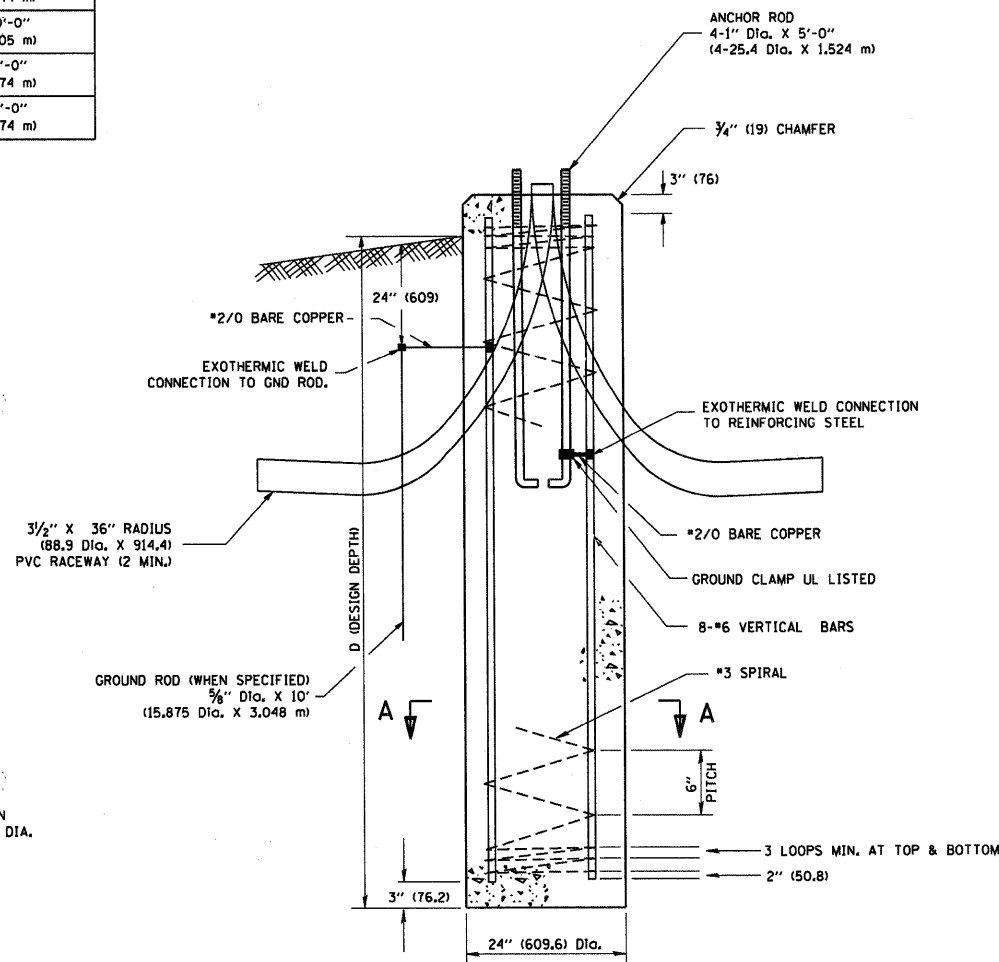

**FOUNDATION DETAIL**

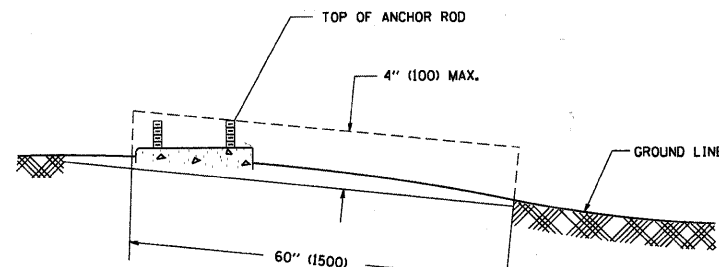

**FOUNDATION EXTENSION DETAIL**

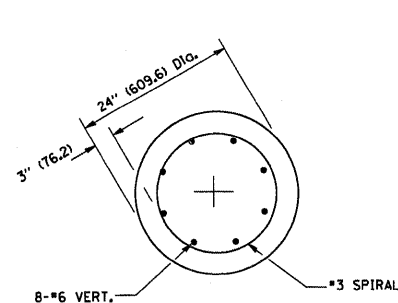

**SECTION A-A**

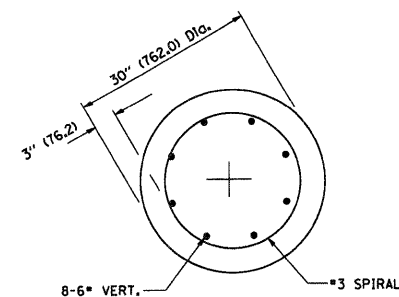

**SECTION A-A**

**NOTES**

- ALL DIMENSIONS ARE IN INCHES (MILLIMETERS) UNLESS OTHERWISE SHOWN.
- THE ANCHOR RODS AND RACEWAYS SHALL BE PROPERLY SECURED IN PLACE BEFORE THE CONCRETE IS PLACED.
- THE FOUNDATION SHALL NOT PROTRUDE MORE THAN 100MM (4 IN.) ABOVE THE FINISHED GRADE WITHIN A 60 IN. (1.5 m) CHORD ACROSS THE FOUNDATION, WITH ANCHOR RODS INCLUDED. IN ACCORDANCE WITH AASHTO GUIDELINES, IF THE FOUNDATION HEIGHT, INCLUDING ANCHOR RODS, EXTENDS BEYOND THESE SPECIFIED LIMITS, THE FOUNDATION SHALL BE REPLACED AT THE CONTRACTOR'S EXPENSE. SEE FOUNDATION EXTENSION DETAIL.
- THE HOLE FOR THE FOUNDATION SHALL BE MADE BY DRILLING WITH AN AUGER, OF THE SAME DIAMETER AS THE FOUNDATION. IF SOIL CONDITIONS REQUIRE THE USE OF A LINER TO FORM THE HOLE, THE LINER SHALL BE WITHDRAWN AS THE CONCRETE IS DEPOSITED.
- THE TOP OF THE FOUNDATION SHALL BE CONSTRUCTED LEVEL. A LINER OR FORM SHALL BE USED TO PRODUCE A UNIFORM SMOOTH SIDE TO THE TOP OF THE FOUNDATION. FOUNDATION TOP SHALL BE CHAMFERED 3/4-IN. (20 mm).
- THE CONCRETE SHALL BE CLASS S1. CONCRETE SHALL CURE ACCORDING TO ARTICLE 1020.13 BEFORE LIGHT POLES ARE INSTALLED.
- THE ANCHOR ROD SHALL BE A HOOK ROD TYPE. COLD BENDING OF THE ANCHOR ROD WILL NOT BE ALLOWED. THE RADIUS OF THE HOOK BEND SHALL NOT BE LESS THAN 4 TIMES THE NOMINAL DIAMETER OF THE ANCHOR ROD. A TACK WELDED ANCHOR ROD MAY BE SUBSTITUTED WITH THE APPROVAL OF THE ENGINEER.
- THE ANCHOR RODS SHALL BE ACCORDING TO ASTM F1554 GRADE 725 (GRADE 105). NUTS SHALL BE HEXAGON NUTS ACCORDING TO ASTM A 194 2H OR ASTM A 563 DH, AND WASHERS SHALL BE ACCORDING TO ASTM F 436.
- ANCHOR RODS, NUTS AND WASHERS SHALL BE COMPLETELY GALVANIZED BY EITHER THE HOT-DIPPED PROCESS CONFORMING WITH AASHTO M 232, THE MECHANICAL PLATING METHOD CONFORMING TO AASHTO M 298, CLASS 50 WITH A MAXIMUM COATING THICKNESS OF 150 UM/6 MILS) OR THE ELECTROLYTIC PROCESS ACCORDING TO ASTM F 1136.
- THE ANCHOR RODS SHALL BE THREADED A MINIMUM OF 6 INCHES (150 mm) WITH A MINIMUM OF 3 INCHES (75 mm) OF THREADED ANCHOR ROD EMBEDDED IN THE FOUNDATION.
- ANCHOR RODS SHALL PROJECT 2 3/4" (69.9 mm) ABOVE THE TOP OF THE FOUNDATION. IF BREAKAWAY COUPLINGS ARE SPECIFIED, THE CONTRACTOR SHALL CAREFULLY COORDINATE THE ANCHOR ROD PROJECTION WITH THE INSTALLATION REQUIREMENTS OF THE BREAKAWAY COUPLINGS.
- THE CONTRACTOR SHALL USE A #3 SPIRAL AT 6" (152.4 mm) PITCH OR MAY SUBSTITUTE #3 TIES AT 12" (304.8 mm) O.C. WITH THE APPROVAL OF THE ENGINEER.
- THE CABLE TRENCHES AND FOUNDATION SHALL BE BACK FILLED AND COMPACTED AS SPECIFIED BEFORE THE LIGHT POLE IS ERECTED.
- THE RACEWAYS SHALL PROJECT 1" (25.4 mm) ABOVE THE TOP OF THE FOUNDATION.

FILE NAME = W:\diststd\22x34\be301.dgn	USER NAME = geglionobt	DESIGNED -	REVISED - 04-22-02	<b>STATE OF ILLINOIS DEPARTMENT OF TRANSPORTATION</b>	<b>LIGHT POLE FOUNDATION</b>			F.A.P. RTE.	SECTION	COUNTY	TOTAL SHEETS	SHEET NO.
		DRAWN -	REVISED -		40' (12.192 m) TO 47 1/2' (14.478 m) M.H. 15" (381 mm) BOLT CIRCLE			336	01-00269-00-CH	KANE	124	120
		CHECKED -	REVISED -		SCALE: NONE SHEET NO. 1 OF 1 SHEETS STA. TO STA.			BE-301		CONTRACT NO. 63533		
		DATE = 1/4/2008	REVISED -		FED. ROAD DIST. NO. 1 (ILLINOIS) FED. AID PROJECT							