

PARTIAL FRAMING PLAN

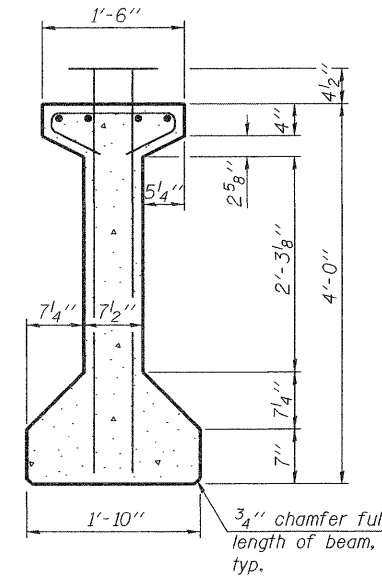

BEAM DIMENSIONS
FOR INFORMATION ONLY

- Polymer Modified Portland Cement Mortar
- Structural Repair of Concrete ≤ 5 inches

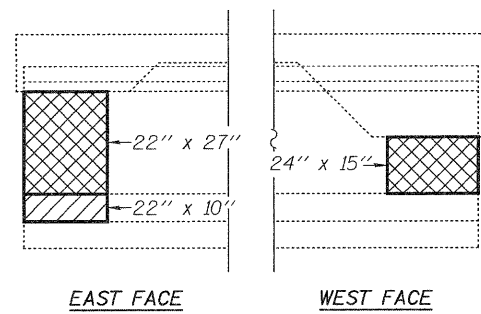

BEAM 1 - S. ABUT.

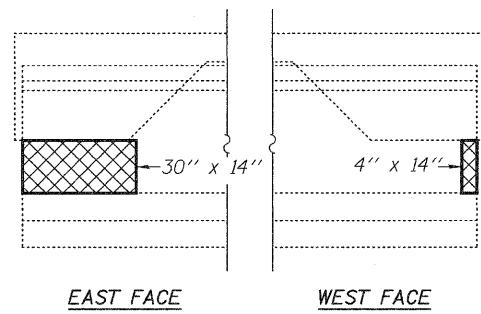

BEAM 2 - S. ABUT.

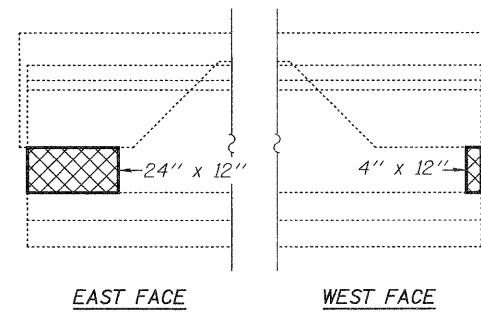

BEAM 3 - S. ABUT.

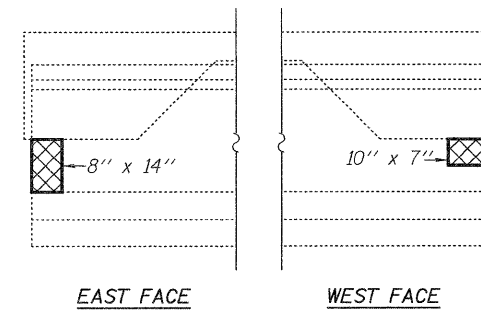

BEAM 4 - S. ABUT.

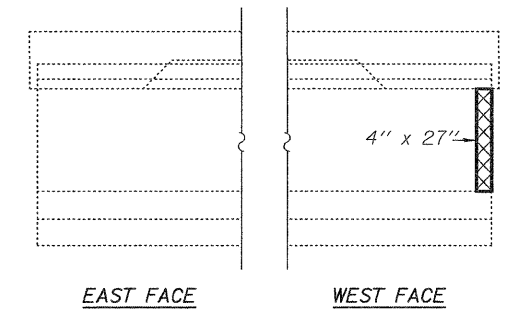

BEAM 5 - S. ABUT.

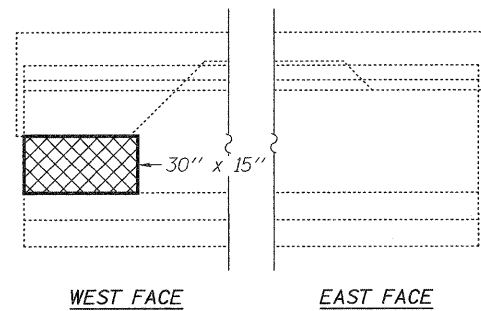

BEAM 1 - N. ABUT.

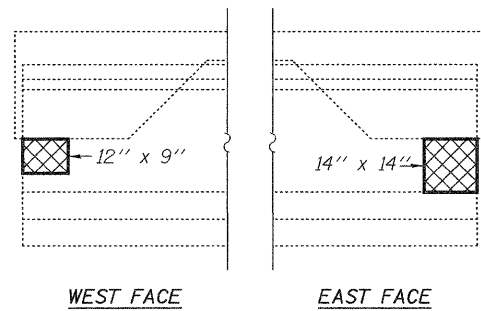

BEAM 2 - N. ABUT.

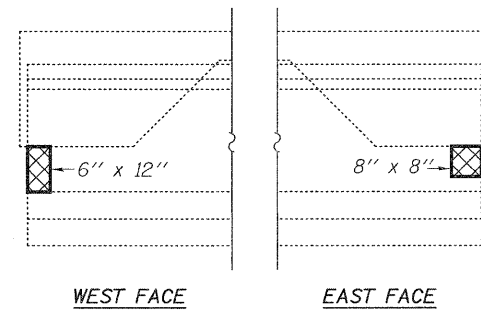

BEAM 3 - N. ABUT.

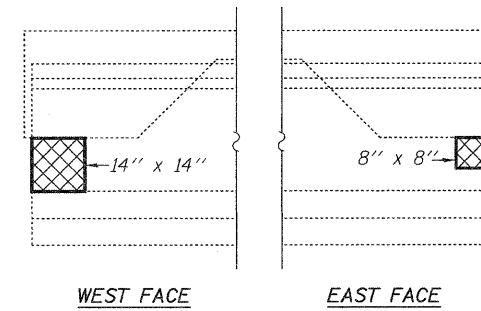

BEAM 4 - N. ABUT.

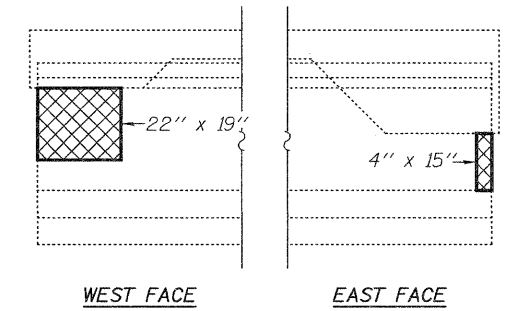

BEAM 5 - N. ABUT.

DESIGNED GGE
 CHECKED ADY
 DRAWN Kyle M. Steffen
 CHECKED GGE ADY

EXAMINED *James F. J. [Signature]* DATE JANUARY 13, 2011
 PASSED *Carl [Signature]*
 ACTING ENGINEER OF STRUCTURAL SERVICES
 ACTING ENGINEER OF BRIDGES AND STRUCTURES

STATE OF ILLINOIS
DEPARTMENT OF TRANSPORTATION

P.P.C. I-BEAM END REPAIRS
SN 043-0035

SHEET NO. 7 OF 10 SHEETS

F.A.P. RTE.	SECTION	COUNTY	TOTAL SHEETS	SHEET NO.
301	(298-1M-1)	JoDAVIESS	17	14
CONTRACT NO. 64G81			ILLINOIS FED. AID PROJECT	