

# 115

**Letting March 11, 2022**

## **Notice to Bidders, Specifications and Proposal**



**Contract No. 85714  
OGLE County  
Section 17-00318-00-RS  
Route FAS 86 (Mt. Morris Road)  
Project PMX4-730 ()  
District 2 Construction Funds**

Plans are  
included herein

Prepared by

Checked by

F





- 1. TIME AND PLACE OF OPENING BIDS.** Electronic bids are to be submitted to the electronic bidding system (iCX-Integrated Contractors Exchange). All bids must be submitted to the iCX system prior to 12:00 p.m. March 11, 2022 at which time the bids will be publicly opened from the iCX SecureVault.
- 2. DESCRIPTION OF WORK.** The proposed improvement is identified and advertised for bids in the Invitation for Bids as:

**Contract No. 85714  
OGLE County  
Section 17-00318-00-RS  
Project PMX4-730 ()  
Route FAS 86 (Mt. Morris Road)  
District 2 Construction Funds**

**Resurfacing Mt. Morris Road from IL 72 to the north city limits of Mt. Morris.**

- 3. INSTRUCTIONS TO BIDDERS.** (a) This Notice, the invitation for bids, proposal and letter of award shall, together with all other documents in accordance with Article 101.09 of the Standard Specifications for Road and Bridge Construction, become part of the contract. Bidders are cautioned to read and examine carefully all documents, to make all required inspections, and to inquire or seek explanation of the same prior to submission of a bid.  
  
(b) State law, and, if the work is to be paid wholly or in part with Federal-aid funds, Federal law requires the bidder to make various certifications as a part of the proposal and contract. By execution and submission of the proposal, the bidder makes the certification contained therein. A false or fraudulent certification shall, in addition to all other remedies provided by law, be a breach of contract and may result in termination of the contract.
- 4. AWARD CRITERIA AND REJECTION OF BIDS.** This contract will be awarded to the lowest responsive and responsible bidder considering conformity with the terms and conditions established by the Department in the rules, Invitation for Bids and contract documents. The issuance of plans and proposal forms for bidding based upon a prequalification rating shall not be the sole determinant of responsibility. The Department reserves the right to determine responsibility at the time of award, to reject any or all proposals, to re-advertise the proposed improvement, and to waive technicalities.

By Order of the  
Illinois Department of Transportation

Omer Osman,  
Secretary

INDEX  
FOR  
SUPPLEMENTAL SPECIFICATIONS  
AND RECURRING SPECIAL PROVISIONS

Adopted January 1, 2022

This index contains a listing of SUPPLEMENTAL SPECIFICATIONS, frequently used RECURRING SPECIAL PROVISIONS, and LOCAL ROADS AND STREETS RECURRING SPECIAL PROVISIONS.

No ERRATA this year.

SUPPLEMENTAL SPECIFICATIONS

Std. Spec. Sec.

Page No.

No Supplemental Specifications this year.

RECURRING SPECIAL PROVISIONS

The following RECURRING SPECIAL PROVISIONS indicated by an "X" are applicable to this contract and are included by reference:

<u>CHECK SHEET #</u>		<u>PAGE NO.</u>
1	X Additional State Requirements for Federal-Aid Construction Contracts .....	1
2	X Subletting of Contracts (Federal-Aid Contracts) .....	4
3	X EEO .....	5
4	Specific EEO Responsibilities Non Federal-Aid Contracts .....	15
5	Required Provisions - State Contracts .....	20
6	Asbestos Bearing Pad Removal .....	26
7	Asbestos Waterproofing Membrane and Asbestos HMA Surface Removal .....	27
8	Temporary Stream Crossings and In-Stream Work Pads .....	28
9	Construction Layout Stakes .....	29
10	Use of Geotextile Fabric for Railroad Crossing .....	32
11	Subsealing of Concrete Pavements .....	34
12	Hot-Mix Asphalt Surface Correction .....	38
13	Pavement and Shoulder Resurfacing .....	40
14	Patching with Hot-Mix Asphalt Overlay Removal .....	41
15	Polymer Concrete .....	43
16	PVC Pipeliner .....	45
17	Bicycle Racks .....	46
18	Temporary Portable Bridge Traffic Signals .....	48
19	Nighttime Inspection of Roadway Lighting .....	50
20	English Substitution of Metric Bolts .....	51
21	Calcium Chloride Accelerator for Portland Cement Concrete .....	52
22	Quality Control of Concrete Mixtures at the Plant .....	53
23	Quality Control/Quality Assurance of Concrete Mixtures .....	61
24	Digital Terrain Modeling for Earthwork Calculations .....	77
25	Preventive Maintenance – Bituminous Surface Treatment (A-1) .....	79
26	Temporary Raised Pavement Markers .....	85
27	Restoring Bridge Approach Pavements Using High-Density Foam .....	86
28	Portland Cement Concrete Inlay or Overlay .....	89
29	Portland Cement Concrete Partial Depth Hot-Mix Asphalt Patching .....	93
30	Longitudinal Joint and Crack Patching .....	96
31	Concrete Mix Design – Department Provided .....	98
32	Station Numbers in Pavements or Overlays .....	99

LOCAL ROADS AND STREETS RECURRING SPECIAL PROVISIONS

Table of Contents

<u>CHECK SHEET #</u>		<u>PAGE NO.</u>
LRS1	Reserved .....	101
LRS2	Furnished Excavation .....	102
LRS3	X Work Zone Traffic Control Surveillance .....	103
LRS4	X Flaggers in Work Zones .....	104
LRS5	Contract Claims .....	105
LRS6	Bidding Requirements and Conditions for Contract Proposals .....	106
LRS7	Bidding Requirements and Conditions for Material Proposals .....	112
LRS8	Reserved .....	118
LRS9	Bituminous Surface Treatments .....	119
LRS10	Reserved .....	123
LRS11	Employment Practices .....	124
LRS12	Wages of Employees on Public Works .....	126
LRS13	Selection of Labor .....	128
LRS14	Paving Brick and Concrete Paver Pavements and Sidewalks .....	129
LRS15	Partial Payments .....	132
LRS16	Protests on Local Lettings .....	133
LRS17	Substance Abuse Prevention Program .....	134
LRS18	Multigrade Cold Mix Asphalt .....	135
LRS19	Reflective Crack Control Treatment .....	136

Section: 17-00318-00-RS  
County: Ogle County  
Project No.: PMX4 (730)  
Job No.: C-92-030-20  
Contract No.: 85714

## **INDEX OF SPECIAL PROVISIONS**

<u>PAGE</u>	<u>DESCRIPTION</u>
1	DESCRIPTION OF WORK
1	BITUMINOUS MATERIALS (PRIME COAT)
1	BITUMINOUS MATERIALS (TACK COAT)
1	HOT-MIX ASPHALT SHOULDERS (SPECIAL)
2	AGGREGATE SHOULDER WEDGE (BY OTHERS)
2	HOT-MIX ASPHALT SURFACE COURSE, IL-9.5, MIX C, N50
2	INCIDENTAL HOT-MIX ASPHALT SURFACING
2	SHORT TERM PAVEMENT MARKING
3	HOT-MIX ASPHALT SURFACE REMOVAL – BUTT JOINT
3	TEMPORARY RAMPS
3-5	TRAFFIC CONTROL & PROTECTION (SPECIAL)
6	LR107-4: INSURANCE
7	LR702: CONSTRUCTION AND MAINTENANCE SIGNS
8	LR1030: GROWTH CURVE
10	LR1030-2: LOCAL QUALITY ASSURANCE/QUALITY MANAGEMENT QC/QA

## BDE SPECIAL PROVISIONS

The following special provisions indicated by an "X" are applicable to this contract. An \* indicates a new or revised special provision for the letting.

<u>File Name</u>	<u>Pg.</u>	<u>Special Provision Title</u>	<u>Effective</u>	<u>Revised</u>
* 80099		Accessible Pedestrian Signals (APS)	April 1, 2003	Jan. 1, 2022
80274		Aggregate Subgrade Improvement	April 1, 2012	April 1, 2016
80192	12	X Automated Flagger Assistance Device	Jan. 1, 2008	
80173		Bituminous Materials Cost Adjustments	Nov. 2, 2006	Aug. 1, 2017
* 80246		Bituminous Surface Treatment with Fog Seal	Jan. 1, 2020	Jan. 1, 2022
80436		Blended Finely Divided Minerals	April 1, 2021	
80241		Bridge Demolition Debris	July 1, 2009	
50261		Building Removal-Case I (Non-Friable and Friable Asbestos)	Sept. 1, 1990	April 1, 2010
50481		Building Removal-Case II (Non-Friable Asbestos)	Sept. 1, 1990	April 1, 2010
50491		Building Removal-Case III (Friable Asbestos)	Sept. 1, 1990	April 1, 2010
50531		Building Removal-Case IV (No Asbestos)	Sept. 1, 1990	April 1, 2010
80384	14	X Compensable Delay Costs	June 2, 2017	April 1, 2019
80198		Completion Date (via calendar days)	April 1, 2008	
80199		Completion Date (via calendar days) Plus Working Days	April 1, 2008	
80293		Concrete Box Culverts with Skews > 30 Degrees and Design Fills ≤ 5 Feet	April 1, 2012	July 1, 2016
80311		Concrete End Sections for Pipe Culverts	Jan. 1, 2013	April 1, 2016
80261		Construction Air Quality – Diesel Retrofit	June 1, 2010	Nov. 1, 2014
80434		Corrugated Plastic Pipe (Culvert and Storm Sewer)	Jan. 1, 2021	
80029	18	X Disadvantaged Business Enterprise Participation	Sept. 1, 2000	Mar. 2, 2019
80229		Fuel Cost Adjustment	April 1, 2009	Aug. 1, 2017
* 80433		Green Preformed Thermoplastic Pavement Markings	Jan. 1, 2021	Jan. 1, 2022
* 80422		High Tension Cable Median Barrier	Jan. 1, 2020	Jan. 1, 2022
* 80442	28	X Hot-Mix Asphalt – Start of Production	Jan. 1, 2022	
* 80438		Illinois Works Apprenticeship Initiative – State Funded Contracts	June 2, 2021	Sept. 2, 2021
* 80411		Luminaires, LED	April 1, 2019	Jan. 1, 2022
* 80045		Material Transfer Device	June 15, 1999	Jan. 1, 2022
80418		Mechanically Stabilized Earth Retaining Walls	Nov. 1, 2019	Nov. 1, 2020
80430		Portland Cement Concrete – Haul Time	July 1, 2020	
* 34261		Railroad Protective Liability Insurance	Dec. 1, 1986	Jan. 1, 2022
80395		Sloped Metal End Section for Pipe Culverts	Jan. 1, 2018	
* 80340		Speed Display Trailer	April 2, 2014	Jan. 1, 2022
* 80127		Steel Cost Adjustment	April 2, 2014	Jan. 1, 2022
80397	29	X Subcontractor and DBE Payment Reporting	April 2, 2018	
80391	30	X Subcontractor Mobilization Payments	Nov. 2, 2017	April 1, 2019
80437		Submission of Payroll Records	April 1, 2021	
* 80435		Surface Testing of Pavements – IRI	Jan. 1, 2021	Jan. 1, 2022
80410		Traffic Spotters	Jan. 1, 2019	
* 20338		Training Special Provisions	Oct. 15, 1975	Sept. 2, 2021
80318		Traversable Pipe Grate for Concrete End Sections	Jan. 1, 2013	Jan. 1, 2018
* 80429		Ultra-Thin Bonded Wearing Course	April 1, 2020	Jan. 1, 2022
80439	31	X Vehicle and Equipment Warning Lights	Nov. 1, 2021	
80440		Waterproofing Membrane System	Nov. 1, 2021	
80302	32	X Weekly DBE Trucking Reports	June 2, 2012	Nov. 1, 2021
80427	33	X Work Zone Traffic Control Devices	Mar. 2, 2020	
80071	35	X Working Days	Jan. 1, 2002	



The following special provisions are in the 2022 Supplemental Specifications and Recurring Special Provisions.

<u>File Name</u>	<u>Special Provision Title</u>	<u>New Location(s)</u>	<u>Effective</u>	<u>Revised</u>
80425	Cape Seal	Sections 405, 1003	Jan. 1, 2020	Jan. 1, 2021
80387	Contrast Preformed Pavement Marking	Articles 780.08, 1095.03	Nov. 1, 2017	
80402	Disposal Fees	Article 109.04(b)	Nov. 1, 2018	
80378	Dowel Bar Inserter	Articles 420.03, 420.05, 1103.20	Jan. 1, 2017	Jan. 1, 2018
80421	Electric Service Installation	Articles 804.04, 804.05	Jan. 1, 2020	
80415	Emulsified Asphalts	Article 1032.06	Aug. 1, 2019	
80423	Engineer's Field Office and Laboratory	Section 670	Jan. 1, 2020	
80417	Geotechnical Fabric for Pipe Underdrains and French Drains	Articles 1080.01(a), 1080.05	Nov. 1, 2019	
80420	Geotextile Retaining Walls	Article 1080.06(d)	Nov. 1, 2019	
80304	Grooving for Recessed Pavement Markings	Articles 780.05, 780.14, 780.15	Nov. 1, 2012	Nov. 1, 2020
80416	Hot-Mix Asphalt – Binder and Surface Course	Sections 406, 1003, 1004, 1030, 1101	July 2, 2019	Nov. 1, 2019
80398	Hot-Mix Asphalt – Longitudinal Joint Sealant	Sections 406, 1032	Aug. 1, 2018	Nov. 1, 2019
80406	Hot-Mix Asphalt – Mixture Design Verification and Production (Modified for I-FIT)	Sections 406, 1030	Jan. 1, 2019	Jan. 2, 2021
80347	Hot-Mix Asphalt – Pay for Performance Using Percent Within Limits – Jobsite Sampling	Sections 406, 1030	Nov. 1, 2014	July 2, 2019
80383	Hot-Mix Asphalt – Quality Control for Performance	Sections 406, 1030	April 1, 2017	July 2, 2019
80393	Manholes, Valve Vaults, and Flat Slab Tops	Articles 602.02, 1042.10	Jan. 1, 2018	Mar. 1, 2019
80424	Micro-Surfacing and Slurry Sealing	Sections 404, 1003	Jan. 1, 2020	Jan. 1, 2021
80428	Mobilization	Article 671.02	April 1, 2020	
80412	Obstruction Warning Luminaires, LED	Sections 801, 822, 1067	Aug. 1, 2019	
80359	Portland Cement Concrete Bridge Deck Curing	Articles 1020.13, 1022.03	April 1, 2015	Nov. 1, 2019
80431	Portland Cement Concrete Pavement Patching	Articles 701.17(e)(3)b, 1001.01(d), 1020.05(b)(5)	July 1, 2020	
80432	Portland Cement Concrete Pavement Placement	Article 420.07	July 1, 2020	
80300	Preformed Plastic Pavement Marking Type D - Inlaid	Articles 780.08, 1095.03	April 1, 2012	April 1, 2016
80157	Railroad Protective Liability Insurance (5 and 10)	Article 107.11	Jan. 1, 2006	
80306	Reclaimed Asphalt Pavement (RAP) and Reclaimed Asphalt Shingles (RAS)	Section 1031	Nov. 1, 2012	Jan. 2, 2021
80407	Removal and Disposal of Regulated Substances	Section 669	Jan. 1, 2019	Jan. 1, 2020
80419	Silt Fence, Inlet Filters, Ground Stabilization and Riprap Filter Fabric	Articles 280.02, 280.04, 1080.02, 1080.03, 1081.15	Nov. 1, 2019	July 1, 2021
80408	Steel Plate Beam Guardrail Manufacturing	Article 1006.25	Jan. 1, 2019	
80413	Structural Timber	Article 1007.03	Aug. 1, 2019	
80298	Temporary Pavement Marking	Section 703, Article 1095.06	April 1, 2012	April 1, 2017
80409	Traffic Control Devices – Cones	Article 701.15(a), 1106.02(b)	Jan. 1, 2019	
80288	Warm Mix Asphalt	Sections 406, 1030, 1102	Jan. 1, 2012	April 1, 2016
80414	Wood Fence Sight Screen	Article 641.02	Aug. 1, 2019	April 1, 2020



Local Public Agency	County	Section Number
Ogle County	Ogle	17-00318-00-RS

The following Special Provision supplement the "Standard Specifications for Road and Bridge Construction", adopted

**January 1, 2022**, the latest edition of the "Manual on Uniform Traffic Control Devices for Streets and Highways", and the "Manual of Test Procedures of Materials" in effect on the date of invitation of bids, and the Supplemental Specification and Recurring Special Provisions indicated on the Check Sheet included here in which apply to and govern the construction of the above named section, and in case of conflict with any parts, or parts of said Specifications, the said Special Provisions shall take precedence and shall govern.

**DESCRIPTION OF WORK:**

The proposed improvement includes the overlay of Mt. Morris Rd from the northerly Village limits of Mt. Morris to IL Route 72 near Mt. Morris, Illinois. The improvement consists of the construction of 3' wide paved shoulders along the edge of the existing pavement and the overlay of the pavement with 1.5" of hot-mix asphalt surface course. The completed paved surface will be 28' wide.

**BITUMINOUS MATERIALS (PRIME COAT):**

This work shall be done in accordance with the applicable provisions of Section 406 of the Standard Specifications for Road and Bridge Construction. PEP shall be used for BITUMINOUS MATERIALS (PRIME COAT) placed on the aggregate below the asphalt shoulder widening and in the currently unpaved private entrances. It shall be applied at a rate of 0.150 lbs/sf, or to the satisfaction of the Engineer. This work shall be paid for at the contract price per Pound for BITUMINOUS MATERIALS (PRIME COAT).

**BITUMINOUS MATERIALS (TACK COAT):**

This work shall be done in accordance with the applicable provisions of Section 406 of the Standard Specifications for Road and Bridge Construction. Asphalt SS-1h shall be used for BITUMINOUS MATERIALS (TACK COAT) on all bituminous surfaces, and shall be applied at a rate of 0.050 lbs/sf, or to the satisfaction of the Engineer. This work shall be paid for at the contract price per Pound for BITUMINOUS MATERIALS (TACK COAT).

**HOT-MIX ASPHALT SHOULDERS (SPECIAL):**

This work shall be done in accordance with the applicable provisions of Section 482 of the Standard Specifications for Road and Bridge Construction. This work shall consist of the placement of 2 lifts of hot-mix asphalt in a 3 ft wide shoulder. The first lift shall have a compacted thickness of 2" and shall be placed and compacted in a trench prepared by others. The top of this first compacted lift will match the grade of the adjacent existing pavement. The trench excavation work for the paved shoulder will be completed by others immediately ahead of the contractor's operations, but within the contractor's traffic control limits. The second lift shall have a compacted thickness of 1.5" and shall be placed and compacted simultaneously with the mainline pavement.

The density requirement for the lower lift of Hot-mix Asphalt Shoulders (Special) shall be in accordance with the attached Local Road Special Provision LR 1030 "Growth Curve". The density of the upper lift will be determined in the same manner as and in conjunction with that of the Hot-Mix Asphalt Surface Course, IL-9.5, Mix C, N50.

Cost of preparing the trench for shoulder paving and shaping the aggregate shoulders after paving will not be included in the contract. The priming of the base prior to placing the first lift of the asphalt shoulder shall be paid at the contract unit price per Pound for BITUMINOUS MATERIALS (PRIME COAT). The placement of the bottom lift of asphalt shoulder (lower 2") shall be paid at the contract unit price per Ton for HOT-MIX ASPHALT SHOULDER (SPECIAL). The placement of the top lift of asphalt shoulder (upper 1.5") shall be paid at the contract unit price per Ton for HOT-MIX ASPHALT SURFACE COURSE, IL-9.5, MIX C, N50.

Ogle County

Ogle

17-00318-00-RS

**AGGREGATE SHOULDER WEDGE (BY OTHERS):**

All aggregate shoulder wedges shall be by others. The shoulder stone will be placed in one lift and will be completed and shaped within 14 calendar days of the placement of the surface course, but prior to final striping. Separate traffic control setups for aggregate shoulder wedge placement are by others and not included in this contract.

**HOT-MIX ASPHALT SURFACE COURSE, IL-9.5, MIX C, N50:**

This work shall be done in accordance with the applicable provisions of Section 406 of the Standard Specifications for Road and Bridge Construction. The HOT-MIX ASPHALT SURFACE COURSE, IL-9.5, MIX C, N50 shall be produced from one plant only. Minimum daily tons placed on the road shall be 1,200 tons when paving the mainline. HMA Surface Course specified for the 3-foot wide shoulder strips shall be placed simultaneously with the mainline pavement and are considered an integral part of the mainline paving.

Mailbox turnouts shall be paved according to standard BLR 24 or as directed by the Engineer. Mailbox turnouts to be placed with extendable screeds during mainline paving and are considered an integral part of the mainline paving. This work shall be included in the unit price per Ton for HOT-MIX ASPHALT SURFACE COURSE, IL-9.5, MIX C, N50.

**Compaction Equipment**

Rollers shall consist of at least 1 Vibratory Roller, 1 Pneumatic Tired Roller, and 1 Tandem Finish Roller.

**Paving Equipment**

The paver shall be equipped with a Full Vibratory Hydraulic variable width screed.

The construction of the mainline pavement, 3-foot shoulder strips and mailbox turnouts shall be paid for at the contract price per Ton for HOT-MIX ASPHALT SURFACE COURSE, IL-9.5, MIX C, N50.

**INCIDENTAL HOT-MIX ASPHALT SURFACING:**

This work shall be done in accordance with the applicable provisions of Section 408 of the Standard Specifications for Road and Bridge Construction. The INCIDENTAL HOT-MIX ASPHALT SURFACING is to be used for side roads and entrances. The bituminous mixture shall be produced from one plant only and shall be the same mix design as that used for HOT-MIX ASPHALT SURFACE COURSE, IL-9.5, MIX C, N50.

This work shall be paid for at the contract price per Ton for INCIDENTAL HOT-MIX ASPHALT SURFACING.

**SHORT TERM PAVEMENT MARKING:**

This work shall be done in accordance with the applicable provisions of Section 703 of the Standard Specifications for Road and Bridge Construction. This work shall consist of the placement of SHORT TERM PAVEMENT MARKINGS at the appropriate stages of construction as indicated in Section 703 of the Standard Specifications or as determined by the Engineer.

All SHORT TERM PAVEMENT MARKINGS that will be operational during the winter months (December through March) or that are placed on milled surface shall be paint.

The removal of SHORT TERM PAVEMENT MARKINGS from the final surface course shall be performed by the contractor within 5 calendar days after the final pavement markings are placed and shall be considered incidental to the pay item.

Ogle County

Ogle

17-00318-00-RS

This work shall be paid for at the contract price per Foot for SHORT TERM PAVEMENT MARKINGS.

#### HOT-MIX ASPHALT SURFACE REMOVAL – BUTT JOINT:

This work shall be done in accordance with the applicable provisions of Section 406 of the Standard Specifications for Road and Bridge Construction. This work shall consist of milling the existing pavement in the roadway, at the right-of-way in paved entrances, and along paved shoulders in front of the existing gutter.

Surface removal in the road shall consist of sawing joints at right angles to the roadway and removing the existing asphalt with a Roto-Mill as directed by the Engineer.

The BUTT JOINTS shall be the full width of the pavement at varying depths and lengths as shown in the butt joint details.

Milling, hauling, and disposal of the millings shall be paid for at the contract price per Square Yard for HOT-MIX ASPHALT SURFACE REMOVAL – BUTT JOINT.

#### TEMPORARY RAMP:

This work shall be done in accordance with the applicable provisions of Section 406 of the Standard Specifications for Road and Bridge Construction. This work shall consist of the construction of TEMPORARY RAMPS at the locations of the mainline butt joints located at either end of the project and at the bridge approaches. The ramps shall be constructed immediately upon completion of the surface removal operation.

The HMA mixture used in the construction of the Temporary Ramps shall be mixture IL-9.5 or IL-9.5FG. To aid in the removal of the temporary ramps, treated paper shall be placed over the existing asphalt surfaces to act as a bond break.

Construction of the TEMPORARY RAMPS shall be paid for at the contract price per Square Yard for TEMPORARY RAMP.

#### TRAFFIC CONTROL & PROTECTION (SPECIAL):

Traffic Control shall be according to the applicable sections of the Standard Specifications for Road and Bridge Construction, the applicable guidelines contained in the National Manual on Uniform Traffic Control Devices for Streets and Highways, Illinois Supplement to the National Manual on Uniform Traffic Control Devices, these special provisions, and any details and Highway Standards contained herein and in the plans.

Special attention is called to Articles 107.09 and 107.14 of the Standard Specifications for Road and Bridge Construction and the following Standards:

Standards: 701006, 701301, 701306, 701311, 701901, 720011, 728001 & 729001.

#### Details:

The entire section shall be kept open to through traffic. Local residents shall be allowed access in accordance with Article 107.09 of the Standard Specifications.

The presence of temporary traffic control drawings or standards in the project plans, whether a pay item or not, does not relieve the contractor of his obligation to the public, in accordance with Article 107.14 of the Standard Specifications for Road and Bridge Construction. The contractor shall provide, to the satisfaction of the Engineer, all protection deemed necessary beyond that shown in the plans or Special Provisions.

Ogle County

Ogle

17-00318-00-RS

**Signs:**

No bracing shall be allowed on post-mounted signs.

Signs shall be mounted on steel posts using standards 720011, 728001, 729001, or on 4"x4" wood posts per Section 730 of the Standard Specifications for Road and Bridge Construction. Other "break away" connections can be used if accepted by the FHWA and corresponding letter is provided to the resident.

All signs are required on both sides of the road when the median is greater than 10 feet and on one way roadways.

"BUMP" (W8-1(O)48) signs shall be installed as directed by the Engineer.

"UNEVEN LANES" (W8-11(O)48) signs shall be installed at 1 mile intervals or as directed by the Engineer.

"NO PASSING ZONES NOT STRIPED NEXT XX MILES" (G20-I100(O)) signs shall be 60"X36".

"LOW SHOULDER" (W8-9(O)48) signs shall be installed at 1 mile intervals or as directed by the Engineer. These signs shall remain in place and maintained by Contractor until the completion of the aggregate shoulders placed by others.

When covering existing Department signs, no tape shall be used on the reflective portion of the sign. Contact the District sign shop for covering techniques.

"ROAD CONSTRUCTION AHEAD" (W20-I103(O)48) signs on sideroads outside of the active work zone shall have an arrow (W1-6(R or L)(O)-3618) mounted below the sign.

All regulatory signs shall be maintained at a 5 foot minimum bottom (rural), 7 foot minimum (urban).

Plates altering signs shall be the same sheeting as the base sign. No more than one (1) plate is allowed per sign.

Any post stubs without a sign in place and visible shall have a reflector placed on each post.

**Devices:**

A minimum of 3 drums spaced at 1.2 meters (4 feet) shall be placed at each return when the sideroad is open.

**Lights:**

Steady burn mono-directional lights are required on devices delineating a widening trench.

**Flaggers:**

Flaggers shall comply with all requirements and signaling methods contained in the Department's "Traffic Control Field Manual" current at the time of letting. The flagger equipment listed for flaggers employed by the Illinois Department of Transportation shall apply to all flaggers.

In addition to the flaggers shown on applicable standards, on major sideroads listed below flaggers shall be required on all legs of the intersection. Major sideroads for this project shall be: Midtown Road, West Grove Road, and Town Line Road.

Flaggers are required on all legs of the intersection when the flagger is within 250 feet of the intersection.

Ogle County

Ogle

17-00318-00-RS

When the mainline is regulated by flaggers, the following intersections shall be closed: none.

The remaining intersections and the following major commercial driveways shall be regulated with one flagger.

Major commercial driveways for this project shall be: none.

Revise the first and second paragraph of Article 701.20(i) of the Standard Specifications to read:

“Signs, barricades, other traffic control devices, or flaggers required by the Engineer, over and above those shown in the contract documents, will be paid for according to Article 109.04.”

All flaggers, signs, and devices to complete this work shall be included in the cost per Lump Sum for Traffic Control and Protection Special.

When the road is closed to through traffic and it is necessary to provide access for local traffic, all flaggers as shown on the applicable standards will be required. No reduction in the number of flaggers shall be allowed.

**Maintenance of Traffic:**

The mainline shall be kept open to one-way traffic at all times during working hours and two-way traffic during non-working hours.

The Contractor shall be required to notify the Ogle County Highway Department, the corresponding Township Commissioner, emergency response agencies (i.e.: fire, ambulance, police), school districts and the Department of Transportation (Bureau of Project Implementation) regarding any changes in traffic control.

The Contractor shall be required to notify the Ogle County Highway Department and/or corresponding Township Commissioner for any sideroad closure or opening.

The pavement patch removal and replacement shall be completed using Traffic Control and Protection Standard 701201.

The sawing of patches, resurfacing and placing of shoulder aggregate shall be completed using Traffic Control and Protection Standard 701306.

Placing and removing pavement marking shall be completed using Traffic Control and Protection Standard 701306 and 701311.

**Removal:**

The removal of all traffic control signage from project site shall be performed by the contractor within 5 calendar days after the short-term pavement markings are removed and shall be considered incidental to the pay item.

This work shall be included in the contract unit price per Lump Sum for TRAFFIC CONTROL & PROTECTION (SPECIAL).

State of Illinois  
Department of Transportation  
Bureau of Local Roads and Streets

SPECIAL PROVISION  
FOR  
INSURANCE

Effective: February 1, 2007  
Revised: August 1, 2007

All references to Sections or Articles in this specification shall be construed to mean specific Section or Article of the Standard Specifications for Road and Bridge Construction, adopted by the Department of Transportation.

The Contractor shall name the following entities as additional insured under the Contractor's general liability insurance policy in accordance with Article 107.27:

---

---

---

---

---

---

---

---

The entities listed above and their officers, employees, and agents shall be indemnified and held harmless in accordance with Article 107.26.

State of Illinois  
Department of Transportation  
Bureau of Local Roads and Streets  
SPECIAL PROVISION  
FOR  
CONSTRUCTION AND MAINTENANCE SIGNS

Effective: January 1, 2004  
Revised: June 1, 2007

All references to Sections or Articles in this specification shall be construed to mean a specific Section or Article of the Standard Specifications for Road and Bridge Construction, adopted by the Department of Transportation.

701.14. Signs. Add the following paragraph to Article 701.14:

All warning signs shall have minimum dimensions of 1200 mm x 1200 mm (48" x 48") and have a black legend on a fluorescent orange reflectorized background, meeting, as a minimum, Type AP reflectivity requirements of Table 1091-2 in Article 1091.02.



State of Illinois  
DEPARTMENT OF TRANSPORTATION  
Bureau of Local Roads & Streets

SPECIAL PROVISION  
FOR  
GROWTH CURVE

Effective: March 1, 2008  
Revised: December 13, 2021

All references to Sections and Articles in this Special Provision shall be construed to mean specific Sections and Articles in the Standard Specifications for Road and Bridge Construction adopted by the Department of Transportation.

The Contractor shall perform a growth curve at the beginning of placement of each type of mix and each lift. The growth curve for each type of mix and each lift shall be performed within the first 200 tons (180 metric tons). If an adjustment is made to the specific mix design, the Engineer reserves the right to request an additional growth curve and supporting tests at the Contractor's expense.

Compaction of the growth curve shall commence immediately after the course is placed and at a temperature of not less than 280 °F (140 °C). The growth curve, consisting of a plot of lb/cu ft (kg/cu m) vs. number of passes with the project breakdown roller, shall be developed. Roller speed during the growth curve testing shall be the same as the normal paving operation. This curve shall be established by use of a nuclear gauge. Tests shall be taken after each pass until the highest lb/cu ft (kg/cu m) is obtained. This value shall be the target density provided the HMA Gyratory air voids are within acceptable limits. If the HMA Gyratory air voids are not within the specified limits, corrective action shall be taken, and a new target density shall be established.

A new growth curve is required if the breakdown roller used on the growth curve is replaced with a new roller during production. The target density shall apply only to the specific gauge used. If additional gauges are to be used to determine density specification compliance, the Contractor shall establish a unique minimum allowable target density from the growth curve location for each gauge.

At least one core sample per day shall be taken at a location specified by the Engineer. Core densities will be determined using the Illinois-Modified AASHTO T 166 or T 275 procedure by the Department. The core density shall be according to Articles 1030.09(c). Any required corrective action for testing using nuclear density testing shall be according to Article 1030.09(f). The QA Manager is responsible for assuring and documenting that the determined number of rollerpasses has been accomplished. The Engineer reserves the right to take core samples at any time to verify density from the nuclear gauge.

All lifts and confined longitudinal joint edges shall be compacted to an average nuclear gauge density of not less than 95 percent nor greater than 102 percent of the target density obtained on the growth curve. Unconfined longitudinal joint edges shall be compacted to an average nuclear gauge density of not less than 93 percent nor greater than 102 percent of the target density obtained on the growth curve. The average nuclear gauge density shall be based on tests representing one day's production.

Quality Control density tests shall be performed at randomly selected locations within 1/2 mile (800 m) intervals per lift per lane. In no case shall more than one half day's production be completed without density testing being performed. Longitudinal joint density testing shall be performed at each random density test location. Longitudinal joint testing shall be located at a distance equal to the lift thickness or a minimum of 2 in. (50 mm) from each pavement edge.

If the Contractor is not controlling the compaction process and is making no effort to take corrective action, the operation shall stop as directed by the Engineer.

State of Illinois  
 DEPARTMENT OF TRANSPORTATION  
 Bureau of Local Roads & Streets  
 SPECIAL PROVISION  
 FOR  
 LOCAL QUALITY ASSURANCE/ QUALITY MANAGEMENT QC/QA  
 Effective: January 1, 2022

Replace the first five paragraphs of Article 1030.06 of the Standard Specifications with the following:

**“1030.06 Quality Management Program.** The Quality Management Program (QMP) will be Quality Control / Quality Assurance (QC/QA) according to the following.”

Delete Article 1030.06(d)(1) of the Standard Specifications.

Revise Article 1030.09(g)(3) of the Standard Specifications to read:

“(3) If core testing is the density verification method, the Contractor shall provide personnel and equipment to collect density verification cores for the Engineer. Core locations will be determined by the Engineer following the document “Hot-Mix Asphalt QC/QA Procedure for Determining Random Density Locations” at density verification intervals defined in Article 1030.09(b). After the Engineer identifies a density verification location and prior to opening to traffic, the Contractor shall cut a 4 in. (100 mm) diameter core. With the approval of the Engineer, the cores may be cut at a later time.”

Revise Article 1030.09(h)(2) of the Standard Specifications to read:

“(2) After final rolling and prior to paving subsequent lifts, the Engineer will identify the random density verification test locations. Cores or nuclear density gauge testing will be used for density verification. The method used for density verification will be as selected below.

Density Verification Method	
<input type="checkbox"/>	Cores
<input checked="" type="checkbox"/>	Nuclear Density Gauge (Correlated when paving ≥ 3,000 tons per mixture)

Density verification test locations will be determined according to the document “Hot-Mix Asphalt QC/QA Procedure for Determining Random Density Locations”. The density testing interval for paving wider than or equal to 3 ft (1 m) will be 0.5 miles (800 m) for lift thicknesses of 3 in. (75 mm) or less and 0.2 miles (320 m) for lift thicknesses greater than 3 in. (75 mm). The density testing interval for paving less than 3 ft (1 m) wide will be 1 mile (1,600 m). If a day’s paving will be less than the prescribed density testing interval, the length of the day’s paving will be the interval for that day. The density testing interval for mixtures used for patching will be 50 patches with a minimum of one test per mixture per project.

If core testing is the density verification method, the Engineer will witness the Contractor coring, and secure and take possession of all density samples at the

density verification locations. The Engineer will test the cores collected by the Contractor for density according to Illinois Modified AASHTO T 166 or AASHTO T 275.

If nuclear density gauge testing is the density verification method, the Engineer will conduct nuclear density gauge tests. The Engineer will follow the density testing procedure detailed in the document "Illinois Modified ASTM D 2950, Standard Test Method for Density of Bituminous Concrete In-Place by Nuclear Method".

A density verification test will be the result of a single core or the average of the nuclear density tests at one location. The results of each density test must be within acceptable limits. The Engineer will promptly notify the Contractor of observed deficiencies."

Revise the seventh paragraph and all subsequent paragraphs in Section D. of the document "Hot-Mix Asphalt QC/QA Initial Daily Plant and Random Samples" to read:

"Mixtures shall be sampled from the truck at the plant by the Contractor following the same procedure used to collect QC mixture samples (Section A). This process will be witnessed by the Engineer who will take custody of the verification sample. Each sample bag with a verification mixture sample will be secured by the Engineer using a locking ID tag. Sample boxes containing the verification mixture sample will be sealed/taped by the Engineer using a security ID label."

## **AUTOMATED FLAGGER ASSISTANCE DEVICES (BDE)**

Effective: January 1, 2008

Description. This work shall consist of furnishing and operating automated flagger assistance devices (AFADs) as part of the work zone traffic control and protection for two-lane highways where two-way traffic is maintained over one lane of pavement. Use of these devices shall be at the option of the Contractor.

Equipment. AFADs shall be according to the FHWA memorandum, "MUTCD - Revised Interim Approval for the use of Automated Flagger Assistance Devices in Temporary Traffic Control Zones (IA-4R)", dated January 28, 2005. The devices shall be mounted on a trailer or a moveable cart and shall meet the requirements of NCHRP 350, Category 4.

The AFAD shall be the Stop/Slow type. This device uses remotely controlled "STOP" and "SLOW" signs to alternately control right-of-way.

Signs for the AFAD shall be according to Article 701.03 of the Standard Specifications and the MUTCD. The signs shall be 24 x 24 in. (600 x 600 mm) having an octagon shaped "STOP" sign on one side and a diamond shaped "SLOW" sign on the opposite side. The letters on the signs shall be 8 in. (200 mm) high. If the "STOP" sign has louvers, the full sign face shall be visible at a distance of 50 ft (15 m) and greater.

The signs shall be supplemented with one of the following types of lights.

- (a) Flashing Lights. When flashing lights are used, white or red flashing lights shall be mounted within the "STOP" sign face and white or yellow flashing lights within the "SLOW" sign face.
- (b) Stop and Warning Beacons. When beacons are used, a stop beacon shall be mounted 24 in. (600 mm) or less above the "STOP" sign face and a warning beacon mounted 24 in. (600 mm) or less above, below, or to the side of the "SLOW" sign face. As an option, a Type B warning light may be used in lieu of the warning beacon.

A "WAIT ON STOP" sign shall be placed on the right hand side of the roadway at a point where drivers are expected to stop. The sign shall be 24 x 30 in. (600 x 750 mm) with a black legend and border on a white background. The letters shall be at least 6 in. (150 mm) high.

This device may include a gate arm or mast arm that descends to a horizontal position when the "STOP" sign is displayed and rises to a vertical position when the "SLOW" sign is displayed. When included, the end of the arm shall reach at least to the center of the lane being controlled. The arm shall have alternating red and white retroreflective stripes, on both sides, sloping downward at 45 degrees toward the side on which traffic will pass. The stripes shall be 6 in. (150 mm) in width and at least 2 in. (50 mm) in height.

Flagging Requirements. Flaggers and flagging requirements shall be according to Article 701.13 of the Standard Specifications and the following.

AFADs shall be placed at each end of the traffic control, where a flagger is shown on the plans. The flaggers shall be able to view the face of the AFAD and approaching traffic during operation.

To stop traffic, the "STOP" sign shall be displayed, the corresponding lights/beacon shall flash, and when included, the gate arm shall descend to a horizontal position. To permit traffic to move, the "SLOW" sign shall be displayed, the corresponding lights/beacon shall flash, and when included, the gate arm shall rise to a vertical position.

If used at night, the AFAD location shall be illuminated according to Section 701 of the Standard Specifications.

When not in use, AFADs will be considered nonoperating equipment and shall be stored according to Article 701.11 of the Standard Specifications.

Basis of Payment. This work will not be paid for separately but shall be considered as included in the cost of the various traffic control items included in the contract.

80192

## COMPENSABLE DELAY COSTS (BDE)

Effective: June 2, 2017

Revised: April 1, 2019

Revise Article 107.40(b) of the Standard Specifications to read:

“(b) Compensation. Compensation will not be allowed for delays, inconveniences, or damages sustained by the Contractor from conflicts with facilities not meeting the above definition; or if a conflict with a utility in an unanticipated location does not cause a shutdown of the work or a documentable reduction in the rate of progress exceeding the limits set herein. The provisions of Article 104.03 notwithstanding, compensation for delays caused by a utility in an unanticipated location will be paid according to the provisions of this Article governing minor and major delays or reduced rate of production which are defined as follows.

- (1) Minor Delay. A minor delay occurs when the work in conflict with the utility in an unanticipated location is completely stopped for more than two hours, but not to exceed two weeks.
- (2) Major Delay. A major delay occurs when the work in conflict with the utility in an unanticipated location is completely stopped for more than two weeks.
- (3) Reduced Rate of Production Delay. A reduced rate of production delay occurs when the rate of production on the work in conflict with the utility in an unanticipated location decreases by more than 25 percent and lasts longer than seven calendar days.”

Revise Article 107.40(c) of the Standard Specifications to read:

“(c) Payment. Payment for Minor, Major, and Reduced Rate of Production Delays will be made as follows.

- (1) Minor Delay. Labor idled which cannot be used on other work will be paid for according to Article 109.04(b)(1) and (2) for the time between start of the delay and the minimum remaining hours in the work shift required by the prevailing practice in the area.

Equipment idled which cannot be used on other work, and which is authorized to standby on the project site by the Engineer, will be paid for according to Article 109.04(b)(4).

- (2) Major Delay. Labor will be the same as for a minor delay.

Equipment will be the same as for a minor delay, except Contractor-owned equipment will be limited to two weeks plus the cost of move-out to either the

Contractor's yard or another job and the cost to re-mobilize, whichever is less. Rental equipment may be paid for longer than two weeks provided the Contractor presents adequate support to the Department (including lease agreement) to show retaining equipment on the job is the most economical course to follow and in the public interest.

- (3) Reduced Rate of Production Delay. The Contractor will be compensated for the reduced productivity for labor and equipment time in excess of the 25 percent threshold for that portion of the delay in excess of seven calendar days. Determination of compensation will be in accordance with Article 104.02, except labor and material additives will not be permitted.

Payment for escalated material costs, escalated labor costs, extended project overhead, and extended traffic control will be determined according to Article 109.13.”

Revise Article 108.04(b) of the Standard Specifications to read:

“(b) No working day will be charged under the following conditions.

- (1) When adverse weather prevents work on the controlling item.
- (2) When job conditions due to recent weather prevent work on the controlling item.
- (3) When conduct or lack of conduct by the Department or its consultants, representatives, officers, agents, or employees; delay by the Department in making the site available; or delay in furnishing any items required to be furnished to the Contractor by the Department prevents work on the controlling item.
- (4) When delays caused by utility or railroad adjustments prevent work on the controlling item.
- (5) When strikes, lock-outs, extraordinary delays in transportation, or inability to procure critical materials prevent work on the controlling item, as long as these delays are not due to any fault of the Contractor.
- (6) When any condition over which the Contractor has no control prevents work on the controlling item.”

Revise Article 109.09(f) of the Standard Specifications to read:

“(f) Basis of Payment. After resolution of a claim in favor of the Contractor, any adjustment in time required for the work will be made according to Section 108. Any adjustment in the costs to be paid will be made for direct labor, direct materials, direct equipment, direct jobsite overhead, direct offsite overhead, and other direct costs allowed by the resolution. Adjustments in costs will not be made for interest charges, loss of anticipated profit, undocumented loss of efficiency, home office overhead and unabsorbed overhead



other than as allowed by Article 109.13, lost opportunity, preparation of claim expenses and other consequential indirect costs regardless of method of calculation.

The above Basis of Payment is an essential element of the contract and the claim cost recovery of the Contractor shall be so limited.”

Add the following to Section 109 of the Standard Specifications.

**“109.13 Payment for Contract Delay.** Compensation for escalated material costs, escalated labor costs, extended project overhead, and extended traffic control will be allowed when such costs result from a delay meeting the criteria in the following table.

Contract Type	Cause of Delay	Length of Delay
Working Days	Article 108.04(b)(3) or Article 108.04(b)(4)	No working days have been charged for two consecutive weeks.
Completion Date	Article 108.08(b)(1) or Article 108.08(b)(7)	The Contractor has been granted a minimum two week extension of contract time, according to Article 108.08.

Payment for each of the various costs will be according to the following.

- (a) Escalated Material and/or Labor Costs. When the delay causes work, which would have otherwise been completed, to be done after material and/or labor costs have increased, such increases will be paid. Payment for escalated material costs will be limited to the increased costs substantiated by documentation furnished by the Contractor. Payment for escalated labor costs will be limited to those items in Article 109.04(b)(1) and (2), except the 35 percent and 10 percent additives will not be permitted.
- (b) Extended Project Overhead. For the duration of the delay, payment for extended project overhead will be paid as follows.
  - (1) Direct Jobsite and Offsite Overhead. Payment for documented direct jobsite overhead and documented direct offsite overhead, including onsite supervisory and administrative personnel, will be allowed according to the following table.

Original Contract Amount	Supervisory and Administrative Personnel
Up to \$5,000,000	One Project Superintendent
Over \$ 5,000,000 - up to \$25,000,000	One Project Manager, One Project Superintendent or Engineer, and One Clerk
Over \$25,000,000 - up to \$50,000,000	One Project Manager, One Project Superintendent, One Engineer, and

	One Clerk
Over \$50,000,000	One Project Manager, Two Project Superintendents, One Engineer, and One Clerk

(2) Home Office and Unabsorbed Overhead. Payment for home office and unabsorbed overhead will be calculated as 8 percent of the total delay cost.

(c) Extended Traffic Control. Traffic control required for an extended period of time due to the delay will be paid for according to Article 109.04.

When an extended traffic control adjustment is paid under this provision, an adjusted unit price as provided for in Article 701.20(a) for increase or decrease in the value of work by more than ten percent will not be paid.

Upon payment for a contract delay under this provision, the Contractor shall assign subrogation rights to the Department for the Department's efforts of recovery from any other party for monies paid by the Department as a result of any claim under this provision. The Contractor shall fully cooperate with the Department in its efforts to recover from another party any money paid to the Contractor for delay damages under this provision."

80384

## **DISADVANTAGED BUSINESS ENTERPRISE PARTICIPATION (BDE)**

Effective: September 1, 2000

Revised: March 2, 2019

**FEDERAL OBLIGATION.** The Department of Transportation, as a recipient of federal financial assistance, is required to take all necessary and reasonable steps to ensure nondiscrimination in the award and administration of contracts. Consequently, the federal regulatory provisions of 49 CFR Part 26 apply to this contract concerning the utilization of disadvantaged business enterprises. For the purposes of this Special Provision, a disadvantaged business enterprise (DBE) means a business certified by the Department in accordance with the requirements of 49 CFR Part 26 and listed in the Illinois Unified Certification Program (IL UCP) DBE Directory.

**STATE OBLIGATION.** This Special Provision will also be used by the Department to satisfy the requirements of the Business Enterprise for Minorities, Females, and Persons with Disabilities Act, 30 ILCS 575. When this Special Provision is used to satisfy state law requirements on 100 percent state-funded contracts, the federal government has no involvement in such contracts (not a federal-aid contract) and no responsibility to oversee the implementation of this Special Provision by the Department on those contracts. DBE participation on 100 percent state-funded contracts will not be credited toward fulfilling the Department's annual overall DBE goal required by the US Department of Transportation to comply with the federal DBE program requirements.

**CONTRACTOR ASSURANCE.** The Contractor makes the following assurance and agrees to include the assurance in each subcontract the Contractor signs with a subcontractor.

The Contractor, subrecipient, or subcontractor shall not discriminate on the basis of race, color, national origin, or sex in the performance of this contract. The Contractor shall carry out applicable requirements of 49 CFR Part 26 in the award and administration of contracts funded in whole or in part with federal or state funds. Failure by the Contractor to carry out these requirements is a material breach of this contract, which may result in the termination of this contract or such other remedy as the recipient deems appropriate, which may include, but is not limited to:

- (a) Withholding progress payments;
- (b) Assessing sanctions;
- (c) Liquidated damages; and/or
- (d) Disqualifying the Contractor from future bidding as non-responsible.

**OVERALL GOAL SET FOR THE DEPARTMENT.** As a requirement of compliance with 49 CFR Part 26, the Department has set an overall goal for DBE participation in its federally assisted contracts. That goal applies to all federal-aid funds the Department will expend in its federally assisted contracts for the subject reporting fiscal year. The Department is required to make a

good faith effort to achieve the overall goal. The dollar amount paid to all approved DBE companies performing work called for in this contract is eligible to be credited toward fulfillment of the Department's overall goal.

CONTRACT GOAL TO BE ACHIEVED BY THE CONTRACTOR. This contract includes a specific DBE utilization goal established by the Department. The goal has been included because the Department has determined the work of this contract has subcontracting opportunities that may be suitable for performance by DBE companies. The determination is based on an assessment of the type of work, the location of the work, and the availability of DBE companies to do a part of the work. The assessment indicates, in the absence of unlawful discrimination and in an arena of fair and open competition, DBE companies can be expected to perform 2.00 % of the work. This percentage is set as the DBE participation goal for this contract. Consequently, in addition to the other award criteria established for this contract, the Department will only award this contract to a bidder who makes a good faith effort to meet this goal of DBE participation in the performance of the work. A bidder makes a good faith effort for award consideration if either of the following is done in accordance with the procedures set for in this Special Provision:

- (a) The bidder documents enough DBE participation has been obtained to meet the goal or,
- (b) The bidder documents a good faith effort has been made to meet the goal, even though the effort did not succeed in obtaining enough DBE participation to meet the goal.

DBE LOCATOR REFERENCES. Bidders shall consult the IL UCP DBE Directory as a reference source for DBE-certified companies. In addition, the Department maintains a letting and item specific DBE locator information system whereby DBE companies can register their interest in providing quotes on particular bid items advertised for letting. Information concerning DBE companies willing to quote work for particular contracts may be obtained by contacting the Department's Bureau of Small Business Enterprises at telephone number (217) 785-4611, or by visiting the Department's website at:

<http://www.idot.illinois.gov/doing-business/certifications/disadvantaged-business-enterprise-certification/il-ucp-directory/index>.

BIDDING PROCEDURES. Compliance with this Special Provision is a material bidding requirement and failure of the bidder to comply will render the bid not responsive.

The bidder shall submit a DBE Utilization Plan (form SBE 2026), and a DBE Participation Statement (form SBE 2025) for each DBE company proposed for the performance of work to achieve the contract goal, with the bid. If the Utilization Plan indicates the contract goal will not be met, documentation of good faith efforts shall also be submitted. The documentation of good faith efforts must include copies of each DBE and non-DBE subcontractor quote submitted to the bidder when a non-DBE subcontractor is selected over a DBE for work on the contract. The required forms and documentation must be submitted as a single .pdf file using the "Integrated Contractor Exchange (iCX)" application within the Department's "EBids System".

The Department will not accept a Utilization Plan if it does not meet the bidding procedures set forth herein and the bid will be declared not responsive. In the event the bid is declared not responsive, the Department may elect to cause the forfeiture of the penal sum of the bidder's proposal guaranty and may deny authorization to bid the project if re-advertised for bids.

GOOD FAITH EFFORT PROCEDURES. The contract will not be awarded until the Utilization Plan is approved. All information submitted by the bidder must be complete, accurate and adequately document enough DBE participation has been obtained or document the good faith efforts of the bidder, in the event enough DBE participation has not been obtained, before the Department will commit to the performance of the contract by the bidder. The Utilization Plan will be approved by the Department if the Utilization Plan documents sufficient commercially useful DBE work to meet the contract goal or the bidder submits sufficient documentation of a good faith effort to meet the contract goal pursuant to 49 CFR Part 26, Appendix A. This means the bidder must show that all necessary and reasonable steps were taken to achieve the contract goal. Necessary and reasonable steps are those which, by their scope, intensity and appropriateness to the objective, could reasonably be expected to obtain sufficient DBE participation, even if they were not successful. The Department will consider the quality, quantity, and intensity of the kinds of efforts the bidder has made. Mere *pro forma* efforts, in other words efforts done as a matter of form, are not good faith efforts; rather, the bidder is expected to have taken genuine efforts that would be reasonably expected of a bidder actively and aggressively trying to obtain DBE participation sufficient to meet the contract goal.

- (a) The following is a list of types of action that the Department will consider as part of the evaluation of the bidder's good faith efforts to obtain participation. These listed factors are not intended to be a mandatory checklist and are not intended to be exhaustive. Other factors or efforts brought to the attention of the Department may be relevant in appropriate cases and will be considered by the Department.
  - (1) Soliciting through all reasonable and available means (e.g. attendance at pre-bid meetings, advertising and/or written notices) the interest of all certified DBE companies that have the capability to perform the work of the contract. The bidder must solicit this interest within sufficient time to allow the DBE companies to respond to the solicitation. The bidder must determine with certainty if the DBE companies are interested by taking appropriate steps to follow up initial solicitations.
  - (2) Selecting portions of the work to be performed by DBE companies in order to increase the likelihood that the DBE goals will be achieved. This includes, where appropriate, breaking out contract work items into economically feasible units to facilitate DBE participation, even when the Contractor might otherwise prefer to perform these work items with its own forces.
  - (3) Providing interested DBE companies with adequate information about the plans, specifications, and requirements of the contract in a timely manner to assist them in responding to a solicitation.

- (4) a. Negotiating in good faith with interested DBE companies. It is the bidder's responsibility to make a portion of the work available to DBE subcontractors and suppliers and to select those portions of the work or material needs consistent with the available DBE subcontractors and suppliers, so as to facilitate DBE participation. Evidence of such negotiation includes the names, addresses, and telephone numbers of DBE companies that were considered; a description of the information provided regarding the plans and specifications for the work selected for subcontracting; and evidence as to why additional agreements could not be reached for DBE companies to perform the work.
  - b. A bidder using good business judgment would consider a number of factors in negotiating with subcontractors, including DBE subcontractors, and would take a firm's price and capabilities as well as contract goals into consideration. However, the fact that there may be some additional costs involved in finding and using DBE companies is not in itself sufficient reason for a bidder's failure to meet the contract DBE goal, as long as such costs are reasonable. Also the ability or desire of a bidder to perform the work of a contract with its own organization does not relieve the bidder of the responsibility to make good faith efforts. Bidders are not, however, required to accept higher quotes from DBE companies if the price difference is excessive or unreasonable. In accordance with the above Bidding Procedures, the documentation of good faith efforts must include copies of each DBE and non-DBE subcontractor quote submitted to the bidder when a non-DBE subcontractor was selected over a DBE for work on the contract.
- (5) Not rejecting DBE companies as being unqualified without sound reasons based on a thorough investigation of their capabilities. The bidder's standing within its industry, membership in specific groups, organizations, or associations and political or social affiliations (for example union vs. non-union employee status) are not legitimate causes for the rejection or non-solicitation of bids in the bidder's efforts to meet the project goal.
  - (6) Making efforts to assist interested DBE companies in obtaining bonding, lines of credit, or insurance as required by the recipient or Contractor.
  - (7) Making efforts to assist interested DBE companies in obtaining necessary equipment, supplies, materials, or related assistance or services.
  - (8) Effectively using the services of available minority/women community organizations; minority/women contractors' groups; local, state, and federal minority/women business assistance offices; and other organizations as allowed on a case-by-case basis to provide assistance in the recruitment and placement of DBE companies.
- (b) If the Department determines the bidder has made a good faith effort to secure the work commitment of DBE companies to meet the contract goal, the Department will award the contract provided it is otherwise eligible for award. If the Department determines the

bidder has failed to meet the requirements of this Special Provision or that a good faith effort has not been made, the Department will notify the responsible company official designated in the Utilization Plan that the bid is not responsive. The notification will also include a statement of reasons for the adverse determination. If the Utilization Plan is not approved because it is deficient as a technical matter, unless waived by the Department, the bidder will be notified and will be allowed no more than a five calendar day period to cure the deficiency.

- (c) The bidder may request administrative reconsideration of an adverse determination by emailing the Department at "[DOT.DBE.UP@illinois.gov](mailto:DOT.DBE.UP@illinois.gov)" within the five calendar days after the receipt of the notification of the determination. The determination shall become final if a request is not made on or before the fifth calendar day. A request may provide additional written documentation or argument concerning the issues raised in the determination statement of reasons, provided the documentation and arguments address efforts made prior to submitting the bid. The request will be reviewed by the Department's Reconsideration Officer. The Reconsideration Officer will extend an opportunity to the bidder to meet in person to consider all issues of documentation and whether the bidder made a good faith effort to meet the goal. After the review by the Reconsideration Officer, the bidder will be sent a written decision within ten working days after receipt of the request for reconsideration, explaining the basis for finding that the bidder did or did not meet the goal or make adequate good faith efforts to do so. A final decision by the Reconsideration Officer that a good faith effort was made shall approve the Utilization Plan submitted by the bidder and shall clear the contract for award. A final decision that a good faith effort was not made shall render the bid not responsive.

**CALCULATING DBE PARTICIPATION.** The Utilization Plan values represent work anticipated to be performed and paid for upon satisfactory completion. The Department is only able to count toward the achievement of the overall goal and the contract goal the value of payments made for the work actually performed by DBE companies. In addition, a DBE must perform a commercially useful function on the contract to be counted. A commercially useful function is generally performed when the DBE is responsible for the work and is carrying out its responsibilities by actually performing, managing, and supervising the work involved. The Department and Contractor are governed by the provisions of 49 CFR Part 26.55(c) on questions of commercially useful functions as it affects the work. Specific counting guidelines are provided in 49 CFR Part 26.55, the provisions of which govern over the summary contained herein.

- (a) DBE as the Contractor: 100 percent goal credit for that portion of the work performed by the DBE's own forces, including the cost of materials and supplies. Work that a DBE subcontracts to a non-DBE does not count toward the DBE goals.
- (b) DBE as a joint venture Contractor: 100 percent goal credit for that portion of the total dollar value of the contract equal to the distinct, clearly defined portion of the work performed by the DBE's own forces.

- (c) DBE as a subcontractor: 100 percent goal credit for the work of the subcontract performed by the DBE's own forces, including the cost of materials and supplies, excluding the purchase of materials and supplies or the lease of equipment by the DBE subcontractor from the Contractor or its affiliates. Work that a DBE subcontractor in turn subcontracts to a non-DBE does not count toward the DBE goal.
- (d) DBE as a trucker: 100 percent goal credit for trucking participation provided the DBE is responsible for the management and supervision of the entire trucking operation for which it is responsible. At least one truck owned, operated, licensed, and insured by the DBE must be used on the contract. Credit will be given for the following:
  - (1) The DBE may lease trucks from another DBE firm, including an owner-operator who is certified as a DBE. The DBE who leases trucks from another DBE receives credit for the total value of the transportation services the lessee DBE provides on the contract.
  - (2) The DBE may also lease trucks from a non-DBE firm, including from an owner-operator. The DBE who leases trucks from a non-DBE is entitled to credit only for the fee or commission is receives as a result of the lease arrangement.
- (e) DBE as a material supplier:
  - (1) 60 percent goal credit for the cost of the materials or supplies purchased from a DBE regular dealer.
  - (2) 100 percent goal credit for the cost of materials of supplies obtained from a DBE manufacturer.
  - (3) 100 percent credit for the value of reasonable fees and commissions for the procurement of materials and supplies if not a DBE regular dealer or DBE manufacturer.

**CONTRACT COMPLIANCE.** Compliance with this Special Provision is an essential part of the contract. The Department is prohibited by federal regulations from crediting the participation of a DBE included in the Utilization Plan toward either the contract goal or the Department's overall goal until the amount to be applied toward the goals has been paid to the DBE. The following administrative procedures and remedies govern the compliance by the Contractor with the contractual obligations established by the Utilization Plan. After approval of the Utilization Plan and award of the contract, the Utilization Plan and individual DBE Participation Statements become part of the contract. If the Contractor did not succeed in obtaining enough DBE participation to achieve the advertised contract goal, and the Utilization Plan was approved and contract awarded based upon a determination of good faith, the total dollar value of DBE work calculated in the approved Utilization Plan as a percentage of the awarded contract value shall become the amended contract goal. All work indicated for performance by an approved DBE shall be performed, managed, and supervised by the DBE executing the DBE Participation Commitment Statement.



- (a) NO AMENDMENT. No amendment to the Utilization Plan may be made without prior written approval from the Department's Bureau of Small Business Enterprises. All requests for amendment to the Utilization Plan shall be emailed to the Department at [DOT.DBE.UP@illinois.gov](mailto:DOT.DBE.UP@illinois.gov).
- (b) CHANGES TO WORK. Any deviation from the DBE condition-of-award or contract plans, specifications, or special provisions must be approved, in writing, by the Department as provided elsewhere in the Contract. The Contractor shall notify affected DBEs in writing of any changes in the scope of work which result in a reduction in the dollar amount condition-of-award to the contract. Where the revision includes work committed to a new DBE subcontractor, not previously involved in the project, then a Request for Approval of Subcontractor, Department form BC 260A or AER 260A, must be signed and submitted. If the commitment of work is in the form of additional tasks assigned to an existing subcontract, a new Request for Approval of Subcontractor will not be required. However, the Contractor must document efforts to assure the existing DBE subcontractor is capable of performing the additional work and has agreed in writing to the change.
- (c) SUBCONTRACT. The Contractor must provide copies of DBE subcontracts to the Department upon request. Subcontractors shall ensure that all lower tier subcontracts or agreements with DBEs to supply labor or materials be performed in accordance with this Special Provision.
- (d) ALTERNATIVE WORK METHODS. In addition to the above requirements for reductions in the condition of award, additional requirements apply to the two cases of Contractor-initiated work substitution proposals. Where the contract allows alternate work methods which serve to delete or create underruns in condition of award DBE work, and the Contractor selects that alternate method or, where the Contractor proposes a substitute work method or material that serves to diminish or delete work committed to a DBE and replace it with other work, then the Contractor must demonstrate one of the following:
- (1) The replacement work will be performed by the same DBE (as long as the DBE is certified in the respective item of work) in a modification of the condition of award; or
  - (2) The DBE is aware its work will be deleted or will experience underruns and has agreed in writing to the change. If this occurs, the Contractor shall substitute other work of equivalent value to a certified DBE or provide documentation of good faith efforts to do so; or
  - (3) The DBE is not capable of performing the replacement work or has declined to perform the work at a reasonable competitive price. If this occurs, the Contractor shall substitute other work of equivalent value to a certified DBE or provide documentation of good faith efforts to do so.

- (e) TERMINATION AND REPLACEMENT PROCEDURES. The Contractor shall not terminate or replace a DBE listed on the approved Utilization Plan, or perform with other forces work designated for a listed DBE except as provided in this Special Provision. The Contractor shall utilize the specific DBEs listed to perform the work and supply the materials for which each is listed unless the Contractor obtains the Department's written consent as provided in subsection (a) of this part. Unless Department consent is provided for termination of a DBE subcontractor, the Contractor shall not be entitled to any payment for work or material unless it is performed or supplied by the DBE in the Utilization Plan.

As stated above, the Contractor shall not terminate or replace a DBE subcontractor listed in the approved Utilization Plan without prior written consent. This includes, but is not limited to, instances in which the Contractor seeks to perform work originally designated for a DBE subcontractor with its own forces or those of an affiliate, a non-DBE firm, or with another DBE firm. Written consent will be granted only if the Bureau of Small Business Enterprises agrees, for reasons stated in its concurrence document, that the Contractor has good cause to terminate or replace the DBE firm. Before transmitting to the Bureau of Small Business Enterprises any request to terminate and/or substitute a DBE subcontractor, the Contractor shall give notice in writing to the DBE subcontractor, with a copy to the Bureau, of its intent to request to terminate and/or substitute, and the reason for the request. The Contractor shall give the DBE five days to respond to the Contractor's notice. The DBE so notified shall advise the Bureau and the Contractor of the reasons, if any, why it objects to the proposed termination of its subcontract and why the Bureau should not approve the Contractor's action. If required in a particular case as a matter of public necessity, the Bureau may provide a response period shorter than five days.

For purposes of this paragraph, good cause includes the following circumstances:

- (1) The listed DBE subcontractor fails or refuses to execute a written contract;
- (2) The listed DBE subcontractor fails or refuses to perform the work of its subcontract in a way consistent with normal industry standards. Provided, however, that good cause does not exist if the failure or refusal of the DBE subcontractor to perform its work on the subcontract results from the bad faith or discriminatory action of the Contractor;
- (3) The listed DBE subcontractor fails or refuses to meet the Contractor's reasonable, nondiscriminatory bond requirements;
- (4) The listed DBE subcontractor becomes bankrupt, insolvent, or exhibits credit unworthiness;
- (5) The listed DBE subcontractor is ineligible to work on public works projects because of suspension and debarment proceedings pursuant 2 CFR Parts 180, 215 and 1200 or applicable state law.

- (6) The Contractor has determined the listed DBE subcontractor is not a responsible contractor;
- (7) The listed DBE subcontractor voluntarily withdraws from the projects and provides written notice to the Contractor of its withdrawal;
- (8) The listed DBE is ineligible to receive DBE credit for the type of work required;
- (9) A DBE owner dies or becomes disabled with the result that the listed DBE subcontractor is unable to complete its work on the contract;
- (10) Other documented good cause that compels the termination of the DBE subcontractor. Provided, that good cause does not exist if the Contractor seeks to terminate a DBE it relied upon to obtain the contract so that the Contractor can self-perform the work for which the DBE contractor was engaged or so that the Contractor can substitute another DBE or non-DBE contractor after contract award.

When a DBE is terminated or fails to complete its work on the Contract for any reason, the Contractor shall make a good faith effort to find another DBE to substitute for the original DBE to perform at least the same amount of work under the contract as the terminated DBE to the extent needed to meet the established Contract goal. The good faith efforts shall be documented by the Contractor. If the Department requests documentation under this provision, the Contractor shall submit the documentation within seven days, which may be extended for an additional seven days if necessary at the request of the Contractor. The Department will provide a written determination to the Contractor stating whether or not good faith efforts have been demonstrated.

- (f) FINAL PAYMENT. After the performance of the final item of work or delivery of material by a DBE and final payment therefore to the DBE by the Contractor, but not later than 30 calendar days after payment has been made by the Department to the Contractor for such work or material, the Contractor shall submit a DBE Payment Agreement on Department form SBE 2115 to the Resident Engineer. If full and final payment has not been made to the DBE, the DBE Payment Agreement shall indicate whether a disagreement as to the payment required exists between the Contractor and the DBE or if the Contractor believes the work has not been satisfactorily completed. If the Contractor does not have the full amount of work indicated in the Utilization Plan performed by the DBE companies indicated in the Utilization Plan and after good faith efforts are reviewed, the Department may deduct from contract payments to the Contractor the amount of the goal not achieved as liquidated and ascertained damages. The Contractor may request an administrative reconsideration of any amount deducted as damages pursuant to subsection (h) of this part.
- (g) ENFORCEMENT. The Department reserves the right to withhold payment to the Contractor to enforce the provisions of this Special Provision. Final payment shall not be

made on the contract until such time as the Contractor submits sufficient documentation demonstrating achievement of the goal in accordance with this Special Provision or after liquidated damages have been determined and collected.

- (h) RECONSIDERATION. Notwithstanding any other provision of the contract, including but not limited to Article 109.09 of the Standard Specifications, the Contractor may request administrative reconsideration of a decision to deduct the amount of the goal not achieved as liquidated damages. A request to reconsider shall be delivered to the Contract Compliance Section and shall be handled and considered in the same manner as set forth in paragraph (c) of "Good Faith Effort Procedures" of this Special Provision, except a final decision that a good faith effort was not made during contract performance to achieve the goal agreed to in the Utilization Plan shall be the final administrative decision of the Department. The result of the reconsideration process is not administratively appealable to the U.S. Department of Transportation.

80029

## **HOT-MIX ASPHALT – START OF PRODUCTION (BDE)**

Effective: January 1, 2022

Add the following paragraph between the third and four paragraphs of Article 1030.10 of the Standard Specifications:

“When a test strip is not required, each HMA mixture with a quantity of 3,000 tons (2,750 metric tons) or more shall still be sampled on the first day of production: I-FIT and Hamburg wheel testing for High ESAL; I-FIT testing for Low ESAL. Within two working days after sampling the mixture, the Contractor shall deliver gyratory cylinders to the District laboratory for Department verification testing. The High ESAL mixture test results shall meet the requirements of Articles 1030.05(d)(3) and 1030.05(d)(4). The Low ESAL mixture test results shall meet the requirements of Article 1030.05(d)(4).”

80442

## **SUBCONTRACTOR AND DBE PAYMENT REPORTING (BDE)**

Effective: April 2, 2018

Add the following to Section 109 of the Standard Specifications.

**“109.14 Subcontractor and Disadvantaged Business Enterprise Payment Reporting.**  
The Contractor shall report all payments made to the following parties:

- (a) first tier subcontractors;
- (b) lower tier subcontractors affecting disadvantaged business enterprise (DBE) goal credit;
- (c) material suppliers or trucking firms that are part of the Contractor’s submitted DBE utilization plan.

The report shall be made through the Department’s on-line subcontractor payment reporting system within 21 days of making the payment.”

80397

## **SUBCONTRACTOR MOBILIZATION PAYMENTS (BDE)**

Effective: November 2, 2017

Revised: April 1, 2019

Replace the second paragraph of Article 109.12 of the Standard Specifications with the following:

“This mobilization payment shall be made at least seven days prior to the subcontractor starting work. The amount paid shall be at the following percentage of the amount of the subcontract reported on form BC 260A submitted for the approval of the subcontractor’s work.

Value of Subcontract Reported on Form BC 260A	Mobilization Percentage
Less than \$10,000	25%
\$10,000 to less than \$20,000	20%
\$20,000 to less than \$40,000	18%
\$40,000 to less than \$60,000	16%
\$60,000 to less than \$80,000	14%
\$80,000 to less than \$100,000	12%
\$100,000 to less than \$250,000	10%
\$250,000 to less than \$500,000	9%
\$500,000 to \$750,000	8%
Over \$750,000	7%”

80391

## **VEHICLE AND EQUIPMENT WARNING LIGHTS (BDE)**

Effective: November 1, 2021

Add the following paragraph after the first paragraph of Article 701.08 of the Standard Specifications:

“The Contractor shall equip all vehicles and equipment with high-intensity oscillating, rotating, or flashing, amber or amber-and-white, warning lights which are visible from all directions. The lights shall be in operation while the vehicle or equipment is engaged in construction operations.”

80439



## **WEEKLY DBE TRUCKING REPORTS (BDE)**

Effective: June 2, 2012

Revised: November 1, 2021

The Contractor shall submit a weekly report of Disadvantaged Business Enterprise (DBE) trucks hired by the Contractor or subcontractors (i.e. not owned by the Contractor or subcontractors) that are used for DBE goal credit.

The report shall be submitted to the Engineer on Department form "SBE 723" within ten business days following the reporting period. The reporting period shall be Sunday through Saturday for each week reportable trucking activities occur.

Any costs associated with providing weekly DBE trucking reports shall be considered as included in the contract unit prices bid for the various items of work involved and no additional compensation will be allowed.

80302

## WORK ZONE TRAFFIC CONTROL DEVICES (BDE)

Effective: March 2, 2020

Add the following to Article 701.03 of the Standard Specifications:

“(q) Temporary Sign Supports ..... 1106.02”

Revise the third paragraph of Article 701.14 of the Standard Specifications to read:

“For temporary sign supports, the Contractor shall provide a FHWA eligibility letter for each device used on the contract. The letter shall provide information for the set-up and use of the device as well as a detailed drawing of the device. The signs shall be supported within 20 degrees of vertical. Weights used to stabilize signs shall be attached to the sign support per the manufacturer’s specifications.”

Revise the first paragraph of Article 701.15 of the Standard Specifications to read:

“**701.15 Traffic Control Devices.** For devices that must meet crashworthiness standards, the Contractor shall provide a manufacturer’s self-certification or a FHWA eligibility letter for each Category 1 device and a FHWA eligibility letter for each Category 2 and Category 3 device used on the contract. The self-certification or letter shall provide information for the set-up and use of the device as well as a detailed drawing of the device.”

Revise the first six paragraphs of Article 1106.02 of the Standard Specifications to read:

“**1106.02 Devices.** Work zone traffic control devices and combinations of devices shall meet crashworthiness standards for their respective categories. The categories are as follows.

Category 1 includes small, lightweight, channelizing and delineating devices that have been in common use for many years and are known to be crashworthy by crash testing of similar devices or years of demonstrable safe performance. These include cones, tubular markers, plastic drums, and delineators, with no attachments (e.g. lights). Category 1 devices manufactured after December 31, 2019 shall be MASH-16 compliant. Category 1 devices manufactured on or before December 31, 2019, and compliant with NCHRP 350 or MASH 2009, may be used on contracts let before December 31, 2024.

Category 2 includes devices that are not expected to produce significant vehicular velocity change but may otherwise be hazardous. These include vertical panels with lights, barricades, temporary sign supports, and Category 1 devices with attachments (e.g. drums with lights). Category 2 devices manufactured after December 31, 2019 shall be MASH-16 compliant. Category 2 devices manufactured on or before December 31, 2019, and compliant with NCHRP 350 or MASH 2009, may be used on contracts let before December 31, 2024.

Category 3 includes devices that are expected to cause significant velocity changes or other potentially harmful reactions to impacting vehicles. These include crash cushions (impact

attenuators), truck mounted attenuators, and other devices not meeting the definitions of Category 1 or 2. Category 3 devices manufactured after December 31, 2019 shall be MASH-16 compliant. Category 3 devices manufactured on or before December 31, 2019, and compliant with NCHRP 350 or MASH 2009, may be used on contracts let before December 31, 2029. Category 3 devices shall be crash tested for Test Level 3 or the test level specified.

Category 4 includes portable or trailer-mounted devices such as arrow boards, changeable message signs, temporary traffic signals, and area lighting supports. It is preferable for Category 4 devices manufactured after December 31, 2019 to be MASH-16 compliant; however, there are currently no crash tested devices in this category, so it remains exempt from the NCHRP 350 or MASH compliance requirement.

For each type of device, when no more than one MASH-16 compliant is available, an NCHRP 350 or MASH-2009 compliant device may be used, even if manufactured after December 31, 2019.”

Revise Articles 1106.02(g), 1106.02(k), and 1106.02(l) to read:

“(g) Truck Mounted/Trailer Mounted Attenuators. The attenuator shall be approved for use at Test Level 3. Test Level 2 may be used for normal posted speeds less than or equal to 45 mph.

(k) Temporary Water Filled Barrier. The water filled barrier shall be a lightweight plastic shell designed to accept water ballast and be on the Department’s qualified product list.

Shop drawings shall be furnished by the manufacturer and shall indicate the deflection of the barrier as determined by acceptance testing; the configuration of the barrier in that test; and the vehicle weight, velocity, and angle of impact of the deflection test. The Engineer shall be provided one copy of the shop drawings.

(l) Movable Traffic Barrier. The movable traffic barrier shall be on the Department’s qualified product list.

Shop drawings shall be furnished by the manufacturer and shall indicate the deflection of the barrier as determined by acceptance testing; the configuration of the barrier in that test; and the vehicle weight, velocity, and angle of impact of the deflection test. The Engineer shall be provided one copy of the shop drawings. The barrier shall be capable of being moved on and off the roadway on a daily basis.”

80427

**WORKING DAYS (BDE)**

Effective: January 1, 2002

The Contractor shall complete the work within 15 working days.

80071

FAS 86 (Mt. Morris Road)  
Sec. 17-00318-00-RS  
Ogle County  
Project No. PMX4 (730)  
Contract No. 85714

APPROVED DECEMBER 8, 20 21

[Signature]  
LOCAL AGENCY OFFICIAL

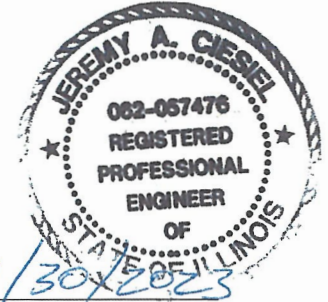

11/30/2023  
Expires:

PASSED 12/9, 20 21

[Signature]  
ENGINEER OF LOCAL ROADS & STREETS

RELEASED FOR  
BID BASED ON  
LIMITED REVIEW 12/9, 20 21

[Signature]  
DEPUTY DIRECTOR OF HIGHWAYS,  
REGION 2 ENGINEER

STATE OF ILLINOIS  
DEPARTMENT OF TRANSPORTATION

FEDERAL AID PROJECT

F.A.S. ROUTE 86  
SECTION 17-00318-00-RS

PROJECT NO. PMX4 (730)

OGLE COUNTY

JOB NO. C-92-030-20

CONTRACT NO. 85714

INDEX TO SHEETS

1	Signature Sheet
2	Title Sheet
3	Location Map
4	Summary of Quantities
5-6	Schedule of Quantities
7	Bituminous Schedule
8	Driveway & Side Road Schedule
9	Typical Section
10	Side Road Detail
11-12	Entrance Details
13-14	Joint Details
15	Standard 701006-05
16	Standard 701301-04
17	Standard 701306-04
18	Standard 701311-03
19-21	Standard 701901-08
22	Standard 720011-01
23	Standard 728001-01
24	Standard 729001-01
25-27	Standard 780001-05
28	Standard B.L.R. 24-2

FAS 86, Mt. Morris Road

Municipal Limits of Mt. Morris to IL Route 72

ADT: 1700-1500-1400 (S-N);  
7% S.U.; 5% M.U. Trucks

Rural Major Collector



**Location & Functional Classification Map**  
**Mt. Morris Road, FAS 86**  
**17-00318-00-RS**  
**Project Number: PMX4 (730)**  
**Near Village of Mt. Morris**  
**Ogle County, IL**  
**Net Length: 23,776.7 ft (4.503 mi)**

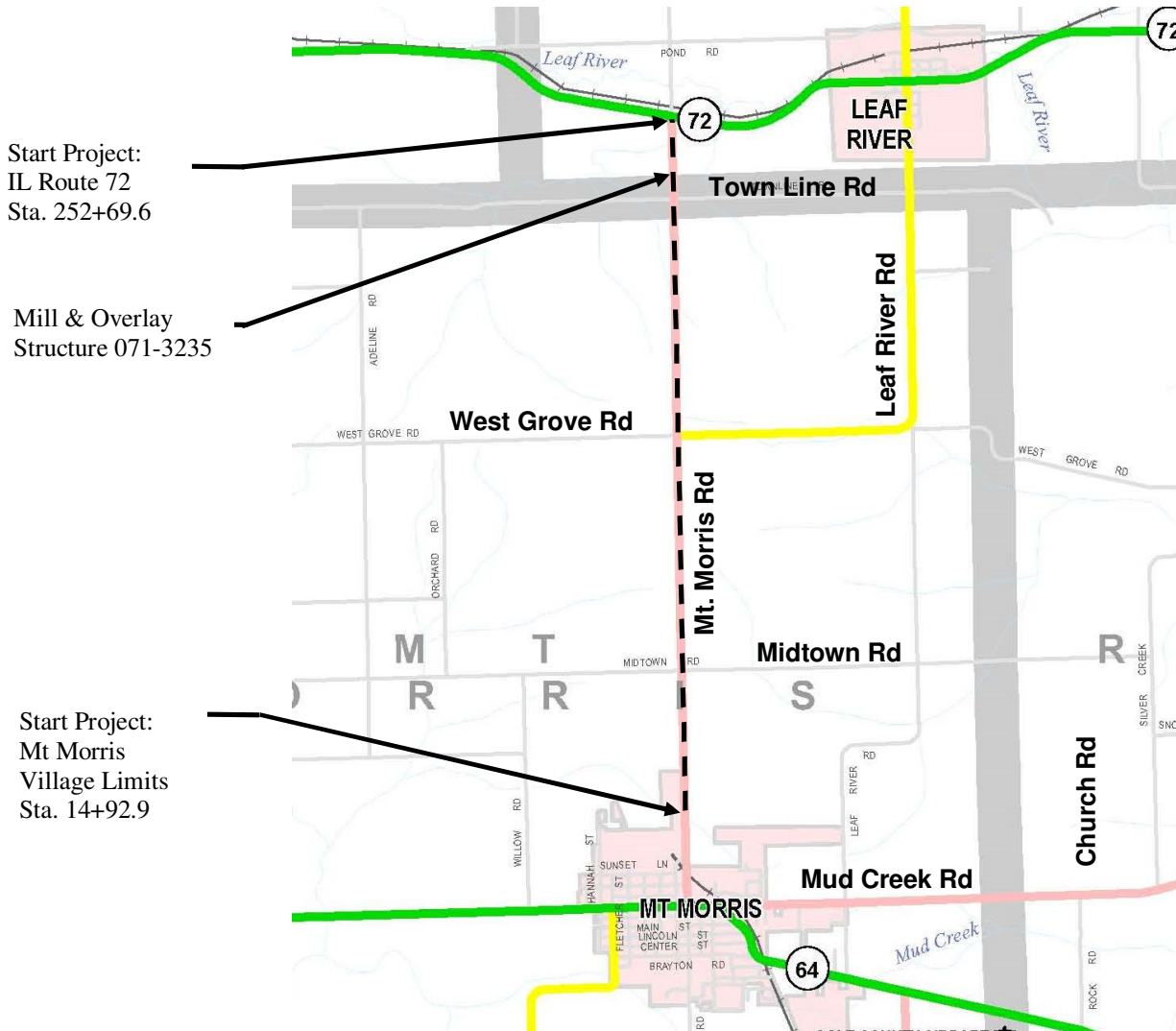

T24N & T25N, R09E of the 4<sup>th</sup> P.M

5-Year Classification	
1 Interstate	Interstate, U.S., State
2 Freeway or Expressway	Railroad
3 Other Principal Arterial	State Boundary
4 Minor Arterial	County Boundary
5 Major Collector	Urban Boundary
6 Minor Collector	River, Streams
7 Local Road or Street	Lakes
	Civil Township or District

FUNCTIONAL CLASSIFICATION AND URBAN LIMIT DATA AS OF DATE: 9/14/2015  
 DATE OF FEDERAL HIGHWAY ADMINISTRATION APPROVAL: 5/28/2014



**SUMMARY OF QUANTITIES**  
 Construction Type Code: 0005

Code	Item	Unit	Quantity
Number			
40600275	Bituminous Materials (Prime Coat)	<i>POUND</i>	17628
40600290	Bituminous Materials (Tack Coat)	<i>POUND</i>	36379
40600982	Hot-Mix Asphalt Surface Removal - Butt Joint	SY	4071
40600990	Temporary Ramp	SY	53
• X4823105	Hot-Mix Asphalt Shoulder, Special	TON	1497
40604050	Hot-Mix Asphalt Surface Course, IL-9.5, Mix C, N50	TON	6905
40800050	Incidental Hot-Mix Asphalt Surfacing	TON	154
67100100	Mobilization	<i>L SUM</i>	1
X7010216	Traffic Control & Protection (Special)	<i>L SUM</i>	1
70300100	Short Term Pavement Marking	FT	2378
△ 78009004	Modified Urethane Pavement Marking, Line 4"	FT	68980

△ *SPECIALTY ITEMS*



SCHEDULE OF QUANTITIES

**40600982 HOT-MIX ASPHALT SURFACE REMOVAL - BUTT JOINT**

LOCATION	REMARK	SQ. YD.
<b>MAINLINE JOINTS</b>		
STA. 14+92.9 - 15+32.9	South end of Project, Village Limits	111.6
STA 23+66.1 - 26+90.4	5' Shoulder along Gutter	178.2
STA 45+55.1 - 48+24.5	5' Shoulder along Gutter	146.9
STA 46+01.2 - 48+75.5	5' Shoulder along Gutter	130.7
STA 67+25.0 - 70+21.8	5' Shoulder along Gutter	166.7
STA 80+39.5 - 87+13.2	5' Shoulder along Gutter	372.7
STA 93+36.2 - 95+75.5	5' Shoulder along Gutter	131.4
STA 104+64.3 - 108+83.0	5' Shoulder along Gutter	230.8
STA 136+65.4 - 141+24.7	5' Shoulder along Gutter	253.7
STA 153+65.8 - 156+80.1	5' Shoulder along Gutter	173.0
STA 164+08.1 - 173+56.7	5' Shoulder along Gutter	525.4
STA 189+69.7 - 193+24.1	5' Shoulder along Gutter	195.3
STA 222+78.2 - 225+74.6	5' Shoulder along Gutter	169.8
STA 229+91.7 - 233+01.0	5' Shoulder along Gutter	170.0
STA 236+80.4 - 241+84.7	4' Shoulder along Gutter	223.2
STA. 244+31.5 - 245+82.6	Structure No. 071-3235	418.4
STA. 252+29.6 - 252+69.6	North end of project, IL Route 72	203.8
	<b>MAINLINE TOTAL =</b>	<b>3802</b>
<b>See Driveway and Sideroad Schedule for additional surface removal quantities</b>		

**40600990 TEMPORARY RAMP**

LOCATION	REMARK	SQ. YD.
STA. 14+92.9	South end of Project, Village Limits	18.2
STA. 252+69.6	North end of Project, IL Route 72	34.5
	<b>TOTAL =</b>	<b>53</b>

**70300100 SHORT-TERM PAVEMENT MARKING**

LOCATION	REMARK	FOOT
<b>YELLOW</b>		
STA. 14+92.9 - 252+69.6	Village Limits to IL Route 72	2378
	<b>TOTAL =</b>	<b>2378</b>

SCHEDULE OF QUANTITIES CONT.

**78009004 MODIFIED URETHANE PAVEMENT MARKING - LINE 4 INCH**

LOCATION	REMARK	FOOT
WHITE		
STA. 14+92.9 - 252+69.6	Left Edge Line	23589
STA. 14+92.9 - 252+69.6	Right Edge Line	23591
	<b>TOTAL WHITE =</b>	<b>47180</b>
YELLOW		
STA. 14+92.9 - 18+99.5	Skip Dash	110
STA. 18+99.5 - 24+34.6	NB No Passing	669
STA. 24+34.6 - 28+21.8	Skip Dash	100
STA. 28+21.8 - 33+62.1	SB No Passing	675
STA. 33+62.1 - 74+72.2	Skip Dash	1030
STA. 74+72.2 - 84+31.9	NB No Passing	1200
STA. 84+31.9 - 85+05.3	Skip Dash	20
STA. 85+05.3 - 93+51.4	SB No Passing	1058
STA. 93+51.4 - 115+11.8	Skip Dash	540
STA. 115+11.8 - 122+44.9	NB No Passing	916
STA. 122+44.9 - 124+94.8	Skip Dash	60
STA. 124+94.8 - 132+98.2	SB No Passing	1004
STA. 132+98.2 - 142+51.7	NB No Passing	1192
STA. 142+51.7 - 147+29.0	Double Yellow	955
STA. 147+29.0 - 151+43.5	SB No Passing	518
STA. 151+43.5 - 157+94.4	Skip Dash	160
STA. 157+94.4 - 166+89.4	NB No Passing	1119
STA. 166+89.4 - 192+73.4	Double Yellow	5168
STA. 192+73.4 - 202+93.3	SB No Passing	1275
STA. 202+93.3 - 220+22.3	Skip Dash	430
STA. 220+22.3 - 231+67.4	NB No Passing	1431
STA. 231+67.4 - 237+67.9	Double Yellow	1201
STA. 237+67.9 - 242+61.1	SB No Passing	616
STA. 242+61.1 - 252+69.1	Skip Dash	250
STA. 252+69.1 - 253+20.6	Double Yellow	103
	<b>TOTAL YELLOW =</b>	<b>21800</b>
	<b>TOTAL 4-INCH =</b>	<b>68980</b>

## BITUMINOUS SCHEDULE

FAS 86 (Mt. Morris Road)  
 Sec 17-00318-00-RS  
 Ogle County  
 Project No. PMX4 (730)  
 Contract No. 85714

STATIONS	Length Ft	PROPOSED SURFACE						40600275 BIT MAT'L (PRIME COAT) (see note)	40600290 BIT. MAT'L (TACK COAT) (see note)	X4823105 HOT-MIX SHLDR SPECIAL	40604050 HOT-MIX ASPHALT SURF CSE IL-9.5, MIX C, N50
		MAINLINE			SHOULDER						
		Width	Sq Yd	Sq Yd	LT	RT	Sq Yd				
STA. 14+92.9 - 252+69.6	23760	24-25	67040	3	3	13020	17577	36027	1497	6905	
<b>TOTALS</b>	<b>23760</b>		<b>67040</b>			<b>13020</b>	<b>17577</b>	<b>36027</b>	<b>1497</b>	<b>6905</b>	

**Notes:**

- Bituminous Material (Prime Coat): Quantity based on application rates of 0.150 lb/sf on aggregate surfaces.
- Bituminous Material (Tack Coat): Quantity based on application rates of 0.050 lb/sf on bituminous surfaces.
- HMA Shoulder, Special: Quantity based on unit weight of 115 lb/in/sy.
- Hot-Mix Asphalt Surface Course: Quantity based on unit weight of 115 lb/in/sy.

DRIVEWAY & SIDEROAD SCHEDULE

STATIONS	Throat Width, Ft	Flare Width, Ft	CL to EOP, Ft	Entrance Area, Sq. Yd.	Length of Milling, Ft.	New HMA Total Thickness, Inches		40600275 BIT. MAT'L (PRIME COAT) POUND	40600290 BIT. MAT'L (TACK COAT) POUND	40800050 INCIDENTAL HOT-MIX ASPHALT SURFACING TON	40600982 HMA SURFACE REMOVAL BUTT JOINT SQ. YD.
						40600275 BIT. MAT'L (PRIME COAT) POUND	40600290 BIT. MAT'L (TACK COAT) POUND				
27+16.0	32.3	92.0	35	119	6	1.5	0	32	13.4	24.2	
54+00.8	10.8	24.0	35	33	6	1.5	0	9	3.7	7.1	
Midtown 67+17.4	22.5	63.5	47.1	109	10	1.5	0	29	12.2	25.2	
Midtown 67+18.1	24.2	54.9	40	99	10	1.5	0	27	11.1	29.2	
80+62.6	12.6	31.1	35.5	40	0	1.5	0	11	4.5	0	
128+96.2	13.3	51.9	41.1	50	0	1.5	0	13	5.6	0	
137+53.9	17.1	35.0	38	54	0	2	51	0	8.1	0	
West Grove 146+39.8	32.5	80.6	40	139	10	1.5	0	38	15.6	41.7	
West Grove 146+41.3	31.5	85.3	40	138	10	1.5	0	37	15.4	40.6	
195+54.0	9.6	23.5	34	29	0	1.5	0	8	3.3	0	
199+20.6	8.8	19.4	42.4	35	0	1.5	0	10	4.0	0	
212+42.0	17.7	69.7	39.2	79	0	1.5	0	21	8.8	0	
221+68.4	15.8	36.0	40	62	6	1.5	0	17	7.0	10.8	
223+26.7	22.6	51.0	40	90	6	1.5	0	24	10.1	15.8	
Town Line 225+84.4	23.7	62.6	45.2	108	10	1.5	0	29	12.2	26.7	
Town Line 225+84.8	21.1	51.9	40	88	10	1.5	0	24	9.9	26.1	
227+08.5	18.2	26.0	35	45	6	1.5	0	12	5.1	12.0	
235+44.9	14.0	53.6	34	39	6	1.5	0	10	4.3	9.6	
<b>PROJECT TOTALS =</b>							<b>51</b>	<b>352</b>	<b>154.2</b>	<b>268.9</b>	

Notes:

Bituminous Material (Prime Coat): Quantity based on application rates of 0.150 lb/sf.  
 Bituminous Material (Tack Coat): Quantity based on application rates of 0.050 lb/sf.  
 Incidental Hot-Mix Asphalt Surfacing: Quantity based on unit weight of 115 lb/in/sy.

- CER: Commercial Entrance - Right (Incidental HMA Surfacing)
- SRR: Side Road - Right (Incidental HMA Surfacing)
- SRL: Side Road - Left (Incidental HMA Surfacing)
- PER: Private Entrance - Right (Incidental HMA Surfacing)
- PEL: Private Entrance - Left (Incidental HMA Surfacing)

# PROPOSED TYPICAL ROADWAY SECTION

Contract No. 85714

Sta. 14+92.9 to 252+69.6

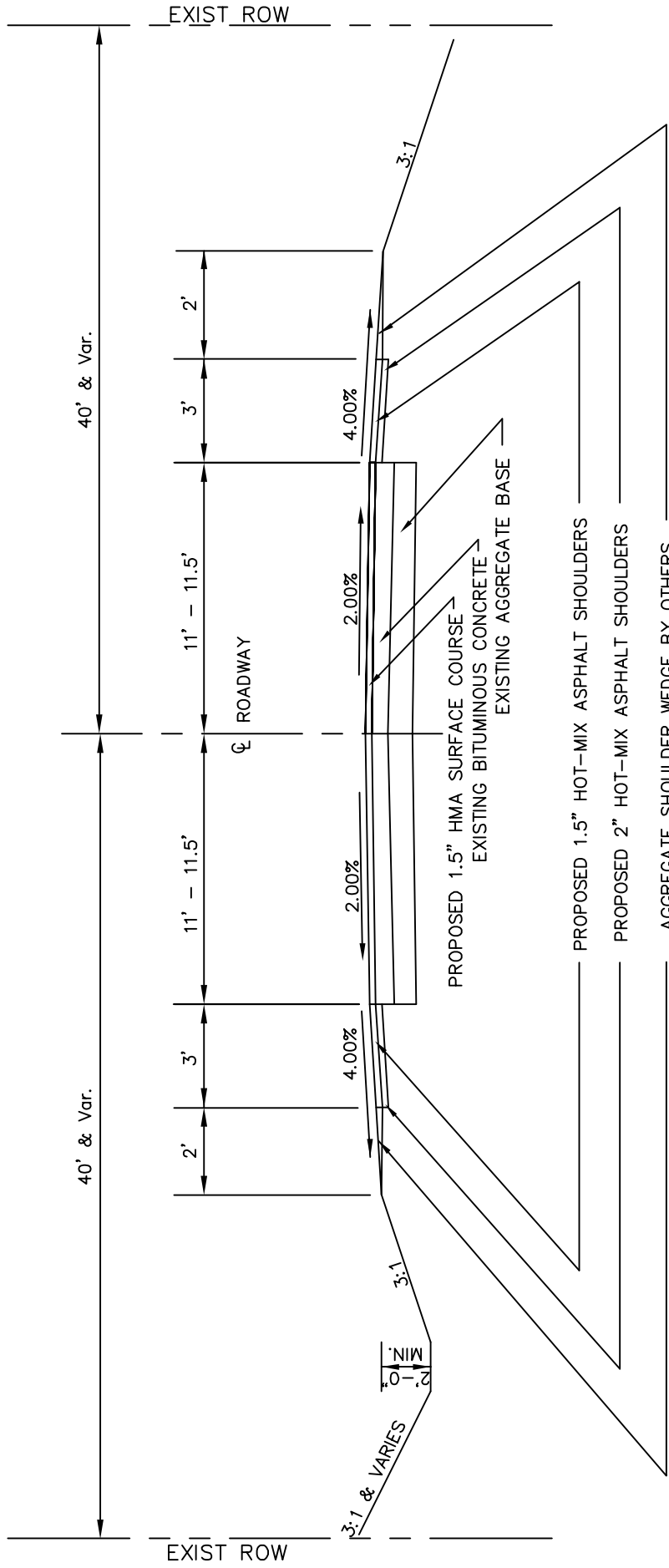

HOT-MIX Asphalt Mixture Requirements	
Mixture Use:	Surface & Top Lift of Shoulder
PG:	58-28
Design Air Voids:	4.0% at N50
Mixture Composition: (Gradation Mixture)	IL-9.5
Friction Aggregate	C
ESALS	0.34
Mixture Weight:	112 lb/sy/in
Quality Management Program:	QC/QA

F.A.S. Route 86  
 Section 17-00318-00-RS  
 Mt. Morris Road  
 Ogle County

# TYPICAL SIDE ROAD RETURN

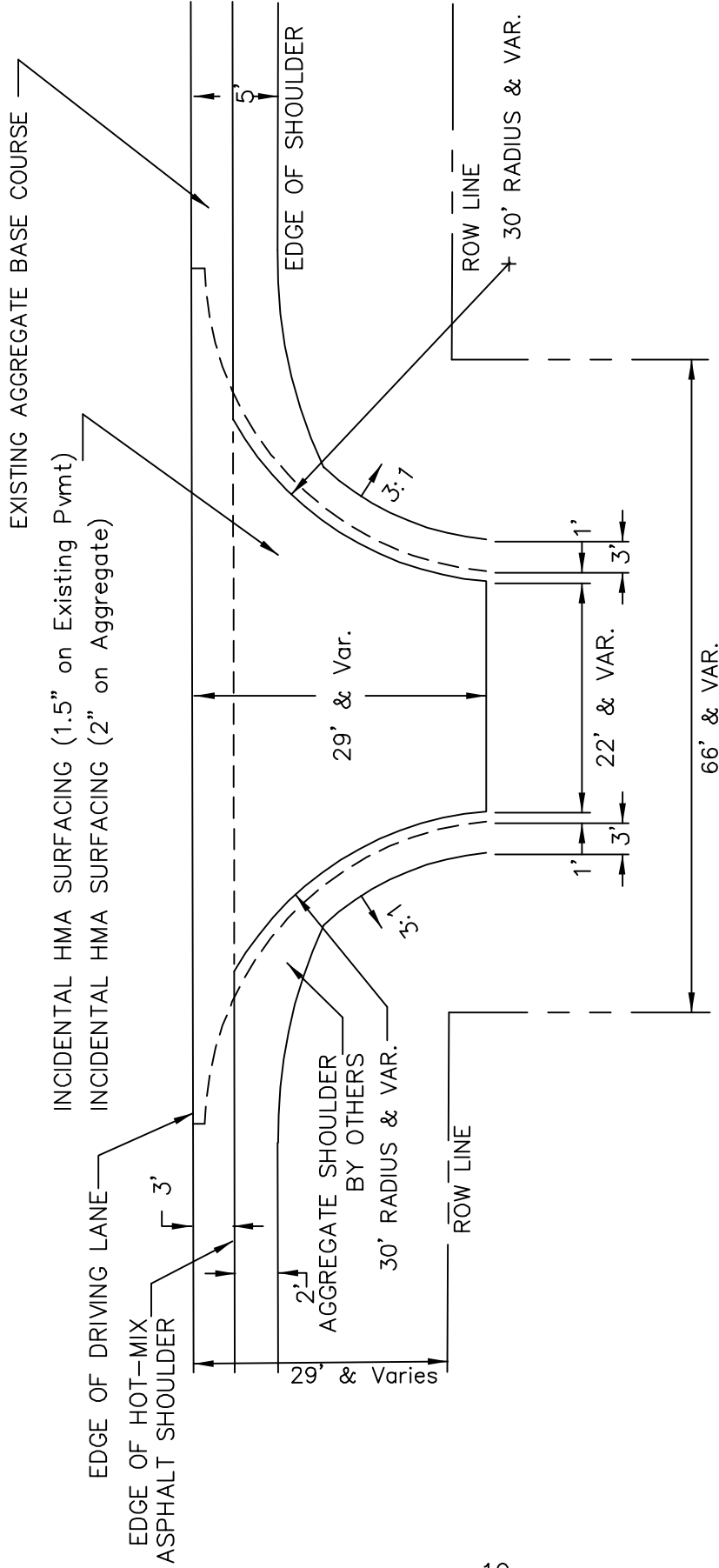

HOT-MIX Asphalt Mixture Requirements	
Mixture Use:	Incidental HMA Surfacing
PG:	58-28
Design Air Voids:	4.0% at N50
Mixture Composition: (Gradation Mixture)	IL-9.5
Friction Aggregate	C
ESALS	
Mixture Weight:	112 lb/sy/in
Quality Management Program:	QC/QA

F.A.S. Route 86  
 Section 17-00318-00-RS  
 Mt. Morris Road  
 Ogle County

# TYPICAL PRIVATE ENTRANCE

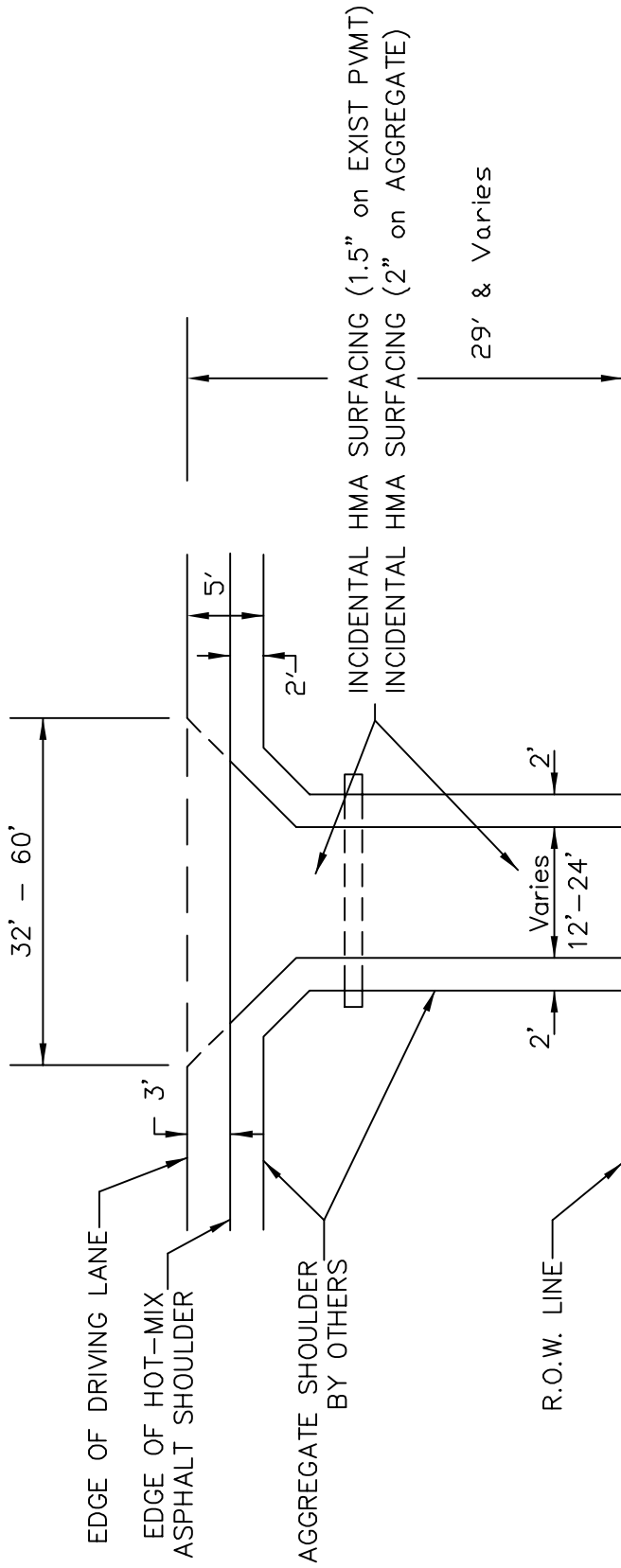

HOT-MIX Asphalt Mixture Requirements	
Mixture Use:	Incidental HMA Surfacing
PG:	58-28
Design Air Voids:	4.0% at N50
Mixture Composition: (Gradation Mixture)	IL-9.5
Friction Aggregate	C
ESALS	
Mixture Weight:	112 lb/sy/in
Quality Management Program:	QC/QA

F.A.S. Route 86  
 Section 17-00318-00-RS  
 Mt. Morris Road  
 Ogle County

# TYPICAL FIELD ENTRANCE

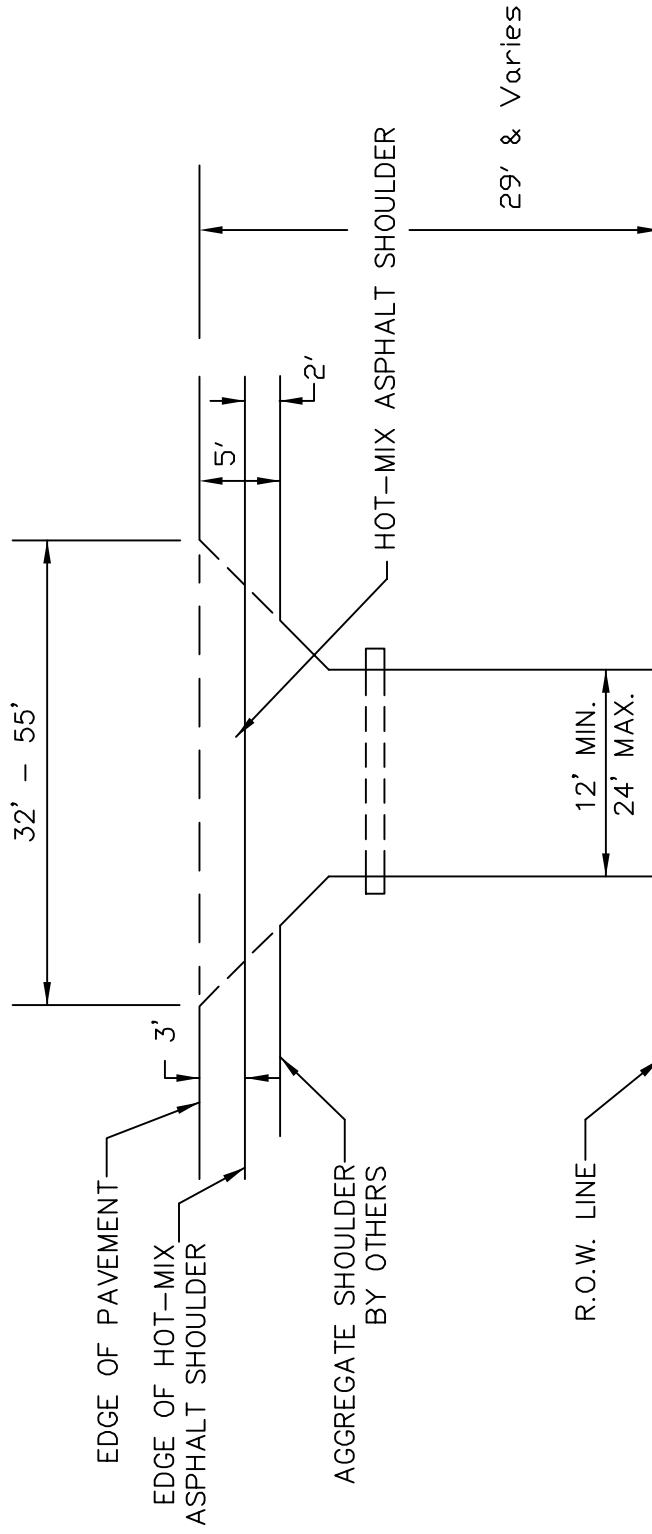

F.A.S. Route 86  
Section 17-00318-00-RS  
Mt. Morris Road  
Ogle County



# BUTT JOINT DETAIL

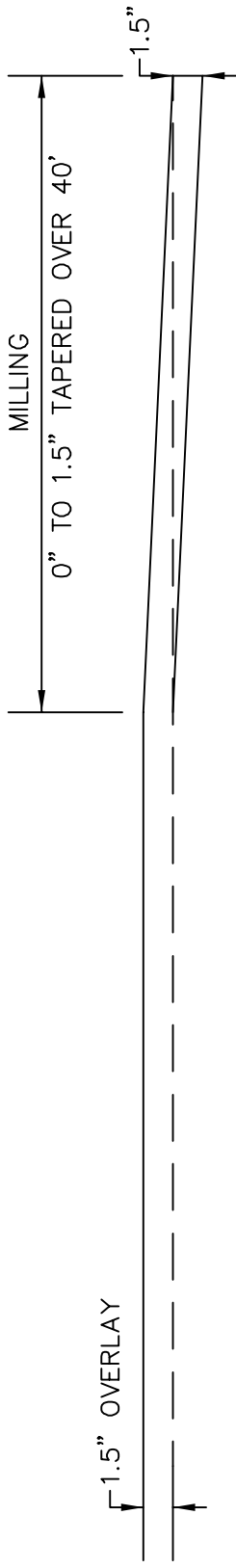
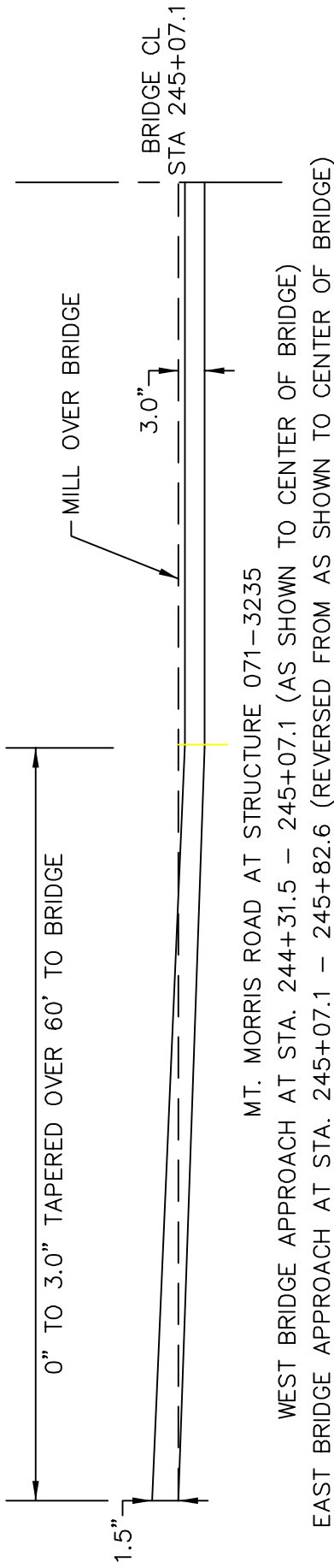

MT. MORRIS ROAD AT SOUTH PROJECT LIMIT AT STA. 14+92.9 - 15+32.9 (REVERSED FROM AS SHOWN)  
 MT. MORRIS ROAD AT NORTH PROJECT LIMIT STA. 252+29.6 - 252+69.6

F.A.S. Route 86  
 Section 17-00318-00-RS  
 Mt. Morris Road  
 Ogle County

# BUTT JOINT DETAIL, CONTINUED

Contract No. 85714

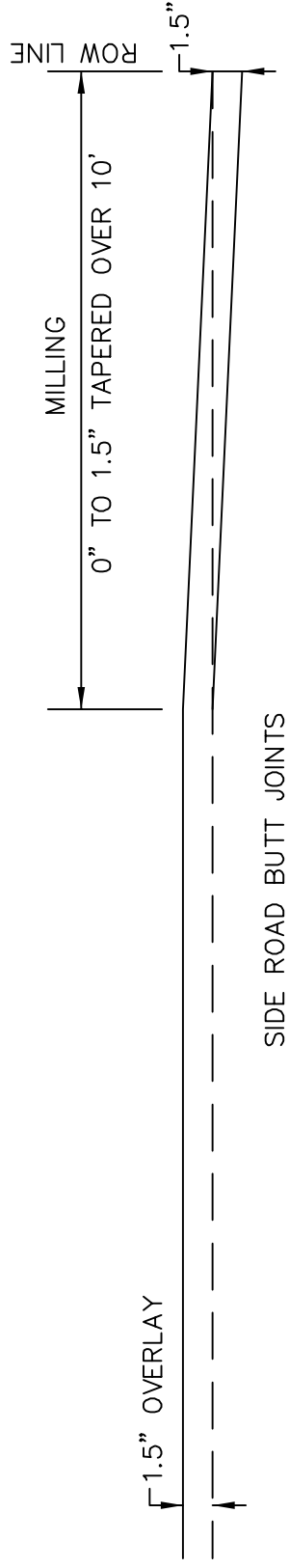
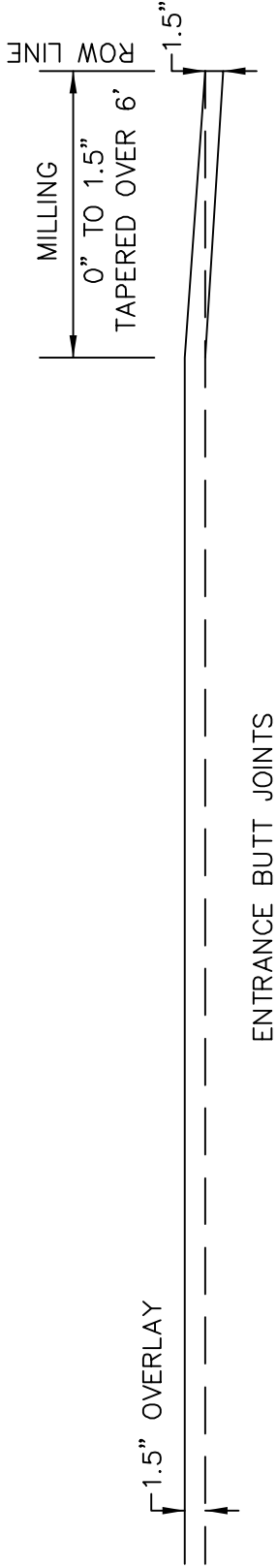

F.A.S. Route 86  
Section 17-00318-00-RS  
Mt. Morris Road  
Ogle County

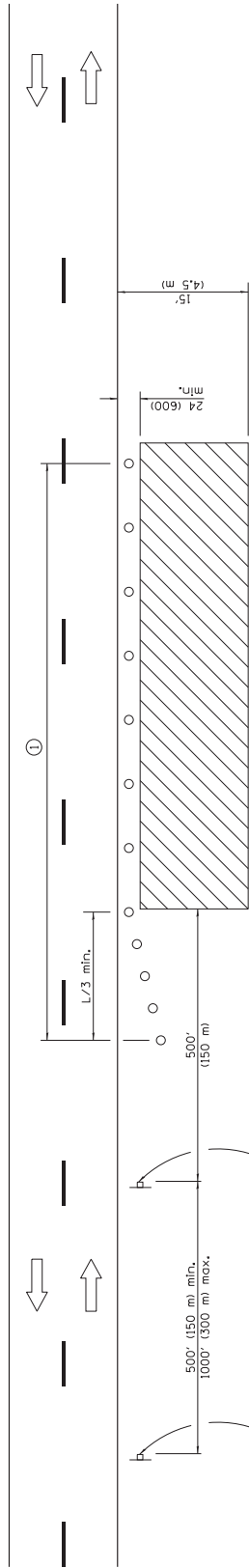

For contract construction projects

W20-1103(O)-48

For maintenance and utility projects

W20-1101-48

① When the work operation exceeds one hour, cones, drums or barricades shall be placed at 25' (8 m) centers for L/3 distance, and at 50' (15 m) centers through the remainder of the work area.

**TYPICAL APPLICATIONS**

- Utility operations
- Culvert extensions
- Side slope changes
- Guardrail installation and maintenance
- Delineator installation
- Landscaping operations
- Shoulder repair
- Sign installation and maintenance

**SYMBOLS**

- Work area
- Sign
- Cone, drum or barricade

**GENERAL NOTES**

This Standard is used where any vehicles, equipment, workers or their activities will encroach in the area 15' (4.5 m) to 24' (600) from the edge of pavement.

Calculate L as follows:

SPEED LIMIT

English	(Metric)
40 mph (70 km/h)	$WS^2$
or less:	$L = \frac{WS^2}{60}$
45 mph (80 km/h)	$L = (W/S)$
or greater:	$L = 0.65(W/S)$

W = Width of offset in feet (meters).

S = Normal posted speed mph (km/h).

All dimensions are in inches (millimeters) unless otherwise shown.

DATE	REVISIONS
1-1-14	Revised workers sign number to agree with current MUTCD.
1-1-13	Omitted text 'WORKERS' sign.

**OFF-RD OPERATIONS, 2L, 2W, 15' (4.5 m) TO 24" (600 mm) FROM PAVEMENT EDGE**

STANDARD 701006-05

Illinois Department of Transportation  
 APPROVED January 1, 2014  
 ENGINEER OF SAFETY ENGINEERING  
 APPROVED January 1, 2014  
 ENGINEER OF DESIGN AND ENVIRONMENT  
 ISSUED 1-1-97

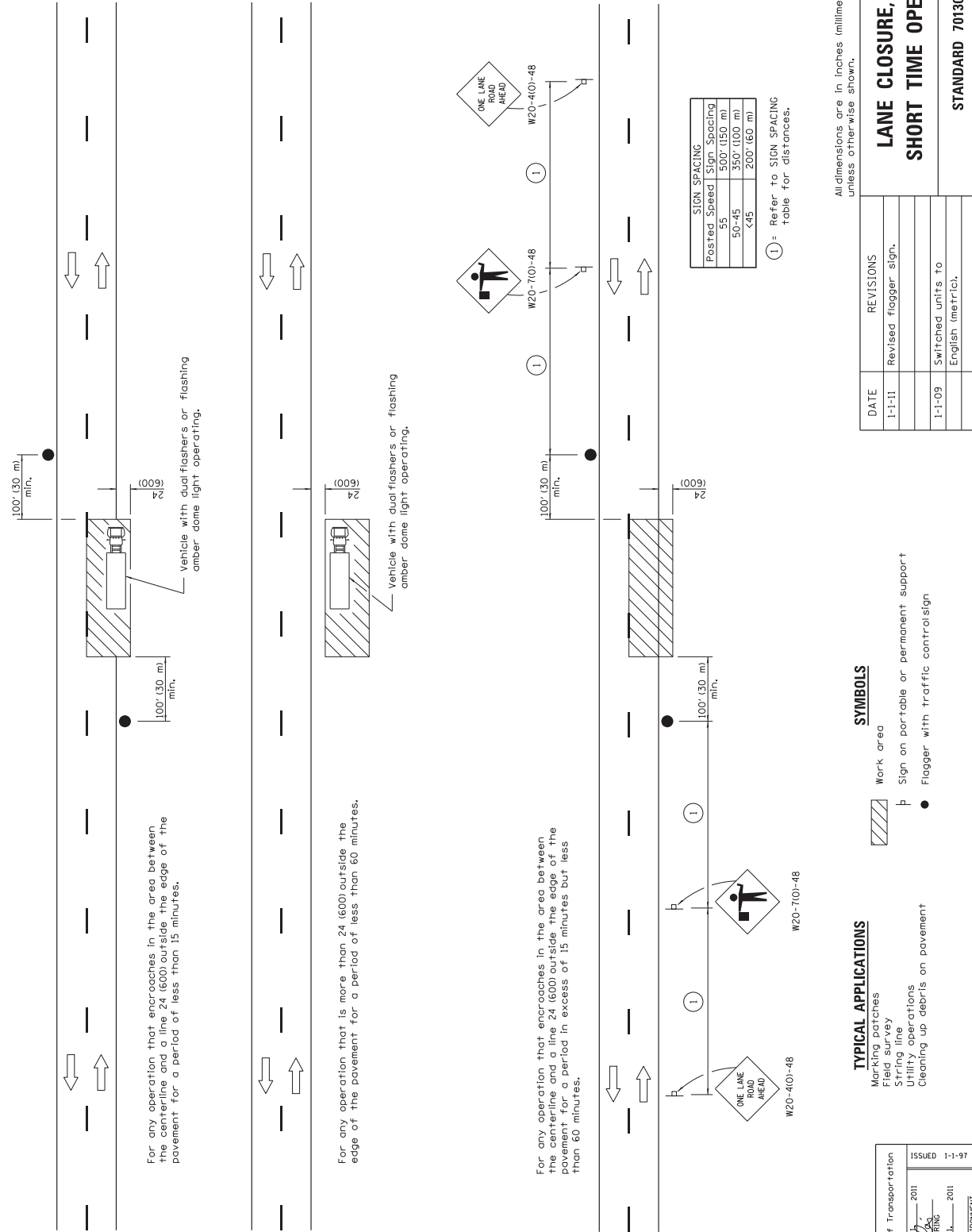

All dimensions are in inches (millimeters) unless otherwise shown.

**LANE CLOSURE, 2L, 2W, SHORT TIME OPERATIONS**

STANDARD 701301-04

DATE	REVISIONS
1-1-11	Revised flagger sign.
1-1-09	Switched units to English (metric).

**SYMBOLS**

- Work area
- Sign on portable or permanent support
- Flagger with traffic control sign

**TYPICAL APPLICATIONS**

- Marking patches
- Field survey
- String line
- Utility operations
- Cleaning up debris on pavement

Illinois Department of Transportation

APPROVED January 2, 2011

ENGINEER OF SAFETY ENGINEERING

ISSUED 1-1-97

APPROVED January 11, 2011

ENGINEER OF DESIGN AND ENVIRONMENT

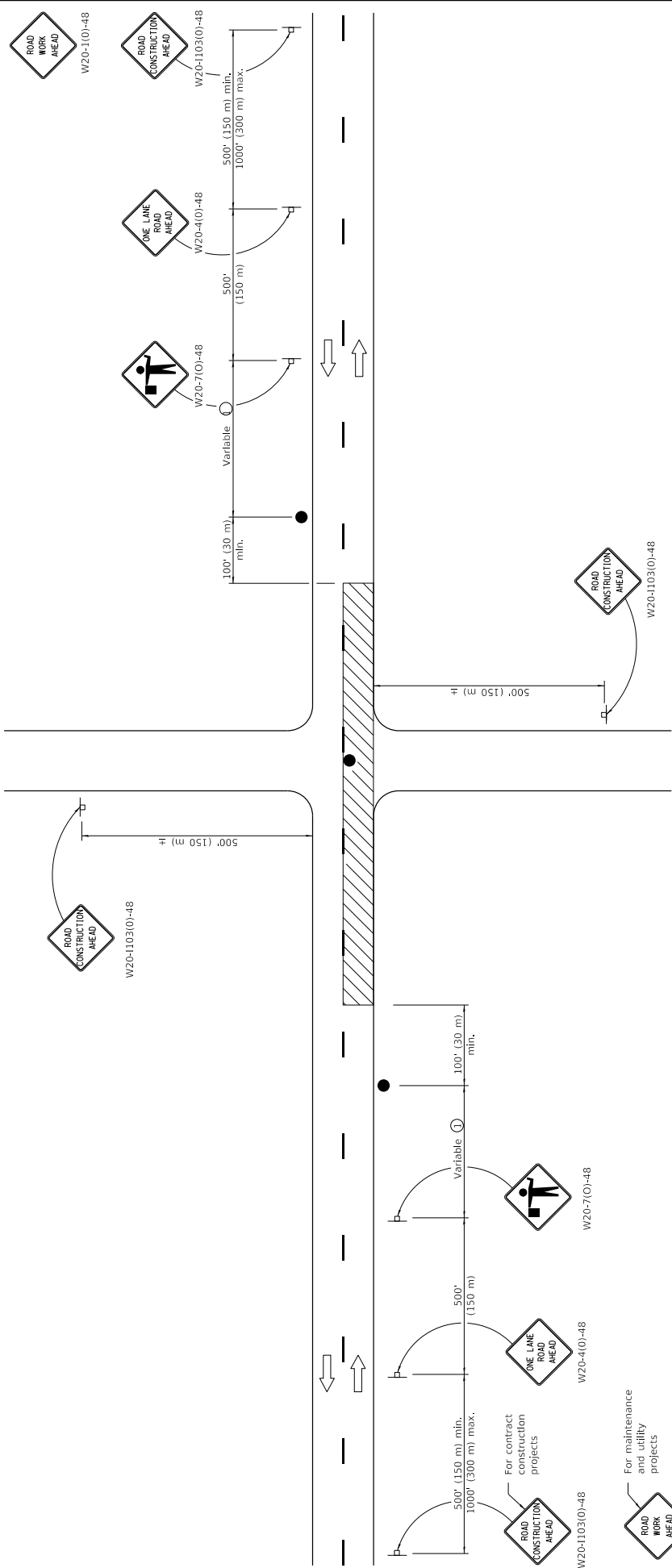

**GENERAL NOTES**

This Standard is used where at any time, any vehicle, equipment, workers or their activities require an intermittent or continuous moving operation on the pavement where the average speed of movement is greater than 1/2 mph (1 km/h) and less than 4 mph (6 km/h).

When the operation does not exceed 60 minutes, traffic control may be according to Standard 701301.

All dimensions are in inches (millimeters) unless otherwise shown.

**TYPICAL APPLICATIONS**

- Bituminous resurfacing
- Milling operations
- Utility operations
- Shoulder operations

① Minimum distance is 200' (60 m). Maximum distance to be determined by the Engineer but should not exceed 1/2 the length required for one normal working days' operation or 2 miles (3200 m), whichever is less.

**SYMBOLS**

- Work area
- Sign on portable or permanent support
- Flagger with traffic control sign

DATE	REVISIONS
1-1-18	Revised lower speed limit for operation to 1/2 mph.
1-1-11	Revised flagger sign.

PASSED January 1, 2018  ENGINEER OF SAFETY PROG. AND ENGINEERING	ISSUED 1-1-18
APPROVED January 1, 2018  ENGINEER OF DESIGN AND ENVIRONMENT	

**LANE CLOSURE, 2L, 2W, SLOW MOVING OPERATIONS DAY ONLY, FOR SPEEDS ≥ 45 MPH**

**STANDARD 701306-04**

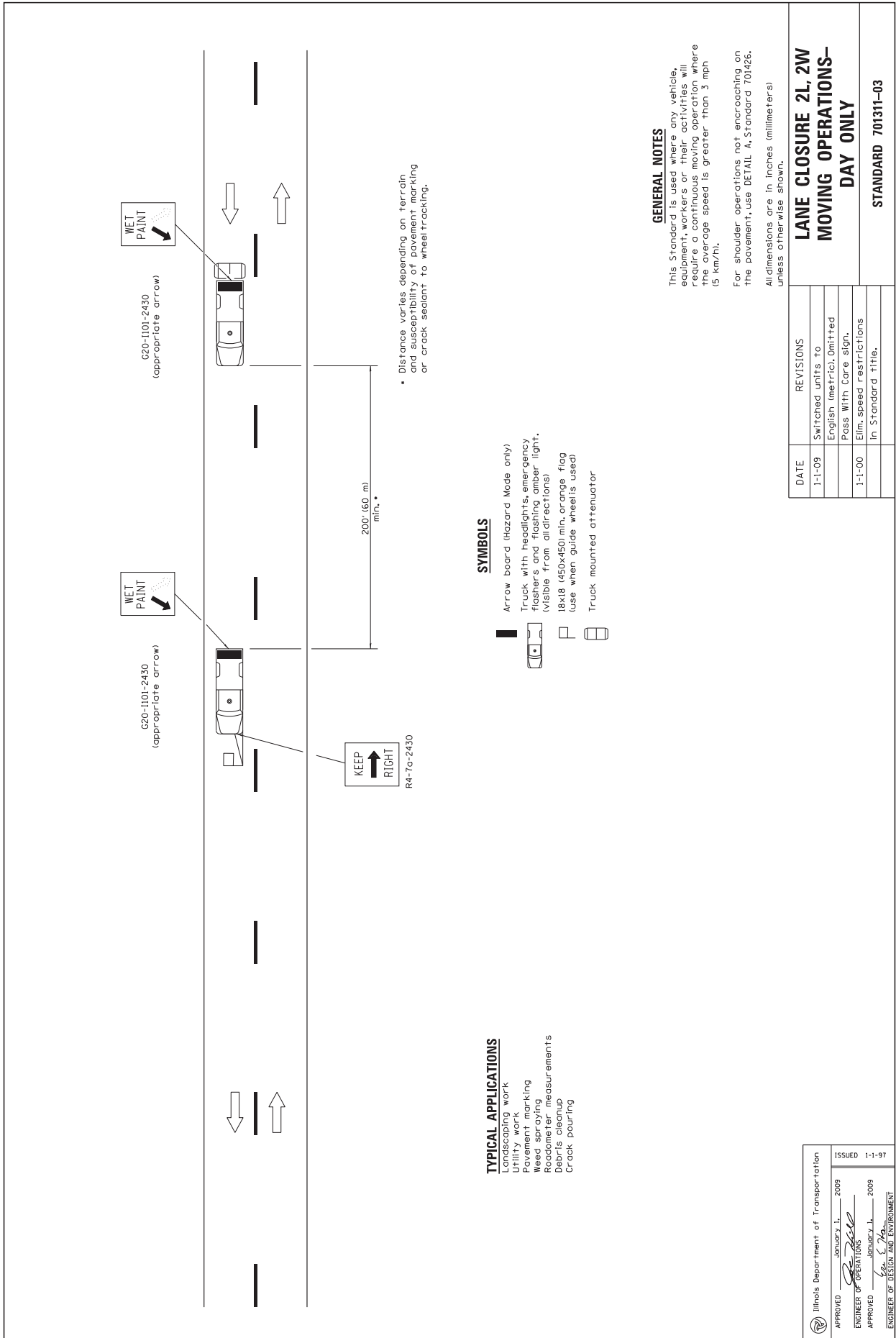

**TYPICAL APPLICATIONS**

- Landscaping work
- Utility work
- Pavement marking
- Weed spraying
- Roadometer measurements
- Debris cleanup
- Crack pouring

**SYMBOLS**

- Arrow board (hazard mode only)
- Truck with headlights, emergency flashers and flashing amber light (visible from all directions) 18x18 (450x450) min, orange flag (use when guide wheels used)
- Truck mounted attenuator

**GENERAL NOTES**

This Standard is used where any vehicle, equipment, workers or their activities will require a continuous moving operation where the average speed is greater than 3 mph (5 km/h).

For shoulder operations not encroaching on the pavement, use DETAIL A, Standard 701426. All dimensions are in inches (millimeters) unless otherwise shown.

Illinois Department of Transportation APPROVED _____ JUNE 11, 2009 ENGINEER OF OPERATIONS APPROVED _____ JUNE 11, 2009 ENGINEER OF DESIGN AND ENVIRONMENT	ISSUED 1-1-97

DATE	REVISIONS
1-1-09	Switched units to English (metric). Omitted Pass With Care sign.
1-1-00	Elim. speed restrictions in Standard title.

**LANE CLOSURE 2L, 2W  
MOVING OPERATIONS-  
DAY ONLY**  
STANDARD 701311-03

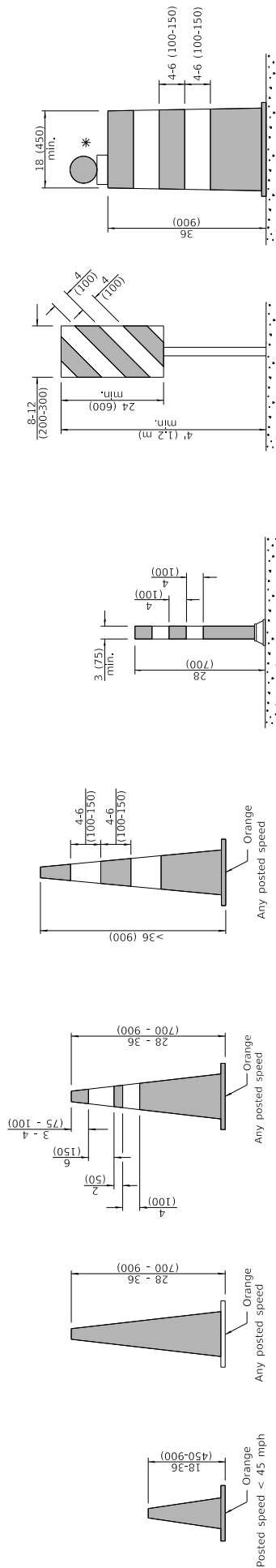

**CONES**

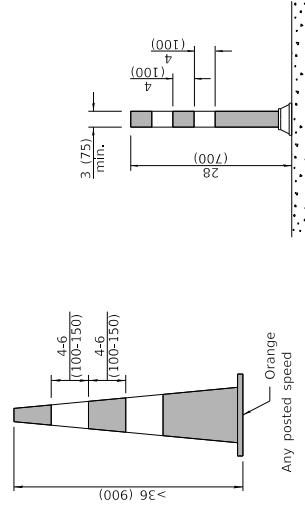

**TUBULAR MARKER**

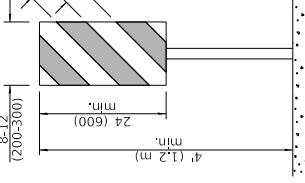

**VERTICAL PANEL POST MOUNTED**

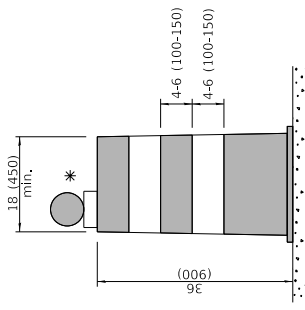

**DRUM**

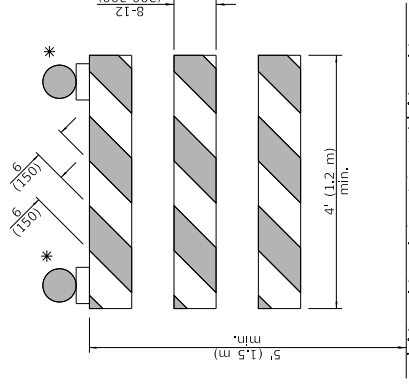

**TYPE III BARRICADE**

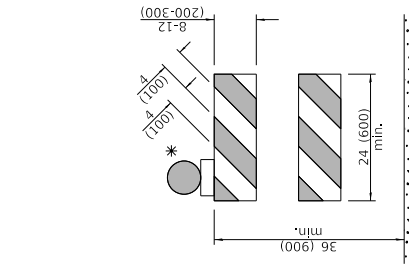

**TYPE II BARRICADE**

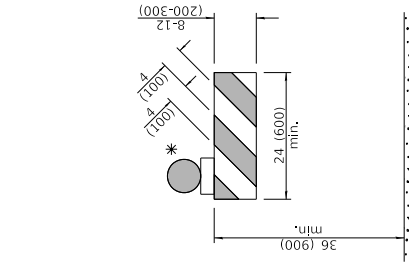

**TYPE I BARRICADE**

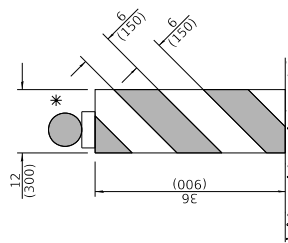

**VERTICAL BARRICADE**

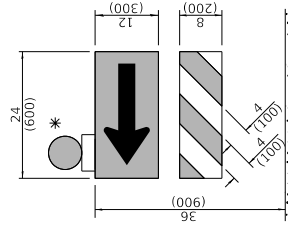

**DIRECTION INDICATOR BARRICADE**

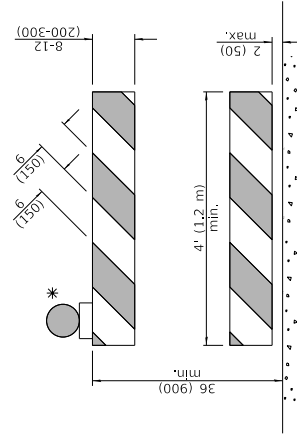

**DETECTABLE PEDESTRIAN CHANNELIZING BARRICADE**

\* Warning lights (if required)

**GENERAL NOTES**

All heights shown shall be measured above the pavement surface.  
All dimensions are in inches (millimeters) unless otherwise shown.

DATE	REVISIONS
1-1-19	Revised cone usage and added cones >36" (900 m) height.
1-1-18	Revised END WORK ZONE SPEED LIMIT sign from orange to white background.

<b>TRAFFIC CONTROL DEVICES</b>	
(Sheet 1 of 3)	
<b>STANDARD 701901-08</b>	

Illinois Department of Transportation  
 APPROVED January 1, 2019  
 [Signature] ENGINEER OF SAFETY PROC. AND ENGINEERING  
 APPROVED January 1, 2019  
 [Signature] ENGINEER OF DESIGN AND ENVIRONMENT

ISSUED 1-1-13

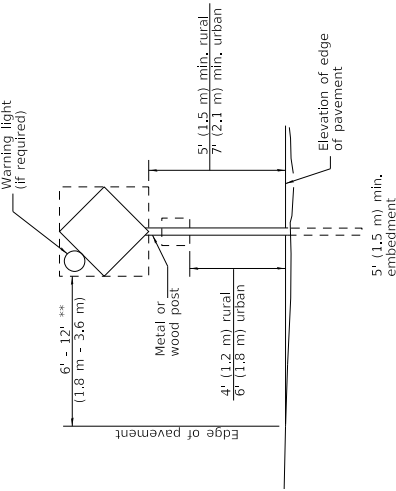

**POST MOUNTED SIGNS**

\*\* When curb or paved shoulder are present this dimension shall be 24 (600) to the face of curb or 6' (1.8 m) to the outside edge of the paved shoulder.

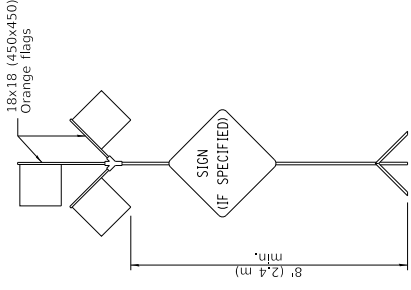

**HIGH LEVEL WARNING DEVICE**

ROAD CONSTRUCTION NEXT X MILES  
G20-1104(0)-6036

END CONSTRUCTION  
G20-1105(0)-6024

This signing is required for all projects 2 miles (3200 m) or more in length.  
ROAD CONSTRUCTION NEXT X MILES sign shall be placed 500' (150 m) in advance of project limits.  
END CONSTRUCTION sign shall be erected at the end of the job unless another job is within 2 miles (3200 m).  
Dual sign displays shall be utilized on multi-lane highways.

**WORK LIMIT SIGNING**

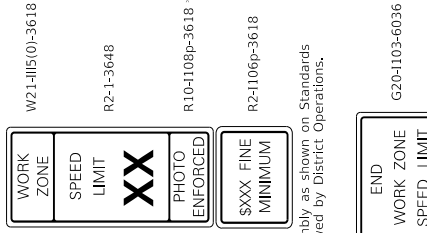

Sign assembly as shown on Standards or as allowed by District Operations.

This sign shall be used when the above sign assembly is used.

**HIGHWAY CONSTRUCTION SPEED ZONE SIGNS**

\*\*\*\* R10-1108p shall only be used along roadways under the jurisdiction of the State.

Illinois Department of Transportation  
APPROVED January 1, 2019  
Cynthia C. [Signature]  
ENGINEER OF SAFETY PROC. AND ENGINEERING  
APPROVED January 1, 2019  
S. [Signature]  
ENGINEER OF DESIGN AND ENVIRONMENT

**FLAGGER TRAFFIC CONTROL SIGN**

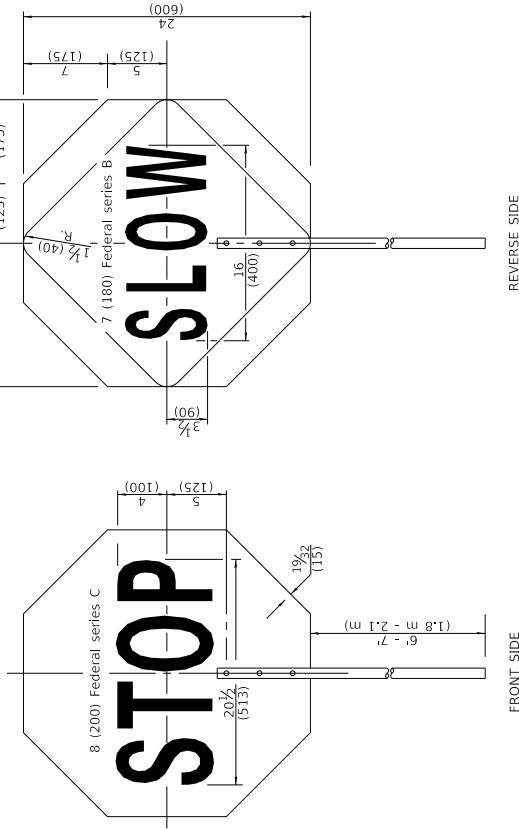

REVERSE SIDE

FRONT SIDE

**TRAFFIC CONTROL DEVICES**

(Sheet 2 of 3)

**STANDARD 701901-08**

W12-1103-4848

**WIDTH RESTRICTION SIGN**

XX-XX" width and X miles are variable.



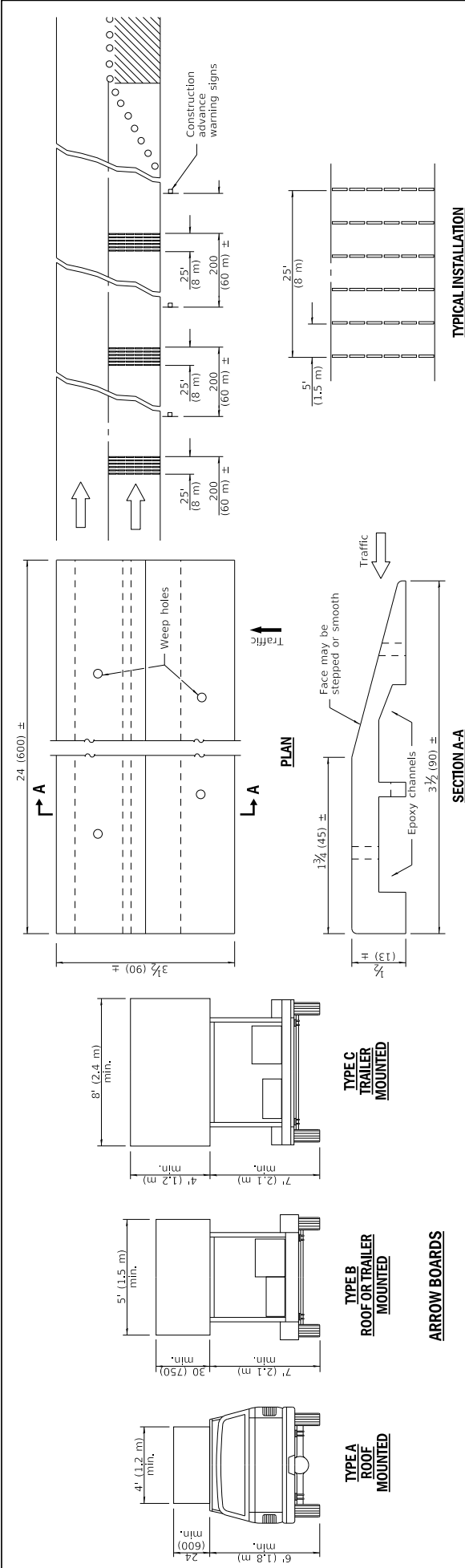

**TEMPORARY RUMBLE STRIPS**

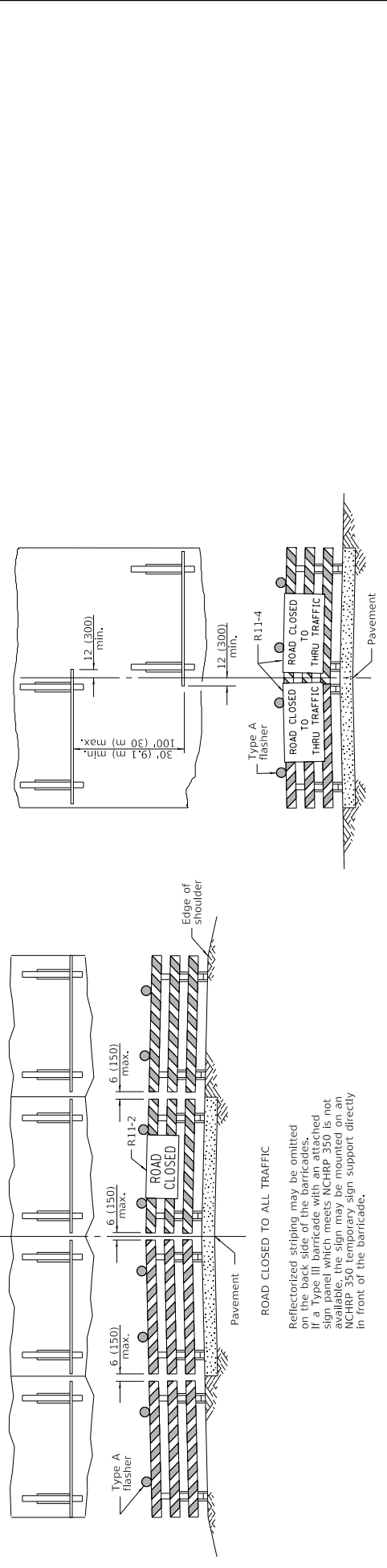

<p>ILLINOIS DEPARTMENT OF TRANSPORTATION</p> <p>APPROVED: <i>[Signature]</i> January 1, 2019          ENGINEER OF SAFETY PROC. AND ENGINEERING</p> <p>APPROVED: <i>[Signature]</i> January 1, 2019          ENGINEER OF DESIGN AND ENVIRONMENT</p>	<p>ISSUED 1-1-13</p>
<p><b>TYPICAL APPLICATIONS OF TYPE III BARRICADES CLOSING A ROAD</b></p>	
<p><b>TRAFFIC CONTROL DEVICES</b></p>	
<p><b>STANDARD 701901-08</b></p>	
<p>(Sheet 3 of 3)</p>	

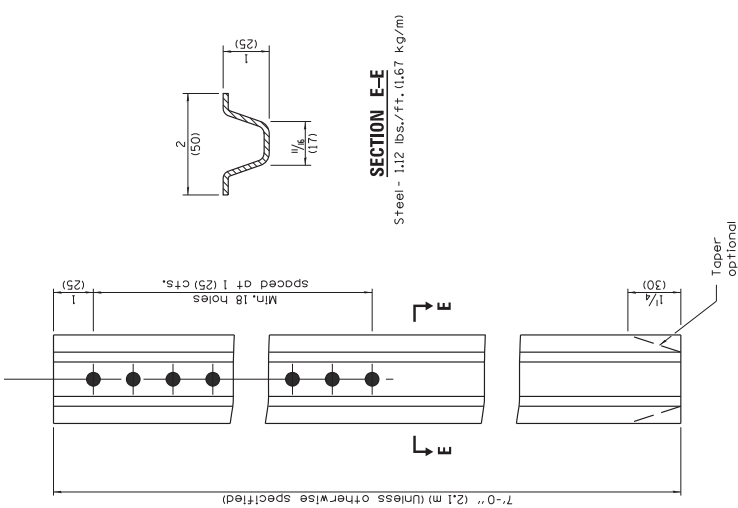

**SECTION E-E**

Steel - 1.12 lbs./ft. (1.67 kg/m)

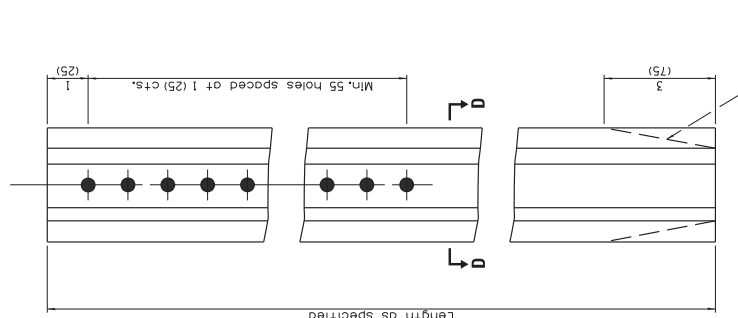

**SECTION D-D**

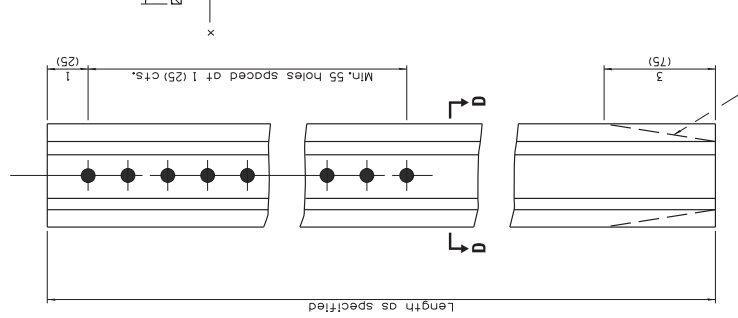
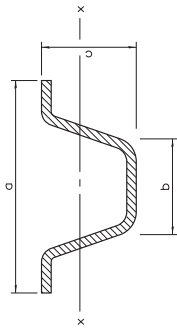

**TYPE A**

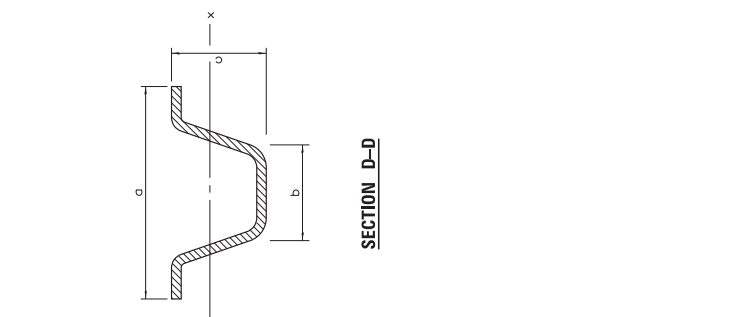

**TYPE B**

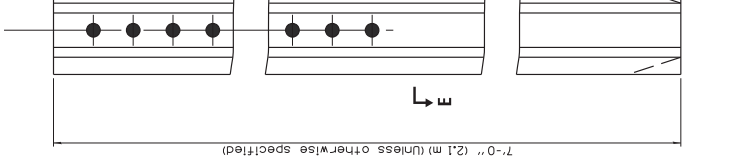

**TYPE C**

**GENERAL NOTES**

Dimensions shown for cross sections are minimum.  
All holes are  $\frac{3}{16}$  (10).

Sx-x is the minimum section modulus about the x-x axis of the post as shown. For posts in which holes are punched or drilled for more than half the length, Sx-x shall be computed for the net section.

All dimensions are in inches (millimeters) unless otherwise shown.

	a	b	c	S <sub>x-x</sub> I <sub>x</sub> 3 (mm <sup>3</sup> )	lbs./ft. (kg/m)
TYPE A	Steel	$\frac{3}{16}$ (12)	$\frac{1}{4}$ (25)	$\frac{1}{16}$ (1.56)	2.50 (0.36)
	Aluminum	$\frac{3}{16}$ (12)	$\frac{1}{4}$ (25)	$\frac{1}{16}$ (1.56)	0.90 (0.13)
TYPE B	Steel	$\frac{3}{16}$ (12)	$\frac{1}{4}$ (25)	$\frac{1}{8}$ (3.12)	3.40 (0.46)
	Aluminum	$\frac{3}{16}$ (12)	$\frac{1}{4}$ (25)	$\frac{1}{8}$ (3.12)	1.30 (0.18)

Illinois Department of Transportation  
 PASSED: JUDICIA, I., 2009  
 ENGINEER OF POLICY AND PROCEDURES  
 APPROVED: JUDICIA, I., 2009  
 ENGINEER OF DESIGN AND ENVIRONMENT

DATE	REVISIONS
1-1-09	Switched units to English (metric).
1-1-97	Renum. Standard 2350-4.

**METAL POSTS FOR SIGNS, MARKERS & DELINEATORS**

STANDARD 720011-01

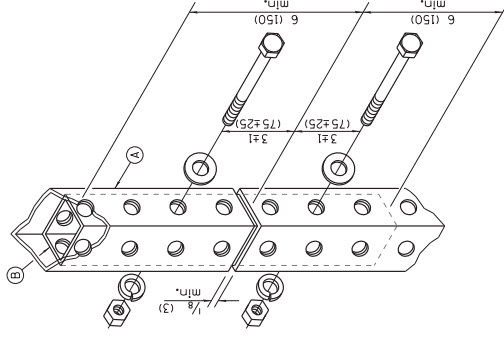

**SPLICE DETAIL**

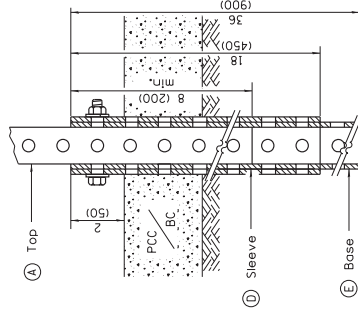

**PAVEMENT MOUNT DETAIL**

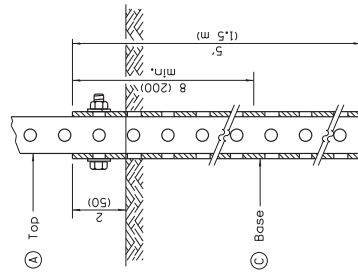

**GROUND MOUNT DETAIL**

Ⓐ	2 x 2 x var. (51 x 51 var.)
Ⓑ	1 3/4 x 1 3/4 x 12 (44 x 44 x 300)
Ⓒ	2 1/4 x 2 1/4 x 60 (57 x 57 x 1500)
Ⓓ	2 1/2 x 2 1/2 x 18 (64 x 64 x 450)
Ⓔ	2 1/4 x 2 1/4 x 36 (57 x 57 x 900)

**GENERAL NOTES**  
 All bolts 3/8" (M10) hex head zinc or cadmium plated.  
 All dimensions are in inches (millimeters)  
 unless otherwise shown.

Illinois Department of Transportation APPROVED <i>[Signature]</i> JUNE 11, 2009 ENGINEER OF OPERATIONS	ISSUED 1-1-07
	APPROVED <i>[Signature]</i> JUNE 11, 2009 ENGINEER OF DESIGN AND ENVIRONMENT

DATE	REVISIONS
1-1-09	Switched units to English (metric).
1-1-07	New Standard. Used to be part of Standard 720006.

**TELESCOPING STEEL SIGN SUPPORT**

**STANDARD 728001-01**

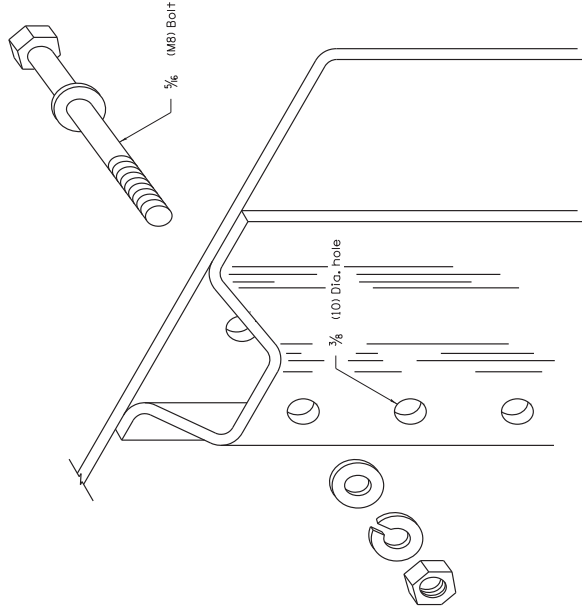

**DETAIL OF MOUNTING SIGN TO POST**  
NOTE: Minimum of 2 bolts per post required.

**GENERAL NOTES**

DESIGN: Current AASHTO Standard Specifications for Structural Supports for Highway Signs, Luminaires and Traffic Signals.

LOADING: For 60 mph (95 km/h) wind velocity with 30% gust factor, normal to sign.

SOIL PRESSURE: Minimum allowable soil pressure 1.25 tsf (120 kPa).

See Standard 720011 for details of Types A and B posts.

All dimensions are in inches (millimeters) unless otherwise shown.

DATE	REVISIONS
1-1-09	Switched units to English (metric).
1-1-97	Renum. Standard 2363-2.

**APPLICATIONS OF TYPES A & B METAL POSTS (FOR SIGNS & MARKERS)**

STANDARD 729001-01

SIGN DEPTH (D)	H	NO. AND TYPE OF POST FOR SIGN WIDTH (W)			
		12 (300)	18 (450)	24 (600)	36 (900)
18 (450)	5'-0" (1.5 m)	A	A	A	A
	5'-6" (1.7 m)	A	A	A	A
	6'-0" (1.8 m)	A	A	A	A
	6'-6" (2.0 m)	A	A	A	B
	7'-0" (2.1 m)	A	A	A	B
	7'-6" (2.3 m)	A	A	A	B
	8'-0" (2.4 m)	A	A	A	B
	8'-6" (2.6 m)	A	A	A	B
	9'-0" (2.7 m)	A	A	A	B
24 (600)	5'-0" (1.5 m)	A	A	A	B
	5'-6" (1.7 m)	A	A	A	B
	6'-0" (1.8 m)	A	A	A	B
	6'-6" (2.0 m)	A	A	A	B
	7'-0" (2.1 m)	A	A	A	B
	7'-6" (2.3 m)	A	A	A	B
	8'-0" (2.4 m)	A	A	A	B
	8'-6" (2.6 m)	A	A	A	B
	9'-0" (2.7 m)	A	A	A	B
30 (750)	5'-0" (1.5 m)	A	A	A	B
	5'-6" (1.7 m)	A	A	A	B
	6'-0" (1.8 m)	A	A	A	B
	6'-6" (2.0 m)	A	A	A	B
	7'-0" (2.1 m)	A	A	A	B
	7'-6" (2.3 m)	A	A	A	B
	8'-0" (2.4 m)	A	A	A	B
	8'-6" (2.6 m)	A	A	A	B
	9'-0" (2.7 m)	A	A	A	B
36 (900)	5'-0" (1.5 m)	A	A	B	2A
	5'-6" (1.7 m)	A	A	B	2A
	6'-0" (1.8 m)	A	A	B	2A
	6'-6" (2.0 m)	A	A	B	2A
	7'-0" (2.1 m)	A	A	B	2A
	7'-6" (2.3 m)	A	A	B	2A
	8'-0" (2.4 m)	A	A	B	2A
	8'-6" (2.6 m)	A	A	B	2A
	9'-0" (2.7 m)	A	A	B	2A
4'-0" (1.2 m)	5'-0" (1.5 m)	A	A	B	2A
	5'-6" (1.7 m)	A	A	B	2A
	6'-0" (1.8 m)	A	A	B	2A
	6'-6" (2.0 m)	A	A	B	2A
	7'-0" (2.1 m)	A	A	B	2A
	7'-6" (2.3 m)	A	A	B	2A
	8'-0" (2.4 m)	A	A	B	2A
	8'-6" (2.6 m)	A	A	B	2A
	9'-0" (2.7 m)	A	A	B	2A

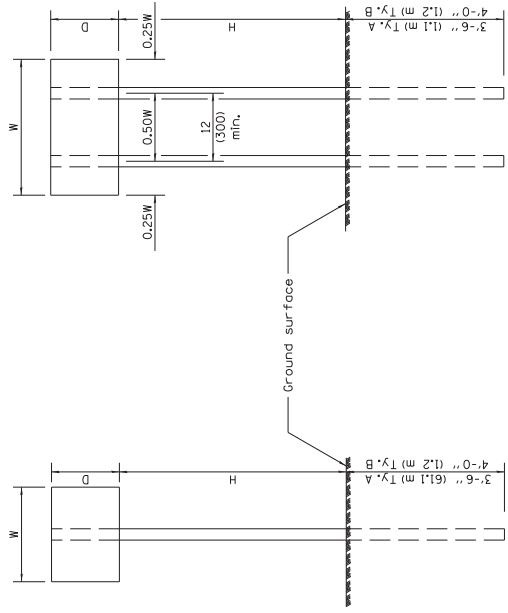

**ONE POST INSTALLATION**

**TWO POST INSTALLATION**

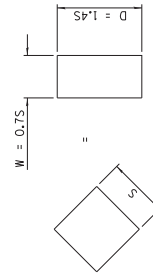

For diamond shaped sign with side S, as shown, use required post size for a sign with  $W = 0.75S$  and  $D = 1.45S$ .

Illinois Department of Transportation  
 PASSED January 1, 2009  
 ENGINEER OF POLICY AND PROCEDURES  
 APPROVED January 1, 2009  
 ENGINEER OF DESIGN AND ENVIRONMENT  
 ISSUED 1-1-97

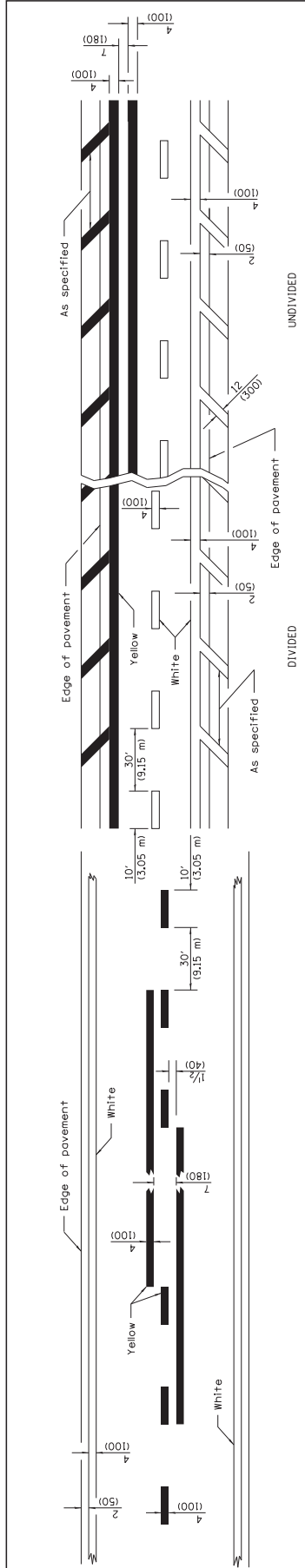

**2 LANE**

**DIVIDED**

**MULTI LANE**

**LANE AND EDGE LINES**

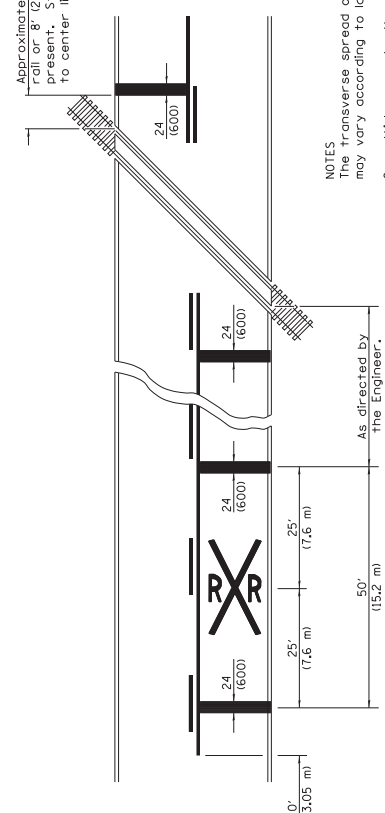

**NOTES**  
 The transverse spread of the "X" may vary according to lane width.  
 On multi-lane roads, the stop lines shall extend across all approach lanes and separate RRR symbols shall be placed adjacent to each other in each lane.  
 When the pavement marking symbol is used, a portion of the symbol should be located directly adjacent to the Advance Warning Sign (W10-1) as placed by Table 2C-4, Condition B of the MUTCD.

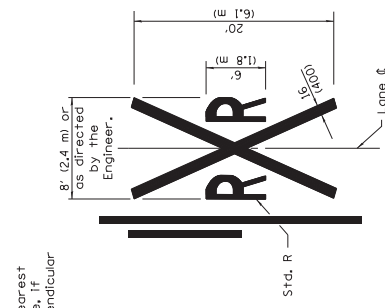

Approximately 15' (4.5 m) from nearest edge of pavement, or 8' (2.4 m) back from stop line if present. Stop line placed perpendicular to center line.

APPROVED	January 1, 2015
APPROVED	January 1, 2015
APPROVED	January 1, 2015
APPROVED	January 1, 2015

Illinois Department of Transportation  
 ENGINEER OF OPERATIONS  
 ENGINEER OF DESIGN AND ENVIRONMENT

**PAVEMENT MARKINGS AT RAILROAD-HIGHWAY GRADE CROSSING**

DATE	REVISIONS
1-1-15	Added symbols, Revised bike symbol, Revised note for stop line at RR crossing.
1-1-14	Added bike symbol, Renamed 'LANE DROP-ARROW' detail to 'LANE-REDUCTION-ARROW'.

**TYPICAL PAVEMENT MARKINGS**

STANDARD 780001-05

(Sheet 1 of 3)

All dimensions are in inches (millimeters) unless otherwise shown.

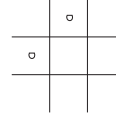
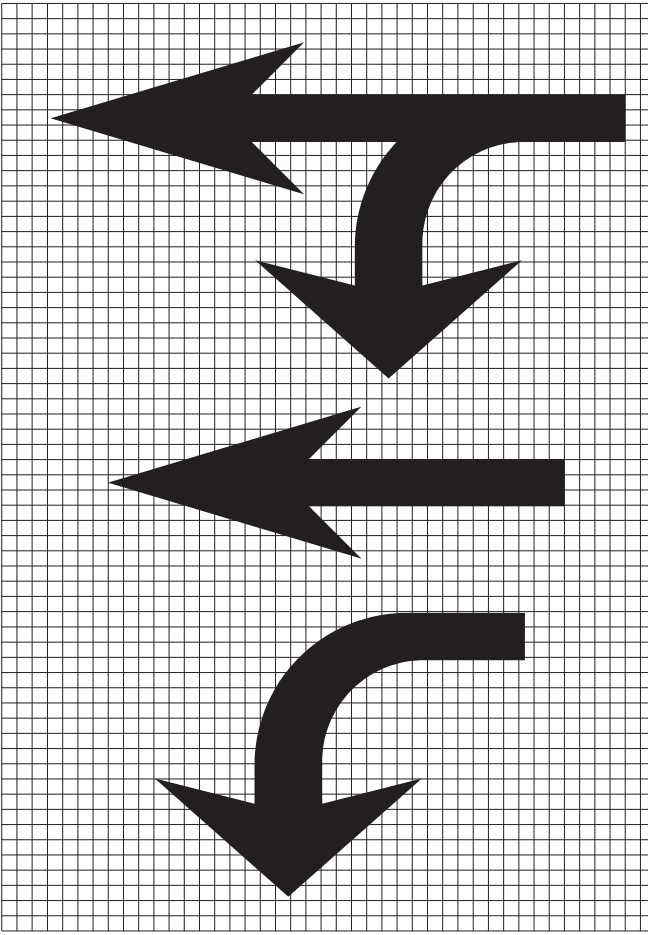
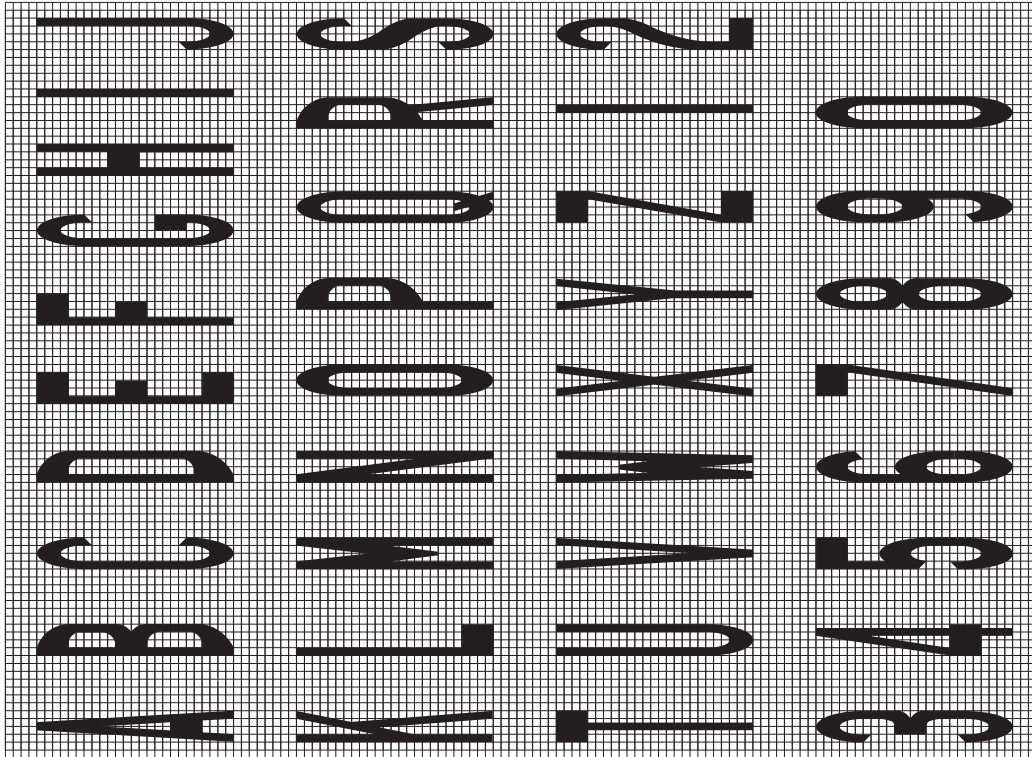

Legend Height	Arrow Size	a
6' (1.8 m)	Small	2.9 (74)
8' (2.4 m)	Large	3.8 (96)

The space between adjacent letters or numerals should be approximately 3 (75) for 6' (1.8 m) legend and 4 (100) for 8' (2.4 m) legend.

**LETTER AND ARROW GRID SCALE**

**TYPICAL PAVEMENT MARKINGS**  
 (Sheet 2 of 3)  
**STANDARD 780001-05**

Illinois Department of Transportation  
 APPROVED \_\_\_\_\_ JANUARY 1, 2015  
 ENGINEER OF OPERATIONS  
 APPROVED \_\_\_\_\_ JANUARY 1, 2015  
 ENGINEER OF DESIGN AND ENVIRONMENT  
 ISSUED 1-1-97

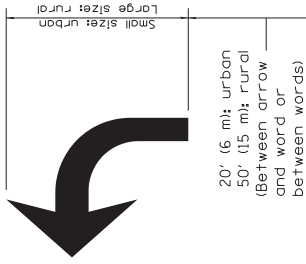
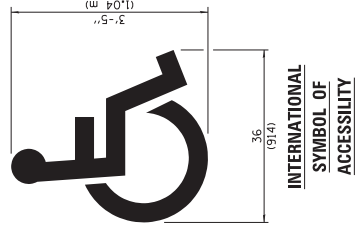

**ONLY**

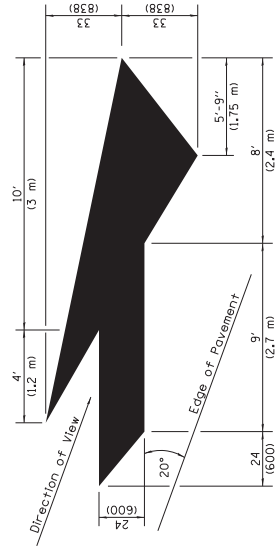

**LANE-REDUCTION ARROW**

Right lane-reduction arrow shown. Use mirror image for left lane.

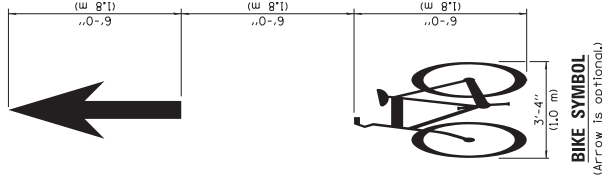
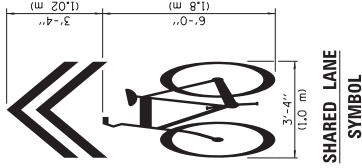
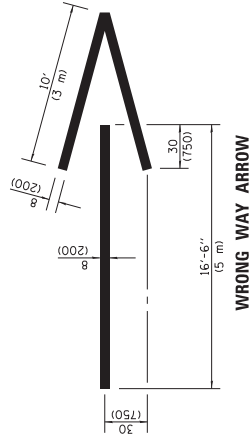

**TYPICAL PAVEMENT MARKINGS**  
(Sheet 3 of 3)  
**STANDARD 780001-05**

Illinois Department of Transportation  
 APPROVED: [Signature] JANUARY 1, 2015  
 ENGINEER OF OPERATIONS  
 APPROVED: [Signature] JANUARY 1, 2015  
 ENGINEER OF DESIGN AND ENVIRONMENT

ISSUED 1-1-97

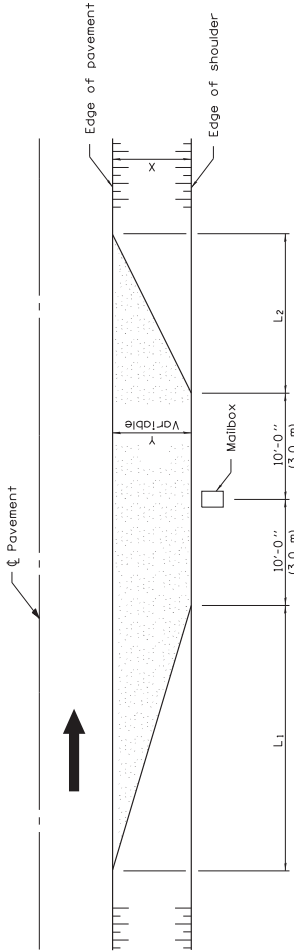

**TYPICAL APPLICATION**

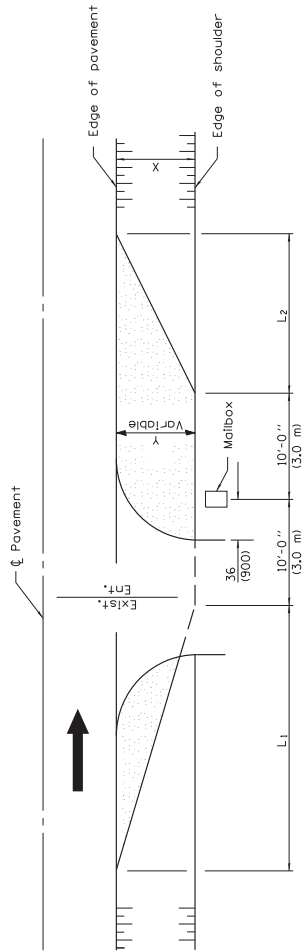

**MAILBOX ON FAR SIDE OF ENTRANCE**

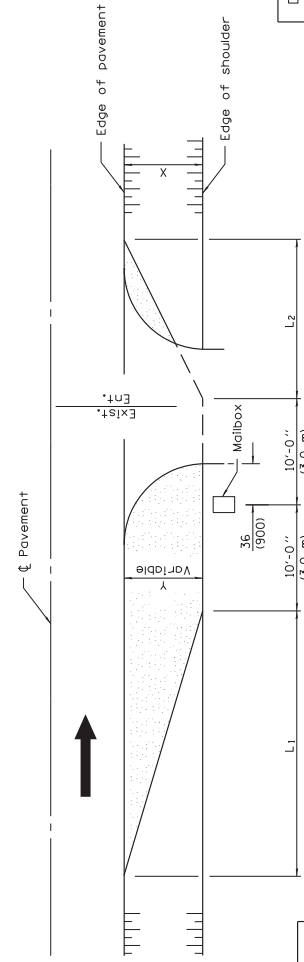

**MAILBOX ON NEAR SIDE OF ENTRANCE**

DIMENSIONS - ft., (m)										
Width of Shoulder (X)	12 (3.6)	10 (3.0)	8 (2.4)	6 (1.8)	5 (1.5)	4 (1.2)				
Width of Turnout (Y)	8 (2.4)	8 (2.4)	6 (1.8)	4 (1.2)	4 (1.2)	4 (1.2)				
L1	30 (9.0)	30 (9.0)	23 (6.9)	15 (4.5)	15 (4.5)	15 (4.5)				
L2	20 (6.0)	20 (6.0)	15 (4.5)	10 (3.0)	10 (3.0)	10 (3.0)				

Note:  
Dimensions for Township and District Roads may vary from the above dimensions.

**GENERAL NOTES**

Mailboxes shall be mounted such that the face of the mailbox is 6 (150) to 12 (300) and the post a minimum of 24 (600) from the edge of the turnout surfacing.

All dimensions are in inches (millimeters) unless otherwise shown.

DATE	REVISIONS
1-1-09	Switched units to English (metric).
1-1-99	Add width of shoulder X.

Illinois Department of Transportation  
 APPROVED January 1, 2009  
*Shirley J. [Signature]*  
 ENGINEER OF LOCAL ROADS AND STREETS  
 APPROVED January 1, 2009  
*Lee S. [Signature]*  
 ENGINEER OF DESIGN AND ENVIRONMENT  
 ISSUED 1-1-97

**MAILBOX TURNOUT FOR LOCAL ROADS**

STANDARD B.L.R. 24-2



## REQUIRED CONTRACT PROVISIONS FEDERAL-AID CONSTRUCTION CONTRACTS

- I. General
- II. Nondiscrimination
- III. Nonsegregated Facilities
- IV. Davis-Bacon and Related Act Provisions
- V. Contract Work Hours and Safety Standards Act Provisions
- VI. Subletting or Assigning the Contract
- VII. Safety: Accident Prevention
- VIII. False Statements Concerning Highway Projects
- IX. Implementation of Clean Air Act and Federal Water Pollution Control Act
- X. Compliance with Governmentwide Suspension and Debarment Requirements
- XI. Certification Regarding Use of Contract Funds for Lobbying

### ATTACHMENTS

A. Employment and Materials Preference for Appalachian Development Highway System or Appalachian Local Access Road Contracts (included in Appalachian contracts only)

#### I. GENERAL

1. Form FHWA-1273 must be physically incorporated in each construction contract funded under Title 23 (excluding emergency contracts solely intended for debris removal). The contractor (or subcontractor) must insert this form in each subcontract and further require its inclusion in all lower tier subcontracts (excluding purchase orders, rental agreements and other agreements for supplies or services).

The applicable requirements of Form FHWA-1273 are incorporated by reference for work done under any purchase order, rental agreement or agreement for other services. The prime contractor shall be responsible for compliance by any subcontractor, lower-tier subcontractor or service provider.

Form FHWA-1273 must be included in all Federal-aid design-build contracts, in all subcontracts and in lower tier subcontracts (excluding subcontracts for design services, purchase orders, rental agreements and other agreements for supplies or services). The design-builder shall be responsible for compliance by any subcontractor, lower-tier subcontractor or service provider.

Contracting agencies may reference Form FHWA-1273 in bid proposal or request for proposal documents, however, the Form FHWA-1273 must be physically incorporated (not referenced) in all contracts, subcontracts and lower-tier subcontracts (excluding purchase orders, rental agreements and other agreements for supplies or services related to a construction contract).

2. Subject to the applicability criteria noted in the following sections, these contract provisions shall apply to all work performed on the contract by the contractor's own organization and with the assistance of workers under the contractor's immediate superintendence and to all work performed on the contract by piecework, station work, or by subcontract.

3. A breach of any of the stipulations contained in these Required Contract Provisions may be sufficient grounds for withholding of progress payments, withholding of final payment, termination of the contract, suspension / debarment or any other action determined to be appropriate by the contracting agency and FHWA.

4. Selection of Labor: During the performance of this contract, the contractor shall not use convict labor for any purpose within the limits of a construction project on a Federal-aid highway unless it is labor

performed by convicts who are on parole, supervised release, or probation. The term Federal-aid highway does not include roadways functionally classified as local roads or rural minor collectors.

#### II. NONDISCRIMINATION

The provisions of this section related to 23 CFR Part 230 are applicable to all Federal-aid construction contracts and to all related construction subcontracts of \$10,000 or more. The provisions of 23 CFR Part 230 are not applicable to material supply, engineering, or architectural service contracts.

In addition, the contractor and all subcontractors must comply with the following policies: Executive Order 11246, 41 CFR 60, 29 CFR 1625-1627, Title 23 USC Section 140, the Rehabilitation Act of 1973, as amended (29 USC 794), Title VI of the Civil Rights Act of 1964, as amended, and related regulations including 49 CFR Parts 21, 26 and 27; and 23 CFR Parts 200, 230, and 633.

The contractor and all subcontractors must comply with: the requirements of the Equal Opportunity Clause in 41 CFR 60-1.4(b) and, for all construction contracts exceeding \$10,000, the Standard Federal Equal Employment Opportunity Construction Contract Specifications in 41 CFR 60-4.3.

Note: The U.S. Department of Labor has exclusive authority to determine compliance with Executive Order 11246 and the policies of the Secretary of Labor including 41 CFR 60, and 29 CFR 1625-1627. The contracting agency and the FHWA have the authority and the responsibility to ensure compliance with Title 23 USC Section 140, the Rehabilitation Act of 1973, as amended (29 USC 794), and Title VI of the Civil Rights Act of 1964, as amended, and related regulations including 49 CFR Parts 21, 26 and 27; and 23 CFR Parts 200, 230, and 633.

The following provision is adopted from 23 CFR 230, Appendix A, with appropriate revisions to conform to the U.S. Department of Labor (US DOL) and FHWA requirements.

**1. Equal Employment Opportunity:** Equal employment opportunity (EEO) requirements not to discriminate and to take affirmative action to assure equal opportunity as set forth under laws, executive orders, rules, regulations (28 CFR 35, 29 CFR 1630, 29 CFR 1625-1627, 41 CFR 60 and 49 CFR 27) and orders of the Secretary of Labor as modified by the provisions prescribed herein, and imposed pursuant to 23 U.S.C. 140 shall constitute the EEO and specific affirmative action standards for the contractor's project activities under this contract. The provisions of the Americans with Disabilities Act of 1990 (42 U.S.C. 12101 et seq.) set forth under 28 CFR 35 and 29 CFR 1630 are incorporated by reference in this contract. In the execution of this contract, the contractor agrees to comply with the following minimum specific requirement activities of EEO:

a. The contractor will work with the contracting agency and the Federal Government to ensure that it has made every good faith effort to provide equal opportunity with respect to all of its terms and conditions of employment and in their review of activities under the contract.

b. The contractor will accept as its operating policy the following statement:

"It is the policy of this Company to assure that applicants are employed, and that employees are treated during employment, without regard to their race, religion, sex, color, national origin, age or disability. Such action shall include: employment, upgrading, demotion, or transfer; recruitment or recruitment advertising; layoff or termination; rates of pay or other forms of compensation; and selection

for training, including apprenticeship, pre-apprenticeship, and/or on-the-job training."

**2. EEO Officer:** The contractor will designate and make known to the contracting officers an EEO Officer who will have the responsibility for and must be capable of effectively administering and promoting an active EEO program and who must be assigned adequate authority and responsibility to do so.

**3. Dissemination of Policy:** All members of the contractor's staff who are authorized to hire, supervise, promote, and discharge employees, or who recommend such action, or who are substantially involved in such action, will be made fully cognizant of, and will implement, the contractor's EEO policy and contractual responsibilities to provide EEO in each grade and classification of employment. To ensure that the above agreement will be met, the following actions will be taken as a minimum:

a. Periodic meetings of supervisory and personnel office employees will be conducted before the start of work and then not less often than once every six months, at which time the contractor's EEO policy and its implementation will be reviewed and explained. The meetings will be conducted by the EEO Officer.

b. All new supervisory or personnel office employees will be given a thorough indoctrination by the EEO Officer, covering all major aspects of the contractor's EEO obligations within thirty days following their reporting for duty with the contractor.

c. All personnel who are engaged in direct recruitment for the project will be instructed by the EEO Officer in the contractor's procedures for locating and hiring minorities and women.

d. Notices and posters setting forth the contractor's EEO policy will be placed in areas readily accessible to employees, applicants for employment and potential employees.

e. The contractor's EEO policy and the procedures to implement such policy will be brought to the attention of employees by means of meetings, employee handbooks, or other appropriate means.

**4. Recruitment:** When advertising for employees, the contractor will include in all advertisements for employees the notation: "An Equal Opportunity Employer." All such advertisements will be placed in publications having a large circulation among minorities and women in the area from which the project work force would normally be derived.

a. The contractor will, unless precluded by a valid bargaining agreement, conduct systematic and direct recruitment through public and private employee referral sources likely to yield qualified minorities and women. To meet this requirement, the contractor will identify sources of potential minority group employees, and establish with such identified sources procedures whereby minority and women applicants may be referred to the contractor for employment consideration.

b. In the event the contractor has a valid bargaining agreement providing for exclusive hiring hall referrals, the contractor is expected to observe the provisions of that agreement to the extent that the system meets the contractor's compliance with EEO contract provisions. Where implementation of such an agreement has the effect of discriminating against minorities or women, or obligates the contractor to do the same, such implementation violates Federal nondiscrimination provisions.

c. The contractor will encourage its present employees to refer minorities and women as applicants for employment. Information and procedures with regard to referring such applicants will be discussed with employees.

**5. Personnel Actions:** Wages, working conditions, and employee benefits shall be established and administered, and personnel actions of every type, including hiring, upgrading, promotion, transfer, demotion, layoff, and termination, shall be taken without regard to race, color, religion, sex, national origin, age or disability. The following procedures shall be followed:

a. The contractor will conduct periodic inspections of project sites to insure that working conditions and employee facilities do not indicate discriminatory treatment of project site personnel.

b. The contractor will periodically evaluate the spread of wages paid within each classification to determine any evidence of discriminatory wage practices.

c. The contractor will periodically review selected personnel actions in depth to determine whether there is evidence of discrimination. Where evidence is found, the contractor will promptly take corrective action. If the review indicates that the discrimination may extend beyond the actions reviewed, such corrective action shall include all affected persons.

d. The contractor will promptly investigate all complaints of alleged discrimination made to the contractor in connection with its obligations under this contract, will attempt to resolve such complaints, and will take appropriate corrective action within a reasonable time. If the investigation indicates that the discrimination may affect persons other than the complainant, such corrective action shall include such other persons. Upon completion of each investigation, the contractor will inform every complainant of all of their avenues of appeal.

## **6. Training and Promotion:**

a. The contractor will assist in locating, qualifying, and increasing the skills of minorities and women who are applicants for employment or current employees. Such efforts should be aimed at developing full journey level status employees in the type of trade or job classification involved.

b. Consistent with the contractor's work force requirements and as permissible under Federal and State regulations, the contractor shall make full use of training programs, i.e., apprenticeship, and on-the-job training programs for the geographical area of contract performance. In the event a special provision for training is provided under this contract, this subparagraph will be superseded as indicated in the special provision. The contracting agency may reserve training positions for persons who receive welfare assistance in accordance with 23 U.S.C. 140(a).

c. The contractor will advise employees and applicants for employment of available training programs and entrance requirements for each.

d. The contractor will periodically review the training and promotion potential of employees who are minorities and women and will encourage eligible employees to apply for such training and promotion.

**7. Unions:** If the contractor relies in whole or in part upon unions as a source of employees, the contractor will use good faith efforts to obtain the cooperation of such unions to increase opportunities for minorities and women. Actions by the contractor, either directly or through a contractor's association acting as agent, will include the procedures set forth below:

a. The contractor will use good faith efforts to develop, in cooperation with the unions, joint training programs aimed toward qualifying more minorities and women for membership in the unions and increasing the skills of minorities and women so that they may qualify for higher paying employment.

b. The contractor will use good faith efforts to incorporate an EEO clause into each union agreement to the end that such union will be contractually bound to refer applicants without regard to their race, color, religion, sex, national origin, age or disability.

c. The contractor is to obtain information as to the referral practices and policies of the labor union except that to the extent such information is within the exclusive possession of the labor union and such labor union refuses to furnish such information to the contractor, the contractor shall so certify to the contracting agency and shall set forth what efforts have been made to obtain such information.

d. In the event the union is unable to provide the contractor with a reasonable flow of referrals within the time limit set forth in the collective bargaining agreement, the contractor will, through independent recruitment efforts, fill the employment vacancies without regard to race, color, religion, sex, national origin, age or disability; making full efforts to obtain qualified and/or qualifiable minorities and women. The failure of a union to provide sufficient referrals (even though it is obligated to provide exclusive referrals under the terms of a collective bargaining agreement) does not relieve the contractor from the requirements of this paragraph. In the event the union referral practice prevents the contractor from meeting the obligations pursuant to Executive Order 11246, as amended, and these special provisions, such contractor shall immediately notify the contracting agency.

**8. Reasonable Accommodation for Applicants / Employees with Disabilities:** The contractor must be familiar with the requirements for and comply with the Americans with Disabilities Act and all rules and regulations established there under. Employers must provide reasonable accommodation in all employment activities unless to do so would cause an undue hardship.

**9. Selection of Subcontractors, Procurement of Materials and Leasing of Equipment:** The contractor shall not discriminate on the grounds of race, color, religion, sex, national origin, age or disability in the selection and retention of subcontractors, including procurement of materials and leases of equipment. The contractor shall take all necessary and reasonable steps to ensure nondiscrimination in the administration of this contract.

a. The contractor shall notify all potential subcontractors and suppliers and lessors of their EEO obligations under this contract.

b. The contractor will use good faith efforts to ensure subcontractor compliance with their EEO obligations.

#### **10. Assurance Required by 49 CFR 26.13(b):**

a. The requirements of 49 CFR Part 26 and the State DOT's U.S. DOT-approved DBE program are incorporated by reference.

b. The contractor or subcontractor shall not discriminate on the basis of race, color, national origin, or sex in the performance of this contract. The contractor shall carry out applicable requirements of 49 CFR Part 26 in the award and administration of DOT-assisted contracts. Failure by the contractor to carry out these requirements is a material breach of this contract, which may result in the termination of this contract or such other remedy as the contracting agency deems appropriate.

**11. Records and Reports:** The contractor shall keep such records as necessary to document compliance with the EEO requirements. Such records shall be retained for a period of three years following the date of the final payment to the contractor for all contract work and shall be available at reasonable times and places for inspection by authorized representatives of the contracting agency and the FHWA.

a. The records kept by the contractor shall document the following:

(1) The number and work hours of minority and non-minority group members and women employed in each work classification on the project;

(2) The progress and efforts being made in cooperation with unions, when applicable, to increase employment opportunities for minorities and women; and

(3) The progress and efforts being made in locating, hiring, training, qualifying, and upgrading minorities and women;

b. The contractors and subcontractors will submit an annual report to the contracting agency each July for the duration of the project, indicating the number of minority, women, and non-minority group employees currently engaged in each work classification required by the contract work. This information is to be reported on [Form FHWA-1391](#).

The staffing data should represent the project work force on board in all or any part of the last payroll period preceding the end of July. If on-the-job training is being required by special provision, the contractor will be required to collect and report training data. The employment data should reflect the work force on board during all or any part of the last payroll period preceding the end of July.

### **III. NONSEGREGATED FACILITIES**

This provision is applicable to all Federal-aid construction contracts and to all related construction subcontracts of \$10,000 or more.

The contractor must ensure that facilities provided for employees are provided in such a manner that segregation on the basis of race, color, religion, sex, or national origin cannot result. The contractor may neither require such segregated use by written or oral policies nor tolerate such use by employee custom. The contractor's obligation extends further to ensure that its employees are not assigned to perform their services at any location, under the contractor's control, where the facilities are segregated. The term "facilities" includes waiting rooms, work areas, restaurants and other eating areas, time clocks, restrooms, washrooms, locker rooms, and other storage or dressing areas, parking lots, drinking fountains, recreation or entertainment areas, transportation, and housing provided for employees. The contractor shall provide separate or single-user restrooms and necessary dressing or sleeping areas to assure privacy between sexes.

### **IV. DAVIS-BACON AND RELATED ACT PROVISIONS**

This section is applicable to all Federal-aid construction projects exceeding \$2,000 and to all related subcontracts and lower-tier subcontracts (regardless of subcontract size). The requirements apply to all projects located within the right-of-way of a roadway that is functionally classified as Federal-aid highway. This excludes roadways functionally classified as local roads or rural minor collectors, which are exempt. Contracting agencies may elect to apply these requirements to other projects.

The following provisions are from the U.S. Department of Labor regulations in 29 CFR 5.5 "Contract provisions and related matters" with minor revisions to conform to the FHWA-1273 format and FHWA program requirements.

#### **1. Minimum wages**

a. All laborers and mechanics employed or working upon the site of the work, will be paid unconditionally and not less often than once a week, and without subsequent deduction or rebate on any account (except such payroll deductions as are permitted by regulations issued by the Secretary of Labor under the Copeland Act (29 CFR part 3)), the full amount of wages and bona fide fringe benefits (or cash equivalents thereof) due at time of payment computed at rates not less than those contained in the wage determination of the Secretary of Labor which is attached hereto and made a part hereof, regardless of any contractual relationship which may be alleged to exist between the contractor and such laborers and mechanics.

Contributions made or costs reasonably anticipated for bona fide fringe benefits under section 1(b)(2) of the Davis-Bacon Act on behalf of laborers or mechanics are considered wages paid to such laborers or mechanics, subject to the provisions of paragraph 1.d. of this section; also, regular contributions made or costs incurred for more than a weekly period (but not less often than quarterly) under plans, funds, or programs which cover the particular weekly period, are deemed to be constructively made or incurred during such weekly period. Such laborers and mechanics shall be paid the appropriate wage rate and fringe benefits on the wage determination for the classification of work actually performed, without regard to skill, except as provided in 29 CFR 5.5(a)(4). Laborers or mechanics performing work in more than one classification may be compensated at the rate specified for each

classification for the time actually worked therein: Provided, That the employer's payroll records accurately set forth the time spent in each classification in which work is performed. The wage determination (including any additional classification and wage rates conformed under paragraph 1.b. of this section) and the Davis-Bacon poster (WH-1321) shall be posted at all times by the contractor and its subcontractors at the site of the work in a prominent and accessible place where it can be easily seen by the workers.

b. (1) The contracting officer shall require that any class of laborers or mechanics, including helpers, which is not listed in the wage determination and which is to be employed under the contract shall be classified in conformance with the wage determination. The contracting officer shall approve an additional classification and wage rate and fringe benefits therefore only when the following criteria have been met:

(i) The work to be performed by the classification requested is not performed by a classification in the wage determination; and

(ii) The classification is utilized in the area by the construction industry; and

(iii) The proposed wage rate, including any bona fide fringe benefits, bears a reasonable relationship to the wage rates contained in the wage determination.

(2) If the contractor and the laborers and mechanics to be employed in the classification (if known), or their representatives, and the contracting officer agree on the classification and wage rate (including the amount designated for fringe benefits where appropriate), a report of the action taken shall be sent by the contracting officer to the Administrator of the Wage and Hour Division, Employment Standards Administration, U.S. Department of Labor, Washington, DC 20210. The Administrator, or an authorized representative, will approve, modify, or disapprove every additional classification action within 30 days of receipt and so advise the contracting officer or will notify the contracting officer within the 30-day period that additional time is necessary.

(3) In the event the contractor, the laborers or mechanics to be employed in the classification or their representatives, and the contracting officer do not agree on the proposed classification and wage rate (including the amount designated for fringe benefits, where appropriate), the contracting officer shall refer the questions, including the views of all interested parties and the recommendation of the contracting officer, to the Wage and Hour Administrator for determination. The Wage and Hour Administrator, or an authorized representative, will issue a determination within 30 days of receipt and so advise the contracting officer or will notify the contracting officer within the 30-day period that additional time is necessary.

(4) The wage rate (including fringe benefits where appropriate) determined pursuant to paragraphs 1.b.(2) or 1.b.(3) of this section, shall be paid to all workers performing work in the classification under this contract from the first day on which work is performed in the classification.

c. Whenever the minimum wage rate prescribed in the contract for a class of laborers or mechanics includes a fringe benefit which is not expressed as an hourly rate, the contractor shall either pay the benefit as stated in the wage determination or shall pay another bona fide fringe benefit or an hourly cash equivalent thereof.

d. If the contractor does not make payments to a trustee or other third person, the contractor may consider as part of the wages of any laborer or mechanic the amount of any costs reasonably anticipated in providing bona fide fringe benefits under a plan or program, Provided, That the Secretary of Labor has found, upon the written request of the contractor, that the applicable standards of the Davis-Bacon Act have been met. The Secretary of Labor may require the contractor to set aside in a

separate account assets for the meeting of obligations under the plan or program.

## 2. Withholding

The contracting agency shall upon its own action or upon written request of an authorized representative of the Department of Labor, withhold or cause to be withheld from the contractor under this contract, or any other Federal contract with the same prime contractor, or any other federally-assisted contract subject to Davis-Bacon prevailing wage requirements, which is held by the same prime contractor, so much of the accrued payments or advances as may be considered necessary to pay laborers and mechanics, including apprentices, trainees, and helpers, employed by the contractor or any subcontractor the full amount of wages required by the contract. In the event of failure to pay any laborer or mechanic, including any apprentice, trainee, or helper, employed or working on the site of the work, all or part of the wages required by the contract, the contracting agency may, after written notice to the contractor, take such action as may be necessary to cause the suspension of any further payment, advance, or guarantee of funds until such violations have ceased.

## 3. Payrolls and basic records

a. Payrolls and basic records relating thereto shall be maintained by the contractor during the course of the work and preserved for a period of three years thereafter for all laborers and mechanics working at the site of the work. Such records shall contain the name, address, and social security number of each such worker, his or her correct classification, hourly rates of wages paid (including rates of contributions or costs anticipated for bona fide fringe benefits or cash equivalents thereof of the types described in section 1(b)(2)(B) of the Davis-Bacon Act), daily and weekly number of hours worked, deductions made and actual wages paid. Whenever the Secretary of Labor has found under 29 CFR 5.5(a)(1)(iv) that the wages of any laborer or mechanic include the amount of any costs reasonably anticipated in providing benefits under a plan or program described in section 1(b)(2)(B) of the Davis-Bacon Act, the contractor shall maintain records which show that the commitment to provide such benefits is enforceable, that the plan or program is financially responsible, and that the plan or program has been communicated in writing to the laborers or mechanics affected, and records which show the costs anticipated or the actual cost incurred in providing such benefits. Contractors employing apprentices or trainees under approved programs shall maintain written evidence of the registration of apprenticeship programs and certification of trainee programs, the registration of the apprentices and trainees, and the ratios and wage rates prescribed in the applicable programs.

b. (1) The contractor shall submit weekly for each week in which any contract work is performed a copy of all payrolls to the contracting agency. The payrolls submitted shall set out accurately and completely all of the information required to be maintained under 29 CFR 5.5(a)(3)(i), except that full social security numbers and home addresses shall not be included on weekly transmittals. Instead the payrolls shall only need to include an individually identifying number for each employee ( e.g. , the last four digits of the employee's social security number). The required weekly payroll information may be submitted in any form desired. Optional Form WH-347 is available for this purpose from the Wage and Hour Division Web site at <http://www.dol.gov/esa/whd/forms/wh347instr.htm> or its successor site. The prime contractor is responsible for the submission of copies of payrolls by all subcontractors. Contractors and subcontractors shall maintain the full social security number and current address of each covered worker, and shall provide them upon request to the contracting agency for transmission to the State DOT, the FHWA or the Wage and Hour Division of the Department of Labor for purposes of an investigation or audit of compliance with prevailing wage requirements. It is not a violation of this section for a prime contractor to require a subcontractor to provide addresses and social security numbers to the prime contractor for its own records, without weekly submission to the contracting agency..

(2) Each payroll submitted shall be accompanied by a "Statement of Compliance," signed by the contractor or subcontractor or his or her agent who pays or supervises the payment of the persons employed under the contract and shall certify the following:

(i) That the payroll for the payroll period contains the information required to be provided under §5.5 (a)(3)(ii) of Regulations, 29 CFR part 5, the appropriate information is being maintained under §5.5 (a)(3)(i) of Regulations, 29 CFR part 5, and that such information is correct and complete;

(ii) That each laborer or mechanic (including each helper, apprentice, and trainee) employed on the contract during the payroll period has been paid the full weekly wages earned, without rebate, either directly or indirectly, and that no deductions have been made either directly or indirectly from the full wages earned, other than permissible deductions as set forth in Regulations, 29 CFR part 3;

(iii) That each laborer or mechanic has been paid not less than the applicable wage rates and fringe benefits or cash equivalents for the classification of work performed, as specified in the applicable wage determination incorporated into the contract.

(3) The weekly submission of a properly executed certification set forth on the reverse side of Optional Form WH-347 shall satisfy the requirement for submission of the "Statement of Compliance" required by paragraph 3.b.(2) of this section.

(4) The falsification of any of the above certifications may subject the contractor or subcontractor to civil or criminal prosecution under section 1001 of title 18 and section 231 of title 31 of the United States Code.

c. The contractor or subcontractor shall make the records required under paragraph 3.a. of this section available for inspection, copying, or transcription by authorized representatives of the contracting agency, the State DOT, the FHWA, or the Department of Labor, and shall permit such representatives to interview employees during working hours on the job. If the contractor or subcontractor fails to submit the required records or to make them available, the FHWA may, after written notice to the contractor, the contracting agency or the State DOT, take such action as may be necessary to cause the suspension of any further payment, advance, or guarantee of funds. Furthermore, failure to submit the required records upon request or to make such records available may be grounds for debarment action pursuant to 29 CFR 5.12.

#### 4. Apprentices and trainees

##### a. Apprentices (programs of the USDOL).

Apprentices will be permitted to work at less than the predetermined rate for the work they performed when they are employed pursuant to and individually registered in a bona fide apprenticeship program registered with the U.S. Department of Labor, Employment and Training Administration, Office of Apprenticeship Training, Employer and Labor Services, or with a State Apprenticeship Agency recognized by the Office, or if a person is employed in his or her first 90 days of probationary employment as an apprentice in such an apprenticeship program, who is not individually registered in the program, but who has been certified by the Office of Apprenticeship Training, Employer and Labor Services or a State Apprenticeship Agency (where appropriate) to be eligible for probationary employment as an apprentice.

The allowable ratio of apprentices to journeymen on the job site in any craft classification shall not be greater than the ratio permitted to the contractor as to the entire work force under the registered program. Any worker listed on a payroll at an apprentice wage rate, who is not registered or otherwise employed as stated above, shall be paid not less than the applicable wage rate on the wage determination for the classification of work actually performed. In addition, any apprentice

performing work on the job site in excess of the ratio permitted under the registered program shall be paid not less than the applicable wage rate on the wage determination for the work actually performed. Where a contractor is performing construction on a project in a locality other than that in which its program is registered, the ratios and wage rates (expressed in percentages of the journeyman's hourly rate) specified in the contractor's or subcontractor's registered program shall be observed.

Every apprentice must be paid at not less than the rate specified in the registered program for the apprentice's level of progress, expressed as a percentage of the journeymen hourly rate specified in the applicable wage determination. Apprentices shall be paid fringe benefits in accordance with the provisions of the apprenticeship program. If the apprenticeship program does not specify fringe benefits, apprentices must be paid the full amount of fringe benefits listed on the wage determination for the applicable classification. If the Administrator determines that a different practice prevails for the applicable apprentice classification, fringes shall be paid in accordance with that determination.

In the event the Office of Apprenticeship Training, Employer and Labor Services, or a State Apprenticeship Agency recognized by the Office, withdraws approval of an apprenticeship program, the contractor will no longer be permitted to utilize apprentices at less than the applicable predetermined rate for the work performed until an acceptable program is approved.

##### b. Trainees (programs of the USDOL).

Except as provided in 29 CFR 5.16, trainees will not be permitted to work at less than the predetermined rate for the work performed unless they are employed pursuant to and individually registered in a program which has received prior approval, evidenced by formal certification by the U.S. Department of Labor, Employment and Training Administration.

The ratio of trainees to journeymen on the job site shall not be greater than permitted under the plan approved by the Employment and Training Administration.

Every trainee must be paid at not less than the rate specified in the approved program for the trainee's level of progress, expressed as a percentage of the journeyman hourly rate specified in the applicable wage determination. Trainees shall be paid fringe benefits in accordance with the provisions of the trainee program. If the trainee program does not mention fringe benefits, trainees shall be paid the full amount of fringe benefits listed on the wage determination unless the Administrator of the Wage and Hour Division determines that there is an apprenticeship program associated with the corresponding journeyman wage rate on the wage determination which provides for less than full fringe benefits for apprentices. Any employee listed on the payroll at a trainee rate who is not registered and participating in a training plan approved by the Employment and Training Administration shall be paid not less than the applicable wage rate on the wage determination for the classification of work actually performed. In addition, any trainee performing work on the job site in excess of the ratio permitted under the registered program shall be paid not less than the applicable wage rate on the wage determination for the work actually performed.

In the event the Employment and Training Administration withdraws approval of a training program, the contractor will no longer be permitted to utilize trainees at less than the applicable predetermined rate for the work performed until an acceptable program is approved.

c. Equal employment opportunity. The utilization of apprentices, trainees and journeymen under this part shall be in conformity with the equal employment opportunity requirements of Executive Order 11246, as amended, and 29 CFR part 30.

##### d. Apprentices and Trainees (programs of the U.S. DOT).

Apprentices and trainees working under apprenticeship and skill training programs which have been certified by the Secretary of Transportation as promoting EEO in connection with Federal-aid highway construction programs are not subject to the requirements of paragraph 4 of this Section IV. The straight time hourly wage rates for apprentices and trainees under such programs will be established by the particular programs. The ratio of apprentices and trainees to journeymen shall not be greater than permitted by the terms of the particular program.

**5. Compliance with Copeland Act requirements.** The contractor shall comply with the requirements of 29 CFR part 3, which are incorporated by reference in this contract.

**6. Subcontracts.** The contractor or subcontractor shall insert Form FHWA-1273 in any subcontracts and also require the subcontractors to include Form FHWA-1273 in any lower tier subcontracts. The prime contractor shall be responsible for the compliance by any subcontractor or lower tier subcontractor with all the contract clauses in 29 CFR 5.5.

**7. Contract termination: debarment.** A breach of the contract clauses in 29 CFR 5.5 may be grounds for termination of the contract, and for debarment as a contractor and a subcontractor as provided in 29 CFR 5.12.

**8. Compliance with Davis-Bacon and Related Act requirements.** All rulings and interpretations of the Davis-Bacon and Related Acts contained in 29 CFR parts 1, 3, and 5 are herein incorporated by reference in this contract.

**9. Disputes concerning labor standards.** Disputes arising out of the labor standards provisions of this contract shall not be subject to the general disputes clause of this contract. Such disputes shall be resolved in accordance with the procedures of the Department of Labor set forth in 29 CFR parts 5, 6, and 7. Disputes within the meaning of this clause include disputes between the contractor (or any of its subcontractors) and the contracting agency, the U.S. Department of Labor, or the employees or their representatives.

#### **10. Certification of eligibility.**

a. By entering into this contract, the contractor certifies that neither it (nor he or she) nor any person or firm who has an interest in the contractor's firm is a person or firm ineligible to be awarded Government contracts by virtue of section 3(a) of the Davis-Bacon Act or 29 CFR 5.12(a)(1).

b. No part of this contract shall be subcontracted to any person or firm ineligible for award of a Government contract by virtue of section 3(a) of the Davis-Bacon Act or 29 CFR 5.12(a)(1).

c. The penalty for making false statements is prescribed in the U.S. Criminal Code, 18 U.S.C. 1001.

#### **V. CONTRACT WORK HOURS AND SAFETY STANDARDS ACT**

The following clauses apply to any Federal-aid construction contract in an amount in excess of \$100,000 and subject to the overtime provisions of the Contract Work Hours and Safety Standards Act. These clauses shall be inserted in addition to the clauses required by 29 CFR 5.5(a) or 29 CFR 4.6. As used in this paragraph, the terms laborers and mechanics include watchmen and guards.

**1. Overtime requirements.** No contractor or subcontractor contracting for any part of the contract work which may require or involve the employment of laborers or mechanics shall require or permit any such laborer or mechanic in any workweek in which he or she is employed on such work to work in excess of forty hours in such workweek unless such laborer or mechanic receives compensation at a rate not less than one

and one-half times the basic rate of pay for all hours worked in excess of forty hours in such workweek.

**2. Violation; liability for unpaid wages; liquidated damages.** In the event of any violation of the clause set forth in paragraph (1.) of this section, the contractor and any subcontractor responsible therefor shall be liable for the unpaid wages. In addition, such contractor and subcontractor shall be liable to the United States (in the case of work done under contract for the District of Columbia or a territory, to such District or to such territory), for liquidated damages. Such liquidated damages shall be computed with respect to each individual laborer or mechanic, including watchmen and guards, employed in violation of the clause set forth in paragraph (1.) of this section, in the sum of \$10 for each calendar day on which such individual was required or permitted to work in excess of the standard workweek of forty hours without payment of the overtime wages required by the clause set forth in paragraph (1.) of this section.

**3. Withholding for unpaid wages and liquidated damages.** The FHWA or the contracting agency shall upon its own action or upon written request of an authorized representative of the Department of Labor withhold or cause to be withheld, from any moneys payable on account of work performed by the contractor or subcontractor under any such contract or any other Federal contract with the same prime contractor, or any other federally-assisted contract subject to the Contract Work Hours and Safety Standards Act, which is held by the same prime contractor, such sums as may be determined to be necessary to satisfy any liabilities of such contractor or subcontractor for unpaid wages and liquidated damages as provided in the clause set forth in paragraph (2.) of this section.

**4. Subcontracts.** The contractor or subcontractor shall insert in any subcontracts the clauses set forth in paragraph (1.) through (4.) of this section and also a clause requiring the subcontractors to include these clauses in any lower tier subcontracts. The prime contractor shall be responsible for compliance by any subcontractor or lower tier subcontractor with the clauses set forth in paragraphs (1.) through (4.) of this section.

#### **VI. SUBLETTING OR ASSIGNING THE CONTRACT**

This provision is applicable to all Federal-aid construction contracts on the National Highway System.

1. The contractor shall perform with its own organization contract work amounting to not less than 30 percent (or a greater percentage if specified elsewhere in the contract) of the total original contract price, excluding any specialty items designated by the contracting agency. Specialty items may be performed by subcontract and the amount of any such specialty items performed may be deducted from the total original contract price before computing the amount of work required to be performed by the contractor's own organization (23 CFR 635.116).

a. The term "perform work with its own organization" refers to workers employed or leased by the prime contractor, and equipment owned or rented by the prime contractor, with or without operators. Such term does not include employees or equipment of a subcontractor or lower tier subcontractor, agents of the prime contractor, or any other assignees. The term may include payments for the costs of hiring leased employees from an employee leasing firm meeting all relevant Federal and State regulatory requirements. Leased employees may only be included in this term if the prime contractor meets all of the following conditions:

(1) the prime contractor maintains control over the supervision of the day-to-day activities of the leased employees;

(2) the prime contractor remains responsible for the quality of the work of the leased employees;

(3) the prime contractor retains all power to accept or exclude individual employees from work on the project; and

(4) the prime contractor remains ultimately responsible for the payment of predetermined minimum wages, the submission of payrolls, statements of compliance and all other Federal regulatory requirements.

b. "Specialty Items" shall be construed to be limited to work that requires highly specialized knowledge, abilities, or equipment not ordinarily available in the type of contracting organizations qualified and expected to bid or propose on the contract as a whole and in general are to be limited to minor components of the overall contract.

2. The contract amount upon which the requirements set forth in paragraph (1) of Section VI is computed includes the cost of material and manufactured products which are to be purchased or produced by the contractor under the contract provisions.

3. The contractor shall furnish (a) a competent superintendent or supervisor who is employed by the firm, has full authority to direct performance of the work in accordance with the contract requirements, and is in charge of all construction operations (regardless of who performs the work) and (b) such other of its own organizational resources (supervision, management, and engineering services) as the contracting officer determines is necessary to assure the performance of the contract.

4. No portion of the contract shall be sublet, assigned or otherwise disposed of except with the written consent of the contracting officer, or authorized representative, and such consent when given shall not be construed to relieve the contractor of any responsibility for the fulfillment of the contract. Written consent will be given only after the contracting agency has assured that each subcontract is evidenced in writing and that it contains all pertinent provisions and requirements of the prime contract.

5. The 30% self-performance requirement of paragraph (1) is not applicable to design-build contracts; however, contracting agencies may establish their own self-performance requirements.

## VII. SAFETY: ACCIDENT PREVENTION

This provision is applicable to all Federal-aid construction contracts and to all related subcontracts.

1. In the performance of this contract the contractor shall comply with all applicable Federal, State, and local laws governing safety, health, and sanitation (23 CFR 635). The contractor shall provide all safeguards, safety devices and protective equipment and take any other needed actions as it determines, or as the contracting officer may determine, to be reasonably necessary to protect the life and health of employees on the job and the safety of the public and to protect property in connection with the performance of the work covered by the contract.

2. It is a condition of this contract, and shall be made a condition of each subcontract, which the contractor enters into pursuant to this contract, that the contractor and any subcontractor shall not permit any employee, in performance of the contract, to work in surroundings or under conditions which are unsanitary, hazardous or dangerous to his/her health or safety, as determined under construction safety and health standards (29 CFR 1926) promulgated by the Secretary of Labor, in accordance with Section 107 of the Contract Work Hours and Safety Standards Act (40 U.S.C. 3704).

3. Pursuant to 29 CFR 1926.3, it is a condition of this contract that the Secretary of Labor or authorized representative thereof, shall have right of entry to any site of contract performance to inspect or investigate the matter of compliance with the construction safety and health standards and to carry out the duties of the Secretary under Section 107 of the Contract Work Hours and Safety Standards Act (40 U.S.C.3704).

## VIII. FALSE STATEMENTS CONCERNING HIGHWAY PROJECTS

This provision is applicable to all Federal-aid construction contracts and to all related subcontracts.

In order to assure high quality and durable construction in conformity with approved plans and specifications and a high degree of reliability on statements and representations made by engineers, contractors, suppliers, and workers on Federal-aid highway projects, it is essential that all persons concerned with the project perform their functions as carefully, thoroughly, and honestly as possible. Willful falsification, distortion, or misrepresentation with respect to any facts related to the project is a violation of Federal law. To prevent any misunderstanding regarding the seriousness of these and similar acts, Form FHWA-1022 shall be posted on each Federal-aid highway project (23 CFR 635) in one or more places where it is readily available to all persons concerned with the project:

18 U.S.C. 1020 reads as follows:

"Whoever, being an officer, agent, or employee of the United States, or of any State or Territory, or whoever, whether a person, association, firm, or corporation, knowingly makes any false statement, false representation, or false report as to the character, quality, quantity, or cost of the material used or to be used, or the quantity or quality of the work performed or to be performed, or the cost thereof in connection with the submission of plans, maps, specifications, contracts, or costs of construction on any highway or related project submitted for approval to the Secretary of Transportation; or

Whoever knowingly makes any false statement, false representation, false report or false claim with respect to the character, quality, quantity, or cost of any work performed or to be performed, or materials furnished or to be furnished, in connection with the construction of any highway or related project approved by the Secretary of Transportation; or

Whoever knowingly makes any false statement or false representation as to material fact in any statement, certificate, or report submitted pursuant to provisions of the Federal-aid Roads Act approved July 1, 1916, (39 Stat. 355), as amended and supplemented;

Shall be fined under this title or imprisoned not more than 5 years or both."

## IX. IMPLEMENTATION OF CLEAN AIR ACT AND FEDERAL WATER POLLUTION CONTROL ACT

This provision is applicable to all Federal-aid construction contracts and to all related subcontracts.

By submission of this bid/proposal or the execution of this contract, or subcontract, as appropriate, the bidder, proposer, Federal-aid construction contractor, or subcontractor, as appropriate, will be deemed to have stipulated as follows:

1. That any person who is or will be utilized in the performance of this contract is not prohibited from receiving an award due to a violation of Section 508 of the Clean Water Act or Section 306 of the Clean Air Act.

2. That the contractor agrees to include or cause to be included the requirements of paragraph (1) of this Section X in every subcontract, and further agrees to take such action as the contracting agency may direct as a means of enforcing such requirements.

## X. CERTIFICATION REGARDING DEBARMENT, SUSPENSION, INELIGIBILITY AND VOLUNTARY EXCLUSION

This provision is applicable to all Federal-aid construction contracts, design-build contracts, subcontracts, lower-tier subcontracts, purchase orders, lease agreements, consultant contracts or any other covered transaction requiring FHWA approval or that is estimated to cost \$25,000 or more – as defined in 2 CFR Parts 180 and 1200.

### 1. Instructions for Certification – First Tier Participants:



a. By signing and submitting this proposal, the prospective first tier participant is providing the certification set out below.

b. The inability of a person to provide the certification set out below will not necessarily result in denial of participation in this covered transaction. The prospective first tier participant shall submit an explanation of why it cannot provide the certification set out below. The certification or explanation will be considered in connection with the department or agency's determination whether to enter into this transaction. However, failure of the prospective first tier participant to furnish a certification or an explanation shall disqualify such a person from participation in this transaction.

c. The certification in this clause is a material representation of fact upon which reliance was placed when the contracting agency determined to enter into this transaction. If it is later determined that the prospective participant knowingly rendered an erroneous certification, in addition to other remedies available to the Federal Government, the contracting agency may terminate this transaction for cause of default.

d. The prospective first tier participant shall provide immediate written notice to the contracting agency to whom this proposal is submitted if any time the prospective first tier participant learns that its certification was erroneous when submitted or has become erroneous by reason of changed circumstances.

e. The terms "covered transaction," "debarred," "suspended," "ineligible," "participant," "person," "principal," and "voluntarily excluded," as used in this clause, are defined in 2 CFR Parts 180 and 1200. "First Tier Covered Transactions" refers to any covered transaction between a grantee or subgrantee of Federal funds and a participant (such as the prime or general contract). "Lower Tier Covered Transactions" refers to any covered transaction under a First Tier Covered Transaction (such as subcontracts). "First Tier Participant" refers to the participant who has entered into a covered transaction with a grantee or subgrantee of Federal funds (such as the prime or general contractor). "Lower Tier Participant" refers any participant who has entered into a covered transaction with a First Tier Participant or other Lower Tier Participants (such as subcontractors and suppliers).

f. The prospective first tier participant agrees by submitting this proposal that, should the proposed covered transaction be entered into, it shall not knowingly enter into any lower tier covered transaction with a person who is debarred, suspended, declared ineligible, or voluntarily excluded from participation in this covered transaction, unless authorized by the department or agency entering into this transaction.

g. The prospective first tier participant further agrees by submitting this proposal that it will include the clause titled "Certification Regarding Debarment, Suspension, Ineligibility and Voluntary Exclusion-Lower Tier Covered Transactions," provided by the department or contracting agency, entering into this covered transaction, without modification, in all lower tier covered transactions and in all solicitations for lower tier covered transactions exceeding the \$25,000 threshold.

h. A participant in a covered transaction may rely upon a certification of a prospective participant in a lower tier covered transaction that is not debarred, suspended, ineligible, or voluntarily excluded from the covered transaction, unless it knows that the certification is erroneous. A participant is responsible for ensuring that its principals are not suspended, debarred, or otherwise ineligible to participate in covered transactions. To verify the eligibility of its principals, as well as the eligibility of any lower tier prospective participants, each participant may, but is not required to, check the Excluded Parties List System website (<https://www.epls.gov/>), which is compiled by the General Services Administration.

i. Nothing contained in the foregoing shall be construed to require the establishment of a system of records in order to render in good faith the certification required by this clause. The knowledge and information of the prospective participant is not required to exceed that which is normally possessed by a prudent person in the ordinary course of business dealings.

j. Except for transactions authorized under paragraph (f) of these instructions, if a participant in a covered transaction knowingly enters into a lower tier covered transaction with a person who is suspended, debarred, ineligible, or voluntarily excluded from participation in this transaction, in addition to other remedies available to the Federal Government, the department or agency may terminate this transaction for cause or default.

\*\*\*\*\*

## **2. Certification Regarding Debarment, Suspension, Ineligibility and Voluntary Exclusion – First Tier Participants:**

a. The prospective first tier participant certifies to the best of its knowledge and belief, that it and its principals:

(1) Are not presently debarred, suspended, proposed for debarment, declared ineligible, or voluntarily excluded from participating in covered transactions by any Federal department or agency;

(2) Have not within a three-year period preceding this proposal been convicted of or had a civil judgment rendered against them for commission of fraud or a criminal offense in connection with obtaining, attempting to obtain, or performing a public (Federal, State or local) transaction or contract under a public transaction; violation of Federal or State antitrust statutes or commission of embezzlement, theft, forgery, bribery, falsification or destruction of records, making false statements, or receiving stolen property;

(3) Are not presently indicted for or otherwise criminally or civilly charged by a governmental entity (Federal, State or local) with commission of any of the offenses enumerated in paragraph (a)(2) of this certification; and

(4) Have not within a three-year period preceding this application/proposal had one or more public transactions (Federal, State or local) terminated for cause or default.

b. Where the prospective participant is unable to certify to any of the statements in this certification, such prospective participant shall attach an explanation to this proposal.

### **2. Instructions for Certification - Lower Tier Participants:**

(Applicable to all subcontracts, purchase orders and other lower tier transactions requiring prior FHWA approval or estimated to cost \$25,000 or more - 2 CFR Parts 180 and 1200)

a. By signing and submitting this proposal, the prospective lower tier is providing the certification set out below.

b. The certification in this clause is a material representation of fact upon which reliance was placed when this transaction was entered into. If it is later determined that the prospective lower tier participant knowingly rendered an erroneous certification, in addition to other remedies available to the Federal Government, the department, or agency with which this transaction originated may pursue available remedies, including suspension and/or debarment.

c. The prospective lower tier participant shall provide immediate written notice to the person to which this proposal is submitted if at any time the prospective lower tier participant learns that its certification was erroneous by reason of changed circumstances.

d. The terms "covered transaction," "debarred," "suspended," "ineligible," "participant," "person," "principal," and "voluntarily excluded," as used in this clause, are defined in 2 CFR Parts 180 and 1200. You may contact the person to which this proposal is submitted for assistance in obtaining a copy of those regulations. "First Tier Covered Transactions" refers to any covered transaction between a grantee or subgrantee of Federal funds and a participant (such as the prime or general contract). "Lower Tier Covered Transactions" refers to any covered transaction under a First Tier Covered Transaction (such as subcontracts). "First Tier Participant" refers to the participant who has entered into a covered transaction with a grantee or subgrantee of



Federal funds (such as the prime or general contractor). "Lower Tier Participant" refers any participant who has entered into a covered transaction with a First Tier Participant or other Lower Tier Participants (such as subcontractors and suppliers).

e. The prospective lower tier participant agrees by submitting this proposal that, should the proposed covered transaction be entered into, it shall not knowingly enter into any lower tier covered transaction with a person who is debarred, suspended, declared ineligible, or voluntarily excluded from participation in this covered transaction, unless authorized by the department or agency with which this transaction originated.

f. The prospective lower tier participant further agrees by submitting this proposal that it will include this clause titled "Certification Regarding Debarment, Suspension, Ineligibility and Voluntary Exclusion-Lower Tier Covered Transaction," without modification, in all lower tier covered transactions and in all solicitations for lower tier covered transactions exceeding the \$25,000 threshold.

g. A participant in a covered transaction may rely upon a certification of a prospective participant in a lower tier covered transaction that is not debarred, suspended, ineligible, or voluntarily excluded from the covered transaction, unless it knows that the certification is erroneous. A participant is responsible for ensuring that its principals are not suspended, debarred, or otherwise ineligible to participate in covered transactions. To verify the eligibility of its principals, as well as the eligibility of any lower tier prospective participants, each participant may, but is not required to, check the Excluded Parties List System website (<https://www.epls.gov/>), which is compiled by the General Services Administration.

h. Nothing contained in the foregoing shall be construed to require establishment of a system of records in order to render in good faith the certification required by this clause. The knowledge and information of participant is not required to exceed that which is normally possessed by a prudent person in the ordinary course of business dealings.

i. Except for transactions authorized under paragraph e of these instructions, if a participant in a covered transaction knowingly enters into a lower tier covered transaction with a person who is suspended, debarred, ineligible, or voluntarily excluded from participation in this transaction, in addition to other remedies available to the Federal Government, the department or agency with which this transaction originated may pursue available remedies, including suspension and/or debarment.

\* \* \* \* \*

#### **Certification Regarding Debarment, Suspension, Ineligibility and Voluntary Exclusion--Lower Tier Participants:**

1. The prospective lower tier participant certifies, by submission of this proposal, that neither it nor its principals is presently debarred, suspended, proposed for debarment, declared ineligible, or voluntarily excluded from participating in covered transactions by any Federal department or agency.

2. Where the prospective lower tier participant is unable to certify to any of the statements in this certification, such prospective participant shall attach an explanation to this proposal.

\* \* \* \* \*

#### **XI. CERTIFICATION REGARDING USE OF CONTRACT FUNDS FOR LOBBYING**

This provision is applicable to all Federal-aid construction contracts and to all related subcontracts which exceed \$100,000 (49 CFR 20).

1. The prospective participant certifies, by signing and submitting this bid or proposal, to the best of his or her knowledge and belief, that:

a. No Federal appropriated funds have been paid or will be paid, by or on behalf of the undersigned, to any person for influencing or attempting to influence an officer or employee of any Federal agency, a Member of

Congress, an officer or employee of Congress, or an employee of a Member of Congress in connection with the awarding of any Federal contract, the making of any Federal grant, the making of any Federal loan, the entering into of any cooperative agreement, and the extension, continuation, renewal, amendment, or modification of any Federal contract, grant, loan, or cooperative agreement.

b. If any funds other than Federal appropriated funds have been paid or will be paid to any person for influencing or attempting to influence an officer or employee of any Federal agency, a Member of Congress, an officer or employee of Congress, or an employee of a Member of Congress in connection with this Federal contract, grant, loan, or cooperative agreement, the undersigned shall complete and submit Standard Form-LLL, "Disclosure Form to Report Lobbying," in accordance with its instructions.

2. This certification is a material representation of fact upon which reliance was placed when this transaction was made or entered into. Submission of this certification is a prerequisite for making or entering into this transaction imposed by 31 U.S.C. 1352. Any person who fails to file the required certification shall be subject to a civil penalty of not less than \$10,000 and not more than \$100,000 for each such failure.

3. The prospective participant also agrees by submitting its bid or proposal that the participant shall require that the language of this certification be included in all lower tier subcontracts, which exceed \$100,000 and that all such recipients shall certify and disclose accordingly.

**ATTACHMENT A - EMPLOYMENT AND MATERIALS PREFERENCE FOR APPALACHIAN DEVELOPMENT HIGHWAY SYSTEM OR APPALACHIAN LOCAL ACCESS ROAD CONTRACTS**

This provision is applicable to all Federal-aid projects funded under the Appalachian Regional Development Act of 1965.

1. During the performance of this contract, the contractor undertaking to do work which is, or reasonably may be, done as on-site work, shall give preference to qualified persons who regularly reside in the labor area as designated by the DOL wherein the contract work is situated, or the subregion, or the Appalachian counties of the State wherein the contract work is situated, except:

a. To the extent that qualified persons regularly residing in the area are not available.

b. For the reasonable needs of the contractor to employ supervisory or specially experienced personnel necessary to assure an efficient execution of the contract work.

c. For the obligation of the contractor to offer employment to present or former employees as the result of a lawful collective bargaining contract, provided that the number of nonresident persons employed under this subparagraph (1c) shall not exceed 20 percent of the total number of employees employed by the contractor on the contract work, except as provided in subparagraph (4) below.

2. The contractor shall place a job order with the State Employment Service indicating (a) the classifications of the laborers, mechanics and other employees required to perform the contract work, (b) the number of employees required in each classification, (c) the date on which the participant estimates such employees will be required, and (d) any other pertinent information required by the State Employment Service to complete the job order form. The job order may be placed with the State Employment Service in writing or by telephone. If during the course of the contract work, the information submitted by the contractor in the original job order is substantially modified, the participant shall promptly notify the State Employment Service.

3. The contractor shall give full consideration to all qualified job applicants referred to him by the State Employment Service. The contractor is not required to grant employment to any job applicants who, in his opinion, are not qualified to perform the classification of work required.

4. If, within one week following the placing of a job order by the contractor with the State Employment Service, the State Employment Service is unable to refer any qualified job applicants to the contractor, or less than the number requested, the State Employment Service will forward a certificate to the contractor indicating the unavailability of applicants. Such certificate shall be made a part of the contractor's permanent project records. Upon receipt of this certificate, the contractor may employ persons who do not normally reside in the labor area to fill positions covered by the certificate, notwithstanding the provisions of subparagraph (1c) above.

5. The provisions of 23 CFR 633.207(e) allow the contracting agency to provide a contractual preference for the use of mineral resource materials native to the Appalachian region.

6. The contractor shall include the provisions of Sections 1 through 4 of this Attachment A in every subcontract for work which is, or reasonably may be, done as on-site work.

## Contract Provision - Cargo Preference Requirements

In accordance with Title 46 CFR § 381.7 (b), the contractor agrees—

“(1) To utilize privately owned United States-flag commercial vessels to ship at least 50 percent of the gross tonnage (computed separately for dry bulk carriers, dry cargo liners, and tankers) involved, whenever shipping any equipment, material, or commodities pursuant to this contract, to the extent such vessels are available at fair and reasonable rates for United States-flag commercial vessels.

(2) To furnish within 20 days following the date of loading for shipments originating within the United States or within 30 working days following the date of loading for shipments originating outside the United States, a legible copy of a rated, ‘on-board’ commercial ocean bill-of-lading in English for each shipment of cargo described in paragraph (b) (1) of this section to both the Contracting Officer (through the prime contractor in the case of subcontractor bills-of-lading) and to the Division of National Cargo, Office of Market Development, Maritime Administration, Washington, DC 20590.

(3) To insert the substance of the provisions of this clause in all subcontracts issued pursuant to this contract.”

Provisions (1) and (2) apply to materials or equipment that are acquired solely for the project. The two provisions do not apply to goods or materials that come into inventories independent of the project, such as shipments of Portland cement, asphalt cement, or aggregates, when industry suppliers and contractors use these materials to replenish existing inventories.

**MINIMUM WAGES FOR FEDERAL AND FEDERALLY  
ASSISTED CONSTRUCTION CONTRACTS**

This project is funded, in part, with Federal-aid funds and, as such, is subject to the provisions of the Davis-Bacon Act of March 3, 1931, as amended (46 Sta. 1494, as amended, 40 U.S.C. 276a) and of other Federal statutes referred to in a 29 CFR Part 1, Appendix A, as well as such additional statutes as may from time to time be enacted containing provisions for the payment of wages determined to be prevailing by the Secretary of Labor in accordance with the Davis-Bacon Act and pursuant to the provisions of 29 CFR Part 1. The prevailing rates and fringe benefits shown in the General Wage Determination Decisions issued by the U.S. Department of Labor shall, in accordance with the provisions of the foregoing statutes, constitute the minimum wages payable on Federal and federally assisted construction projects to laborers and mechanics of the specified classes engaged on contract work of the character and in the localities described therein.

General Wage Determination Decisions, modifications and supersedes decisions thereto are to be used in accordance with the provisions of 29 CFR Parts 1 and 5. Accordingly, the applicable decision, together with any modifications issued, must be made a part of every contract for performance of the described work within the geographic area indicated as required by an applicable DBRA Federal prevailing wage law and 29 CFR Part 5. The wage rates and fringe benefits contained in the General Wage Determination Decision shall be the minimum paid by contractors and subcontractors to laborers and mechanics.