

STATE OF ILLINOIS
DEPARTMENT OF TRANSPORTATION

ROUTE NO.	SECTION	COUNTY	STA. SHEETS	SHEET NO.	SHEET NO. 27 32 SHEETS
F.A.I. 57	★	COOK	75 53		
FED. ROAD DIST. NO. 7		ILLINOIS	FED. AID PROJECT-		

Contract 60366
★ 2122B

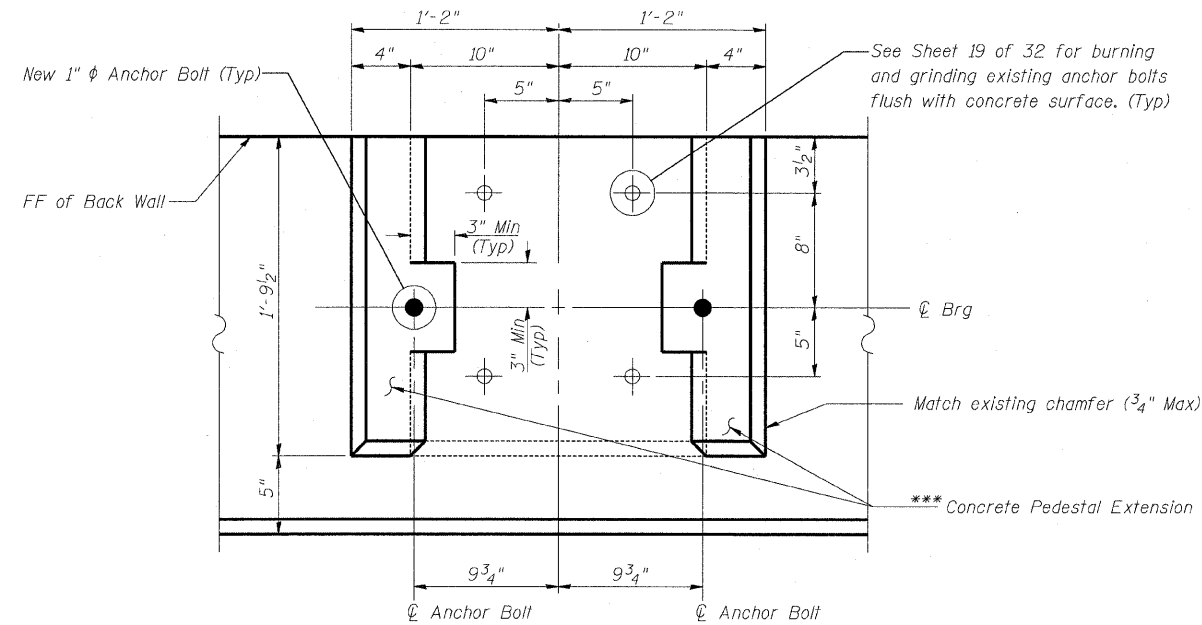

ANCHOR BOLT LAYOUT DETAIL C

*** Remove existing bearing seat pedestal within 3" minimum around new anchor bolt location down to top of existing beam seat. Clean surface below concrete pedestal extension of debris, calcification deposits and any other foreign (non-concrete) material. Construct pedestal extension to locations shown level with existing concrete pedestal. If resulting surface is uneven, grind smooth. Cost included with Concrete Structures.

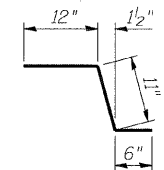

BAR c21(E)

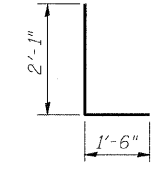

BAR d24(E)

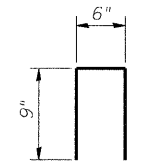

BAR d20(E)

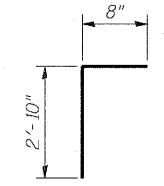

BAR v20(E)

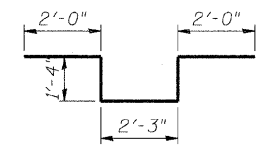

BARS d23(E)

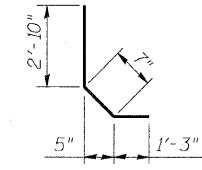

BAR v21(E)

BILL OF MATERIAL

Bar	No.	Size	Length	Shape
c20(E)	4	#5	7'-2"	—
c21(E)	4	#5	2'-5"	—
c22(E)	8	#5	3'-0"	—
d20(E)	32	#4	2'-0"	□
d21(E)	124	#6	2'-11"	—
d22(E)	228	#5	2'-1"	—
d23(E)	8	#6	8'-11"	—
d24(E)	6	#6	3'-7"	—
h20(E)	22	#5	32'-2"	—
h21(E)	8	#6	32'-2"	—
h22(E)	12	#5	9'-8"	—
h23(E)	24	#5	17'-8"	—
h24(E)	12	#5	1'-8"	—
h25(E)	32	#5	2'-6"	—
v20(E)	66	#4	3'-6"	—
v21(E)	66	#4	4'-8"	—
v22(E)	132	#4	3'-5"	—
v23(E)	50	#5	3'-10"	—
v24(E)	66	#4	3'-4"	—
Structure Excavation		Cu Yd	22.0	
Concrete Structures		Cu Yd	17.0	
Concrete Superstructure		Cu Yd	14.2	
Protective Coat		Sq Yd	47	
Reinforcement Bars, Epoxy Coated		Pound	4090	
Bar Splicers		Each	65	
Concrete Sealer		Sq Ft	511	

Notes:

- For location of Detail C, see Sheet 25 of 32.
- For details of Bar Splicers, see Sheet 31 of 32.

DESIGNED	NDR
CHECKED	DSE
DRAWN	RTT
CHECKED	DSE
DATE	JAN 16, 2009

Illinois Firm Registration No: 084-008533

8501 West Higgins Road, Suite 730, Chicago, Illinois 60631-2801
www.stanleygroup.com

EAST ABUTMENT DETAILS
103RD STREET OVER
FAI 57 (DAN RYAN-WEST LEG)
FAI RTE 57 SECTION 2122B
COOK COUNTY
STA 5+47.40
STRUCTURE NO 016-2127