

STATE OF ILLINOIS  
DEPARTMENT OF TRANSPORTATION

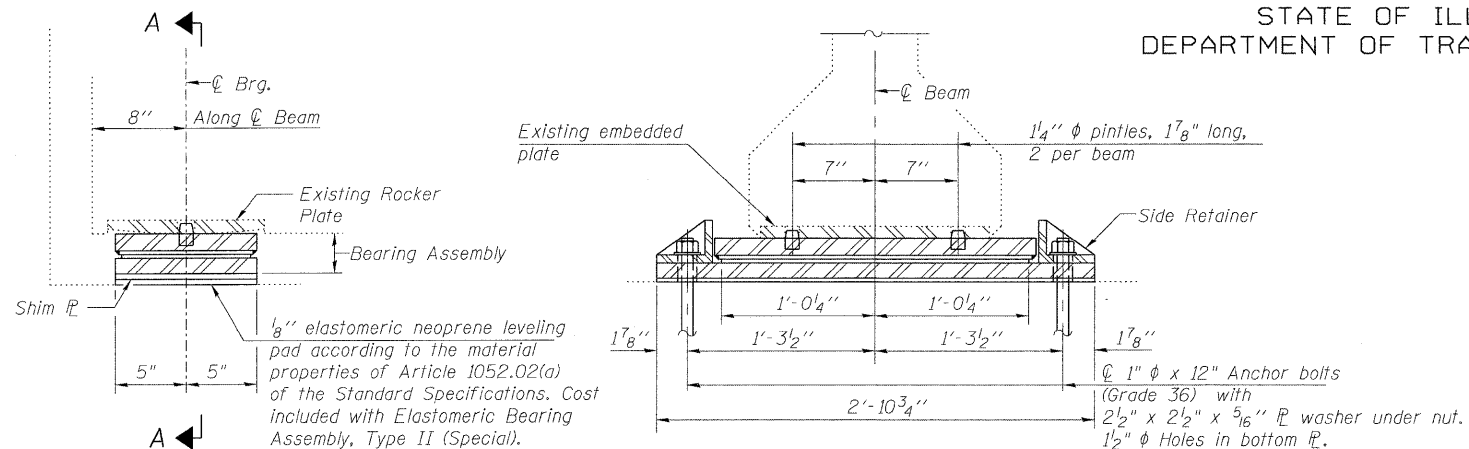

SECTION AT ABUT.

(Anchor bolt not shown)

SECTION A-A

TYPE II ELASTOMERIC EXP. BRG. AT ABUTMENTS

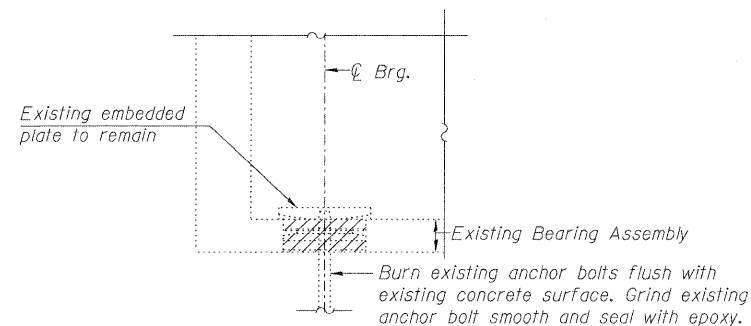

EXISTING BEARING REMOVAL DETAIL

Cost included with Jack and Remove Existing Bearings.

REQUIRED SHIM PLATE TABLE		
Beam	Location	Size
1	South Abut.	9/16" x 10" x 2'-10 3/4"
1	North Abut.	9/16" x 10" x 2'-10 3/4"

Note: Beam 1 is the closest beam to CL IL Rte 53

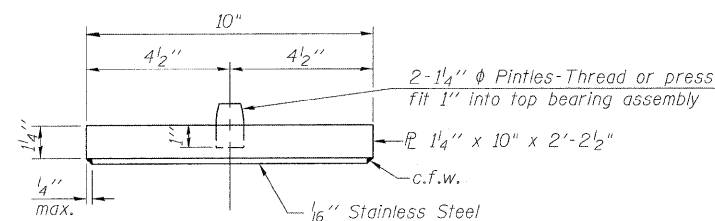

TOP BEARING ASSEMBLY

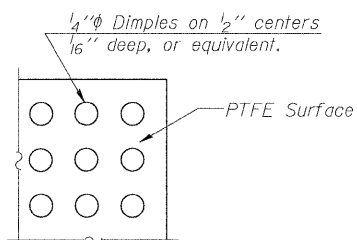

PLAN-PTFE SURFACE

INTERIOR BEAM REACTION TABLE		
R <sub>1</sub>	(k)	35.0
R <sub>2</sub>	(k)	43.0
R <sub>3</sub>	(k)	12.0
R <sub>Total</sub>	(k)	90.0

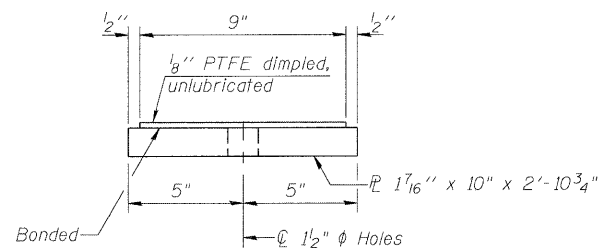

BOTTOM BEARING ASSEMBLY

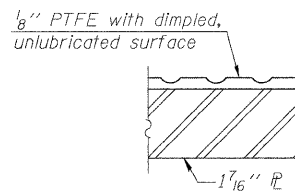

SECTION THRU PTFE

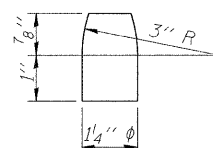

PINTLE

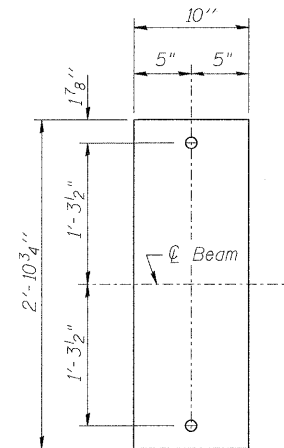

PLAN OF BOTTOM PLATE

Notes:

The structural steel plates of the bearing assembly shall conform to the requirements of AASHTO M270 Grade 50.

Anchor bolts shall be ASTM F1554 all-thread (or an Engineer-approved alternate material) of the grade(s) and diameter(s) specified. ASTM A307 Grade C anchor bolts may be used in lieu of ASTM F1554 Grade 36 (Fy=36ksi). The corresponding specified grade of AASHTO M314 anchor bolts may be used in lieu of ASTM F1554.

Anchor bolts for Type II bearings shall be placed in holes in the concrete drilled through holes in the bottom bearing plate after members are in place. Side retainers shall be placed after bolts are installed.

Drilled and set anchor bolts shall be installed according to Article 521.06 of the Standard Specifications.

Side retainers and other steel members required for the bearing assembly shall be included in the cost of Elastomeric Bearing Assembly, Type II (Special).

The 1/8" PTFE sheet shall be bonded directly to the top steel plate with a two-component, medium viscosity epoxy resin, conforming to the requirements of the Federal Specification MMM-A-134, Type I. The bond agent shall be applied on the full area of the contact surfaces.

Bonding of 1/8" PTFE sheet during vulcanizing process will be permitted provided the process and method of adjusting assembly height is approved by the Engineer.

All bearing plates, side retainers, anchor bolts, nuts, washers and pintles shall be galvanized according to AASHTO M111 or M232 as applicable.

Minimum jack capacity = 50 Tons

Cost of all bearing plates, side retainers and labor required to install them will be paid for at the contract unit price cost per each for Elastomeric Bearing Assembly, Type II (Special).

BILL OF MATERIAL

Item	Unit	Total
Elastomeric Bearing Assembly, Type II (Special)	Each	18
Anchor Bolts, 1"	Each	36
Jack and Remove Existing Bearings	Each	18

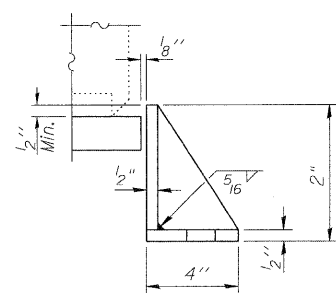

SIDE RETAINER

Equivalent rolled angle with stiffeners will be allowed in lieu of welded plates.

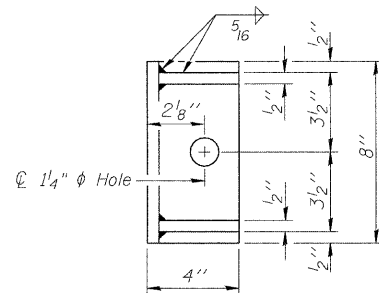

SETTING ANCHOR BOLTS AT EXP. BRG.

D=1/8" per each 100' of expansion for every 15° temp. change from the normal temp. of 50°F.

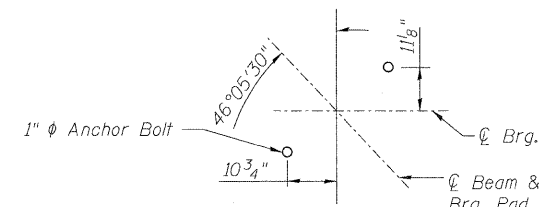
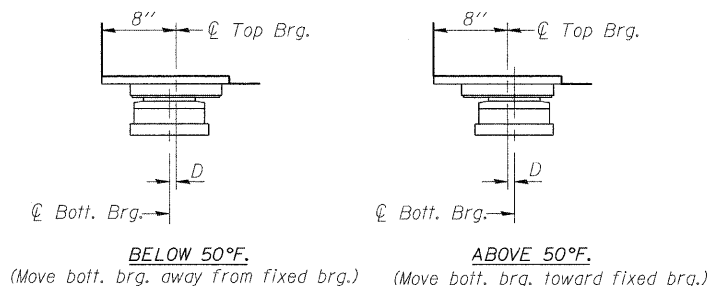

ANCHOR BOLT LOCATION

BEARING DETAILS  
STRUCTURE NO. 016-0973

<p>LIN ENGINEERING LTD. Consulting Engineers Chatham, Illinois</p>	SHEET NO. 7  11 SHEETS	F.A.I. RTE.	SECTION	COUNTY	TOTAL SHEETS	SHEET NO.
		290	(531-3.1,0305-302K)RS-5	COOK	314	141
		CONTRACT NO. 60138				
		FED. ROAD DIST. NO. - ILLINOIS FED. AID PROJECT				