

SIGN G20-1102

COLOR: BACKGROUND - FLOURESCENT ORANGE (*)
 BORDER AND LETTERS - BLACK
 SIZE: 48"x24"
 LETTERING: 6" FEDERAL SERIES C,
 MOUNTING HOLES: 7/16" DIA., 4 HOLES SPACED AS SHOWN
 ON SIGN G20-2A

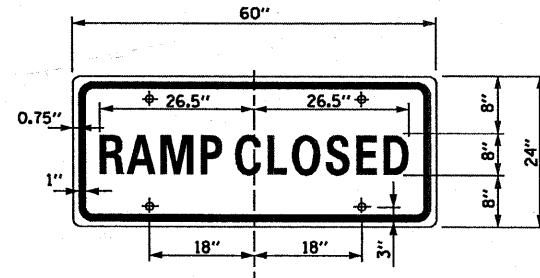

SIGN TS-6

COLOR: BACKGROUND - WHITE (REFLECTORIZED)
 BORDER AND LETTERS - BLACK
 SIZE: 60"x24"
 LETTERING: 8" FEDERAL SERIES C
 MOUNTING HOLES: 7/16" DIA., 4 HOLES SPACED AS SHOWN

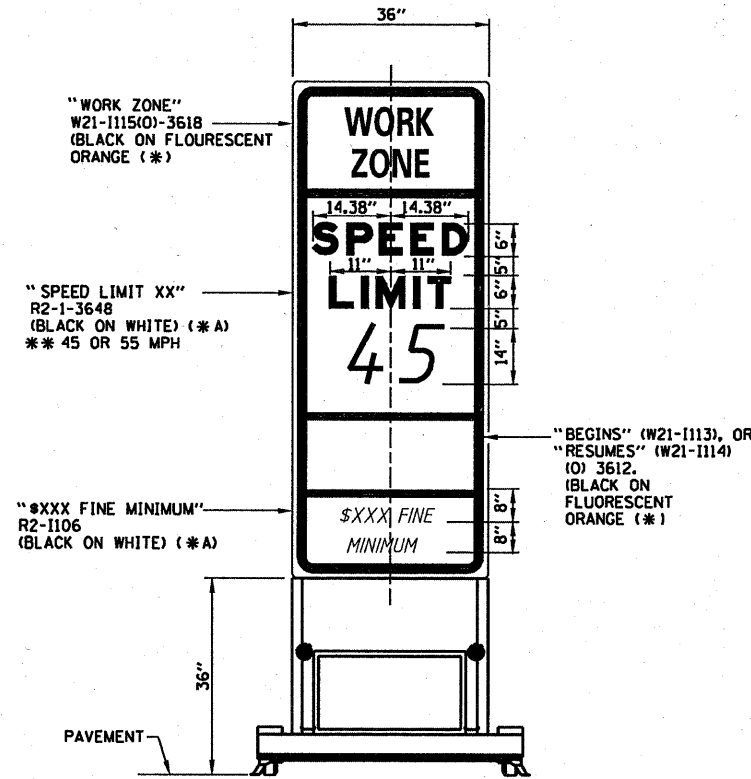

**WORK ZONE SPEED LIMIT
SIGN ASSEMBLY**

"WORK ZONE"
 W21-1115(10)-3618
 (BLACK ON FLOURESCENT
 ORANGE (*)
 "SPEED LIMIT XX"
 R2-1-3648
 (BLACK ON WHITE) (*A)
 ** 45 OR 55 MPH

"BEGINS" (W21-1113), OR
 "RESUMES" (W21-1114)
 (O) 3612,
 (BLACK ON
 FLOURESCENT
 ORANGE (*)

"XXX FINE MINIMUM"
 R2-1106
 (BLACK ON WHITE) (*A)

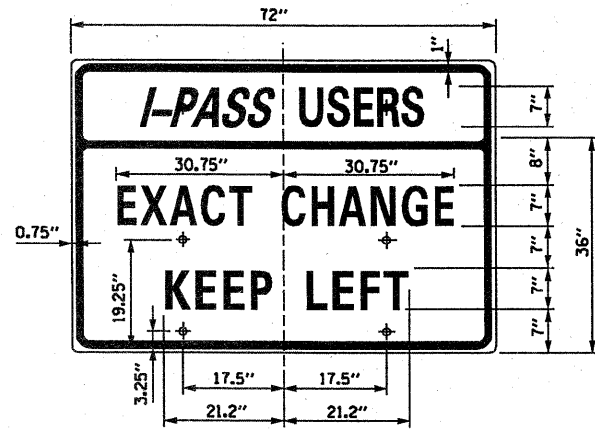

SIGN TS-7

COLOR: BACKGROUND - WHITE (REFLECTORIZED) (*A)
 BORDER AND LETTERS - BLACK
 SIZE: 72"x36"
 LETTERING: 7" FEDERAL SERIES C
 MOUNTING HOLES: 7/16" DIA., 4 HOLES SPACED AS SHOWN

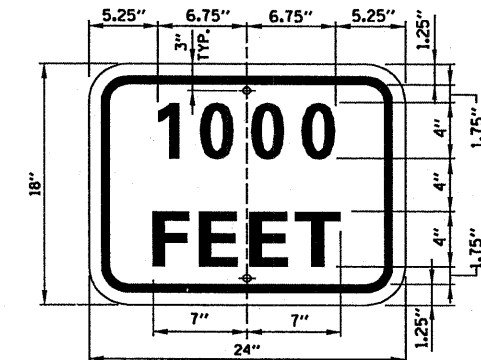

SUPPLEMENTAL PLATE

COLOR: BACKGROUND - FLOURESCENT ORANGE (*)
 BORDER AND LETTERS - BLACK
 SIZE: 24"x18"
 LETTERING: 4" FEDERAL SERIES D
 MOUNTING HOLES: 7/16" DIA.

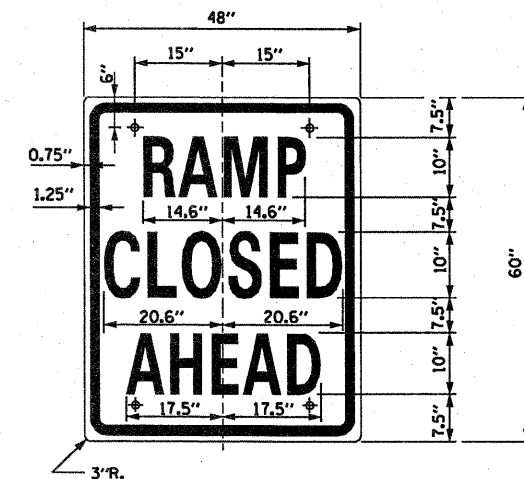

SIGN TS-9

COLOR: BACKGROUND - WHITE (REFLECTORIZED)
 BORDER AND LETTERS - BLACK
 SIZE: 48"x60"
 LETTERING: 10" FEDERAL SERIES C
 MOUNTING HOLES: 7/16" DIA., 4 HOLES SPACED AS SHOWN

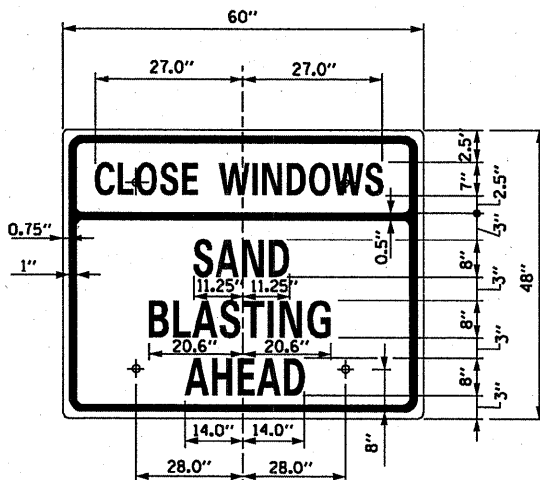

SIGN TS-10

COLOR: BACKGROUND - FLOURESCENT ORANGE (*)
 BORDER AND LETTERS - BLACK
 SIZE: 60"x48"
 LETTERING: 8" FEDERAL SERIES C, 7" FEDERAL SERIES B
 MOUNTING HOLES: 7/16" DIA., 4 HOLES SPACED AS SHOWN

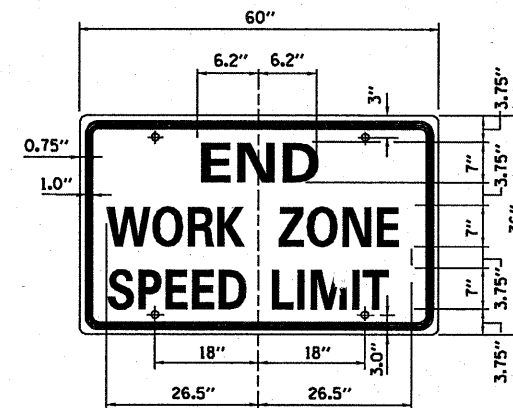

SIGN G20-1103

COLOR: BACKGROUND - FLOURESCENT ORANGE (*)
 BORDER AND LETTERS - BLACK
 SIZE: 60"x36"
 LETTERING: 6" FEDERAL SERIES C,
 MOUNTING HOLES: 7/16" DIA., 4 HOLES SPACED AS SHOWN

GENERAL NOTES:

- ALL LETTERING IS DESIGNATED BY SIZE AND SERIES IN ACCORDANCE WITH THE LATEST EDITION OF "STANDARD ALPHABETS FOR HIGHWAY SIGNS AND PAVEMENT MARKINGS" AS PUBLISHED BY THE U.S. DEPARTMENT OF TRANSPORTATION. LETTERING SPACING SHALL BE IN ACCORDANCE WITH THE GUIDE EXCEPT WHERE NOTED.
 - SYMBOLS AND ARROWS SHALL CONFORM TO THE DETAILS SHOWN IN THE LATEST EDITION OF "STANDARD HIGHWAY SIGNS" AS PUBLISHED BY THE U.S. DEPARTMENT OF TRANSPORTATION.
 - SEE THE CONTRACT REQUIREMENTS FOR ADDITIONAL NOTES AND SPECIFICATIONS.
- (*) FLOURESCENT ORANGE REFLECTIVE SHEETING PER THE STANDARD SPECIFICATIONS.
 (*A) REFLECTIVE SHEETING PER THE STANDARD SPECIFICATIONS.

