

**PIER 1**  
**ELEVATION, SOUTH FACE**  
**(LOOKING NORTH)**

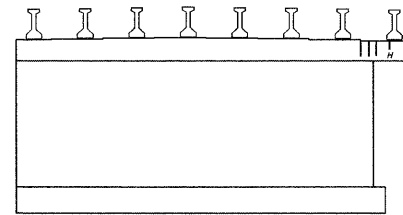

**PIER 1**  
**ELEVATION, NORTH FACE**  
**(LOOKING SOUTH)**

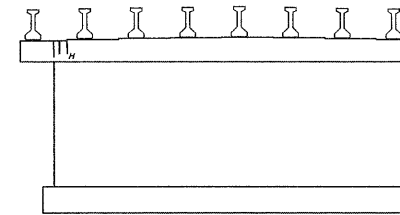

**PIER 2**  
**ELEVATION, SOUTH FACE**  
**(LOOKING NORTH)**

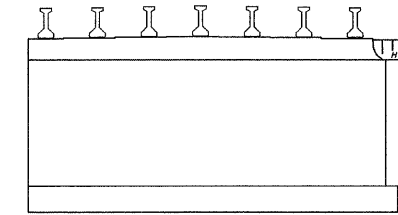

**PIER 2**  
**ELEVATION, NORTH FACE**  
**(LOOKING SOUTH)**

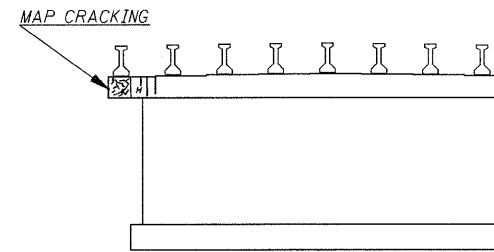

**PIER 3**  
**ELEVATION, SOUTH FACE**  
**(LOOKING NORTH)**

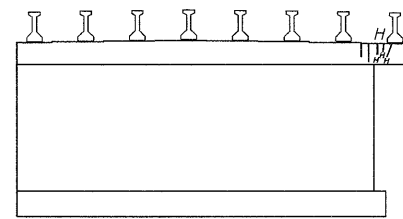

**PIER 3**  
**ELEVATION, NORTH FACE**  
**(LOOKING SOUTH)**

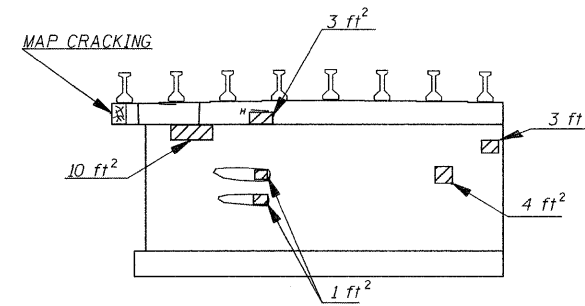

**PIER 4**  
**ELEVATION, SOUTH FACE**  
**(LOOKING NORTH)**

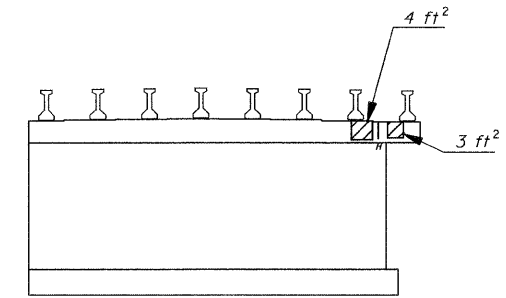

**PIER 4**  
**ELEVATION, NORTH FACE**  
**(LOOKING SOUTH)**

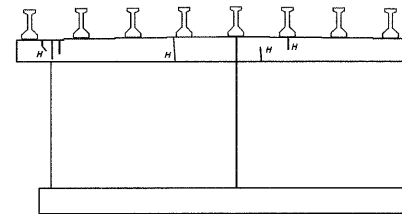

**PIER 5**  
**ELEVATION, SOUTH FACE**  
**(LOOKING NORTH)**

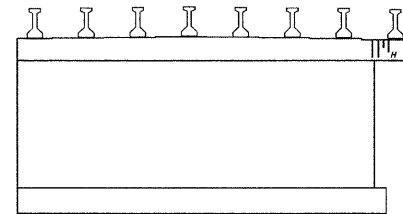

**PIER 5**  
**ELEVATION, NORTH FACE**  
**(LOOKING SOUTH)**

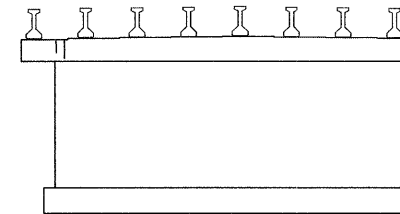

**PIER 6**  
**ELEVATION, SOUTH FACE**  
**(LOOKING NORTH)**

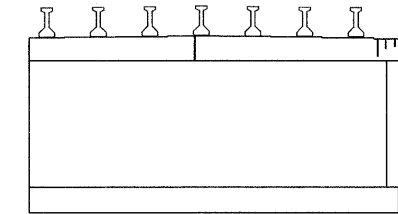

**PIER 6**  
**ELEVATION, NORTH FACE**  
**(LOOKING SOUTH)**

**LEGEND**

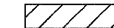
-  Epoxy Crack Injection
-  Structural Repair of Concrete  
(Depth Equal to or Less Than 5")

Note:  
Quantities Included in Bill of Material on Sheet 9 of 9

PLOT DATE = 6/25/2009  
 PLOT SCALE = 1/8" = 1'-0"  
 PLOT SCALE = 20115284 Y' / IN.  
 USER NAME = JNL

ILLINOIS DEPARTMENT OF TRANSPORTATION	
SHEET TITLE <b>PIER REPAIRS</b>	
PROJECT I-55 SB OVER KANKAKEE RIVER FAI ROUTE 55, SECTION 88(B&B-1)BR WILL COUNTY SN 099-0002	PROJECT NO. 03095-16 SCALE DATE 06/25/09 DRAWN BY CFC CHECKED BY MCB/KPS DRAWING NO. 8
<b>COOMBE-BLOXDORF P.C.</b> Engineers / Land Surveyors Springfield, Illinois Design Firm License No. 184-002703	
OF 9 SHTS	