

ROUTE	SECTION	COUNTY	TOTAL SHEETS	SHEET NUMBER
VARIOUS	2009-018 PP	LAKE	32	1

**STATE OF ILLINOIS**  
**DEPARTMENT OF TRANSPORTATION**  
**DIVISION OF HIGHWAYS**  
**DISTRICT ONE**  
**PROPOSED HIGHWAY PLANS**

**CONTRACT NO. 60G17**

D-91-348-09

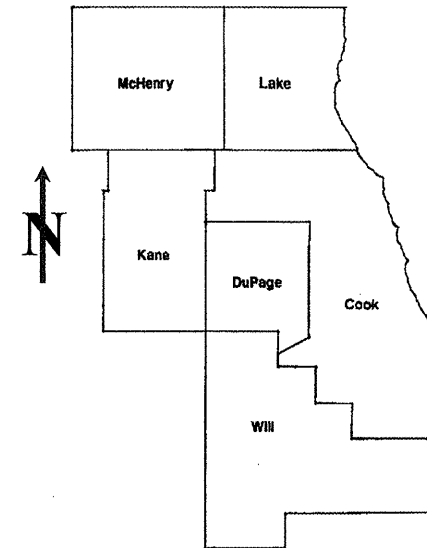

LOCATION OF IMPROVEMENT INDICATED THUS:

FOR INDEX OF SHEETS SEE SHEET 2

VARIOUS ROUTES  
 SECTION: 2009-018 PP  
 VARIOUS LOCATIONS IN EAST LAKE COUNTY  
 INTERMITTENT PAVEMENT RESURFACING  
 PROJECT: *ESP-0005(657)*  
 LAKE COUNTY  
 C-91-348-09

**STATE OF ILLINOIS**  
**DEPARTMENT OF TRANSPORTATION**  
**DIVISION OF HIGHWAYS**  
 SUBMITTED: FEBRUARY 5, 2009  
*Diane M. O'Malley*  
 DEPUTY DIRECTOR OF HIGHWAYS, REGION ENGINEER  
March 27, 2009  
*Charles J. Ingersoll*  
 ENGINEER OF DESIGN AND ENVIRONMENT  
March 27, 2009  
*Christine M. Reed*  
 DIRECTOR, DIVISION OF HIGHWAYS

**PRINTED BY THE AUTHORITY**  
**OF THE STATE OF ILLINOIS**

**J.U.L.I.E.: JOINT UTILITY LOCATION**  
**INFORMATION FOR EXCAVATION**  
**(312) 744-7000**

**CONTRACT NO. 60G17**

DISTRICT ONE - DESIGN - PLAN PREPARATION ENGINEER:  
 KEN ENG / (847) 705-4247

INDEX OF SHEETS

<u>SHEET NO.</u>	<u>DESCRIPTION</u>
1	TITLE SHEET
2	INDEX OF SHEETS, STATE STANDARDS AND GENERAL NOTES
3	SUMMARY OF QUANTITIES
4	GENERAL LOCATION MAP
5	SUMMARY OF PATCHING SCHEDULE
6-24	PATCHING SCHEDULE
25	BUTT JOINT AND HMA TAPER DETAILS
26	TRAFFIC CONTROL AND PROTECTION FOR SIDE ROADS, INTERSECTIONS AND DRIVEWAYS
27	TYPICAL APPLICATIONS: RAISED REFLECTIVE PAVEMENT MARKERS (SNOW-PLOW RESISTANT)
28	DISTRICT ONE TYPICAL PAVEMENT MARKINGS
29	TRAFFIC CONTROL AND PROTECTION OF TURN BAYS (TO REMAIN OPEN TO TRAFFIC)
30	ARTERIAL ROAD INFORMATION SIGN
31	STANDARD TRAFFIC SIGNAL DESIGN DETAILS
32	DETECTOR LOOP INSTALLATION DETAIL FOR ROADWAY RESURFACING

STATE STANDARDS

<u>STANDARD NO.</u>	<u>DESCRIPTION</u>
000001-05	TYPICAL SYMBOLS, ABBREVIATIONS AND PATTERNS
701201-03	LANE CLOSURE, 2L, 2W, DAY ONLY
701301-03	LANE CLOSURE, 2L, 2W, SHORT TIME OPERATIONS
701306-02	LANE CLOSURE, 2L, 2W, SLOW MOVING OPERATIONS - DAY ONLY
701336-05	LANE CLOSURE, 2L, 2W, WORK AREAS IN SERIES
701501-05	URBAN LANE CLOSURE, 2L, 2W, UNDIVIDED
701601-06	URBAN LANE CLOSURE, MULTILANE, 1W OR 2W WITH NONTRAVERSABLE MEDIAN
701606-06	URBAN LANE CLOSURE, MULTILANE, 2W WITH MOUNTABLE MEDIAN
701701-06	URBAN LANE CLOSURE, MULTILANE INTERSECTION
701901-01	TRAFFIC CONTROL DEVICES

GENERAL NOTES

BEFORE STARTING ANY EXCAVATION, THE CONTRACTOR SHALL CALL "JULIE" AT (800) 892-0123 OR 811 FOR FIELD LOCATIONS OF BURIED ELECTRIC, TELEPHONE AND GAS FACILITIES. (48 HOUR NOTIFICATION REQUIRED)

THE CONTRACTOR WILL NOT BE ALLOWED TO SET UP A YARD OR FIELD OFFICE ON STATE (OR TOLLWAY) PROPERTY WITHOUT WRITTEN PERMISSION FROM THE DEPARTMENT (OR ISTHA)

WHEN ARTIFICIAL LIGHTING IS UTILIZED IN NIGHT OPERATIONS, THE CONTRACTOR SHALL EXERCISE THE UTMOST PRECAUTIONS IN PREVENTING ADVERSE VISIBILITY TO THE MOTORING PUBLIC AND ADJOINING RESIDENTIAL AREAS.

ANY PAVEMENT MARKINGS AND RAISED REFLECTIVE PAVEMENT MARKERS OBLITERATED BY MILLING AND RESURFACING OPERATIONS ON SIDE STREETS AND ENTRANCES SHALL BE REPLACED AND PAID FOR IN KIND.

BEFORE BEGINNING ANY WORK, THE CONTRACTOR SHALL RETAIN AND RECORD FOR FUTURE REFERENCE, ALL EXISTING PAVEMENT MARKING LINES (AND RAISED REFLECTIVE PAVEMENT MARKERS) IN ORDER THAT THESE LOCATIONS CAN BE RE-ESTABLISHED FOR STRIPING. EXACT LOCATIONS OF ALL PAVEMENT MARKINGS SHALL BE AS DIRECTED BY THE ENGINEER.

ALL PAVEMENT PATCHING LOCATIONS WILL BE DETERMINED IN THE FIELD BY THE ENGINEER.

THE CONTRACTOR SHALL CONTACT THE DISTRICT ONE TRAFFIC CONTROL SUPERVISOR AT (847) 705-4470 A MINIMUM OF 72 HOURS IN ADVANCE OF BEGINNING WORK.

THE ENGINEER SHALL CONTACT MS. DEBBIE HANLON, AREA TRAFFIC FIELD ENGINEER AT (847) 438-2300 MINIMUM OF TWO (2) WEEKS PRIOR TO PLACEMENT OF PERMANENT PAVEMENT MARKINGS.

DOUBLE LANE MARKERS ARE TO BE USED AS SHOWN ON THE DISTRICT ONE DETAIL "TYPICAL APPLICATIONS - RAISED REFLECTIVE PAVEMENT MARKERS (SNOW-PLOW RESISTANT)" SHOWN IN THE PLANS.

THE EXISTING ROADWAY TYPICAL SECTION IS ASSUMED TO HAVE A 3 INCH HOT-MIX ASPHALT OVERLAY ON TOP OF A TEN INCH CONCRETE BASE.

ALL PAVEMENT PATCHES SHOWN IN THE PLANS ARE TWO (2) INCH MILL AND RESURFACE ONLY. THE MINIMUM WIDTH FOR MILLING AND PATCHING SHALL BE TWO (2) FEET.

THE COST OF TRAFFIC CONTROL AND PROTECTION FOR THE PROJECT SHALL BE INCLUDED IN THE COST OF THE ASSOCIATED ROAD WORK.

THE COST OF ANY PARTIAL OR FULL DEPTH PATCHING REQUIRED AFTER THE REMOVAL OF THE EXISTING 2 INCH HOT-MIX ASPHALT SURFACE SHALL BE PAID FOR IN ACCORDANCE WITH ARTICLE 109.04 OF THE STANDARD SPECIFICATIONS.

HOT-MIX ASPHALT MIXTURE REQUIREMENTS

MIXTURE TYPE	AC TYPE	AIR VOIDS (%)
HOT-MIX ASPHALT SURFACE COURSE, MIX "D", N70 (IL 9.5MM), 2"	PG 64-22	4% @ 70 GYR

THE UNIT WEIGHT USED TO CALCULATE ALL HOT-MIX ASPHALT SURFACE MIXTURE QUANTITIES IS 112 LBS/SY/IN.

SUMMARY OF QUANTITIES			URBAN 100% FED. TOTAL QUANTITIES		CONSTRUCTION TYPE CODE				
CODE NO	ITEM	UNIT							
40600200	BITUMINOUS MATERIALS (PRIME COAT)	TON	24	24					
40600300	AGGREGATE (PRIME COAT)	TON	117	117					
40600400	MIXTURE FOR CRACKS, JOINTS, AND FLANGEWAYS	TON	175	175					
40600982	HOT-MIX ASPHALT SURFACE REMOVAL - BUTT JOINT	SO YD	2325	2325					
40603340	HOT-MIX ASPHALT SURFACE COURSE, MIX "D", N70	TON	6510	6510					
44000157	HOT-MIX ASPHALT SURFACE REMOVAL, 2"	SO YD	58122	58112					
67000400	ENGINEER'S FIELD OFFICE, TYPE A	CAL MO	6	6					
67100100	MOBILIZATION	L SUM	1	1					
70300100	SHORT-TERM PAVEMENT MARKING	FOOT	16100	16100					
70301000	WORK ZONE PAVEMENT MARKING REMOVAL	SO FT	5367	5367					
* 78000100	THERMOPLASTIC PAVEMENT MARKING - LETTERS AND SYMBOLS	SO FT	220	220					
* 78000200	THERMOPLASTIC PAVEMENT MARKING - LINE 4"	FOOT	88552	88552					
* 78000400	THERMOPLASTIC PAVEMENT MARKING - LINE 6"	FOOT	3600	3600					
* 78000600	THERMOPLASTIC PAVEMENT MARKING - LINE 12"	FOOT	200	200					
* 78000650	THERMOPLASTIC PAVEMENT MARKING - LINE 24"	FOOT	200	200					
* 78100100	RAISED REFLECTIVE PAVEMENT MARKER	EACH	2130	2130					
78300200	RAISED REFLECTIVE PAVEMENT MARKER REMOVAL	EACH	2130	2130					
* 88600600	DETECTOR LOOP REPLACEMENT	FOOT	2000	2000					
X0322256	TEMPORARY INFORMATION SIGNING	SO FT	412	412					
20076600	TRAINEES	HOUR	500	500					

SUMMARY OF QUANTITIES			TOTAL QUANTITIES		CONSTRUCTION TYPE CODE				
CODE NO	ITEM	UNIT							

\* SPECIALTY ITEM

20 Y080

REVISIONS	
NAME	DATE

ILLINOIS DEPARTMENT OF TRANSPORTATION  
SUMMARY OF QUANTITIES

PLOT DATE: 2/6/2009

2/6/2009 2:06:43 PM C:\Users\smihki\Documents\20076600.dgn

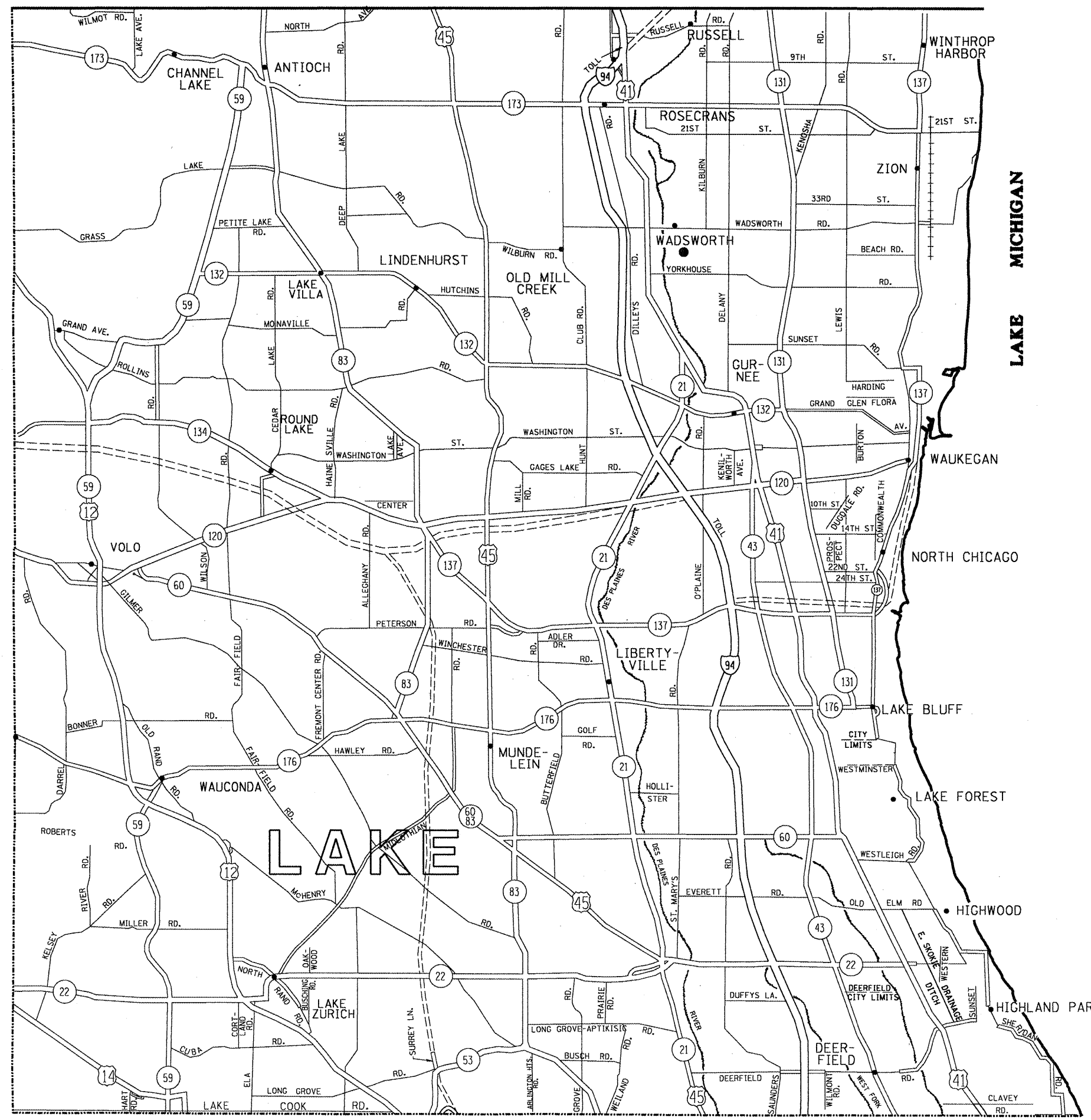

LAKE MICHIGAN

LAKE

**STATE OF ILLINOIS  
DEPARTMENT OF TRANSPORTATION**

**GENERAL LOCATION MAP - LAKE COUNTY**

FILE NAME =  
c:\pw\work\XPWIDDT\SMITHKL\d0125025\Desig

USER NAME = sm1thk1  
DESIGNED -  
DRAWN -  
CHECKED -  
DATE -

DESIGNED -  
REVISOR -  
REVISOR -  
REVISOR -  
REVISOR -

SCALE: SHEET NO. OF SHEETS STA. TO STA.

F.A. RTE. SECTION COUNTY TOTAL SHEETS SHEET NO.  
VAR. 2009-018 PP LAKE 32 4  
CONTRACT NO. 60G17

FED. ROAD DIST. NO. 1 ILLINOIS FED. AID PROJECT

SUMMARY - EASY LAKE COUNTY	HMA 2" MILL & RESURFACE (SY)
IL 43 (IL 176 TO IL 22)	17132
IL 43 (US 41 TO 22ND ST.)	4549
IL 120 (IL 41 TO IL 131)	417
IL 137 (IL 21 TO O'PLAINE RD.)	1081
IL 173 (IL 131 TO MILL RD.)	16323
SHERIDAN RD. (22ND ST./MLK DR. TO IL 137)	2816
SHERIDAN RD. (YORKHOUSE RD. TO WADSWORTH RD.)	1575
US 41 (IL 120 TO ILLINOIS/WISCONSIN STATE LINE)	14229
<b>SUMMARY TOTALS:</b>	<b>58122</b>
	<b>SY</b>

FILE NAME = c:\pwwork\pwwid\SMITHKL\d0125025\Desi	USER NAME = smithkl	DESIGNED -	REVISED -	<b>STATE OF ILLINOIS DEPARTMENT OF TRANSPORTATION</b>	<b>SUMMARY OF PATCHING SCHEDULE EAST LAKE COUNTY</b>	F.A. RTE.	SECTION	COUNTY	TOTAL SHEETS	SHEET NO.	
		DRAWN -	REVISED -			VAR.	2009-018 PP	LAKE	32	5	
		CHECKED -	REVISED -			<b>CONTRACT NO. 60G17</b>					
		DATE -	REVISED -			SCALE:	SHEET NO.	OF	SHEETS	STA.	TO STA.













ROUTE: Rte 137 (Rte 21 to O'Plaine Rd)

Table with columns: FROM, TO, DIRECTION (EB/WB), LANE NO., PAVEMENT PATCH WIDTH, PAVEMENT PATCH LENGTH, REPAIR AREA (SQ FT), REPAIR AREA (SQ YD). Lists 66 entries for Rte 21 to O'Plaine Rd.

ROUTE: Rte 137 (Rte 21 to O'Plaine Rd)

Table with columns: FROM, TO, DIRECTION (EB/WB), LANE NO., PAVEMENT PATCH WIDTH, PAVEMENT PATCH LENGTH, REPAIR AREA (SQ FT), REPAIR AREA (SQ YD). Lists 66 entries for Rte 21 to O'Plaine Rd.

TOTALS: 1936 FT 1081 SY

FILE NAME = e:\pwork\p\WID01\SMITH\1\0125025\Des...

USER NAME = smthkl  
DRAWN -  
CHECKED -  
DATE -

DESIGNED -  
DRAWN -  
CHECKED -  
DATE -

REVISED -  
REVISED -  
REVISED -  
REVISED -

STATE OF ILLINOIS  
DEPARTMENT OF TRANSPORTATION

PATCHING SCHEDULE  
IL ROUTE 137

SCALE: SHEET NO. OF SHEETS STA. TO STA.

Table with columns: F.A. RTE. VAR., SECTION, COUNTY, TOTAL SHEETS, SHEET NO., CONTRACT NO. 60G17.

ILLINOIS FED. AID PROJECT





ROUTE: Sheridan Rd. (Martin Luther King Dr to IL 137)

CROSS STREETS		DIRECTION (EB/WB) (NB/SB)	LANE NO. (1, 2, 3)	PAVEMENT		REPAIR	
FROM	TO			PATCH WIDTH	PATCH LENGTH	AREA (SQ FT)	REPAIR AREA (SQ YD)
MLK Dr.	IL 137	SB		2	200	400	44
MLK Dr.	IL 137	SB		2	550	1100	122
MLK Dr.	IL 137	SB		24	5	120	13
MLK Dr.	IL 137	SB		24	5	120	13
MLK Dr.	IL 137	SB		2	80	160	18
MLK Dr.	IL 137	SB		2	1800	3600	400
MLK Dr.	IL 137	SB		2	1800	3600	400
MLK Dr.	IL 137	SB		20	20	400	44
MLK Dr.	IL 137	SB		2	300	600	67
MLK Dr.	IL 137	SB		2	880	1760	196
MLK Dr.	IL 137	SB		4	20	80	9
MLK Dr.	IL 137	SB		2	20	40	4
MLK Dr.	IL 137	SB		15	90	1350	150
MLK Dr.	IL 137	SB		12	25	300	33
MLK Dr.	IL 137	SB		12	50	600	67
MLK Dr.	IL 137	SB		2	12	24	3
MLK Dr.	IL 137	SB		2	12	24	3
MLK Dr.	IL 137	SB		2	12	24	3
MLK Dr.	IL 137	SB		2	12	24	3
MLK Dr.	IL 137	SB		2	25	50	6
MLK Dr.	IL 137	SB		2	20	40	4
MLK Dr.	IL 137	SB		2	30	60	7
MLK Dr.	IL 137	NB/SB		24	25	600	67
MLK Dr.	IL 137	NB		2	12	24	3
MLK Dr.	IL 137	NB		2	12	24	3
MLK Dr.	IL 137	NB		2	12	24	3
MLK Dr.	IL 137	NB		2	12	24	3
MLK Dr.	IL 137	NB		4	12	48	5
MLK Dr.	IL 137	NB		2	820	1640	182
MLK Dr.	IL 137	NB		2	80	160	18
MLK Dr.	IL 137	NB		2	40	80	9
MLK Dr.	IL 137	NB		24	5	120	13
MLK Dr.	IL 137	NB		36	5	180	20
MLK Dr.	IL 137	NB		2	25	50	6
MLK Dr.	IL 137	NB		2	780	1560	173
MLK Dr.	IL 137	NB		2	720	1440	160
MLK Dr.	IL 137	NB		24	5	120	13
MLK Dr.	IL 137	NB		2	45	90	10
MLK Dr.	IL 137	NB		2	250	500	56
MLK Dr.	IL 137	NB		2	440	880	98
MLK Dr.	IL 137	NB		2	300	600	67
MLK Dr.	IL 137	SB		2	15	30	3
MLK Dr.	IL 137	SB		12	25	300	33
MLK Dr.	IL 137	SB		12	10	120	13
MLK Dr.	IL 137	SB		12	25	300	33
MLK Dr.	IL 137	SB		36	6	216	24
MLK Dr.	IL 137	SB		2	20	40	4
MLK Dr.	IL 137	SB		12	15	180	20
MLK Dr.	IL 137	SB		12	2	24	3
MLK Dr.	IL 137	NB		15	2	30	3
MLK Dr.	IL 137	NB		2	100	200	22
MLK Dr.	IL 137	NB		12	25	300	33
MLK Dr.	IL 137	NB		2	12	24	3
MLK Dr.	IL 137	NB		2	100	200	22
MLK Dr.	IL 137	NB		24	15	360	40
MLK Dr.	IL 137	NB		12	2	24	3
MLK Dr.	IL 137	NB		24	2	48	5
MLK Dr.	IL 137	NB		12	12	144	16
MLK Dr.	IL 137	NB		12	4	48	5
MLK Dr.	IL 137	NB		24	2	48	5
MLK Dr.	IL 137	NB		24	2	48	5

TOTALS: 9976 FT 2816 SY

FILE NAME =	USER NAME = smthkl	DESIGNED -	REVISED -	<b>STATE OF ILLINOIS DEPARTMENT OF TRANSPORTATION</b>	<b>PATCHING SCHEDULE SHERIDAN ROAD</b>			F.A. RTE.	SECTION	COUNTY	TOTAL SHEETS	SHEET NO.
or\pwork\PW1001\SMITHKL\08125025\Desig	DRAWN -	REVISED -	VAR.					2009-018-PP	LAKE	22	14	
PLOT SCALE = 1/8" = 1' / IN.	CHECKED -	REVISED -	SCALE: SHEET NO. OF SHEETS STA. TO STA.			CONTRACT NO. 60G17						
PLOT DATE = 2/6/2009	DATE -	REVISED -	ILLINOIS FED. AID PROJECT									



ROUTE: Sheridan Rd. (Yorkhouse to Wadsworth)

CROSS STREETS		DIRECTION (EB/WB) (NB/SB)	LANE NO. (1, 2, 3)	PAVEMENT PATCH WIDTH	PAVEMENT PATCH LENGTH	REPAIR AREA (SQ FT)	REPAIR AREA (SQ YD)
FROM	TO						
Wadsworth	Yorkhouse	NB		12	2	24	3
Wadsworth	Yorkhouse	NB		12	2	24	3
Wadsworth	Yorkhouse	NB		2	12	24	3
Wadsworth	Yorkhouse	NB		2	12	24	3
Wadsworth	Yorkhouse	NB		12	5	60	7
Wadsworth	Yorkhouse	NB		12	5	60	7
Wadsworth	Yorkhouse	NB		12	2	24	3
Wadsworth	Yorkhouse	NB		12	2	24	3
Wadsworth	Yorkhouse	NB		2	15	30	3
Wadsworth	Yorkhouse	NB		2	80	160	18
Wadsworth	Yorkhouse	NB		12	2	24	3
Wadsworth	Yorkhouse	NB		2	20	40	4
Wadsworth	Yorkhouse	NB		12	2	24	3
Wadsworth	Yorkhouse	NB		12	2	24	3
Wadsworth	Yorkhouse	NB		2	30	60	7
Wadsworth	Yorkhouse	NB		12	2	24	3
Wadsworth	Yorkhouse	NB		12	2	24	3
Wadsworth	Yorkhouse	NB		12	2	24	3
Wadsworth	Yorkhouse	NB		12	2	24	3
Wadsworth	Yorkhouse	NB		12	2	24	3
Wadsworth	Yorkhouse	NB		12	2	24	3
Wadsworth	Yorkhouse	NB		12	2	24	3
Wadsworth	Yorkhouse	NB		12	2	24	3
Wadsworth	Yorkhouse	NB		12	2	24	3
Wadsworth	Yorkhouse	NB		12	2	24	3
Wadsworth	Yorkhouse	NB		2	75	150	17
Wadsworth	Yorkhouse	NB		2	30	60	7
Wadsworth	Yorkhouse	NB		2	100	200	22
Wadsworth	Yorkhouse	NB		2	220	440	49
Wadsworth	Yorkhouse	NB		2	120	240	27
Wadsworth	Yorkhouse	NB		2	440	880	98
Wadsworth	Yorkhouse	NB		2	100	200	22
Wadsworth	Yorkhouse	NB		2	120	240	27
Wadsworth	Yorkhouse	NB		2	160	320	36
Wadsworth	Yorkhouse	NB		2	120	240	27
Wadsworth	Yorkhouse	NB		2	120	240	27
Wadsworth	Yorkhouse	NB		2	80	160	18
Wadsworth	Yorkhouse	NB		2	80	160	18
Wadsworth	Yorkhouse	NB		2	360	720	80
Wadsworth	Yorkhouse	NB		2	60	120	13
Wadsworth	Yorkhouse	NB		2	250	500	56
Wadsworth	Yorkhouse	NB		2	60	120	13
Wadsworth	Yorkhouse	NB		2	320	640	71
Wadsworth	Yorkhouse	NB		2	20	40	4
Wadsworth	Yorkhouse	NB		2	20	40	4
Wadsworth	Yorkhouse	NB		2	80	160	18
Wadsworth	Yorkhouse	NB		2	60	120	13
Wadsworth	Yorkhouse	NB		2	20	40	4
Wadsworth	Yorkhouse	NB		2	160	320	36
Wadsworth	Yorkhouse	NB		2	130	260	29
Wadsworth	Yorkhouse	NB		2	60	120	13
Wadsworth	Yorkhouse	NB		2	700	1400	156
Wadsworth	Yorkhouse	NB		2	15	30	3
Wadsworth	Yorkhouse	NB		2	40	80	9
Wadsworth	Yorkhouse	NB		2	50	100	11
Wadsworth	Yorkhouse	NB		2	15	30	3
Wadsworth	Yorkhouse	NB		2	15	30	3
Wadsworth	Yorkhouse	NB		2	15	30	3
Wadsworth	Yorkhouse	NB		2	15	30	3
Wadsworth	Yorkhouse	NB		2	50	100	11
Wadsworth	Yorkhouse	NB		2	60	120	13

TOTALS: 5259 FT 1575 SY

FILE NAME =	USER NAME = smthkl	DESIGNED -	REVISED -	<b>STATE OF ILLINOIS DEPARTMENT OF TRANSPORTATION</b>	<b>PATCHING SCHEDULE SHERIDAN ROAD</b>			F.A. RTE.	SECTION	COUNTY	TOTAL SHEETS	SHEET NO.
ca\pwork\PW1001\SMITHKL\d0125025\Des	gn.dgn	DRAWN -	REVISED -					VAR.	2009-018-PP	LAKE	32	16
PLOT SCALE = 1/8" = 1' / IN.	CHECKED -	REVISED -	REVISED -		SCALE:	SHEET NO.	OF SHEETS	STA.	TO STA.	<b>CONTRACT NO. 60G17</b>		
PLOT DATE = 2/6/2009	DATE -	REVISED -	REVISED -		ILLINOIS FED. AID PROJECT							

















ROUTE: US 41 (Rte 120 to Wisc. State Line)

CROSS STREETS		DIRECTION (EB/WB) (NB/SB)	LANE NO. (1, 2, 3)	PAVEMENT PATCH WIDTH	PAVEMENT PATCH LENGTH	REPAIR AREA (SQ FT)	REPAIR AREA (SQ YD)
FROM	TO						
Rte 21	Rte 120	SB	2	2	100	200	22
Rte 21	Rte 120	SB	2	2	100	200	22
Rte 21	Rte 120	SB	2	2	100	200	22
Rte 21	Rte 120	SB	2	2	100	200	22
Rte 21	Rte 120	SB	2	2	100	200	22
Rte 21	Rte 120	SB	2	2	100	200	22
Rte 21	Rte 120	SB	2	2	100	200	22
Rte 21	Rte 120	SB	2	2	100	200	22
Rte 21	Rte 120	SB	2	2	100	200	22
Rte 21	Rte 120	SB	2	2	100	200	22
Rte 21	Rte 120	SB	2	2	100	200	22
Rte 21	Rte 120	SB	2	2	100	200	22
Rte 21	Rte 120	SB	2	2	100	200	22
Rte 21	Rte 120	SB	2	2	100	200	22
Rte 21	Rte 120	SB	2	2	100	200	22
Rte 21	Rte 120	SB	2	2	100	200	22
Rte 21	Rte 120	SB	2	2	100	200	22

Total S.Y. = 14229

FILE NAME = c:\pwork\pwork\smthk1\08125025\Design.dgn	USER NAME = smthk1	DESIGNED -	REVISED -	<b>STATE OF ILLINOIS DEPARTMENT OF TRANSPORTATION</b>	<b>PATCHING SCHEDULE US 41</b>				F.A. RTE.	SECTION	COUNTY	TOTAL SHEETS	SHEET NO.	
		DRAWN -	REVISED -		SCALE:	SHEET NO.	OF	SHEETS	STA.	TO STA.	VAR.	2009-018-PP	LAKE 32-41	24
		CHECKED -	REVISED -		CONTRACT NO. 60G17									
		DATE -	REVISED -		ILLINOIS FED. AID PROJECT									



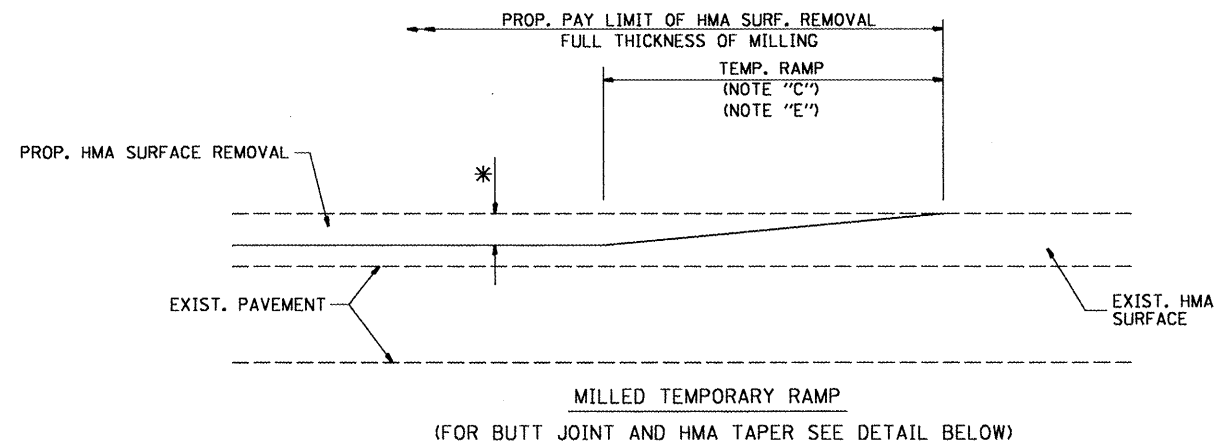

**OPTION 1**

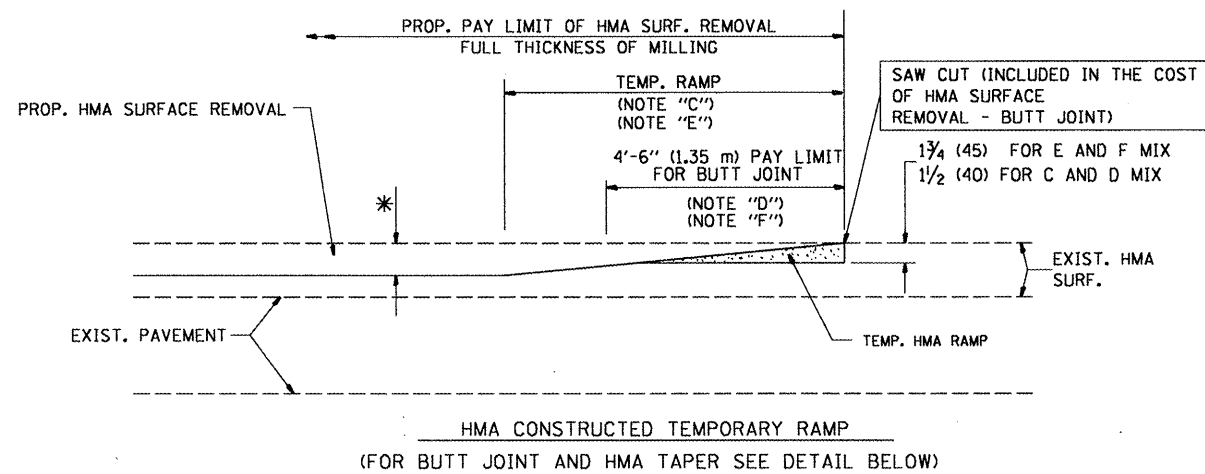

**OPTION 2**

**TYPICAL TEMPORARY RAMP**

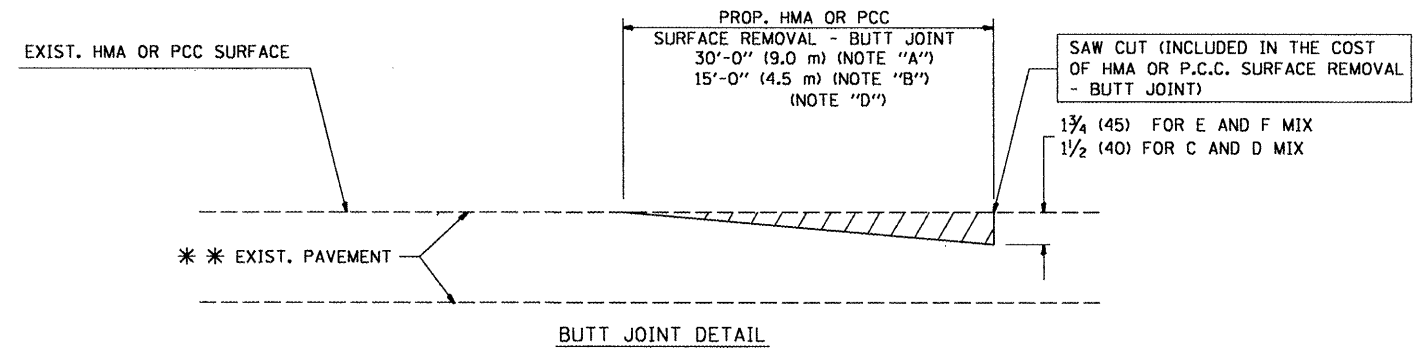

**BUTT JOINT DETAIL**

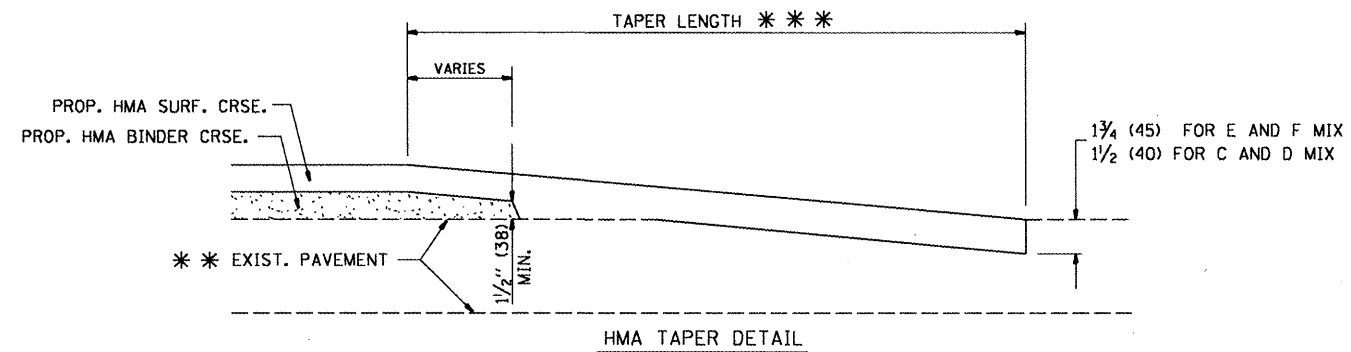

**HMA TAPER DETAIL**

**TYPICAL BUTT JOINT AND HMA TAPER FOR RESURFACING ONLY**

\*\*\* PC CONCRETE, HMA OR HMA RESURFACED PAVEMENT.

**NOTES**

- A: MAINLINE ROADWAYS AND MAJOR SIDE ROADS.
  - B: MINOR SIDE ROADS.
  - C: THE TEMP. RAMP SHALL BE CONSTRUCTED IMMEDIATELY UPON REMOVAL OF THE EXISTING HMA SURFACE.
  - D: THE BUTT JOINT SHALL BE CONSTRUCTED IMMEDIATELY PRIOR TO PLACING THE PROPOSED HMA COURSES.
  - E: TAPER THE TEMP. RAMP AT A RATE OF 3'-0" (900 mm) PER 1 INCH (25 mm) OF MILLING THICKNESS.
  - F: INSTALLATION AND REMOVAL OF THE 4'-6" (1.35 m) TEMP. RAMP IS INCLUDED IN COST OF HMA SURFACE REMOVAL - BUTT JOINT
  - G: SEE ARTICLE 406.08 AND 406.14 OF THE STANDARD SPECIFICATIONS FOR "HMA AND/OR PCC SURFACE REMOVAL, BUTT JOINT".
- \* SEE TYPICAL SECTIONS FOR MILLING THICKNESS.
- \*\*\* 20'-0" (6.1 m) PER 1 (25) RESURFACING (NOTE "A")  
 10'-0" (3.0 m) PER 1 (25) RESURFACING (NOTE "B")

**BASIS OF PAYMENT:**

THE BUTT JOINT WILL BE PAID FOR AT THE CONTRACT UNIT PRICE PER SQUARE YARD (SQUARE METER) FOR "HOT-MIX ASPHALT SURFACE REMOVAL - BUTT JOINT" OR FOR "PORTLAND CEMENT CONCRETE SURFACE REMOVAL - BUTT JOINT".

ALL DIMENSIONS ARE IN INCHES (MILLIMETERS) UNLESS OTHERWISE SHOWN.

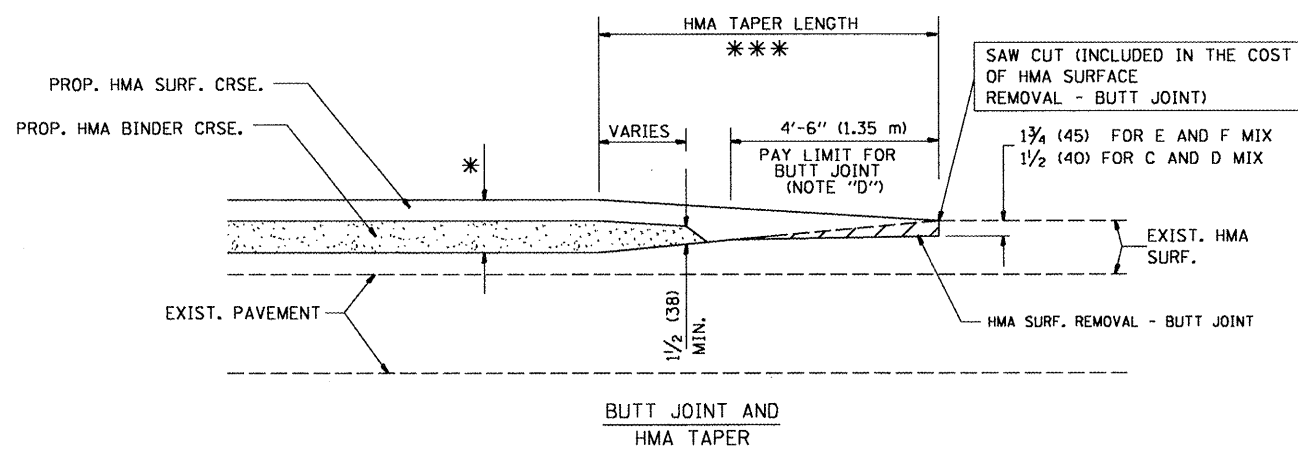

**TYPICAL BUTT JOINT AND HMA TAPER FOR MILLING AND RESURFACING**

**STATE OF ILLINOIS  
DEPARTMENT OF TRANSPORTATION**

**BUTT JOINT AND  
HMA TAPER DETAILS**

FILE NAME =	USER NAME = smthkl	DESIGNED - M. DE YONG	REVISED - R. SHAH 10-25-94
ct:\pw_work\pwsidot\smthkl\0125025\Dist5.d.dgn		DRAWN -	REVISED - A. ABBAS 03-21-97
PLOT SCALE = 100.0000' / IN.		CHECKED -	REVISED - M. GOMEZ 04-06-01
PLOT DATE = 2/4/2009		DATE - 06-13-90	REVISED - R. BORO 01-01-07

SCALE: NONE	SHEET NO. 1 OF 1 SHEETS	STA. TO STA.	F.A. RTE. VAR.	SECTION	COUNTY	TOTAL SHEETS	SHEET NO.
			BD400-05	BD32	LAKE	32	25
			CONTRACT NO. 60G17		FED. ROAD DIST. NO. 1 ILLINOIS FED. AID PROJECT		

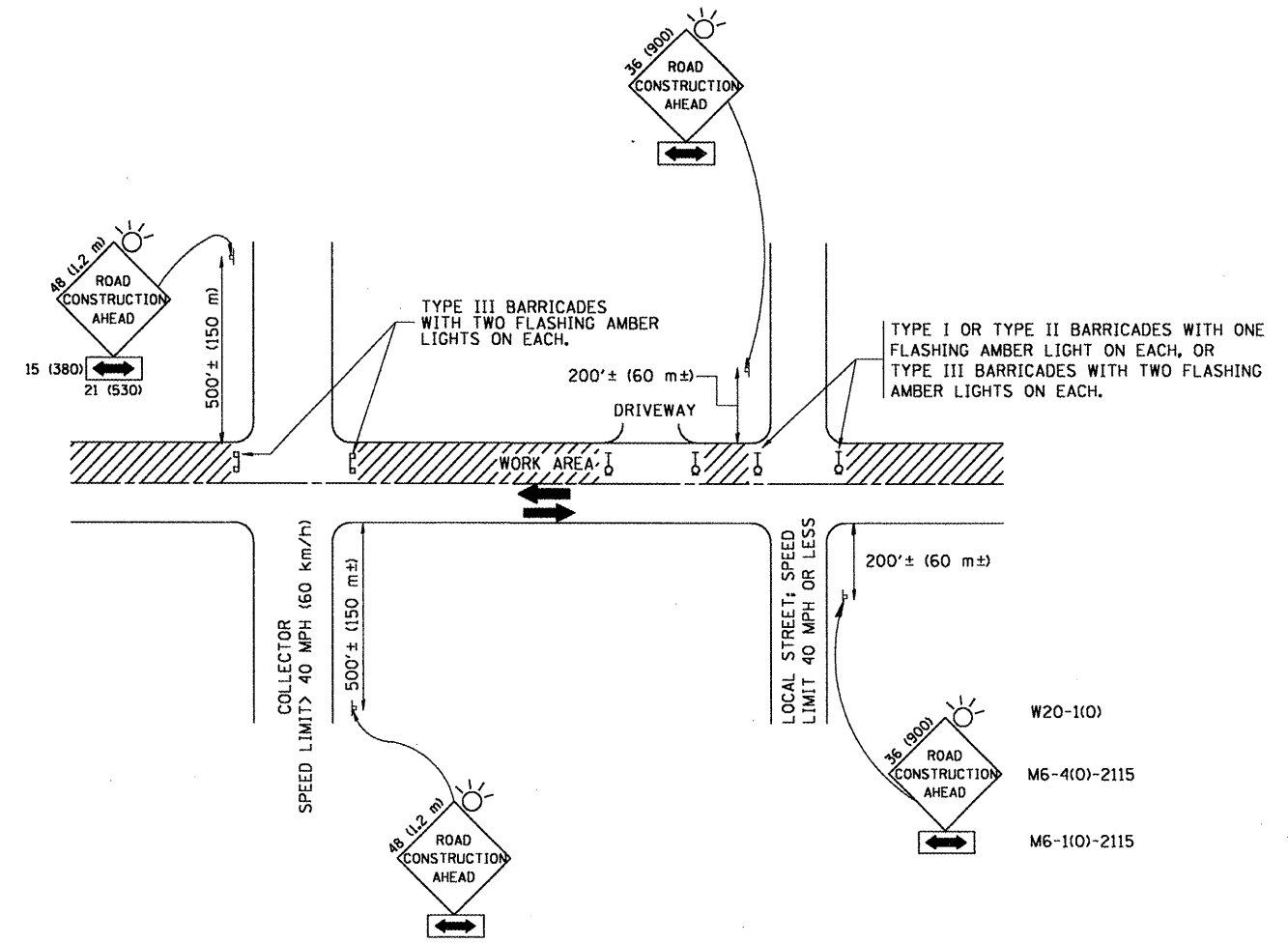

**TRAFFIC CONTROL AND PROTECTION FOR SIDE ROADS, INTERSECTIONS, AND DRIVEWAYS**

**NOTES:**

- A. FOR NO LANE RESTRICTION ON THE SIDE ROAD OR DRIVEWAYS**
- SIDE ROAD WITH A SPEED LIMIT OF 40 MPH (60 km/h) OR LESS AS SHOWN ON THE DRAWING AND AS DIRECTED BY THE ENGINEER:
    - ONE **ROAD CONSTRUCTION AHEAD** SIGN 36 x 36 (900x900) WITH A FLASHER AND FLAG MOUNTED ON IT APPROXIMATELY 200' (60 m) IN ADVANCE OF THE MAIN ROUTE.
    - THE CLOSED PORTION OF THE MAIN ROUTE SHALL BE PROTECTED BY BLOCKING WITH TYPE I, TYPE II OR TYPE III BARRICADES, 1/3 OF THE CROSS SECTION OF THE CLOSED PORTION.
  - SIDE ROAD WITH A SPEED LIMIT GREATER THAN 40 MPH (60 km/h) AS SHOWN ON THE DRAWING AND AS DIRECTED BY THE ENGINEER:
    - ONE **ROAD CONSTRUCTION AHEAD** SIGN 48 x 48 (1.2 m x 1.2 m) WITH A FLASHER MOUNTED ON IT APPROXIMATELY 500' (150 m) IN ADVANCE OF THE MAIN ROUTE.
    - THE CLOSED PORTION OF THE MAIN ROUTE SHALL BE PROTECTED BY BLOCKING WITH TYPE III BARRICADES, 1/2 OF THE CROSS SECTION OF THE CLOSED PORTION.
- 3. WHEN THE SIDE ROAD LIES BETWEEN THE BEGINNING OF THE MAINLINE SIGNING AND THE WORK ZONE, A SINGLE HEADED ARROW (M6-1) SHALL BE USED IN LIEU OF THE DOUBLE HEADED ARROW (M6-4).**
- B. FOR A LANE CLOSURE ON A SIDE ROAD OR DRIVEWAY:**
- USE APPLICABLE PORTIONS OF THE TYPICAL APPLICATION OF TRAFFIC CONTROL DEVICES (STD. 701501, STD. 701606 OR THE APPROPRIATE STANDARD). THE SPACING OF SIGNS AND BARRICADES SHALL BE ADJUSTED FOR FIELD CONDITIONS AS DIRECTED BY THE ENGINEER. THE DIRECTIONAL ARROW SHALL BE COVERED OR REMOVED WHEN NO LONGER CONSISTENT WITH THE SIDE ROAD LANE CLOSURE.
- C. ADVANCE WARNING SIGNS ARE TO BE OMITTED ON DRIVEWAY UNLESS OTHERWISE NOTED.**
- D. THE TRAFFIC CONTROL AND PROTECTION FOR SIDE ROADS, INTERSECTIONS, AND DRIVEWAYS SHALL BE INCIDENTAL TO THE COST OF SPECIFIED TRAFFIC CONTROL STANDARDS OR ITEMS.**

All dimensions are in millimeters (inches) unless otherwise shown.

FILE NAME =	USER NAME = smthkl	DESIGNED - LHA	REVISED - J. OBERLE 10-18-95
:\pw\work\pwr\dot\smthkl\0125025\Dist5.d.dgn		DRAWN -	REVISED - A. HOUSEH 03-06-96
		PLOT SCALE = 100.0000' / IN.	REVISED - A. HOUSEH 10-15-96
		PLOT DATE = 2/4/2009	REVISED - T. RAMMACHER 01-06-00
		DATE - 06-89	

**STATE OF ILLINOIS  
DEPARTMENT OF TRANSPORTATION**

**TRAFFIC CONTROL AND PROTECTION FOR  
SIDE ROADS, INTERSECTIONS, AND DRIVEWAYS**

SCALE: NONE SHEET NO. 1 OF 1 SHEETS STA. TO STA.

F.A. RTE.	SECTION	COUNTY	TOTAL SHEETS	SHEET NO.
VAR.	2009-01B PP	LAKE	32	26
TC-10			CONTRACT NO. 60G17	
FED. ROAD DIST. NO. 1 ILLINOIS FED. AID PROJECT				

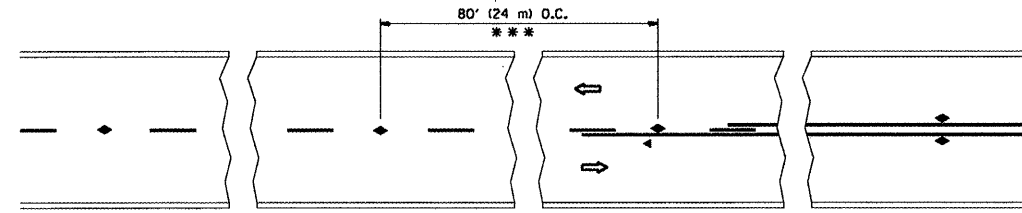

\*\*\* REDUCE TO 40' (12 m) O.C. ON CURVES WITH POSTED OR ADVISORY SPEED 45 M.P.H. (70 km/h) OR LESS.

TWO-LANE/TWO-WAY

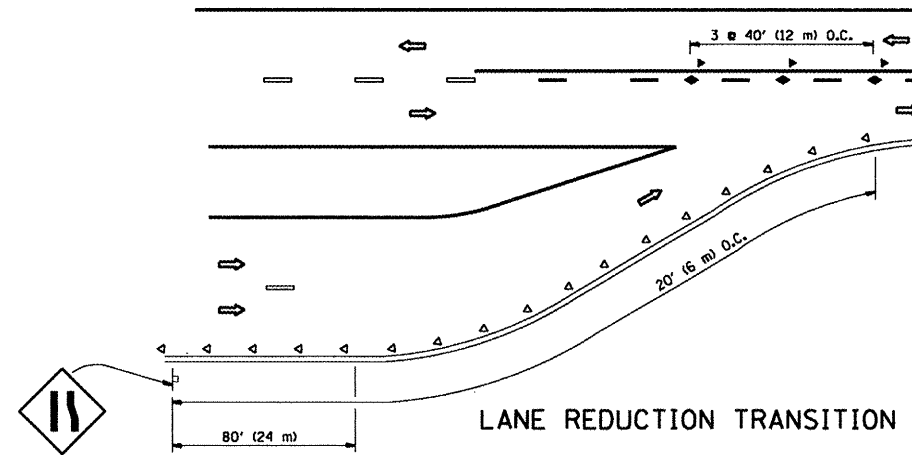

LANE REDUCTION TRANSITION

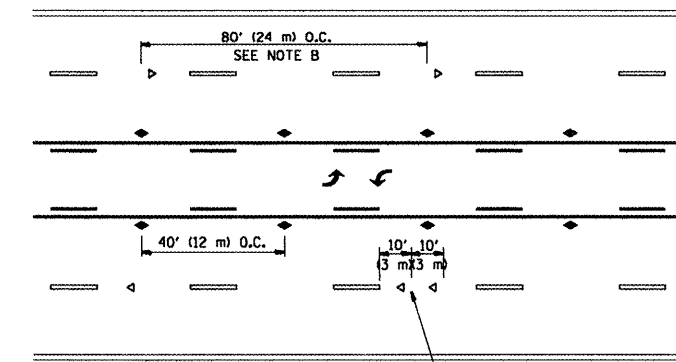

TWO-WAY LEFT TURN

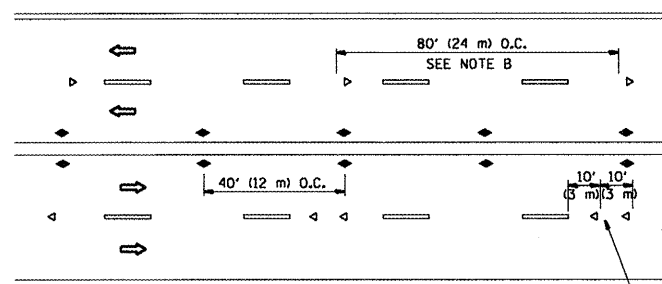

MULTI-LANE/UNDIVIDED

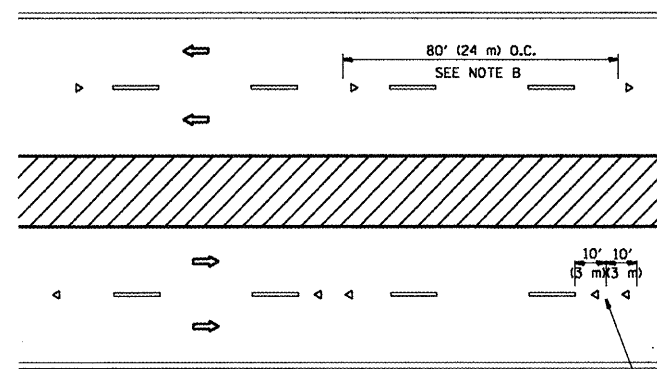

MULTI-LANE/DIVIDED

GENERAL NOTES

1. MARKERS USED WITH DASHED LINES SHALL BE CENTERED IN THE GAP BETWEEN SEGMENTS.
2. MARKERS USED ADJACENT TO SOLID LINES SHALL BE OFFSET 2 TO 3 (50 TO 75) TOWARD TRAFFIC AS SHOWN.
3. MARKERS THROUGH TANGENTS LESS THAN 500' (150 m) IN LENGTH BETWEEN CURVES SHALL BE INSTALLED AT THE LESSER OF THE TWO CURVE SPACINGS.

SYMBOLS

- YELLOW STRIPE
- WHITE STRIPE
- ◀ ONE-WAY AMBER MARKER
- ◀ ONE-WAY CRYSTAL MARKER (W/O)
- ◆ TWO-WAY AMBER MARKER

LANE MARKER NOTES

- B. REDUCE TO 40' (12 m) O.C. ON CURVES WHERE ADVISORY SPEEDS ARE 10 M.P.H. (20 km/h) LOWER THAN POSTED SPEEDS.
- A. USE DOUBLE LANE LINE MARKERS SPACED AS SHOWN.

DESIGN NOTES

1. DOUBLE LANE LINE MARKERS SHALL BE USED UNLESS SPECIFIED OTHERWISE.
2. EXCEPT AS SHOWN ON THE LANE REDUCTION TRANSITION AND FREEWAY EXIT RAMP DETAIL, MARKERS ARE NOT TO BE SPECIFIED ON RIGHT EDGE LINES.
3. THE EXACT MARKER LIMITS, SPACING, AND COLOR SHOULD BE INCLUDED IN THE PLANS.
4. MARKERS SHOULD NOT BE USED ALONGSIDE CURBS EXCEPT FOR EXTREMELY SHORT SECTIONS OF CURBS WHERE NOT MORE THAN TWO MARKERS WOULD BE INVOLVED.

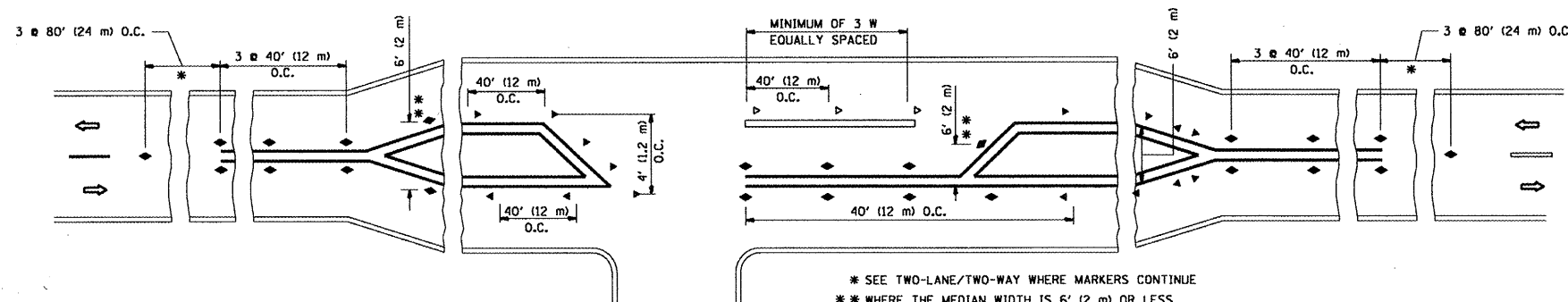

LEFT TURN

\* SEE TWO-LANE/TWO-WAY WHERE MARKERS CONTINUE  
 \*\* WHERE THE MEDIAN WIDTH IS 6' (2 m) OR LESS USE TWO-WAY MARKERS.

All dimensions are in inches (millimeters) unless otherwise shown.

FILE NAME =	USER NAME = smthkl	DESIGNED -	REVISED - T. RAMMACHER 09-19-94
ct:\pw_work\p1dot\smthkl\d0125025\01st5.dgn		DRAWN -	REVISED - T. RAMMACHER 03-12-99
PLOT SCALE = 100.0000' / IN.		CHECKED -	REVISED - T. RAMMACHER 01-06-00
PLOT DATE = 2/4/2009		DATE -	REVISED -

STATE OF ILLINOIS  
 DEPARTMENT OF TRANSPORTATION

TYPICAL APPLICATIONS	
RAISED REFLECTIVE PAVEMENT MARKERS (SNOW-PLOW RESISTANT)	
SCALE: NONE	SHEET NO. 1 OF 1 SHEETS STA. TO STA.

F.A. RTE.	SECTION	COUNTY	TOTAL SHEETS	SHEET NO.
VAR.	2009-018 PP	LAKE	32	27
TC-11			CONTRACT NO. 60G17	
FED. ROAD DIST. NO. 1 ILLINOIS FED. AID PROJECT				

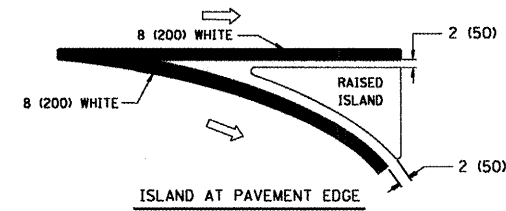
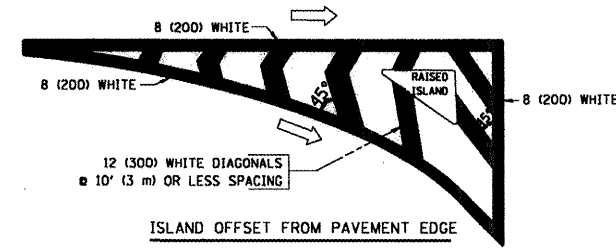
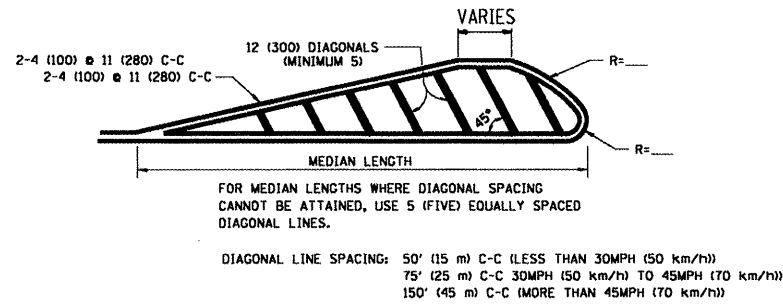
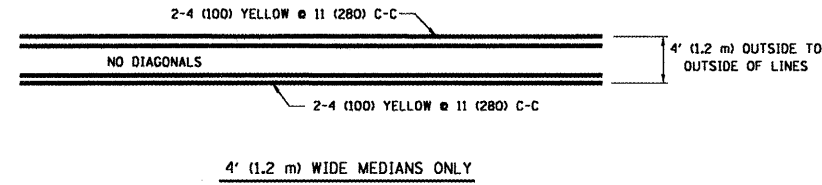
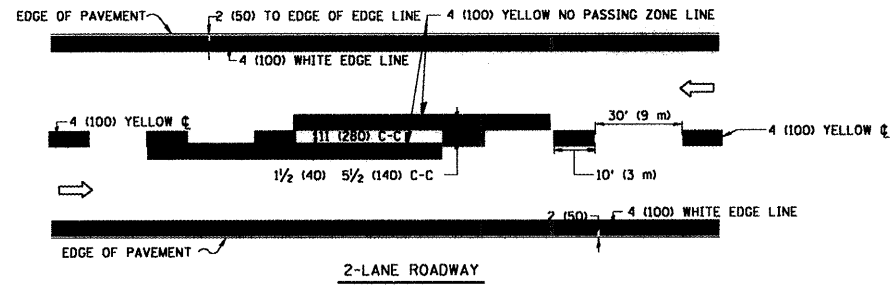

TYPICAL ISLAND MARKING

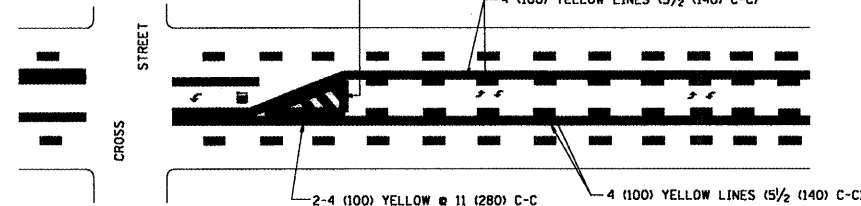
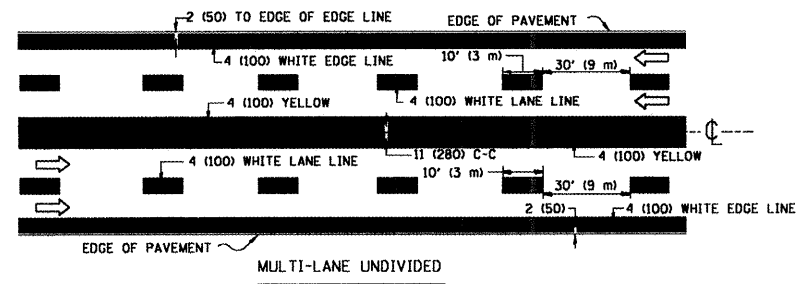

A MINIMUM OF TWO PAIRS OF TURN ARROWS SHALL BE USED, WHITE IN COLOR. ADDITIONAL PAIRS SHALL BE PLACED AT 200' (60 m) TO 300' (90 m) INTERVALS.

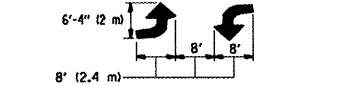

TYPICAL PAINTED MEDIAN MARKING

TYPE OF MARKING	WIDTH OF LINE	PATTERN	COLOR	SPACING / REMARKS
CENTERLINE ON 2 LANE PAVEMENT	4 (100)	SKIP-DASH	YELLOW	10' (3 m) LINE WITH 30' (9 m) SPACE
CENTERLINE ON MULTI-LANE UNDIVIDED PAVEMENT	2 @ 4 (100)	SOLID	YELLOW	11 (280) C-C
NO PASSING ZONE LINES: FOR ONE DIRECTION FOR BOTH DIRECTIONS	4 (100) 2 @ 4 (100)	SOLID SOLID	YELLOW YELLOW	5/2 (140) C-C FROM SKIP-DASH CENTERLINE 11 (280) C-C OMIT SKIP-DASH CENTERLINE BETWEEN
LANE LINES	4 (100) 5 (125) ON FREEWAYS	SKIP-DASH SKIP-DASH	WHITE WHITE	10' (3 m) LINE WITH 30' (9 m) SPACE
DOTTED LINES (EXTENSIONS OF CENTER, LANE OR TURN LANE MARKINGS)	SAME AS LINE BEING EXTENDED	SKIP-DASH	SAME AS LINE BEING EXTENDED	2' (600) LINE WITH 6' (1.8 m) SPACE
EDGE LINES	4 (100)	SOLID	YELLOW-LEFT WHITE-RIGHT	OUTLINE MOUNTABLE MEDIANS IN YELLOW; EDGE LINES ARE NOT USED NEXT TO BARRIER CURB
TURN LANE MARKINGS	6 (150) LINE; FULL SIZE LETTERS & SYMBOLS (8' (2.4m))	SOLID	WHITE	SEE TYPICAL TURN LANE MARKING DETAIL
TWO WAY LEFT TURN MARKING	2 @ 4 (100) EACH DIRECTION 8' (2.4m) LEFT ARROW	SKIP-DASH AND SOLID IN PAIRS	YELLOW WHITE	10' (3 m) LINE WITH 30' (9 m) SPACE FOR SKIP-DASH; 5/2 (140) C-C BETWEEN SOLID LINE AND SKIP-DASH LINE SEE TYPICAL TWO-WAY LEFT TURN MARKING DETAIL
CROSSWALK LINES (PEDESTRIAN) A. DIAGONALS (BIKE & EQUESTRIAN) B. LONGITUDINAL BARS (SCHOOL)	2 @ 6 (150) 12 (300) @ 45° 12 (300) @ 90°	SOLID SOLID SOLID	WHITE WHITE WHITE	NOT LESS THAN 6' (1.8 m) APART 2' (600) APART 2' (600) APART SEE TYPICAL CROSSWALK MARKING DETAILS.
STOP LINES	24 (600)	SOLID	WHITE	PLACE 4' (1.2 m) IN ADVANCE OF AND PARALLEL TO CROSSWALK, IF PRESENT. OTHERWISE, PLACE AT DESIRED STOPPING POINT. PARALLEL TO CROSSROAD CENTERLINE, WHERE POSSIBLE
PAINTED MEDIANS	2 @ 4 (100) WITH 12 (300) DIAGONALS @ 45° NO DIAGONALS USED FOR 4' (1.2 m) WIDE MEDIANS	SOLID	YELLOW: TWO WAY TRAFFIC WHITE: ONE WAY TRAFFIC	11 (280) C-C FOR THE DOUBLE LINE SEE TYPICAL PAINTED MEDIAN MARKING.
GORE MARKING AND CHANNELIZING LINES	8 (200) WITH 12 (300) DIAGONALS @ 45°	SOLID	WHITE	DIAGONALS: 15' (4.5 m) C-C (LESS THAN 30MPH (50 km/h)) 20' (6 m) C-C 30MPH (50 km/h) TO 45MPH (70 km/h) 30' (9 m) C-C (OVER 45MPH (70 km/h))
RAILROAD CROSSING	24 (600) TRANSVERSE LINES; "RR" IS 6' (1.8 m) LETTERS; 16 (400) LINE FOR "X"	SOLID	WHITE	SEE STATE STANDARD 780001 AREA OF: "RR"=3.6 SQ. FT. (0.33 m <sup>2</sup> ) EACH "X"=54.0 SQ. FT. (5.0 m <sup>2</sup> )
SHOULDER DIAGONALS	12 (300) @ 45°	SOLID	WHITE - RIGHT YELLOW - LEFT	50' (15 m) C-C (LESS THAN 30MPH (50 km/h)) 75' (25 m) C-C (30 MPH (50 km/h) TO 45MPH (70 km/h)) 150' (45 m) C-C (OVER 45MPH (70 km/h))

FOR FURTHER DETAILS ON PAVEMENT MARKING REFER TO STANDARD SPECIFICATIONS FOR ROAD AND BRIDGE CONSTRUCTION AND STATE STANDARD 780001.

All dimensions are in inches (millimeters) unless otherwise shown.

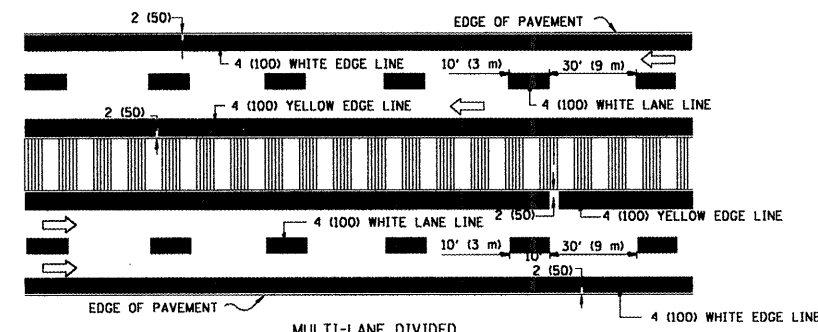

NOTE: MEDIANS WITH BARRIER CURB DO NOT REQUIRE AN EDGE LINE

TYPICAL LANE AND EDGE LINE MARKING

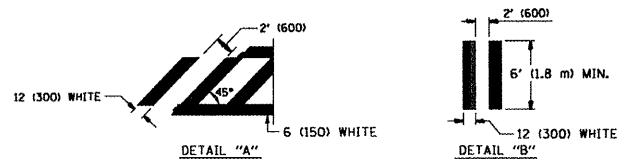
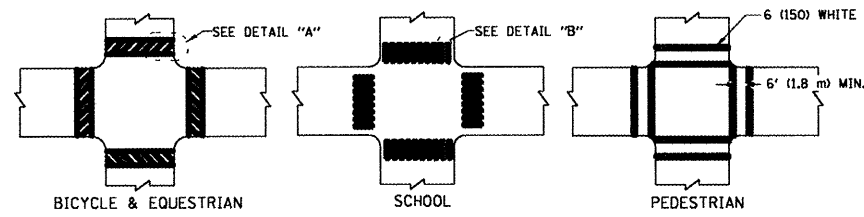

TYPICAL CROSSWALK MARKING

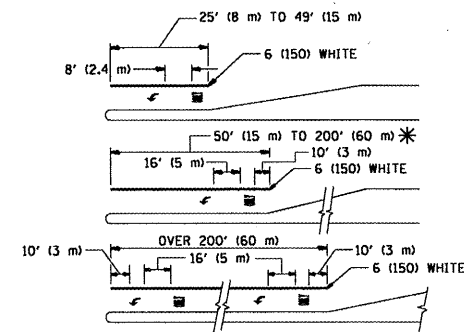

FULL SIZE LETTERS 8' (2.4 m) AND ARROWS SHALL BE USED. AREA = 15.6 SQ. FT. (1.5 m<sup>2</sup>) ONLY AREA = 20.8 SQ. FT. (1.9 m<sup>2</sup>)

\* TURN LANES IN EXCESS OF 400' (120 m) IN LENGTH MAY HAVE AN ADDITIONAL SET OF ARROW - "ONLY" INSTALLED MIDWAY BETWEEN THE OTHER TWO SETS OF ARROW - "ONLY".

TYPICAL LEFT (OR RIGHT) TURN LANE

TYPICAL TURN LANE MARKING

STATE OF ILLINOIS  
DEPARTMENT OF TRANSPORTATION

DISTRICT ONE  
TYPICAL PAVEMENT MARKINGS

SCALE: NONE SHEET NO. 1 OF 1 SHEETS STA. TO STA.

F.A. RTE. SECTION COUNTY TOTAL SHEETS SHEET NO.  
VAR. 2009-01B PP LAKE 32 28  
TC-13 CONTRACT NO. 60G17  
FED. ROAD DIST. NO. 1 ILLINOIS FED. AID PROJECT

FILE NAME: USER NAME: smthkl DESIGNED: EVERS REVISED: T. RAMMACHER 10-27-94  
DRAWN: A. HOUSEH 10-09-96  
PLOT SCALE: 100.0000' / IN. CHECKED: A. HOUSEH 10-17-96  
PLOT DATE: 2/4/2009 DATE: 03-19-90 REVISED: T. RAMMACHER 01-06-00

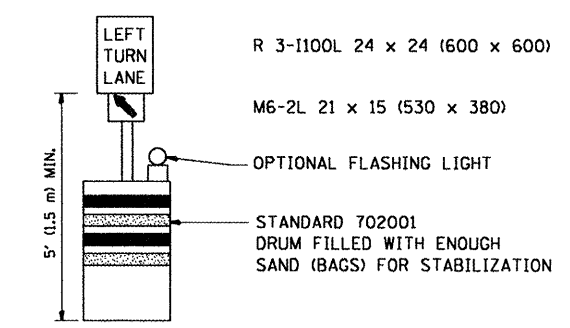
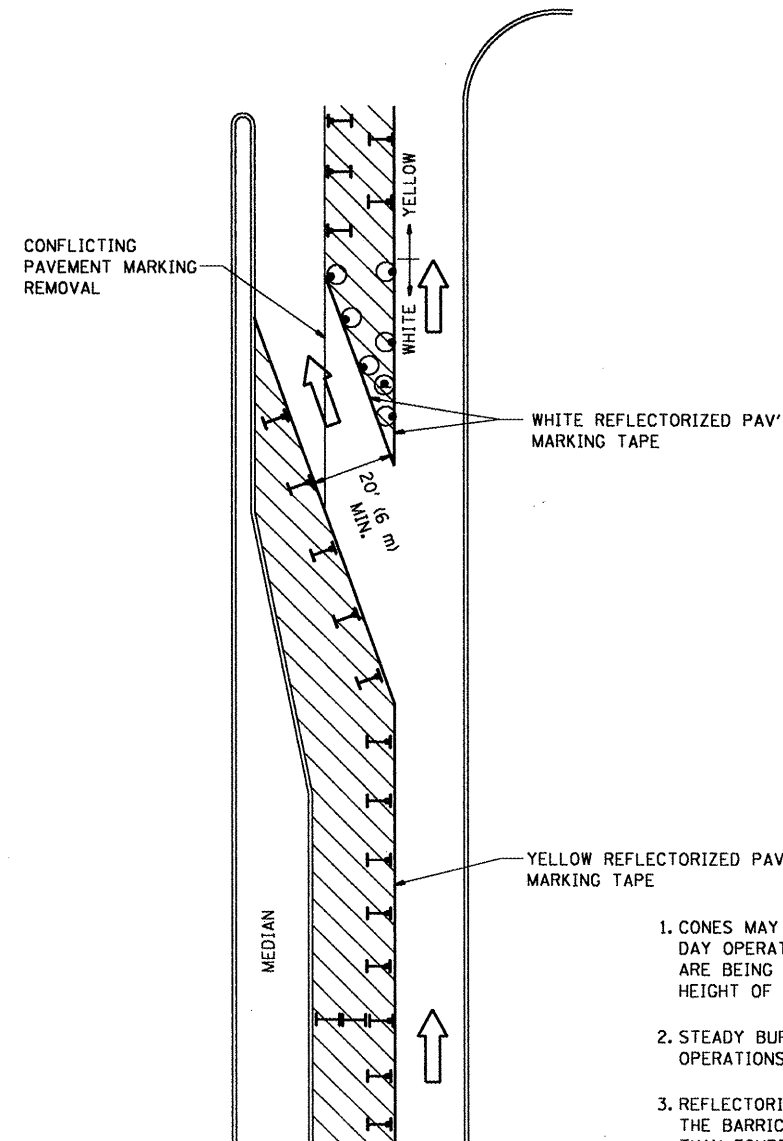







**GENERAL NOTES**

1. CONES MAY BE SUBSTITUTED FOR BARRICADES OR DRUMS AT HALF THE SPACING DURING DAY OPERATIONS. CONES SHALL BE A MINIMUM OF 28 (710) IN HEIGHT. WHEN CONES ARE BEING USED, THE "LEFT TURN LANE" SIGN MAY BE SKID MOUNTED AT A MINIMUM HEIGHT OF 5' (1.5 m).
2. STEADY BURNING LIGHTS WILL NOT BE REQUIRED ON BARRICADES OR DRUMS FOR DAY OPERATIONS. ALL LIGHTS SHALL BE MONODIRECTIONAL.
3. REFLECTORIZED TEMPORARY PAVEMENT MARKING TAPE SHALL BE PLACED THROUGHOUT THE BARRICADED AREA OF EACH TURN BAY WHERE THE CLOSURE TIME IS GREATER THAN FOURTEEN DAYS.
4. THIS APPLICATION ALSO APPLIES WHEN WORK IS BEING PERFORMED IN THE RIGHT LANE(S) AND THE RIGHT TURN BAY IS TO REMAIN OPEN. UNDER THIS CONDITION, "RIGHT TURN LANE" R3-100 24 x 24 (600 x 600) AND M6-2R 21 x 15 (530 x 380) SHALL BE USED.
5. THESE CONTROLS SHALL SUPPLEMENT MAINLINE TRAFFIC CONTROL FOR LANE CLOSURES.
6. LONGITUDINAL DIMENSIONS MAY BE ADJUSTED TO FIT FIELD CONDITIONS.
7. FORM BT 725 IS REQUIRED.
8. TRAFFIC CONTROL AND PROTECTION AT TURN BAYS (TO REMAIN OPEN TO TRAFFIC) SHALL BE INCLUDED IN THE COST SPECIFIED TRAFFIC CONTROL STANDARDS OR ITEMS.

All dimensions are in inches (millimeters) unless otherwise shown.

**LEGEND**

-  WORK AREA
-  LANE OPEN TO TRAFFIC
-  TYPE I OR II BARRICADE WITH STEADY BURN LIGHT
-  DRUM WITH STEADY BURN LIGHT
-  DRUM WITH SIGN (WITH OPTIONAL FLASHING LIGHT) SEE DETAIL
-  TYPE I OR II CHECK BARRICADE WITH FLASHING LIGHT

FILE NAME =	USER NAME = smthkl	DESIGNED -	REVISED -T. RAMMACHER 09-08-94
ce\pwwork\pwwork\smthkl\0125025\Dist5.dgn		DRAWN -	REVISED - A. HOUSEH 11-07-95
		CHECKED -	REVISED - A. HOUSEH 10-12-96
		DATE -	REVISED -T. RAMMACHER 01-06-00

**STATE OF ILLINOIS  
DEPARTMENT OF TRANSPORTATION**

**TRAFFIC CONTROL AND PROTECTION AT TURN BAYS  
(TO REMAIN OPEN TO TRAFFIC)**

SCALE: NONE SHEET NO. 1 OF 1 SHEETS STA. TO STA.

F.A. RTE.	SECTION	COUNTY	TOTAL SHEETS	SHEET NO.
VAR.	2009-018 PP	LAKE	32	29
TC-14			CONTRACT NO. 60G17	
FED. ROAD DIST. NO. 1 ILLINOIS FED. AID PROJECT				

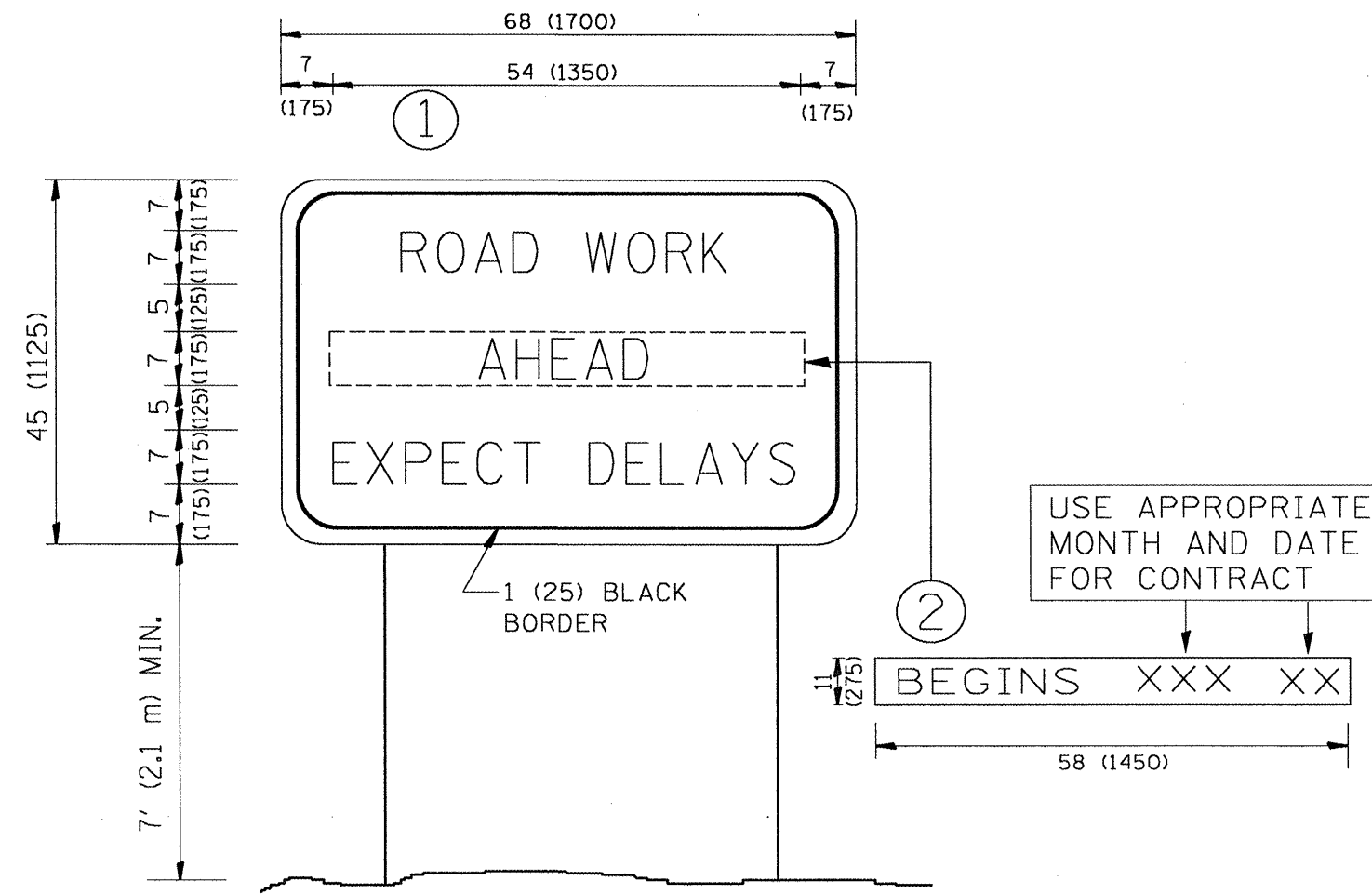

**NOTES:**

1. USE BLACK LETTERING ON ORANGE BACKGROUND.
2. ERECT SIGNS IN ADVANCE OF THE LOCATION FOR THE "ROAD CONSTRUCTION AHEAD" SIGN AT LOCATIONS AS DIRECTED BY THE ENGINEER.
3. ERECT SIGN ① WITH INSTALLED PANEL ② ONE WEEK PRIOR TO THE START OF CONSTRUCTION.
4. REMOVE PANEL ② SOON AFTER THE START OF CONSTRUCTION.
5. SEE SPECIAL PROVISION FOR "TEMPORARY INFORMATION SIGNING" FOR ADDITIONAL INFORMATION.
6. ONE SIGN ASSEMBLY EQUALS 25.70 SQ. FT. (2.3 SQ. M.)
7. SHALL BE PAID FOR AS TEMPORARY INFORMATION SIGNING.

ALL DIMENSIONS ARE IN INCHES (MILLIMETERS) UNLESS OTHERWISE SHOWN.

FILE NAME =	USER NAME = smsthk1	DESIGNED -	REVISED - R. MIRS 09-15-97
es:\pw_work\pwidot\smsthk\1\0125025\Dist5	d.dgn	DRAWN -	REVISED - R. MIRS 12-11-97
PLOT SCALE = 1/8"=1'-0"	CHECKED -	REVISED - T. RAMMACHER 02-02-99	
PLOT DATE = 2/4/2009	DATE -	REVISED - C. JUCIUS 01-31-07	

**STATE OF ILLINOIS  
DEPARTMENT OF TRANSPORTATION**

<b>ARTERIAL ROAD INFORMATION SIGN</b>	
SCALE: NONE	SHEET NO. 1 OF 1 SHEETS STA. TO STA.

F.A. RTE.	SECTION	COUNTY	TOTAL SHEETS	SHEET NO.
VAR.	2009-01B PP	LAKE	32	30
TC-22		CONTRACT NO. 60G17		
FED. ROAD DIST. NO. 1 ILLINOIS FED. AID PROJECT				

## LOOP DETECTOR NOTES

- EACH PAIR OF LOOP WIRES SHALL BE PLACED IN A SEPARATE UNIT DUCT FROM THE EDGE OF PAVEMENT TO THE HANDHOLE. SPACING BETWEEN THE HOLES DRILLED IN THE PAVEMENT SHALL NOT BE LESS THAN 6" (150 mm). UNIT DUCT SHALL BE INCLUDED IN THE COST OF THE LOOP WIRE.
- THE NUMBER OF LOOP TURNS SHALL BE AS RECOMMENDED BY THE AMPLIFIER MANUFACTURER. ALL ADJACENT SIDES OF THE LOOPS SHALL BE INSTALLED IN SUCH A WAY THAT THE CURRENT FLOW IS IN THE SAME DIRECTION TO REINFORCE ITS MAGNETIC FIELDS FOR SMALL VEHICLE DETECTION.
- EACH LOOP LEAD-IN SHALL BE IDENTIFIED AND PERMANENTLY TAGGED IN THE HANDHOLE. EACH LEAD-IN CABLE TAG SHALL INDICATE THE LOCATION OF THE LOOP, LOOP ROTATION (CLOCKWISE/COUNTERCLOCKWISE), LOOP LEAD-IN DIRECTION (IN OR OUT), LOOP CABLE NUMBER AND LOCATION IN CABINET, AND NUMBER OF TURNS IN THE DETECTOR LOOPS IN WATER PROOF INK AS INDICATED ON THE DISTRICT 1 STANDARD TRAFFIC SIGNAL DESIGN DETAIL. THE CONTRACTOR SHALL MARK LOOP LOCATIONS ON RECORD DRAWINGS AND PRESENT TO THE ENGINEER AFTER FINAL INSPECTION. LOOPS SHALL BE MARKED BY LANE AND LOOP NUMBER. SEE DETAIL BELOW.
- ALL LOOP CABLE SHALL BE FASTENED WITH PLASTIC TIE WRAP TO THE HANDHOLE HOOKS.
- IN ASPHALT PAVEMENT, LOOPS SHOULD BE PLACED IN THE BINDER AND DIVEHOLES MARKED AT THE CURB WITH A SAW-CUT. THE SAW-CUT SHALL BE CUT IN ACCORDANCE WITH LOCAL AND E.P.A. DUST CONTROL REQUIREMENTS. DETECTOR LOOP(S) SHALL NOT BE INSTALLED IN WET CONDITIONS AND THE SAW-CUTS MUST BE FREE OF DEBRIS AND RESIDUE SUCH AS DUST AND WATER WHICH IS TO BE ACHIEVED BY THE USE OF COMPRESSED AIR, WIRE BRUSHING AND HEAT DRYING ACCORDING TO SEALANT MANUFACTURER REQUIREMENTS. THE DETECTOR WIRE SHALL BE HELD IN PLACE BY THE USE OF FORM WEDGES. WEDGES SHALL BE SPACED NO MORE THAN 18" (450 mm) APART.
- LOOP SPLICES SHALL BE SOLDERED USING A SOLDERING IRON. BLOW TORCHES OR OTHER DEVICES WHICH OXIDIZE COPPER CABLE SHALL NOT BE ALLOWED FOR SOLDERING OPERATIONS. SEE DETAIL BELOW RIGHT.
- PERFORMED DETECTOR LOOPS SHALL BE USED, AS SHOWN ON THE PLANS, WHERE NEW CONCRETE PAVEMENT IS PROPOSED. THE INSTALLATION OF PREFORMED LOOPS SHALL BE IN ACCORDANCE WITH THE DISTRICT 1 SPECIFICATIONS OR AS DIRECTED BY THE ENGINEER.

### LOOP LEAD-IN CABLE TAG

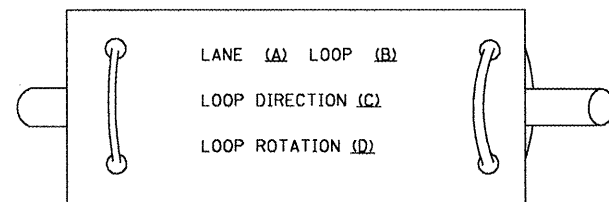

- LANE 1 IS THE LANE CLOSEST TO THE CENTERLINE OF THE ROADWAY
- LOOP #1 IS THE LOOP IN THE LANE CLOSEST TO THE INTERSECTION.
- LABEL LOOP CABLE "IN" OR LOOP CABLE "OUT".
- LABEL LOOP CABLE CLOCKWISE OR LOOP CABLE COUNTERCLOCKWISE.

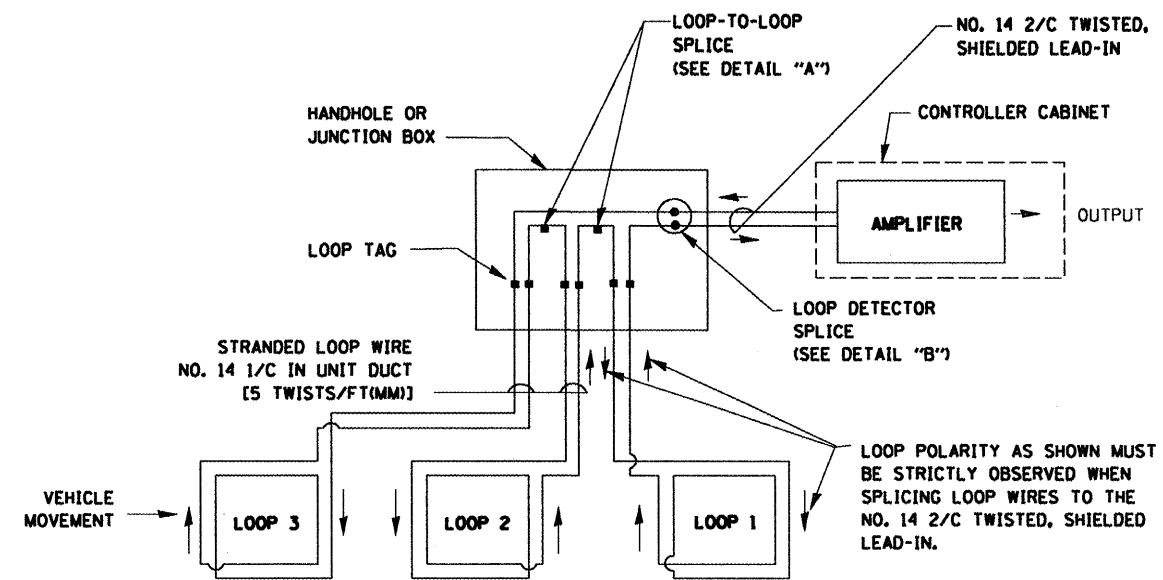

### DETECTOR LOOP WIRING SCHEMATIC

- LOOPS SHALL BE SPLICED IN SERIES.
- SAW-CUTS SHALL BE A MINIMUM WIDTH OF 5/16" (8 mm).
- SAW-CUT DEPTHS SHALL BE 3" (75 mm), IF IN CONCRETE. THE SAW-CUT DEPTH SHALL BE TO THE TOP OF THE REINFORCEMENT.
- LOOP CORNERS SHALL BE DRILLED WITH A 2" (50 mm) DIAMETER CORE.

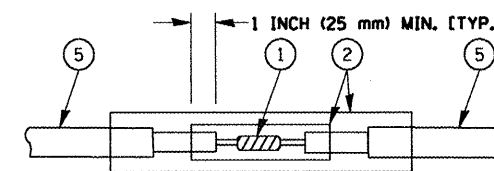

DETAIL "A"  
LOOP-TO-LOOP SPLICE

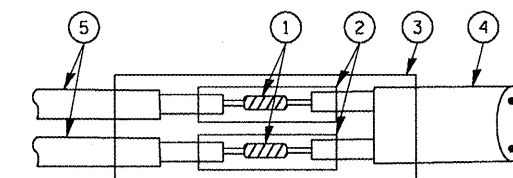

DETAIL "B"  
LOOP-TO-CONTROLLER SPLICE

### LOOP DETECTOR SPLICE

- WESTERN UNION SPLICE SOLDERED WITH ROSIN CORE FLUX. ALL EXPOSED SURFACES OF THE SOLDER SHALL BE SMOOTH.
- WCSMW 30/100 HEAT SHRINK TUBE, MINIMUM LENGTH 3" (75 mm), UNDERWATER GRADE.
- WCS 200/750 HEAT SHRINK TUBE, MINIMUM LENGTH 6" (150 mm), UNDERWATER GRADE.
- NO. 14 2/C TWISTED, SHIELDED CABLE.
- LOOP CONDUCTOR WITH FLEXIBLE PLASTIC TUBE.

FILE NAME =	USER NAME = smsthkl	DESIGNED - D.A.D.	REVISED - 11-12-01
or:\pw_work\pwidot\smsthkl\00125025\01st5	id.dgn	DRAWN - R.W.P.	REVISED - BUR. TRAFFIC 01-01-02
PLOT SCALE = 100.0000' / IN.	CHECKED - D.A.Z.	REVISED -	
PLOT DATE = 2/4/2009	DATE - 05-30-00	REVISED -	

STATE OF ILLINOIS  
DEPARTMENT OF TRANSPORTATION

DISTRICT ONE  
STANDARD TRAFFIC SIGNAL DESIGN DETAILS

SCALE: NONE SHEET NO. 1 OF 4 SHEETS STA. TO STA.

F.A. RTE.	SECTION	COUNTY	TOTAL SHEETS	SHEET NO.
VAR.	2009-018 PP	LAKE	32	31
TS-05			CONTRACT NO. 60G17	
FED. ROAD DIST. NO. 1 (ILLINOIS) FED. AID PROJECT				

**LOOPS NEXT TO SHOULDERS**

PROVIDE A PAVEMENT REPLACEMENT NOTE WHICH SHOULD EQUAL 3' (900 mm) X WIDTH OF PAVED SHOULDER.

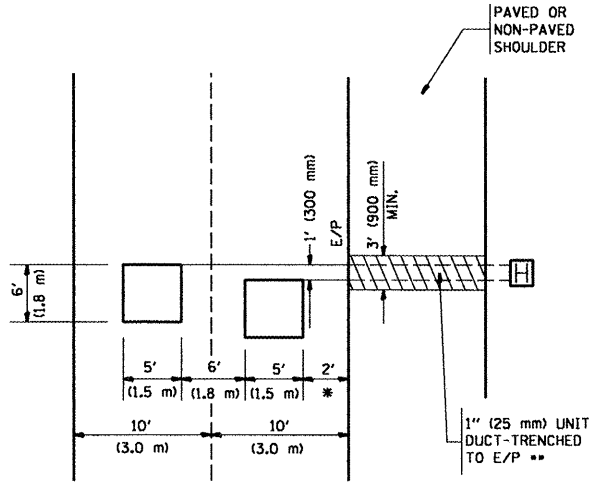

\* = (600 mm)

\*\* UNIT DUCT IS TO BE SHOWN ON PLAN SHEETS BUT SHALL NOT BE INCLUDED IN THE PAY ITEMS.

**LEFT TURN LANES WITH MEDIANS  
VOLUME DENSITY ("FAR OUT" DETECTION)  
ON SAME APPROACH  
(PROTECTED / PERMITTED LEFT TURN PHASING)**

HANDHOLE LOCATION MAY VARY DEPENDING ON GEOMETRICS AND DESIGN OF TRAFFIC SIGNALS. HEAVY-DUTY HANDHOLES TO BE USED WHEN THE MEDIAN IS MOUNTABLE. REFER TO STANDARD B14001 TO ENSURE THAT HANDHOLE FITS IN MEDIAN.

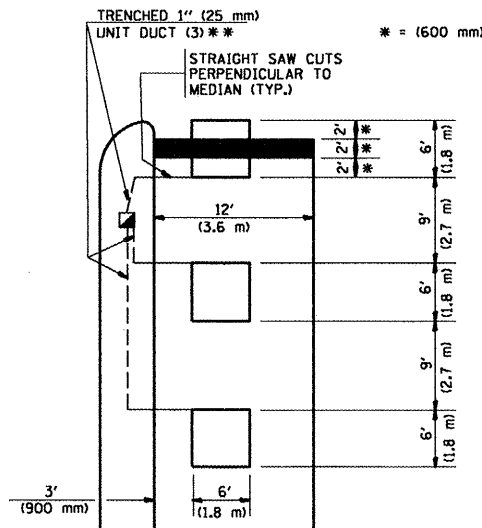

\*\* UNIT DUCT IS TO BE SHOWN ON PLAN SHEETS BUT SHALL NOT BE INCLUDED IN THE PAY ITEMS.

NOTE: DUAL LEFT TURNS NOT SHOWN REFER TO PLAN SHEET FOR DETECTOR LOOP REPLACEMENT

**LEFT TURN LANES WITHOUT MEDIANS  
VOLUME DENSITY ("FAR OUT" DETECTION)  
ON SAME APPROACH  
(PROTECTED / PERMITTED LEFT TURN PHASING)**

\* = (600 mm)

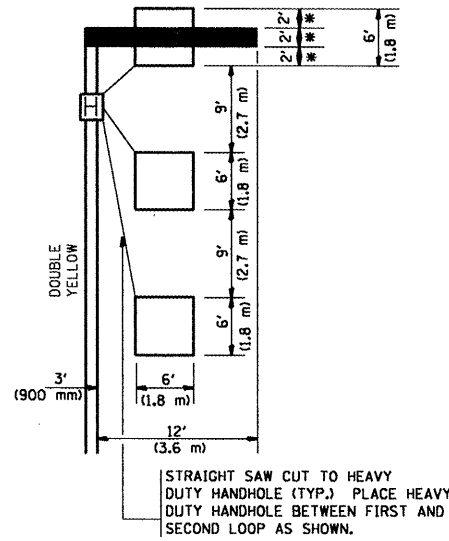

NOTE: DUAL LEFT TURNS NOT SHOWN REFER TO PLAN SHEET FOR DETECTOR LOOP REPLACEMENT

**ARTERIAL-VOLUME DENSITY ("FAR OUT" DETECTION)  
CROSS STREET-VOLUME DENSITY ("FAR OUT" DETECTION)**

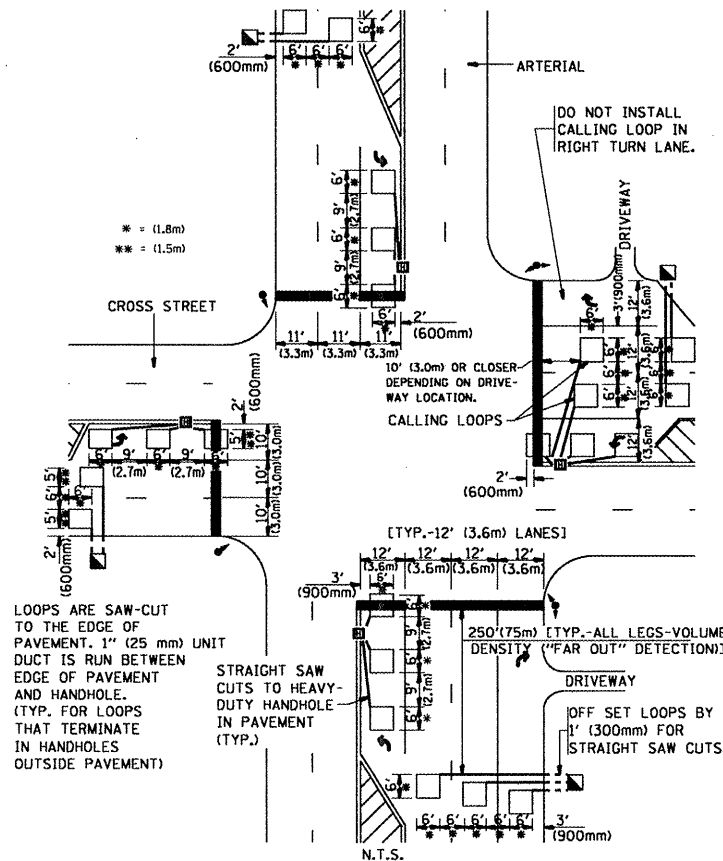

**DETAIL 1  
N.T.S.**

**ARTERIAL-VOLUME DENSITY ("FAR OUT" DETECTION)  
CROSS STREET-NON VOLUME DENSITY ("UPTIGHT" PRESENCE DETECTION)**

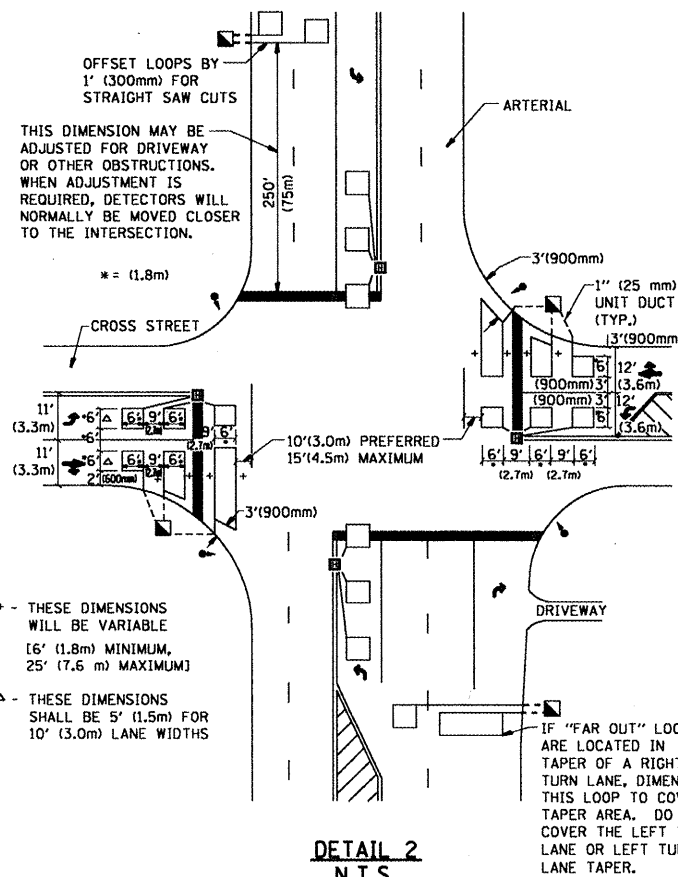

**DETAIL 2  
N.T.S.**

**NOTES:**

**VEHICLES LOOP DETECTORS**

- \* ALL LEAD IN CABLE SHALL BE TWO CONDUCTOR NO. 14 TWISTED, SHIELDED.
- \* EACH DETECTOR LOOP SHALL HAVE ITS OWN SAW CUT FROM THE LOOP TO THE EDGE OF PAVEMENT OR TO A HANDHOLE IN THE PAVEMENT.
- \* EACH DETECTOR LOOP SHALL HAVE ITS OWN ONE INCH (25 mm) UNIT DUCT BETWEEN THE EDGE OF PAVEMENT AND THE FIRST HANDHOLE OR JUNCTION BOX. EACH UNIT DUCT RUN SHALL BE SHOWN ON THE PLANS BY THE DESIGNER, BUT SHALL NOT BE PAID FOR SEPARATELY. THIS ITEM IS INCIDENTAL TO THE PAY ITEM FOR DETECTOR LOOPS.
- \* ONE DIMENSION OF ALL DETECTOR LOOPS SHALL BE SIX FEET (1.8 m)
- \* EACH LANE OF NON-LOCKING, PRESENCE DETECTION AND EACH LANE OF A DOUBLE LEFT TURN LANE REQUIRES A SEPARATE INDUCTIVE LOOP DETECTOR AND LEAD IN CABLE.
- \* WHEN NON-LOCKING, PRESENCE DETECTION IS USED, MORE THAN ONE LOOP PER LANE IS REQUIRED BEHIND THE STOP BAR (i.e. 1-1/2, 1-3/4, 2).
- \* WHEN SYSTEM LOOPS ARE REQUIRED ON AN APPROACH OF AN INTERSECTION, THE LOOPS USED FOR VOLUME DENSITY AND INTERSECTION TIMING SHALL ALSO BE USED AS SYSTEM DETECTORS. EACH ONE OF THESE TYPE OF LOOPS REQUIRES A SEPARATE TWO CONDUCTOR NO. 14 TWISTED SHIELDED CABLE AND A SEPARATE INDUCTIVE LOOP DETECTOR WHEN NEW CONTROLLERS ARE UTILIZED. THE DESIGNER SHALL LABEL THESE TYPES OF LOOPS AS "INTERSECTION AND SAMPLING (SYSTEM) DETECTORS" ON THE SIGNAL LAYOUT, THE INTERCONNECT PLAN AND THE SYSTEM CABLE PLAN. WHEN AN EXISTING CONTROLLER IS UTILIZED FOR THIS TYPE OF DETECTION, THE PAY ITEM "INDUCTIVE LOOP DETECTOR WITH SYSTEM OUTPUT" SHOULD BE USED.

**PLACEMENT OF DETECTORS**

THE FOLLOWING FIGURES REPRESENT THE MOST COMMON DETECTOR LOOP LOCATIONS AND SIZES. ADJUSTMENTS WILL BE NECESSARY FOR SPECIFIC GEOMETRIC CONSIDERATIONS.

LOCATIONS AND DIMENSIONS OF DETECTOR LOOPS ARE REQUIRED ON ALL SIGNAL LAYOUT PLAN SHEETS.

"FAR OUT" DETECTION REFERS TO LOCKING, PRESENCE TYPE DETECTION LOCATED IN THRU LANES, RIGHT TURN LANES, AND RIGHT TURN LANE TAPER AREAS (IF APPLICABLE), USUALLY 250' (75 m) IN ADVANCE OF STOP BARS. "UPTIGHT" DETECTION REFERS TO NON-LOCKING PRESENCE TYPE DETECTION LOCATED IN ALL LANES AND 10'-15' (3.0 m-4.5 m) BEHIND THE CROSSING STREET'S EDGE OF PAVEMENT EXTENDED.

**NOTE:**

ALL DETAILS AND NOTES SHOWN ARE FROM THE I.D.O.T. DISTRICT 1 TRAFFIC SIGNAL DESIGN GUIDELINES DATED JANUARY 1995

THIS DRAWING HAS BEEN PREPARED TO ASSIST THE RESIDENT ENGINEER FOR ALL ROADWAY RESURFACING OR S.M.A.R.T. PROJECTS WHERE THE DIMENSIONS ARE NOT SHOWN ON THE PLANS AND THE FINAL LOCATIONS FOR CROSSWALKS OR STOP BARS ARE NOT DETERMINED.

**STATE OF ILLINOIS  
DEPARTMENT OF TRANSPORTATION**

**DISTRICT 1 - DETECTOR LOOP INSTALLATION  
DETAILS FOR ROADWAY RESURFACING**

F.A. RTE.	SECTION	COUNTY	TOTAL SHEETS	SHEET NO.
VAR.	2009-018 PP	LAKE	32	32
TS-07			CONTRACT NO. 60G17	
FED. ROAD DIST. NO. 1   ILLINOIS   FED. AID PROJECT				

SCALE: NONE SHEET NO. 1 OF 1 SHEETS STA. TO STA.