

VELDA STREET INTERSECTION

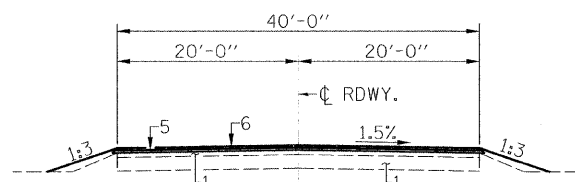

TYPICAL SECTION  
VELDA STREET

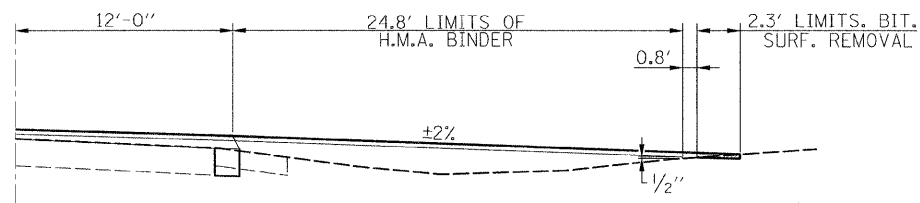

TAPER DETAIL  
VELDA STREET

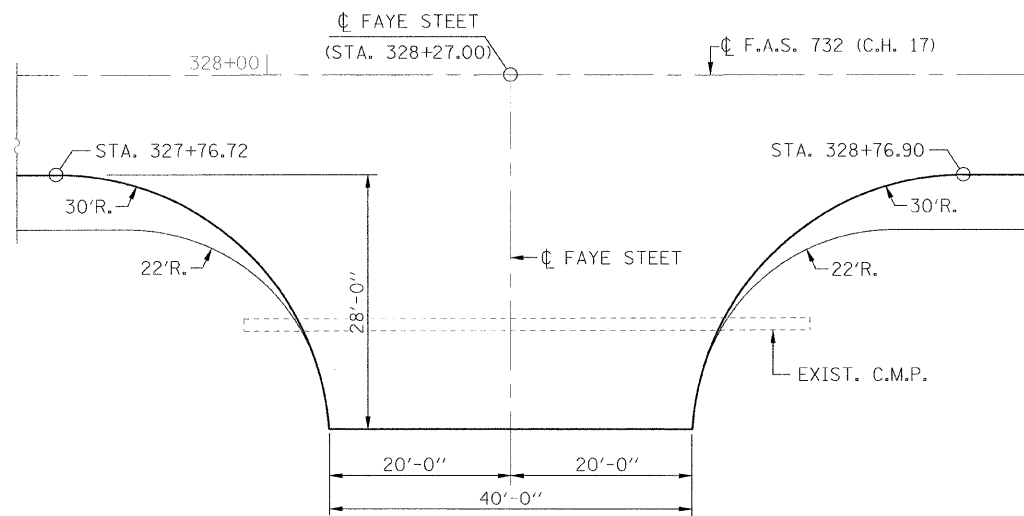

FAYE STREET INTERSECTION

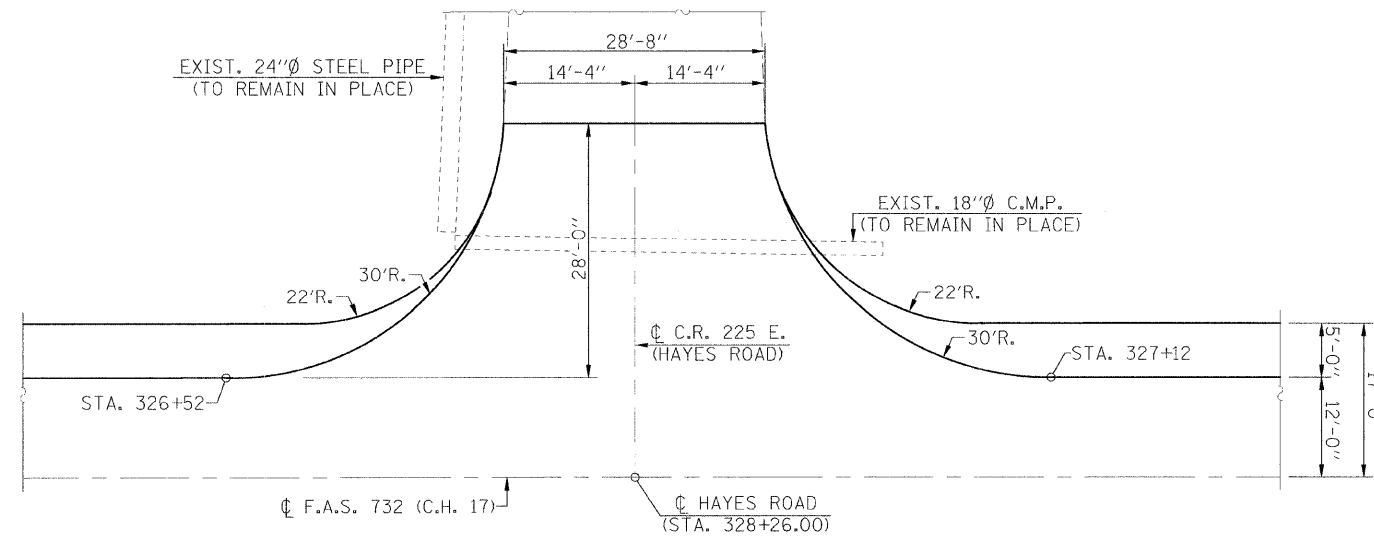

HAYES ROAD INTERSECTION

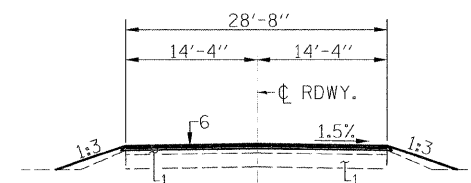

TYPICAL SECTION  
HAYES ROAD

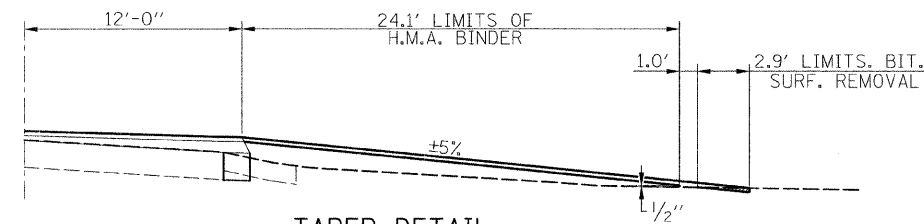

TAPER DETAIL  
HAYES ROAD

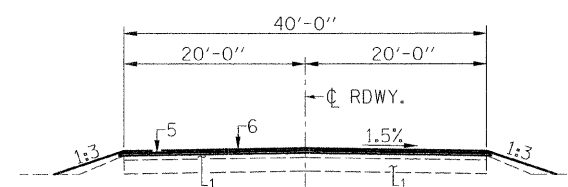

TYPICAL SECTION  
FAYE STREET

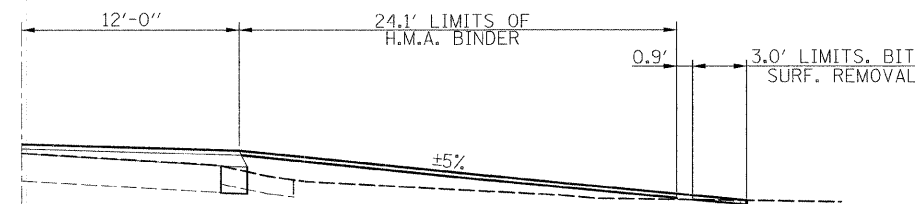

TAPER DETAIL  
FAYE STREET

USER NAME - #USER#	DESIGNED -	REVISED -
DRAWN -	CHECKED -	REVISED -
PLOT SCALE - #SCALE#	DATE -	REVISED -
PLOT DATE - #DATE#		



Allen Henderson & Associates, Inc.  
Civil and Structural Engineers Springfield, IL.  
62703 Phone: (217)544-8033 IL Design Firm  
No. 184-001907

INTERSECTION DETAILS

SCALE: \_\_\_\_\_ SHEET NO. \_\_\_\_ OF \_\_\_\_ SHEETS STA. \_\_\_\_\_ TO STA. \_\_\_\_\_

F.A.S. RTE.	SECTION	COUNTY	TOTAL SHEETS	SHEET NO.
732	07-00125-02-RS	MONTGOMERY	57	6
CONTRACT NO. 93480				
FED. ROAD DIST. NO. _____ ILLINOIS FED. AID PROJECT				