

F.A.P. RTE.	SECTION	COUNTY	TOTAL SHEETS	SHEET NO.
312	101-2(A,B,R)	ALEXANDER	152	32
STA.		TO STA.		
FED. ROAD DIST. NO.		ILLINOIS FED. AID PROJECT		

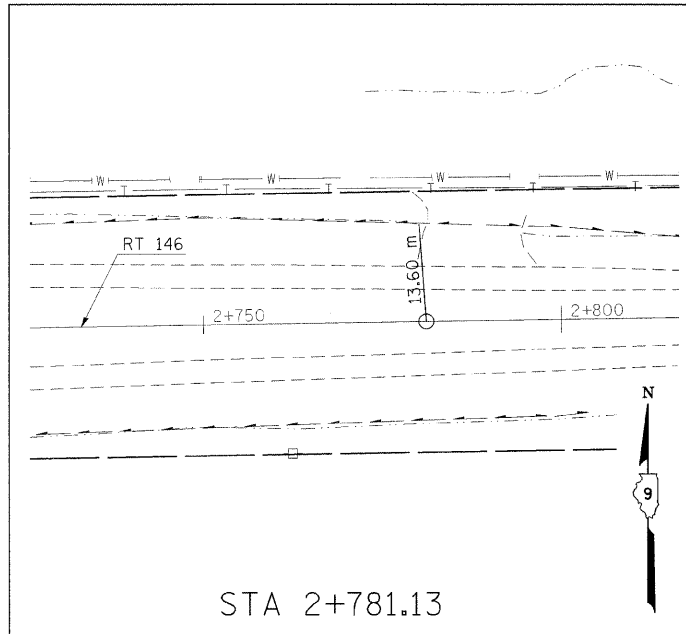

STA 2+781.13

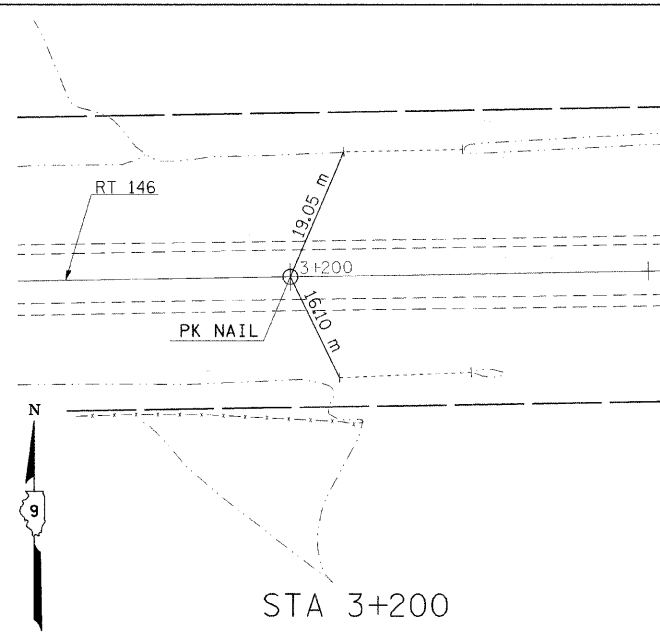

STA 3+200

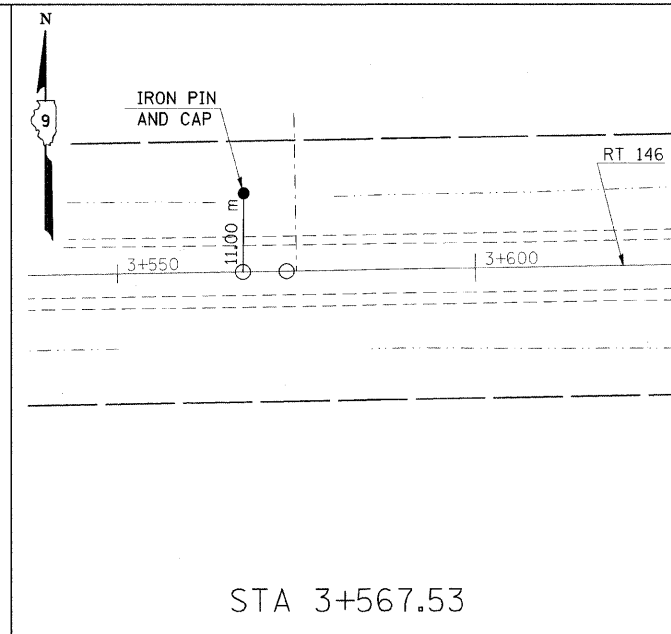

STA 3+567.53

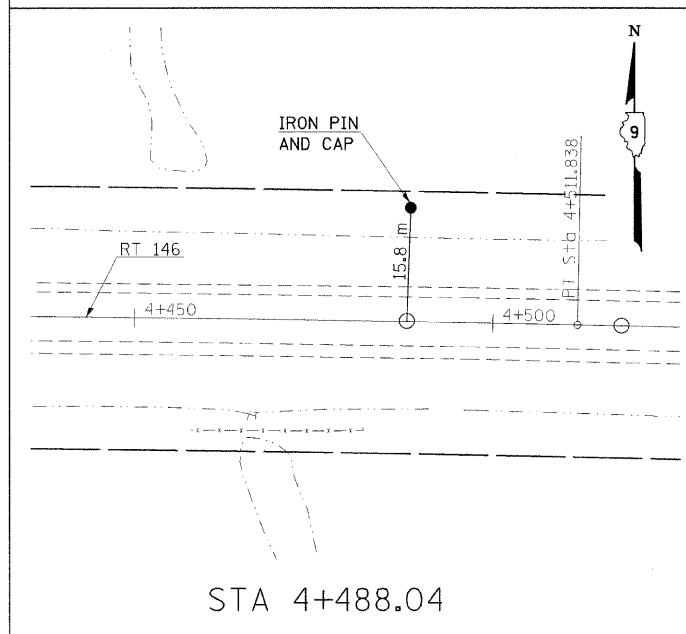

STA 4+488.04

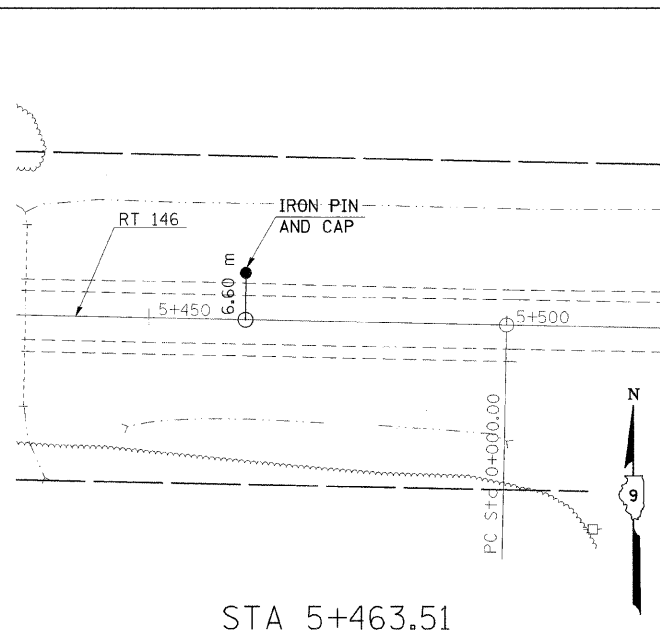

STA 5+463.51

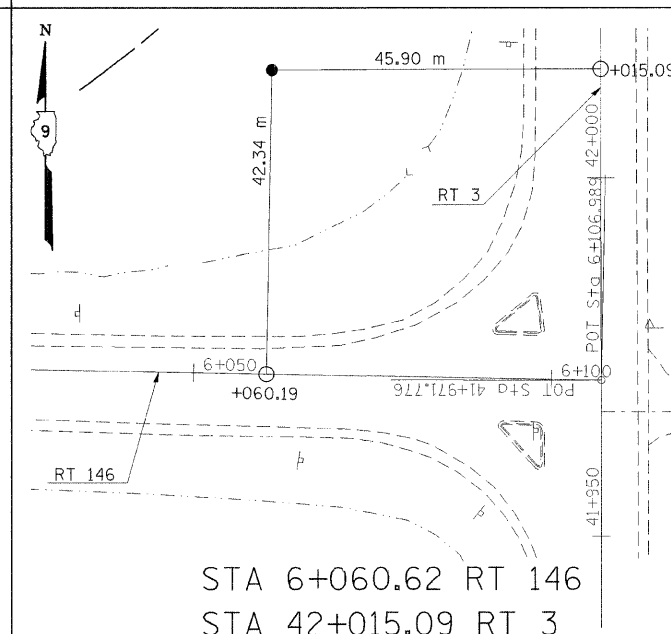

STA 6+060.62 RT 146  
STA 42+015.09 RT 3

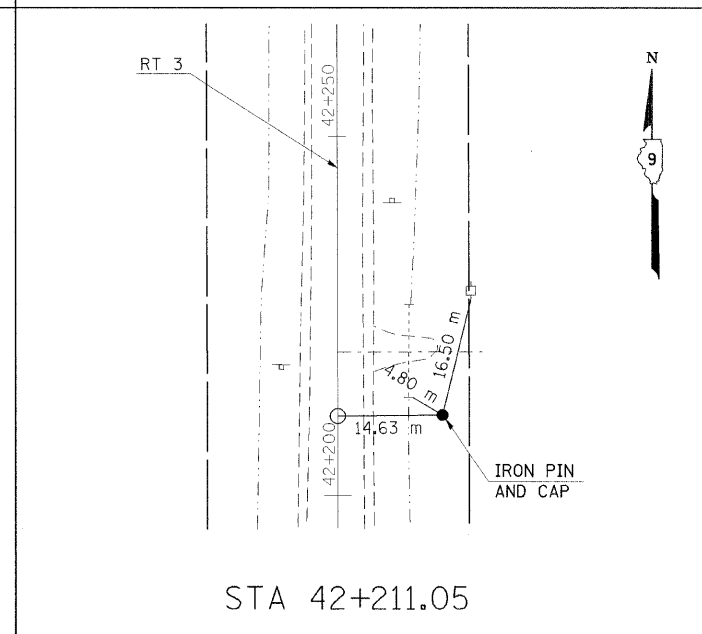

STA 42+211.05