

STATE OF ILLINOIS
DEPARTMENT OF TRANSPORTATION
DIVISION OF HIGHWAYS

PLANS FOR PROPOSED FEDERAL AID HIGHWAY FAU 2792 (LAWNDALE AVENUE) FAU 3562 (JOLIET ROAD) TO FAU 1488 (47TH STREET)

RESURFACING
SECTION 12-00018-00-RS
PROJECT M-4003(084)
VILLAGE OF McCOOK
VILLAGE OF LYONS
COOK COUNTY
JOB NO: C-91-011-13

FAU RTE	SECTION	COUNTY	TOTAL SHEETS	SHEET NO.
FAU 2792	12-00018-00-RS	COOK	18	1
F.H.W.A. REG.		ILLINOIS PROJECT	M-4003(084)	

CONTRACT NO. 61B15

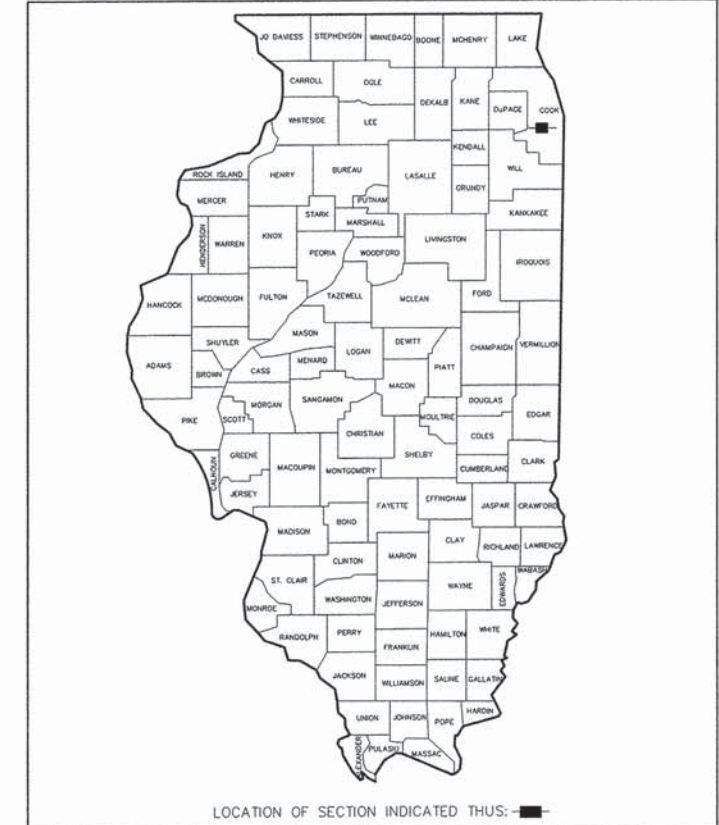

- INDEX OF SHEETS**
- COVER SHEET: INDEX OF SHEETS, LOCATION MAP, INDEX OF DISTRICT 1 DETAILS,
 - GENERAL CONSTRUCTION NOTES, INDEX OF HIGHWAY STANDARDS
 - SUMMARY OF QUANTITIES
 - TYPICAL SECTIONS, HOT-MIX ASPHALT MIXTURE REQUIREMENTS
 - 5-6.) PLAN: LAWNDALE AVENUE (RESURFACING)
 - 7.) PLAN: LAWNDALE AVENUE (PAVEMENT MARKINGS)
- INDEX OF DISTRICT 1 DETAILS**
- 8.) BD-08 DETAILS FOR FRAMES AND LIDS ADJUSTMENTS WITH MILLING
 - 9.) BD-22 PAVEMENT PATCHING FOR HMA SURFACED PAVEMENT
 - 10.) BD-24 CURB OR CURB AND GUTTER REMOVAL AND REPLACEMENT
 - 11.) BD-32 BUTT JOINT AND HMA TAPER DETAILS
 - 12.) TC-10 TRAFFIC CONTROL & PROTECTION FOR SIDE ROADS, INTERSECTIONS, & DRIVEWAYS
 - 13.) TC-11 TYPICAL APPLICATIONS RAISED REFLECTIVE PAVEMENT MARKINGS (SNOW PLOW RESISTANT)
 - 14.) TC-13 DISTRICT ONE TYPICAL PAVEMENT MARKINGS
 - 15.) TC-16 PAVEMENT MARKING LETTERS AND SYMBOLS FOR TRAFFIC STAGING
 - 16.) TC-22 ARTERIAL ROAD INFORMATION SIGN
 - 17.) TS-05 STANDARD TRAFFIC SIGNAL DESIGN DETAILS
 - 18.) TS-07 DETECTOR LOOP INSTALLATION DETAILS FOR ROADWAY RESURFACING

INDEX OF HIGHWAY STANDARDS
SEE SHEET 2

TRAFFIC DATA	DESIGN DESIGNATION
ADT: LAWNDALE AVENUE 3000 (2013)	LOCAL
<u>POSTED SPEED</u> 30 MPH (EXISTING) 30 MPH (PROPOSED)	<u>DESIGN SPEED</u> 30 MPH (EXISTING) 30 MPH (PROPOSED)

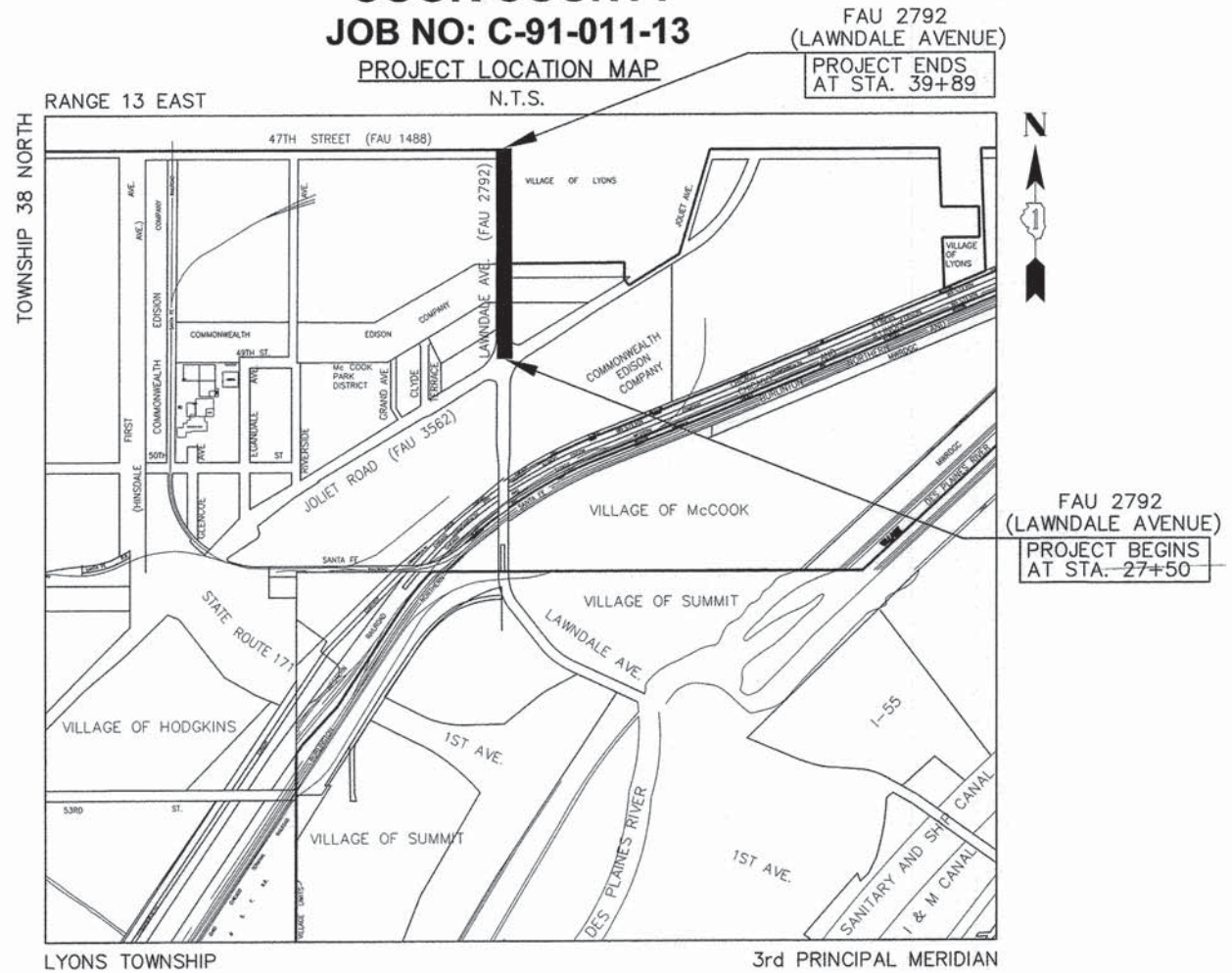

FEDERAL AID PROGRAM ENGINEER: FAWAD AQUEEL, P.E. (847)705-4021 SCHAUMBURG, IL.

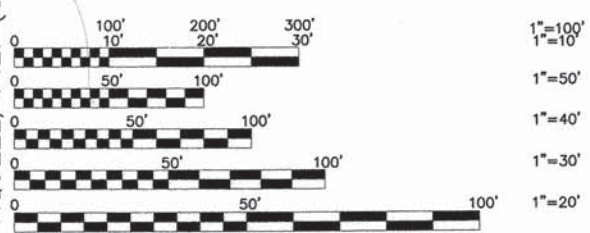

FULL SIZE PLANS HAVE BEEN PREPARED USING STANDARD ENGINEERING SCALES. REDUCED SIZED PLANS WILL NOT CONFORM TO STANDARD SCALES. IN MAKING MEASUREMENTS ON REDUCED PLANS, THE ABOVE SCALES MAY BE USED.

J.U.L.I.E.
JOINT UTILITY LOCATION INFORMATION FOR EXCAVATION
CALL 811

Know what's below.
Call before you dig.

Frank Novotny & Associates, Inc.
825 Midway Drive • Willowbrook, IL • 60527 • Telephone: (630) 887-5640 • Fax: (630) 887-0132
Civil Engineers/Municipal Consultants ILLINOIS PROFESSIONAL DESIGN FIRM NO. 184-00028

FNA PROJECT NO. 10070 DRAWN/DESIGNED JFP/JLC CHECKED/APPROVED THK/JLC

REVISIONS			
NO.	BY	DATE	DESCRIPTION
1	JLC	1/2/15	PER I.D.O.T. REVIEW

— DENOTES LOCATION OF IMPROVEMENT

LENGTH OF PROJECT

GROSS LENGTH OF PROJECT 1,248 FEET (0.24 MILES)
NET LENGTH OF PROJECT 1,248 FEET (0.24 MILES)

STATE OF ILLINOIS
DEPARTMENT OF TRANSPORTATION
DIVISION OF HIGHWAYS

APPROVED	<i>[Signature]</i>	20 15
VILLAGE OF McCOOK	JEFFREY TOBOLSKI, VILLAGE MAYOR	
APPROVED	<i>[Signature]</i>	20 15
VILLAGE OF LYONS	CHRISTOPHER GETTY, VILLAGE PRESIDENT	
PASSED	FEBRUARY 18, 2015	2015
	<i>[Signature]</i> CHRISTOPHER HOLT	
	DISTRICT 1 ENGINEER OF LOCAL ROADS & STREETS	
RELEASING FOR BID BASED ON LIMITED REVIEW	February 18	2015
	<i>[Signature]</i> John Fortman	
	DEPUTY DIRECTOR OF HIGHWAYS, REGION 1 ENGINEER	

[Signature]

JAMES L. CAINKAR, P.E.
IL. P.E. NO. 062-036190
EXPIRES 11-30-2015

1-5-14
DATE

SEAL

**PRINTED BY THE AUTHORITY
OF THE STATE OF ILLINOIS**

GENERAL CONSTRUCTION NOTES PAVING AND STORM SEWERS

SPECIFICATIONS

THE JAN 1, 2012 EDITIONS OF THE "STANDARD SPECIFICATIONS FOR ROAD AND BRIDGE CONSTRUCTION", THE "SUPPLEMENTAL SPECIFICATIONS AND RECURRING SPECIAL PROVISIONS", PREPARED BY THE ILLINOIS DEPARTMENT OF TRANSPORTATION AND THE "MANUAL OF UNIFORM TRAFFIC CONTROL DEVICES" SHALL GOVERN ALL WORK ASSOCIATED WITH THIS PROJECT. THE "STANDARD SPECIFICATIONS FOR WATER AND SEWER MAIN CONSTRUCTION IN ILLINOIS" MAY GOVERN OTHER WORK ON THIS PROJECT AS INDICATED BY REFERENCE.

CARE IN EXCAVATION

CARE SHALL BE EXERCISED BY THE CONTRACTOR IN CARRYING OUT EARTH AND/OR TRENCHING OPERATIONS SO THAT LOCAL UTILITY SERVICES, WATER VALVES, MANHOLES, CATCH BASINS, INLETS, BUFFALO BOXES, AND OTHER STRUCTURES ARE NOT DAMAGED OR REMOVED. ANY DAMAGE DONE BY THE CONTRACTOR, WHETHER THE STRUCTURE OR SERVICE IS VISIBLE AT THE GROUND SURFACE OR NOT, SHALL BE REPAIRED OR REPLACED BY THE CONTRACTOR IN ACCORDANCE WITH ARTICLE 105.07 OF THE "STANDARD SPECIFICATIONS FOR ROAD AND BRIDGE CONSTRUCTION".

NOTIFICATION OF PUBLIC UTILITIES

PRIOR TO STARTING CONSTRUCTION, THE CONTRACTOR SHALL NOTIFY THE OFFICIALS OF THE PUBLIC WORKS DEPARTMENT OF THE LOCAL MUNICIPALITIES AT (708)466-2646, LYONS, (708)447-2276, McCOOK, J.U.L.I.E. AT 1-800-892-0123 OR 811, AND OTHER PUBLIC AND PRIVATE UTILITIES SO THAT ARRANGEMENTS CAN BE MADE TO LOCATE THEIR VARIOUS FACILITIES WITHIN THE LIMITS OF CONSTRUCTION UNDER THIS CONTRACT, AS WELL AS TO PROVIDE ADEQUATE PROTECTION AND INSPECTION THERETO. IT SHALL BE THIS CONTRACTOR'S RESPONSIBILITY TO DETERMINE THE ACTUAL LOCATION OF ALL SUCH FACILITIES IN THE FIELD.

TRAFFIC CONTROL DEVICES

BARRICADES AND WARNING SIGNS SHALL BE PROVIDED IN ACCORDANCE WITH ARTICLE 107.14 OF THE "STANDARD SPECIFICATIONS FOR ROAD AND BRIDGE CONSTRUCTION".

PROTECTION OF SIGNS AND PROPERTY

ALL TRAFFIC SIGNS, STREET SIGNS, ETC., THAT INTERFERE WITH THE CONSTRUCTION OPERATIONS SHALL BE REMOVED AND PLACED AT NEW LOCATIONS AS DESIGNATED BY THE ENGINEER. THIS WORK SHALL BE CONSIDERED INCLUDED IN THE COST OF "MOBILIZATION", AND NO ADDITIONAL COMPENSATION WILL BE ALLOWED. IN ADDITION, ALL MAIL BOXES THAT INTERFERE WITH CONSTRUCTION SHALL BE SIMILARLY RELOCATED AT NO ADDITIONAL COST IN ACCORDANCE WITH ARTICLES 107.20 AND 107.21 OF THE "STANDARD SPECIFICATIONS FOR ROAD AND BRIDGE CONSTRUCTION".

SUPERINTENDENCE

SPECIAL ATTENTION IS DRAWN TO ARTICLE 105.06 OF THE "STANDARD SPECIFICATIONS FOR ROAD AND BRIDGE CONSTRUCTION" WHICH REQUIRES THE CONTRACTOR TO HAVE A COMPETENT SUPERINTENDENT ON THE PROJECT SITE AT ALL TIMES, IRRESPECTIVE OF THE AMOUNT OF WORK SUBLET. THE SUPERINTENDENT SHALL BE CAPABLE OF READING AND UNDERSTANDING THE PLANS AND SPECIFICATIONS, SHALL HAVE FULL AUTHORITY TO EXECUTE ORDERS TO EXPEDITE THE PROJECT AND SHALL BE RESPONSIBLE FOR SCHEDULING AND HAVING CONTROL OF ALL THE WORK AS THE AGENT OF THE GENERAL CONTRACTOR. FAILURE TO COMPLY WITH THIS PROVISION WILL RESULT IN A SUSPENSION OF WORK AS PROVIDED IN ARTICLE 108.07.

SAWING EXISTING IMPROVEMENTS

ALL PERMANENT TYPE PAVEMENTS OR OTHER PERMANENT IMPROVEMENTS WHICH ABUT THE PROPOSED IMPROVEMENT AND MUST BE REMOVED, SHALL BE SAWED AS DIRECTED PRIOR TO REMOVAL. ALL ITEMS SO REMOVED SHALL BE REPLACED WITH SIMILAR CONSTRUCTION MATERIALS TO THEIR ORIGINAL CONDITION OR BETTER. PAYMENT FOR SAWING SHALL BE INCLUDED IN THE COST FOR THE REMOVAL OF EACH ITEM, AND REPLACEMENT WILL BE PAID FOR UNDER THE RESPECTIVE ITEMS IN THE CONTRACT UNLESS OTHERWISE INDICATED. SAW CUTTING FOR PATCHES WILL BE INCLUDED IN THE COST OF TO THE PATCHING ITEM. EXISTING DRIVEWAY PAVEMENT AND SIDEWALK TO REMAIN IN PLACE SHALL BE SAWCUT TO PROVIDE A NEAT VERTICAL FACE BETWEEN THE PROPOSED AND THE EXISTING, AND SUCH COST SHALL BE CONSIDERED INCLUDED IN THE COST OF THE ITEM BEING REMOVED.

CONSTRUCTION LAYOUT STAKES

THE CONTRACTOR SHALL PROVIDE THE ENGINEER WITH WOODEN STAKES OR OTHER LAYOUT MATERIALS FOR LAYOUT OF THE LINES AND GRADES OF THE PROJECT. FAILURE TO PROVIDE STAKES IN A TIMELY MANNER WILL RESULT IN A DELAY IN STAKEOUT WHICH WILL BE APPLICABLE AGAINST THE TIME LIMIT FOR COMPLETION SHOWN IN THE PROJECT SPECIFICATIONS. LINE AND GRADE WILL BE ESTABLISHED BY THE ENGINEER AT REGULAR INTERVALS ON PERMANENTLY PAVED SURFACES, SIDEWALKS OR STAKES AT THE ENGINEER'S OPTION, ALL WITHIN THE PUBLIC RIGHT-OF-WAY AND SHALL BE TRANSFERRED BY THE CONTRACTOR TO THE ACTUAL LINE OF CONSTRUCTION.

PROJECT SAFETY

WHEN MILLED PAVEMENT IS OPEN TO TRAFFIC THE MAXIMUM GRADE DIFFERENTIAL BETWEEN PASSES OF THE MILLING MACHINE SHALL NOT EXCEED 1-1/2 INCHES WHERE THE SPEED LIMIT IS 45 MPH OR LESS AND 1 INCH WHERE THE SPEED LIMIT IS GREATER THAN 45 MPH. WITH WRITTEN APPROVAL FROM THE ENGINEER, A MAXIMUM GRADE DIFFERENTIAL OF 3 INCHES MAY BE ALLOWED IF THE EDGE OF THE MILLING IS SLOPED A MINIMUM 1:3 (V:H).

BUTT JOINTS WILL BE INSTALLED AT THE ENDS OF ALL RESURFACING (WHERE RESURFACING MEETS EXISTING PAVEMENT), IN ACCORDANCE WITH THE "BUTT JOINT AND HOT-MIX ASPHALT TAPER DETAILS" SHEET INCLUDED IN THE PLANS, UNLESS OTHERWISE SPECIFIED.

THE CONTRACTOR SHALL COMPLY WITH AND OBSERVE THE RULES AND REGULATIONS OF O.S.H.A. AND APPROPRIATE AUTHORITIES REGARDING SAFETY PROVISIONS. THE CONTRACTOR, ENGINEER, AND OWNER SHALL EACH BE RESPONSIBLE FOR THEIR OWN RESPECTIVE AGENTS AND EMPLOYEES.

THE ENGINEER AND OWNER ARE NOT RESPONSIBLE FOR THE CONSTRUCTION MEANS, METHODS, TECHNIQUES, SEQUENCES OR PROCEDURES, TIME OF PERFORMANCE, PROGRAMS, OR FOR ANY SAFETY PRECAUTIONS USED BY THE CONTRACTOR. THE CONTRACTOR IS SOLELY RESPONSIBLE FOR EXECUTION OF HIS WORK IN ACCORDANCE WITH THE DOCUMENTS AND SPECIFICATIONS.

THE RESIDENT ENGINEER SHALL CONTACT THE TRAFFIC CONTROL SUPERVISOR AT (847) 705-4470 A MINIMUM OF 72 HOURS PRIOR TO THE PLACEMENT OF ANY TEMPORARY TRAFFIC CONTROL DEVICES.

MISCELLANEOUS

ALL PATCHING ON THE HOT-MIX ASPHALT PORTAINS OF THIS PROJECT WILL BE MARKED OUT AND CONSTRUCTED AFTER MILLING. A PROOF ROLL WILL BE REQUIRED PRIOR TO PATCHING

PROTECTIVE COAT SHALL BE USED ON ALL PORTLAND CEMENT CONCRETE SURFACE IN ACCORDANCE WITH ARTICLES 420.21, 420.22, AND 420.23 OF THE STANDARD SPECIFICATIONS.

BEFORE BEGINNING ANY WORK, THE CONTRACTOR SHALL RETAIN AND RECORD FOR FUTURE REFERENCE, ALL EXISTING PAVEMENT MARKING LINES (AND RAISED REFLECTIVE PAVEMENT MARKERS) IN ORDER THAT THESE LOCATIONS CAN BE RE-ESTABLISHED FOR STRIPING. EXACT LOCATIONS OF ALL PAVEMENT MARKINGS SHALL BE AS DIRECTED BY THE ENGINEER.

INDEX OF HIGHWAY STANDARDS

000001-06	STANDARD SYMBOLS, ABBREVIATIONS, AND PATTERNS
442201-03	CLASS C AND D PATCHES
606001-06	CONCRETE CURB TYPE B AND COMBINATION CONCRETE CURB & GUTTER
701301-04	LANE CLOSURE, 2L, 2W, SHORT TIME OPERATIONS
701311-03	LANE CLOSURE, 2L, 2W, MOVING OPERATIONS-DAY ONLY
701501-06	URBAN LANE CLOSURE, 2 L, 2 W UNDIVIDED
701701-09	URBAN LANE CLOSURE, MULTILANE INTERSECTION
701901-04	TRAFFIC CONTROL DEVICES
780001-05	TYPICAL PAVEMENT MARKINGS

FILE NAME = VILLAGE OF McCOOK LAWDALE AVENUE JOLIET ROAD TO 47TH STREET RESURFACING	USER NAME =	DESIGNED -- THK	REVISED -- JLC 1/2/15
#10070	PLOT SCALE =	DRAWN -- JFP-JEP	REVISED --
	PLOT DATE =	CHECKED -- JLC	REVISED --
		DATE -- 10/28/14	REVISED --

**STATE OF ILLINOIS
DEPARTMENT OF TRANSPORTATION**

**GENERAL CONSTRUCTION NOTES
INDEX OF HIGHWAY STANDARDS**

SCALE: NONE SHEET NO. OF SHEETS STA. TO STA.

 Frank Novotny & Associates, Inc. <small>859 Midway Drive • Willowbrook, IL • 61097 • Telephone: (630) 887-9640 • Fax: (630) 887-0138 ILLINOIS PROFESSIONAL DESIGN FIRM NO. 184-00028</small>				
F.A.U. RTE.	SECTION	COUNTY	TOTAL SHEETS	SHEET NO.
2792	12-00018-00-RS	COOK	18	2
CONTRACT NO. 61B15				
FED. ROAD DIST. NO.	ILLINOIS FED. AID PROJECT	M-4003(084)		

Specialty Item	Special Provision	Code No	Item	Unit	Total Quantity	Construction Code Roadway 0005
		25200110	SODDING, SALT TOLERANT	SQ YD	90	90
		21101615	TOPSOIL FURNISH AND PLACE, 4"	SQ YD	90	90
	SP	40600275	BITUMINOUS MATERIALS (PRME COAT)	POUND	2381	2381
		40600400	MIXTURE FOR CRACKS, JOINTS, AND FLANGEWAYS	TON	5	5
		40600827	POLYMERIZED LEVELING BINDER (MACHINE METHOD), IL-4.75, N50	TON	304	304
		40600982	HOT-MIX ASPHALT SURFACE REMOVAL - BUTT JOINT	SQ YD	120	120
		40603340	HOT-MIX ASPHALT SURFACE COURSE, MIX "D", N70	TON	462	462
		42300600	PORTLAND CEMENT CONCRETE DRIVEWAY PAVEMENT, 10 INCH	SQ YD	44	44
		44000159	HOT-MIX ASPHALT SURFACE REMOVAL, 2 1/2"	SQ YD	5291	5291
		44000200	DRIVEWAY PAVEMENT REMOVAL	SQ YD	44	44
		44201789	CLASS D PATCHES, TYPE II, 12 INCH	SQ YD	27	27
		44201794	CLASS D PATCHES, TYPE III, 12 INCH	SQ YD	63	63
		44201796	CLASS D PATCHES, TYPE IV, 12 INCH	SQ YD	183	183
		67100100	MOBILIZATION	L SUM	1	1
		70102620	TRAFFIC CONTROL AND PROTECTION, STANDARD 701501	L SUM	1	1
		70102635	TRAFFIC CONTROL AND PROTECTION, STANDARD 701701	L SUM	1	1
		70300100	SHORT TERM PAVEMENT MARKING	FOOT	130	130
*		78000100	THERMOPLASTIC PAVEMENT MARKING - LETTERS AND SYMBOLS	SQ FT	728	728
*		78000200	THERMOPLASTIC PAVEMENT MARKING - LINE 4"	FOOT	1417	1417
*		78000400	THERMOPLASTIC PAVEMENT MARKING - LINE 6"	FOOT	470	470
*		78000650	THERMOPLASTIC PAVEMENT MARKING - LINE 24"	FOOT	129	129
*		78100100	RAISED REFLECTIVE PAVEMENT MARKER	EACH	41	41
*		88600600	DETECTOR LOOP REPLACEMENT	FOOT	579	579
	SP	X6030310	FRAMES AND LIDS TO BE ADJUSTED (SPECIAL)	EACH	4	4
	SP	Z0030850	TEMPORARY INFORMATION SIGNING	SQ FT	60	60
	SP	Z0004562	COMBINATION CONCRETE CURB AND GUTTER REMOVAL AND REPLACEMENT	FOOT	540	540

FILE NAME = VILLAGE OF McCOOK
LAWDALE AVENUE
JOLIET ROAD TO 47TH STREET
RESURFACING

USER NAME =
PLOT SCALE =
PLOT DATE =

DESIGNED -- THK
DRAWN -- JFP-JEP
CHECKED -- JLC
DATE -- 10/28/14

REVISED -- JLC 1/2/15
REVISED --
REVISED --
REVISED --

STATE OF ILLINOIS
DEPARTMENT OF TRANSPORTATION

SUMMARY OF QUANTITIES

SCALE: NONE SHEET NO. OF SHEETS STA. TO STA.

Frank Novotny & Associates, Inc.
505 Midway Drive • Wilmette, IL • 60091 • Telephone: (800) 887-8840 • Fax: (800) 887-0132
Civil Engineers
Municipal Consultants
ILLINOIS PROFESSIONAL DESIGN FIRM NO. 184-00028

F.A.U. RTE.	SECTION	COUNTY	TOTAL SHEETS	SHEET NO.
2792	12-00018-00-RS	COOK	18	3
CONTRACT NO. 61B15				
FED. ROAD DIST. NO. ILLINOIS FED. AID PROJECT M-4003(084)				

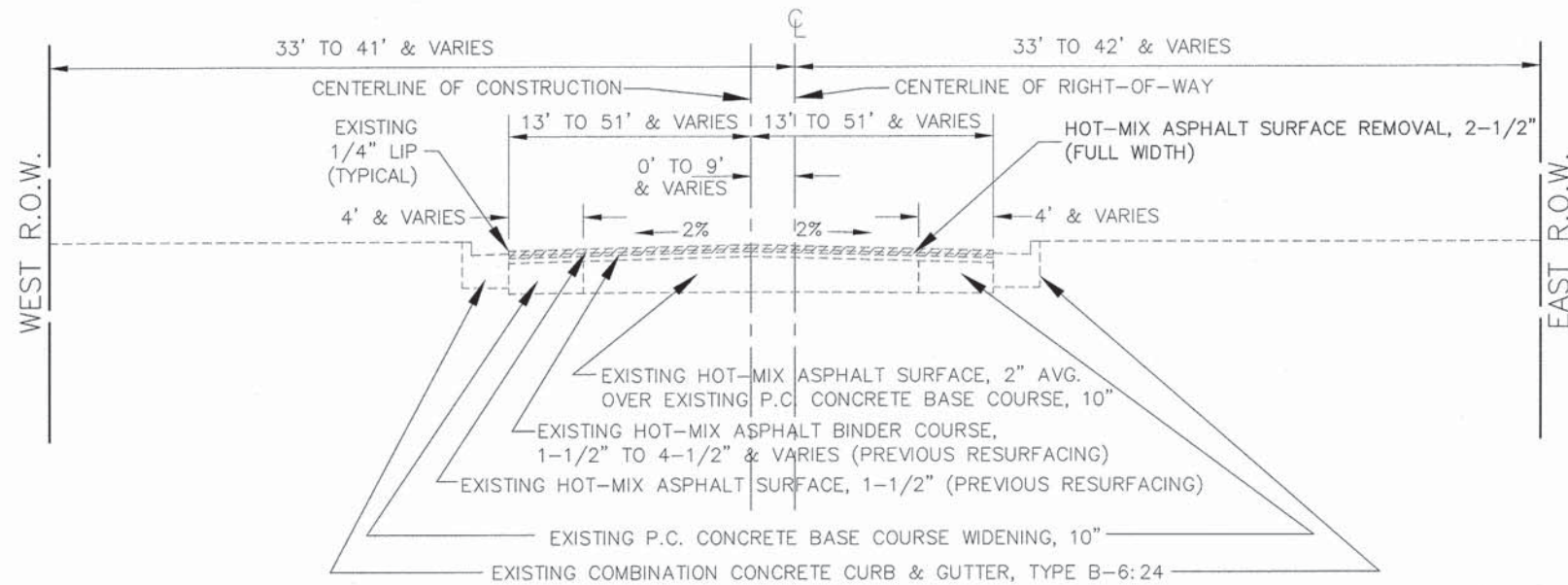

EXISTING TYPICAL SECTION
STA. 27+50 TO STA. 39+89, LAWNDALE AVENUE

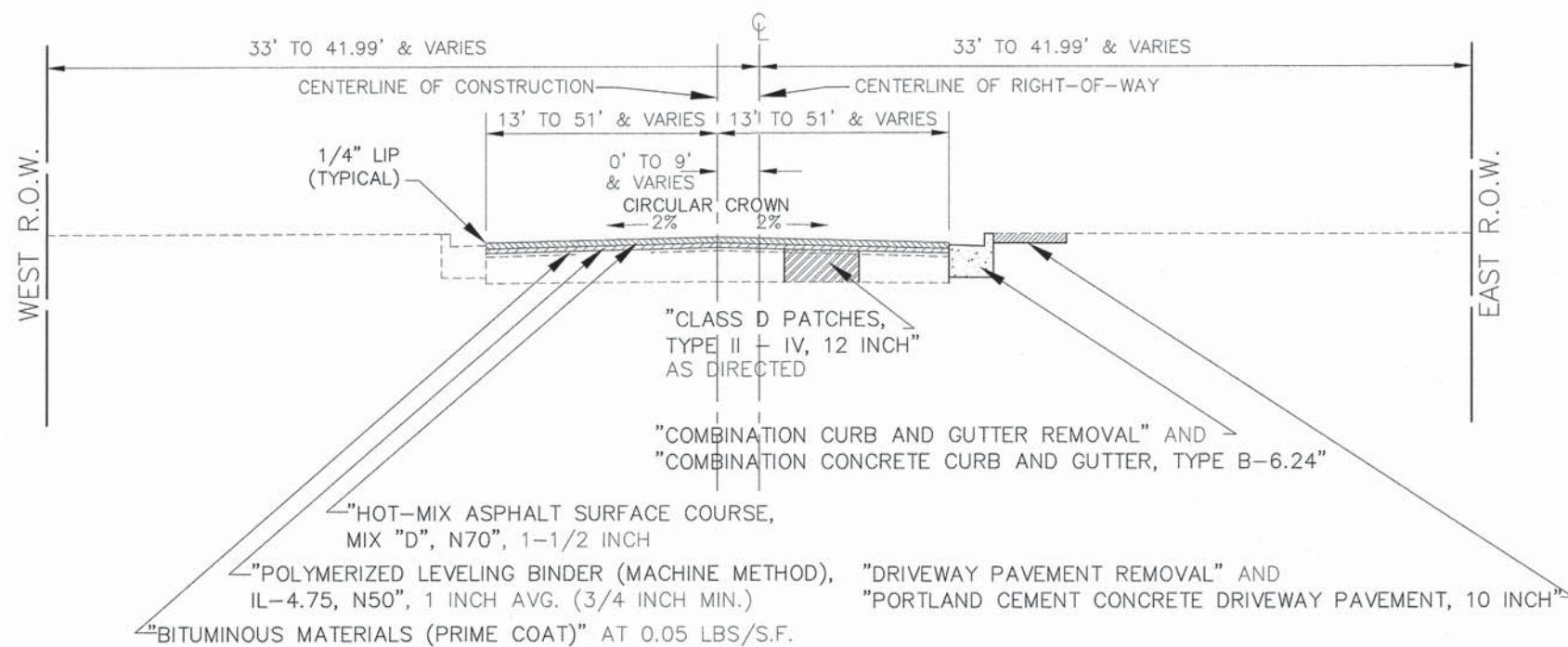

PROPOSED TYPICAL SECTION
STA. 27+50 TO STA. 39+89, LAWNDALE AVENUE

NOTE: CONTRACTOR SHALL MILL BEFORE PATCHING.

HOT-MIX ASPHALT MIXTURE REQUIREMENTS

MIXTURE TYPE	AIR VOIDS @ NDES
ROADWAY	
HOT-MIX ASPHALT SURFACE COURSE, MIX "D", N70, (IL-9.5mm), 1-1/2"	4% @ 50 GYR
POLYMERIZED LEVELING BINDER (MACHINE METHOD), IL-4.75, N50, 1 INCH AVG. (3/4 INCH MIN.)	3.5% @ 50 GYR
PATCHING	
CLASS D PATCHES, TYPE II-IV, 12" (HMA BINDER COURSE, IL-19 mm), 12" (IN 3 LIFTS)	4% @ 70 GYR

THE UNIT WEIGHT TO CALCULATE ALL HOT-MIX ASPHALT SURFACE MIXTURE QUANTITIES IS 112 LBS/SQ YD/IN.
 "THE "AC TYPE" FOR POLYMERIZED HMA MIXES SHALL BE "SBS/SBR PG 76-22" AND FOR NON-POLYMERIZED HMA THE "AC TYPE" SHALL BE "PG 64-22" UNLESS MODIFIED BY DISTRICT ONE SPECIAL PROVISIONS"
 FOR HMA FULL DEPTH "AC TYPE" SEE SPECIAL PROVISIONS
 FOR USE OF RECYCLED MATERIALS SEE SPECIAL PROVISIONS

IMPORTANT!

FULL SIZE PLANS HAVE BEEN PREPARED USING STANDARD ENGINEERING SCALES. REDUCED SIZED PLANS WILL NOT CONFORM TO STANDARD SCALES INDICATED IN TITLE BLOCK.

Frank Novotny & Associates, Inc.
 Civil Engineers
 835 Midway Drive • Willowbrook, IL • 61227 • Telephone: (630) 887-8640 • Fax: (630) 887-0138
 ILLINOIS PROFESSIONAL DESIGN FIRM NO. 184-000208

FILE NAME = VILLAGE OF MCCOOK LAWNDALE AVENUE JOLIET ROAD TO 47TH STREET RESURFACING	USER NAME =	DESIGNED -- THK	REVISED -- JLC 1/2/15
PLOT SCALE =		DRAWN -- JFP-JEP	REVISED --
PLOT DATE =		CHECKED -- JLC	REVISED --
		DATE -- 10/28/14	REVISED --

STATE OF ILLINOIS
DEPARTMENT OF TRANSPORTATION

TYPICAL SECTIONS
HOT-MIX ASPHALT MIXTURE REQUIREMENTS

SCALE: 1"=5' SHEET NO. OF SHEETS STA. TO STA.

F.A.U. RTE.	SECTION	COUNTY	TOTAL SHEETS	SHEET NO.
2792	12-00018-00-RS	COOK	18	4
CONTRACT NO. 61B15				
FED. ROAD DIST. NO. ILLINOIS FED. AID PROJECT M-4003(084)				

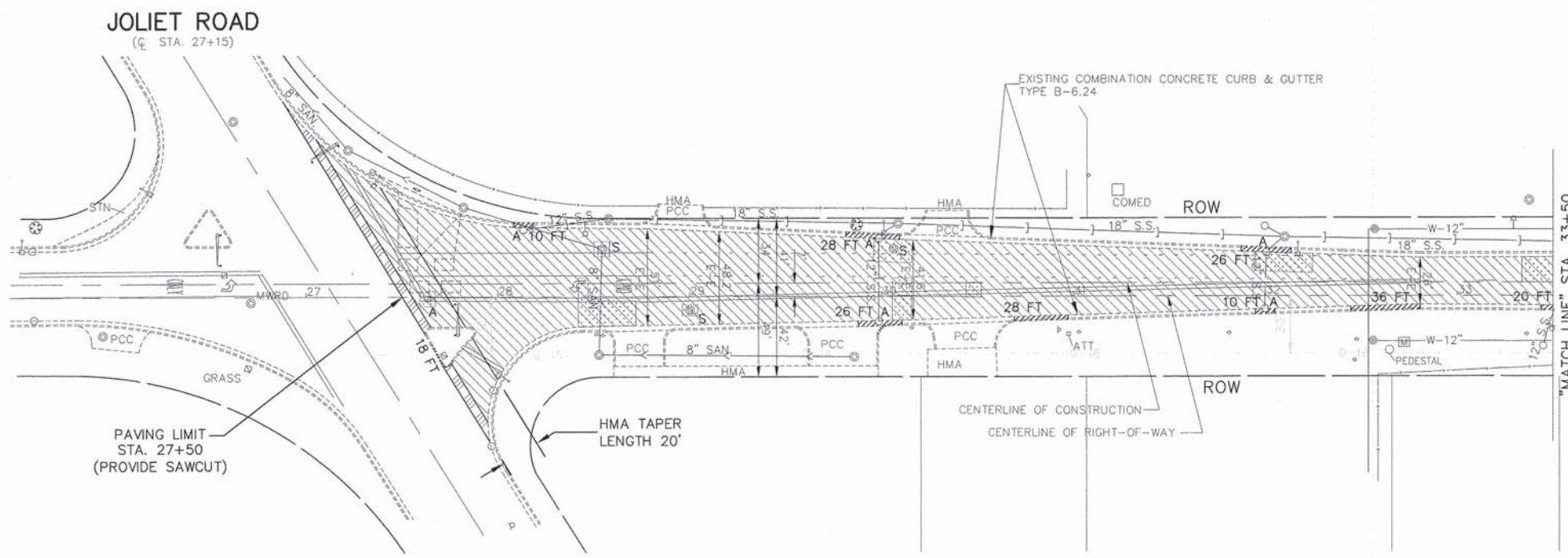

EXISTING

FOR CONTINUATION
SEE SHEET 6

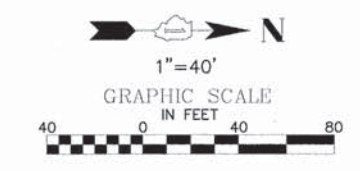

REMOVAL LEGEND

- DENOTES HOT-MIX ASPHALT SURFACE REMOVAL—BUTT JOINT
- DENOTES HOT-MIX ASPHALT SURFACE REMOVAL, 2-1/2 INCH
- DENOTES DRIVEWAY PAVEMENT REMOVAL
- DENOTES CLASS D PATCHES, TYPE II, III & IV, 12 INCH, — AS DIRECTED
- DENOTES COMBINATION CURB AND GUTTER REMOVAL
- "A" DENOTES EXISTING FRAMES AND LIDS TO BE ADJUSTED
- "S" DENOTES EXISTING FRAMES AND LIDS TO BE ADJUSTED (SPECIAL)

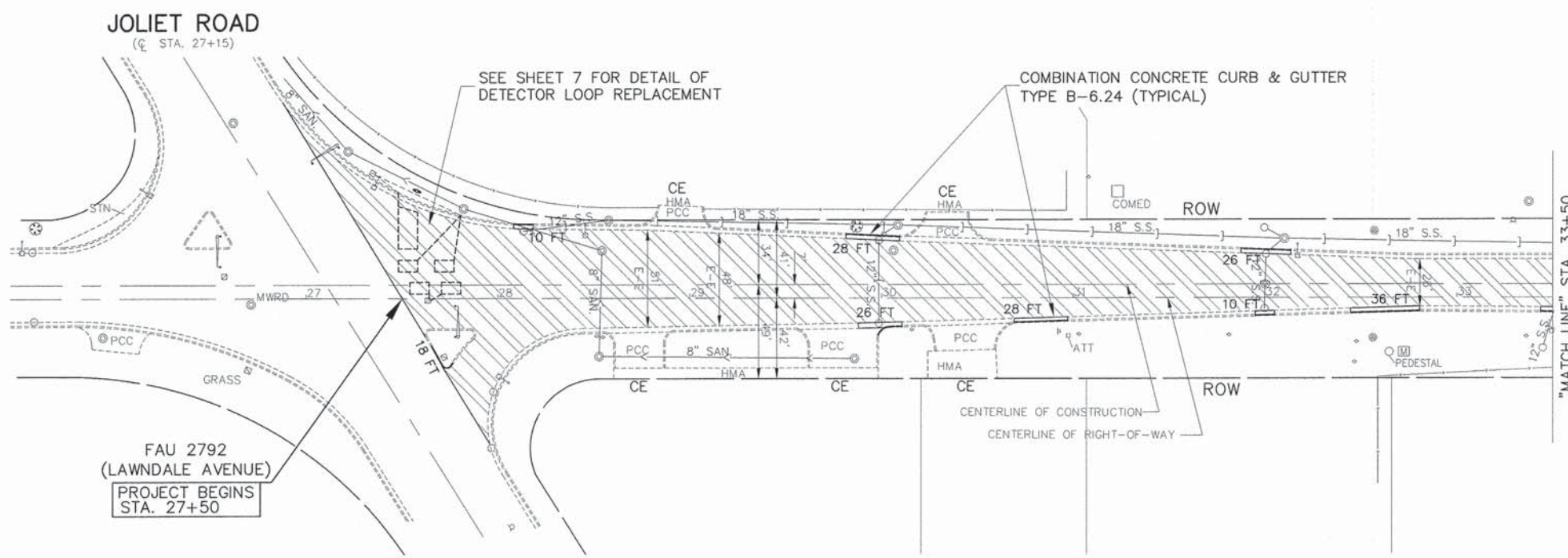

PROPOSED
LAWNDALE AVENUE

PROPOSED PAVEMENT LEGEND

- DENOTES POLYMERIZED LEVELING BINDER (MACHINE METHOD), IL-4.75, N50, 1 INCH AVG. (3/4 INCH MIN.)
- DENOTES PORTLAND CEMENT CONCRETE DRIVEWAY PAVEMENT, 10 INCH
- DENOTES COMBINATION CONCRETE CURB AND GUTTER, TYPE B-6.24
- PE DENOTES PRIVATE ENTRANCE
- CE DENOTES COMMERCIAL ENTRANCE

ALL SAW CUTS SHALL BE CONSIDERED INCLUDED IN THE COST OF THE ITEM BEING REMOVED.

FOR TYPICAL SECTIONS OF NEW PAVEMENT WORK SEE SHEET 4

IMPORTANT!
FULL SIZE PLANS HAVE BEEN PREPARED USING STANDARD ENGINEERING SCALES. REDUCED SIZED PLANS WILL NOT CONFORM TO STANDARD SCALES INDICATED IN TITLE BLOCK.

FILE NAME VILLAGE OF MCCOOK
LAWNDALE AVENUE
JOLIET ROAD TO 47TH STREET
RESURFACING

USER NAME =
PLOT SCALE =
PLOT DATE =

DESIGNED — JLC
DRAWN — JEP—JFP
CHECKED — JLC
DATE — 10/28/14

REVISED — JLC 1/2/15
REVISED —
REVISED —
REVISED —

STATE OF ILLINOIS
DEPARTMENT OF TRANSPORTATION

PLAN & PROFILE: FAU 2792 (LAWNDALE AVENUE) -
FAU 3562 (JOLIET ROAD) TO FAU 1488 (47TH STREET)
(RESURFACING)
SCALE: 1"=40' SHEET NO. OF SHEETS STA. 27+50 TO STA. 33+50

Frank Novotny & Associates, Inc.
Civil Engineer
855 Midway Drive • Willowbrook, IL • 60127 • Telephone: (630) 887-9640 • Fax: (630) 887-0132
ILLINOIS PROFESSIONAL DESIGN FIRM NO. 184-000828

F.A.U. RTE.	SECTION	COUNTY	TOTAL SHEETS	SHEET NO.
2792	12-00018-00-RS	COOK	18	5
CONTRACT NO. 61B15				
FED. ROAD DIST. NO.		ILLINOIS FED. AID PROJECT M-4003(084)		

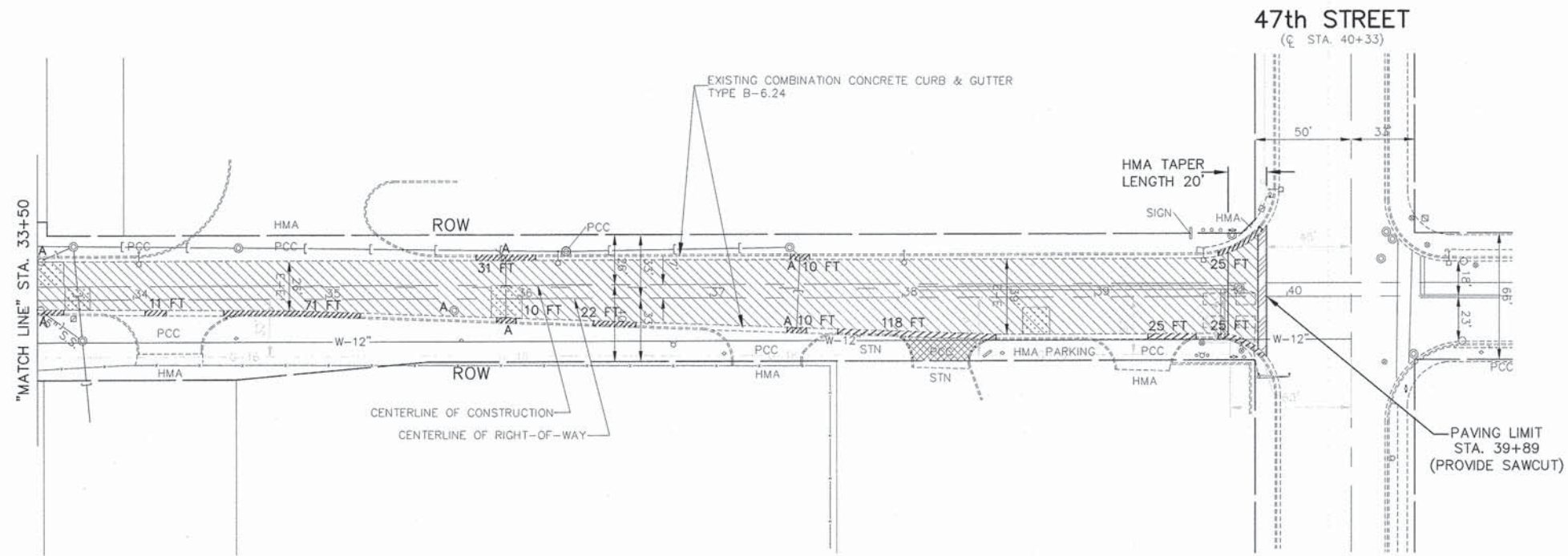
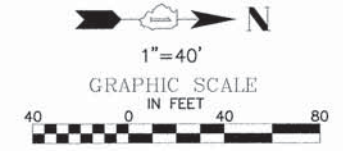

FOR CONTINUATION
SEE SHEET 5

EXISTING

- REMOVAL LEGEND**
- DENOTES HOT-MIX ASPHALT SURFACE REMOVAL-BUTT JOINT
 - DENOTES HOT-MIX ASPHALT SURFACE REMOVAL, 2-1/2 INCH
 - DENOTES DRIVEWAY PAVEMENT REMOVAL
 - DENOTES CLASS D PATCHES, TYPE II, III & IV, 12 INCH. - AS DIRECTED
 - DENOTES COMBINATION CURB AND GUTTER REMOVAL
 - "A" DENOTES EXISTING FRAMES AND LIDS TO BE ADJUSTED
 - "S" DENOTES EXISTING FRAMES AND LIDS TO BE ADJUSTED (SPECIAL)

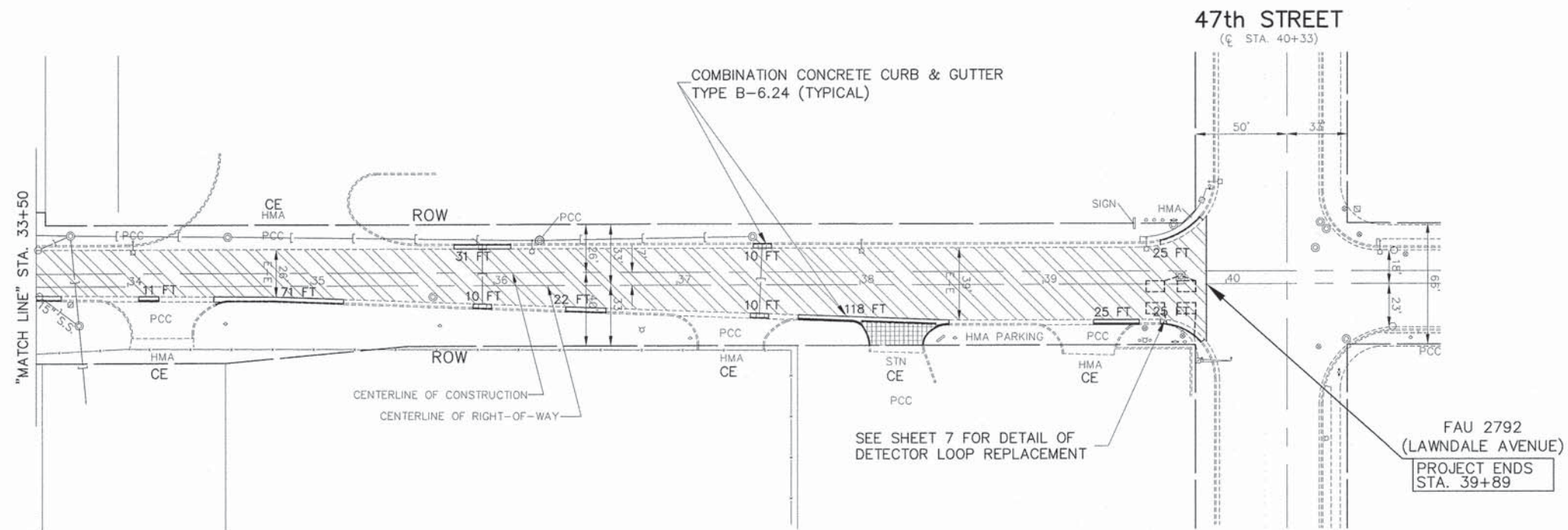

PROPOSED
LAWNDALE AVENUE

- PROPOSED PAVEMENT LEGEND**
- DENOTES POLYMERIZED LEVELING BINDER (MACHINE METHOD), IL-4.75, N50, 1 INCH AVG. (3/4 INCH MIN.)
 - DENOTES HOT-MIX ASPHALT SURFACE COURSE, MIX "D", N70, 1-1/2 INCH
 - DENOTES PORTLAND CEMENT CONCRETE DRIVEWAY PAVEMENT, 10 INCH
 - DENOTES COMBINATION CONCRETE CURB AND GUTTER, TYPE B-6.24
 - PE DENOTES PRIVATE ENTRANCE
 - CE DENOTES COMMERCIAL ENTRANCE

ALL SAW CUTS SHALL BE CONSIDERED INCLUDED IN THE COST OF THE ITEM BEING REMOVED.

FOR TYPICAL SECTIONS OF NEW PAVEMENT WORK SEE SHEET 4

IMPORTANT!
FULL SIZE PLANS HAVE BEEN PREPARED USING STANDARD ENGINEERING SCALES. REDUCED SIZED PLANS WILL NOT CONFORM TO STANDARD SCALES INDICATED IN TITLE BLOCK.

Frank Novotny & Associates, Inc.
Civil Engineers
805 Midway Drive • Willmetts, IL • 61227 • Telephone (815) 887-8840 • Fax (815) 887-0178
ILLINOIS PROFESSIONAL DESIGN FIRM NO. 184-000808

FILE NAME VILLAGE OF MCCOOK
LAWNDALE AVENUE
JOLIET ROAD TO 47TH STREET
RESURFACING

USER NAME =
PLOT SCALE =
PLOT DATE =

DESIGNED -- JLC
DRAWN -- JEP-JFP
CHECKED -- JLC
DATE -- 10/28/14

REVISED -- JLC 1/2/15
REVISED --
REVISED --
REVISED --

STATE OF ILLINOIS
DEPARTMENT OF TRANSPORTATION

PLAN & PROFILE: FAU 2792 (LAWNDALE AVENUE) -
FAU 3562 (JOLIET ROAD) TO FAU 1488 (47TH STREET)
(RESURFACING)

SCALE: 1"=40' SHEET NO. OF SHEETS STA. 33+50 TO STA. 39+89

F.A.U. RTE.	SECTION	COUNTY	TOTAL SHEETS	SHEET NO.
2792	12-00018-00-RS	COOK	18	6
CONTRACT NO. 61B15				
FED. ROAD DIST. NO.		ILLINOIS FED. AID PROJECT		M-4003(084)

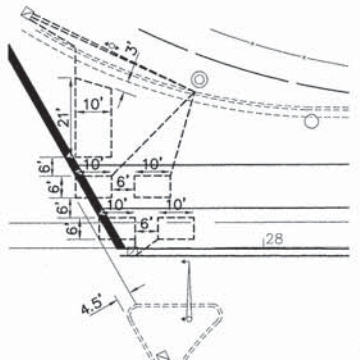

JOLIET ROAD
(C STA. 27+15)

EXISTING TRAFFIC CONTROL DETECTOR LOOPS - TO BE REPLACED AND INSTALLED IN LEVELING BINDER COURSE PRIOR TO HOT-MIX ASPHALT SURFACE COURSE INSTALLATION. SEE ABOVE LEFT FOR LOCATION DETAIL.

DETECTOR LOOP INSTALLATION AT JOLIET ROAD

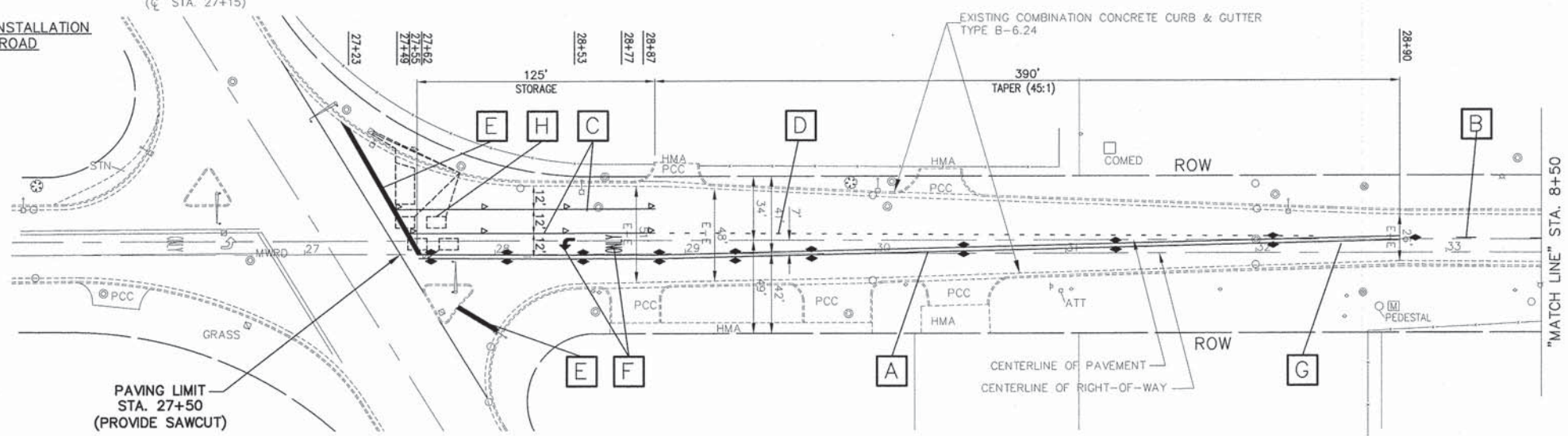

PAVING LIMIT STA. 27+50 (PROVIDE SAWCUT)

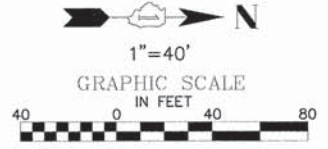

THERMOPLASTIC PAVEMENT MARKING CODE

- [A] CENTERLINE - SOLID DOUBLE YELLOW PREFORMED PLASTIC PAVEMENT MARKING - LINE 4", 11" O/C
- [B] LANE LINE - DASHED WHITE THERMOPLASTIC PAVEMENT MARKING - LINE 4", 10' DASH, 30' SKIP
- [C] TURN AND LANE LINE - SOLID WHITE THERMOPLASTIC PAVEMENT MARKING - LINE 6"
- [D] TURN LANE TAPER LINE - DASHED WHITE THERMOPLASTIC PAVEMENT MARKING - LINE 6", 2' DASH, 6' SKIP
- [E] STOP BAR - SOLID WHITE THERMOPLASTIC PAVEMENT MARKING - LINE 24"
- [F] LETTERS AND SYMBOLS - SOLID WHITE THERMOPLASTIC PAVEMENT MARKING

REFLECTIVE PAVEMENT MARKERS

- [G] RECESSED REFLECTIVE PAVEMENT MARKERS - 80' O/C OR AS SHOWN
 - ◆ TWO-WAY AMBER MARKER
 - ▼ ONE-WAY AMBER MARKER
 - ▽ ONE-WAY CRYSTAL MARKER
 - ◇ TWO-WAY BLUE MARKER

NOTE: SHORT-TERM PAVEMENT MARKING IS PROPOSED ON THE MILLED PAVEMENT, NEW BINDER AND ON THE NEW SURFACE. SEE ARTICLE 703.04 OF THE LATEST EDITION OF THE "STANDARD SPECIFICATIONS FOR ROAD AND BRIDGE CONSTRUCTION".
NOTE: ALL "ARROWS" AND "ONLYS" SHALL BE 8" IN HEIGHT.
NOTE: PROPOSED CENTERLINE - DOUBLE SOLID YELLOW THERMOPLASTIC PAVEMENT MARKING - 4", 11" O/C (NOTE: [A]) IS MEASURED PER LINE. TOTAL QUANTITY AND PAYMENT LENGTH IS FOR EACH LINEAR FOOT OF SINGLE 4" STRIPE INSTALLED.

DETECTOR LOOPS

- [H] PROPOSED DETECTOR LOOP REPLACEMENT

NOTE: PROPOSED PAVEMENT MARKING THAT IS BEING REPLACED IS IN THE SAME LOCATION.

DETECTOR LOOP SCHEDULE OF QUANTITIES

CODE	QUANTITY	UNIT	ITEM
88600600	579	FOOT	DETECTOR LOOP REPLACEMENT

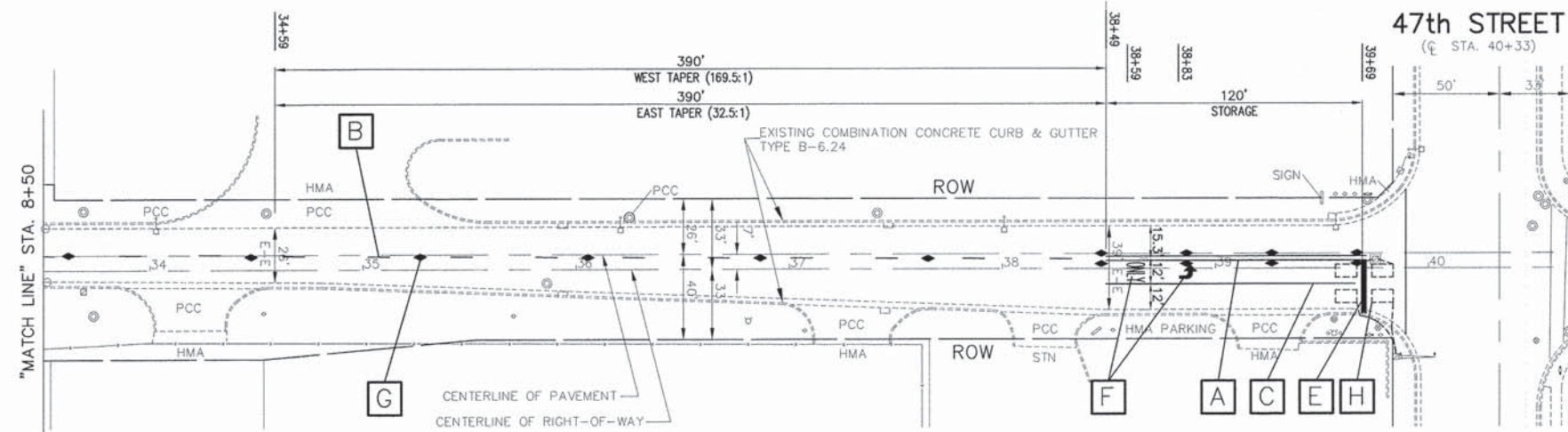

47th STREET
(C STA. 40+33)

EXISTING TRAFFIC CONTROL DETECTOR LOOPS - TO BE REPLACED AND INSTALLED IN LEVELING BINDER COURSE PRIOR TO HOT-MIX ASPHALT SURFACE COURSE INSTALLATION. SEE BELOW RIGHT FOR LOCATION DETAIL.

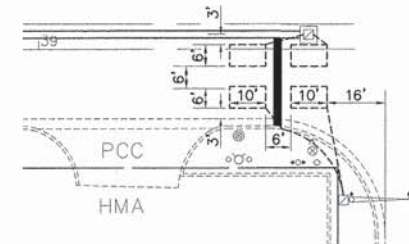

DETECTOR LOOP INSTALLATION AT 47TH STREET

LAWNDALE AVENUE

FOR PAVEMENT MARKING DETAILS SEE SHEET 14 FOR DISTRICT DETAIL TC-13

IMPORTANT!
FULL SIZE PLANS HAVE BEEN PREPARED USING STANDARD ENGINEERING SCALES. REDUCED SIZED PLANS WILL NOT CONFORM TO STANDARD SCALES INDICATED IN TITLE BLOCK.

Frank Novotny & Associates, Inc.
Civil Engineers
835 Midway Drive • Wilmette, IL • 60577 • Telephone (830) 887-8840 • Fax (830) 887-0139
ILLINOIS PROFESSIONAL DESIGN FIRM NO. 184-000828

FILE NAME	VILLAGE OF McCOOK LAWNDALE AVENUE JOLIET ROAD TO 47TH STREET RESURFACING	USER NAME =	DESIGNED - JLC	REVISED - JLC 1/2/15
			DRAWN - JEP-JFP	REVISED -
			CHECKED - JLC	REVISED -
			DATE - 10/28/14	REVISED -

STATE OF ILLINOIS
DEPARTMENT OF TRANSPORTATION

PLAN & PROFILE: FAU 2792 (LAWNDALE AVENUE) -
FAU 3562 (JOLIET ROAD) TO FAU 1488 (47TH STREET)
(PAVEMENT MARKING)

SCALE: 1" = 40' SHEET NO. OF SHEETS STA. 27+50 TO STA. 39+69

F.A.U. RTE.	SECTION	COUNTY	TOTAL SHEETS	SHEET NO.
2792	12-00018-00-RS	COOK	18	7
CONTRACT NO. 61B15				
FED. ROAD DIST. NO.	ILLINOIS FED. AID PROJECT	M-4003(084)		

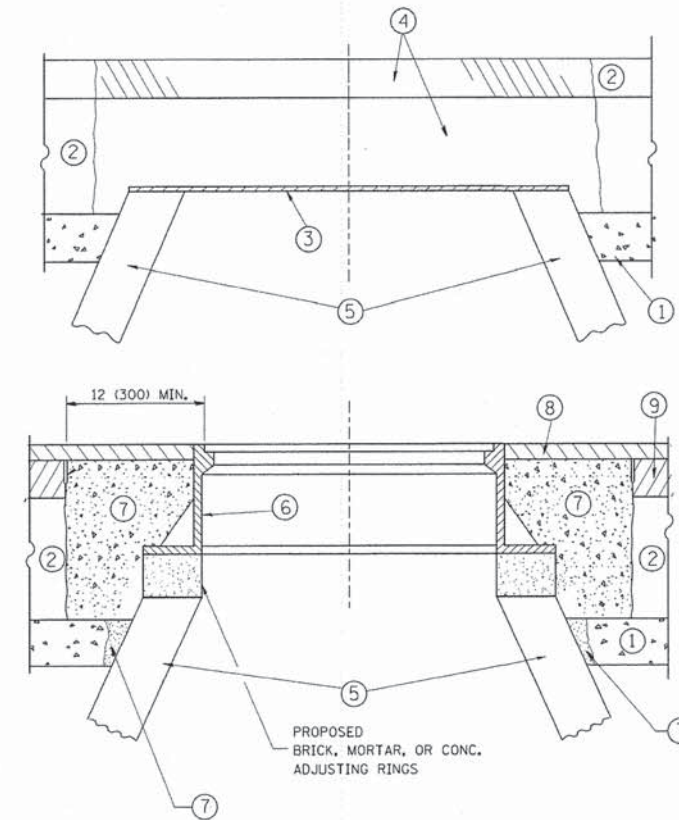

CONSTRUCTION PROCEDURES

STAGE 1 (BEFORE PAVEMENT MILLING)

- A) REMOVE A MINIMUM OF 12 (300) OF THE PAVEMENT FROM AROUND THE STRUCTURE.
- B) REMOVE THE EXISTING FRAME AND LID FROM THE STRUCTURE.
- C) COVER THE STRUCTURE OPENING WITH A 36 (900) DIAMETER METAL PLATE.
- D) BACKFILL WITH CRUSHED STONE AND A MINIMUM 1/2 (40) THICK HMA SURFACE MIX APPROVED BY THE ENGINEER.

STAGE 2 (AFTER PAVEMENT MILLING)

- A) REMOVE THE HMA SURFACE MIX AND CRUSHED STONE.
- B) INSTALL THE FRAME AND LID; ADJUST THE FRAME TO ITS FINAL SURFACE ELEVATION.
- C) THE SURROUNDING SPACE SHALL BE FILLED WITH CLASS PP-1* CONCRETE TO THE ELEVATION OF THE SURFACE OF THE EXISTING BASE COURSE OR THE BINDER COURSE.

* UNLESS OTHERWISE SPECIFIED IN THE PLANS.

THE PROCEDURE EXPLAINED ABOVE SHALL CONFORM TO THE APPLICABLE PORTIONS OF SECTIONS 353, 406, 602, AND 603 OF THE STANDARD SPECIFICATIONS EXCEPT THAT "THE CONTRACTOR SHALL ADJUST THE STRUCTURES TO THE FINISHED PAVEMENT ELEVATION NO MORE THAN 5 CALENDAR DAYS PRIOR TO PLACEMENT OF THE FINAL LIFT OF SURFACE UNLESS APPROVED BY THE ENGINEER."

LEGEND

- ① SUB-BASE GRANULAR MATERIAL
- ② EXISTING PAVEMENT
- ③ 36 (900) DIAMETER METAL PLATE
- ④ PROPOSED CRUSHED STONE AND HMA SURFACE MIX
- ⑤ EXISTING STRUCTURE
- ⑥ FRAME AND LID (SEE NOTES)
- ⑦ CLASS PP-1* CONCRETE
- ⑧ PROPOSED HMA SURFACE COURSE
- ⑨ PROPOSED HMA BINDER COURSE

LOCATION OF STRUCTURES:

THE CONTRACTOR WILL BE REQUIRED TO KEEP A RECORD OF THE LOCATIONS OF THE BURIED STRUCTURES ACCORDING TO THE STATION AND DISTANCE LEFT OR RIGHT OF THE CENTERLINE OF PAVEMENT. UPON COMPLETION OF THE WORK, THE CONTRACTOR WILL DELIVER THE RECORD TO THE ENGINEER.

BASIS OF PAYMENT:

REMOVING FRAMES AND LIDS ON DRAINAGE AND UTILITY STRUCTURES IN THE PAVEMENT PRIOR TO MILLING, AND ADJUSTING TO FINAL GRADE PRIOR TO PLACING THE SURFACE COURSE, WILL BE PAID FOR AT THE CONTRACT UNIT PRICE EACH FOR "FRAMES AND LIDS TO BE ADJUSTED (SPECIAL)."

THIS WORK WILL NOT BE PAID FOR WHEN DRAINAGE AND UTILITY STRUCTURES ARE SPECIFIED FOR PAYMENT AS STRUCTURE RECONSTRUCTION.

NEW FRAMES AND LIDS, WHEN SPECIFIED, WILL BE PAID FOR SEPARATELY.

NOTES:

EXISTING BROKEN FRAMES AND LIDS SHALL BE REMOVED AND DISPOSED OF BY THE CONTRACTOR AND SHALL BE REPLACED AS DIRECTED BY THE ENGINEER. REPLACEMENT FRAMES AND LIDS WILL BE PAID FOR IN ACCORDANCE WITH ARTICLE 109.04 OF THE STANDARD SPECIFICATIONS UNLESS A SEPARATE PAY ITEM HAS BEEN PROVIDED.

IF THE EXISTING LIDS ARE OPEN, THE FRAME WILL BE ADJUSTED TO THE ELEVATION OF THE MILLED PAVEMENT SURFACE PRIOR TO THE MILLING OPERATION. THE FRAME WILL NOT BE REMOVED AND COVERED BY THE METAL PLATE.

CITY OF CHICAGO CASTINGS ARE THE PROPERTY OF THE CITY AND THE CONTRACTOR SHALL NOTIFY THE CITY FOR REMOVAL AND DISPOSITION OF THE CASTINGS.

THE METAL PLATE USED TO COVER THE STRUCTURE SHALL REMAIN THE PROPERTY OF THE CONTRACTOR.

WHEN STRUCTURES ARE TO BE ADJUSTED OR RECONSTRUCTED, THE LOWERING AND RAISING OF THE FRAMES AND LIDS WILL NOT BE PAID FOR SEPARATELY BUT WILL BE INCLUDED IN THE COST OF THE CORRESPONDING PAY ITEM.

DETAILS FOR FRAMES AND LIDS ADJUSTMENT WITH MILLING

ALL DIMENSIONS ARE IN INCHES (MILLIMETERS) UNLESS OTHERWISE SHOWN

FILE NAME =	USER NAME = bawerd1	DESIGNED - R. SHAH	REVISED - R. WIEDEMAN 05-14-04
ct:\pw_work\pw\dot\bawerd1\0108315\bd08.dgn		DRAWN -	REVISED - R. BORO 01-01-07
		CHECKED -	REVISED - R. BORO 03-09-11
		DATE - 10-25-94	REVISED - R. BORO 12-06-11

**STATE OF ILLINOIS
DEPARTMENT OF TRANSPORTATION**

**DETAILS FOR
FRAMES AND LIDS ADJUSTMENT WITH MILLING**

SCALE: NONE SHEET NO. 1 OF 1 SHEETS STA. TO STA.

F.A.U. RTE.	SECTION	COUNTY	TOTAL SHEETS	SHEET NO.
2792	12-00018-00-RS	COOK	18	8
BD600-03 (BD-8)			CONTRACT NO. 61B15	
FED. ROAD DIST. NO. 1		ILLINOIS FED. AID PROJECT	M-4003(084)	

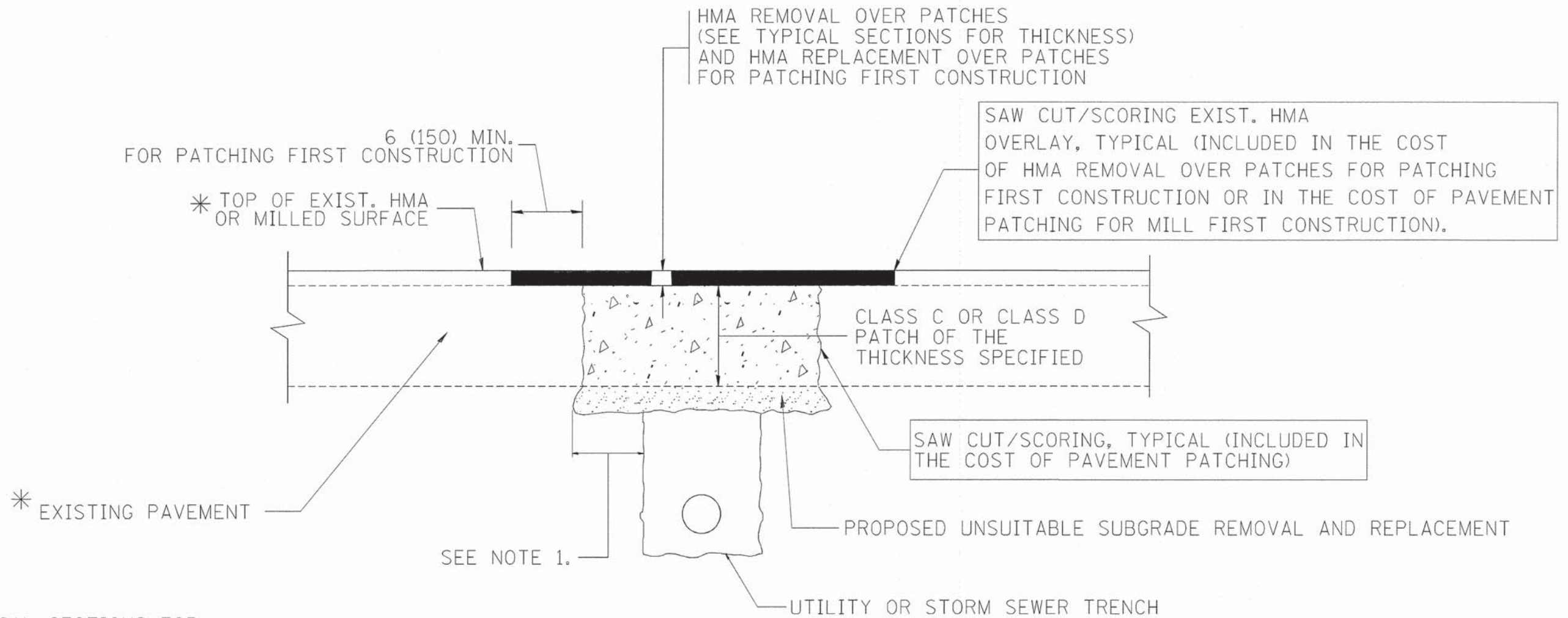

* SEE TYPICAL SECTIONS FOR THICKNESS AND MATERIALS

NOTES:

1. THE WIDTH OF THE FULL DEPTH PATCH OVER A TRENCH SHALL BE 12 (300) WIDER ON EACH SIDE OF THE TRENCH.
2. FOR METHOD OF MEASUREMENT AND BASIS OF PAYMENT, SEE RECURRING SPECIAL PROVISION "PATCHING WITH HOT-MIX ASPHALT OVERLAY REMOVAL".

SEQUENCE OF CONSTRUCTION (PATCHING FIRST)

1. REMOVE THE EXISTING HMA MATERIAL OVER THE AREA TO BE PATCHED.
2. REMOVE AND REPLACE WITH CLASS C OR D PATCH.
3. REPLACE HMA MATERIAL OVER THE AREA TO BE PATCHED.

SEQUENCE OF CONSTRUCTION (MILLING FIRST)

1. MILL HMA FIRST IF THERE IS AT LEAST 4 1/2 INCHES OR MORE OF HMA MATERIAL ON TOP OF THE EXISTING PAVEMENT OR IF THE PAVEMENT IS FULL DEPTH HMA. A MINIMUM OF 2 INCHES OF HMA MATERIAL SHALL BE IN PLACE AFTER MILLING.
2. REMOVE AND REPLACE WITH FULL DEPTH CLASS D PATCHES TO TOP OF MILLED SURFACE.

ALL DIMENSIONS ARE IN INCHES (MILLIMETERS) UNLESS OTHERWISE SHOWN.

FILE NAME = c:\projects\distst022x34\bd22.dgn	USER NAME = bouerd1	DESIGNED - R. SHAH	REVISED - A. ABBAS 04-27-98	STATE OF ILLINOIS DEPARTMENT OF TRANSPORTATION	PAVEMENT PATCHING FOR HMA SURFACED PAVEMENT	F.A.U. RTE.	SECTION	COUNTY	TOTAL SHEETS	SHEET NO.
	PLOT SCALE = 50.000' / IN.	CHECKED -	REVISED - R. BORO 01-01-07			2792	12-00018-00-RS	COOK	18	9
PLOT DATE = 10/27/2008	DATE = 10-25-94	REVISED - K. ENG 10-27-08		SCALE: NONE	SHEET NO. 1 OF 1 SHEETS	STA.	TO STA.	FED. ROAD DIST. NO. 1 ILLINOIS FED. AID PROJECT M-4003(084)		

VARIABLE - TO MEET EXISTING DIMENSIONS AND FIELD CONDITIONS (SEE NOTE ②)

PROP. CONC. CURB OR CURB AND GUTTER REPLACEMENT IN ACCORDANCE WITH STATE STANDARD 606001. (SEE NOTE ②)

SAW CUT FULL DEPTH - INCLUDED IN THE COST OF SIDEWALK, DRIVEWAY OR MEDIAN SURFACE REMOVAL PAY ITEM.

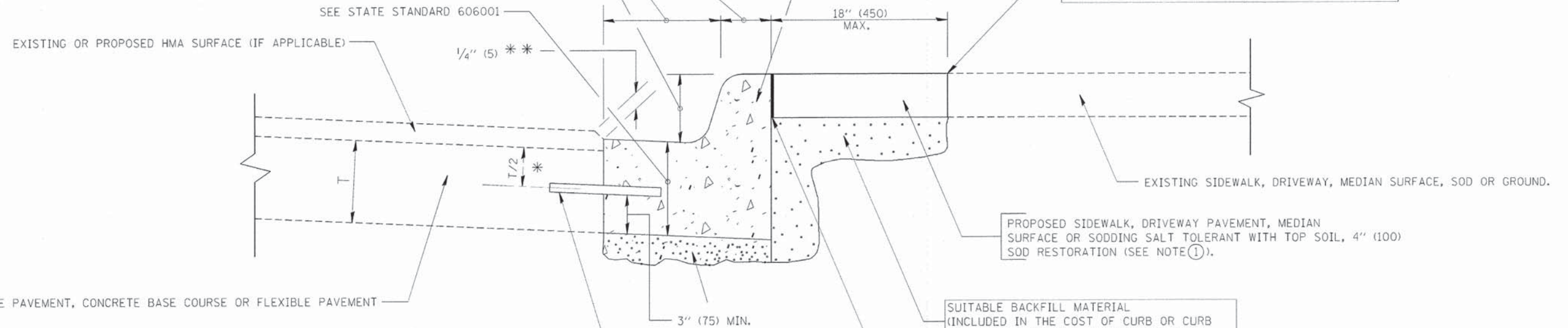

* 3" (75) MINIMUM FROM TOP AND BOTTOM OF THE CONCRETE PAVEMENT OR BASE COURSE.

** IF THE FINAL SURFACE OF THE PAVEMENT IS CONCRETE, THE GUTTER IS TO BE FLUSH WITH THE PAVEMENT.

NOTE: ① SIDEWALK, DRIVEWAY PAVEMENT OR MEDIAN SURFACE SHALL BE SIMILAR TO THE MATERIAL BEING REMOVED AND WILL BE PAID FOR SEPARATELY.

SODDING, SALT TOLERANT AND TOP SOIL, FURNISH AND PLACE 4" WILL BE PAID FOR SEPARATELY.

② FERTILIZER FOR THE PLACEMENT OF THE SOD IS NOT REQUIRED

③ CURB OR CURB AND GUTTER REPLACEMENT SHALL MATCH THE SHAPE OF THE EXISTING CURB OR CURB AND GUTTER UNLESS OTHERWISE SPECIFIED.

④ FOR CURB OR CURB AND GUTTER REMOVAL AND REPLACEMENT ADJACENT TO FLEXIBLE PAVEMENT DELETE EPOXY COATED TIE BARS.

⑤ LONGITUDINAL BARS, IF ENCOUNTERED IN THE EXISTING CURB OR CURB AND GUTTER, ARE NOT TO BE REPLACED. CUTTING AND REMOVING LONGITUDINAL BARS SHALL BE INCLUDED IN THE COST OF CURB OR CURB AND GUTTER REMOVAL AND REPLACEMENT.

⑥ THE COST OF HMA SURFACE REMOVAL IN THE EXISTING GUTTER FLAG SHALL BE INCLUDED IN THE COST OF THE CURB AND GUTTER REMOVAL AND REPLACEMENT.

⑦ THE REMOVAL AND REPLACEMENT OF THE EXISTING CURB OR CURB AND GUTTER SHALL BE DONE IN ACCORDANCE WITH THE APPLICABLE PORTIONS OF SECTION 440 AND 606 OF THE STANDARD SPECIFICATIONS.

⑧ THE LOCATIONS OF REMOVAL AND REPLACEMENT OF EXISTING CURB OR CURB AND GUTTER SHALL BE DETERMINED BY THE RESIDENT ENGINEER AT THE TIME OF CONSTRUCTION.

SUITABLE BACKFILL MATERIAL (INCLUDED IN THE COST OF CURB OR CURB AND GUTTER REMOVAL AND REPLACEMENT)

PROPOSED 3/4" (20) PREFORMED EXPANSION JOINT AT CONCRETE SIDEWALKS, DRIVEWAYS, AND MEDIANS. (INCLUDED IN THE COST OF CURB OR CURB AND GUTTER REMOVAL AND REPLACEMENT.)

UNSUITABLE SUB-BASE MATERIAL TO BE REMOVED, IF DIRECTED BY THE ENGINEER, SHALL BE REPLACED WITH EITHER SUB-BASE GRANULAR MATERIAL, TYPE B OR ADDITIONAL THICKNESS OF CONCRETE.

REMOVAL AND REPLACEMENT 4" (100) OR LESS IS INCLUDED IN THE COST OF CURB OR CURB AND GUTTER REMOVAL AND REPLACEMENT.

REMOVAL AND REPLACEMENT IN EXCESS OF 4" (100) WILL BE PAID FOR IN ACCORDANCE WITH ARTICLE 109.04 OF THE STANDARD SPECIFICATIONS.

PROPOSED #6 (20) EPOXY COATED TIE BARS 24" (600) LONG AT 24" (600) CENTERS WILL NOT BE PAID FOR SEPARATELY. DELETE EPOXY COATED TIE BARS IF EXISTING TIE BARS ARE USABLE AS DETERMINED BY THE ENGINEER. (SEE NOTE ③).

BASIS OF PAYMENT:

THIS WORK WILL BE PAID FOR AT THE CONTRACT UNIT PRICE PER FOOT (METER) FOR "CURB REMOVAL AND REPLACEMENT" OR "COMBINATION CONCRETE CURB AND GUTTER REMOVAL AND REPLACEMENT".

CURB OR CURB AND GUTTER REMOVAL AND REPLACEMENT

ALL DIMENSIONS ARE IN INCHES (MILLIMETERS) UNLESS OTHERWISE SHOWN.

FILE NAME =	USER NAME = drvakosgn	DESIGNED - A. HOUSEH	REVISED - R. SHAH 10-03-96	STATE OF ILLINOIS DEPARTMENT OF TRANSPORTATION	CURB OR CURB AND GUTTER REMOVAL AND REPLACEMENT			F.A.U. RTE. 2792	SECTION 12-00018-00-RS	COUNTY COOK	TOTAL SHEETS 18	SHEET NO. 10
ei:\pwork\pwork\drvakosgn\d9100315\h04.dgn		DRAWN -	REVISED - A. ABBAS 03-21-97		SCALE: NONE	SHEET NO. 1 OF 1 SHEETS	STA. TO STA.	BD600-06 (BD-24)		CONTRACT NO. 61B15		
		PLOT SCALE = 50.0000' / IN.	CHECKED -		REVISED - M. GOMEZ 01-22-01	FED. ROAD DIST. NO. 1 ILLINOIS FED. AID PROJECT M-4003(084)						
		PLOT DATE = 12/15/2009	DATE - 03-11-94		REVISED - R. BORO 12-15-09							

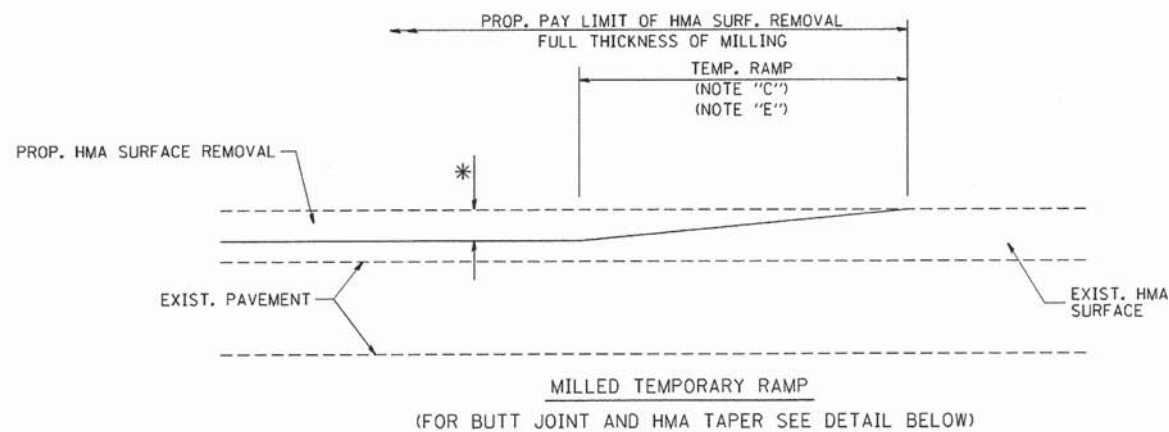

OPTION 1

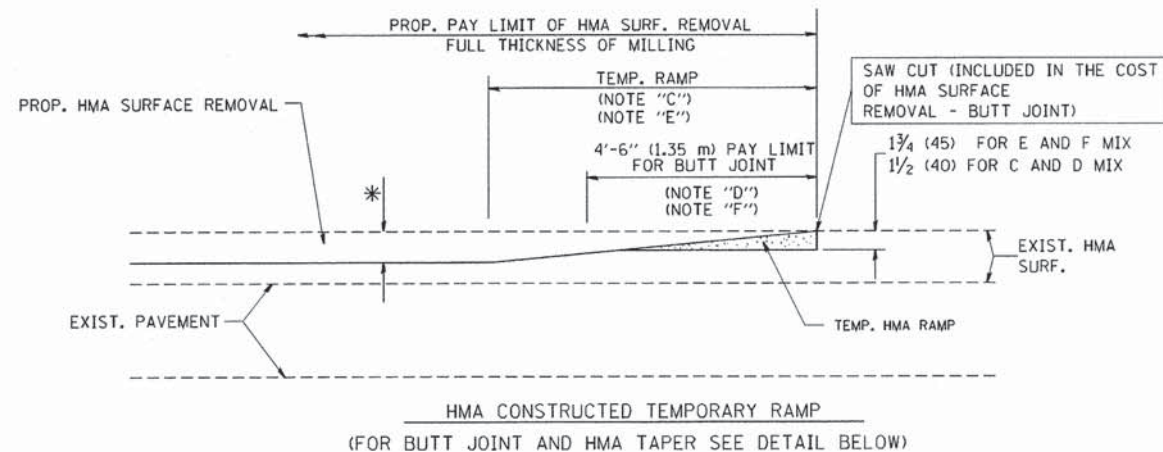

OPTION 2

TYPICAL TEMPORARY RAMP

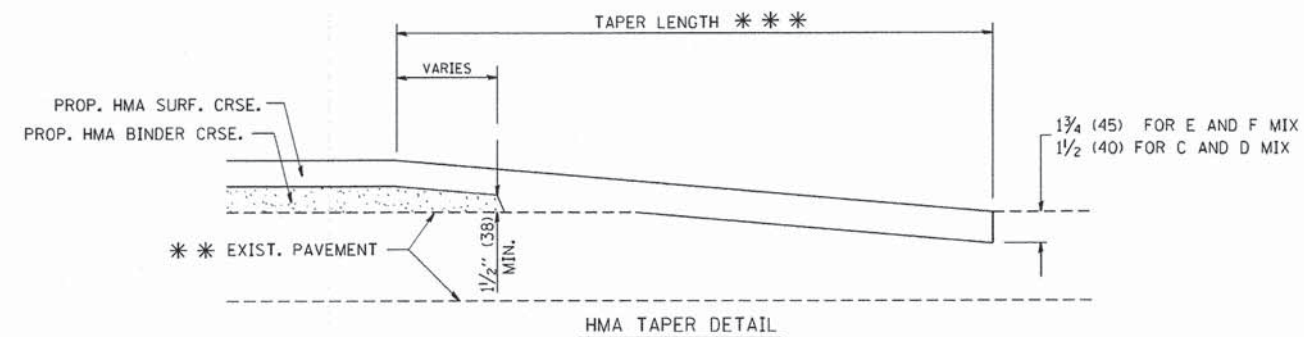
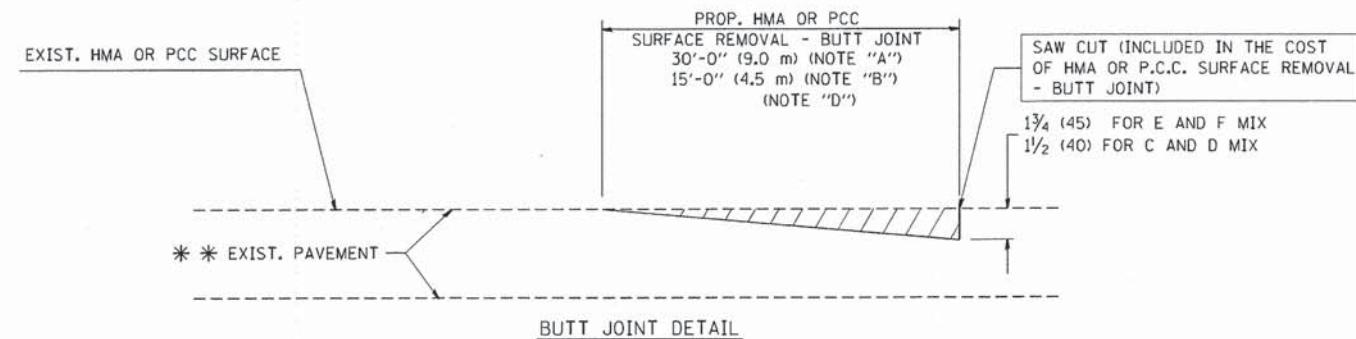

TYPICAL BUTT JOINT AND HMA TAPER FOR RESURFACING ONLY

*** PC CONCRETE, HMA OR HMA RESURFACED PAVEMENT.

NOTES

- A: MAINLINE ROADWAYS AND MAJOR SIDE ROADS.
- B: MINOR SIDE ROADS.
- C: THE TEMP. RAMP SHALL BE CONSTRUCTED IMMEDIATELY UPON REMOVAL OF THE EXISTING HMA SURFACE.
- D: THE BUTT JOINT SHALL BE CONSTRUCTED IMMEDIATELY PRIOR TO PLACING THE PROPOSED HMA COURSES.
- E: TAPER THE TEMP. RAMP AT A RATE OF 3'-0" (900 mm) PER 1 INCH (25 mm) OF MILLING THICKNESS.
- F: INSTALLATION AND REMOVAL OF THE 4'-6" (1.35 m) TEMP. RAMP IS INCLUDED IN COST OF HMA SURFACE REMOVAL - BUTT JOINT
- G: SEE ARTICLE 406.08 AND 406.14 OF THE STANDARD SPECIFICATIONS FOR "HMA AND/OR PCC SURFACE REMOVAL, BUTT JOINT".
- * SEE TYPICAL SECTIONS FOR MILLING THICKNESS.
- *** 20'-0" (6.1 m) PER 1 (25) RESURFACING (NOTE "A")
10'-0" (3.0 m) PER 1 (25) RESURFACING (NOTE "B")

BASIS OF PAYMENT:

THE BUTT JOINT WILL BE PAID FOR AT THE CONTRACT UNIT PRICE PER SQUARE YARD (SQUARE METER) FOR "HOT-MIX ASPHALT SURFACE REMOVAL - BUTT JOINT" OR FOR "PORTLAND CEMENT CONCRETE SURFACE REMOVAL - BUTT JOINT".

ALL DIMENSIONS ARE IN INCHES (MILLIMETERS) UNLESS OTHERWISE SHOWN.

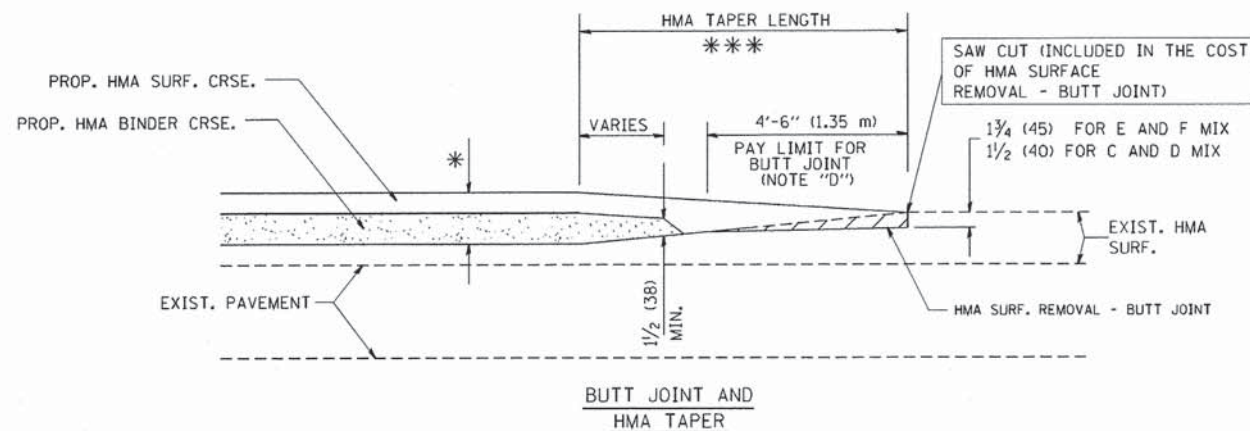

TYPICAL BUTT JOINT AND HMA TAPER FOR MILLING AND RESURFACING

FILE NAME = W:\diststd\22\34\bd32.dgn	USER NAME = geglrenobt	DESIGNED - M. DE YONG	REVISED - R. SHAH 10-25-94
		DRAWN -	REVISED - A. ABBAS 03-21-97
	PLOT SCALE = 50.0000' / IN.	CHECKED -	REVISED - M. GOMEZ 04-06-01
	PLOT DATE = 1/4/2008	DATE - 06-13-90	REVISED - R. BORO 01-01-07

**STATE OF ILLINOIS
DEPARTMENT OF TRANSPORTATION**

**BUTT JOINT AND
HMA TAPER DETAILS**

SCALE: NONE	SHEET NO. 1 OF 1 SHEETS	STA. TO STA.	F.A.U. RTE. 2792	SECTION 12-00018-00-RS	COUNTY COOK	TOTAL SHEETS 18	SHEET NO. 11
			BD400-05 BD32		CONTRACT NO. 61B15		
FED. ROAD DIST. NO. 1 ILLINOIS FED. AID PROJECT M-4003(084)							

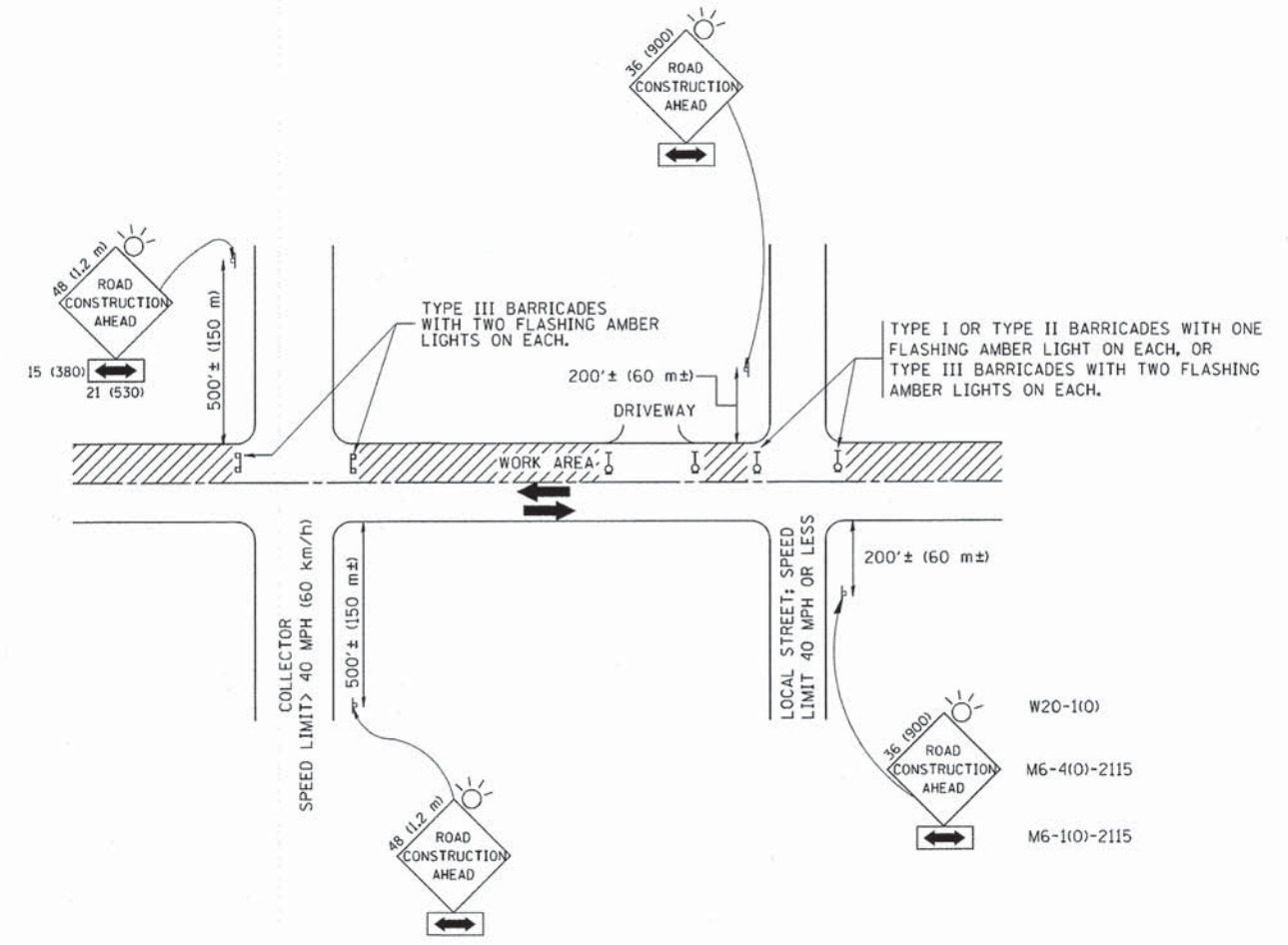

TRAFFIC CONTROL AND PROTECTION FOR SIDE ROADS, INTERSECTIONS, AND DRIVEWAYS

NOTES:

- A. FOR NO LANE RESTRICTION ON THE SIDE ROAD OR DRIVEWAYS
 1. SIDE ROAD WITH A SPEED LIMIT OF 40 MPH (60 km/h) OR LESS AS SHOWN ON THE DRAWING AND AS DIRECTED BY THE ENGINEER:
 - a) ONE ROAD CONSTRUCTION AHEAD SIGN 36 x 36 (900x900) WITH A FLASHER AND FLAG MOUNTED ON IT APPROXIMATELY 200' (60 m) IN ADVANCE OF THE MAIN ROUTE.
 - b) THE CLOSED PORTION OF THE MAIN ROUTE SHALL BE PROTECTED BY BLOCKING WITH TYPE I, TYPE II OR TYPE III BARRICADES, 1/3 OF THE CROSS SECTION OF THE CLOSED PORTION.
 2. SIDE ROAD WITH A SPEED LIMIT GREATER THAN 40 MPH (60 km/h) AS SHOWN ON THE DRAWING AND AS DIRECTED BY THE ENGINEER:
 - a) ONE ROAD CONSTRUCTION AHEAD SIGN 48 x 48 (1.2 m x 1.2 m) WITH A FLASHER MOUNTED ON IT APPROXIMATELY 500' (150 m) IN ADVANCE OF THE MAIN ROUTE.
 - b) THE CLOSED PORTION OF THE MAIN ROUTE SHALL BE PROTECTED BY BLOCKING WITH TYPE III BARRICADES, 1/2 OF THE CROSS SECTION OF THE CLOSED PORTION.
- 3. WHEN THE SIDE ROAD LIES BETWEEN THE BEGINNING OF THE MAINLINE SIGNING AND THE WORK ZONE, A SINGLE HEADED ARROW (M6-1) SHALL BE USED IN LIEU OF THE DOUBLE HEADED ARROW (M6-4).
- B. FOR A LANE CLOSURE ON A SIDE ROAD OR DRIVEWAY:

USE APPLICABLE PORTIONS OF THE TYPICAL APPLICATION OF TRAFFIC CONTROL DEVICES (STD. 701501, STD. 701606 OR THE APPROPRIATE STANDARD). THE SPACING OF SIGNS AND BARRICADES SHALL BE ADJUSTED FOR FIELD CONDITIONS AS DIRECTED BY THE ENGINEER. THE DIRECTIONAL ARROW SHALL BE COVERED OR REMOVED WHEN NO LONGER CONSISTENT WITH THE SIDE ROAD LANE CLOSURE.
- C. ADVANCE WARNING SIGNS ARE TO BE OMITTED ON DRIVEWAY UNLESS OTHERWISE NOTED.
- D. THE TRAFFIC CONTROL AND PROTECTION FOR SIDE ROADS, INTERSECTIONS, AND DRIVEWAYS SHALL BE INCIDENTAL TO THE COST OF SPECIFIED TRAFFIC CONTROL STANDARDS OR ITEMS.

All dimensions are in millimeters (inches) unless otherwise shown.

FILE NAME = W:\diststd\22x34\tcl0.dgn	USER NAME = gaglianobt	DESIGNED - LHA	REVISED - J. OBERLE 10-18-95
	PLOT SCALE = 50,000 ' / IN.	DRAWN -	REVISED - A. HOUSEH 03-06-96
	PLOT DATE = 1/4/2009	CHECKED -	REVISED - A. HOUSEH 10-15-96
		DATE - 06-89	REVISED - T. RAMMACHER 01-06-00

STATE OF ILLINOIS
DEPARTMENT OF TRANSPORTATION

TRAFFIC CONTROL AND PROTECTION FOR
SIDE ROADS, INTERSECTIONS, AND DRIVEWAYS
SCALE: NONE SHEET NO. 1 OF 1 SHEETS STA. TO STA.

F.A.U. RTE. 2792	SECTION 12-00018-00-RS	COUNTY COOK	TOTAL SHEETS 18	SHEET NO. 12
TC-10			CONTRACT NO. 61B15	
FED. ROAD DIST. NO. 1 ILLINOIS FED. AID PROJECT M-4003(084)				

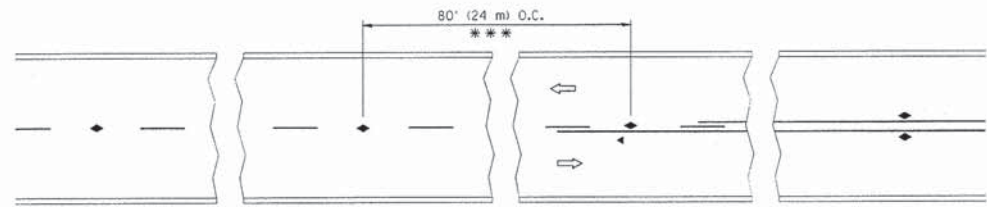

*** REDUCE TO 40' (12 m) O.C. ON CURVES WITH POSTED OR ADVISORY SPEED 45 M.P.H. (70 km/h) OR LESS.

TWO-LANE/TWO-WAY

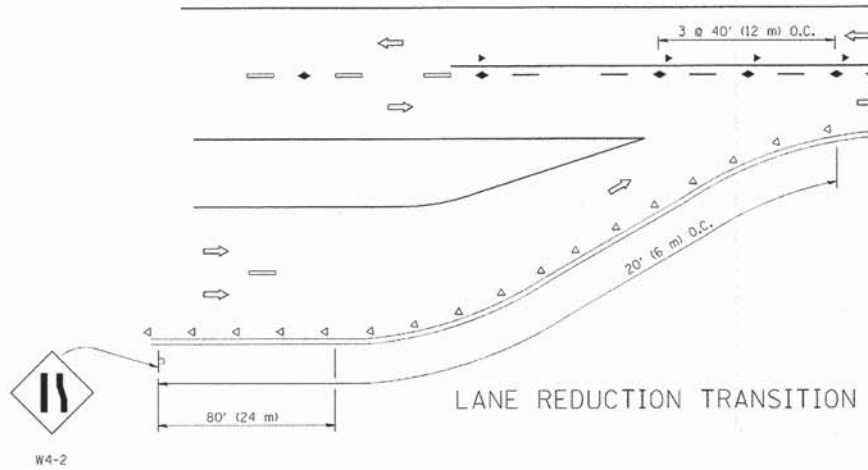

LANE REDUCTION TRANSITION

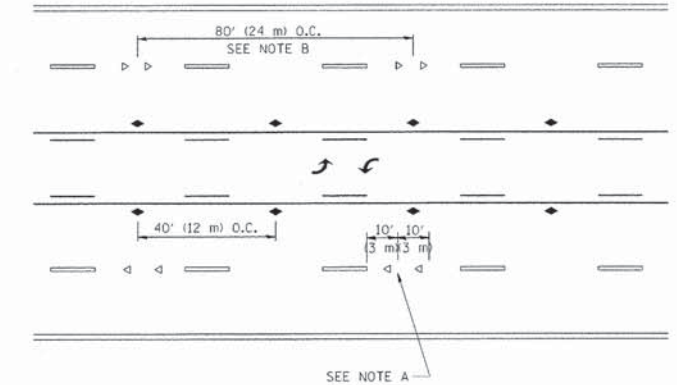

TWO-WAY LEFT TURN

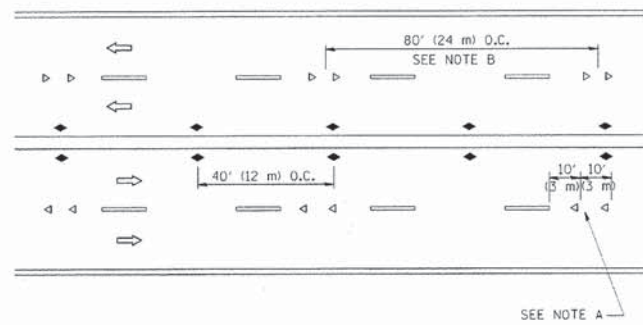

MULTI-LANE/UNDIVIDED

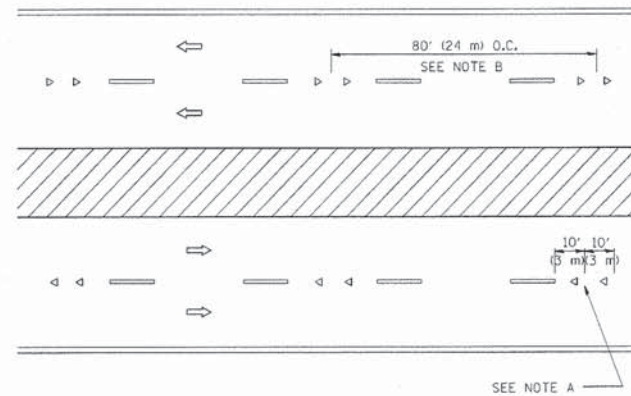

MULTI-LANE/DIVIDED

GENERAL NOTES

1. MARKERS USED WITH DASHED LINES SHALL BE CENTERED IN THE GAP BETWEEN SEGMENTS.
2. MARKERS USED ADJACENT TO SOLID LINES SHALL BE OFFSET 2 TO 3 (50 TO 75) TOWARD TRAFFIC AS SHOWN.
3. MARKERS THROUGH TANGENTS LESS THAN 500' (150 m) IN LENGTH BETWEEN CURVES SHALL BE INSTALLED AT THE LESSER OF THE TWO CURVE SPACINGS.

SYMBOLS

- YELLOW STRIPE
- WHITE STRIPE
- ◀ ONE-WAY AMBER MARKER
- ◁ ONE-WAY CRYSTAL MARKER (W/O)
- ◆ TWO-WAY AMBER MARKER

LANE MARKER NOTES

- A. USE DOUBLE LANE LINE MARKERS SPACED AS SHOWN.
- B. REDUCE TO 40' (12 m) O.C. ON CURVES WHERE ADVISORY SPEEDS ARE 10 M.P.H (20 km/h) LOWER THAN POSTED SPEEDS.

DESIGN NOTES

1. DOUBLE LANE LINE MARKERS SHALL BE USED UNLESS SPECIFIED OTHERWISE.
2. EXCEPT AS SHOWN ON THE LANE REDUCTION TRANSITION AND FREEWAY EXIT RAMP DETAIL, MARKERS ARE NOT TO BE SPECIFIED ON RIGHT EDGE LINES.
3. THE EXACT MARKER LIMITS, SPACING, AND COLOR SHOULD BE INCLUDED IN THE PLANS.
4. MARKERS SHOULD NOT BE USED ALONGSIDE CURBS EXCEPT FOR EXTREMELY SHORT SECTIONS OF CURBS WHERE NOT MORE THAN TWO MARKERS WOULD BE INVOLVED.

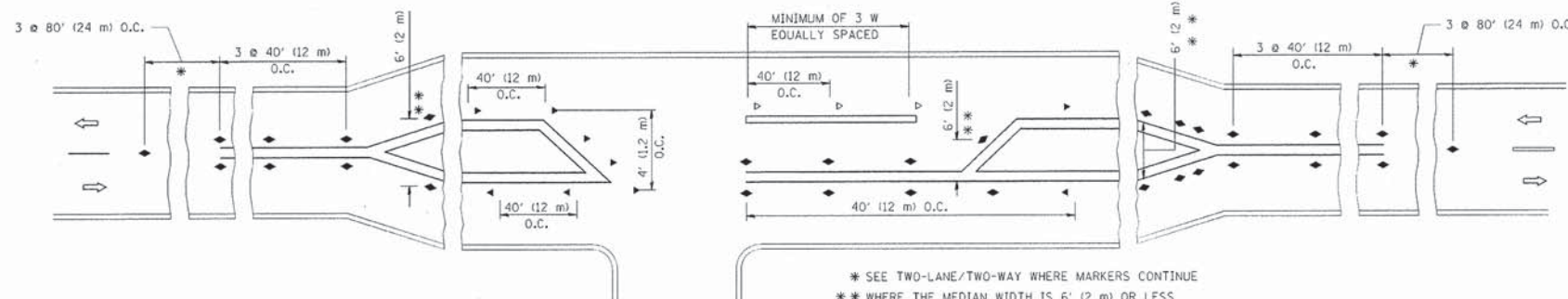

LEFT TURN

* SEE TWO-LANE/TWO-WAY WHERE MARKERS CONTINUE
 ** WHERE THE MEDIAN WIDTH IS 6' (2 m) OR LESS USE TWO-WAY MARKERS.

All dimensions are in inches (millimeters) unless otherwise shown.

FILE NAME *	USER NAME * drivakosgn	DESIGNED -	REVISED - T. RAMMACHER 09-19-94
c:\pwork\pwork\drivakosgn\d018315\to	udgn	DRAWN -	REVISED - T. RAMMACHER 03-12-99
		CHECKED -	REVISED - T. RAMMACHER 01-06-00
		DATE -	REVISED - C. JUCIUS 09-09-09

STATE OF ILLINOIS
 DEPARTMENT OF TRANSPORTATION

TYPICAL APPLICATIONS
 RAISED REFLECTIVE PAVEMENT MARKERS (SNOW-PLOW RESISTANT)

SCALE: NONE SHEET NO. 1 OF 1 SHEETS STA. TO STA.

F.A.U. RTE.	SECTION	COUNTY	TOTAL SHEETS	SHEET NO.
2792	12-00018-00-RS	COOK	18	13
TC-11			CONTRACT NO. 61B15	
FED. ROAD DIST. NO. 1 ILLINOIS FED. AID PROJECT			M-4003(084)	

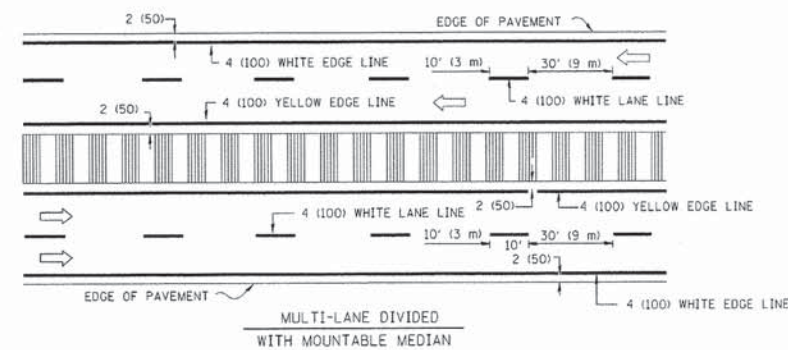
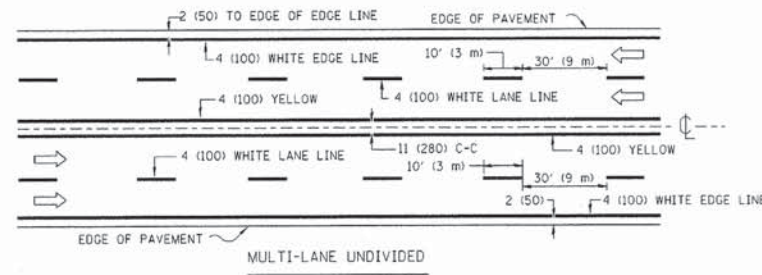
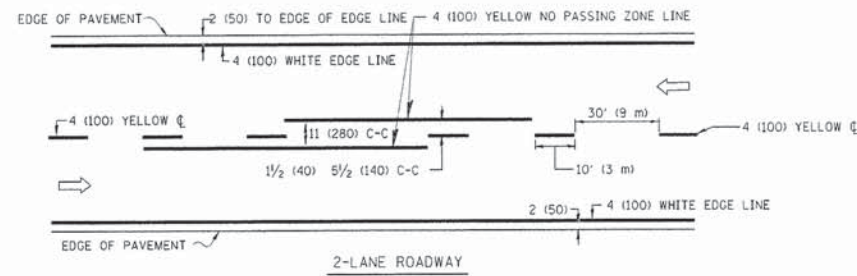

NOTE: MEDIANS WITH BARRIER CURB DO NOT REQUIRE AN EDGE LINE

TYPICAL LANE AND EDGE LINE MARKING

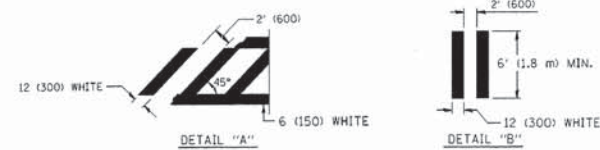
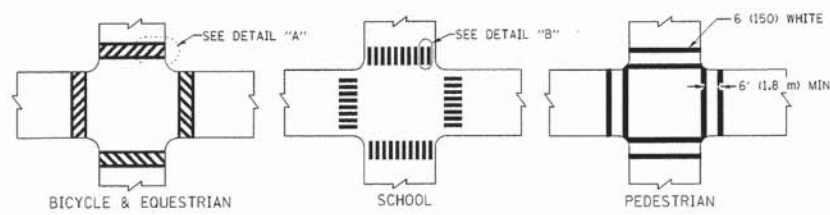

TYPICAL CROSSWALK MARKING

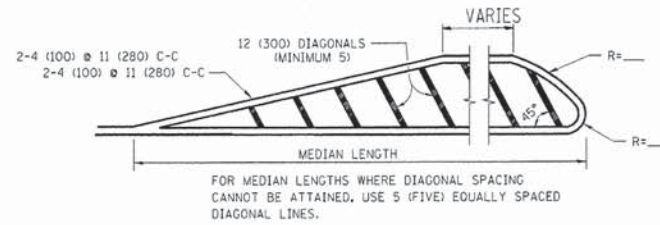
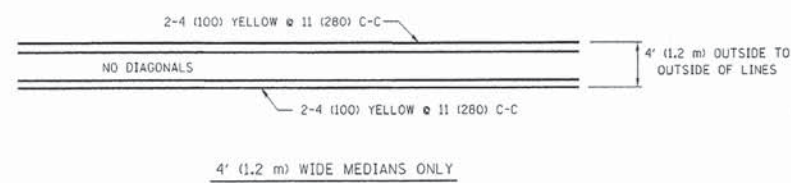

FOR MEDIAN LENGTHS WHERE DIAGONAL SPACING CANNOT BE ATTAINED, USE 5 (FIVE) EQUALLY SPACED DIAGONAL LINES.
 DIAGONAL LINE SPACING: 50' (15 m) C-C (LESS THAN 30MPH (50 km/h))
 75' (25 m) C-C 30MPH (50 km/h) TO 45MPH (70 km/h)
 150' (45 m) C-C (MORE THAN 45MPH (70 km/h))

MEDIANS OVER 4' (1.2 m) WIDE

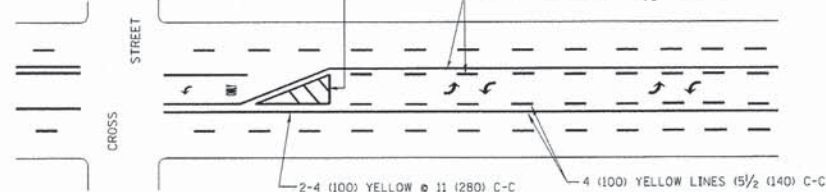

A MINIMUM OF TWO PAIRS OF TURN ARROWS SHALL BE USED, WHITE IN COLOR. ADDITIONAL PAIRS SHALL BE PLACED AT 200' (60 m) TO 300' (90 m) INTERVALS.

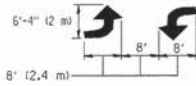

MEDIAN WITH TWO-WAY LEFT TURN LANE

TYPICAL PAINTED MEDIAN MARKING

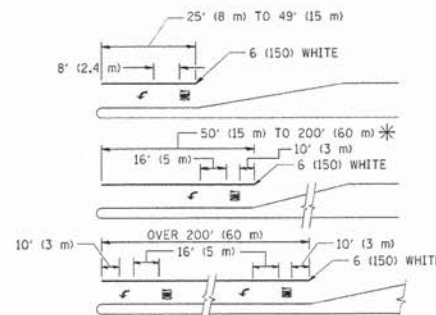

FULL SIZE LETTERS 8" (2.4 m) AND ARROWS SHALL BE USED.
 * AREA = 15.6 SQ. FT. (1.5 m²) ; ONLY AREA = 20.8 SQ. FT. (1.9 m²)

* TURN LANES IN EXCESS OF 400' (120 m) IN LENGTH MAY HAVE AN ADDITIONAL SET OF ARROW - "ONLY" INSTALLED MIDWAY BETWEEN THE OTHER TWO SETS OF ARROW - "ONLY".

TYPICAL LEFT (OR RIGHT) TURN LANE

TYPICAL TURN LANE MARKING

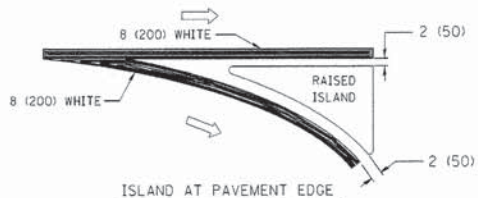
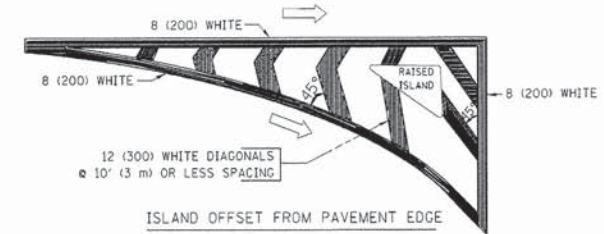

TYPICAL ISLAND MARKING

TYPE OF MARKING	WIDTH OF LINE	PATTERN	COLOR	SPACING / REMARKS
CENTERLINE ON 2 LANE PAVEMENT	4 (100)	SKIP-DASH	YELLOW	10' (3 m) LINE WITH 30' (9 m) SPACE
CENTERLINE ON MULTI-LANE UNDIVIDED PAVEMENT	2 @ 4 (100)	SOLID	YELLOW	11 (280) C-C
NO PASSING ZONE LINES: FOR ONE DIRECTION FOR BOTH DIRECTIONS	4 (100) 2 @ 4 (100)	SOLID SOLID	YELLOW YELLOW	5/2 (140) C-C FROM SKIP-DASH CENTERLINE 11 (280) C-C OMIT SKIP-DASH CENTERLINE BETWEEN
LANE LINES	4 (100) 5 (125) ON FREEWAYS	SKIP-DASH SKIP-DASH	WHITE WHITE	10' (3 m) LINE WITH 30' (9 m) SPACE
DOTTED LINES (EXTENSIONS OF CENTER, LANE OR TURN LANE MARKINGS)	SAME AS LINE BEING EXTENDED	SKIP-DASH	SAME AS LINE BEING EXTENDED	2' (600) LINE WITH 6' (1.8 m) SPACE
EDGE LINES	4 (100)	SOLID	YELLOW-LEFT WHITE-RIGHT	OUTLINE MOUNTABLE MEDIANS IN YELLOW; EDGE LINES ARE NOT USED NEXT TO BARRIER CURB
TURN LANE MARKINGS	6 (150) LINES FULL SIZE LETTERS & SYMBOLS 8" (2.4m)	SOLID	WHITE	SEE TYPICAL TURN LANE MARKING DETAIL
TWO WAY LEFT TURN MARKING	2 @ 4 (100) EACH DIRECTION 8' (2.4m) LEFT ARROW	SKIP-DASH AND SOLID IN PAIRS	YELLOW WHITE	10' (3 m) LINE WITH 30' (9 m) SPACE FOR SKIP-DASH 5/2 (140) C-C BETWEEN SOLID LINE AND SKIP-DASH LINE SEE TYPICAL TWO-WAY LEFT TURN MARKING DETAIL
CROSSWALK LINES (PEDESTRIAN) A. DIAGONALS (BIKE & EQUESTRIAN) B. LONGITUDINAL BARS (SCHOOL)	2 @ 6 (150) 12 (300) @ 45° 12 (300) @ 90°	SOLID SOLID SOLID	WHITE WHITE WHITE	NOT LESS THAN 6' (1.8 m) APART 2' (600) APART 2' (600) APART SEE TYPICAL CROSSWALK MARKING DETAILS.
STOP LINES	24 (600)	SOLID	WHITE	PLACE 4' (1.2 m) IN ADVANCE OF AND PARALLEL TO CROSSWALK, IF PRESENT, OTHERWISE, PLACE AT DESIRED STOPPING POINT. PARALLEL TO CROSSROAD CENTERLINE, WHERE POSSIBLE
PAINTED MEDIANS	2 @ 4 (100) WITH 12 (300) DIAGONALS @ 45° NO DIAGONALS USED FOR 4' (1.2 m) WIDE MEDIANS	SOLID	YELLOW; TWO WAY TRAFFIC WHITE; ONE WAY TRAFFIC	11 (280) C-C FOR THE DOUBLE LINE SEE TYPICAL PAINTED MEDIAN MARKING.
GORE MARKING AND CHANNELIZING LINES	8 (200) WITH 12 (300) DIAGONALS @ 45°	SOLID	WHITE	DIAGONALS: 15' (4.5 m) C-C (LESS THAN 30MPH (50 km/h)) 20' (6 m) C-C 30MPH (50 km/h) TO 45MPH (70 km/h) 30' (9 m) C-C (OVER 45MPH (70 km/h))
RAILROAD CROSSING	24 (600) TRANSVERSE LINES; "RR" 15' (4.5 m) LINE FOR "X"	SOLID	WHITE	SEE STATE STANDARD 780001 AREA OF: "R"=3.6 SQ. FT. (0.33 m ²) EACH "X"=54.0 SQ. FT. (5.0 m ²)
SHOULDER DIAGONALS	12 (300) @ 45°	SOLID	WHITE - RIGHT YELLOW - LEFT	50' (15 m) C-C (LESS THAN 30MPH (50 km/h)) 75' (25 m) C-C (30 MPH (50 km/h) TO 45MPH (70 km/h)) 150' (45 m) C-C (OVER 45MPH (70 km/h))

FOR FURTHER DETAILS ON PAVEMENT MARKING REFER TO STANDARD SPECIFICATIONS FOR ROAD AND BRIDGE CONSTRUCTION AND STATE STANDARD 780001.

	LARGE SIZE SQ FT (SQ M)	SMALL SIZE SQ FT (SQ M)
THROUGH ARROW	11.5 (1.07)	6.5 (0.60)
LEFT OF RIGHT ARROW	15.6 (1.47)	6.5 (0.60)
COMBINATION LEFT (RIGHT) AND THROUGH ARROW	26.0 (2.42)	14.7 (1.37)
RAILROAD "R" 1.8m (6ft.)	3.6 (0.33)	—
RAILROAD "X" 6.1m (20ft.)	54.0 (5.02)	—
HANDICAPPED SYMBOL	6.0 (0.56)	—

All dimensions are in inches (millimeters) unless otherwise shown.

FILE NAME =	USER NAME = drvakosgn	DESIGNED - EVERS	REVISED - T. RAMMACHER 10-27-94
e:\pavework\pvidot\drvakosgn\d0108315\to3.dgn		DRAWN -	REVISED - C. JUJUS 09-09-09
PLOT SCALE = 50.0000' / IN.		CHECKED -	REVISED -
PLOT DATE = 9/9/2009		DATE - 03-19-90	REVISED -

STATE OF ILLINOIS
DEPARTMENT OF TRANSPORTATION

DISTRICT ONE	
TYPICAL PAVEMENT MARKINGS	
SCALE: NONE	SHEET NO. 1 OF 1 SHEETS
STA.	TO STA.

F.A.U. R.T.E.	SECTION	COUNTY	TOTAL SHEETS	SHEET NO.
2792	12-00018-00-RS	COOK	18	14
TC-13		CONTRACT NO. 61B15		
FED. ROAD DIST. NO. 1 ILLINOIS FED. AID PROJECT M-4003(084)				

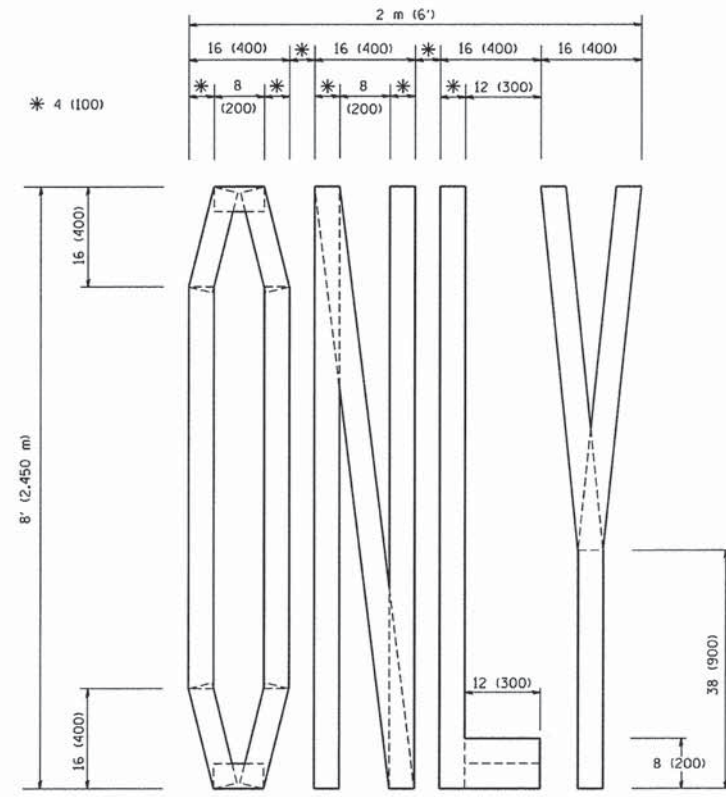

QUANTITY
 4 (100) LINE = 64.1 ft. (19.7 m)
 21.1 sq. ft. (1.97 sq. m)

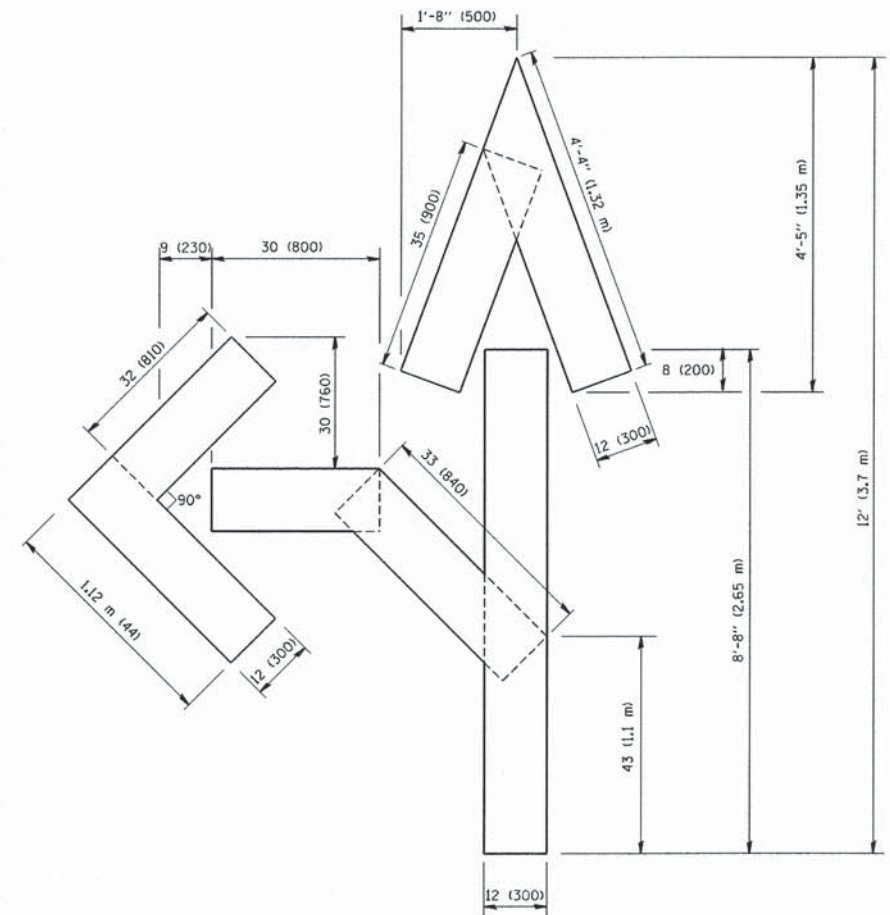

QUANTITY
 4 (100) LINE = 82.5 ft. (25.3 m)
 27.5 sq. ft. (2.53 sq. m)

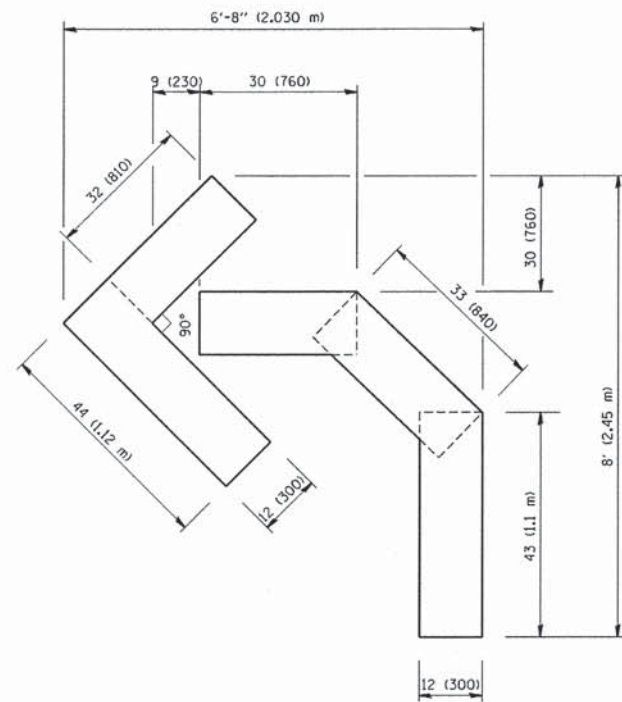

QUANTITY
 4 (100) LINE = 45.5 ft. (13.9 m)
 15.2 sq. ft. (1.39 sq. m)

All dimensions are in inches (millimeters) unless otherwise shown.

FILE NAME = W:\diststd\22x34\to16.dgn	USER NAME = geglienobt	DESIGNED -	REVISED -T. RAMMACHER 06-05-96
		DRAWN -	REVISED -T. RAMMACHER 11-04-97
	PLOT SCALE = 50.0000 "/ IN.	CHECKED -	REVISED -T. RAMMACHER 03-02-98
	PLOT DATE = 1/4/2008	DATE - 09-18-94	REVISED -E. GOMEZ 08-28-00

STATE OF ILLINOIS
 DEPARTMENT OF TRANSPORTATION

PAVEMENT MARKING LETTERS AND SYMBOLS
 FOR TRAFFIC STAGING

SCALE: NONE SHEET NO. 1 OF 1 SHEETS STA. TO STA.

F.A.I. RTE.	SECTION	COUNTY	TOTAL SHEETS	SHEET NO.
2792	12-00018-00-RS	COOK	18	15
TC-16			CONTRACT NO. 61B15	
FED. ROAD DIST. NO. 1 ILLINOIS FED. AID PROJECT M-4003(084)				

LOOPS NEXT TO SHOULDERS

PROVIDE A PAVEMENT REPLACEMENT NOTE WHICH SHOULD EQUAL 3' (900 mm) X WIDTH OF PAVED SHOULDER.

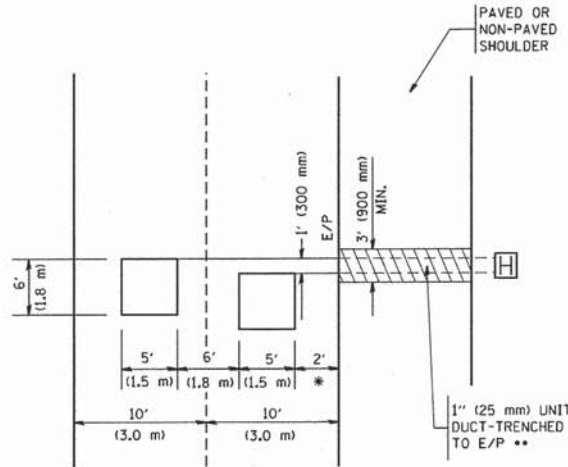

* = (600 mm)

** UNIT DUCT IS TO BE SHOWN ON PLAN SHEETS BUT SHALL NOT BE INCLUDED IN THE PAY ITEMS.

**LEFT TURN LANES WITH MEDIANS
VOLUME DENSITY ("FAR OUT" DETECTION)
ON SAME APPROACH
(PROTECTED / PERMITTED LEFT TURN PHASING)**

HANDHOLE LOCATION MAY VARY DEPENDING ON GEOMETRICS AND DESIGN OF TRAFFIC SIGNALS. HEAVY-DUTY HANDHOLES TO BE USED WHEN THE MEDIAN IS MOUNTABLE. REFER TO STANDARD 814001 TO ENSURE THAT HANDHOLE FITS IN MEDIAN.

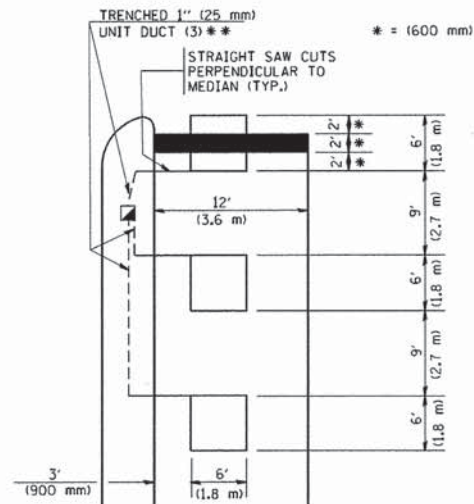

** UNIT DUCT IS TO BE SHOWN ON PLAN SHEETS BUT SHALL NOT BE INCLUDED IN THE PAY ITEMS.

NOTE: DUAL LEFT TURNS NOT SHOWN REFER TO PLAN SHEET FOR DETECTOR LOOP REPLACEMENT

**LEFT TURN LANES WITHOUT MEDIANS
VOLUME DENSITY ("FAR OUT" DETECTION)
ON SAME APPROACH
(PROTECTED / PERMITTED LEFT TURN PHASING)**

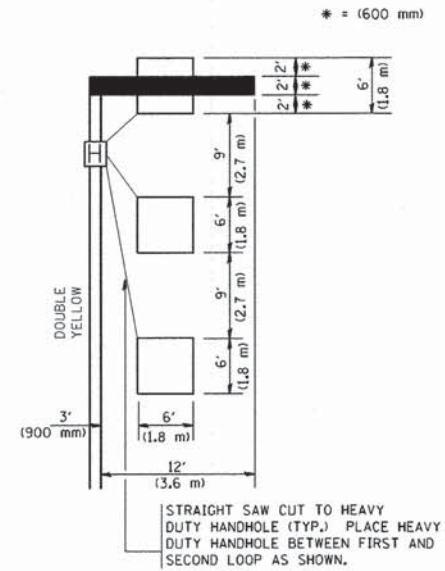

NOTE: DUAL LEFT TURNS NOT SHOWN REFER TO PLAN SHEET FOR DETECTOR LOOP REPLACEMENT

**ARTERIAL-VOLUME DENSITY ("FAR OUT" DETECTION)
CROSS STREET-VOLUME DENSITY ("FAR OUT" DETECTION)**

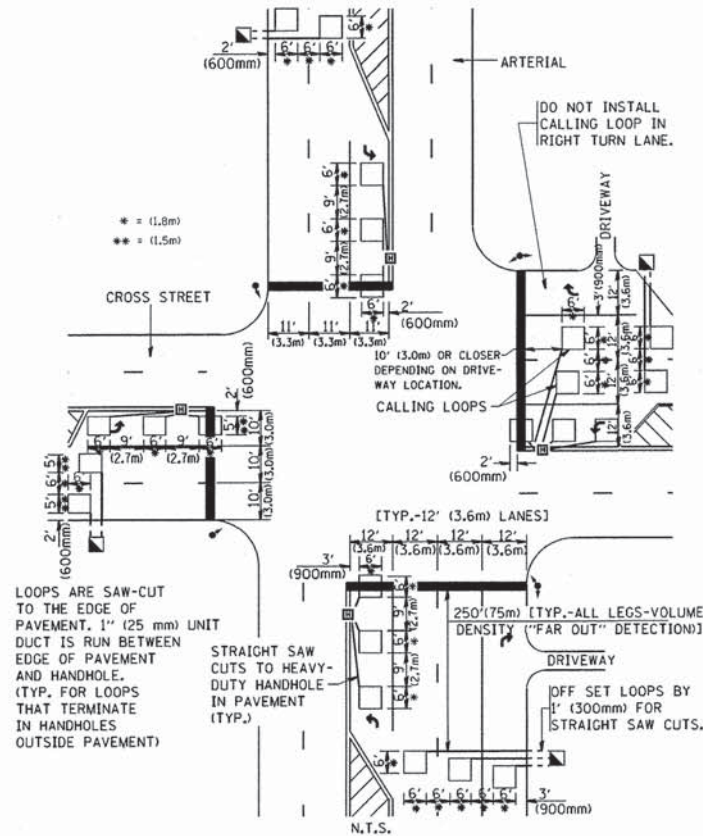

DETAIL 1
N.T.S.

**ARTERIAL-VOLUME DENSITY ("FAR OUT" DETECTION)
CROSS STREET-NON VOLUME DENSITY ("UPTIGHT" PRESENCE DETECTION)**

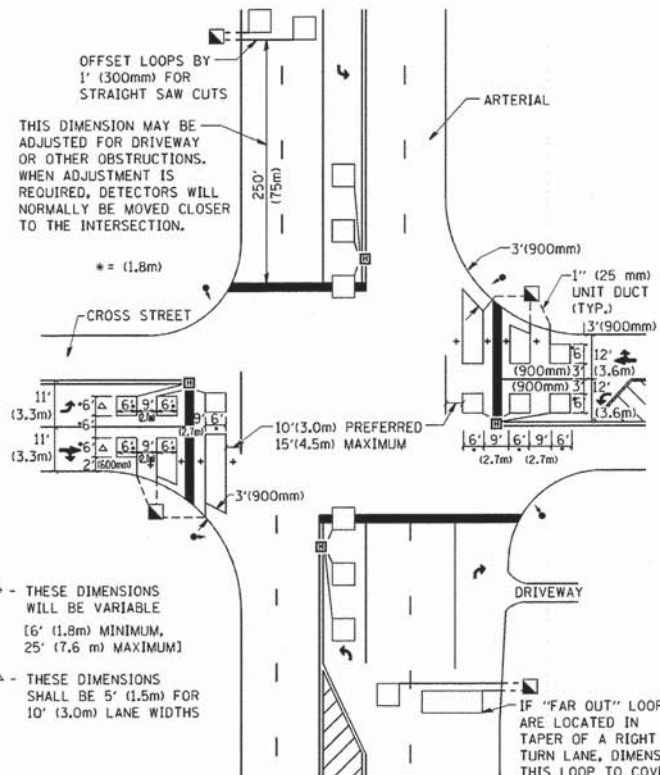

DETAIL 2
N.T.S.

NOTES:

VEHICLES LOOP DETECTORS

- * ALL LEAD IN CABLE SHALL BE TWO CONDUCTOR NO. 14 TWISTED, SHIELDED.
- * EACH DETECTOR LOOP SHALL HAVE ITS OWN SAW CUT FROM THE LOOP TO THE EDGE OF PAVEMENT OR TO A HANDHOLE IN THE PAVEMENT.
- * EACH DETECTOR LOOP SHALL HAVE ITS OWN ONE INCH (25 mm) UNIT DUCT BETWEEN THE EDGE OF PAVEMENT AND THE FIRST HANDHOLE OR JUNCTION BOX. EACH UNIT DUCT RUN SHALL BE SHOWN ON THE PLANS BY THE DESIGNER, BUT SHALL NOT BE PAID FOR SEPARATELY. THIS ITEM IS INCIDENTAL TO THE PAY ITEM FOR DETECTOR LOOPS.
- * ONE DIMENSION OF ALL DETECTOR LOOPS SHALL BE SIX FEET (1.8 m)
- * EACH LANE OF NON-LOCKING, PRESENCE DETECTION AND EACH LANE OF A DOUBLE LEFT TURN LANE REQUIRES A SEPARATE INDUCTIVE LOOP DETECTOR AND LEAD IN CABLE.
- * WHEN NON-LOCKING, PRESENCE DETECTION IS USED, MORE THAN ONE LOOP PER LANE IS REQUIRED BEHIND THE STOP BAR (i.e. 1-1/2, 1-3/4, 2).
- * WHEN SYSTEM LOOPS ARE REQUIRED ON AN APPROACH OF AN INTERSECTION, THE LOOPS USED FOR VOLUME DENSITY AND INTERSECTION TIMING SHALL ALSO BE USED AS SYSTEM DETECTORS. EACH ONE OF THESE TYPE OF LOOPS REQUIRES A SEPARATE TWO CONDUCTOR NO. 14 TWISTED SHIELDED CABLE AND A SEPARATE INDUCTIVE LOOP DETECTOR WHEN NEW CONTROLLERS ARE UTILIZED. THE DESIGNER SHALL LABEL THESE TYPES OF LOOPS AS "INTERSECTION AND SAMPLING (SYSTEM) DETECTORS" ON THE SIGNAL LAYOUT, THE INTERCONNECT PLAN AND THE SYSTEM CABLE PLAN. WHEN AN EXISTING CONTROLLER IS UTILIZED FOR THIS TYPE OF DETECTION, THE PAY ITEM "INDUCTIVE LOOP DETECTOR WITH SYSTEM OUTPUT" SHOULD BE USED.

PLACEMENT OF DETECTORS

THE FOLLOWING FIGURES REPRESENT THE MOST COMMON DETECTOR LOOP LOCATIONS AND SIZES. ADJUSTMENTS WILL BE NECESSARY FOR SPECIFIC GEOMETRIC CONSIDERATIONS.

LOCATIONS AND DIMENSIONS OF DETECTOR LOOPS ARE REQUIRED ON ALL SIGNAL LAYOUT PLAN SHEETS.

"FAR OUT" DETECTION REFERS TO LOCKING, PRESENCE TYPE DETECTION LOCATED IN THRU LANES, RIGHT TURN LANES, AND RIGHT TURN LANE TAPER AREAS (IF APPLICABLE), USUALLY 250' (75 m) IN ADVANCE OF STOP BARS. "UPTIGHT" DETECTION REFERS TO NON-LOCKING PRESENCE TYPE DETECTION LOCATED IN ALL LANES AND 10'-15' (3.0 m-4.5 m) BEHIND THE CROSSING STREET'S EDGE OF PAVEMENT EXTENDED.

NOTE:

ALL DETAILS AND NOTES SHOWN ARE FROM THE I.D.O.T. DISTRICT 1 TRAFFIC SIGNAL DESIGN GUIDELINES DATED JANUARY 1995

THIS DRAWING HAS BEEN PREPARED TO ASSIST THE RESIDENT ENGINEER FOR ALL ROADWAY RESURFACING OR S.M.A.R.T. PROJECTS WHERE THE DIMENSIONS ARE NOT SHOWN ON THE PLANS AND THE FINAL LOCATIONS FOR CROSSWALKS OR STOP BARS ARE NOT DETERMINED.

FILE NAME = W:\diststd\22x34\ts07.dgn	USER NAME = gajlienobt	DESIGNED -	REVISED -	STATE OF ILLINOIS DEPARTMENT OF TRANSPORTATION	DISTRICT 1 - DETECTOR LOOP INSTALLATION DETAILS FOR ROADWAY RESURFACING			F.A.U. RTE. 2792	SECTION 12-00018-00-RS	COUNTY COOK	TOTAL SHEETS 18	SHEET NO. 18
PLOT SCALE = 50.0000' / IN.	CHECKED - R.K.F.	REVISED -	REVISED -		SCALE: NONE	SHEET NO. 1 OF 1 SHEETS	STA.	TO STA.	TS-07		CONTRACT NO. 61B15	
PLOT DATE = 1/4/2008	DATE -	REVISED -	REVISED -		FED. ROAD DIST. NO. 1 ILLINOIS FED. AID PROJECT M-4003(084)							