

# **BID PROPOSAL INSTRUCTIONS**

**ABOUT IDOT PROPOSALS:** All proposals are potential bidding proposals. Each proposal contains all certifications and affidavits, a proposal signature sheet and a proposal bid bond.

## **PREQUALIFICATION**

Any contractor who desires to become pre-qualified to bid on work advertised by IDOT must submit the properly completed pre-qualification forms to the Bureau of Construction no later than 4:30 p.m. prevailing time twenty-one days prior to the letting of interest. This pre-qualification requirement applies to first time contractors, contractors renewing expired ratings, contractors maintaining continuous pre-qualification or contractors requesting revised ratings. To be eligible to bid, existing pre-qualification ratings must be effective through the date of letting.

## **WHO CAN BID ?**

Bids will be accepted from only those companies that request and receive written Authorization to Bid from IDOT's Central Bureau of Construction.

## **REQUESTS FOR AUTHORIZATION TO BID**

Contractors wanting to bid on items included in a particular letting must submit the properly completed "Request for Authorization to Bid/or Not For Bid Status" (BDE 124) and the ORIGINAL "Affidavit of Availability" (BC 57) to the proper office no later than 4:30 p.m. prevailing time, three (3) days prior to the letting date.

## **WHAT CONSTITUTES WRITTEN AUTHORIZATION TO BID?**

When a prospective prime bidder submits a "Request for Authorization to Bid/or Not For Bid Status"(BDE 124) he/she must indicate at that time which items are being requested For Bidding purposes. Only those items requested For Bidding will be analyzed. After the request has been analyzed, the bidder will be issued an **Authorization to Bid or Not for Bid Report**, approved by the Central Bureau of Construction and the Chief Procurement Officer that indicates which items have been approved For Bidding. If **Authorization to Bid** cannot be approved, the **Authorization to Bid or Not for Bid Report** will indicate the reason for denial.

## **ABOUT AUTHORIZATION TO BID**

Firms that have not received an Authorization to Bid or Not For Bid Report within a reasonable time of complete and correct original document submittal should contact the Department as to the status. Firms unsure as to authorization status should call the Prequalification Section of the Bureau of Construction at the number listed at the end of these instructions.

## **ADDENDA AND REVISIONS**

It is the bidder's responsibility to determine which, if any, addenda or revisions pertain to any project they may be bidding. Failure to incorporate all relevant addenda or revisions may cause the bid to be declared unacceptable.

Each addendum or revision will be included with the Electronic Plans and Proposals. Addenda and revisions will also be placed on the Addendum/Revision Checklist and each subscription service subscriber will be notified by e-mail of each addendum and revision issued.

The Internet is the Department's primary way of doing business. The subscription service emails are an added courtesy the Department provides. It is suggested that bidders check IDOT's website at <http://www.dot.il.gov/desenv/delett.html> before submitting final bid information.

***IDOT IS NOT RESPONSIBLE FOR ANY E-MAIL FAILURES.***

Addenda questions may be directed to the Contracts Office at (217)782-7806 or [DOT.D&Econtracts@illinois.gov](mailto:DOT.D&Econtracts@illinois.gov)

Technical questions about downloading these files may be directed to Tim Garman at (217)524-1642 or [Timothy.Garman@illinois.gov](mailto:Timothy.Garman@illinois.gov).

## **STANDARD GUIDELINES FOR SUBMITTING BIDS**

- All pages should be single sided.
- Use the Cover Page that is provided in the Bid Proposal (posted on the IDOT Web Site) as the first page of your submitted bid. It has the item number in large bold type in the upper left-hand corner and lines provided for your company name and address in the upper right-hand corner.
- Do not use report covers, presentation folders or special bindings and do not staple multiple times on left side like a book. Use only 1 staple in the upper left hand corner. Make sure all elements of your bid are stapled together including the bid bond or guaranty check (if required).
- Do not include any certificates of eligibility, your authorization to bid, Addendum Letters or affidavit of availability.
- Do not include the Subcontractor Documentation with your bid (pages i – iii and pages a – g). This documentation is required only if you are awarded the project.
- Use the envelope cover sheet (provided with the proposal) as the cover for the proposal envelope.
- Do not rely on overnight services to deliver your proposal prior to 10 AM on letting day. It will not be read if it is delivered after 10 AM.
- Do not submit your Substance Abuse Prevention Program (SAPP) with your bid. If you are awarded the contract this form is to be submitted to the district engineer at the pre-construction conference.

## **BID SUBMITTAL CHECKLIST**

- Cover page** (the sheet that has the item number on it) – This should be the first page of your bid proposal, **followed by your bid (the Schedule of Prices/Pay Items)**. If you are using special software or CBID to generate your schedule of prices, do not include the blank pages of the schedule of prices that came with the proposal package.
- Page 4 (Item 9)** – Check “YES” if you will use a subcontractor(s) with an annual value over \$50,000. Include the subcontractor(s) name, address, general type of work to be performed and the dollar amount. If you will use subcontractor(s) but are uncertain who or the dollar amount; check “YES” but leave the lines blank.
- After page 4** – Insert the following documents: The **Illinois Office Affidavit** (Not applicable to federally funded projects) followed by Cost Adjustments for Steel, Bituminous and Fuel (if applicable) and the Contractor Letter of Assent (if applicable). The general rule should be, if you don’t know where it goes, put it after page 4.
- Page 10 (Paragraph J)** – Check “YES” or “NO” whether your company has any business in Iran.
- Page 10 (Paragraph K)** – (Not applicable to federally funded projects) List the name of the apprenticeship and training program sponsor holding the certificate of registration from the US Department of Labor. If no applicable program exists, please indicate the work/job category **Your bid will not be read if this is not completed.** Do not include certificates with your bid. Keep the certificates in your office in case they are requested by IDOT.
- Page 11 (Paragraph L)** – A copy of your State Board of Elections certificate of registration is no longer required with your bid.
- Page 11 (Paragraph M)** – Indicate if your company has hired a lobbyist in connection with the job for which you are submitting the bid proposal.
- Page 12 (Paragraph C)** – This is a work sheet to determine if a completed Form A is required. It is not part of the form and you do not need to make copies for each completed Form A.
- Pages 14-17 (Form A)** – One Form A (4 pages) is required for each applicable person in your company. Copies of the forms can be used and only need to be changed when the information changes. The certification signature and date must be original for each letting. **Do not staple the forms together.** If you answered “NO” to all of the questions in Paragraph C (page 12), complete the first section (page 14) with your company information and then sign and date the Not Applicable statement on page 17.
- Page 18 (Form B)** - If you check “YES” to having other current or pending contracts it is acceptable to use the phrase, “See Affidavit of Availability on file”. **Ownership Certification** (at the bottom of the page) - Check N/A if the Form A(s) you submitted accounts for 100 percent of the company ownership. Check YES if any percentage of ownership falls outside of the parameters that require reporting on the Form A. Checking NO indicates that the Form A(s) you submitted is not correct and you will be required to submit a revised Form A.
- Page 20 (Workforce Projection)** – Be sure to include the Duration of the Project. It is acceptable to use the phrase “Per Contract Specifications”.

**Proposal Bid Bond** – (Insert after the proposal signature page) Submit your proposal Proposal Bid Bond (if applicable) using the current Proposal Bid Bond form provided in the proposal package. The Power of Attorney page should be stapled to the Proposal Bid Bond. If you are using an electronic bond, include your bid bond number on the Proposal Bid Bond and attach the Proof of Insurance printed from the Surety’s Web Site.

**Disadvantaged Business Utilization Plan and/or Good Faith Effort** – The last items in your bid should be the DBE Utilization Plan (SBE 2026), followed by the DBE Participation Statement (SBE 2025) and supporting paperwork. If you have documentation of a Good Faith Effort, it is to follow the SBE Forms.

**The Bid Letting is now available in streaming Audio/Video from the IDOT Web Site.** A link to the stream will be placed on the main page of the current letting on the day of the Letting. The stream will not begin until 10 AM. The actual reading of the bids does not begin until approximately 10:30 AM.

Following the Letting, the As-Read Tabulation of Bids will be posted by the end of the day. You will find the link on the main Web page for the current letting.

**QUESTIONS: pre-letting up to execution of the contract**

|  |              |
|--|--------------|
| Contractor pre-qualification .....                               | 217-782-3413 |
| Small Business, Disadvantaged Business Enterprise (DBE) .....    | 217-785-4611 |
| Contracts, Bids, Letting process or Internet downloads .....     | 217-782-7806 |
| Estimates Unit.....  | 217-785-3483 |
| Aeronautics.....   | 217-785-8515 |
| IDNR (Land Reclamation, Water Resources, Natural Resources)..... | 217-782-6302 |

**QUESTIONS: following contract execution**

|   |              |
|---|--------------|
| Subcontractor documentation, payments ..... | 217-782-3413 |
| Railroad Insurance .....                    | 217-785-0275 |

# 87

RETURN WITH BID

|                       |
|-----------------------|
| Proposal Submitted By |
| Name                  |
| Address               |
| City                  |

Letting April 25, 2014

**NOTICE TO PROSPECTIVE BIDDERS**

This proposal can be used for bidding purposes by only those companies that request and receive written AUTHORIZATION TO BID from IDOT's Central Bureau of Construction.

**BIDDERS NEED NOT RETURN THE ENTIRE PROPOSAL**

# Notice to Bidders, Specifications, Proposal, Contract and Contract Bond



**Illinois Department  
of Transportation**

Springfield, Illinois 62764

**Contract No. 91491  
EDGAR County  
Section 10-00105-02-RS  
Route FAS 679 (Ch 8)  
Project RS-0679(111)  
District 5 Construction Funds**

PLEASE MARK THE APPROPRIATE BOX BELOW:

- A Bid Bond is included.
- A Cashier's Check or a Certified Check is included
- An Annual Bid Bond is included or is on file with IDOT.

Plans Included  
Herein

|             |   |
|-------------|---|
| Prepared by |   |
| Checked by  | F |

(Printed by authority of the State of Illinois)

**Page intentionally left blank**

RETURN WITH BID



PROPOSAL

TO THE DEPARTMENT OF TRANSPORTATION

1. Proposal of \_\_\_\_\_  
\_\_\_\_\_

Taxpayer Identification Number (Mandatory) \_\_\_\_\_

For the improvement identified and advertised for bids in the Invitation for Bids as:

**Contract No. 91491  
EDGAR County  
Section 10-00105-02-RS  
Project RS-0679(111)  
Route FAS 679 (Ch 8)  
District 5 Construction Funds**

**Project consists of the construction of a 1 1/4" HMA surface course, aggregate wedge shoulders, pavement markings, raised reflective pavement markers and all other incidental items to complete the work on FAS Route 679 (CH 8), 0.64 mile east of Illinois Route 49 to Illinois Route 1.**

2. The undersigned bidder will furnish all labor, material and equipment to complete the above described project in a good and workmanlike manner as provided in the contract documents provided by the Department of Transportation. This proposal will become part of the contract and the terms and conditions contained in the contract documents will govern performance and payments.

**RETURN WITH BID**

3. **ASSURANCE OF EXAMINATION AND INSPECTION/WAIVER.** The undersigned bidder further declares that he/she has carefully examined the proposal, plans, specifications, addenda form of contract and contract bond, and special provisions, and that he/she has inspected in detail the site of the proposed work, and that he/she has familiarized themselves with all of the local conditions affecting the contract and the detailed requirements of construction, and understands that in making this bid proposal he/she waives all right to plead any misunderstanding regarding the same.
  
4. **EXECUTION OF CONTRACT AND CONTRACT BOND.** The undersigned bidder further agrees to execute a contract for this work and present the same to the department within fifteen (15) days after the contract has been mailed to him/her. The undersigned further agrees that he/she and his/her surety will execute and present within fifteen (15) days after the contract has been mailed to him/her contract bond satisfactory to and in the form prescribed by the Department of Transportation, in the penal sum of the full amount of the contract, or as specified in the special provisions, guaranteeing the faithful performance of the work in accordance with the terms of the contract.
  
5. **PROPOSAL GUARANTY.** Accompanying this proposal is either a bid bond on the department form, executed by a corporate surety company satisfactory to the department, or a proposal guaranty check consisting of a bank cashier's check or a properly certified check for not less than 5 per cent of the amount bid or for the amount specified in the following schedule:

| <u>Amount of Bid</u> |                      | <u>Proposal Guaranty</u> | <u>Amount of Bid</u> |    | <u>Proposal Guaranty</u> |             |
|----------------------|----------------------|--------------------------|----------------------|----|--------------------------|-------------|
| Up to                | \$5,000 .....        | \$150                    | \$2,000,000          | to | \$3,000,000 .....        | \$100,000   |
| \$5,000              | to \$10,000 .....    | \$300                    | \$3,000,000          | to | \$5,000,000 .....        | \$150,000   |
| \$10,000             | to \$50,000 .....    | \$1,000                  | \$5,000,000          | to | \$7,500,000 .....        | \$250,000   |
| \$50,000             | to \$100,000 .....   | \$3,000                  | \$7,500,000          | to | \$10,000,000 .....       | \$400,000   |
| \$100,000            | to \$150,000 .....   | \$5,000                  | \$10,000,000         | to | \$15,000,000 .....       | \$500,000   |
| \$150,000            | to \$250,000 .....   | \$7,500                  | \$15,000,000         | to | \$20,000,000 .....       | \$600,000   |
| \$250,000            | to \$500,000 .....   | \$12,500                 | \$20,000,000         | to | \$25,000,000 .....       | \$700,000   |
| \$500,000            | to \$1,000,000 ..... | \$25,000                 | \$25,000,000         | to | \$30,000,000 .....       | \$800,000   |
| \$1,000,000          | to \$1,500,000 ..... | \$50,000                 | \$30,000,000         | to | \$35,000,000 .....       | \$900,000   |
| \$1,500,000          | to \$2,000,000 ..... | \$75,000                 | over                 |    | \$35,000,000 .....       | \$1,000,000 |

Bank cashier's checks or properly certified checks accompanying bid proposals will be made payable to the Treasurer, State of Illinois.

If a combination bid is submitted, the proposal guaranties which accompany the individual bid proposals making up the combination will be considered as also covering the combination bid.

The amount of the proposal guaranty check is \_\_\_\_\_ \$( \_\_\_\_\_ ). If this proposal is accepted and the undersigned will fail to execute a contract bond as required herein, it is hereby agreed that the amount of the proposal guaranty will become the property of the State of Illinois, and shall be considered as payment of damages due to delay and other causes suffered by the State because of the failure to execute said contract and contract bond; otherwise, the bid bond will become void or the proposal guaranty check will be returned to the undersigned.

**Attach Cashier's Check or Certified Check Here**

In the event that one proposal guaranty check is intended to cover two or more bid proposals, the amount must be equal to the sum of the proposal guaranties which would be required for each individual bid proposal. If the guaranty check is placed in another bid proposal, state below where it may be found.

The proposal guaranty check will be found in the bid proposal for:

Item \_\_\_\_\_

Section No. \_\_\_\_\_

County \_\_\_\_\_

**Mark the proposal cover sheet as to the type of proposal guaranty submitted.**

**RETURN WITH BID**

6. **COMBINATION BIDS.** The undersigned bidder further agrees that if awarded the contract for the sections contained in the following combination, he/she will perform the work in accordance with the requirements of each individual contract comprising the combination bid specified in the schedule below, and that the combination bid shall be prorated against each section in proportion to the bid submitted for the same. If an error is found to exist in the gross sum bid for one or more of the individual sections included in a combination, the combination bid shall be corrected as provided in the specifications.

**When a combination bid is submitted, the schedule below must be completed in each proposal comprising the combination.**

**If alternate bids are submitted for one or more of the sections comprising the combination, a combination bid must be submitted for each alternate.**

**Schedule of Combination Bids**

| Combination No. | Sections Included in Combination | Combination Bid |       |
|-----------------|----------------------------------|-----------------|-------|
|                 |                                  | Dollars         | Cents |
|                 |                                  |                 |       |
|                 |                                  |                 |       |
|                 |                                  |                 |       |
|                 |                                  |                 |       |

7. **SCHEDULE OF PRICES.** The undersigned bidder submits herewith, in accordance with the rules and instructions, a schedule of prices for the items of work for which bids are sought. The unit prices bid are in U.S. dollars and cents, and all extensions and summations have been made. The bidder understands that the quantities appearing in the bid schedule are approximate and are provided for the purpose of obtaining a gross sum for the comparison of bids. If there is an error in the extension of the unit prices, the unit prices will govern. Payment to the contractor awarded the contract will be made only for actual quantities of work performed and accepted or materials furnished according to the contract. The scheduled quantities of work to be done and materials to be furnished may be increased, decreased or omitted as provided elsewhere in the contract.
8. **AUTHORITY TO DO BUSINESS IN ILLINOIS.** Section 20-43 of the Illinois Procurement Code (the Code) (30 ILCS 500/20-43) provides that a person (other than an individual acting as a sole proprietor) must be a legal entity authorized to do business in the State of Illinois prior to submitting the bid.
9. **EXECUTION OF CONTRACT:** The Department of Transportation will, in accordance with the rules governing Department procurements, execute the contract and shall be the sole entity having the authority to accept performance and make payments under the contract. Execution of the contract by the Chief Procurement Officer (CPO) or the State Purchasing Officer (SPO) is for approval of the procurement process and execution of the contract by the Department. Neither the CPO nor the SPO shall be responsible for administration of the contract or determinations respecting performance or payment there under except as otherwise permitted in the Code.
10. **The services of a subcontractor will be used.**

Check box Yes   
 Check box No

For known subcontractors with subcontracts with an annual value of more than \$50,000, the contract shall include their name, address, general type of work to be performed, and the dollar allocation for each subcontractor.  
 (30 ILCS 500/20-120)

---



---



|             |      |      |                |                 |         |
|-------------|------|------|----------------|-----------------|---------|
| COUNTY NAME | CODE | DIST | SECTION NUMBER | PROJECT NUMBER  | ROUTE   |
| EDGAR       | 045  | 05   | 10-00105-02-RS | RS-0679/111/000 | FAS 679 |

| ITEM NUMBER | PAY ITEM DESCRIPTION  | UNIT OF MEASURE | QUANTITY    | UNIT PRICE |       | TOTAL PRICE |     |
|-------------|-----------------------|-----------------|-------------|------------|-------|-------------|-----|
|             |                       |                 |             | DOLLARS    | CENTS | DOLLARS     | CTS |
| Z0048665    | RR PROT LIABILITY INS | L SUM           | 1.000       | X          | =     |             |     |
| 40600100    | BIT MATLS PR CT       | GALLON          | 17,815.000  | X          | =     |             |     |
| 40600300    | AGG PR CT             | TON             | 270.000     | X          | =     |             |     |
| 40600895    | CONSTRUC TEST STRIP   | EACH            | 1.000       | X          | =     |             |     |
| 40600982    | HMA SURF REM BUTT JT  | SQ YD           | 537.000     | X          | =     |             |     |
| 40600990    | TEMPORARY RAMP        | SQ YD           | 120.000     | X          | =     |             |     |
| 40603310    | HMA SC "C" N50        | TON             | 12,450.000  | X          | =     |             |     |
| 48102100    | AGG WEDGE SHLD TYPE B | TON             | 1,410.000   | X          | =     |             |     |
| 67100100    | MOBILIZATION          | L SUM           | 1.000       | X          | =     |             |     |
| 70100460    | TRAF CONT-PROT 701306 | L SUM           | 1.000       | X          | =     |             |     |
| 70300100    | SHORT TERM PAVT MKING | FOOT            | 6,828.000   | X          | =     |             |     |
| 70301000    | WORK ZONE PAVT MK REM | SQ FT           | 2,276.000   | X          | =     |             |     |
| 78001100    | PT PVT MK LTRS & SYMB | SQ FT           | 122.400     | X          | =     |             |     |
| 78001110    | PAINT PVT MK LINE 4   | FOOT            | 153,298.000 | X          | =     |             |     |
| 78001180    | PAINT PVT MK LINE 24  | FOOT            | 92.000      | X          | =     |             |     |

| ITEM NUMBER | PAY ITEM DESCRIPTION  | UNIT OF MEASURE | QUANTITY | UNIT PRICE |       | TOTAL PRICE |     |
|-------------|-----------------------|-----------------|----------|------------|-------|-------------|-----|
|             |                       |                 |          | DOLLARS    | CENTS | DOLLARS     | CTS |
| 78100100    | RAISED REFL PAVT MKR  | EACH            | 855.000  |            | X     |             |     |
| 78300200    | RAISED REF PVT MK REM | EACH            | 855.000  |            | X     |             |     |

TOTAL \$

- NOTE:
1. EACH PAY ITEM SHOULD HAVE A UNIT PRICE AND A TOTAL PRICE.
  2. THE UNIT PRICE SHALL GOVERN IF NO TOTAL PRICE IS SHOWN OR IF THERE IS A DISCREPANCY BETWEEN THE PRODUCT OF THE UNIT PRICE MULTIPLIED BY THE QUANTITY.
  3. IF A UNIT PRICE IS OMITTED, THE TOTAL PRICE WILL BE DIVIDED BY THE QUANTITY IN ORDER TO ESTABLISH A UNIT PRICE.
  4. A BID MAY BE DECLARED UNACCEPTABLE IF NEITHER A UNIT PRICE NOR A TOTAL PRICE IS SHOWN.

## RETURN WITH BID

### **STATE REQUIRED ETHICAL STANDARDS GOVERNING CONTRACT PROCUREMENT: ASSURANCES, CERTIFICATIONS AND DISCLOSURES**

#### I. GENERAL

A. Article 50 of the Code establishes the duty of all State CPOs, SPOs, and their designees to maximize the value of the expenditure of public moneys in procuring goods, services, and contracts for the State of Illinois and to act in a manner that maintains the integrity and public trust of State government. In discharging this duty, they are charged by law to use all available information, reasonable efforts, and reasonable actions to protect, safeguard, and maintain the procurement process of the State of Illinois.

B. In order to comply with the provisions of Article 50 and to carry out the duty established therein, all bidders are to adhere to ethical standards established for the procurement process, and to make such assurances, disclosures and certifications required by law. Except as otherwise required in subsection III, paragraphs J-M, by execution of the Proposal Signature Sheet, the bidder indicates that each of the mandated assurances have been read and understood, that each certification is made and understood, and that each disclosure requirement has been understood and completed.

C. In addition to all other remedies provided by law, failure to comply with any assurance, failure to make any disclosure or the making of a false certification shall be grounds for the CPO to void the contract, and may result in the suspension or debarment of the bidder or subcontractor. If a false certification is made by a subcontractor the contractor's submitted bid and the executed contract may not be declared void unless the contractor refuses to terminate the subcontract upon the State's request after a finding that the subcontractor's certification was false.

I acknowledge, understand and accept these terms and conditions.

#### II. ASSURANCES

The assurances hereinafter made by the bidder are each a material representation of fact upon which reliance is placed should the Department enter into the contract with the bidder.

##### A. Conflicts of Interest

Section 50-13. Conflicts of Interest.

(a) Prohibition. It is unlawful for any person holding an elective office in this State, holding a seat in the General Assembly, or appointed to or employed in any of the offices or agencies of state government and who receives compensation for such employment in excess of 60% of the salary of the Governor of the State of Illinois, or who is an officer or employee of the Capital Development Board or the Illinois State Toll Highway Authority, or who is the spouse or minor child of any such person to have or acquire any contract, or any direct pecuniary interest in any contract therein, whether for stationery, printing, paper, or any services, materials, or supplies, that will be wholly or partially satisfied by the payment of funds appropriated by the General Assembly of the State of Illinois or in any contract of the Capital Development Board or the Illinois State Toll Highway Authority.

(b) Interests. It is unlawful for any firm, partnership, association or corporation, in which any person listed in subsection (a) is entitled to receive (i) more than 7 1/2% of the total distributable income or (ii) an amount in excess of the salary of the Governor, to have or acquire any such contract or direct pecuniary interest therein.

(c) Combined interests. It is unlawful for any firm, partnership, association, or corporation, in which any person listed in subsection (a) together with his or her spouse or minor children is entitled to receive (i) more than 15%, in the aggregate, of the total distributable income or (ii) an amount in excess of 2 times the salary of the Governor, to have or acquire any such contract or direct pecuniary interest therein.

(d) Securities. Nothing in this Section invalidates the provisions of any bond or other security previously offered or to be offered for sale or sold by or for the State of Illinois.

(e) Prior interests. This Section does not affect the validity of any contract made between the State and an officer or employee of the State or member of the General Assembly, his or her spouse, minor child or any combination of those persons if that contract was in existence before his or her election or employment as an officer, member, or employee. The contract is voidable, however, if it cannot be completed within 365 days after the officer, member, or employee takes office or is employed.

The current salary of the Governor is \$177,412.00. Sixty percent of the salary is \$106,447.20.

## RETURN WITH BID

The bidder assures the Department that the award and execution of the contract would not cause a violation of Section 50-13, or that an effective exemption has been issued by the Board of Ethics to any individual subject to the Section 50-13 prohibitions pursuant to the provisions of Section 50-20 of the Code. Information concerning the exemption process is available from the Department upon request.

### **B. Negotiations**

Section 50-15. Negotiations.

It is unlawful for any person employed in or on a continual contractual relationship with any of the offices or agencies of State government to participate in contract negotiations on behalf of that office or agency with any firm, partnership, association, or corporation with whom that person has a contract for future employment or is negotiating concerning possible future employment.

The bidder assures the Department that the award and execution of the contract would not cause a violation of Section 50-15, and that the bidder has no knowledge of any facts relevant to the kinds of acts prohibited therein.

### **C. Inducements**

Section 50-25. Inducement.

Any person who offers or pays any money or other valuable thing to any person to induce him or her not to bid for a State contract or as recompense for not having bid on a State contract is guilty of a Class 4 felony. Any person who accepts any money or other valuable thing for not bidding for a State contract or who withholds a bid in consideration of the promise for the payment of money or other valuable thing is guilty of a Class 4 felony.

The bidder assures the Department that the award and execution of the contract would not cause a violation of Section 50-25, and that the bidder has no knowledge of any facts relevant to the kinds of acts prohibited therein.

### **D. Revolving Door Prohibition**

Section 50-30. Revolving door prohibition.

CPOs, SPOs, procurement compliance monitors, their designees whose principal duties are directly related to State procurement, and executive officers confirmed by the Senate are expressly prohibited for a period of 2 years after terminating an affected position from engaging in any procurement activity relating to the State agency most recently employing them in an affected position for a period of at least 6 months. The prohibition includes, but is not limited to: lobbying the procurement process; specifying; bidding; proposing bid, proposal, or contract documents; on their own behalf or on behalf of any firm, partnership, association, or corporation. This Section applies only to persons who terminate an affected position on or after January 15, 1999.

The bidder assures the Department that the award and execution of the contract would not cause a violation of Section 50-30, and that the bidder has no knowledge of any facts relevant to the kinds of acts prohibited therein.

### **E. Reporting Anticompetitive Practices**

Section 50-40. Reporting anticompetitive practices.

When, for any reason, any vendor, bidder, contractor, CPO, SPO, designee, elected official, or State employee suspects collusion or other anticompetitive practice among any bidders, offerors, contractors, proposers, or employees of the State, a notice of the relevant facts shall be transmitted to the Attorney General and the CPO.

The bidder assures the Department that it has not failed to report any relevant facts concerning the practices addressed in Section 50-40 which may involve the contract for which the bid is submitted.

### **F. Confidentiality**

Section 50-45. Confidentiality.

Any CPO, SPO, designee, or executive officer who willfully uses or allows the use of specifications, competitive bid documents, proprietary competitive information, proposals, contracts, or selection information to compromise the fairness or integrity of the procurement, bidding, or contract process shall be subject to immediate dismissal, regardless of the Personnel code, any contract, or any collective bargaining agreement, and may in addition be subject to criminal prosecution.

The bidder assures the Department that it has no knowledge of any fact relevant to the practices addressed in Section 50-45 which may involve the contract for which the bid is submitted.

## RETURN WITH BID

### G. Insider Information

Section 50-50. Insider information.

It is unlawful for any current or former elected or appointed State official or State employee to knowingly use confidential information available only by virtue of that office or employment for actual or anticipated gain for themselves or another person.

The bidder assures the Department that it has no knowledge of any facts relevant to the practices addressed in Section 50-50 which may involve the contract for which the bid is submitted.

I acknowledge, understand and accept these terms and conditions for the above assurances.

### III. CERTIFICATIONS

The certifications hereinafter made by the bidder are each a material representation of fact upon which reliance is placed should the Department enter into the contract with the bidder. Section 50-2 of the Code provides that every person that has entered into a multi-year contract and every subcontractor with a multi-year subcontract shall certify, by July 1 of each fiscal year covered by the contract after the initial fiscal year, to the responsible CPO whether it continues to satisfy the requirements of Article 50 pertaining to the eligibility for a contract award. If a contractor or subcontractor is not able to truthfully certify that it continues to meet all requirements, it shall provide with its certification a detailed explanation of the circumstances leading to the change in certification status. A contractor or subcontractor that makes a false statement material to any given certification required under Article 50 is, in addition to any other penalties or consequences prescribed by law, subject to liability under the Whistleblower Reward and Protection Act for submission of a false claim.

#### A. Bribery

Section 50-5. Bribery.

(a) Prohibition. No person or business shall be awarded a contract or subcontract under this Code who:

(1) has been convicted under the laws of Illinois or any other state of bribery or attempting to bribe an officer or employee of the State of Illinois or any other state in that officer's or employee's official capacity; or

(2) has made an admission of guilt of that conduct that is a matter of record but has not been prosecuted for that conduct.

(b) Businesses. No business shall be barred from contracting with any unit of State or local government, or subcontracting under such a contract, as a result of a conviction under this Section of any employee or agent of the business if the employee or agent is no longer employed by the business and:

(1) the business has been finally adjudicated not guilty; or

(2) the business demonstrates to the governmental entity with which it seeks to contract, or which is signatory to the contract which the subcontract relates, and that entity finds that the commission of the offense was not authorized, requested, commanded, or performed by a director, officer, or high managerial agent on behalf of the business as provided in paragraph (2) of subsection (a) of Section 5-4 of the Criminal Code of 2012.

(c) Conduct on behalf of business. For purposes of this Section, when an official, agent, or employee of a business committed the bribery or attempted bribery on behalf of the business and in accordance with the direction or authorization of a responsible official of the business, the business shall be chargeable with the conduct.

(d) Certification. Every bid submitted to and contract executed by the State, and every subcontract subject to Section 20-120 of the Code shall contain a certification by the contractor or the subcontractor, respectively, that the contractor or subcontractor is not barred from being awarded a contract or subcontract under this Section and acknowledges that the CPO may declare the related contract void if any certifications required by this Section are false. A contractor who makes a false statement, material to the certification, commits a Class 3 felony.

The contractor or subcontractor certifies that it is not barred from being awarded a contract under Section 50.5.

#### B. Felons

Section 50-10. Felons.

(a) Unless otherwise provided, no person or business convicted of a felony shall do business with the State of Illinois or any State agency, or enter into a subcontract, from the date of conviction until 5 years after the date of completion of the sentence for that felony, unless no person held responsible by a prosecutorial office for the facts upon which the conviction was based continues to have any involvement with the business.

(b) Certification. Every bid submitted to and contract executed by the State and every subcontract subject to Section 20-120 of the Code shall contain a certification by the bidder or contractor or subcontractor, respectively, that the bidder, contractor, or subcontractor is not barred from being awarded a contract or subcontract under this Section and acknowledges that the CPO may declare the related contract void if any of the certifications required by this Section are false.

## RETURN WITH BID

### **C. Debt Delinquency**

Section 50-11 and 50-12. Debt Delinquency.

The contractor or bidder or subcontractor, respectively, certifies that it, or any affiliate, is not barred from being awarded a contract or subcontract under the Code. Section 50-11 prohibits a person from entering into a contract with a State agency, or entering into a subcontract, if it knows or should know that it, or any affiliate, is delinquent in the payment of any debt to the State as defined by the Debt Collection Board. Section 50-12 prohibits a person from entering into a contract with a State agency, or entering into a subcontract, if it, or any affiliate, has failed to collect and remit Illinois Use Tax on all sales of tangible personal property into the State of Illinois in accordance with the provisions of the Illinois Use Tax Act. The bidder or contractor or subcontractor, respectively, further acknowledges that the CPO may declare the related contract void if this certification is false or if the bidder, contractor, or subcontractor, or any affiliate, is determined to be delinquent in the payment of any debt to the State during the term of the contract.

### **D. Prohibited Bidders, Contractors and Subcontractors**

Section 50-10.5 and 50-60(c). Prohibited bidders, contractors and subcontractors.

The bidder or contractor or subcontractor, respectively, certifies in accordance with 30 ILCS 500/50-10.5 that no officer, director, partner or other managerial agent of the contracting business has been convicted of a felony under the Sarbanes-Oxley Act of 2002 or a Class 3 or Class 2 felony under the Illinois Securities Law of 1953 or if in violation of Subsection (c) for a period of five years from the date of conviction. Every bid submitted to and contract executed by the State and every subcontract subject to Section 20-120 of the Code shall contain a certification by the bidder, contractor, or subcontractor, respectively, that the bidder, contractor, or subcontractor is not barred from being awarded a contract or subcontract under this Section and acknowledges that the CPO shall declare the related contract void if any of the certifications completed pursuant to this Section are false.

### **E. Section 42 of the Environmental Protection Act**

The bidder or contractor or subcontractor, respectively, certifies in accordance with 30 ILCS 500/50-14 that the bidder, contractor, or subcontractor, is not barred from being awarded a contract or entering into a subcontract under this Section which prohibits the bidding on or entering into contracts with the State of Illinois or a State agency, or entering into any subcontract, that is subject to the Code by a person or business found by a court or the Pollution Control Board to have committed a willful or knowing violation of Section 42 of the Environmental Protection Act for a period of five years from the date of the order. The bidder or contractor or subcontractor, respectively, acknowledges that the CPO may declare the contract void if this certification is false.

### **F. Educational Loan**

Section 3 of the Educational Loan Default Act provides no State agency shall contract with an individual for goods or services if that individual is in default, as defined in Section 2 of this Act, on an educational loan. Any contract used by any State agency shall include a statement certifying that the individual is not in default on an educational loan as provided in this Section.

The bidder, if an individual as opposed to a corporation, partnership or other form of business organization, certifies that the bidder is not in default on an educational loan as provided in Section 3 of the Act.

### **G. Bid-Rigging/Bid Rotating**

Section 33E-11 of the Criminal Code of 2012 provides:

(a) Every bid submitted to and public contract executed pursuant to such bid by the State or a unit of local government shall contain a certification by the prime contractor that the prime contractor is not barred from contracting with any unit of State or local government as a result of a violation of either Section 33E-3 or 33E-4 of this Article.

(b) A contractor who makes a false statement, material to the certification, commits a Class 3 felony.

A violation of Section 33E-3 would be represented by a conviction of the crime of bid-rigging which, in addition to Class 3 felony sentencing, provides that any person convicted of this offense or any similar offense of any state or the United States which contains the same elements as this offense shall be barred for 5 years from the date of conviction from contracting with any unit of State or local government. No corporation shall be barred from contracting with any unit of State or local government as a result of a conviction under this Section of any employee or agent of such corporation if the employee so convicted is no longer employed by the corporation and: (1) it has been finally adjudicated not guilty or (2) if it demonstrates to the governmental entity with which it seeks to contract and that entity finds that the commission of the offense was neither authorized, requested, commanded, nor performed by a director, officer or a high managerial agent in behalf of the corporation.

## RETURN WITH BID

A violation of Section 33E-4 would be represented by a conviction of the crime of bid-rotating which, in addition to Class 2 felony sentencing, provides that any person convicted of this offense or any similar offense of any state or the United States which contains the same elements as this offense shall be permanently barred from contracting with any unit of State or local government. No corporation shall be barred from contracting with any unit of State or local government as a result of a conviction under this Section of any employee or agent of such corporation if the employee so convicted is no longer employed by the corporation and: (1) it has been finally adjudicated not guilty or (2) if it demonstrates to the governmental entity with which it seeks to contract and that entity finds that the commission of the offense was neither authorized, requested, commanded, nor performed by a director, officer or a high managerial agent in behalf of the corporation.

The bidder certifies that it is not barred from contracting with the Department by reason of a violation of either Section 33E-3 or Section 33E-4.

### **H. International Anti-Boycott**

Section 5 of the International Anti-Boycott Certification Act provides every contract entered into by the State of Illinois for the manufacture, furnishing, or purchasing of supplies, material, or equipment or for the furnishing of work, labor, or services, in an amount exceeding the threshold for small purchases according to the purchasing laws of this State or \$10,000.00, whichever is less, shall contain certification, as a material condition of the contract, by which the contractor agrees that neither the contractor nor any substantially-owned affiliated company is participating or shall participate in an international boycott in violation of the provisions of the U.S. Export Administration Act of 1979 or the regulations of the U.S. Department of Commerce promulgated under that Act.

The bidder makes the certification set forth in Section 5 of the Act.

### **I. Drug Free Workplace**

The Illinois "Drug Free Workplace Act" applies to this contract and it is necessary to comply with the provisions of the "Act" if the contractor is a corporation, partnership, or other entity (including a sole proprietorship) which has 25 or more employees.

The bidder certifies that if awarded a contract in excess of \$5,000 it will provide a drug free workplace in compliance with the provisions of the Act.

### **J. Disclosure of Business Operations in Iran**

Section 50-36 of the Code, 30ILCS 500/50-36 provides that each bid, offer, or proposal submitted for a State contract shall include a disclosure of whether or not the Company acting as the bidder, offeror, or proposing entity, or any of its corporate parents or subsidiaries, within the 24 months before submission of the bid, offer, or proposal had business operations that involved contracts with or provision of supplies or services to the Government of Iran, companies in which the Government of Iran has any direct or indirect equity share, consortiums or projects commissioned by the Government of Iran, or companies involved in consortiums or projects commissioned by the Government of Iran and either of the following conditions apply:

- (1) More than 10% of the Company's revenues produced in or assets located in Iran involve oil-related activities or mineral-extraction activities; less than 75% of the Company's revenues produced in or assets located in Iran involve contracts with or provision of oil-related or mineral-extraction products or services to the Government of Iran or a project or consortium created exclusively by that government; and the Company has failed to take substantial action.
- (2) The Company has, on or after August 5, 1996, made an investment of \$20 million or more, or any combination of investments of at least \$10 million each that in the aggregate equals or exceeds \$20 million in any 12-month period, which directly or significantly contributes to the enhancement of Iran's ability to develop petroleum resources of Iran.

The terms "Business operations", "Company", "Mineral-extraction activities", "Oil-related activities", "Petroleum resources", and "Substantial action" are all defined in the Code.

Failure to make the disclosure required by the Code shall cause the bid, offer or proposal to be considered not responsive. The disclosure will be considered when evaluating the bid or awarding the contract. The name of each Company disclosed as doing business or having done business in Iran will be provided to the State Comptroller.

Check the appropriate statement:

Company has no business operations in Iran to disclose.

Company has business operations in Iran as disclosed the attached document.

## RETURN WITH BID

### **K. Apprenticeship and Training Certification (Does not apply to federal aid projects)**

In accordance with the provisions of Section 30-22 (6) of the Code, the bidder certifies that it is a participant, either as an individual or as part of a group program, in the approved apprenticeship and training programs applicable to each type of work or craft that the bidder will perform with its own forces. The bidder further certifies for work that will be performed by subcontract that each of its subcontractors submitted for approval either (a) is, at the time of such bid, participating in an approved, applicable apprenticeship and training program; or (b) will, prior to commencement of performance of work pursuant to this contract, begin participation in an approved apprenticeship and training program applicable to the work of the subcontract. The Department, at any time before or after award, may require the production of a copy of each applicable Certificate of Registration issued by the United States Department of Labor evidencing such participation by the contractor and any or all of its subcontractors. Applicable apprenticeship and training programs are those that have been approved and registered with the United States Department of Labor. The bidder shall list in the space below, the official name of the program sponsor holding the Certificate of Registration for all of the types of work or crafts in which the bidder is a participant and that will be performed with the bidder's forces. Types of work or craft work that will be subcontracted shall be included and listed as subcontract work. The list shall also indicate any type of work or craft job category that does not have an applicable apprenticeship or training program. **The bidder is responsible for making a complete report and shall make certain that each type of work or craft job category that will be utilized on the project as reported on the Construction Employee Workforce Projection (Form BC-1256) and returned with the bid is accounted for and listed.**

**NA-FEDERAL**

---

---

---

The requirements of this certification and disclosure are a material part of the contract, and the contractor shall require this certification provision to be included in all approved subcontracts. In order to fulfill this requirement, it shall not be necessary that an applicable program sponsor be currently taking or that it will take applications for apprenticeship, training or employment during the performance of the work of this contract.



**RETURN WITH BID**

**L. Political Contributions and Registration with the State Board of Elections**

Sections 20-160 and 50-37 of the Code regulate political contributions from business entities and any affiliated entities or affiliated persons bidding on or contracting with the state. Generally under Section 50-37, any business entity, and any affiliated entity or affiliated person of the business entity, whose current year contracts with all state agencies exceed an awarded value of \$50,000, are prohibited from making any contributions to any political committees established to promote the candidacy of the officeholder responsible for the awarding of the contracts or any other declared candidate for that office for the duration of the term of office of the incumbent officeholder or a period 2 years after the termination of the contract, whichever is longer. Any business entity and affiliated entities or affiliated persons whose state contracts in the current year do not exceed an awarded value of \$50,000, but whose aggregate pending bids and proposals on state contracts exceed \$50,000, either alone or in combination with contracts not exceeding \$50,000, are prohibited from making any political contributions to any political committee established to promote the candidacy of the officeholder responsible for awarding the pending contract during the period beginning on the date the invitation for bids or request for proposals is issued and ending on the day after the date of award or selection if the entity was not awarded or selected. Section 20-160 requires certification of registration of affected business entities in accordance with procedures found in Section 9-35 of The Election Code.

By submission of a bid, the contractor business entity acknowledges and agrees that it has read and understands Sections 20-160 and 50-37 of the Code, and that it makes the following certification:

**The undersigned bidder certifies that it has registered as a business with the State Board of Elections and acknowledges a continuing duty to update the registration in accordance with the above referenced statutes. If the business entity is required to register, the CPO shall verify that it is in compliance on the date the bid or proposal is due. The CPO shall not accept a bid or proposal if the business entity is not in compliance with the registration requirements.**

These requirements and compliance with the above referenced statutory sections are a material part of the contract, and any breach thereof shall be cause to void the contract under Section 50-60 of the Code. This provision does not apply to Federal-aid contracts.

**M. Lobbyist Disclosure**

Section 50-38 of the Code requires that any bidder or offeror on a State contract that hires a person required to register under the Lobbyist Registration Act to assist in obtaining a contract shall:

- (i) Disclose all costs, fees, compensation, reimbursements, and other remunerations paid or to be paid to the lobbyist related to the contract,
- (ii) Not bill or otherwise cause the State of Illinois to pay for any of the lobbyist's costs, fees, compensation, reimbursements, or other remuneration, and
- (iii) Sign a verification certifying that none of the lobbyist's costs, fees, compensation, reimbursements, or other remuneration were billed to the State.

This information, along with all supporting documents, shall be filed with the agency awarding the contract and with the Secretary of State. The CPO shall post this information, together with the contract award notice, in the online Procurement Bulletin.

Pursuant to Subsection (c) of this Section, no person or entity shall retain a person or entity to attempt to influence the outcome of a procurement decision made under the Code for compensation contingent in whole or in part upon the decision or procurement. Any person who violates this subsection is guilty of a business offense and shall be fined not more than \$10,000.

Bidder acknowledges that it is required to disclose the hiring of any person required to register pursuant to the Illinois Lobbyist Registration Act (25 ILCS 170) in connection with this contract.

Bidder has not hired any person required to register pursuant to the Illinois Lobbyist Registration Act in connection with this contract.

Or

Bidder has hired the following persons required to register pursuant to the Illinois Lobbyist Registration Act in connection with the contract:

Name and address of person: \_\_\_\_\_  
All costs, fees, compensation, reimbursements and other remuneration paid to said person: \_\_\_\_\_  
\_\_\_\_\_  
\_\_\_\_\_

I acknowledge, understand and accept these terms and conditions for the above certifications.

## RETURN WITH BID

### IV. DISCLOSURES

- A. The disclosures hereinafter made by the bidder are each a material representation of fact upon which reliance is placed should the Department enter into the contract with the bidder. The bidder further certifies that the Department has received the disclosure forms for each bid.

The CPO may void the bid, or contract, respectively, if it is later determined that the bidder or subcontractor rendered a false or erroneous disclosure. A contractor or subcontractor may be suspended or debarred for violations of the Code. Furthermore, the CPO may void the contract and the surety providing the performance bond shall be responsible for completion of the contract.

### B. Financial Interests and Conflicts of Interest

1. Section 50-35 of the Code provides that all bids of more than \$25,000 shall be accompanied by disclosure of the financial interests of the bidder. This disclosed information for the successful bidder, will be maintained as public information subject to release by request pursuant to the Freedom of Information Act, filed with the Procurement Policy Board, and shall be incorporated as a material term of the contract. Furthermore, pursuant to Section 5-5, the Procurement Policy Board may review a proposal, bid, or contract and issue a recommendation to void a contract or reject a proposal or bid based on any violation of the Code or the existence of a conflict of interest as provided in subsections (b) and (d) of Section 50-35.

The financial interests to be disclosed shall include ownership or distributive income share that is in excess of 5%, or an amount greater than 60% of the annual salary of the Governor, of the bidding entity or its parent entity, whichever is less, unless the contractor or bidder is a publicly traded entity subject to Federal 10K reporting, in which case it may submit its 10K disclosure in place of the prescribed disclosure. If a bidder is a privately held entity that is exempt from Federal 10K reporting, but has more than 200 shareholders, it may submit the information that Federal 10K companies are required to report, and list the names of any person or entity holding any ownership share that is in excess of 5%. The disclosure shall include the names, addresses, and dollar or proportionate share of ownership of each person making the disclosure, their instrument of ownership or beneficial relationship, and notice of any potential conflict of interest resulting from the current ownership or beneficial interest of each person making the disclosure having any of the relationships identified in Section 50-35 and on the disclosure form.  
**The current annual salary of the Governor is \$177,412.00.**

In addition, all disclosures shall indicate any other current or pending contracts, proposals, leases, or other ongoing procurement relationships the bidding entity has with any other unit of state government and shall clearly identify the unit and the contract, proposal, lease, or other relationship.

2. Disclosure Forms. Disclosure Form A is attached for use concerning the individuals meeting the above ownership or distributive share requirements. A separate Disclosure Form A must be submitted with the bid for each individual meeting the above requirements. In addition, a second form (Disclosure Form B) provides for the disclosure of current or pending procurement relationships with other (non-IDOT) state agencies and a total ownership certification. **The forms must be included with each bid.**

### C. Disclosure Form Instructions

#### Form A Instructions for Financial Information & Potential Conflicts of Interest

If the bidder is a publicly traded entity subject to Federal 10K reporting, the 10K Report may be submitted to meet the requirements of Form A. If a bidder is a privately held entity that is exempt from Federal 10K reporting, but has more than 200 shareholders, it may submit the information that Federal 10K companies are required to report, and list the names of any person or entity holding any ownership share that is in excess of 5%. If a bidder is not subject to Federal 10K reporting, the bidder must determine if any individuals are required by law to complete a financial disclosure form. To do this, the bidder should answer each of the following questions. A "YES" answer indicates Form A must be completed. If the answer to each of the following questions is "NO", then the NOT APPLICABLE STATEMENT on Form A must be signed and dated by a person that is authorized to execute contracts for the bidding company. Note: These questions are for assistance only and are not required to be completed.

1. Does anyone in your organization have a direct or beneficial ownership share of greater than 5% of the bidding entity or parent entity? YES \_\_\_ NO \_\_\_
2. Does anyone in your organization have a direct or beneficial ownership share of less than 5%, but which has a value greater than 60% of the annual salary of the Governor? YES \_\_\_ NO \_\_\_
3. Does anyone in your organization receive more than 60% of the annual salary of the Governor of the bidding entity's or parent entity's distributive income? YES \_\_\_ NO \_\_\_
4. Does anyone in your organization receive greater than 5% of the bidding entity's or parent entity's total distributive income, but which is less than 60% of the annual salary of the Governor? YES \_\_\_ NO \_\_\_

(Note: Only one set of forms needs to be completed per person per bid even if a specific individual would require a yes answer to more than one question.)

A "YES" answer to any of these questions requires the completion of Form A. The bidder must determine each individual in the bidding entity or the bidding entity's parent company that would cause the questions to be answered "Yes". Each form must be signed and dated by a person that is authorized to execute contracts for your organization. **Photocopied or stamped signatures are not acceptable.** The person signing can be, but does not have to be, the person for which the form is being completed. The bidder is responsible for the accuracy of any information provided.

If the answer to each of the above questions is "NO", then the NOT APPLICABLE STATEMENT of Form A must be signed and dated by a person that is authorized to execute contracts for your company.

## RETURN WITH BID

### **Form B: Instructions for Identifying Other Contracts & Procurement Related Information**

Disclosure Form B must be completed for each bid submitted by the bidding entity. *Note: Checking the NOT APPLICABLE STATEMENT on Form A does not allow the bidder to ignore Form B. Form B must be completed, checked, and dated or the bidder may be considered nonresponsive and the bid will not be accepted.*

The Bidder shall identify, by checking Yes or No on Form B, whether it has any pending contracts (including leases), bids, proposals, or other ongoing procurement relationship with any other (non-IDOT) State of Illinois agency. If "No" is checked, the bidder only needs to complete the check box on the bottom of Form B. If "Yes" is checked, the bidder must do one of the following:

Option I: If the bidder did not submit an Affidavit of Availability to obtain authorization to bid, the bidder must list all non-IDOT State of Illinois agency pending contracts, leases, bids, proposals, and other ongoing procurement relationships. These items may be listed on Form B or on an attached sheet(s). Do not include IDOT contracts. Contracts with cities, counties, villages, etc. are not considered State of Illinois agency contracts and are not to be included. Contracts with other State of Illinois agencies such as the Department of Natural Resources or the Capital Development Board must be included. Bidders who submit Affidavits of Availability are suggested to use Option II.

Option II: If the bidder is required and has submitted an Affidavit of Availability in order to obtain authorization to bid, the bidder may write or type "See Affidavit of Availability" which indicates that the Affidavit of Availability is incorporated by reference and includes all non-IDOT State of Illinois agency pending contracts, leases, bids, proposals, and other ongoing procurement relationships. For any contracts that are not covered by the Affidavit of Availability, the bidder must identify them on Form B or on an attached sheet(s). These might be such things as leases.

RETURN WITH BID

ILLINOIS DEPARTMENT OF TRANSPORTATION

Form A Financial Information & Potential Conflicts of Interest Disclosure

Contractor Name, Legal Address, City, State, Zip, Telephone Number, Email Address, Fax Number (if available)

Disclosure of the information contained in this Form is required by the Section 50-35 of the Code (30 ILCS 500). Vendors desiring to enter into a contract with the State of Illinois must disclose the financial information and potential conflict of interest information as specified in this Disclosure Form. This information shall become part of the publicly available contract file. This Form A must be completed for bids in excess of \$25,000, and for all open-ended contracts. A publicly traded company may submit a 10K disclosure (or equivalent if applicable) in satisfaction of the requirements set forth in Form A. See Disclosure Form Instructions.

The current annual salary of the Governor is \$177,412.00.

DISCLOSURE OF FINANCIAL INFORMATION

- 1. Disclosure of Financial Information. The individual named below has an interest in the BIDDER (or its parent) in terms of ownership or distributive income share in excess of 5%, or an interest which has a value of more than 60% of the annual salary of the Governor. (Make copies of this form as necessary and attach a separate Disclosure Form A for each individual meeting these requirements)

FOR INDIVIDUAL (type or print information) NAME: ADDRESS Type of ownership/distributable income share: stock sole proprietorship Partnership other: (explain on separate sheet): % or \$ value of ownership/distributable income share:

- 2. Disclosure of Potential Conflicts of Interest. Check "Yes" or "No" to indicate which, if any, of the following potential conflict of interest relationships apply. If the answer to any question is "Yes", please attach additional pages and describe.

(a) State employment, currently or in the previous 3 years, including contractual employment of services. Yes \_\_\_ No \_\_\_

If your answer is yes, please answer each of the following questions.

- 1. Are you currently an officer or employee of either the Capitol Development Board or the Illinois State Toll Highway Authority? Yes \_\_\_ No \_\_\_
2. Are you currently appointed to or employed by any agency of the State of Illinois? If you are currently appointed to or employed by any agency of the State of Illinois, and your annual salary exceeds 60% of the annual salary of the Governor provide the name the State agency for which you are employed and your annual salary.

**RETURN WITH BID**

3. If you are currently appointed to or employed by any agency of the State of Illinois, and your annual salary exceeds 60% of the annual salary of the Governor, are you entitled to receive (i) more than 7 1/2% of the total distributable income of your firm, partnership, association or corporation, or (ii) an amount in excess of 100% of the annual salary of the Governor? Yes \_\_\_ No \_\_\_
4. If you are currently appointed to or employed by any agency of the State of Illinois, and your annual salary exceeds 60% of the annual salary of the Governor, are you and your spouse or minor children entitled to receive (i) more than 15% in aggregate of the total distributable income of your firm, partnership, association or corporation, or (ii) an amount in excess of two times the salary of the Governor? Yes \_\_\_ No \_\_\_

---

(b) State employment of spouse, father, mother, son, or daughter, including contractual employment for services in the previous 2 years.

Yes \_\_\_ No \_\_\_

If your answer is yes, please answer each of the following questions.

1. Is your spouse or any minor children currently an officer or employee of the Capitol Development Board or the Illinois State Toll Highway Authority? Yes \_\_\_ No \_\_\_
2. Is your spouse or any minor children currently appointed to or employed by any agency of the State of Illinois? If your spouse or minor children is/are currently appointed to or employed by any agency of the State of Illinois, and his/her annual salary exceeds 60% of the annual salary of the Governor, provide the name of the spouse and/or minor children, the name of the State agency for which he/she is employed and his/her annual salary. \_\_\_\_\_
- 
3. If your spouse or any minor children is/are currently appointed to or employed by any agency of the State of Illinois, and his/her annual salary exceeds 60% of the annual salary of the Governor, are you entitled to receive (i) more than 7 1/2% of the total distributable income of your firm, partnership, association or corporation, or (ii) an amount in excess 100% of the annual salary of the Governor? Yes \_\_\_ No \_\_\_
4. If your spouse or any minor children are currently appointed to or employed by any agency of the State of Illinois, and his/her annual salary exceeds 60% of the annual salary of the Governor, are you and your spouse or any minor children entitled to receive (i) more than 15% in the aggregate of the total distributable income from your firm, partnership, association or corporation, or (ii) an amount in excess of two times the salary of the Governor? Yes \_\_\_ No \_\_\_

---

(c) Elective status; the holding of elective office of the State of Illinois, the government of the United States, any unit of local government authorized by the Constitution of the State of Illinois or the statutes of the State of Illinois currently or in the previous 3 years. Yes \_\_\_ No \_\_\_

---

(d) Relationship to anyone holding elective office currently or in the previous 2 years; spouse, father, mother, son, or daughter. Yes \_\_\_ No \_\_\_

---

(e) Appointive office; the holding of any appointive government office of the State of Illinois, the United State of America, or any unit of local government authorized by the Constitution of the State of Illinois or the statutes of the State of Illinois, which office entitles the holder to compensation in excess of the expenses incurred in the discharge of that office currently or in the previous 3 years. Yes \_\_\_ No \_\_\_

---

(f) Relationship to anyone holding appointive office currently or in the previous 2 years; spouse, father, mother, son, or daughter. Yes \_\_\_ No \_\_\_

---

(g) Employment, currently or in the previous 3 years, as or by any registered lobbyist of the State government. Yes \_\_\_ No \_\_\_

---

**RETURN WITH BID**

(h) Relationship to anyone who is or was a registered lobbyist in the previous 2 years; spouse, father, mother, son, or daughter. Yes \_\_\_ No \_\_\_

---

(i) Compensated employment, currently or in the previous 3 years, by any registered election or reelection committee registered with the Secretary of State or any county clerk of the State of Illinois, or any political action committee registered with either the Secretary of State or the Federal Board of Elections. Yes \_\_\_ No \_\_\_

---

(j) Relationship to anyone; spouse, father, mother, son, or daughter; who was a compensated employee in the last 2 years by any registered election or re-election committee registered with the Secretary of State or any county clerk of the State of Illinois, or any political action committee registered with either the Secretary of State or the Federal Board of Elections. Yes \_\_\_ No \_\_\_

---

**3. Communication Disclosure.**

Disclose the name and address of each lobbyist and other agent of the bidder or offeror who is not identified in Section 2 of this form, who is has communicated, is communicating, or may communicate with any State officer or employee concerning the bid or offer. This disclosure is a continuing obligation and must be promptly supplemented for accuracy throughout the process and throughout the term of the contract. If no person is identified, enter "None" on the line below:

Name and address of person(s): \_\_\_\_\_  
\_\_\_\_\_  
\_\_\_\_\_  
\_\_\_\_\_

**RETURN WITH BID**

**4. Debarment Disclosure.** For each of the persons identified under Sections 2 and 3 of this form, disclose whether any of the following has occurred within the previous 10 years: debarment from contracting with any governmental entity; professional licensure discipline; bankruptcies; adverse civil judgments and administrative findings; and criminal felony convictions. This disclosure is a continuing obligation and must be promptly supplemented for accuracy throughout the procurement process and term of the contract. If no person is identified, enter "None" on the line below:

Name of person(s): \_\_\_\_\_

Nature of disclosure: \_\_\_\_\_  
\_\_\_\_\_  
\_\_\_\_\_

**APPLICABLE STATEMENT**

**This Disclosure Form A is submitted on behalf of the INDIVIDUAL named on previous page. Under penalty of perjury, I certify the contents of this disclosure to be true and accurate to the best of my knowledge.**

Completed by:  \_\_\_\_\_  
Signature of Individual or Authorized Representative Date

**NOT APPLICABLE STATEMENT**

**Under penalty of perjury, I have determined that no individuals associated with this organization meet the criteria that would require the completion of this Form A.**

**This Disclosure Form A is submitted on behalf of the CONTRACTOR listed on the previous page.**

\_\_\_\_\_  
Signature of Authorized Representative Date

The bidder has a continuing obligation to supplement these disclosures under Sec. 50-35 of the Code.

RETURN WITH BID

ILLINOIS DEPARTMENT OF TRANSPORTATION

Form B Other Contracts & Financial Related Information Disclosure

Contractor Name, Legal Address, City, State, Zip, Telephone Number, Email Address, Fax Number (if available)

Disclosure of the information contained in this Form is required by the Section 50-35 of the Code (30 ILCS 500). This information shall become part of the publicly available contract file. This Form B must be completed for bids in excess of \$25,000, and for all open-ended contracts.

DISCLOSURE OF OTHER CONTRACTS AND PROCUREMENT RELATED INFORMATION

1. Identifying Other Contracts & Procurement Related Information. The BIDDER shall identify whether it has any pending contracts (including leases), bids, proposals, or other ongoing procurement relationship with any other State of Illinois agency: Yes \_\_\_ No \_\_\_

If "No" is checked, the bidder only needs to complete the signature box on the bottom of this page.

2. If "Yes" is checked. Identify each such relationship by showing State of Illinois agency name and other descriptive information such as bid or project number (attach additional pages as necessary). SEE DISCLOSURE FORM INSTRUCTIONS:

THE FOLLOWING STATEMENT MUST BE CHECKED

Signature of Authorized Representative, Date

OWNERSHIP CERTIFICATION

Please certify that the following statement is true if the individuals for all submitted Form A disclosures do not total 100% of ownership.

Any remaining ownership interest is held by individuals receiving less than \$106,447.20 of the bidding entity's or parent entity's distributive income or holding less than a 5% ownership interest.

Yes No N/A (Form A disclosure(s) established 100% ownership)



## **RETURN WITH BID**

### **SPECIAL NOTICE TO CONTRACTORS**

The following requirements of the Illinois Department of Human Rights' Rules and Regulations are applicable to bidders on all construction contracts advertised by the Illinois Department of Transportation:

#### **CONSTRUCTION EMPLOYEE UTILIZATION PROJECTION**

- (a) All bidders on construction contracts shall complete and submit, along with and as part of their bids, a Bidder's Employee Utilization Form (Form BC-1256) setting forth a projection and breakdown of the total workforce intended to be hired and/or allocated to such contract work by the bidder including a projection of minority and female employee utilization in all job classifications on the contract project.
- (b) The Department of Transportation shall review the Employee Utilization Form, and workforce projections contained therein, of the contract awardee to determine if such projections reflect an underutilization of minority persons and/or women in any job classification in accordance with the Equal Employment Opportunity Clause and Section 7.2 of the Illinois Department of Human Rights' Rules and Regulations for Public Contracts adopted as amended on September 17, 1980. If it is determined that the contract awardee's projections reflect an underutilization of minority persons and/or women in any job classification, it shall be advised in writing of the manner in which it is underutilizing and such awardee shall be considered to be in breach of the contract unless, prior to commencement of work on the contract project, it submits revised satisfactory projections or an acceptable written affirmative action plan to correct such underutilization including a specific timetable geared to the completion stages of the contract.
- (c) The Department of Transportation shall provide to the Department of Human Rights a copy of the contract awardee's Employee Utilization Form, a copy of any required written affirmative action plan, and any written correspondence related thereto. The Department of Human Rights may review and revise any action taken by the Department of Transportation with respect to these requirements.



RETURN WITH BID

Contract No. 91491  
 EDGAR County  
 Section 10-00105-02-RS  
 Project RS-0679(111)  
 Route FAS 679 (Ch 8)  
 District 5 Construction Funds

**PART I. IDENTIFICATION**

Dept. Human Rights # \_\_\_\_\_ Duration of Project: \_\_\_\_\_

Name of Bidder: \_\_\_\_\_

**PART II. WORKFORCE PROJECTION**

A. The undersigned bidder has analyzed minority group and female populations, unemployment rates and availability of workers for the location in which this contract work is to be performed, and for the locations from which the bidder recruits employees, and hereby submits the following workforce projection including a projection for minority and female employee utilization in all job categories in the workforce to be allocated to this contract:

TABLE A

TABLE B

| TOTAL Workforce Projection for Contract |                 |   |                    |          |   |               |   |             |          |                     |   |   |
|---|-----------------|---|--------------------|----------|---|---------------|---|-------------|----------|---------------------|---|---|
| JOB CATEGORIES                          | TOTAL EMPLOYEES |   | MINORITY EMPLOYEES |          |   |               |   |             | TRAINEES |                     |   |   |
|   | M               | F | BLACK              | HISPANIC |   | *OTHER MINOR. |   | APPRENTICES |          | ON THE JOB TRAINEES |   |   |
|   | M               | F | M                  | F        | M | F             | M | F           | M        | F                   | M | F |
| OFFICIALS (MANAGERS)                    |                 |   |                    |          |   |               |   |             |          |                     |   |   |
| SUPERVISORS                             |                 |   |                    |          |   |               |   |             |          |                     |   |   |
| FOREMEN                                 |                 |   |                    |          |   |               |   |             |          |                     |   |   |
| CLERICAL                                |                 |   |                    |          |   |               |   |             |          |                     |   |   |
| EQUIPMENT OPERATORS                     |                 |   |                    |          |   |               |   |             |          |                     |   |   |
| MECHANICS                               |                 |   |                    |          |   |               |   |             |          |                     |   |   |
| TRUCK DRIVERS                           |                 |   |                    |          |   |               |   |             |          |                     |   |   |
| IRONWORKERS                             |                 |   |                    |          |   |               |   |             |          |                     |   |   |
| CARPENTERS                              |                 |   |                    |          |   |               |   |             |          |                     |   |   |
| CEMENT MASONS                           |                 |   |                    |          |   |               |   |             |          |                     |   |   |
| ELECTRICIANS                            |                 |   |                    |          |   |               |   |             |          |                     |   |   |
| PIPEFITTERS, PLUMBERS                   |                 |   |                    |          |   |               |   |             |          |                     |   |   |
| PAINTERS                                |                 |   |                    |          |   |               |   |             |          |                     |   |   |
| LABORERS, SEMI-SKILLED                  |                 |   |                    |          |   |               |   |             |          |                     |   |   |
| LABORERS, UNSKILLED                     |                 |   |                    |          |   |               |   |             |          |                     |   |   |
| TOTAL                                   |                 |   |                    |          |   |               |   |             |          |                     |   |   |

| CURRENT EMPLOYEES TO BE ASSIGNED TO CONTRACT |   |                    |   |
|--|---|--------------------|---|
| TOTAL EMPLOYEES                              |   | MINORITY EMPLOYEES |   |
| M  | F | M                  | F |
|  |   |                    |   |
|  |   |                    |   |
|  |   |                    |   |
|  |   |                    |   |
|  |   |                    |   |
|  |   |                    |   |
|  |   |                    |   |
|  |   |                    |   |
|  |   |                    |   |
|  |   |                    |   |
|  |   |                    |   |
|  |   |                    |   |
|  |   |                    |   |
|  |   |                    |   |
|  |   |                    |   |
|  |   |                    |   |
|  |   |                    |   |
|  |   |                    |   |
|  |   |                    |   |
|  |   |                    |   |
|  |   |                    |   |
|  |   |                    |   |
|  |   |                    |   |
|  |   |                    |   |
|  |   |                    |   |
|  |   |                    |   |
|  |   |                    |   |
|  |   |                    |   |
|  |   |                    |   |
|  |   |                    |   |
|  |   |                    |   |
|  |   |                    |   |

TABLE C

| TOTAL Training Projection for Contract |                 |   |       |   |          |   |               |   |
|--|-----------------|---|-------|---|----------|---|---------------|---|
| EMPLOYEES IN TRAINING                  | TOTAL EMPLOYEES |   | BLACK |   | HISPANIC |   | *OTHER MINOR. |   |
|  | M               | F | M     | F | M        | F | M             | F |
| APPRENTICES                            |                 |   |       |   |          |   |               |   |
| ON THE JOB TRAINEES                    |                 |   |       |   |          |   |               |   |

\*Other minorities are defined as Asians (A) or Native Americans (N).  
 Please specify race of each employee shown in Other Minorities column.

FOR DEPARTMENT USE ONLY

Note: See instructions on page 2

**RETURN WITH BID**

**Contract No. 91491  
EDGAR County  
Section 10-00105-02-RS  
Project RS-0679(111)  
Route FAS 679 (Ch 8)  
District 5 Construction Funds**

**PART II. WORKFORCE PROJECTION - continued**

- B. Included in "Total Employees" under Table A is the total number of **new hires** that would be employed in the event the undersigned bidder is awarded this contract.

The undersigned bidder projects that: (number) \_\_\_\_\_ new hires would be recruited from the area in which the contract project is located; and/or (number) \_\_\_\_\_ new hires would be recruited from the area in which the bidder's principal office or base of operation is located.

- C. Included in "Total Employees" under Table A is a projection of numbers of persons to be employed directly by the undersigned bidder as well as a projection of numbers of persons to be employed by subcontractors.

The undersigned bidder estimates that (number) \_\_\_\_\_ persons will be directly employed by the prime contractor and that (number) \_\_\_\_\_ persons will be employed by subcontractors.

**PART III. AFFIRMATIVE ACTION PLAN**

- A. The undersigned bidder understands and agrees that in the event the foregoing minority and female employee utilization projection included under **PART II** is determined to be an underutilization of minority persons or women in any job category, and in the event that the undersigned bidder is awarded this contract, he/she will, prior to commencement of work, develop and submit a written Affirmative Action Plan including a specific timetable (geared to the completion stages of the contract) whereby deficiencies in minority and/or female employee utilization are corrected. Such Affirmative Action Plan will be subject to approval by the contracting agency and the **Department of Human Rights**.
- B. The undersigned bidder understands and agrees that the minority and female employee utilization projection submitted herein, and the goals and timetable included under an Affirmative Action Plan if required, are deemed to be part of the contract specifications.

Company \_\_\_\_\_

Telephone Number \_\_\_\_\_

Address \_\_\_\_\_

**NOTICE REGARDING SIGNATURE**

The Bidder's signature on the Proposal Signature Sheet will constitute the signing of this form. The following signature block needs to be completed only if revisions are required.

Signature:  \_\_\_\_\_ Title: \_\_\_\_\_ Date: \_\_\_\_\_

- Instructions: All tables must include subcontractor personnel in addition to prime contractor personnel.
- Table A - Include both the number of employees that would be hired to perform the contract work and the total number currently employed (Table B) that will be allocated to contract work, and include all apprentices and on-the-job trainees. The "Total Employees" column should include all employees including all minorities, apprentices and on-the-job trainees to be employed on the contract work.
- Table B - Include all employees currently employed that will be allocated to the contract work including any apprentices and on-the-job trainees currently employed.
- Table C - Indicate the racial breakdown of the total apprentices and on-the-job trainees shown in Table A.

**RETURN WITH BID**

**ADDITIONAL FEDERAL REQUIREMENTS**

In addition to the Required Contract Provisions for Federal-Aid Construction Contracts (FHWA 1273), all bidders make the following certifications.

- A. By the execution of this proposal, the signing bidder certifies that the bidding entity has not, either directly or indirectly, entered into any agreement, participated in any collusion, or otherwise taken any action, in restraint of free competitive bidding in connection with the submitted bid. This statement made by the undersigned bidder is true and correct under penalty of perjury under the laws of the United States.
- B. CERTIFICATION, EQUAL EMPLOYMENT OPPORTUNITY:
1. Have you participated in any previous contracts or subcontracts subject to the equal opportunity clause. YES \_\_\_\_\_ NO \_\_\_\_\_
  2. If answer to #1 is yes, have you filed with the Joint Reporting Committee, the Director of OFCC, any Federal agency, or the former President's Committee on Equal Employment Opportunity, all reports due under the applicable filing requirements of those organizations? YES \_\_\_\_\_ NO \_\_\_\_\_

**RETURN WITH BID**

**Contract No. 91491  
EDGAR County  
Section 10-00105-02-RS  
Project RS-0679(111)  
Route FAS 679 (Ch 8)  
District 5 Construction Funds**

PROPOSAL SIGNATURE SHEET

The undersigned bidder hereby makes and submits this bid on the subject Proposal, thereby assuring the Department that all requirements of the Invitation for Bids and rules of the Department have been met, that there is no misunderstanding of the requirements of paragraph 3 of this Proposal, and that the contract will be executed in accordance with the rules of the Department if an award is made on this bid.

(IF AN INDIVIDUAL) Firm Name \_\_\_\_\_  
Signature of Owner \_\_\_\_\_  
Business Address \_\_\_\_\_  
\_\_\_\_\_

(IF A CO-PARTNERSHIP) Firm Name \_\_\_\_\_  
By \_\_\_\_\_  
Business Address \_\_\_\_\_  
Name and Address of All Members of the Firm:  
\_\_\_\_\_  
\_\_\_\_\_

(IF A CORPORATION) Corporate Name \_\_\_\_\_  
By \_\_\_\_\_  
Signature of Authorized Representative \_\_\_\_\_  
Typed or printed name and title of Authorized Representative \_\_\_\_\_  
Attest \_\_\_\_\_  
Signature \_\_\_\_\_  
(IF A JOINT VENTURE, USE THIS SECTION FOR THE MANAGING PARTY AND THE SECOND PARTY SHOULD SIGN BELOW) Business Address \_\_\_\_\_

(IF A JOINT VENTURE) Corporate Name \_\_\_\_\_  
By \_\_\_\_\_  
Signature of Authorized Representative \_\_\_\_\_  
Typed or printed name and title of Authorized Representative \_\_\_\_\_  
Attest \_\_\_\_\_  
Signature \_\_\_\_\_  
Business Address \_\_\_\_\_  
\_\_\_\_\_

If more than two parties are in the joint venture, please attach an additional signature sheet.



This Annual Proposal Bid Bond shall become effective at 12:01 AM (CDST) on \_\_\_\_\_ and shall be valid until \_\_\_\_\_ 11:59 PM (CDST).

KNOW ALL PERSONS BY THESE PRESENTS, That We \_\_\_\_\_

as PRINCIPAL, and \_\_\_\_\_

as SURETY, and held jointly, severally and firmly bound unto the STATE OF ILLINOIS in the penal sum of 5 percent of the total bid price, or for the amount specified in the bid proposal under "Proposal Guaranty" in effect on the date of the Invitation for Bids, whichever is the lesser sum, well and truly to be paid unto said STATE OF ILLINOIS, for the payment of which we bind ourselves, our heirs, executors, administrators, successors and assigns.

THE CONDITION OF THE FOREGOING OBLIGATION IS SUCH that whereas, the PRINCIPAL may submit bid proposal(s) to the STATE OF ILLINOIS, acting through the Department of Transportation, for various improvements published in the Transportation Bulletin during the effective term indicated above.

NOW, THEREFORE, if the Department shall accept the bid proposal(s) of the PRINCIPAL; and if the PRINCIPAL shall, within the time and as specified in the bidding and contract documents; and if, after award by the Department, the PRINCIPAL shall enter into a contract in accordance with the terms of the bidding and contract documents including evidence of the required insurance coverages and providing such bond as specified with good and sufficient surety for the faithful performance of such contract and for the prompt payment of labor and material furnished in the prosecution thereof; or if, in the event of the failure of the PRINCIPAL to enter into such contract and to give the specified bond, the PRINCIPAL pays to the Department the difference not to exceed the penalty hereof between the amount specified in the bid proposal and such larger amount for which the Department may contract with another party to perform the work covered by said bid proposal, then this obligation shall be null and void, otherwise, it shall remain in full force and effect.

IN THE EVENT the Department determines the PRINCIPAL has failed to comply with any requirement as set forth in the preceding paragraph, then Surety shall pay the penal sum to the Department within fifteen (15) days of written demand therefor. If Surety does not make full payment within such period of time, the Department may bring an action to collect the amount owed. Surety is liable to the Department for all its expenses, including attorney's fees, incurred in any litigation in which it prevails either in whole or in part.

In TESTIMONY WHEREOF, the said PRINCIPAL has caused this instrument to be signed by its officer \_\_\_\_\_ day of \_\_\_\_\_ A.D., \_\_\_\_\_

In TESTIMONY WHEREOF, the said SURETY has caused this instrument to be signed by its officer \_\_\_\_\_ day of \_\_\_\_\_ A.D., \_\_\_\_\_

\_\_\_\_\_  
(Company Name)

\_\_\_\_\_  
(Company Name)

By \_\_\_\_\_  
(Signature and Title)

By \_\_\_\_\_  
(Signature of Attorney-in-Fact)

**Notary for PRINCIPAL**

**Notary for SURETY**

STATE OF \_\_\_\_\_  
COUNTY OF \_\_\_\_\_

STATE OF \_\_\_\_\_  
COUNTY OF \_\_\_\_\_

Signed and attested before me on \_\_\_\_\_ (date)

Signed and attested before me on \_\_\_\_\_ (date)

by \_\_\_\_\_  
(Name of Notary Public)

by \_\_\_\_\_  
(Name of Notary Public)

(Seal) \_\_\_\_\_  
(Signature of Notary Public)

(Seal) \_\_\_\_\_  
(Signature of Notary Public)

\_\_\_\_\_  
(Date Commission Expires)

\_\_\_\_\_  
(Date Commission Expires)

In lieu of completing the above section of the Annual Proposal Bid Bond form, the Principal may file an Electronic Bid Bond. By signing the proposal(s) the Principal is ensuring the identified electronic bid bond has been executed and the Principal and Surety are firmly bound unto the State of Illinois under the conditions of the bid bond as shown above.

---

| Electronic Bid Bond ID # | Company/Bidder Name | Signature and Title |
|--------------------------|---------------------|---------------------|
|--------------------------|---------------------|---------------------|

This bond may be terminated, at Surety's request, upon giving not less than thirty (30) days prior written notice of the cancellation/termination of the bond. Said written notice shall be issued to the Illinois Department of Transportation, Chief Contracts Official, 2300 South Dirksen Parkway, Springfield, Illinois, 62764, and shall be served in person, by receipted courier delivery or certified or registered mail, return receipt requested. Said notice period shall commence on the first calendar day following the Department's receipt of written cancellation/termination notice. Surety shall remain firmly bound to all obligations herein for proposals submitted prior to the cancellation/termination. Surety shall be released and discharged from any obligation(s) for proposals submitted for any letting or date after the effective date of cancellation/termination.



Item No. \_\_\_\_\_

Letting Date \_\_\_\_\_

KNOW ALL PERSONS BY THESE PRESENTS, That We \_\_\_\_\_

as PRINCIPAL, and \_\_\_\_\_

as SURETY, and held jointly, severally and firmly bound unto the STATE OF ILLINOIS in the penal sum of 5 percent of the total bid price, or for the amount specified in the bid proposal under "Proposal Guaranty" in effect on the date of the Invitation for Bids, whichever is the lesser sum, well and truly to be paid unto said STATE OF ILLINOIS, for the payment of which we bind ourselves, our heirs, executors, administrators, successors and assigns.

THE CONDITION OF THE FOREGOING OBLIGATION IS SUCH that whereas, the PRINCIPAL has submitted a bid proposal to the STATE OF ILLINOIS, acting through the Department of Transportation, for the improvement designated by the Transportation Bulletin Item Number and Letting Date indicated above.

NOW, THEREFORE, if the Department shall accept the bid proposal of the PRINCIPAL; and if the PRINCIPAL shall, within the time and as specified in the bidding and contract documents; and if, after award by the Department, the PRINCIPAL shall enter into a contract in accordance with the terms of the bidding and contract documents including evidence of the required insurance coverages and providing such bond as specified with good and sufficient surety for the faithful performance of such contract and for the prompt payment of labor and material furnished in the prosecution thereof; or if, in the event of the failure of the PRINCIPAL to enter into such contract and to give the specified bond, the PRINCIPAL pays to the Department the difference not to exceed the penalty hereof between the amount specified in the bid proposal and such larger amount for which the Department may contract with another party to perform the work covered by said bid proposal, then this obligation shall be null and void, otherwise, it shall remain in full force and effect.

IN THE EVENT the Department determines the PRINCIPAL has failed to comply with any requirement as set forth in the preceding paragraph, then Surety shall pay the penal sum to the Department within fifteen (15) days of written demand therefor. If Surety does not make full payment within such period of time, the Department may bring an action to collect the amount owed. Surety is liable to the Department for all its expenses, including attorney's fees, incurred in any litigation in which it prevails either in whole or in part.

In TESTIMONY WHEREOF, the said PRINCIPAL has caused this instrument to be signed by its officer \_\_\_\_\_ day of \_\_\_\_\_ A.D., \_\_\_\_\_.

In TESTIMONY WHEREOF, the said SURETY has caused this instrument to be signed by its officer \_\_\_\_\_ day of \_\_\_\_\_ A.D., \_\_\_\_\_.

\_\_\_\_\_  
(Company Name)

\_\_\_\_\_  
(Company Name)

By \_\_\_\_\_  
(Signature and Title)

By \_\_\_\_\_  
(Signature of Attorney-in-Fact)

**Notary for PRINCIPAL**

**Notary for SURETY**

STATE OF \_\_\_\_\_  
COUNTY OF \_\_\_\_\_

STATE OF \_\_\_\_\_  
COUNTY OF \_\_\_\_\_

Signed and attested before me on \_\_\_\_\_ (date)  
by \_\_\_\_\_

Signed and attested before me on \_\_\_\_\_ (date)  
by \_\_\_\_\_

(Name of Notary Public)

(Name of Notary Public)

(Seal) \_\_\_\_\_  
(Signature of Notary Public)

(Seal) \_\_\_\_\_  
(Signature of Notary Public)

\_\_\_\_\_  
(Date Commission Expires)

\_\_\_\_\_  
(Date Commission Expires)

In lieu of completing the above section of the Proposal Bid Bond form, the Principal may file an Electronic Bid Bond. By signing the proposal the Principal is ensuring the identified electronic bid bond has been executed and the Principal and Surety are firmly bound unto the State of Illinois under the conditions of the bid bond as shown above.

Electronic Bid Bond ID # \_\_\_\_\_ Company/Bidder Name \_\_\_\_\_ Signature and Title \_\_\_\_\_



**(1) Policy**

It is public policy that disadvantageded businesses as defined in 49 CFR Part 26 and the Special Provision shall have the maximum opportunity to participate in the performance of contracts financed in whole or in part with Federal or State funds. Consequently the requirements of 49 CFR Part 26 apply to this contract.

**(2) Obligation**

The contractor agrees to ensure that disadvantageded businesses as defined in 49 CFR Part 26 and the Special Provision have the maximum opportunity to participate in the performance of contracts or subcontracts financed in whole or in part with Federal or State funds. The contractor shall take all necessary and reasonable steps in accordance with 49 CFR Part 26 and the Special Provision to ensure that said businesses have the maximum opportunity to compete for and perform under this contract. The contractor shall not discriminate on the basis of race, color, national origin or sex in the award and performance of contracts.

**(3) Project and Bid Identification**

Complete the following information concerning the project and bid:

|                        |  |
|------------------------|--|
| Route _____            | Total Bid _____  |
| Section _____          | Contract DBE Goal _____<br>(Percent) _____ (Dollar Amount) |
| Project _____          |  |
| County _____           |  |
| Letting Date _____     |  |
| Contract No. _____     |  |
| Letting Item No. _____ |  |

**(4) Assurance**

I, acting in my capacity as an officer of the undersigned bidder (or bidders if a joint venture), hereby assure the Department that on this project my company : (check one)

Meets or exceeds contract award goals and has provided documented participation as follows:  
Disadvantaged Business Participation \_\_\_\_\_ percent

Attached are the signed participation statements, forms SBE 2025, required by the Special Provision evidencing availability and use of each business participating in this plan and assuring that each business will perform a commercially useful function in the work of the contract.

Failed to meet contract award goals and has included good faith effort documentation to meet the goals and that my company has provided participation as follows:

Disadvantaged Business Participation \_\_\_\_\_ percent

The contract goals should be accordingly modified or waived. Attached is all information required by the Special Provision in support of this request including good faith effort. Also attached are the signed participation statements, forms SBE 2025, required by the Special Provision evidencing availability and use of each business participating in this plan and assuring that each business will perform a commercially useful function in the work of the contract.

\_\_\_\_\_  
Company

By \_\_\_\_\_

Title \_\_\_\_\_

Date \_\_\_\_\_

The "as read" Low Bidder is required to comply with the Special Provision.

Submit only one utilization plan for each project. The utilization plan shall be submitted in accordance with the special provision.

Bureau of Small Business Enterprises      **Local Let Projects**  
2300 South Dirksen Parkway                  Submit forms to the  
Springfield, Illinois 62764                      Local Agency



Subcontractor Registration \_\_\_\_\_

Letting \_\_\_\_\_

**Participation Statement**

Item No. \_\_\_\_\_

(1) Instructions

Contract \_\_\_\_\_

This form must be completed for each disadvantaged business participating in the Utilization Plan. This form shall be submitted in accordance with the special provision and will be attached to the Utilization Plan form.. If additional space is needed complete an additional form for the firm.

(2) Work

| Pay Item No. | Description | Quantity | Unit Price | Total |
|--------------|-------------|----------|------------|-------|
|              |             |          |            |       |
|              |             |          |            |       |
|              |             |          |            |       |
|              |             |          |            |       |
|              |             |          |            |       |
| <b>Total</b> |             |          |            |       |

(3) Partial Payment Items

For any of the above items which are partial pay items, specifically describe the work and subcontract dollar amount:

(4) Commitment

The undersigned certify that the information included herein is true and correct, and that the DBE firm listed below has agreed to perform a commercially useful function in the work of the contract item(s) listed above and to execute a contract with the prime contractor. The undersigned further understand that no changes to this statement may be made without prior approval from the Department’s Bureau of Small Business Enterprises and that complete and accurate information regarding actual work performed on this project and the payment therefore must be provided to the Department.

\_\_\_\_\_  
Signature for Prime Contractor

\_\_\_\_\_  
Signature for DBE Firm

Title \_\_\_\_\_

Title \_\_\_\_\_

Date \_\_\_\_\_

Date \_\_\_\_\_

Contact \_\_\_\_\_

Contact Person \_\_\_\_\_

Phone \_\_\_\_\_

Phone \_\_\_\_\_

Firm Name \_\_\_\_\_

Firm Name \_\_\_\_\_

Address \_\_\_\_\_

Address \_\_\_\_\_

City/State/Zip \_\_\_\_\_

City/State/Zip \_\_\_\_\_

E \_\_\_\_\_

WC \_\_\_\_\_

The Department of Transportation is requesting disclosure of information that is necessary to accomplish the statutory purpose as outlined under the state and federal law. Disclosure of this information is **REQUIRED**. Failure to provide any information will result in the contract not being awarded. This form has been approved by the State Forms Management Center.

# PROPOSAL ENVELOPE



# PROPOSALS

for construction work advertised for bids by the  
Illinois Department of Transportation

| Item No. | Item No. | Item No. |
|----------|----------|----------|
|          |          |          |
|          |          |          |
|          |          |          |
|          |          |          |

Submitted By:

|           |
|-----------|
| Name:     |
| Address:  |
|           |
|           |
| Phone No. |

Bidders should use an IDOT proposal envelope or affix this form to the front of a 10" x 13" envelope for the submittal of bids. If proposals are mailed, they should be enclosed in a second or outer envelope addressed to:

Engineer of Design and Environment - Room 326  
Illinois Department of Transportation  
2300 South Dirksen Parkway  
Springfield, Illinois 62764

## **NOTICE**

**Individual bids, including Bid Bond and/or supplemental information if required, should be securely stapled.**

# CONTRACTOR OFFICE COPY OF CONTRACT SPECIFICATIONS

## NOTICE

None of the following material needs to be returned with the bid package unless the special provisions require documentation and/or other information to be submitted.

**Contract No. 91491  
EDGAR County  
Section 10-00105-02-RS  
Project RS-0679(111)  
Route FAS 679 (Ch 8)  
District 5 Construction Funds**



**Illinois Department of Transportation**

## **SUBCONTRACTOR DOCUMENTATION**

Public Acts 96-0795, 96-0920, and 97-0895 enacted substantial changes to the provisions of the Code (30 ILCS 500). Among the changes are provisions affecting subcontractors. The Contractor awarded this contract will be required as a material condition of the contract to implement and enforce the contract requirements applicable to subcontractors that entered into a contractual agreement with a total value of \$50,000 or more with a person or entity who has a contract subject to the Code and approved in accordance with article 108.01 of the Standard Specifications for Road and Bridge Construction.

If the Contractor seeks approval of subcontractors to perform a portion of the work, and approval is granted by the Department, the Contractor shall provide a copy of the subcontract to the Illinois Department of Transportation's CPO upon request within 15 calendar days after execution of the subcontract.

Financial disclosures required pursuant to Sec. 50-35 of the Code must be submitted for all applicable subcontractors. The subcontract shall contain the certifications required to be made by subcontractors pursuant to Article 50 of the Code. This Notice to Bidders includes a document incorporating all required subcontractor certifications and disclosures for use by the Contractor in compliance with this mandate. The document is entitled State Required Ethical Standards Governing Subcontractors.

## RETURN WITH SUBCONTRACT

### STATE ETHICAL STANDARDS GOVERNING SUBCONTRACTORS

Article 50 of the Code establishes the duty of all State CPOs, SPOs, and their designees to maximize the value of the expenditure of public moneys in procuring goods, services, and contracts for the State of Illinois and to act in a manner that maintains the integrity and public trust of State government. In discharging this duty, they are charged by law to use all available information, reasonable efforts, and reasonable actions to protect, safeguard, and maintain the procurement process of the State of Illinois.

The certifications hereinafter made by the subcontractor are each a material representation of fact upon which reliance is placed should the Department approve the subcontractor. The CPO may terminate or void the contract approval if it is later determined that the bidder or subcontractor rendered a false or erroneous certification. If a false certification is made by a subcontractor the contractor's submitted bid and the executed contract may not be declared void unless the contractor refuses to terminate the subcontract upon the State's request after a finding that the subcontractor's certification was false.

Section 50-2 of the Code provides that every person that has entered into a multi-year contract and every subcontractor with a multi-year subcontract shall certify, by July 1 of each fiscal year covered by the contract after the initial fiscal year, to the responsible CPO whether it continues to satisfy the requirements of Article 50 pertaining to the eligibility for a contract award. If a contractor or subcontractor is not able to truthfully certify that it continues to meet all requirements, it shall provide with its certification a detailed explanation of the circumstances leading to the change in certification status. A contractor or subcontractor that makes a false statement material to any given certification required under Article 50 is, in addition to any other penalties or consequences prescribed by law, subject to liability under the Whistleblower Reward and Protection Act for submission of a false claim.

#### **A. Bribery**

Section 50-5. Bribery.

(a) Prohibition. No person or business shall be awarded a contract or subcontract under this Code who:

(1) has been convicted under the laws of Illinois or any other state of bribery or attempting to bribe an officer or employee of the State of Illinois or any other state in that officer's or employee's official capacity; or

(2) has made an admission of guilt of that conduct that is a matter of record but has not been prosecuted for that conduct.

(b) Businesses. No business shall be barred from contracting with any unit of State or local government, or subcontracting under such a contract, as a result of a conviction under this Section of any employee or agent of the business if the employee or agent is no longer employed by the business and:

(1) the business has been finally adjudicated not guilty; or

(2) the business demonstrates to the governmental entity with which it seeks to contract, or which is signatory to the contract to which the subcontract relates, and that entity finds that the commission of the offense was not authorized, requested, commanded, or performed by a director, officer, or high managerial agent on behalf of the business as provided in paragraph (2) of subsection (a) of Section 5-4 of the Criminal Code of 2012.

(c) Conduct on behalf of business. For purposes of this Section, when an official, agent, or employee of a business committed the bribery or attempted bribery on behalf of the business and in accordance with the direction or authorization of a responsible official of the business, the business shall be chargeable with the conduct.

(d) Certification. Every bid submitted to and contract executed by the State, and every subcontract subject to Section 20-120 of the Code shall contain a certification by the contractor or the subcontractor, respectively, that the contractor or subcontractor is not barred from being awarded a contract or subcontract under this Section and acknowledges that the CPO may declare the related contract void if any certifications required by this Section are false. A contractor who makes a false statement, material to the certification, commits a Class 3 felony.

The contractor or subcontractor certifies that it is not barred from being awarded a contract under Section 50.5.

#### **B. Felons**

Section 50-10. Felons.

(a) Unless otherwise provided, no person or business convicted of a felony shall do business with the State of Illinois or any State agency, or enter into a subcontract, from the date of conviction until 5 years after the date of completion of the sentence for that felony, unless no person held responsible by a prosecutorial office for the facts upon which the conviction was based continues to have any involvement with the business.

(b) Certification. Every bid submitted to and contract executed by the State and every subcontract subject to Section 20-120 of the Code shall contain a certification by the bidder or contractor or subcontractor, respectively, that the bidder, contractor, or subcontractor is not barred from being awarded a contract or subcontract under this Section and acknowledges that the CPO may declare the related contract void if any of the certifications required by this Section are false.

## RETURN WITH SUBCONTRACT

### **C. Debt Delinquency**

Section 50-11 and 50-12. Debt Delinquency.

The contractor or bidder or subcontractor, respectively, certifies that it, or any affiliate, is not barred from being awarded a contract or subcontract under the Code. Section 50-11 prohibits a person from entering into a contract with a State agency, or entering into a subcontract, if it knows or should know that it, or any affiliate, is delinquent in the payment of any debt to the State as defined by the Debt Collection Board. Section 50-12 prohibits a person from entering into a contract with a State agency, or entering into a subcontract, if it, or any affiliate, has failed to collect and remit Illinois Use Tax on all sales of tangible personal property into the State of Illinois in accordance with the provisions of the Illinois Use Tax Act. The bidder or contractor or subcontractor, respectively, further acknowledges that the CPO may declare the related contract void if this certification is false or if the bidder, contractor, or subcontractor, or any affiliate, is determined to be delinquent in the payment of any debt to the State during the term of the contract.

### **D. Prohibited Bidders, Contractors and Subcontractors**

Section 50-10.5 and 50-60(c). Prohibited bidders, contractors and subcontractors.

The bidder or contractor or subcontractor, respectively, certifies in accordance with 30 ILCS 500/50-10.5 that no officer, director, partner or other managerial agent of the contracting business has been convicted of a felony under the Sarbanes-Oxley Act of 2002 or a Class 3 or Class 2 felony under the Illinois Securities Law of 1953 or if in violation of Subsection (c) for a period of five years from the date of conviction. Every bid submitted to and contract executed by the State and every subcontract subject to Section 20-120 of the Code shall contain a certification by the bidder, contractor, or subcontractor, respectively, that the bidder, contractor, or subcontractor is not barred from being awarded a contract or subcontract under this Section and acknowledges that the CPO shall declare the related contract void if any of the certifications completed pursuant to this Section are false.

### **E. Section 42 of the Environmental Protection Act**

The bidder or contractor or subcontractor, respectively, certifies in accordance with 30 ILCS 500/50-14 that the bidder, contractor, or subcontractor, is not barred from being awarded a contract or entering into a subcontract under this Section which prohibits the bidding on or entering into contracts with the State of Illinois or a State agency, or entering into any subcontract, that is subject to the Code by a person or business found by a court or the Pollution Control Board to have committed a willful or knowing violation of Section 42 of the Environmental Protection Act for a period of five years from the date of the order. The bidder or contractor or subcontractor, respectively, acknowledges that the CPO may declare the contract void if this certification is false.

**The undersigned, on behalf of the subcontracting company, has read and understands the above certifications and makes the certifications as required by law.**

|   |   |      |
|---|---|------|
| <hr style="border: 0; border-top: 1px solid black; margin-bottom: 5px;"/> |   |      |
| Name of Subcontracting Company  |   |      |
| <hr style="border: 0; border-top: 1px solid black; margin-bottom: 5px;"/> |   |      |
| Authorized Officer  | <hr style="border: 0; border-top: 1px solid black; margin-bottom: 5px;"/> | Date |

**RETURN WITH SUBCONTRACT**  
**SUBCONTRACTOR DISCLOSURES**

**I. DISCLOSURES**

- A.** The disclosures hereinafter made by the subcontractor are each a material representation of fact upon which reliance is placed. The subcontractor further certifies that the Department has received the disclosure forms for each subcontract.

The CPO may void the bid, contract, or subcontract, respectively, if it is later determined that the bidder or subcontractor rendered a false or erroneous disclosure. A contractor or subcontractor may be suspended or debarred for violations of the Code. Furthermore, the CPO may void the contract.

**B. Financial Interests and Conflicts of Interest**

1. Section 50-35 of the Code provides that all subcontracts with a total value of \$50,000 or more, from subcontractors identified in Section 20-120 of the Code, shall be accompanied by disclosure of the financial interests of the subcontractor. This disclosed information for the subcontractor, will be maintained as public information subject to release by request pursuant to the Freedom of Information Act, filed with the Procurement Policy Board, and shall be incorporated as a material term of the Prime Contractor's contract. Furthermore, pursuant to this Section, the Procurement Policy Board may recommend to allow or void a contract or subcontract based on a potential conflict of interest.

The financial interests to be disclosed shall include ownership or distributive income share that is in excess of 5%, or an amount greater than 60% of the annual salary of the Governor, of the subcontracting entity or its parent entity, whichever is less, unless the subcontractor is a publicly traded entity subject to Federal 10K reporting, in which case it may submit its 10K disclosure in place of the prescribed disclosure. If a subcontractor is a privately held entity that is exempt from Federal 10K reporting, but has more than 200 shareholders, it may submit the information that Federal 10K companies are required to report, and list the names of any person or entity holding any ownership share that is in excess of 5%. The disclosure shall include the names, addresses, and dollar or proportionate share of ownership of each person making the disclosure, their instrument of ownership or beneficial relationship, and notice of any potential conflict of interest resulting from the current ownership or beneficial interest of each person making the disclosure having any of the relationships identified in Section 50-35 and on the disclosure form.

**The current annual salary of the Governor is \$177,412.00.**

In addition, all disclosures shall indicate any other current or pending contracts, subcontracts, proposals, leases, or other ongoing procurement relationships the subcontracting entity has with any other unit of state government and shall clearly identify the unit and the contract, subcontract, proposal, lease, or other relationship.

2. Disclosure Forms. Disclosure Form A is attached for use concerning the individuals meeting the above ownership or distributive share requirements. A separate Disclosure Form A must be submitted with the bid for each individual meeting the above requirements. In addition, a second form (Disclosure Form B) provides for the disclosure of current or pending procurement relationships with other (non-IDOT) state agencies and a total ownership certification. **The forms must be included with each bid.**

**C. Disclosure Form Instructions**

**Form A Instructions for Financial Information & Potential Conflicts of Interest**

If the subcontractor is a publicly traded entity subject to Federal 10K reporting, the 10K Report may be submitted to meet the requirements of Form A. If a subcontractor is a privately held entity that is exempt from Federal 10K reporting, but has more than 200 shareholders, it may submit the information that Federal 10K companies are required to report, and list the names of any person or entity holding any ownership share that is in excess of 5%. If a subcontractor is not subject to Federal 10K reporting, the subcontractor must determine if any individuals are required by law to complete a financial disclosure form. To do this, the subcontractor should answer each of the following questions. A "YES" answer indicates Form A must be completed. If the answer to each of the following questions is "NO", then the **NOT APPLICABLE STATEMENT** on the second page of Form A must be signed and dated by a person that is authorized to execute contracts for the subcontracting company. Note: These questions are for assistance only and are not required to be completed.

1. Does anyone in your organization have a direct or beneficial ownership share of greater than 5% of the bidding entity or parent entity? YES \_\_\_ NO \_\_\_
2. Does anyone in your organization have a direct or beneficial ownership share of less than 5%, but which has a value greater than 60% of the annual salary of the Governor? YES \_\_\_ NO \_\_\_
3. Does anyone in your organization receive more than 60% of the annual salary of the Governor of the subcontracting entity's or parent entity's distributive income? YES \_\_\_ NO \_\_\_

(Note: Distributive income is, for these purposes, any type of distribution of profits. An annual salary is not distributive income.)

4. Does anyone in your organization receive greater than 5% of the subcontracting entity's or parent entity's total distributive income, but which is less than 60% of the annual salary of the Governor? YES \_\_\_ NO \_\_\_

(Note: Only one set of forms needs to be completed per person per subcontract even if a specific individual would require a yes answer to more than one question.)

A "YES" answer to any of these questions requires the completion of Form A. The subcontractor must determine each individual in the subcontracting entity or the subcontracting entity's parent company that would cause the questions to be answered "Yes". Each form must be signed and dated by a person that is authorized to execute contracts for your organization. **Photocopied or stamped signatures are not acceptable.** The person signing can be, but does not have to be, the person for which the form is being completed. The subcontractor is responsible for the accuracy of any information provided.

If the answer to each of the above questions is "NO", then the **NOT APPLICABLE STATEMENT** on page 2 of Form A must be signed and dated by a person that is authorized to execute contracts for your company.



## RETURN WITH SUBCONTRACT

### **Form B: Instructions for Identifying Other Contracts & Procurement Related Information**

Disclosure Form B must be completed for each subcontract submitted by the subcontracting entity. *Note: Checking the NOT APPLICABLE STATEMENT on Form A does not allow the subcontractor to ignore Form B. Form B must be completed, checked, and dated or the subcontract will not be approved.*

The Subcontractor shall identify, by checking Yes or No on Form B, whether it has any pending contracts, subcontracts, leases, bids, proposals, or other ongoing procurement relationship with any other (non-IDOT) State of Illinois agency. If "No" is checked, the subcontractor only needs to complete the check box on the bottom of Form B. If "Yes" is checked, the subcontractor must list all non-IDOT State of Illinois agency pending contracts, subcontracts, leases, bids, proposals, and other ongoing procurement relationships. These items may be listed on Form B or on an attached sheet(s). Contracts with cities, counties, villages, etc. are not considered State of Illinois agency contracts and are not to be included. Contracts or subcontracts with other State of Illinois agencies such as the Department of Natural Resources or the Capital Development Board must be included.

**ILLINOIS DEPARTMENT  
OF TRANSPORTATION**

**Form A  
Subcontractor: Financial  
Information & Potential Conflicts  
of Interest Disclosure**

|                    |               |                           |
|--------------------|---------------|---------------------------|
| Subcontractor Name |               |                           |
| Legal Address      |               |                           |
| City, State, Zip   |               |                           |
| Telephone Number   | Email Address | Fax Number (if available) |

Disclosure of the information contained in this Form is required by the Section 50-35 of the Code (30 ILCS 500). Subcontractors desiring to enter into a subcontract of a State of Illinois contract must disclose the financial information and potential conflict of interest information as specified in this Disclosure Form. This information shall become part of the publicly available contract file. This Form A must be completed for subcontracts with a total value of \$50,000 or more, from subcontractors identified in Section 20-120 of the Code, and for all open-ended contracts. **A publicly traded company may submit a 10K disclosure (or equivalent if applicable) in satisfaction of the requirements set forth in Form A. See Disclosure Form Instructions.**

*The current annual salary of the Governor is \$177,412.00.*

**DISCLOSURE OF FINANCIAL INFORMATION**

**1. Disclosure of Financial Information.** The individual named below has an interest in the SUBCONTRACTOR (or its parent) in terms of ownership or distributive income share in excess of 5%, or an interest which has a value of more than 60% of the annual salary of the Governor. **(Make copies of this form as necessary and attach a separate Disclosure Form A for each individual meeting these requirements)**

|   |       |
|---|-------|
| <b>FOR INDIVIDUAL (type or print information)</b>   |       |
| <b>NAME:</b>  | _____ |
| <b>ADDRESS</b>  | _____ |
| <b>Type of ownership/distributable income share:</b>  |       |
| stock _____ sole proprietorship _____ Partnership _____ other: (explain on separate sheet): |       |
| % or \$ value of ownership/distributable income share:                                      | _____ |

**2. Disclosure of Potential Conflicts of Interest.** Check "Yes" or "No" to indicate which, if any, of the following potential conflict of interest relationships apply. If the answer to any question is "Yes", please attach additional pages and describe.

(a) State employment, currently or in the previous 3 years, including contractual employment of services.

Yes \_\_\_ No \_\_\_

If your answer is yes, please answer each of the following questions.

1. Are you currently an officer or employee of either the Capitol Development Board or the Illinois State Toll Highway Authority? Yes \_\_\_ No \_\_\_

2. Are you currently appointed to or employed by any agency of the State of Illinois? If you are currently appointed to or employed by any agency of the State of Illinois, and your annual salary exceeds 60% of the annual salary of the Governor, provide the name the State agency for which you are employed and your annual salary. \_\_\_\_\_

**RETURN WITH SUBCONTRACT**

3. If you are currently appointed to or employed by any agency of the State of Illinois, and your annual salary exceeds 60% of the annual salary of the Governor, are you entitled to receive (i) more than 7 1/2% of the total distributable income of your firm, partnership, association or corporation, or (ii) an amount in excess of 100% of the annual salary of the Governor?  
Yes \_\_\_ No \_\_\_

4. If you are currently appointed to or employed by any agency of the State of Illinois, and your annual salary exceeds 60% of the annual salary of the Governor, are you and your spouse or minor children entitled to receive (i) more than 15 % in the aggregate of the total distributable income of your firm, partnership, association or corporation, or (ii) an amount in excess of two times the salary of the Governor?  
Yes \_\_\_ No \_\_\_

---

(b) State employment of spouse, father, mother, son, or daughter, including contractual employment services in the previous 2 years.

Yes \_\_\_ No \_\_\_

If your answer is yes, please answer each of the following questions.

1. Is your spouse or any minor children currently an officer or employee of the Capitol Development Board or the Illinois State Toll Highway Authority?  
Yes \_\_\_ No \_\_\_

2. Is your spouse or any minor children currently appointed to or employed by any agency of the State of Illinois? If your spouse or minor children is/are currently appointed to or employed by any agency of the State of Illinois, and his/her annual salary exceeds 60% of the annual salary of the Governor, provide the name of your spouse and/or minor children, the name of the State agency for which he/she is employed and his/her annual salary. \_\_\_\_\_

3. If your spouse or any minor children is/are currently appointed to or employed by any agency of the State of Illinois, and his/her annual salary exceeds 60% of the annual salary of the Governor, are you entitled to receive (i) more than 7 1/2% of the total distributable income of your firm, partnership, association or corporation, or (ii) an amount in excess of 100% of the annual salary of the Governor?  
Yes \_\_\_ No \_\_\_

4. If your spouse or any minor children are currently appointed to or employed by any agency of the State of Illinois, and his/her annual salary exceeds 60% of the annual salary of the Governor, are you and your spouse or minor children entitled to receive (i) more than 15 % in the aggregate of the total distributable income of your firm, partnership, association or corporation, or (ii) an amount in excess of two times the salary of the Governor?  
Yes \_\_\_ No \_\_\_

---

(c) Elective status; the holding of elective office of the State of Illinois, the government of the United States, any unit of local government authorized by the Constitution of the State of Illinois or the statutes of the State of Illinois currently or in the previous 3 years.  
Yes \_\_\_ No \_\_\_

---

(d) Relationship to anyone holding elective office currently or in the previous 2 years; spouse, father, mother, son, or daughter.  
Yes \_\_\_ No \_\_\_

---

(e) Appointive office; the holding of any appointive government office of the State of Illinois, the United States of America, or any unit of local government authorized by the Constitution of the State of Illinois or the statutes of the State of Illinois, which office entitles the holder to compensation in excess of the expenses incurred in the discharge of that office currently or in the previous 3 years.  
Yes \_\_\_ No \_\_\_

---

(f) Relationship to anyone holding appointive office currently or in the previous 2 years; spouse, father, mother, son, or daughter.  
Yes \_\_\_ No \_\_\_

---

(g) Employment, currently or in the previous 3 years, as or by any registered lobbyist of the State government.  
Yes \_\_\_ No \_\_\_

---

**RETURN WITH SUBCONTRACT**

(h) Relationship to anyone who is or was a registered lobbyist in the previous 2 years; spouse, father, mother, son, or daughter. Yes \_\_\_ No \_\_\_

(i) Compensated employment, currently or in the previous 3 years, by any registered election or reelection committee registered with the Secretary of State or any county clerk of the State of Illinois, or any political action committee registered with either the Secretary of State or the Federal Board of Elections. Yes \_\_\_ No \_\_\_

(j) Relationship to anyone; spouse, father, mother, son, or daughter; who was a compensated employee in the last 2 years by any registered election or re-election committee registered with the Secretary of State or any county clerk of the State of Illinois, or any political action committee registered with either the Secretary of State or the Federal Board of Elections. Yes \_\_\_ No \_\_\_

**3 Communication Disclosure.**

Disclose the name and address of each lobbyist and other agent of the bidder or offeror who is not identified in Section 2 of this form, who is has communicated, is communicating, or may communicate with any State officer or employee concerning the bid or offer. This disclosure is a continuing obligation and must be promptly supplemented for accuracy throughout the process and throughout the term of the contract. If no person is identified, enter "None" on the line below:

Name and address of person(s): \_\_\_\_\_  
\_\_\_\_\_  
\_\_\_\_\_  
\_\_\_\_\_

**RETURN WITH SUBCONTRACT**

**4. Debarment Disclosure.** For each of the persons identified under Sections 2 and 3 of this form, disclose whether any of the following has occurred within the previous 10 years: debarment from contracting with any governmental entity; professional licensure discipline; bankruptcies; adverse civil judgments and administrative findings; and criminal felony convictions. This disclosure is a continuing obligation and must be promptly supplemented for accuracy throughout the procurement process and term of the contract. If no person is identified, enter "None" on the line below:

Name of person(s): \_\_\_\_\_

Nature of disclosure: \_\_\_\_\_  
\_\_\_\_\_  
\_\_\_\_\_

**APPLICABLE STATEMENT**

**This Disclosure Form A is submitted on behalf of the INDIVIDUAL named on previous page. Under penalty of perjury, I certify the contents of this disclosure to be true and accurate to the best of my knowledge.**

Completed by:  \_\_\_\_\_ Date \_\_\_\_\_  
Signature of Individual or Authorized Officer

**NOT APPLICABLE STATEMENT**

**Under penalty of perjury, I have determined that no individuals associated with this organization meet the criteria that would require the completion of this Form A.**

**This Disclosure Form A is submitted on behalf of the SUBCONTRACTOR listed on the previous page.**

\_\_\_\_\_ Date \_\_\_\_\_  
Signature of Authorized Officer

RETURN WITH SUBCONTRACT

ILLINOIS DEPARTMENT OF TRANSPORTATION

Form B
Subcontractor: Other Contracts & Financial Related Information Disclosure

Form with fields: Subcontractor Name, Legal Address, City, State, Zip, Telephone Number, Email Address, Fax Number (if available)

Disclosure of the information contained in this Form is required by the Section 50-35 of the Code (30 ILCS 500). This information shall become part of the publicly available contract file. This Form B must be completed for subcontracts with a total value of \$50,000 or more, from subcontractors identified in Section 20-120 of the Code, and for all open-ended contracts.

DISCLOSURE OF OTHER CONTRACTS, SUBCONTRACTS, AND PROCUREMENT RELATED INFORMATION

1. Identifying Other Contracts & Procurement Related Information. The SUBCONTRACTOR shall identify whether it has any pending contracts, subcontracts, including leases, bids, proposals, or other ongoing procurement relationship with any other State of Illinois agency: Yes \_\_\_ No \_\_\_

If "No" is checked, the subcontractor only needs to complete the signature box on the bottom of this page.

2. If "Yes" is checked. Identify each such relationship by showing State of Illinois agency name and other descriptive information such as bid or project number (attach additional pages as necessary). SEE DISCLOSURE FORM INSTRUCTIONS:

THE FOLLOWING STATEMENT MUST BE CHECKED

Signature box with fields for Signature of Authorized Officer and Date

OWNERSHIP CERTIFICATION

Please certify that the following statement is true if the individuals for all submitted Form A disclosures do not total 100% of ownership

Any remaining ownership interest is held by individuals receiving less than \$106,447.20 of the bidding entity's or parent entity's distributive income or holding less than a 5% ownership interest.

Yes No N/A (Form A disclosure(s) established 100% ownership)



## NOTICE TO BIDDERS

- 1. TIME AND PLACE OF OPENING BIDS.** Sealed proposals for the improvement described herein will be received by the Department of Transportation. Electronic bids are to be submitted to the electronic bidding system (ics-Integrated Contractors Exchange). Paper-based bids are to be submitted to the Chief Procurement Officer for the Department of Transportation in care of the Chief Contracts Official at the Harry R. Hanley Building, 2300 South Dirksen Parkway, in Springfield, Illinois until 10:00 o'clock a.m. April 25, 2014. All bids will be gathered, sorted, publicly opened and read in the auditorium at the Department of Transportation's Harry R. Hanley Building shortly after the 10:00 a.m. cut off time.
- 2. DESCRIPTION OF WORK.** The proposed improvement is identified and advertised for bids in the Invitation for Bids as:

**Contract No. 91491  
EDGAR County  
Section 10-00105-02-RS  
Project RS-0679(111)  
Route FAS 679 (Ch 8)  
District 5 Construction Funds**

**Project consists of the construction of a 1 1/4" HMA surface course, aggregate wedge shoulders, pavement markings, raised reflective pavement markers and all other incidental items to complete the work on FAS Route 679 (CH 8), 0.64 mile east of Illinois Route 49 to Illinois Route 1.**

- 3. INSTRUCTIONS TO BIDDERS.** (a) This Notice, the invitation for bids, proposal and letter of award shall, together with all other documents in accordance with Article 101.09 of the Standard Specifications for Road and Bridge Construction, become part of the contract. Bidders are cautioned to read and examine carefully all documents, to make all required inspections, and to inquire or seek explanation of the same prior to submission of a bid.  
  
(b) State law, and, if the work is to be paid wholly or in part with Federal-aid funds, Federal law requires the bidder to make various certifications as a part of the proposal and contract. By execution and submission of the proposal, the bidder makes the certification contained therein. A false or fraudulent certification shall, in addition to all other remedies provided by law, be a breach of contract and may result in termination of the contract.
- 4. AWARD CRITERIA AND REJECTION OF BIDS.** This contract will be awarded to the lowest responsive and responsible bidder considering conformity with the terms and conditions established by the Department in the rules, Invitation for Bids and contract documents. The issuance of plans and proposal forms for bidding based upon a prequalification rating shall not be the sole determinant of responsibility. The Department reserves the right to determine responsibility at the time of award, to reject any or all proposals, to readvertise the proposed improvement, and to waive technicalities.

By Order of the  
Illinois Department of Transportation

Ann L. Schneider,  
Secretary

CONTRACT 91491

INDEX  
FOR  
SUPPLEMENTAL SPECIFICATIONS  
AND RECURRING SPECIAL PROVISIONS

Adopted January 1, 2014

This index contains a listing of SUPPLEMENTAL SPECIFICATIONS, frequently used RECURRING SPECIAL PROVISIONS, and LOCAL ROADS AND STREETS RECURRING SPECIAL PROVISIONS.

ERRATA Standard Specifications for Road and Bridge Construction (Adopted 1-1-12) (Revised 1-1-14)

SUPPLEMENTAL SPECIFICATIONS

| <u>Std. Spec. Sec.</u> |  | <u>Page No.</u> |
|------------------------|--|-----------------|
| 101                    | Definition of Terms .....  | 1               |
| 102                    | Advertisement, Bidding, Award, and Contract Execution .....  | 2               |
| 105                    | Control of Work .....  | 3               |
| 106                    | Control of Materials .....   | 5               |
| 107                    | Legal Regulations and Responsibility to Public .....   | 6               |
| 108                    | Prosecution and Progress .....   | 14              |
| 109                    | Measurement and Payment .....  | 15              |
| 202                    | Earth and Rock Excavation .....  | 17              |
| 211                    | Topsoil and Compost .....  | 18              |
| 253                    | Planting Woody Plants .....  | 19              |
| 280                    | Temporary Erosion and Sediment Control .....   | 21              |
| 312                    | Stabilized Subbase .....   | 22              |
| 406                    | Hot-Mix Asphalt Binder and Surface Course .....  | 23              |
| 407                    | Hot-Mix Asphalt Pavement (Full-Depth) .....  | 26              |
| 420                    | Portland Cement Concrete Pavement .....  | 30              |
| 424                    | Portland Cement Concrete Sidewalk .....  | 32              |
| 440                    | Removal of Existing Pavement and Appurtenances .....   | 33              |
| 503                    | Concrete Structures .....  | 34              |
| 504                    | Precast Concrete Structures .....  | 37              |
| 506                    | Cleaning and Painting New Steel Structures .....   | 38              |
| 512                    | Piling .....   | 39              |
| 516                    | Drilled Shafts .....   | 40              |
| 521                    | Bearings .....   | 41              |
| 540                    | Box Culverts .....   | 42              |
| 588                    | Bridge Relief Joint System .....   | 43              |
| 589                    | Elastic Joint Sealer .....   | 45              |
| 602                    | Catch Basin, Manhole, Inlet, Drainage Structure, and Valve Vault Construction, Adjustment,<br>and Reconstruction ..... | 46              |
| 603                    | Adjusting Frames and Grates of Drainage and Utility Structures .....   | 47              |
| 606                    | Concrete Gutter, Curb, Median, and Paved Ditch .....   | 49              |
| 610                    | Shoulder Inlets with Curb .....  | 50              |
| 639                    | Precast Prestressed Concrete Sight Screen .....  | 51              |
| 642                    | Shoulder Rumble Strips .....   | 52              |
| 643                    | Impact Attenuators .....   | 53              |
| 644                    | High Tension Cable Median Barrier .....  | 55              |
| 701                    | Work Zone Traffic Control and Protection .....   | 57              |
| 706                    | Impact Attenuators, Temporary .....  | 60              |
| 707                    | Movable Traffic Barrier .....  | 63              |
| 708                    | Temporary Water Filled Barrier .....   | 65              |
| 730                    | Wood Sign Support .....  | 67              |
| 780                    | Pavement Striping .....  | 68              |
| 860                    | Master Controller .....  | 73              |



|      |  |     |
|------|--|-----|
| 1001 | Cement .....   | 74  |
| 1003 | Fine Aggregates .....                                | 75  |
| 1004 | Coarse Aggregates .....                              | 77  |
| 1006 | Metals .....   | 81  |
| 1011 | Mineral Filler .....                                 | 83  |
| 1017 | Packaged, Dry, Combined Materials for Mortar .....   | 84  |
| 1018 | Packaged Rapid Hardening Mortar or Concrete .....    | 85  |
| 1019 | Controlled Low-Strength Material .....               | 86  |
| 1020 | Portland Cement Concrete .....                       | 87  |
| 1024 | Grout and Nonshrink Grout .....                      | 126 |
| 1030 | Hot-Mix Asphalt .....                                | 127 |
| 1040 | Drain Pipe, Tile, Drainage Mat, and Wall Drain ..... | 132 |
| 1042 | Precast Concrete Products .....                      | 133 |
| 1070 | Foundation and Breakaway Devices .....               | 134 |
| 1073 | Controller .....                                     | 135 |
| 1081 | Materials for Planting .....                         | 136 |
| 1082 | Preformed Bearing Pads .....                         | 137 |
| 1083 | Elastomeric Bearings .....                           | 138 |
| 1095 | Pavement Markings .....                              | 139 |
| 1101 | General Equipment .....                              | 142 |
| 1102 | Hot-Mix Asphalt Equipment .....                      | 144 |
| 1105 | Pavement Marking Equipment .....                     | 146 |
| 1106 | Work Zone Traffic Control Devices .....              | 147 |

RECURRING SPECIAL PROVISIONS

The following RECURRING SPECIAL PROVISIONS indicated by an "X" are applicable to this contract and are included by reference:

| <u>CHECK SHEET #</u>   | <u>PAGE NO.</u> |
|--|-----------------|
| 1 X Additional State Requirements for Federal-Aid Construction Contracts<br>(Eff. 2-1-69) (Rev. 1-1-10) .....                | 149             |
| 2 X Subletting of Contracts (Federal-Aid Contracts) (Eff. 1-1-88) (Rev. 5-1-93) .....  | 152             |
| 3 X EEO (Eff. 7-21-78) (Rev. 11-18-80) .....   | 153             |
| 4 Specific Equal Employment Opportunity Responsibilities Non Federal-Aid Contracts (Eff. 3-20-69) (Rev. 1-1-94) .....        | 163             |
| 5 Required Provisions - State Contracts (Eff. 4-1-65) (Rev. 1-1-13) .....  | 168             |
| 6 Asbestos Bearing Pad Removal (Eff. 11-1-03) .....  | 173             |
| 7 Asbestos Waterproofing Membrane and Asbestos Hot-Mix Asphalt Surface Removal (Eff. 6-1-89) (Rev. 1-1-09) .....             | 174             |
| 8 Haul Road Stream Crossings, Other Temporary Stream Crossings, and<br>In-Stream Work Pads (Eff. 1-2-92) (Rev. 1-1-98) ..... | 175             |
| 9 Construction Layout Stakes Except for Bridges (Eff. 1-1-99) (Rev. 1-1-07) .....  | 176             |
| 10 Construction Layout Stakes (Eff. 5-1-93) (Rev. 1-1-07) .....  | 179             |
| 11 Use of Geotextile Fabric for Railroad Crossing (Eff. 1-1-95) (Rev. 1-1-07) .....  | 182             |
| 12 Subsealing of Concrete Pavements (Eff. 11-1-84) (Rev. 1-1-07) .....   | 184             |
| 13 Hot-Mix Asphalt Surface Correction (Eff. 11-1-87) (Rev. 1-1-09) .....   | 188             |
| 14 Pavement and Shoulder Resurfacing (Eff. 2-1-00) (Rev. 1-1-09) .....   | 190             |
| 15 PCC Partial Depth Hot-Mix Asphalt Patching (Eff. 1-1-98) (Rev. 1-1-07) .....  | 191             |
| 16 Patching with Hot-Mix Asphalt Overlay Removal (Eff. 10-1-95) (Rev. 1-1-07) .....  | 193             |
| 17 Polymer Concrete (Eff. 8-1-95) (Rev. 1-1-08) .....  | 194             |
| 18 PVC Pipeliner (Eff. 4-1-04) (Rev. 1-1-07) .....   | 196             |
| 19 Pipe Underdrains (Eff. 9-9-87) (Rev. 1-1-07) .....  | 197             |
| 20 Guardrail and Barrier Wall Delineation (Eff. 12-15-93) (Rev. 1-1-12) .....  | 198             |
| 21 Bicycle Racks (Eff. 4-1-94) (Rev. 1-1-12) .....   | 202             |
| 22 Temporary Modular Glare Screen System (Eff. 1-1-00) (Rev. 1-1-07) .....   | 204             |
| 23 Temporary Portable Bridge Traffic Signals (Eff. 8-1-03) (Rev. 1-1-07) .....   | 206             |
| 24 Work Zone Public Information Signs (Eff. 9-1-02) (Rev. 1-1-07) .....  | 208             |
| 25 Night Time Inspection of Roadway Lighting (Eff. 5-1-96) .....   | 209             |
| 26 English Substitution of Metric Bolts (Eff. 7-1-96) .....  | 210             |
| 27 English Substitution of Metric Reinforcement Bars (Eff. 4-1-96) (Rev. 1-1-03) .....                                       | 211             |
| 28 Calcium Chloride Accelerator for Portland Cement Concrete (Eff. 1-1-01) (Rev. 1-1-13) .....                               | 212             |
| 29 Portland Cement Concrete Inlay or Overlay for Pavements (Eff. 11-1-08) (Rev. 1-1-13) .....                                | 213             |
| 30 Quality Control of Concrete Mixtures at the Plant (Eff. 8-1-00) (Rev. 1-1-14) .....                                       | 216             |
| 31 Quality Control/Quality Assurance of Concrete Mixtures (Eff. 4-1-92) (Rev. 1-1-14) .....                                  | 224             |
| 32 Digital Terrain Modeling for Earthwork Calculations (Eff. 4-1-07) .....   | 240             |
| 33 Pavement Marking Removal (Eff. 4-1-09) .....  | 242             |
| 34 Preventive Maintenance – Bituminous Surface Treatment (Eff. 1-1-09) (Rev. 1-1-12) .....                                   | 243             |
| 35 Preventive Maintenance – Cape Seal (Eff. 1-1-09) (Rev. 1-1-12) .....  | 249             |
| 36 Preventive Maintenance – Micro-Surfacing (Eff. 1-1-09) (Rev. 1-1-12) .....  | 264             |
| 37 Preventive Maintenance – Slurry Seal (Eff. 1-1-09) (Rev. 1-1-12) .....  | 275             |
| 38 Temporary Raised Pavement Markers (Eff. 1-1-09) (Rev. 1-1-14) .....   | 285             |
| 39 Restoring Bridge Approach Pavements Using High-Density Foam (Eff. 1-1-09) (Rev. 1-1-12) .....                             | 286             |

LOCAL ROADS AND STREETS RECURRING SPECIAL PROVISIONS

The following LOCAL ROADS AND STREETS RECURRING SPECIAL PROVISIONS indicated by an "X" are applicable to this contract and are included by reference:

Table of Contents

| <u>CHECK SHEET #</u> |   | <u>PAGE NO.</u> |
|----------------------|---|-----------------|
| LRS 1                | <b>Reserved</b> .....   | 290             |
| LRS 2                | <input type="checkbox"/> Furnished Excavation .....                                       | 291             |
| LRS 3                | <input checked="" type="checkbox"/> Work Zone Traffic Control Surveillance .....          | 292             |
| LRS 4                | <input checked="" type="checkbox"/> Flaggers in Work Zones .....                          | 293             |
| LRS 5                | <input type="checkbox"/> Contract Claims .....  | 294             |
| LRS 6                | <input type="checkbox"/> Bidding Requirements and Conditions for Contract Proposals ..... | 295             |
| LRS 7                | <input type="checkbox"/> Bidding Requirements and Conditions for Material Proposals ..... | 301             |
| LRS 8                | <b>Reserved</b> .....   | 307             |
| LRS 9                | <input type="checkbox"/> Bituminous Surface Treatments .....                              | 308             |
| LRS 10               | <b>Reserved</b> .....   | 309             |
| LRS 11               | <input type="checkbox"/> Employment Practices .....                                       | 310             |
| LRS 12               | <input type="checkbox"/> Wages of Employees on Public Works .....                         | 312             |
| LRS 13               | <input type="checkbox"/> Selection of Labor .....   | 314             |
| LRS 14               | <input type="checkbox"/> Paving Brick and Concrete Paver Pavements and Sidewalks .....    | 315             |
| LRS 15               | <input type="checkbox"/> Partial Payments .....   | 318             |
| LRS 16               | <input type="checkbox"/> Protests on Local Lettings .....                                 | 319             |
| LRS 17               | <input type="checkbox"/> Substance Abuse Prevention Program.....                          | 320             |
| LRS 18               | <input type="checkbox"/> Multigrade Cold Mix Asphalt .....                                | 321             |

## TABLE OF CONTENTS

| <u>SHEET NO.</u> | <u>DESCRIPTION</u>                                    |
|------------------|---|
| 1                | Opening Paragraph                                     |
| 1                | Description of Work                                   |
| 1-2              | Traffic Control                                       |
| 2                | Resurfacing of Sideroad, Entrance and Mailbox Returns |
| 2                | Aggregate Wedge Shoulder, Type B                      |
| 3                | Raised Reflective Pavement Marker Removal             |
| 3                | Utilities   |
| 3                | Working Days  |
| 3                | Commitments   |
| 4-6              | Friction Aggregate                                    |
| 7                | Non-Vertical Impact Roller For Hot-Mix Asphalt        |
| 7                | Pneumatic-Tired Roller for Hot-Mix Asphalt            |
| 8                | Hot-Mix Asphalt – Required Field Tests                |
| 9-10             | Individual Density Sites                              |
| 11               | Status of Utilities                                   |

INDEX LOCAL ROADS AND STREETS SPECIAL PROVISIONS

| <u>LR #</u> | <u>Pg #</u> | <u>Special Provision Title</u>  | <u>Effective</u> | <u>Revised</u> |
|-------------|-------------|---|------------------|----------------|
| LR SD12     |             | <input type="checkbox"/> Slab Movement Detection Device   | Nov. 11, 1984    | Jan. 1, 2007   |
| LR SD13     |             | <input type="checkbox"/> Required Cold Milled Surface Texture   | Nov. 1, 1987     | Jan. 1, 2007   |
| LR SD406    |             | <input type="checkbox"/> <b>RESCINDED</b>   |                  |                |
| LR 102-2    |             | <input type="checkbox"/> Bidding Requirements and Conditions for Contract Proposals   | Jan. 1, 2001     | Jan. 1, 2014   |
| LR 105      | 12          | <input checked="" type="checkbox"/> Cooperation with Utilities  | Jan. 1, 1999     | Jan. 1, 2007   |
| LR 107-2    |             | <input type="checkbox"/> Railroad Protective Liability Insurance for Local Lettings   | Mar. 1, 2005     | Jan. 1, 2006   |
| LR 107-4    | 15          | <input checked="" type="checkbox"/> Insurance   | Feb. 1, 2007     | Aug. 1, 2007   |
| LR 107-7    |             | <input type="checkbox"/> Wages of Employees on Public Works   | Jan. 1, 1999     | Jan. 1, 2014   |
| LR 108      |             | <input type="checkbox"/> Combination Bids   | Jan. 1, 1994     | Mar. 1, 2005   |
| LR 109      |             | <input type="checkbox"/> Equipment Rental Rates   | Jan. 1, 2012     |                |
| LR 212      |             | <input type="checkbox"/> Shaping Roadway  | Aug. 1, 1969     | Jan. 1, 2002   |
| LR 355-1    |             | <input type="checkbox"/> Bituminous Stabilized Base Course, Road Mix or Traveling Plant Mix   | Oct. 1, 1973     | Jan. 1, 2007   |
| LR 355-2    |             | <input type="checkbox"/> Bituminous Stabilized Base Course, Plant Mix   | Feb. 20, 1963    | Jan. 1, 2007   |
| LR 400-1    |             | <input type="checkbox"/> Bituminous Treated Earth Surface   | Jan. 1, 2007     | Apr. 1, 2012   |
| LR 400-2    |             | <input type="checkbox"/> Bituminous Surface Plant Mix (Class B)   | Jan. 1, 2008     |                |
| LR 400-3    |             | <input type="checkbox"/> Hot In-Place Recycling (HIR) – Surface Recycling   | Jan. 1, 2012     |                |
| LR 400-4    |             | <input type="checkbox"/> Full-Depth Reclamation (FDR) with Emulsified Asphalt   | Apr. 1, 2012     | Jun. 1, 2012   |
| LR 400-5    |             | <input type="checkbox"/> Cold In-Place Recycling (CIR) With Emulsified Asphalt  | Apr. 1, 2012     | Jun. 1, 2012   |
| LR 400-6    |             | <input type="checkbox"/> Cold In Place Recycling (CIR) with Foamed Asphalt  | June 1, 2012     |                |
| LR 400-7    |             | <input type="checkbox"/> Full-Depth Reclamation (FDR) with Foamed Asphalt   | June 1, 2012     |                |
| LR 402      |             | <input type="checkbox"/> Salt Stabilized Surface Course   | Feb. 20, 1963    | Jan. 1, 2007   |
| LR 403-1    |             | <input type="checkbox"/> Surface Profile Milling of Existing, Recycled or Reclaimed Flexible Pavement                                 | Apr. 1, 2012     | Jun. 1, 2012   |
| LR 403-2    |             | <input type="checkbox"/> Bituminous Hot Mix Sand Seal Coat  | Aug. 1, 1969     | Jan. 1, 2007   |
| LR 406      |             | <input type="checkbox"/> Filling HMA Core Holes with Non-shrink Grout   | Jan. 1, 2008     |                |
| LR 420      |             | <input type="checkbox"/> PCC Pavement (Special)   | May 12, 1964     | Jan. 2, 2007   |
| LR 442      |             | <input type="checkbox"/> Bituminous Patching Mixtures for Maintenance Use   | Jan. 1, 2004     | Jun. 1, 2007   |
| LR 451      |             | <input type="checkbox"/> Crack Filling Bituminous Pavement with Fiber-Asphalt   | Oct. 1, 1991     | Jan. 1, 2007   |
| LR 503-1    |             | <input type="checkbox"/> Furnishing Class SI Concrete   | Oct. 1, 1973     | Jan. 1, 2002   |
| LR 503-2    |             | <input type="checkbox"/> Furnishing Class SI Concrete (Short Load)  | Jan. 1, 1989     | Jan. 1, 2002   |
| LR 542      |             | <input type="checkbox"/> Pipe Culverts, Type _____ (Furnished)  | Sep. 1, 1964     | Jan. 1, 2007   |
| LR 663      |             | <input type="checkbox"/> Calcium Chloride Applied   | Jan. 1, 1958     | Jan. 1, 2007   |
| LR 702      |             | <input type="checkbox"/> Construction and Maintenance Signs   | Jan. 1, 2004     | Jun. 1, 2007   |
| LR 1000-1   |             | <input type="checkbox"/> Cold In-Place Recycling (CIR) and Full Depth Reclamation (FDR) with Emulsified Asphalt Mix Design Procedures | Apr. 1, 2012     | Jun. 1, 2012   |
| LR 1000-2   |             | <input type="checkbox"/> Cold In-Place Recycling (CIR) and Full Depth Reclamation (FDR) with Foamed Asphalt Mix Design Procedures     | June 1, 2012     |                |
| LR 1004     |             | <input type="checkbox"/> Coarse Aggregate for Bituminous Surface Treatment  | Jan. 1, 2002     | Jan. 1, 2007   |
| LR 1030     |             | <input type="checkbox"/> Growth Curve   | Mar. 1, 2008     | Jan. 1, 2010   |
| LR 1032-1   |             | <input type="checkbox"/> Emulsified Asphalts  | Jan. 1, 2007     | Feb. 7, 2008   |
| LR 1102     |             | <input type="checkbox"/> Road Mix or Traveling Plan Mix Equipment   | Jan. 1, 2007     |                |

BDE SPECIAL PROVISIONS  
For the April 25 and June 13, 2014 Lettings

The following special provisions indicated by an "x" are applicable to this contract. An \* indicates a new or revised special provision for the letting.

| <u>File Name</u> | <u>Pg.</u> |   | <u>Special Provision Title</u>  | <u>Effective</u> | <u>Revised</u> |
|------------------|------------|---|---|------------------|----------------|
| 80240            |            |   | Above Grade Inlet Protection  | July 1, 2009     | Jan. 1, 2012   |
| 80099            |            |   | Accessible Pedestrian Signals (APS)   | April 1, 2003    | Jan. 1, 2014   |
| 80274            |            |   | Aggregate Subgrade Improvement  | April 1, 2012    | Jan. 1, 2013   |
| 80192            | 16         | X | Automated Flagger Assistance Device   | Jan. 1, 2008     |                |
| 80173            |            |   | Bituminous Materials Cost Adjustments   | Nov. 2, 2006     | Aug. 1, 2013   |
| 80241            |            |   | Bridge Demolition Debris  | July 1, 2009     |                |
| 50261            |            |   | Building Removal-Case I (Non-Friable and Friable Asbestos)  | Sept. 1, 1990    | April 1, 2010  |
| 50481            |            |   | Building Removal-Case II (Non-Friable Asbestos)   | Sept. 1, 1990    | April 1, 2010  |
| 50491            |            |   | Building Removal-Case III (Friable Asbestos)  | Sept. 1, 1990    | April 1, 2010  |
| 50531            |            |   | Building Removal-Case IV (No Asbestos)  | Sept. 1, 1990    | April 1, 2010  |
| 80292            |            |   | Coarse Aggregate in Bridge Approach Slabs/Footings  | April 1, 2012    | April 1, 2013  |
| 80310            |            |   | Coated Galvanized Steel Conduit   | Jan. 1, 2013     |                |
| 80198            |            |   | Completion Date (via calendar days)   | April 1, 2008    |                |
| 80199            |            |   | Completion Date (via calendar days) Plus Working Days   | April 1, 2008    |                |
| * 80293          |            |   | Concrete Box Culverts with Skews > 30 Degrees and Design Fills ≤ 5 Feet   | April 1, 2012    | April 1, 2014  |
| * 80294          |            |   | Concrete Box Culverts with Skews ≤ 30 Degrees Regardless of Design Fill and Skews > 30 Degrees with Design Fills > 5 Feet | April 1, 2012    | April 1, 2014  |
| 80311            |            |   | Concrete End Sections for Pipe Culverts   | Jan. 1, 2013     |                |
| * 80334          |            |   | Concrete Gutter, Curb, Median, and Paved Ditch  | April 1, 2014    |                |
| 80277            |            |   | Concrete Mix Design – Department Provided   | Jan. 1, 2012     | Jan. 1, 2014   |
| 80261            |            |   | Construction Air Quality – Diesel Retrofit  | June 1, 2010     | Jan. 1, 2014   |
| * 80335          | 18         | X | Contract Claims   | April 1, 2014    |                |
| 80029            | 19         | X | Disadvantaged Business Enterprise Participation   | Sept. 1, 2000    | Aug. 2, 2011   |
| 80265            |            |   | Friction Aggregate  | Jan. 1, 2011     |                |
| 80229            |            |   | Fuel Cost Adjustment  | April 1, 2009    | July 1, 2009   |
| 80329            |            |   | Glare Screen  | Jan. 1, 2014     |                |
| 80303            |            |   | Granular Materials  | Nov. 1, 2012     |                |
| 80304            |            |   | Grooving for Recessed Pavement Markings   | Nov. 1, 2012     | Jan. 1, 2013   |
| 80246            |            |   | Hot-Mix Asphalt – Density Testing of Longitudinal Joints  | Jan. 1, 2010     | April 1, 2012  |
| 80322            | 29         | X | Hot-Mix Asphalt – Mixture Design Composition and Volumetric Requirements  | Nov 1, 2013      |                |
| 80323            | 32         | X | Hot-Mix Asphalt – Mixture Design Verification and Production  | Nov 1, 2013      |                |
| 80315            |            |   | Insertion Lining of Culverts  | Jan. 1, 2013     | Nov 1, 2013    |
| * 80336          |            |   | Longitudinal Joint and Crack Patching   | April 1, 2014    |                |
| * 80324          |            |   | LRFD Pipe Culvert Burial Tables   | Nov 1, 2013      | April 1, 2014  |
| 80325            |            |   | LRFD Storm Sewer Burial Tables  | Nov 1, 2013      |                |
| 80045            |            |   | Material Transfer Device  | June 15, 1999    | Jan. 1, 2009   |
| 80165            |            |   | Moisture Cured Urethane Paint System  | Nov. 1, 2006     | Jan. 1, 2010   |
| * 80337          |            |   | Paved Shoulder Removal  | April 1, 2014    |                |
| 80330            |            |   | Pavement Marking for Bike Symbol  | Jan. 1, 2014     |                |
| 80298            |            |   | Pavement Marking Tape Type IV   | April 1, 2012    |                |
| 80254            |            |   | Pavement Patching   | Jan. 1, 2010     |                |
| 80331            | 35         | X | Payrolls and Payroll Records  | Jan. 1, 2014     |                |
| 80332            |            |   | Portland Cement Concrete – Curing of Abutments and Piers  | Jan. 1, 2014     |                |
| 80326            |            |   | Portland Cement Concrete Equipment  | Nov 1, 2013      |                |
| * 80338          |            |   | Portland Cement Concrete Partial Depth Hot-Mix Asphalt Patching   | April 1, 2014    |                |
| 80300            |            |   | Preformed Plastic Pavement Marking Type D - Inlaid  | April 1, 2012    |                |

| <u>File Name</u> | <u>Pg.</u> |   | <u>Special Provision Title</u>  | <u>Effective</u> | <u>Revised</u> |
|------------------|------------|---|---|------------------|----------------|
| 80328            | 37         | X | Progress Payments   | Nov. 2, 2013     |                |
| 80281            |            |   | Quality Control/Quality Assurance of Concrete Mixes                   | Jan. 1, 2012     | Jan. 1, 2014   |
| 3426I            |            |   | Railroad Protective Liability Insurance                               | Dec. 1, 1986     | Jan. 1, 2006   |
| 80157            | 38         | X | Railroad Protective Liability Insurance (5 and 10)                    | Jan. 1, 2006     |                |
| * 80306          | 39         | X | Reclaimed Asphalt Pavement (RAP) and Reclaimed Asphalt Shingles (RAS) | Nov. 1, 2012     | April 1, 2014  |
| 80327            |            |   | Reinforcement bars  | Nov 1, 2013      |                |
| 80283            | 49         | X | Removal and Disposal of Regulated Substances                          | Jan. 1, 2012     | Nov. 2, 2012   |
| 80319            | 53         | X | Removal and Disposal of Surplus Materials                             | Nov. 2, 2012     |                |
| 80307            |            |   | Seeding   | Nov. 1, 2012     |                |
| * 80339          |            |   | Stabilized Subbase  | April 1, 2014    |                |
| 80127            |            |   | Steel Cost Adjustment   | April 2, 2004    | April 1, 2009  |
| 80317            |            |   | Surface Testing of Hot-Mix Asphalt Overlays                           | Jan. 1, 2013     |                |
| 80301            |            |   | Tracking the Use of Pesticides  | Aug. 1, 2012     |                |
| 80333            |            |   | Traffic Control Setup and Removal Freeway/Expressway                  | Jan. 1, 2014     |                |
| 20338            |            |   | Training Special Provisions   | Oct. 15, 1975    |                |
| * 80318          |            |   | Traversable Pipe Grate  | Jan. 1, 2013     | April 1, 2014  |
| 80288            |            |   | Warm Mix Asphalt  | Jan. 1, 2012     | Nov. 1, 2013   |
| 80302            | 54         | X | Weekly DBE Trucking Reports   | June 2, 2012     |                |
| 80289            |            |   | Wet Reflective Thermoplastic Pavement Marking                         | Jan. 1, 2012     |                |
| 80071            | 55         | X | Working Days  | Jan. 1, 2002     |                |

The following special provisions are in the 2014 Supplemental Specifications and Recurring Special Provisions:

| <u>File Name</u> | <u>Special Provision Title</u>                        | <u>New Location</u>                           | <u>Effective</u> | <u>Revised</u> |
|------------------|---|---|------------------|----------------|
| 80309            | Anchor Bolts  | Articles 1006.09, 1070.01, and 1070.03        | Jan. 1, 2013     |                |
| 80276            | Bridge Relief Joint Sealer                            | Article 503.19 and Sections 588 and 589       | Jan. 1, 2012     | Aug. 1, 2012   |
| 80312            | Drain Pipe, Tile, Drainage Mat, and Wall Drain        | Article 101.01, 1040.03, and 1040.04          | Jan. 1, 2013     |                |
| 80313            | Fabric Bearing Pads                                   | Article 1082.01                               | Jan. 1, 2013     |                |
| 80169            | High Tension Cable Median Barrier                     | Section 644 and Article 1106.02               | Jan. 1, 2007     | Jan. 1, 2013   |
| 80320            | Liquidated Damages                                    | Article 108.09                                | April 1, 2013    |                |
| 80297            | Modified Urethane Pavement Marking                    | Section 780, Articles 1095.09 and 1105.04     | April 1, 2012    |                |
| 80253            | Moveable Traffic Barrier                              | Section 707 and Article 1106.02               | Jan. 1, 2010     | Jan. 1, 2013   |
| 80231            | Pavement Marking Removal                              | Recurring CS #33                              | April 1, 2009    |                |
| 80321            | Pavement Removal                                      | Article 440.07                                | April 1, 2013    |                |
| 80022            | Payments to Subcontractors                            | Article 109.11                                | June 1, 2000     | Jan. 1, 2006   |
| 80316            | Placing and Consolidating Concrete                    | Articles 503.06, 503.07, and 516.12           | Jan. 1, 2013     |                |
| 80278            | Planting Woody Plants                                 | Section 253 and Article 1081.01               | Jan. 1, 2012     | Aug. 1, 2012   |
| 80305            | Polyurea Pavement Markings                            | Article 780.14                                | Nov. 1, 2012     | Jan. 1, 2013   |
| 80279            | Portland Cement Concrete                              | Sections 312, 503, 1003, 1004, 1019, and 1020 | Jan. 1, 2012     | Nov. 1, 2013   |
| 80218            | Preventive Maintenance – Bituminous Surface Treatment | Recurring CS #34                              | Jan. 1, 2009     | April 1, 2012  |
| 80219            | Preventive Maintenance – Cape Seal                    | Recurring CS #35                              | Jan. 1, 2009     | April 1, 2012  |
| 80220            | Preventive Maintenance – Micro Surfacing              | Recurring CS #36                              | Jan. 1, 2009     | April 1, 2012  |
| 80221            | Preventive Maintenance – Slurry Seal                  | Recurring CS #37                              | Jan. 1, 2009     | April 1, 2012  |

| <u>File Name</u> | <u>Special Provision Title</u>                                    | <u>New Location</u>  | <u>Effective</u> | <u>Revised</u> |
|------------------|---|--|------------------|----------------|
| 80224            | Restoring Bridge Approach Pavements Using High-Density Foam       | Recurring CS #39   | Jan. 1, 2009     | Jan. 1, 2012   |
| 80255            | Stone Matrix Asphalt  | Sections 406, 1003, 1004, 1030, and 1011                           | Jan. 1, 2010     | Aug. 1, 2013   |
| 80143            | Subcontractor Mobilization Payments                               | Article 109.12   | April 2, 2005    | April 1, 2011  |
| 80308            | Synthetic Fibers in Concrete Gutter, Curb, Median and Paved Ditch | Articles 606.02 and 606.11   | Nov. 1, 2012     |                |
| 80286            | Temporary Erosion and Sediment Control                            | Articles 280.04 and 280.08   | Jan. 1, 2012     |                |
| 80225            | Temporary Raised Pavement Marker                                  | Recurring CS #38   | Jan. 1, 2009     |                |
| 80256            | Temporary Water Filled Barrier                                    | Section 708 and Article 1106.02                                    | Jan. 1, 2010     | Jan. 1, 2013   |
| 80273            | Traffic Control Deficiency Deduction                              | Article 105.03   | Aug. 1, 2011     |                |
| 80270            | Utility Coordination and Conflicts                                | Articles 105.07, 107.19, 107.31, 107.37, 107.38, 107.39 and 107.40 | April 1, 2011    | Jan. 1, 2012   |

The following special provisions require additional information from the designer. The Special Provisions are:

- Bridge Demolition Debris
- Building Removal-Case I
- Building Removal-Case II
- Building Removal-Case III
- Building Removal-Case IV
- Completion Date
- Completion Date Plus Working Days
- DBE Participation
- Material Transfer Device
- Railroad Protective Liability Insurance
- Training Special Provisions
- Working Days



## SPECIAL PROVISIONS.

The following Special Provisions supplement the "Standard Specifications for Road and Bridge Construction", adopted January 1, 2012, the latest edition of the Manual on Uniform Traffic Control Devices for Street and Highways", and the Manual of Test Procedures of Materials" in effect on the date of invitation of bids, and the Supplemental Specifications and Recurring Special Provisions indicated on the Check Sheet included here in which apply to and govern the construction of section 10-00105-02-RS, and in case of conflict with any part, or parts, of said Specifications, the Special Provisions shall take precedence and govern.

**DESCRIPTION OF WORK:** This work consists primarily of construction of a 1¼" Hot-Mix Asphalt Surface Course on the existing pavement structure; 18" Aggregate Wedge Shoulders; Pavement Markings, Raised Reflective Pavement Markers and all other items to complete the construction.

**TRAFFIC CONTROL:** Traffic control shall be in accordance with the applicable sections of the Standard Specifications, the applicable guidelines contained in the Illinois Manual on Uniform Traffic Control Devices, these Special Provisions, and any special details and Highway Standards contained herein and in the plans.

Special attention is called to Articles 107.09 and 107.14 of the Standard Specifications, the following Highway Standards relating to Traffic Control, the listed Supplemental Specifications and Recurring Special Provisions.

Highway Standards: 701006, 701011, 701301, 701306, 701311 and 701901

Traffic: It is the intention of the Department that FAS 679 (CH 8), all side roads and entrances be kept open to traffic at all times during the construction of this section. One-way traffic will be permitted in the immediate work areas during construction. At all other times, two-way traffic shall be maintained throughout the project.

Whenever the contractors operations will affect normal traffic patterns at side roads and entrances designated by the Engineer, the contractor shall provide flaggers to regulate traffic on the side road or entrances deemed necessary by the Engineer. All traffic control necessary to safeguard side road or entrance traffic, additional to items shown on the Standards included in the plans will be paid for in accordance with Article 109.04 of the Standard Specifications.

The following Traffic Control Standards will be utilized during, but not limited to the listed construction operations:

**TRAFFIC CONTROL:** (Cont'd)

**Standard 701006:** Shall be used whenever vehicles, equipment or workers do not encroach within 24 inches of the pavement edge.

**Standard 701011:** Shoulder grading operations and Clean-up Operations that do not encroach on the pavement edge.

**Standard 701301:** Shall be used whenever vehicles, equipment or workers encroach on the pavement and the duration of encroachment is 60 minutes or less.

**Standard 701306:** Hot-Mix Asphalt placement and Aggregate Wedge Shoulder placement/grading. This traffic control standard shall be used any time that vehicles, equipment or workers encroach on the pavement and the duration of the encroachment exceeds 60 minutes.

**Standard 701311:** Shall be used for pavement markings and markers.

**RESURFACING OF SIDEROAD, ENTRANCE AND MAILBOX RETURNS:** This work shall be performed in accordance with applicable portions of Section 406 of the Standard Specifications and the detail included the plans.

The contractor shall place the 18 inch wide resurfacing on the returns at the same time that the resurfacing is placed on the adjacent mainline pavement.

This work shall be paid for at the contract unit price Ton for Hot-Mix Asphalt Surface Course, Mix "C", N50, which price shall include all materials and any additional labor required to construct the returns as shown in the plans.

**AGGREGATE WEDGE SHOULDER, TYPE B:** This work shall be performed in accordance with applicable portions of Section 481 of the Standard Specifications except that the only material allowed will be crushed stone.

This work will be paid for at the contract unit price Ton for Aggregate Wedge Shoulder, Type B, which price shall be payment in full for all material, equipment and labor to complete the work as herein specified.

## **RAISED REFLECTIVE PAVEMENT MARKER REMOVAL**

Eff. 10-22-1997

Rev. 01-01-2014

Replace Article 783.03(b) with the following:

“Where removal of raised reflective markers is indicated in the plans, this shall consist of complete removal of the castings, and reflectors from the pavement structure. Where cold milling is not proposed, or where the proposed depth of cold milling is less than 1½ inches (38 mm), the holes resulting from the removal of raised reflective markers shall immediately be cleaned out with compressed air, filled with a bituminous mixture meeting the requirements of Article 1030.07 and/or Materials “M” Specification 120 (Bituminous Premix for Maintenance Use – Proprietary Mixes), and compacted to the satisfaction of the Engineer. This work shall be completed prior to cold milling, or prior to hot-mix asphalt placement if cold milling is not specified.”

Add the following at the end of Article 783.06:

“The payment for RAISED REFLECTIVE PAVEMENT MARKER REMOVAL shall include complete removal and disposal of the castings and reflectors, and furnishing, placing, and compacting the bituminous material in the holes as specified above.”

783

**UTILITIES:** There should be no utilities that interfere with the construction of this project unless excavation operations are added to the contract. If excavation operations are added to the contract, the contractor will be responsible for contacting the various utility companies that may have facilities present within the limits of this section.

If a utility conflict exists, the contractor shall make every effort possible to perform his operations so as to not disturb the utility.

**WORKING DAYS:** The Contractor shall complete the work within 25 Working Days

**COMMITMENTS:** There were no commitments made that pertain to the construction of this project.

**SPECIAL PROVISION FOR FRICTION AGGREGATE (BMPR)**

Effective: January 1, 2010

Revised 09-01-12

Revise Article 1004.01 (a) (4) of the Standard Specifications to read:

“(4) Crushed Stone. Crushed stone shall be the angular fragments resulting from crushing undisturbed, consolidated deposits of rock by mechanical means. Crushed stone shall be divided into the following, when specified.

(i) Carbonate Crushed Stone. Carbonate Crushed Stone shall be either Dolomite or Limestone. Dolomite shall contain 11.0 percent or more magnesium oxide (MgO). Limestone shall contain less than 11.0 percent magnesium oxide (MgO).

(ii) Crystalline Crushed Stone. Crystalline Crushed Stone shall be either Metamorphic or Igneous Stone to include but is not limited to, Quartzite, Granite, Rhyolite and Diabase.”

Revise Article 1004.03 (a) of the Standard Specifications to read:

“**1004.03 Coarse Aggregate for Hot-Mix Asphalt (HMA).** The aggregate shall be according to Article 1004.01 and the following.

(a) Description. The coarse aggregate for HMA shall be according to the following table.

| Use              | Mixture                               | Aggregates Percent (%) Allowed by Volume  |
|------------------|---------------------------------------|---|
| Class A          | Seal or Cover                         | <u>Allowed Alone or in Combination:</u><br>Gravel<br>Crushed Gravel<br>Carbonate Crushed Stone<br>Crystalline Crushed Stone<br>Crushed Sandstone<br>Crushed Slag (ACBF)<br>Crushed Steel Slag<br>Crushed Concrete               |
| HMA<br>All Other | Stabilized<br>Subbase or<br>Shoulders | <u>Allowed Alone or in Combination:</u><br>Gravel<br>Crushed Gravel<br>Carbonate Crushed Stone<br>Crystalline Crushed Stone<br>Crushed Sandstone<br>Crushed Slag (ACBF)<br>Crushed Steel Slag <sup>1/</sup><br>Crushed Concrete |

| Use                          | Mixture  | Aggregates Percent (%) Allowed by Volume  |
|------------------------------|--|---|
| HMA<br>High ESAL<br>Low ESAL | Binder<br>IL-25.0, IL-19.0,<br>or IL-19.0L<br><br>SMA Binder   | <u>Allowed Alone or in Combination:</u><br>Crushed Gravel<br>Carbonate Crushed Stone <sup>2/</sup><br>Crystalline Crushed Stone<br>Crushed Sandstone<br>Crushed Slag (ACBF)<br>Crushed Concrete <sup>3/</sup>   |
| HMA<br>High ESAL<br>Low ESAL | C Surface and<br>Leveling Binder<br>IL-12.5, IL-9.5,<br>or IL-9.5L<br><br>SMA<br>Ndesign 50<br>Surface | <u>Allowed Alone or in Combination:</u><br>Crushed Gravel<br>Carbonate Crushed Stone <sup>2/</sup><br>Crystalline Crushed Stone<br>Crushed Sandstone<br>Crushed Slag (ACBF)<br>Crushed Steel Slag <sup>4/</sup><br>Crushed Concrete <sup>3/</sup>   |
| HMA<br>High ESAL             | D Surface and<br>Leveling Binder<br>IL-12.5 or<br>IL-9.5<br><br>SMA<br>Ndesign 50<br>Surface           | <u>Allowed Alone or in Combination:</u><br>Crushed Gravel<br>Carbonate Crushed Stone (other than Limestone) <sup>2/</sup><br>Crystalline Crushed Stone<br>Crushed Sandstone<br>Crushed Slag (ACBF) <sup>5/</sup><br>Crushed Steel Slag <sup>4/ 5/</sup><br>Crushed Concrete <sup>3/</sup> |
|                              |  | <u>Other Combinations Allowed:</u>  |
|                              |  | <i>Up to...</i> <i>With...</i>  |
|                              |  | 25%<br>Limestone      Dolomite  |
|                              |  | 50%<br>Limestone      Any Mixture D aggregate other than<br>Dolomite  |
|                              |  | 75%<br>Limestone      Crushed Slag (ACBF) <sup>5/</sup> or Crushed<br>Sandstone   |

|  |  |  |  |
|--|--|--|--|
| HMA<br>High ESAL   | E Surface<br>IL-12.5 or<br>IL-9.5<br><br>SMA<br>Ndesign 80<br>Surface  | <u>Allowed Alone or in Combination:</u>  |  |
|  |  | Crushed Gravel<br>Crystalline Crushed Stone<br>Crushed Sandstone<br>Crushed Slag (ACBF) <sup>5/</sup><br>Crushed Steel Slag <sup>5/</sup><br>Crushed Concrete <sup>3/</sup><br><br>No Limestone. |  |
|  |  | <u>Other Combinations Allowed:</u>   |  |
|  |  | <i>Up to...</i>  | <i>With...</i>   |
|  |  | 50%<br>Dolomite <sup>2/</sup>  | Any Mixture E aggregate  |
| 75%<br>Dolomite <sup>2/</sup>                                    | Crushed Sandstone, Crushed Slag (ACBF) <sup>5/</sup> , Crushed Steel Slag <sup>5/</sup> , or Crystalline Crushed Stone |  |  |
| 75%<br>Crushed<br>Gravel or<br>Crushed<br>Concrete <sup>3/</sup> | Crushed Sandstone, Crystalline Crushed Stone, Crushed Slag (ACBF) <sup>5/</sup> , or Crushed Steel Slag <sup>5/</sup>  |  |  |
| HMA<br>High ESAL   | F Surface<br>IL-12.5 or<br>IL-9.5<br><br>SMA<br>Ndesign 80<br>Surface  | <u>Allowed Alone or in Combination:</u>  |  |
|  |  | Crystalline Crushed Stone<br>Crushed Sandstone<br>Crushed Slag (ACBF) <sup>5/</sup><br>Crushed Steel Slag <sup>5/</sup><br>No Limestone.   |  |
|  |  | <u>Other Combinations Allowed:</u>   |  |
|  |  | <i>Up to...</i>  | <i>With...</i>   |
|  |  | 50%<br>Crushed<br>Gravel,<br>Crushed<br>Concrete <sup>3/</sup> ,<br>or Dolomite <sup>2/</sup>  | Crushed Sandstone, Crushed Slag (ACBF) <sup>5/</sup> , Crushed Steel Slag <sup>5/</sup> , or Crystalline Crushed Stone |

1/ Crushed Steel Slag allowed in Shoulder Surface Only

2/ Carbonate Crushed Stone shall not be used in SMA Ndesign 80. In SMA Ndesign 50, Carbonate Crushed Stone shall not be blended with any of the other aggregates allowed alone in Ndesign 50 SMA Binder or Ndesign 50 SMA Surface

3/ Crushed Concrete will not be permitted in SMA mixes

4/ Crushed Steel Slag shall not be used as leveling binder

5/ When either slag is used, the blend percentages listed shall be by volume"

## **NON-VERTICAL IMPACT ROLLER FOR HOT-MIX ASPHALT**

Eff. October 13, 2011

For all Hot-Mix Asphalt Mixtures placed at a rate exceeding 85 tons per hour (75 metric tons per hour), a Non-Vertical Impact roller may be used as the finish roller. The roller shall meet the requirements outlined below.

The roller shall be capable of operating in a mode that will provide non-vertical impacts and operate at a speed to produce not less than 10 impacts/ft (30 impacts/m). The roller shall be self-propelled and provide a smooth operation when starting, stopping or reversing directions. The non-vertical impact drum(s) amplitude and frequency shall be approximately the same in each direction and meet the following minimum requirements: drum diameter 48 in. (1200 mm), length of drum 66 in. (1650 mm), unit static force on drum(s) 125 lb/in. (22 N/m), adjustable eccentrics, and reversible eccentrics on non-driven drum(s). The total applied force and the direction it is applied for various combinations of VPM and eccentric positions shall be shown on decals on the vibrating roller or on a chart maintained with the roller. The roller shall be equipped with water tanks and sprinkling devices, or other approved methods, which shall be used to wet the drums to prevent material pickup.

This work will not be measured for payment or paid for separately, but shall be considered as included in the price per ton (metric ton) or square yard (square meter) of the various items of HOT-MIX ASPHALT, of the mixture and Ndesign (if applicable) specified.

Non-vertical roller

## **PNEUMATIC-TIRED ROLLER FOR HOT-MIX ASPHALT**

Eff. 10-01-1998

Rev. 09-01-2006

For all Hot-Mix Asphalt Mixtures placed at a rate exceeding 85 tons per hour (75 metric tons per hour), a pneumatic-tired roller will be required as the intermediate roller. This roller shall meet the requirements of Table 1 of Article 406.07 of the Standard Specifications. This provision shall hold over any other requirements included elsewhere in the contract.

This work will not be measured for payment or paid for separately, but shall be considered as included in the price per ton (metric ton) or square yard (square meter) of the various items of HOT-MIX ASPHALT, of the mixture and Ndesign (if applicable) specified.

406.doc

## **HOT-MIX ASPHALT – REQUIRED FIELD TESTS**

Effective 01/01/11

Revise the first paragraph of Article 1030.05(d)(3) to read as follows:

Required Field Tests. The Contractor shall control the compaction process by testing the mix density at random locations determined by the Engineer in accordance with the QC/QA document, "Determination of Random Density Test Site Locations", and recording the results on forms approved by the Engineer. The density locations will be disclosed and marked by the Engineer after all compaction efforts have been completed. Locations shall be laid out using a tape measure or an approved measuring wheel. The Contractor shall follow the density testing procedures detailed in the QC/QA document, "Illinois-Modified ASTM D 2950, Standard Test Method for Determination of Density of Bituminous Concrete In-Place by Nuclear Method".

103005-d3



## INDIVIDUAL DENSITY SITES

Effective: September 1, 2007

Revised: April 10, 2012

Description: This work shall consist of evaluating the daily average offset density value as part of the quality control/quality assurance (QC/QA) of hot-mix asphalt (HMA). Work shall be according to Section 1030 of the Standard Specifications except as follows:

Revise the Density Control Limits table in 1030.05(d)(4) of the Standard Specifications to read:

| INDIVIDUAL OFFSET DENSITY CONTROL LIMITS |                             |                                |                             |
|--|-----------------------------|--------------------------------|-----------------------------|
| Mixture Composition                      | Parameter                   | Mat                            | Confined & Unconfined Edge  |
|  |                             | Daily Average Density Value    | Daily Average Density Value |
| IL-4.75                                  | $N_{des}=50$                | 93.0 – 97.4% <sup>1/</sup>     | 90.0%                       |
| IL-9.5, IL-12.5                          | $N_{des} \geq 90$           | 92.0 – 96.0 %                  | 90.0%                       |
| IL-9.5, IL-9.5L, IL-12.5                 | $N_{des} < 90$              | 92.5 – 97.4 %                  | 90.0%                       |
| IL-19.0, IL-19.0FG, IL-25.0              | $N_{des} \geq 90$           | 93.0 – 96.0 %                  | 90.0%                       |
| IL-19.0, IL-19.0FG, IL-19.0L, IL-25.0    | $N_{des} < 90$              | 93.0 – 97.4 %                  | 90.0%                       |
| IL-9.5FG <1 ¼ in (32 mm)                 | $N_{des} 50-105$            | % <sup>1/</sup><br>90.0 – 95.0 | 90.0%                       |
| IL-9.5FG ≥1 ¼ in (32 mm)                 | $N_{des} 50-105$            | 93.0 – 97.0 %                  | 90.0%                       |
| SMA                                      | $N_{des} 50 \text{ \& } 80$ | 93.5% - 97.4%                  | 91.0%                       |
| All Other                                | $N_{des} = 30$              | 93.0 <sup>42/</sup> - 97.4%    | 90.0%                       |

1/ Density shall be determined by cores or by correlated, approved thin lift nuclear gauge.

2/ 92.0% when placed as first lift on an unimproved subgrade.

Insert the following after the sixth paragraph Article 1030.05(d)(7) of the Standard Specifications:

When the daily average density value for a given offset exceeds the control limits, the Engineer shall be notified immediately.

If a daily average density value failure occurs at a given offset due to low density for a given mixture, additional compactive effort or paver adjustment shall be required and approved by the Engineer prior to additional paving. If a daily average density value failure occurs at a given offset due to high density for a given mixture, production shall cease until the problem has been investigated and corrected. Reducing compactive effort for failing high densities will not be allowed.

## INDIVIDUAL DENSITY SITES (Cont'd)

If two daily average density value failures occur at a given offset for a given mixture, the Engineer shall cease production.

103005(a)(4)

## STATUS OF UTILITIES

| Name & Address<br><u>of Utility</u> | <u>Type</u>  | <u>Location</u>    | Adjustment<br>or<br><u>Relocation</u> |
|-------------------------------------|--------------|--------------------|---------------------------------------|
| Enerstar Power Corp.                | Aerial Lines | Throughout Project | None                                  |
| Frontier Communications             | Buried Cable | Throughout Project | None                                  |

Utility adjustments or relocations should not be required by this project. **The Illinois Underground Utility Facilities Damage Prevention Act** requires persons excavating to contact the one call system (J.U.L.I.E 800-892-0123 or 811) before digging.

Toll Free J.U.L.I.E. Telephone Number (800) 892-0123

\* = J.U.L.I.E. Member

State of Illinois  
Department of Transportation  
Bureau of Local Roads and Streets

SPECIAL PROVISION  
FOR  
COOPERATION WITH UTILITIES

Effective: January 1, 1999  
Revised: January 1, 2007

All references to Sections or Articles in this specification shall be construed to mean specific Section or Article of the Standard Specifications for Road and Bridge Construction, adopted by the Department of Transportation.

Replace Article 105.07 of the Standard Specifications with the following:

**"105.07 Cooperation with Utilities.** The adjustment of utilities consists of the relocation, removal, replacement, rearrangements, reconstruction, improvement, disconnection, connection, shifting, new installation or altering of an existing utility facility in any manner.

When the plans or special provisions include information pertaining to the location of underground utility facilities, such information represents only the opinion of the Department as to the location of such utilities and is only included for the convenience of the bidder. The Department assumes no responsibility in respect to the sufficiency or the accuracy of the information shown on the plans relative to the location of the underground utility facilities.

Utilities which are to be adjusted shall be adjusted by the utility owner or the owner's representative or by the Contractor as a contract item. Generally, arrangements for adjusting existing utilities will be made by the Department prior to project construction; however, utilities will not necessarily be adjusted in advance of project construction and, in some cases, utilities will not be removed from the proposed construction limits. When utility adjustments must be performed in conjunction with construction, the utility adjustment work will be shown on the plans and/or covered by Special Provisions.

When the Contractor discovers a utility has not been adjusted by the owner or the owner's representative as indicated in the contract documents, or the utility is not shown on the plans or described in the Special Provisions as to be adjusted in conjunction with construction, the Contractor shall not interfere with said utility, and shall take proper precautions to prevent damage or interruption of the utility and shall promptly notify the Engineer of the nature and location of said utility.

All necessary adjustments, as determined by the Engineer, of utilities not shown on the plans or not identified by markers, will be made at no cost to the Contractor except traffic structures, light poles, etc., that are normally located within the proposed construction limits as hereinafter defined will not be adjusted unless required by the proposed improvement.

(a) Limits of Proposed Construction for Utilities Paralleling the Roadway. For the purpose of this Article, limits of proposed construction for utilities extending in the same longitudinal direction as the roadway, shall be defined as follows:

(1) The horizontal limits shall be a vertical plane, outside of, parallel to, and 600 mm (2 ft) distant at right angles from the plan or revised slope limits.

In cases where the limits of excavation for structures are not shown on the plans, the horizontal limits shall be a vertical plane 1.2 m (4 ft) outside the edges of structure footings or the structure where no footings are required.

(2) The upper vertical limits shall be the regulations governing the roadbed clearance for the specific utility involved.

(3) The lower vertical limits shall be the top of the utility at the depth below the proposed grade as prescribed by the governing agency or the limits of excavation, whichever is less.

(b) Limits of Proposed Construction for Utilities Crossing the Roadway. For the purpose of this Article, limits of proposed construction for utilities crossing the roadway in a generally transverse direction shall be defined as follows:

(1) Utilities crossing excavations for structures that are normally made by trenching such as sewers, underdrains, etc. and all minor structures such as manholes, inlets, foundations for signs, foundations for traffic signals, etc., the limits shall be the space to be occupied by the proposed permanent construction unless otherwise required by the regulations governing the specific utility involved.

(2) For utilities crossing the proposed site of major structures such as bridges, sign trusses, etc., the limits shall be as defined above for utilities extending in the same general direction as the roadway.

The Contractor may make arrangements for adjustment of utilities outside of the limits of proposed construction provided the Contractor furnishes the Department with a signed agreement with the utility owner covering the adjustments to be made. The cost of any adjustments made outside the limits of proposed construction shall be the responsibility of the Contractor unless otherwise provided.

The Contractor shall request all utility owners to field locate their facilities according to Article 107.31. The Engineer may make the request for location from the utility after receipt of notice from the Contractor. On request, the Engineer will make an inspection to verify that the utility company has field located its facilities, but will not assume responsibility for the accuracy of such work. The Contractor shall be responsible for maintaining the excavations or markers provided by the utility owners. This field location procedure may be waived if the utility owner has stated in writing to the Department it is satisfied the construction plans are sufficiently accurate. If the utility owner does not submit such statement to the Department, and they do not field locate their facilities in both horizontal and vertical alignment, the Engineer will authorize the Contractor in writing to proceed to locate the facilities in the most economical and reasonable manner, subject to the approval of the Engineer, and be paid according to Article 109.04.

The Contractor shall coordinate with any planned utility adjustment or new installation and the Contractor shall take all precautions to prevent disturbance or damage to utility facilities. Any failure on the part of the utility owner, or their representative, to proceed with any planned utility adjustment or new installation shall be reported promptly by the Contractor to the Engineer orally and in writing.

The Contractor shall take all necessary precautions for the protection of the utility facilities. The Contractor shall be responsible for any damage or destruction of utility facilities resulting from neglect, misconduct, or omission in the Contractor's manner or method of execution or nonexecution of the work, or caused by defective work or the use of unsatisfactory materials. Whenever any damage or destruction of a utility facility occurs as a result of work performed by the Contractor, the utility company will be immediately notified. The utility company will make arrangements to restore such facility to a condition equal to that existing before any such damage or destruction was done.

It is understood and agreed that the Contractor has considered in the bid all of the permanent and temporary utilities in their present and/or adjusted positions.

No additional compensation will be allowed for any delays, inconvenience, or damage sustained by the Contractor due to any interference from the said utility facilities or the operation of relocating the said utility facilities.

State of Illinois  
Department of Transportation  
Bureau of Local Roads and Streets

SPECIAL PROVISION  
FOR  
INSURANCE

Effective: February 1, 2007  
Revised: August 1, 2007

All references to Sections or Articles in this specification shall be construed to mean specific Section or Article of the Standard Specifications for Road and Bridge Construction, adopted by the Department of Transportation.

The Contractor shall name the following entities as additional insured under the Contractor's general liability insurance policy in accordance with Article 107.27:

Edgar County Highway Department

The entities listed above and their officers, employees, and agents shall be indemnified and held harmless in accordance with Article 107.26.

## **AUTOMATED FLAGGER ASSISTANCE DEVICES (BDE)**

Effective: January 1, 2008

Description. This work shall consist of furnishing and operating automated flagger assistance devices (AFADs) as part of the work zone traffic control and protection for two-lane highways where two-way traffic is maintained over one lane of pavement. Use of these devices shall be at the option of the Contractor.

Equipment. AFADs shall be according to the FHWA memorandum, "MUTCD - Revised Interim Approval for the use of Automated Flagger Assistance Devices in Temporary Traffic Control Zones (IA-4R)", dated January 28, 2005. The devices shall be mounted on a trailer or a moveable cart and shall meet the requirements of NCHRP 350, Category 4.

The AFAD shall be the Stop/Slow type. This device uses remotely controlled "STOP" and "SLOW" signs to alternately control right-of-way.

Signs for the AFAD shall be according to Article 701.03 of the Standard Specifications and the MUTCD. The signs shall be 24 x 24 in. (600 x 600 mm) having an octagon shaped "STOP" sign on one side and a diamond shaped "SLOW" sign on the opposite side. The letters on the signs shall be 8 in. (200 mm) high. If the "STOP" sign has louvers, the full sign face shall be visible at a distance of 50 ft (15 m) and greater.

The signs shall be supplemented with one of the following types of lights.

- (a) Flashing Lights. When flashing lights are used, white or red flashing lights shall be mounted within the "STOP" sign face and white or yellow flashing lights within the "SLOW" sign face.
- (b) Stop and Warning Beacons. When beacons are used, a stop beacon shall be mounted 24 in. (600 mm) or less above the "STOP" sign face and a warning beacon mounted 24 in. (600 mm) or less above, below, or to the side of the "SLOW" sign face. As an option, a Type B warning light may be used in lieu of the warning beacon.

A "WAIT ON STOP" sign shall be placed on the right hand side of the roadway at a point where drivers are expected to stop. The sign shall be 24 x 30 in. (600 x 750 mm) with a black legend and border on a white background. The letters shall be at least 6 in. (150 mm) high.

This device may include a gate arm or mast arm that descends to a horizontal position when the "STOP" sign is displayed and rises to a vertical position when the "SLOW" sign is displayed. When included, the end of the arm shall reach at least to the center of the lane being controlled. The arm shall have alternating red and white retroreflective stripes, on both sides, sloping downward at 45 degrees toward the side on which traffic will pass. The stripes shall be 6 in. (150 mm) in width and at least 2 in. (50 mm) in height.



Flagging Requirements. Flaggers and flagging requirements shall be according to Article 701.13 of the Standard Specifications and the following.

AFADs shall be placed at each end of the traffic control, where a flagger is shown on the plans. The flaggers shall be able to view the face of the AFAD and approaching traffic during operation.

To stop traffic, the "STOP" sign shall be displayed, the corresponding lights/beacon shall flash, and when included, the gate arm shall descend to a horizontal position. To permit traffic to move, the "SLOW" sign shall be displayed, the corresponding lights/beacon shall flash, and when included, the gate arm shall rise to a vertical position.

If used at night, the AFAD location shall be illuminated according to Section 701 of the Standard Specifications.

When not in use, AFADs will be considered nonoperating equipment and shall be stored according to Article 701.11 of the Standard Specifications.

Basis of Payment. This work will not be paid for separately but shall be considered as included in the cost of the various traffic control items included in the contract.

80192

-

17

## CONTRACT CLAIMS (BDE)

Effective: April 1, 2014

Revise the first paragraph of Article 109.09(a) of the Standard Specifications to read:

“(a) Submission of Claim. All claims filed by the Contractor shall be in writing and in sufficient detail to enable the Department to ascertain the basis and amount of the claim. As a minimum, the following information must accompany each claim submitted.”

Revise Article 109.09(e) of the Standard Specifications to read:

“(e) Procedure. The Department provides two administrative levels for claims review.

- Level I Engineer of Construction
- Level II Chief Engineer/Director of Highways or Designee

- (1) Level I. All claims shall first be submitted at Level I. Two copies each of the claim and supporting documentation shall be submitted simultaneously to the District and the Engineer of Construction. The Engineer of Construction, in consultation with the District, will consider all information submitted with the claim and render a decision on the claim within 90 days after receipt by the Engineer of Construction. Claims not conforming to this Article will be returned without consideration. The Engineer of Construction may schedule a claim presentation meeting if in the Engineer of Construction's judgment such a meeting would aid in resolution of the claim, otherwise a decision will be made based on the claim documentation submitted. If a Level I decision is not rendered within 90 days of receipt of the claim, or if the Contractor disputes the decision, an appeal to Level II may be made by the Contractor.
- (2) Level II. An appeal to Level II shall be made in writing to the Engineer of Construction within 45 days after the date of the Level I decision. Review of the claim at Level II shall be conducted as a full evaluation of the claim. A claim presentation meeting may be scheduled if the Chief Engineer/Director of Highways determines that such a meeting would aid in resolution of the claim, otherwise a decision will be made based on the claim documentation submitted. A Level II final decision will be rendered within 90 days of receipt of the written request for appeal.

Full compliance by the Contractor with the provisions specified in this Article is a contractual condition precedent to the Contractor's right to seek relief in the Court of Claims. The Director's written decision shall be the final administrative action of the Department. Unless the Contractor files a claim for adjudication by the Court of Claims within 60 days after the date of the written decision, the failure to file shall constitute a release and waiver of the claim.”

80335

## **DISADVANTAGED BUSINESS ENTERPRISE PARTICIPATION (BDE)**

Effective: September 1, 2000

Revised: August 2, 2011

FEDERAL OBLIGATION. The Department of Transportation, as a recipient of federal financial assistance, is required to take all necessary and reasonable steps to ensure nondiscrimination in the award and administration of contracts. Consequently, the federal regulatory provisions of 49 CFR Part 26 apply to this contract concerning the utilization of disadvantaged business enterprises. For the purposes of this Special Provision, a disadvantaged business enterprise (DBE) means a business certified by the Department in accordance with the requirements of 49 CFR Part 26 and listed in the Illinois Unified Certification Program (IL UCP) DBE Directory.

STATE OBLIGATION. This Special Provision will also be used by the Department to satisfy the requirements of the Business Enterprise for Minorities, Females, and Persons with Disabilities Act, 30 ILCS 575. When this Special Provision is used to satisfy state law requirements on 100 percent state-funded contracts, the federal government has no involvement in such contracts (not a federal-aid contract) and no responsibility to oversee the implementation of this Special Provision by the Department on those contracts. DBE participation on 100 percent state-funded contracts will not be credited toward fulfilling the Department's annual overall DBE goal required by the US Department of Transportation to comply with the federal DBE program requirements.

CONTRACTOR ASSURANCE. The Contractor makes the following assurance and agrees to include the assurance in each subcontract that the Contractor signs with a subcontractor.

The Contractor, subrecipient, or subcontractor shall not discriminate on the basis of race, color, national origin, or sex in the performance of this contract. The Contractor shall carry out applicable requirements of 49 CFR Part 26 in the award and administration of contracts funded in whole or in part with federal or state funds. Failure by the Contractor to carry out these requirements is a material breach of this contract, which may result in the termination of this contract or such other remedy as the recipient deems appropriate.

OVERALL GOAL SET FOR THE DEPARTMENT. As a requirement of compliance with 49 CFR Part 26, the Department has set an overall goal for DBE participation in its federally assisted contracts. That goal applies to all federal-aid funds the Department will expend in its federally assisted contracts for the subject reporting fiscal year. The Department is required to make a good faith effort to achieve the overall goal. The dollar amount paid to all approved DBE companies performing work called for in this contract is eligible to be credited toward fulfillment of the Department's overall goal.

CONTRACT GOAL TO BE ACHIEVED BY THE CONTRACTOR. This contract includes a specific DBE utilization goal established by the Department. The goal has been included because the Department has determined that the work of this contract has subcontracting opportunities that may be suitable for performance by DBE companies. The determination is

based on an assessment of the type of work, the location of the work, and the availability of DBE companies to do a part of the work. The assessment indicates that, in the absence of unlawful discrimination, and in an arena of fair and open competition, DBE companies can be expected to perform 4.00 % of the work. This percentage is set as the DBE participation goal for this contract. Consequently, in addition to the other award criteria established for this contract, the Department will only award this contract to a bidder who makes a good faith effort to meet this goal of DBE participation in the performance of the work. A bidder makes a good faith effort for award consideration if either of the following is done in accordance with the procedures set for in this Special Provision:

- (a) The bidder documents that enough DBE participation has been obtained to meet the goal: or
- (b) The bidder documents that a good faith effort has been made to meet the goal, even though the effort did not succeed in obtaining enough DBE participation to meet the goal.

DBE LOCATOR REFERENCES. Bidders shall consult the IL UCP DBE Directory as a reference source for DBE-certified companies. In addition, the Department maintains a letting and item specific DBE locator information system whereby DBE companies can register their interest in providing quotes on particular bid items advertised for letting. Information concerning DBE companies willing to quote work for particular contracts may be obtained by contacting the Department's Bureau of Small Business Enterprises at telephone number (217)785-4611, or by visiting the Department's website at [www.dot.il.gov](http://www.dot.il.gov).

BIDDING PROCEDURES. Compliance with this Special Provision is a material bidding requirement. The failure of the bidder to comply will render the bid not responsive.

- (a) The bidder shall submit a Disadvantaged Business Utilization Plan on Department forms SBE 2025 and 2026 with the bid.
- (b) The Utilization Plan shall indicate that the bidder either has obtained sufficient DBE participation commitments to meet the contract goal or has not obtained enough DBE participation commitments in spite of a good faith effort to meet the goal. The Utilization Plan shall further provide the name, telephone number, and telefax number of a responsible official of the bidder designated for purposes of notification of plan approval or disapproval under the procedures of this Special Provision.
- (c) The Utilization Plan shall include a DBE Participation Commitment Statement, Department form SBE 2025, for each DBE proposed for the performance of work to achieve the contract goal. For bidding purposes, submission of the completed SBE 2025 forms, signed by the DBEs and faxed to the bidder will be acceptable as long as the original is available and provided upon request. All elements of information indicated on the said form shall be provided, including but not limited to the following:
  - (1) The names and addresses of DBE firms that will participate in the contract;

- (2) A description, including pay item numbers, of the work each DBE will perform;
- (3) The dollar amount of the participation of each DBE firm participating. The dollar amount of participation for identified work shall specifically state the quantity, unit price, and total subcontract price for the work to be completed by the DBE. If partial pay items are to be performed by the DBE, indicate the portion of each item, a unit price where appropriate and the subcontract price amount;
- (4) DBE Participation Commitment Statements, form SBE 2025, signed by the bidder and each participating DBE firm documenting the commitment to use the DBE subcontractors whose participation is submitted to meet the contract goal;
- (5) if the bidder is a joint venture comprised of DBE companies and non-DBE companies, the plan must also include a clear identification of the portion of the work to be performed by the DBE partner(s); and,
- (6) If the contract goal is not met, evidence of good faith efforts.

GOOD FAITH EFFORT PROCEDURES. The contract will not be awarded until the Utilization Plan submitted by the apparent successful bidder is approved. All information submitted by the bidder must be complete, accurate and adequately document that enough DBE participation has been obtained or document that good faith efforts of the bidder, in the event enough DBE participation has not been obtained, before the Department will commit to the performance of the contract by the bidder. The Utilization Plan will be approved by the Department if the Utilization Plan documents sufficient commercially useful DBE work performance to meet the contract goal or the bidder submits sufficient documentation of a good faith effort to meet the contract goal pursuant to 49 CFR Part 26, Appendix A. The Utilization Plan will not be approved by the Department if the Utilization Plan does not document sufficient DBE participation to meet the contract goal unless the apparent successful bidder documented in the Utilization Plan that it made a good faith effort to meet the goal. This means that the bidder must show that all necessary and reasonable steps were taken to achieve the contract goal. Necessary and reasonable steps are those which, by their scope, intensity and appropriateness to the objective, could reasonably be expected to obtain sufficient DBE participation, even if they were not successful. The Department will consider the quality, quantity, and intensity of the kinds of efforts that the bidder has made. Mere *pro forma* efforts, in other words, efforts done as a matter of form, are not good faith efforts; rather, the bidder is expected to have taken genuine efforts that would be reasonably expected of a bidder actively and aggressively trying to obtain DBE participation sufficient to meet the contract goal.

- (a) The following is a list of types of action that the Department will consider as part of the evaluation of the bidder's good faith efforts to obtain participation. These listed factors are not intended to be a mandatory checklist and are not intended to be exhaustive. Other factors or efforts brought to the attention of the Department may be relevant in appropriate cases, and will be considered by the Department.

- (1) Soliciting through all reasonable and available means (e.g. attendance at pre-bid meetings, advertising and/or written notices) the interest of all certified DBE companies that have the capability to perform the work of the contract. The bidder must solicit this interest within sufficient time to allow the DBE companies to respond to the solicitation. The bidder must determine with certainty if the DBE companies are interested by taking appropriate steps to follow up initial solicitations.
- (2) Selecting portions of the work to be performed by DBE companies in order to increase the likelihood that the DBE goals will be achieved. This includes, where appropriate, breaking out contract work items into economically feasible units to facilitate DBE participation, even when the prime Contractor might otherwise prefer to perform these work items with its own forces.
- (3) Providing interested DBE companies with adequate information about the plans, specifications, and requirements of the contract in a timely manner to assist them in responding to a solicitation.
- (4) a. Negotiating in good faith with interested DBE companies. It is the bidder's responsibility to make a portion of the work available to DBE subcontractors and suppliers and to select those portions of the work or material needs consistent with the available DBE subcontractors and suppliers, so as to facilitate DBE participation. Evidence of such negotiation includes the names, addresses, and telephone numbers of DBE companies that were considered; a description of the information provided regarding the plans and specifications for the work selected for subcontracting; and evidence as to why additional agreements could not be reached for DBE companies to perform the work.  
  
b. A bidder using good business judgment would consider a number of factors in negotiating with subcontractors, including DBE subcontractors, and would take a firm's price and capabilities as well as contract goals into consideration. However, the fact that there may be some additional costs involved in finding and using DBE companies is not in itself sufficient reason for a bidder's failure to meet the contract DBE goal, as long as such costs are reasonable. Also the ability or desire of a bidder to perform the work of a contract with its own organization does not relieve the bidder of the responsibility to make good faith efforts. Bidders are not, however, required to accept higher quotes from DBE companies if the price difference is excessive or unreasonable.
- (5) Not rejecting DBE companies as being unqualified without sound reasons based on a thorough investigation of their capabilities. The bidder's standing within its industry, membership in specific groups, organizations, or associations and political or social affiliations (for example union vs. non-union employee status) are not legitimate causes for the rejection or non-solicitation of bids in the bidder's efforts to meet the project goal.

- (6) Making efforts to assist interested DBE companies in obtaining bonding, lines of credit, or insurance as required by the recipient or Contractor.
  - (7) Making efforts to assist interested DBE companies in obtaining necessary equipment, supplies, materials, or related assistance or services.
  - (8) Effectively using the services of available minority/women community organizations; minority/women contractors' groups; local, state, and federal minority/women business assistance offices; and other organizations as allowed on a case-by-case basis to provide assistance in the recruitment and placement of DBE companies.
- (b) If the Department determines that the apparent successful bidder has made a good faith effort to secure the work commitment of DBE companies to meet the contract goal, the Department will award the contract provided that it is otherwise eligible for award. If the Department determines that the bidder has failed to meet the requirements of this Special Provision or that a good faith effort has not been made, the Department will notify the responsible company official designated in the Utilization Plan that the bid is not responsive. The notification shall include a statement of reasons for the determination.
- (c) The bidder may request administrative reconsideration of a determination adverse to the bidder within the five working days after the receipt of the notification date of the determination by delivering the request to the Department of Transportation, Bureau of Small Business Enterprises, Contract Compliance Section, 2300 South Dirksen Parkway, Room 319, Springfield, Illinois 62764 (Telefax: (217)785-1524). Deposit of the request in the United States mail on or before the fifth business day shall not be deemed delivery. The determination shall become final if a request is not made and delivered. A request may provide additional written documentation and/or argument concerning the issues raised in the determination statement of reasons, provided the documentation and arguments address efforts made prior to submitting the bid. The request will be forwarded to the Department's Reconsideration Officer. The Reconsideration Officer will extend an opportunity to the bidder to meet in person in order to consider all issues of documentation and whether the bidder made a good faith effort to meet the goal. After the review by the Reconsideration Officer, the bidder will be sent a written decision within ten working days after receipt of the request for consideration, explaining the basis for finding that the bidder did or did not meet the goal or make adequate good faith efforts to do so. A final decision by the Reconsideration Officer that a good faith effort was made shall approve the Utilization Plan submitted by the bidder and shall clear the contract for award. A final decision that a good faith effort was not made shall render the bid not responsive.

CALCULATING DBE PARTICIPATION. The Utilization Plan values represent work anticipated to be performed and paid for upon satisfactory completion. The Department is only able to count toward the achievement of the overall goal and the contract goal the value of payments made for the work actually performed by DBE companies. In addition, a DBE must perform a commercially useful function on the contract to be counted. A commercially useful function is

generally performed when the DBE is responsible for the work and is carrying out its responsibilities by actually performing, managing, and supervising the work involved. The Department and Contractor are governed by the provisions of 49 CFR Part 26.55(c) on questions of commercially useful functions as it affects the work. Specific counting guidelines are provided in 49 CFR Part 26.55, the provisions of which govern over the summary contained herein.

- (a) DBE as the Contractor: 100 percent goal credit for that portion of the work performed by the DBE's own forces, including the cost of materials and supplies. Work that a DBE subcontracts to a non-DBE does not count toward the DBE goals.
- (b) DBE as a joint venture Contractor: 100 percent goal credit for that portion of the total dollar value of the contract equal to the distinct, clearly defined portion of the work performed by the DBE's own forces.
- (c) DBE as a subcontractor: 100 percent goal credit for the work of the subcontract performed by the DBE's own forces, including the cost of materials and supplies, excluding the purchase of materials and supplies or the lease of equipment by the DBE subcontractor from the prime Contractor or its affiliates. Work that a DBE subcontractor in turn subcontracts to a non-DBE does not count toward the DBE goal.
- (d) DBE as a trucker: 100 percent goal credit for trucking participation provided the DBE is responsible for the management and supervision of the entire trucking operation for which it is responsible. At least one truck owned, operated, licensed, and insured by the DBE must be used on the contract. Credit will be given for the following:
  - (1) The DBE may lease trucks from another DBE firm, including an owner-operator who is certified as a DBE. The DBE who leases trucks from another DBE receives credit for the total value of the transportation services the lessee DBE provides on the contract.
  - (2) The DBE may also lease trucks from a non-DBE firm, including from an owner-operator. The DBE who leases trucks from a non-DBE is entitled to credit only for the fee or commission it receives as a result of the lease arrangement.
- (e) DBE as a material supplier:
  - (1) 60 percent goal credit for the cost of the materials or supplies purchased from a DBE regular dealer.
  - (2) 100 percent goal credit for the cost of materials or supplies obtained from a DBE manufacturer.
  - (3) 100 percent credit for the value of reasonable fees and commissions for the procurement of materials and supplies if not a regular dealer or manufacturer.



CONTRACT COMPLIANCE. Compliance with this Special Provision is an essential part of the contract. The Department is prohibited by federal regulations from crediting the participation of a DBE included in the Utilization Plan toward either the contract goal or the Department's overall goal until the amount to be applied toward the goals has been paid to the DBE. The following administrative procedures and remedies govern the compliance by the Contractor with the contractual obligations established by the Utilization Plan. After approval of the Utilization Plan and award of the contract, the Utilization Plan and individual DBE Participation Statements become part of the contract. If the Contractor did not succeed in obtaining enough DBE participation to achieve the advertised contract goal, and the Utilization Plan was approved and contract awarded based upon a determination of good faith, the total dollar value of DBE work calculated in the approved Utilization Plan as a percentage of the awarded contract value shall become the amended contract goal. All work indicated for performance by an approved DBE shall be performed, managed, and supervised by the DBE executing the Participation Statement.

- (a) NO AMENDMENT. No amendment to the Utilization Plan may be made without prior written approval from the Department's Bureau of Small Business Enterprises. All requests for amendment to the Utilization Plan shall be submitted to the Department of Transportation, Bureau of Small Business Enterprises, Contract Compliance Section, 2300 South Dirksen Parkway, Room 319, Springfield, Illinois 62764. Telephone number (217)785-4611. Telefax number (217)785-1524.
- (b) TERMINATION OR REPLACEMENT. The Contractor shall not terminate or replace a DBE listed on the approved Utilization Plan, or perform with other forces work designated for a listed DBE except as provided in the Special Provision.
- (c) CHANGES TO WORK. Any deviation from the DBE condition-of-award or contract plans, specifications, or special provisions must be approved, in writing, by the Department as provided elsewhere in the Contract. The Contractor shall notify affected DBEs in writing of any changes in the scope of work which result in a reduction in the dollar amount condition-of-award to the contract. Where the revision includes work committed to a new DBE subcontractor, not previously involved in the project, then a Request for Approval of Subcontractor, Department form BC 260A, must be signed and submitted. If the commitment of work is in the form of additional tasks assigned to an existing subcontract, then a new Request for Approval of Subcontractor shall not be required. However, the Contractor must document efforts to assure that the existing DBE subcontractor is capable of performing the additional work and has agreed in writing to the change.
- (d) ALTERNATIVE WORK METHODS. In addition to the above requirements for reductions in the condition of award, additional requirements apply to the two cases of Contractor-initiated work substitution proposals. Where the contract allows alternate work methods which serve to delete or create underruns in condition of award DBE work, and the Contractor selects that alternate method or, where the Contractor proposes a substitute work method or material that serves to diminish or delete work committed to a DBE and replace it with other work, then the Contractor must demonstrate one of the following:

- (1) That the replacement work will be performed by the same DBE (as long as the DBE is certified in the respective item of work) in a modification of the condition of award; or
- (2) That the DBE is aware that its work will be deleted or will experience underruns and has agreed in writing to the change. If this occurs, the Contractor shall substitute other work of equivalent value to a certified DBE or provide documentation of good faith efforts to do so; or
- (3) That the DBE is not capable of performing the replacement work or has declined to perform the work at a reasonable competitive price. If this occurs, the Contractor shall substitute other work of equivalent value to a certified DBE or provide documentation of good faith efforts to do so.

(e) TERMINATION AND REPLACEMENT PROCEDURES. The Contractor shall not terminate or replace a DBE subcontractor listed in the approved Utilization Plan without prior written consent. This includes, but is not limited to, instances in which the Contractor seeks to perform work originally designated for a DBE subcontractor with its own forces or those of an affiliate, a non-DBE firm, or with another DBE firm. Written consent will be granted only if the Bureau of Small Business Enterprises agrees, for reasons stated in its concurrence document, that the Contractor has good cause to terminate or replace the DBE firm. Before transmitting to the Bureau of Small Business Enterprises any request to terminate and/or substitute a DBE subcontractor, the Contractor shall give notice in writing to the DBE subcontractor, with a copy to the Bureau, of its intent to request to terminate and/or substitute, and the reason for the request. The Contractor shall give the DBE five days to respond to the Contractor's notice. The DBE so notified shall advise the Bureau and the Contractor of the reasons, if any, why it objects to the proposed termination of its subcontract and why the Bureau should not approve the Contractor's action. If required in a particular case as a matter of public necessity, the Bureau may provide a response period shorter than five days.

For purposes of this paragraph, good cause includes the following circumstances:

- (1) The listed DBE subcontractor fails or refuses to execute a written contract;
- (2) The listed DBE subcontractor fails or refuses to perform the work of its subcontract in a way consistent with normal industry standards. Provided, however, that good cause does not exist if the failure or refusal of the DBE subcontractor to perform its work on the subcontract results from the bad faith or discriminatory action of the prime contractor;
- (3) The listed DBE subcontractor fails or refuses to meet the prime Contractor's reasonable, nondiscriminatory bond requirements;

- (4) The listed DBE subcontractor becomes bankrupt, insolvent, or exhibits credit unworthiness;
- (5) The listed DBE subcontractor is ineligible to work on public works projects because of suspension and debarment proceedings pursuant 2 CFR Parts 180, 215 and 1,200 or applicable state law.
- (6) You have determined that the listed DBE subcontractor is not a responsible contractor;
- (7) The listed DBE subcontractor voluntarily withdraws from the projects and provides to you written notice of its withdrawal;
- (8) The listed DBE is ineligible to receive DBE credit for the type of work required;
- (9) A DBE owner dies or becomes disabled with the result that the listed DBE contractor is unable to complete its work on the contract;
- (10) Other documented good cause that compels the termination of the DBE subcontractor. Provided, that good cause does not exist if the prime Contractor seeks to terminate a DBE it relied upon to obtain the contract so that the prime Contractor can self-perform the work for which the DBE contractor was engaged or so that the prime Contractor can substitute another DBE or non-DBE contractor after contract award.

When a DBE is terminated, or fails to complete its work on the Contract for any reason the Contractor shall make a good faith effort to find another DBE to substitute for the original DBE to perform at least the same amount of work under the contract as the terminated DBE to the extent needed to meet the established Contract goal.

- (f) PAYMENT RECORDS. The Contractor shall maintain a record of payments for work performed to the DBE participants. The records shall be made available to the Department for inspection upon request. After the performance of the final item of work or delivery of material by a DBE and final payment therefore to the DBE by the Contractor, but not later than thirty calendar days after payment has been made by the Department to the Contractor for such work or material, the Contractor shall submit a DBE Payment Agreement on Department form SBE 2115 to the Regional Engineer. If full and final payment has not been made to the DBE, the DBE Payment Agreement shall indicate whether a disagreement as to the payment required exists between the Contractor and the DBE or if the Contractor believes that the work has not been satisfactorily completed. If the Contractor does not have the full amount of work indicated in the Utilization Plan performed by the BDE companies indicated in the Utilization Plan and after good faith efforts are reviewed, the Department may deduct from contract payments to the Contractor the amount of the goal not achieved as liquidated and ascertained damages. The Contractor may request an administrative

| reconsideration of any amount deducted as damages pursuant to subsection (h) of this part.

| (g) ENFORCEMENT. The Department reserves the right to withhold payment to the Contractor to enforce the provisions of this Special Provision. Final payment shall not be made on the contract until such time as the Contractor submits sufficient documentation demonstrating achievement of the goal in accordance with this Special Provision or after liquidated damages have been determined and collected.

| (h) RECONSIDERATION. Notwithstanding any other provision of the contract, including but not limited to Article 109.09 of the Standard Specifications, the Contractor may request administrative reconsideration of a decision to deduct the amount of the goal not achieved as liquidated damages. A request to reconsider shall be delivered to the Contract Compliance Section and shall be handled and considered in the same manner as set forth in paragraph (c) of "Good Faith Effort Procedures" of this Special Provision, except a final decision that a good faith effort was not made during contract performance to achieve the goal agreed to in the Utilization Plan shall be the final administrative decision of the Department.

80029

**HOT-MIX ASPHALT – MIXTURE DESIGN COMPOSITION AND VOLUMETRIC REQUIREMENTS (BDE)**

Effective: November 1, 2013

Revise Article 406.14(b) of the Standard Specifications to read.

“(b) If the HMA placed during the initial test strip (1) is determined to be unacceptable to remain in place by the Engineer, and (2) was not produced within 2.0 to 6.0 percent air voids or within the individual control limits of the JMF, the mixture and test strip will not be paid for and the mixture shall be removed at the Contractor’s expense. An additional test strip and mixture will be paid for in full, if produced within 2.0 to 6.0 percent air voids and within the individual control limits of the JMF.”

Revise Article 406.14(c) of the Standard Specifications to read.

“(c) If the HMA placed during the initial test strip (1) is determined to be unacceptable to remain in place by the Engineer, and (2) was produced within 2.0 to 6.0 percent air voids and within the individual control limits of the JMF, the mixture shall be removed. Removal will be paid in accordance to Article 109.04. This initial mixture and test strip will be paid for at the contract unit prices. The additional mixture will be paid for at the contract unit price, and any additional test strips will be paid for at one half the unit price of each test strip.”

Revise Article 1030.04(a)(1) of the Standard Specifications to read.

“(1) High ESAL Mixtures. The Job Mix Formula (JMF) shall fall within the following limits.

| High ESAL, MIXTURE COMPOSITION (% PASSING) <sup>1/</sup> |            |                  |            |                  |            |                  |           |                  |            |     |
|--|------------|------------------|------------|------------------|------------|------------------|-----------|------------------|------------|-----|
| Sieve Size   | IL-25.0 mm |                  | IL-19.0 mm |                  | IL-12.5 mm |                  | IL-9.5 mm |                  | IL-4.75 mm |     |
|  | min        | max              | min        | max              | min        | max              | min       | max              | min        | max |
| 1 1/2 in (37.5 mm)                                       |            | 100              |            |                  |            |                  |           |                  |            |     |
| 1 in. (25 mm)  | 90         | 100              |            | 100              |            |                  |           |                  |            |     |
| 3/4 in. (19 mm)  |            | 90               | 82         | 100              |            | 100              |           |                  |            |     |
| 1/2 in. (12.5 mm)  | 45         | 75               | 50         | 85               | 90         | 100              |           | 100              |            | 100 |
| 3/8 in. (9.5 mm)   |            |                  |            |                  |            | 89               | 90        | 100              |            | 100 |
| #4 (4.75 mm)   | 24         | 42 <sup>2/</sup> | 24         | 50 <sup>2/</sup> | 28         | 65               | 32        | 69               | 90         | 100 |
| #8 (2.36 mm)   | 16         | 31               | 20         | 36               | 28         | 48 <sup>3/</sup> | 32        | 52 <sup>3/</sup> | 70         | 90  |
| #16 (1.18 mm)  | 10         | 22               | 10         | 25               | 10         | 32               | 10        | 32               | 50         | 65  |
| #50 (300 µm)   | 4          | 12               | 4          | 12               | 4          | 15               | 4         | 15               | 15         | 30  |
| #100 (150 µm)  | 3          | 9                | 3          | 9                | 3          | 10               | 3         | 10               | 10         | 18  |
| #200 (75 µm)   | 3          | 6                | 3          | 6                | 4          | 6                | 4         | 6                | 7          | 9   |

|                                 |  |     |  |     |  |     |  |     |  |                    |
|---------------------------------|--|-----|--|-----|--|-----|--|-----|--|--------------------|
| Ratio<br>Dust/Asphalt<br>Binder |  | 1.0 |  | 1.0 |  | 1.0 |  | 1.0 |  | 1.0 <sup>1/4</sup> |
|---------------------------------|--|-----|--|-----|--|-----|--|-----|--|--------------------|

- 1/ Based on percent of total aggregate weight.
- 2/ The mixture composition shall not exceed 40 percent passing the #4 (4.75 mm) sieve for binder courses with Ndesign ≥ 90.
- 3/ The mixture composition shall not exceed 44 percent passing the #8 (2.36 mm) sieve for surface courses with Ndesign ≥ 90.
- 4/ Additional minus No. 200 (0.075 mm) material required by the mix design shall be mineral filler, unless otherwise approved by the Engineer.”

Delete Article 1030.04(a)(4) of the Standard Specifications.

Revise Article 1030.04(b)(1) of the Standard Specifications to read.

“(1) High ESAL Mixtures. The target value for the air voids of the HMA shall be 4.0 percent at the design number of gyrations. The VMA and VFA of the HMA design shall be based on the nominal maximum size of the aggregate in the mix, and shall conform to the following requirements.

| VOLUMETRIC REQUIREMENTS<br>High ESAL |   |         |         |        |                       |   |
|--------------------------------------|---|---------|---------|--------|-----------------------|---|
| Ndesign                              | Voids in the Mineral Aggregate<br>(VMA),<br>% minimum |         |         |        |                       | Voids Filled<br>with Asphalt<br>Binder<br>(VFA),<br>% |
|                                      | IL-25.0   | IL-19.0 | IL-12.5 | IL-9.5 | IL-4.75 <sup>1/</sup> |   |
| 50                                   | 12.0  | 13.0    | 14.0    | 15.0   | 18.5                  | 65 – 78 <sup>2/</sup>                                 |
| 70                                   |   |         |         |        | 65 - 75               |   |
| 90                                   |   |         |         |        |                       |   |
| 105                                  |   |         |         |        |                       |   |

- 1/ Maximum Draindown for IL-4.75 shall be 0.3 percent
- 2/ VFA for IL-4.75 shall be 76-83 percent”

Delete Article 1030.04(b)(4) of the Standard Specifications.

Revise the Control Limits Table in Article 1030.05(d)(4) of the Standard Specifications to read.

|                 |
|-----------------|
| “CONTROL LIMITS |
|-----------------|

| Parameter                             | High ESAL<br>Low ESAL | High ESAL<br>Low ESAL | All Other          | IL-4.75              | IL-4.75              |
|---------------------------------------|-----------------------|-----------------------|--------------------|----------------------|----------------------|
|                                       | Individual<br>Test    | Moving Avg.<br>of 4   | Individual<br>Test | Individual<br>Test   | Moving<br>Avg. of 4  |
| % Passing: <sup>1/</sup>              |                       |                       |                    |                      |                      |
| 1/2 in. (12.5 mm)                     | ± 6 %                 | ± 4 %                 | ± 15 %             |                      |                      |
| No. 4 (4.75 mm)                       | ± 5 %                 | ± 4 %                 | ± 10 %             |                      |                      |
| No. 8 (2.36 mm)                       | ± 5 %                 | ± 3 %                 |                    |                      |                      |
| No. 16 (1.18 mm)                      |                       |                       |                    | ± 4 %                | ± 3 %                |
| No. 30 (600 µm)                       | ± 4 %                 | ± 2.5 %               |                    |                      |                      |
| Total Dust Content<br>No. 200 (75 µm) | ± 1.5 %               | ± 1.0 %               | ± 2.5 %            | ± 1.5 %              | ± 1.0 %              |
| Asphalt Binder Content                | ± 0.3 %               | ± 0.2 %               | ± 0.5 %            | ± 0.3 %              | ± 0.2 %              |
| Voids                                 | ± 1.2 %               | ± 1.0 %               | ± 1.2 %            | ± 1.2 %              | ± 1.0 %              |
| VMA                                   | -0.7 % <sup>2/</sup>  | -0.5 % <sup>2/</sup>  |                    | -0.7 % <sup>2/</sup> | -0.5 % <sup>2/</sup> |

1/ Based on washed ignition oven

2/ Allowable limit below minimum design VMA requirement"

80322

## HOT-MIX ASPHALT – MIXTURE DESIGN VERIFICATION AND PRODUCTION (BDE)

Effective: November 1, 2013

Description. This special provision provides the requirements for Hamburg Wheel and tensile strength testing for High ESAL, IL-4.75, and Stone Matrix Asphalt (SMA) hot-mix asphalt (HMA) mixes during mix design verification and production. This special provision also provides the plant requirements for hydrated lime addition systems used in the production of High ESAL, IL-4.75, and SMA mixes.

Mix Design Testing. Add the following to Article 1030.04 of the Standard Specifications:

“(d) Verification Testing. High ESAL, IL-4.75, and SMA mix designs submitted for verification will be tested to ensure that the resulting mix designs will pass the required criteria for the Hamburg Wheel Test (Illinois Modified AASHTO T 324) and the Tensile Strength Test (Illinois Modified AASHTO T 283). The Department will perform a verification test on gyratory specimens compacted by the Contractor. If the mix fails the Department’s verification test, the Contractor shall make necessary changes to the mix and provide passing Hamburg Wheel and tensile strength test results from a private lab. The Department will verify the passing results.

All new and renewal mix designs shall meet the following requirements for verification testing.

(1) Hamburg Wheel Test Criteria. The maximum allowable rut depth shall be 0.5 in. (12.5 mm). The minimum number of wheel passes at the 0.5 in. (12.5 mm) rut depth criteria shall be based on the high temperature binder grade of the mix as specified in the mix requirements table of the plans.

Illinois Modified AASHTO T 324 Requirements <sup>1/</sup>

| PG Grade             | Number of Passes |
|----------------------|------------------|
| PG 58-xx (or lower)  | 5,000            |
| PG 64-xx             | 7,500            |
| PG 70-xx             | 15,000           |
| PG 76-xx (or higher) | 20,000           |

<sup>1/</sup> When produced at temperatures of  $275 \pm 5$  °F ( $135 \pm 3$  °C) or less, loose Warm Mix Asphalt shall be oven aged at  $270 \pm 5$  °F ( $132 \pm 3$  °C) for two hours prior to gyratory compaction of Hamburg Wheel specimens.

(2) Tensile Strength Criteria. The minimum allowable conditioned tensile strength shall be 415 kPa (60 psi) for non-polymer modified performance graded (PG) asphalt binder and 550 kPa (80 psi) for polymer modified PG asphalt binder. The maximum allowable unconditioned tensile strength shall be 1380 kPa (200 psi).”



Production Testing. Revise Article 1030.06(a) of the Standard Specifications to read:

“(a) High ESAL, IL-4.75 and SMA Mixtures. For each contract, a 300 ton (275 metric tons) test strip will be required at the beginning of HMA production for each mixture with a quantity of 3000 tons (2750 metric tons) or more according to the Manual of Test Procedures for Materials “Hot Mix Asphalt Test Strip Procedures”.

Before start-up, target values shall be determined by applying gradation correction factors to the JMF when applicable. These correction factors shall be determined from previous experience. The target values, when approved by the Engineer, shall be used to control HMA production. Plant settings and control charts shall be set according to target values.

Before constructing the test strip, target values shall be determined by applying gradation correction factors to the JMF when applicable. After any JMF adjustment, the JMF shall become the Adjusted Job Mix Formula (AJMF). Upon completion of the first acceptable test strip, the JMF shall become the AJMF regardless of whether or not the JMF has been adjusted. If an adjustment/plant change is made, the Engineer may require a new test strip to be constructed. If the HMA placed during the initial test strip is determined to be unacceptable to remain in place by the Engineer, it shall be removed and replaced.

The limitations between the JMF and AJMF are as follows.

| Parameter              | Adjustment |
|------------------------|------------|
| 1/2 in. (12.5 mm)      | ± 5.0 %    |
| No. 4 (4.75 mm)        | ± 4.0 %    |
| No. 8 (2.36 mm)        | ± 3.0 %    |
| No. 30 (600 µm)        | *          |
| No. 200 (75 µm)        | *          |
| Asphalt Binder Content | ± 0.3 %    |

\* In no case shall the target for the amount passing be greater than the JMF.

Any adjustments outside the above limitations will require a new mix design.

Mixture sampled to represent the test strip shall include additional material sufficient for the Department to conduct Hamburg Wheel testing according to Illinois Modified AASHTO T324 (approximately 60 lb (27 kg) total).

The Contractor shall immediately cease production upon notification by the Engineer of failing Hamburg Wheel test. All prior produced material may be paved out provided all other mixture criteria is being met. No additional mixture shall be produced until the Engineer receives passing Hamburg Wheel tests.

The Department may conduct additional Hamburg Wheel tests on production material as determined by the Engineer.”

Revise the title of Article 1030.06(b) of the Standard Specifications to read:

“(b) Low ESAL and All Other Mixtures.”

System for Hydrated Lime Addition. Revise the fourth sentence of the third paragraph of Article 1030.04(c) of the Standard Specifications to read:

“The method of application shall be according to Article 1102.01(a)(10).”

Replace the first three sentences of the second paragraph of Article 1102.01(a)(10) of the Standard Specifications to read:

“When hydrated lime is used as the anti-strip additive, a separate bin or tank and feeder system shall be provided to store and accurately proportion the lime onto the aggregate either as a slurry, as dry lime applied to damp aggregates, or as dry lime injected onto the hot aggregates prior to adding the liquid asphalt cement. If the hydrated lime is added either as a slurry or as dry lime on damp aggregates, the lime and aggregates shall be mixed by a power driven pugmill to provide a uniform coating of the lime prior to entering the dryer. If dry hydrated lime is added to the hot dry aggregates in a dryer-drum plant, the lime shall be added in such a manner that the lime will not become entrained into the air stream of the dryer-drum and that thorough dry mixing shall occur prior to the injection point of the liquid asphalt. When a batch plant is used, the hydrated lime shall be added to the mixture in the weigh hopper or as approved by the Engineer.”

Basis of Payment. Replace the seventh paragraph of Article 406.14 of the Standard Specifications with the following:

“For mixes designed and verified under the Hamburg Wheel criteria, the cost of furnishing and introducing anti-stripping additives in the HMA will not be paid for separately, but shall be considered as included in the contract unit price of the HMA item involved.

If an anti-stripping additive is required for any other HMA mix, the cost of the additive will be paid for according to Article 109.04. The cost incurred in introducing the additive into the HMA will not be paid for separately, but shall be considered as included in the contract unit price of the HMA item involved.

No additional compensation will be awarded to the Contractor because of reduced production rates associated with the addition of the anti-stripping additive.”

## PAYROLLS AND PAYROLL RECORDS (BDE)

Effective: January 1, 2014

FEDERAL AID CONTRACTS. Revise the following section of Check Sheet #1 of the Recurring Special Provisions to read:

### "STATEMENTS AND PAYROLLS

The payroll records shall include the worker's name, the worker's address, the worker's telephone number when available, the worker's social security number, the worker's classification or classifications, the worker's gross and net wages paid in each pay period, the worker's number of hours worked each day, the worker's starting and ending times of work each day. However, any Contractor or subcontractor who remits contributions to a fringe benefit fund that is not jointly maintained and jointly governed by one or more employers and one or more labor organization must additionally submit the worker's hourly wage rate, the worker's hourly overtime wage rate, the worker's hourly fringe benefit rates, the name and address of each fringe benefit fund, the plan sponsor of each fringe benefit, if applicable, and the plan administrator of each fringe benefit, if applicable.

The Contractor and each subcontractor shall submit payroll records to the Engineer each week from the start to the completion of their respective work, except that full social security numbers and home addresses shall not be included on weekly transmittals. Instead, the payrolls shall include an identification number for each employee (e.g., the last four digits of the employee's social security number). In addition, starting and ending times of work each day may be omitted from the payroll records submitted to the Engineer. The submittals shall be on the Department's form SBE 48, or an approved facsimile. When there has been no activity during a work week, a payroll record shall still be submitted with the appropriate box ("No Work", "Suspended", or "Complete") checked on the form."

STATE CONTRACTS. Revise Section IV of Check Sheet #5 of the Recurring Special Provisions to read:

### "IV. COMPLIANCE WITH THE PREVAILING WAGE ACT

1. Prevailing Wages. All wages paid by the Contractor and each subcontractor shall be in compliance with The Prevailing Wage Act (820 ILCS 130), as amended, except where a prevailing wage violates a federal law, order, or ruling, the rate conforming to the federal law, order, or ruling shall govern. The Contractor shall be responsible to notify each subcontractor of the wage rates set forth in this contract and any revisions thereto. If the Department of Labor revises the wage rates, the Contractor will not be allowed additional compensation on account of said revisions.
2. Payroll Records. The Contractor and each subcontractor shall make and keep, for a period of five years from the later of the date of final payment under the contract or completion of the contract, records of the wages paid to his/her workers. The payroll records shall include the worker's name, the worker's address, the worker's telephone number when available, the worker's social security number, the worker's classification or classifications, the worker's gross and net wages paid in each pay period, the worker's number of hours worked each day, the worker's starting and ending times of work each day. However, any contractor or subcontractor who remits contributions to a

fringe benefit fund that is not jointly maintained and jointly governed by one or more employers and one or more labor organization must additionally submit the worker's hourly wage rate, the worker's hourly overtime wage rate, the worker's hourly fringe benefit rates, the name and address of each fringe benefit fund, the plan sponsor of each fringe benefit, if applicable, and the plan administrator of each fringe benefit, if applicable. Upon seven business days' notice, these records shall be available at a location within the State, during reasonable hours, for inspection by the Department or the Department of Labor; and Federal, State, or local law enforcement agencies and prosecutors.

3. Submission of Payroll Records. The Contractor and each subcontractor shall submit payroll records to the Engineer each week from the start to the completion of their respective work, except that full social security numbers and home addresses shall not be included on weekly transmittals. Instead the payrolls shall include an identification number for each employee (e.g., the last four digits of the employee's social security number). In addition, starting and ending times of work each day may be omitted from the payroll records submitted to the Engineer. The submittals shall be on the Department's form SBE 48, or an approved facsimile. When there has been no activity during a work week, a payroll record shall still be submitted with the appropriate box ("No Work", "Suspended", or "Complete") checked on the form.

Each submittal shall be accompanied by a statement signed by the Contractor or subcontractor, or an officer, employee, or officer thereof, which avers that: (i) he or she has examined the records and such records are true and accurate; (ii) the hourly rate paid to each worker is not less than the general prevailing rate of hourly wages required by the Act; and (iii) the Contractor or subcontractor is aware that filing a payroll record that he/she knows to be false is a Class A misdemeanor.

4. Employee Interviews. The Contractor and each subcontractor shall permit his/her employees to be interviewed on the job, during working hours, by compliance investigators of the Department or the Department of Labor."

80331

*Fl*

## PROGRESS PAYMENTS (BDE)

Effective: November 2, 2013

Revise Article 109.07(a) of the Standard Specifications to read:

“(a) Progress Payments. At least once each month, the Engineer will make a written estimate of the quantity of work performed in accordance with the contract, and the value thereof at the contract unit prices. The amount of the estimate approved as due for payment will be vouchered by the Department and presented to the State Comptroller for payment. No amount less than \$1000.00 will be approved for payment other than the final payment.

Progress payments may be reduced by liens filed pursuant to Section 23(c) of the Mechanics' Lien Act, 770 ILCS 60/23(c).

If a Contractor or subcontractor has defaulted on a loan issued under the Department's Disadvantaged Business Revolving Loan Program (20 ILCS 2705/2705-610), progress payments may be reduced pursuant to the terms of that loan agreement. In such cases, the amount of the estimate related to the work performed by the Contractor or subcontractor, in default of the loan agreement, will be offset, in whole or in part, and vouchered by the Department to the Working Capital Revolving Fund or designated escrow account. Payment for the work shall be considered as issued and received by the Contractor or subcontractor on the date of the offset voucher. Further, the amount of the offset voucher shall be a credit against the Department's obligation to pay the Contractor, the Contractor's obligation to pay the subcontractor, and the Contractor's or subcontractor's total loan indebtedness to the Department. The offset shall continue until such time as the entire loan indebtedness is satisfied. The Department will notify the Contractor and Fund Control Agent in a timely manner of such offset. The Contractor or subcontractor shall not be entitled to additional payment in consideration of the offset.

The failure to perform any requirement, obligation, or term of the contract by the Contractor shall be reason for withholding any progress payments until the Department determines that compliance has been achieved.”

80328

**RAILROAD PROTECTIVE LIABILITY INSURANCE (5 and 10) (BDE)**

Effective: January 1, 2006

Description. Railroad Protective Liability and Property Damage Liability Insurance shall be carried in accordance with Article 107.11 of the Standard Specifications, except the limits shall be a minimum of \$5,000,000 combined single limit per occurrence for bodily injury liability and property damage liability with an aggregate limit of \$10,000,000 over the life of the policy. A separate policy is required for each railroad indicated below unless otherwise noted.

---

| NAMED INSURED & ADDRESS  | NUMBER AND SPEED OF PASSENGER TRAINS | NUMBER & SPEED OF FREIGHT TRAINS |
|--|--------------------------------------|----------------------------------|
| CSX Transportation, Inc.<br>500 Water St C907<br>Jacksonville, FL. 32202 | None                                 | 1/30MPH                          |
| DOT/AAR No-542441U   | Mile Post-98.34                      |                                  |
| Division-NS  | Sub Division-DANVILLE SEC            |                                  |

---

**FOR FREIGHT/PASSENGER INFORMATION CONTACT:**

Mr. Ben Ewing, Roadmaster

Phone: (217) 722-7993

**FOR INSURANCE INFORMATION CONTACT:**

Mr. Jonathan MacArthur, Manager Risk Management

Phone: 904-359-1194

---

**APPROVAL OF INSURANCE:** The ORIGINAL and one CERTIFIED copy of each required policy shall be submitted to the following address for approval:

Illinois Department of Transportation  
Bureau of Design and Environment  
2300 South Dirksen Parkway, Room 326  
Springfield, Illinois 62764

The Contractor will be advised when the Department has received approval of the insurance from the railroad(s). Before any work begins on railroad right-of-way, the Contractor shall submit to the Engineer evidence that the required insurance has been approved by the railroad(s). The Contractor shall also provide the Engineer with the expiration date of each required policy.

**Basis of Payment:** Providing Railroad Protective Liability and Property Damage Insurance will be paid for at the contract unit price per Lump Sum for RAILROAD PROTECTIVE LIABILITY INSURANCE.

## RECLAIMED ASPHALT PAVEMENT AND RECLAIMED ASPHALT SHINGLES (BDE)

Effective: November 1, 2012

Revise: April 1, 2014

Revise Section 1031 of the Standard Specifications to read:

### **“SECTION 1031. RECLAIMED ASPHALT PAVEMENT AND RECLAIMED ASPHALT SHINGLES**

**1031.01 Description.** Reclaimed asphalt pavement and reclaimed asphalt shingles shall be according to the following.

- (a) Reclaimed Asphalt Pavement (RAP). RAP is the material produced by cold milling or crushing an existing hot-mix asphalt (HMA) pavement. The Contractor shall supply written documentation that the RAP originated from routes or airfields under federal, state, or local agency jurisdiction.
  
- (b) Reclaimed Asphalt Shingles (RAS). Reclaimed asphalt shingles (RAS). RAS is from the processing and grinding of preconsumer or post-consumer shingles. RAS shall be a clean and uniform material with a maximum of 0.5 percent unacceptable material, as defined in Bureau of Materials and Physical Research Policy Memorandum “Reclaimed Asphalt Shingle (RAS) Sources”, by weight of RAS. All RAS used shall come from a Bureau of Materials and Physical Research approved processing facility where it shall be ground and processed to 100 percent passing the 3/8 in. (9.5 mm) sieve and 93 percent passing the #4 (4.75 mm) sieve based on a dry shake gradation. RAS shall be uniform in gradation and asphalt binder content and shall meet the testing requirements specified herein. In addition, RAS shall meet the following Type 1 or Type 2 requirements.
  - (1) Type 1. Type 1 RAS shall be processed, preconsumer asphalt shingles salvaged from the manufacture of residential asphalt roofing shingles.
  
  - (2) Type 2. Type 2 RAS shall be processed post-consumer shingles only, salvaged from residential, or four unit or less dwellings not subject to the National Emission Standards for Hazardous Air Pollutants (NESHAP).

**1031.02 Stockpiles.** RAP and RAS stockpiles shall be according to the following.

- (a) RAP Stockpiles. The Contractor shall construct individual, sealed RAP stockpiles meeting one of the following definitions. No additional RAP shall be added to the pile after the pile has been sealed. Stockpiles shall be sufficiently separated to prevent intermingling at the base. Stockpiles shall be identified by signs indicating the type as listed below (i.e. “Homogeneous Surface”).

Prior to milling, the Contractor shall request the District provide documentation on the quality of the RAP to clarify the appropriate stockpile.

- (1) Fractionated RAP (FRAP). FRAP shall consist of RAP from Class I, HMA (High and Low ESAL) mixtures. The coarse aggregate in FRAP shall be crushed aggregate and may represent more than one aggregate type and/or quality but shall be at least C quality. All FRAP shall be fractionated prior to testing by screening into a minimum of two size fractions with the separation occurring on or between the #4 (4.75 mm) and 1/2 in. (12.5 mm) sieves. Agglomerations shall be minimized such that 100 percent of the RAP shall pass the sieve size specified below for the mix into which the FRAP will be incorporated.

| Mixture FRAP will be used in: | Sieve Size that 100% of FRAP Shall Pass |
|-------------------------------|---|
| IL-25.0                       | 2 in. (50 mm)                           |
| IL-19.0                       | 1 1/2 in. (40 mm)                       |
| IL-12.5                       | 1 in. (25 mm)                           |
| IL-9.5                        | 3/4 in. (20 mm)                         |
| IL-4.75                       | 1/2 in. (13 mm)                         |

- (2) Homogeneous. Homogeneous RAP stockpiles shall consist of RAP from Class I, HMA (High and Low ESAL) mixtures and represent: 1) the same aggregate quality, but shall be at least C quality; 2) the same type of crushed aggregate (either crushed natural aggregate, ACBF slag, or steel slag); 3) similar gradation; and 4) similar asphalt binder content. If approved by the Engineer, combined single pass surface/binder millings may be considered "homogenous" with a quality rating dictated by the lowest coarse aggregate quality present in the mixture.
- (3) Conglomerate. Conglomerate RAP stockpiles shall consist of RAP from Class I, HMA (High and Low ESAL) mixtures. The coarse aggregate in this RAP shall be crushed aggregate and may represent more than one aggregate type and/or quality but shall be at least C quality. This RAP may have an inconsistent gradation and/or asphalt binder content prior to processing. All conglomerate RAP shall be processed prior to testing by crushing to where all RAP shall pass the 5/8 in. (16 mm) or smaller screen. Conglomerate RAP stockpiles shall not contain steel slag.
- (4) Conglomerate "D" Quality (DQ). Conglomerate DQ RAP stockpiles shall consist of RAP from Class I, HMA (High or Low ESAL), or "All Other" (as defined by Article 1030.04(a)(3)) mixtures. The coarse aggregate in this RAP may be crushed or round but shall be at least D quality. This RAP may have an inconsistent gradation and/or asphalt binder content. Conglomerate DQ RAP stockpiles shall not contain steel slag.
- (5) Non-Quality. RAP stockpiles that do not meet the requirements of the stockpile categories listed above shall be classified as "Non-Quality".



RAP/FRAP containing contaminants, such as earth, brick, sand, concrete, sheet asphalt, bituminous surface treatment (i.e. chip seal), pavement fabric, joint sealants, etc., will be unacceptable unless the contaminants are removed to the satisfaction of the Engineer. Sheet asphalt shall be stockpiled separately.

- (b) RAS Stockpiles. Type 1 and Type 2 RAS shall be stockpiled separately and shall not be intermingled. Each stockpile shall be signed indicating what type of RAS is present.

Unless otherwise specified by the Engineer, mechanically blending manufactured sand (FM 20 or FM 22) up to an equal weight of RAS with the processed RAS will be permitted to improve workability. The sand shall be "B Quality" or better from an approved Aggregate Gradation Control System source. The sand shall be accounted for in the mix design and during HMA production.

Records identifying the shingle processing facility supplying the RAS, RAS type and lot number shall be maintained by project contract number and kept for a minimum of three years.

**1031.03 Testing.** RAP/FRAP and RAS testing shall be according to the following.

- (a) RAP/FRAP Testing. When used in HMA, the RAP/FRAP shall be sampled and tested either during or after stockpiling.

(1) During Stockpiling. For testing during stockpiling, washed extraction samples shall be run at the minimum frequency of one sample per 500 tons (450 metric tons) for the first 2000 tons (1800 metric tons) and one sample per 2000 tons (1800 metric tons) thereafter. A minimum of five tests shall be required for stockpiles less than 4000 tons (3600 metric tons).

(2) After Stockpiling. For testing after stockpiling, the Contractor shall submit a plan for approval to the District proposing a satisfactory method of sampling and testing the RAP/FRAP pile either in-situ or by restockpiling. The sampling plan shall meet the minimum frequency required above and detail the procedure used to obtain representative samples throughout the pile for testing.

Each sample shall be split to obtain two equal samples of test sample size. One of the two test samples from the final split shall be labeled and stored for Department use. The Contractor shall extract the other test sample according to Department procedure. The Engineer reserves the right to test any sample (split or Department-taken) to verify Contractor test results.

- (b) RAS Testing. RAS or RAS blended with manufactured sand shall be sampled and tested during stockpiling according to Illinois Department of Transportation Policy Memorandum, "Reclaimed Asphalt Shingle (RAS) Source".

Samples shall be collected during stockpiling at the minimum frequency of one sample per 200 tons (180 metric tons) for the first 1000 tons (900 metric tons) and one sample per 250 tons (225 metric tons) thereafter. A minimum of five samples are required for stockpiles less than 1000 tons (900 metric tons). Once a  $\leq 1000$  ton (900 metric ton), five-sample/test stockpile has been established it shall be sealed. Additional incoming RAS or RAS blended with manufactured sand shall be stockpiled in a separate working pile as designated in the Quality Control plan and only added to the sealed stockpile when the test results of the working pile are complete and are found to meet the tolerances specified herein for the original sealed RAS stockpile.

Before testing, each sample shall be split to obtain two test samples. One of the two test samples from the final split shall be labeled and stored for Department use. The Contractor shall perform a washed extraction and test for unacceptable materials on the other test sample according to Department procedures. The Engineer reserves the right to test any sample (split or Department-taken) to verify Contractor test results.

If the sampling and testing was performed at the shingle processing facility in accordance with the QC Plan, the Contractor shall obtain and make available all of the test results from start of the initial stockpile.

**1031.04 Evaluation of Tests.** Evaluation of tests results shall be according to the following.

- (a) Evaluation of RAP/FRAP Test Results. All of the extraction results shall be compiled and averaged for asphalt binder content and gradation and, when applicable  $G_{mm}$ . Individual extraction test results, when compared to the averages, will be accepted if within the tolerances listed below.

| Parameter                   | FRAP/Homogeneous /Conglomerate | Conglomerate "D" Quality |
|-----------------------------|--------------------------------|--------------------------|
| 1 in. (25 mm)               |                                | $\pm 5 \%$               |
| 1/2 in. (12.5 mm)           | $\pm 8 \%$                     | $\pm 15 \%$              |
| No. 4 (4.75 mm)             | $\pm 6 \%$                     | $\pm 13 \%$              |
| No. 8 (2.36 mm)             | $\pm 5 \%$                     |                          |
| No. 16 (1.18 mm)            |                                | $\pm 15 \%$              |
| No. 30 (600 $\mu\text{m}$ ) | $\pm 5 \%$                     |                          |
| No. 200 (75 $\mu\text{m}$ ) | $\pm 2.0 \%$                   | $\pm 4.0 \%$             |
| Asphalt Binder              | $\pm 0.4 \%$ <sup>1/</sup>     | $\pm 0.5 \%$             |
| $G_{mm}$                    | $\pm 0.03$                     |                          |

1/ The tolerance for FRAP shall be  $\pm 0.3 \%$ .

If more than 20 percent of the individual sieves and/or asphalt binder content tests are out of the above tolerances, the RAP/FRAP shall not be used in HMA unless the

RAP/FRAP representing the failing tests is removed from the stockpile. All test data and acceptance ranges shall be sent to the District for evaluation.

With the approval of the Engineer, the ignition oven may be substituted for extractions according to the Illinois Test Procedure, "Calibration of the Ignition Oven for the Purpose of Characterizing Reclaimed Asphalt Pavement (RAP)".

- (b) Evaluation of RAS and RAS Blended with Manufactured Sand Test Results. All of the test results, with the exception of percent unacceptable materials, shall be compiled and averaged for asphalt binder content and gradation. Individual test results, when compared to the averages, will be accepted if within the tolerances listed below.

| Parameter              | RAS     |
|------------------------|---------|
| No. 8 (2.36 mm)        | ± 5 %   |
| No. 16 (1.18 mm)       | ± 5 %   |
| No. 30 (600 µm)        | ± 4 %   |
| No. 200 (75 µm)        | ± 2.0 % |
| Asphalt Binder Content | ± 1.5 % |

If more than 20 percent of the individual sieves and/or asphalt binder content tests are out of the above tolerances, or if the percent unacceptable material exceeds 0.5 percent by weight of material retained on the # 4 (4.75 mm) sieve, the RAS or RAS blend shall not be used in Department projects. All test data and acceptance ranges shall be sent to the District for evaluation.

**1031.05 Quality Designation of Aggregate in RAP/FRAP.**

- (a) RAP. The aggregate quality of the RAP for homogenous, conglomerate, and conglomerate "D" quality stockpiles shall be set by the lowest quality of coarse aggregate in the RAP stockpile and are designated as follows.
- (1) RAP from Class I, Superpave/HMA (High ESAL), or (Low ESAL) IL-9.5L surface mixtures are designated as containing Class B quality coarse aggregate.
  - (2) RAP from Superpave/HMA (Low ESAL) IL-19.0L binder mixture is designated as Class D quality coarse aggregate.
  - (3) RAP from Class I, Superpave/HMA (High ESAL) binder mixtures, bituminous base course mixtures, and bituminous base course widening mixtures are designated as containing Class C quality coarse aggregate.
  - (4) RAP from bituminous stabilized subbase and BAM shoulders are designated as containing Class D quality coarse aggregate.
- (b) FRAP. If the Engineer has documentation of the quality of the FRAP aggregate, the Contractor shall use the assigned quality provided by the Engineer.

If the quality is not known, the quality shall be determined as follows. Coarse and fine FRAP stockpiles containing plus #4 (4.75 mm) sieve coarse aggregate shall have a maximum tonnage of 5,000 tons (4,500 metric tons). The Contractor shall obtain a representative sample witnessed by the Engineer. The sample shall be a minimum of 50 lb (25 kg). The sample shall be extracted according to Illinois Modified AASHTO T 164 by a consultant prequalified by the Department for the specified testing. The consultant shall submit the test results along with the recovered aggregate to the District Office. The cost for this testing shall be paid by the Contractor. The District will forward the sample to the BMPR Aggregate Lab for MicroDeval Testing, according to Illinois Modified AASHTO T 327. A maximum loss of 15.0 percent will be applied for all HMA applications.

**1031.06 Use of RAP/FRAP and/or RAS in HMA.** The use of RAP/FRAP and/or RAS shall be a Contractor's option when constructing HMA in all contracts.

(a) RAP/FRAP. The use of RAP/FRAP in HMA shall be as follows.

- (1) Coarse Aggregate Size. The coarse aggregate in all RAP shall be equal to or less than the nominal maximum size requirement for the HMA mixture to be produced.
- (2) Steel Slag Stockpiles. Homogeneous RAP stockpiles containing steel slag will be approved for use in all HMA (High ESAL and Low ESAL) Surface and Binder Mixture applications.
- (3) Use in HMA Surface Mixtures (High and Low ESAL). RAP/FRAP stockpiles for use in HMA surface mixtures (High and Low ESAL) shall be FRAP or homogeneous in which the coarse aggregate is Class B quality or better. RAP/FRAP from Conglomerate stockpiles shall be considered equivalent to limestone for frictional considerations. Known frictional contributions from plus #4 (4.75 mm) homogeneous RAP and FRAP stockpiles will be accounted for in meeting frictional requirements in the specified mixture.
- (4) Use in HMA Binder Mixtures (High and Low ESAL), HMA Base Course, and HMA Base Course Widening. RAP/FRAP stockpiles for use in HMA binder mixtures (High and Low ESAL), HMA base course, and HMA base course widening shall be FRAP, homogeneous, or conglomerate, in which the coarse aggregate is Class C quality or better.
- (5) Use in Shoulders and Subbase. RAP/FRAP stockpiles for use in HMA shoulders and stabilized subbase (HMA) shall be FRAP, homogeneous, conglomerate, or conglomerate DQ.
- (6) When the Contractor chooses the RAP option, the percentage of RAP shall not exceed the amounts indicated in Article 1031.06(c)(1) below for a given N Design.

- (b) RAS. RAS meeting Type 1 or Type 2 requirements will be permitted in all HMA applications as specified herein.
- (c) RAP/FRAP and/or RAS Usage Limits. Type 1 or Type 2 RAS may be used alone or in conjunction with RAP or FRAP in HMA mixtures up to a maximum of 5.0% by weight of the total mix.
- (1) RAP/RAS. When RAP is used alone or RAP is used in conjunction with RAS, the percentage of virgin asphalt binder replacement shall not exceed the amounts listed in the Max RAP/RAS ABR table listed below for the given Ndesign.

**RAP/RAS Maximum Asphalt Binder Replacement (ABR) Percentage**

| HMA Mixtures <sup>1/, 2/</sup> | RAP/RAS Maximum ABR %  |         |                  |
|--------------------------------|------------------------|---------|------------------|
| Ndesign                        | Binder/Leveling Binder | Surface | Polymer Modified |
| 30                             | 30                     | 30      | 10               |
| 50                             | 25                     | 15      | 10               |
| 70                             | 15                     | 10      | 10               |
| 90                             | 10                     | 10      | 10               |
| 105                            | 10                     | 10      | 10               |

1/ For HMA "All Other" (shoulder and stabilized subbase) N-30, the RAP/RAS ABR shall not exceed 50 percent of the mixture.

2/ When RAP/RAS ABR exceeds 20 percent, the high and low virgin asphalt binder grades shall each be reduced by one grade (i.e. 25 percent ABR would require a virgin asphalt binder grade of PG64-22 to be reduced to a PG58-28). If warm mix asphalt (WMA) technology is utilized, and production temperatures do not exceed 275 °F (135 °C) the high and low virgin asphalt binder grades shall each be reduced by one grade when RAP/RAS ABR exceeds 25 percent (i.e. 26 percent RAP/RAS ABR would require a virgin asphalt binder grade of PG64-22 to be reduced to a PG58-28).

- (2) FRAP/RAS. When FRAP is used alone or FRAP is used in conjunction with RAS, the percentage of virgin asphalt binder replacement shall not exceed the amounts listed in the FRAP/RAS table listed below for the given N design.

**FRAP/RAS Maximum Asphalt Binder Replacement (ABR) Percentage**

| HMA Mixtures <sup>1/, 2/</sup> | FRAP/RAS Maximum ABR % |         |                                    |
|--------------------------------|------------------------|---------|------------------------------------|
| Ndesign                        | Binder/Leveling Binder | Surface | Polymer Modified <sup>3/, 4/</sup> |
| 30                             | 50                     | 40      | 10                                 |

|     |    |    |    |
|-----|----|----|----|
| 50  | 40 | 35 | 10 |
| 70  | 40 | 30 | 10 |
| 90  | 40 | 30 | 10 |
| 105 | 40 | 30 | 10 |

- 1/ For HMA "All Other" (shoulder and stabilized subbase) N30, the FRAP/RAS ABR shall not exceed 50 percent of the mixture.
- 2/ When FRAP/RAS ABR exceeds 20 percent for all mixes the high and low virgin asphalt binder grades shall each be reduced by one grade (i.e. 25 percent ABR would require a virgin asphalt binder grade of PG64-22 to be reduced to a PG58-28). If warm mix asphalt (WMA) technology is utilized, and production temperatures do not exceed 275 °F (135 °C) the high and low virgin asphalt binder grades shall each be reduced by one grade when FRAP/RAS ABR exceeds 25 percent (i.e. 26 percent ABR would require a virgin asphalt binder grade of PG64-22 to be reduced to a PG58-28).
- 3/ For SMA the FRAP/RAS ABR shall not exceed 20 percent.
- 4/ For IL-4.75 mix the FRAP/RAS ABR shall not exceed 30 percent.

**1031.07 HMA Mix Designs.** At the Contractor's option, HMA mixtures may be constructed utilizing RAP/FRAP and/or RAS material meeting the detailed requirements specified herein.

- (a) RAP/FRAP and/or RAS. RAP/FRAP and/or RAS mix designs shall be submitted for verification. If additional RAP/FRAP stockpiles are tested and found that no more than 20 percent of the results, as defined under "Testing" herein, are outside of the control tolerances set for the original RAP/FRAP stockpile and HMA mix design, and meets all of the requirements herein, the additional RAP/FRAP stockpiles may be used in the original mix design at the percent previously verified.
- (b) RAS. Type 1 and Type 2 RAS are not interchangeable in a mix design. A RAS stone bulk specific gravity (Gsb) of 2.500 shall be used for mix design purposes.

**1031.08 HMA Production.** HMA production utilizing RAP/FRAP and/or RAS shall be as follows.

- (a) RAP/FRAP. The coarse aggregate in all RAP/FRAP used shall be equal to or less than the nominal maximum size requirement for the HMA mixture being produced.

To remove or reduce agglomerated material, a scalping screen, gator, crushing unit, or comparable sizing device approved by the Engineer shall be used in the RAP feed system to remove or reduce oversized material. If material passing the sizing device adversely affects the mix production or quality of the mix, the sizing device shall be set at a size specified by the Engineer.

If the RAP/FRAP control tolerances or QC/QA test results require corrective action, the Contractor shall cease production of the mixture containing RAP/FRAP and either switch to the virgin aggregate design or submit a new RAP/FRAP design.

- (b) RAS. RAS shall be incorporated into the HMA mixture either by a separate weight depletion system or by using the RAP weigh belt. Either feed system shall be interlocked with the aggregate feed or weigh system to maintain correct proportions for all rates of production and batch sizes. The portion of RAS shall be controlled accurately to within  $\pm 0.5$  percent of the amount of RAS utilized. When using the weight depletion system, flow indicators or sensing devices shall be provided and interlocked with the plant controls such that the mixture production is halted when RAS flow is interrupted.
- (c) RAP/FRAP and/or RAS. HMA plants utilizing RAP/FRAP and/or RAS shall be capable of automatically recording and printing the following information.

(1) Dryer Drum Plants.

- a. Date, month, year, and time to the nearest minute for each print.
- b. HMA mix number assigned by the Department.
- c. Accumulated weight of dry aggregate (combined or individual) in tons (metric tons) to the nearest 0.1 ton (0.1 metric ton).
- d. Accumulated dry weight of RAP/FRAP/RAS in tons (metric tons) to the nearest 0.1 ton (0.1 metric ton).
- e. Accumulated mineral filler in revolutions, tons (metric tons), etc. to the nearest 0.1 unit.
- f. Accumulated asphalt binder in gallons (liters), tons (metric tons), etc. to the nearest 0.1 unit.
- g. Residual asphalt binder in the RAP/FRAP material as a percent of the total mix to the nearest 0.1 percent.
- h. Aggregate and RAP/FRAP moisture compensators in percent as set on the control panel. (Required when accumulated or individual aggregate and RAP/FRAP are printed in wet condition.)

(2) Batch Plants.

- a. Date, month, year, and time to the nearest minute for each print.
- b. HMA mix number assigned by the Department.

- c. Individual virgin aggregate hot bin batch weights to the nearest pound (kilogram).
- d. Mineral filler weight to the nearest pound (kilogram).
- e. RAP/FRAP/RAS weight to the nearest pound (kilogram).
- f. Virgin asphalt binder weight to the nearest pound (kilogram).
- g. Residual asphalt binder in the RAP/FRAP/RAS material as a percent of the total mix to the nearest 0.1 percent.

The printouts shall be maintained in a file at the plant for a minimum of one year or as directed by the Engineer and shall be made available upon request. The printing system will be inspected by the Engineer prior to production and verified at the beginning of each construction season thereafter.

**1031.09 RAP in Aggregate Surface Course and Aggregate Shoulders.** The use of RAP in aggregate surface course (temporary access entrances only) and aggregate wedge shoulders Type B shall be as follows.

- (a) Stockpiles and Testing. RAP stockpiles may be any of those listed in Article 1031.02, except "Non-Quality" and "FRAP". The testing requirements of Article 1031.03 shall not apply. RAP used to construct aggregate surface course and aggregate shoulders shall be according to the current Bureau of Materials and Physical Research's Policy Memorandum, "Reclaimed Asphalt Pavement (RAP) for Aggregate Applications".
- (b) Gradation. One hundred percent of the RAP material shall pass the 1 1/2 in. (37.5 mm) sieve. The RAP material shall be reasonably well graded from coarse to fine. RAP material that is gap-graded or single sized will not be accepted."

80306



## REMOVAL AND DISPOSAL OF REGULATED SUBSTANCES (BDE)

Effective: January 1, 2012  
Revised: November 2, 2012

Revise Article 669.01 of the Standard Specifications to read:

**“669.01 Description.** This work shall consist of the transportation and proper disposal of contaminated soil and water. This work shall also consist of the removal, transportation, and proper disposal of underground storage tanks (UST), their content and associated underground piping to the point where the piping is above the ground, including determining the content types and estimated quantities.”

Revise Article 669.08 of the Standard Specifications to read:

**“669.08 Contaminated Soil and/or Groundwater Monitoring.** The Contractor shall hire a qualified environmental firm to monitor the area containing the regulated substances. The affected area shall be monitored with a photoionization detector (PID) utilizing a lamp of 10.6eV or greater or a flame ionization detector (FID). Any field screen reading on the PID or FID in excess of background levels indicates the potential presence of contaminated material requiring handling as a non-special waste, special waste, or hazardous waste. No excavated soils can be taken to a clean construction and demolition debris (CCDD) facility or an uncontaminated soil fill operation with detectable PID or FID meter readings that are above background. The PID or FID meter shall be calibrated on-site and background level readings taken and recorded daily. All testing shall be done by a qualified engineer/technician. Such testing and monitoring shall be included in the work. The Contractor shall identify the exact limits of removal of non-special waste, special waste, or hazardous waste. All limits shall be approved by the Engineer prior to excavation. The Contractor shall take all necessary precautions.

Based upon the land use history of the subject property and/or PID or FID readings indicating contamination, a soil or groundwater sample shall be taken from the same location and submitted to an approved laboratory. Soil or groundwater samples shall be analyzed for the contaminants of concern, including pH, based on the property's land use history or the parameters listed in the maximum allowable concentration (MAC) for chemical constituents in uncontaminated soil established pursuant to Subpart F of 35 Illinois Administrative Code 1100.605. The analytical results shall serve to document the level of soil contamination. Soil and groundwater samples may be required at the discretion of the Engineer to verify the level of soil and groundwater contamination.

Samples shall be grab samples (not combined with other locations). The samples shall be taken with decontaminated or disposable instruments. The samples shall be placed in sealed containers and transported in an insulated container to the laboratory. The container shall maintain a temperature of 39 °F (4 °C). All samples shall be clearly labeled. The labels shall indicate the sample number, date sampled, location and elevation, and any other observations.

The laboratory shall use analytical methods which are able to meet the lowest appropriate practical quantitation limits (PQL) or estimated quantitation limit (EQL) specified in "Test Methods for Evaluating Solid Wastes, Physical/Chemical Methods", EPA Publication No. SW-846 and "Methods for the Determination of Organic Compounds in Drinking Water", EPA, EMSL, EPA-600/4-88/039. For parameters where the specified cleanup objective is below the acceptable detection limit (ADL), the ADL shall serve as the cleanup objective. For other parameters the ADL shall be equal to or below the specified cleanup objective."

Replace the first two paragraphs of Article 669.09 of the Standard Specifications with the following:

**"669.09 Contaminated Soil and/or Groundwater Management and Disposal.** The management and disposal of contaminated soil and/or groundwater shall be according to the following:

- (a) Soil Analytical Results Exceed Most Stringent MAC. When the soil analytical results indicate that detected levels exceed the most stringent maximum allowable concentration (MAC) for chemical constituents in uncontaminated soil established pursuant to Subpart F of 35 Illinois Administrative Code 1100.605, the soil shall be managed as follows:
  - (1) When analytical results indicate inorganic chemical constituents exceed the most stringent MAC but they are still considered within area background levels by the Engineer, the excavated soil can be utilized within the construction limits as fill, when suitable. Such soil excavated for storm sewers can be placed back into the excavated trench as backfill, when suitable, unless trench backfill is specified. If the soils cannot be utilized within the construction limits, they shall be managed and disposed of off-site as a non-special waste, special waste, or hazardous waste as applicable.
  - (2) When analytical results indicate chemical constituents exceed the most stringent MAC but do not exceed the MAC for a Metropolitan Statistical Area (MSA) County, the excavated soil can be utilized within the construction limits as fill, when suitable, or managed and disposed of off-site as "uncontaminated soil" at a CCDD facility or an uncontaminated soil fill operation within an MSA County provided the pH of the soil is within the range of 6.25 - 9.0, inclusive.
  - (3) When analytical results indicate chemical constituents exceed the most stringent MAC but do not exceed the MAC for an MSA County excluding Chicago, or the MAC within the Chicago corporate limits, the excavated soil can be utilized within the construction limits as fill, when suitable, or managed and disposed of off-site as "uncontaminated soil" at a CCDD facility or an uncontaminated soil fill operation within an MSA County excluding Chicago or within the Chicago corporate limits provided the pH of the soil is within the range of 6.25 - 9.0, inclusive.

- (4) When analytical results indicate chemical constituents exceed the most stringent MAC but do not exceed the MAC for an MSA County excluding Chicago, the excavated soil can be utilized within the construction limits as fill, when suitable, or managed and disposed of off-site as "uncontaminated soil" at a CCDD facility or an uncontaminated soil fill operation within an MSA County excluding Chicago provided the pH of the soil is within the range of 6.25 - 9.0, inclusive.
- (5) When the Engineer determines soil cannot be managed according to Articles 669.09(a)(1) through (a)(4) above, the soil shall be managed and disposed of off-site as a non-special waste, special waste, or hazardous waste as applicable.
- (b) Soil Analytical Results Do Not Exceed Most Stringent MAC. When the soil analytical results indicate that detected levels do not exceed the most stringent MAC but the pH of the soil is less than 6.25 or greater than 9.0, the excavated soil can be utilized within the construction limits or managed and disposed of off-site as "uncontaminated soil" according to Article 202.03. However the excavated soil cannot be taken to a CCDD facility or an uncontaminated soil fill operation.
- (c) Groundwater. When groundwater analytical results indicate the detected levels are above Appendix B, Table E of 35 Illinois Administrative Code 742, the most stringent Tier 1 Groundwater Remediation Objectives for Groundwater Component of the Groundwater Ingestion Route for Class 1 groundwater, the groundwater shall be managed off-site as a special waste.

All groundwater encountered within lateral trenches may be managed within the trench and allowed to infiltrate back into the ground. If the groundwater cannot be managed within the trench it must be removed as a special or hazardous waste. The Contractor is prohibited from managing groundwater within the trench by discharging it through any existing or new storm sewer. The Contractor shall install backfill plugs within the area of groundwater contamination.

One backfill plug shall be placed down gradient to the area of groundwater contamination. Backfill plugs shall be installed at intervals not to exceed 50 ft (15 m). Backfill plugs are to be 4 ft (1.2 m) long, measured parallel to the trench, full trench width and depth. Backfill plugs shall not have any fine aggregate bedding or backfill, but shall be entirely cohesive soil or any class of concrete. The Contractor shall provide test data that the material has a permeability of less than  $10^{-7}$  cm/sec according to ASTM D 5084, Method A or per another test method approved by the Engineer."

Revise Article 669.14 of the Standard Specifications to read:

**"669.14 Final Environmental Construction Report.** At the end of the project, the Contractor will prepare and submit three copies of the Environmental Construction Report on the activities conducted during the life of the project, one copy shall be submitted to the Resident Engineer, one copy shall be submitted to the District's Environmental Studies Unit, and one copy shall be submitted with an electronic copy in Adode.pdf format to the Geologic

and Waste Assessment Unit, Bureau of Design and Environment, IDOT, 2300 South Dirksen Parkway, Springfield, Illinois 62764. The technical report shall include all pertinent information regarding the project including, but not limited to:

- (a) Measures taken to identify, monitor, handle, and dispose of soil or groundwater containing regulated substances, to prevent further migration of regulated substances, and to protect workers,
- (b) Cost of identifying, monitoring, handling, and disposing of soil or groundwater containing regulated substances, the cost of preventing further migration of regulated substances, and the cost for worker protection from the regulated substances. All cost should be in the format of the contract pay items listed in the contract plans (identified by the preliminary environmental site investigation (PESA) site number),
- (c) Plan sheets showing the areas containing the regulated substances,
- (d) Field sampling and testing results used to identify the nature and extent of the regulated substances,
- (e) Waste manifests (identified by the preliminary environmental site investigation (PESA) site number) for special or hazardous waste disposal, and
- (f) Landfill tickets (identified by the preliminary environmental site investigation (PESA) site number) for non-special waste disposal."

Revise the second paragraph of Article 669.16 of the Standard Specifications to read:

"The transportation and disposal of soil and other materials from an excavation determined to be contaminated will be paid for at the contract unit price per cubic yard (cubic meter) for NON-SPECIAL WASTE DISPOSAL, SPECIAL WASTE DISPOSAL, or HAZARDOUS WASTE DISPOSAL."

80283

## REMOVAL AND DISPOSAL OF SURPLUS MATERIALS (BDE)

Effective: November 2, 2012

Revise the first four paragraphs of Article 202.03 of the Standard Specifications to read:

**“202.03 Removal and Disposal of Surplus, Unstable, Unsuitable, and Organic Materials.** Suitable excavated materials shall not be wasted without permission of the Engineer. The Contractor shall dispose of all surplus, unstable, unsuitable, and organic materials, in such a manner that public or private property will not be damaged or endangered.

Suitable earth, stones and boulders naturally occurring within the right-of-way may be placed in fills or embankments in lifts and compacted according to Section 205. Broken concrete without protruding metal bars, bricks, rock, stone, reclaimed asphalt pavement with no expansive aggregate, or uncontaminated dirt and sand generated from construction or demolition activities may be used in embankment or in fill. If used in fills or embankments, these materials shall be placed and compacted to the satisfaction of the Engineer; shall be buried under a minimum of 2 ft (600 mm) of earth cover (except when the materials include only uncontaminated dirt); and shall not create an unsightly appearance or detract from the natural topographic features of an area. Broken concrete without protruding metal bars, bricks, rock, or stone may be used as riprap as approved by the Engineer. If the materials are used for fill in locations within the right-of-way but outside project construction limits, the Contractor must specify to the Engineer, in writing, how the landscape restoration of the fill areas will be accomplished. Placement of fill in such areas shall not commence until the Contractor's landscape restoration plan is approved by the Engineer.

Aside from the materials listed above, all other construction and demolition debris or waste shall be disposed of in a licensed landfill, recycled, reused, or otherwise disposed of as allowed by State or Federal laws and regulations. When the Contractor chooses to dispose of uncontaminated soil at a clean construction and demolition debris (CCDD) facility or at an uncontaminated soil fill operation, it shall be the Contractor's responsibility to have the pH of the material tested to ensure the value is between 6.25 and 9.0, inclusive. A copy of the pH test results shall be provided to the Engineer.

A permit shall be obtained from IEPA and made available to the Engineer prior to open burning of organic materials (i.e., plant refuse resulting from pruning or removal of trees or shrubs) or other construction or demolition debris. Organic materials originating within the right-of-way limits may be chipped or shredded and placed as mulch around landscape plantings within the right-of-way when approved by the Engineer. Chipped or shredded material to be placed as mulch shall not exceed a depth of 6 in. (150 mm).”

80319

## **WEEKLY DBE TRUCKING REPORTS (BDE)**

Effective: June 2, 2012

The Contractor shall provide a weekly report of Disadvantaged Business Enterprise (DBE) trucks hired by the Contractor or subcontractors (i.e. not owned by the Contractor or subcontractors) that are used on the jobsite; or used for the delivery and/or removal of equipment/material to and from the jobsite. The jobsite shall also include offsite locations, such as plant sites or storage sites, when those locations are used solely for this contract.

The report shall be submitted on the form provided by the Department within ten business days following the reporting period. The reporting period shall be Monday through Sunday for each week reportable trucking activities occur. The report shall be submitted to the Engineer and a copy shall be provided to the district EEO Officer.

Any costs associated with providing weekly DBE trucking reports shall be considered as included in the contract unit prices bid for the various items of work involved and no additional compensation will be allowed.

80302

**WORKING DAYS (BDE)**

Effective: January 1, 2002

The Contractor shall complete the work within 25 working days.

80071

|                 |                |        |              |           |
|-----------------|----------------|--------|--------------|-----------|
| ROUTE           | SECTION        | COUNTY | TOTAL SHEETS | SHEET NO. |
| FAS 679<br>CH 8 | 10-00105-02-RS | EDGAR  | 21           | 1         |

CONTRACT NO. 91491

**STATE OF ILLINOIS**  
**DEPARTMENT OF TRANSPORTATION**  
**DIVISION OF HIGHWAYS**  
**FAS ROUTE 679 (CH 8)**  
**SECTION 10-00105-02-RS**  
**PROJECT RS-0679 (111)**  
**HMA RESURFACING (POLICY OVERLAY)**  
**EDGAR COUNTY**  
**STR, STATE MATCH & LOCAL FUNDS**  
**JOB NO. C-95-326-13**

**INDEX OF SHEETS**

| <u>SHEET NO.</u> | <u>DESCRIPTION</u>                                      |
|------------------|---|
| 1                | COVER SHEET   |
| 2                | LOCATION MAP  |
| 3                | LAYOUT SHEET  |
| 4                | GENERAL NOTES   |
| 5                | SUMMARY OF QUANTITIES                                   |
| 6-8              | SCHEDULES OF QUANTITIES                                 |
| 9-13 (INCL)      | EXISTING TYPICAL CROSS SECTIONS                         |
| 14-18 (INCL)     | PROPOSED TYPICAL CROSS SECTIONS                         |
| 19               | BUTT JOINT DETAILS                                      |
| 20               | SIDEROAD, ENTRANCE & MAILBOX RETURN RESURFACING DETAILS |
| 21               | STRIPING DETAILS  |



**ILLINOIS HIGHWAY STANDARD DRAWINGS**

|           |  |
|-----------|--|
| 001006    | DECIMAL OF AN INCH AND OF A FOOT   |
| 701006-05 | OFF-ROAD MOVING OPERATIONS, 2-LANE, 2-WAY, GREATER THAN 24" FROM E.P.  |
| 701011-04 | OFF-ROAD MOVING OPERATIONS, 2-LANE, 2-WAY, DAYTIME ONLY  |
| 701301-04 | LANE CLOSURE, 2-LANE, 2-WAY, SHORT TIME OPERATION  |
| 701306-03 | LANE CLOSURE, 2-LANE, 2-WAY, SLOW MOVING OPERATIONS, DAYTIME ONLY FOR SPEEDS EQUAL TO OR GREATER THAN 45 MPH |
| 701311-03 | LANE CLOSURE, 2-LANE, 2-WAY, MOVING OPERATIONS, DAYTIME ONLY   |
| 701901-03 | TRAFFIC CONTROL DEVICES  |
| 780001-04 | TYPICAL PAVEMENT MARKINGS  |
| 781001-03 | TYPICAL APPLICATIONS RAISED REFLECTIVE PAVEMENT MARKERS  |

AARON M. LAWSON  
PROFESSIONAL ENGINEER  
NO. 062-051230  
EXPIRES 11-30-2015

|                           |                 |
|---------------------------|-----------------|
| ADT = 600                 | YEAR 2014       |
| FUNCTIONAL CLASSIFICATION | MAJOR COLLECTOR |

**J.U.L.I.E.**  
**JOINT UTILITY LOCATION INFORMATION FOR EXCAVATION**  
1-800-892-0123  
OR 811

| AGENCY RESPONSIBLE FOR LETTING                  |  |
|---|--|
| APPROVED  | <i>[Signature]</i> 11/27/2014<br>EDGAR COUNTY ENGINEER   |
| PASSED  | <i>[Signature]</i> 02/10/2014<br>DISTRICT FIVE ENGINEER OF LOCAL ROADS AND STREETS   |
| RELEASING FOR BID<br>BASED ON LIMITED<br>REVIEW | <i>[Signature]</i> 02/10/2014<br>DEPUTY DIRECTOR OF HIGHWAYS, REGION THREE ENGINEER<br>STATE OF ILLINOIS<br>DEPARTMENT OF TRANSPORTATION |



# LOCATION MAP

| ROUTE             | SECTION        | COUNTY | TOTAL SHEETS | SHEET NO. |
|-------------------|----------------|--------|--------------|-----------|
| FAS 679<br>(CH 8) | 10-00105-02-RS | EDGAR  | 21           | 2         |

CONTRACT NO. 91491

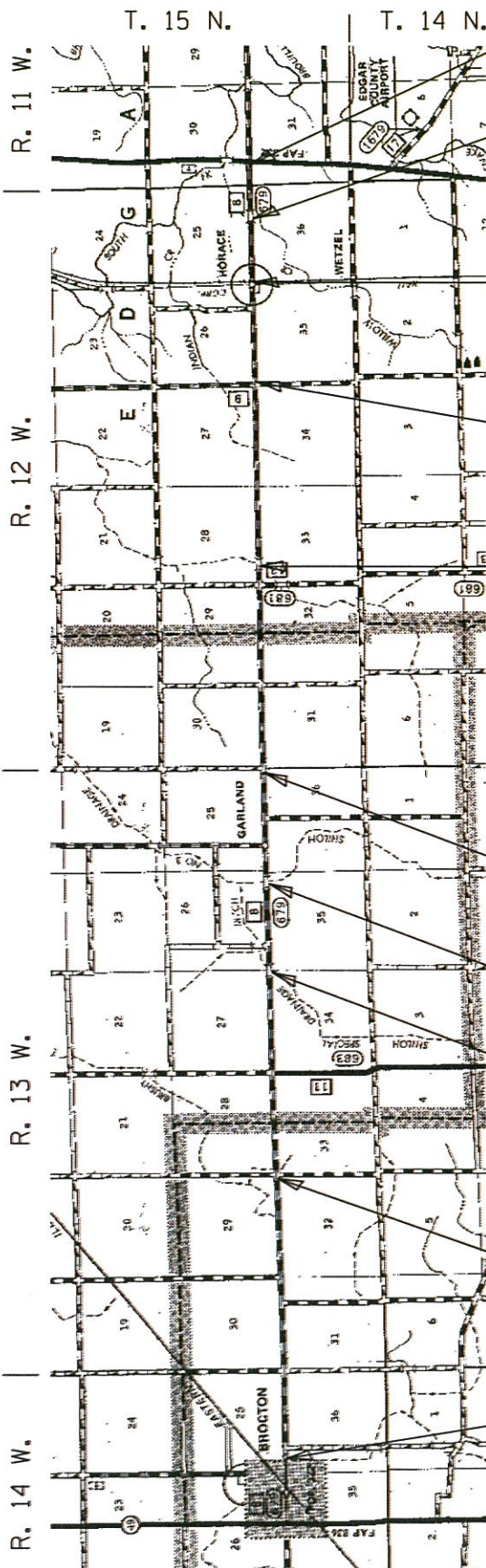

SECTION 10-00105-02-RS  
ENDS STA. 684+70.46 (13-2-G)

STRUCTURE NO. 3259 DOUBLE  
9' x 9' CONC BOX CULVERT



OMMISSION FROM RESURFACING  
STATION 620+08.70 TO  
STATION 620+17.40

STATION EQUATION  
STATION 158+59.20 (13-4-Q) (BACK)=  
STATION 566+44.60 (13-2-6) (AHEAD)

STRUCTURE NO. 3226 DOUBLE  
12' x 13' CONC BOX CULVERT

**NOTE:**  
SECTION NUMBERS DENOTED  
REFER TO ORIGINAL CONSTRUCTION  
SECTIONS.

STATION EQUATION  
STATION 203+56.60 (13-3-Q) (BACK)=  
STATION 0+00 (13-4-Q) (AHEAD)

STRUCTURE NO. 3225 TRIPLE  
9'-3''' x 13'-1'' CONC BOX CULVERT

STRUCTURE NO. 3224 DOUBLE  
12' x 10'-6'' CONC BOX CULVERT

STATION EQUATION  
STATION 205+00 (13-1-Q) (BACK)=  
STATION 0+00 (13-3-Q) (AHEAD)

SECTION 10-00105-02-RS  
BEGINS STA. 2+74.50 (13-1-Q)

GROSS LENGTH OF SECTION = 68,267.16' (12.929 MILES)  
NET LENGTH OF SECTION = 68,258.46' (12.928 MILES)

# LAYOUT SHEET

| ROUTE             | SECTION        | COUNTY | TOTAL SHEETS | SHEET NO. |
|-------------------|----------------|--------|--------------|-----------|
| FAS 679<br>(CH B) | 10-00105-02-RS | EDGAR  | 21           | 3         |

CONTRACT NO. 91491

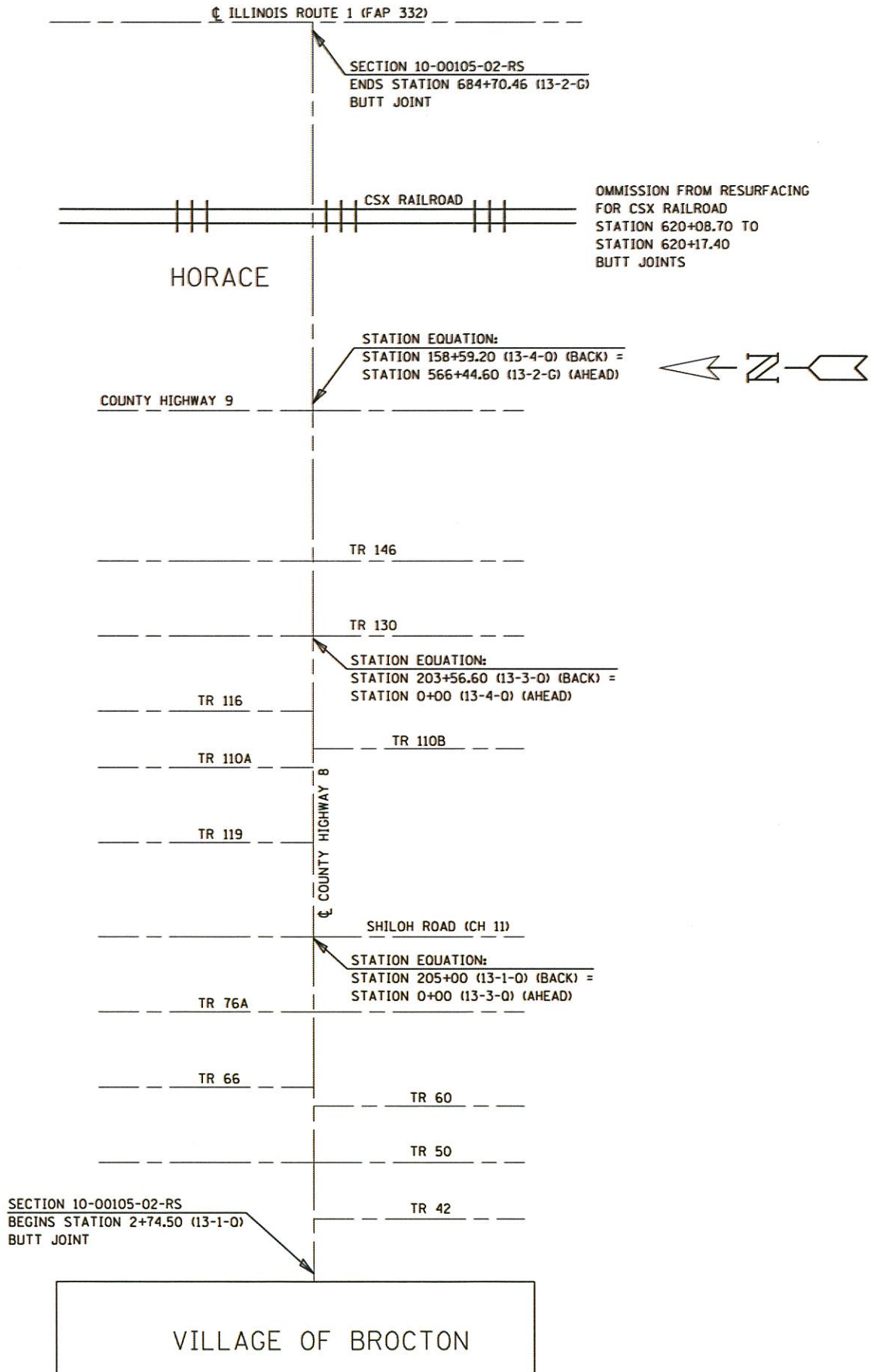

# GENERAL NOTES

| ROUTE             | SECTION        | COUNTY | TOTAL SHEETS | SHEET NO. |
|-------------------|----------------|--------|--------------|-----------|
| FAS 679<br>(CH B) | 10-00105-02-RS | EDGAR  | 21           | 4         |

CONTRACT NO. 91491

**G.N.-100**

ENGLISH UNITS OF MEASUREMENT SHALL GOVERN OVER AND SUPERSEDE ANY METRIC UNITS SHOWN IN THIS CONTRACT. WHERE INCLUDED, METRIC UNITS ARE FOR INFORMATION ONLY.

**G.N.-406**

THE QUANTITIES INCLUDED IN THE PLANS FOR HOT-MIX ASPHALT RESURFACING ARE INTENDED TO GIVE THE COVERAGE SHOWN ON THE TYPICAL CROSS SECTIONS. IT IS NOT INTENDED TO INCREASE THE THICKNESS OF THE HOT-MIX ASPHALT MIXTURE IN ORDER TO USE ALL OF THE QUANTITIES INCLUDED IN THE CONTRACT.

**G.N. -406H**

**MIXTURE REQUIREMENTS**

The following mixture requirements are applicable for this project:

|   |  |
|---|--|
| Location(s):                                | Station 2+74.50 (13-1-Q)<br>to Station<br>684+70.46 (13-2-G) |
| Mixture Use(s):                             | Surface Course   |
| AC/PG:                                      | PG 64-22   |
| RAP %: (Max)                                | *  |
| Design Air Voids:                           | 4.0% @Ndes=50  |
| Mixture Composition:<br>(Gradation Mixture) | IL 9.5   |
| Friction Aggregate:                         | Mix C  |

- See RAP/RAS Special Provision

**G.N.-703A (REV)**

SHORT TERM PAVEMENT MARKING SHALL BE APPLIED TO THE PAVEMENT AFTER PLACING THE HMA SURFACE COURSE. SHORT TERM PAVEMENT MARKING PLACED ON THE SURFACE, SHALL COINCIDE WITH THE FINAL PAVEMENT STRIPING. USE 4 FEET PER 40 FEET (OR 10% PER STATION).

**G.N.-781**

RAISED REFLECTIVE PAVEMENT MARKERS SHALL BE PLACED IN ACCORDANCE WITH STANDARD 781001. THE FINAL PAVEMENT MARKINGS SHALL BE IN PLACE PRIOR TO PLACING THE RAISED REFLECTIVE PAVEMENT MARKERS AND THE RAISED REFLECTIVE PAVEMENT MARKERS SHALL BE PLACED MIDWAY IN THE 30 FOOT SPACE BETWEEN THE DASHED CENTERLINE STRIPES.

**G.N.-1004.01**

COARSE AGGREGATE GRADATION CA-10 MAY BE USED WHENEVER COARSE AGGREGATE CA-6 IS SPECIFIED IN THE STANDARD SPECIFICATIONS.

**UTILITIES LOCATED WITHIN SECTION**

| UTILITY                 | TYPE        | LOCATION           | RELOC |
|-------------------------|-------------|--------------------|-------|
| Enerstar Power Corp.    | Aerial Line | Throughout Project | None  |
| Frontier Communications | Buried Line | Throughout Project | None  |

## SUMMARY OF QUANTITIES

| <u>ITEM NO.</u> | <u>DESCRIPTION</u>                              | <u>UNIT</u> | <u>QUANTITY</u> |
|-----------------|---|-------------|-----------------|
| 40600100        | BITUMINOUS MATERIALS (PRIME COAT)               | GALLON      | 17,815          |
| 40600300        | AGGREGATE (PRIME COAT)                          | TON         | 270             |
| 40600895        | CONSTRUCTING TEST STRIP                         | EACH        | 1               |
| 40600982        | HOT-MIX ASPHALT SURFACE REMOVAL - BUTT JOINT    | SQ YD       | 537             |
| 40600990        | TEMPORARY RAMP                                  | SQ YD       | 120             |
| 40603310        | HOT-MIX ASPHALT SURFACE COURSE, MIX "C", N50    | TON         | 12,450          |
| 48102100        | AGGREGATE WEDGE SHOULDER, TYPE B                | TON         | 1,410           |
| 67100100        | MOBILIZATION                                    | L SUM       | 1               |
| 70100460        | TRAFFIC CONTROL AND PROTECTION, STANDARD 701306 | L SUM       | 1               |
| 70300100        | SHORT TERM PAVEMENT MARKING                     | FOOT        | 6,828           |
| 70301000        | WORK ZONE PAVEMENT MARKING REMOVAL              | SQ FT       | 2,276           |
| 78001100        | PAINT PAVEMENT MARKING - LETTERS AND SYMBOLS    | SQ FT       | 122.4           |
| 78001110        | PAINT PAVEMENT MARKING - LINE 4"                | FOOT        | 153,298         |
| 78001180        | PAINT PAVEMENT MARKING - LINE 24"               | FOOT        | 92              |
| 78100100        | RAISED REFLECTIVE PAVEMENT MARKER               | EACH        | 855             |
| 78300200        | RAISED REFLECTIVE PAVEMENT MARKER REMOVAL       | EACH        | 855             |
| Z0048665        | RAILROAD PROTECTIVE LIABILITY INSURANCE         | L SUM       | 1               |

\* \* \* \*

\* SPECIALTY ITEM

CONTRACT NO. 91491

|                   |                |        |              |           |
|-------------------|----------------|--------|--------------|-----------|
| ROUTE             | SECTION        | COUNTY | TOTAL SHEETS | SHEET NO. |
| FAS 679<br>(CH 8) | 10-00105-02-R5 | EDGAR  | 21           | 5         |

# SCHEDULE OF QUANTITIES

| ROUTE             | SECTION        | COUNTY | TOTAL SHEETS | SHEET NO. |
|-------------------|----------------|--------|--------------|-----------|
| FAS 679<br>(CH 8) | 10-00105-02-RS | EDGAR  | 21           | 6         |

CONTRACT NO. 91491

## HMA SURFACE COURSE

|                     |    |           |           |         | 40600100   | 40600300  | 40603310 |
|---------------------|----|-----------|-----------|---------|------------|-----------|----------|
|                     |    |           |           |         | GALLONS    | TONS      | TONS     |
| STATION             | TO | STATION   | LENGTH    | WIDTH   | PRIME COAT | AGG PRIME | SURFACE  |
| 2+74.50             |    | 98+47.00  | 9,572.50  | 24.00   | 2,680.5    | 40.6      | 1,876.2  |
| 98+47.00            |    | 103+47.00 | 500.00    | 24+21/2 | 131.3      | 2.0       | 91.9     |
| 103+47.00           |    | 192+30.02 | 8,883.02  | 21.00   | 2,176.5    | 33.0      | 1,523.4  |
| 193+30.02           |    | 205+00.00 | 1,169.98  | 28.00   | 382.2      | 5.8       | 267.5    |
| 0+00                |    | 5+75.42   | 575.42    | 28.00   | 188.0      | 2.8       | 131.6    |
| 5+75.42             |    | 203+56.60 | 19,781.18 | 22.00   | 5,077.5    | 77.0      | 3,554.0  |
| 0+00                |    | 158+59.20 | 15,859.20 | 22.00   | 4,070.8    | 61.7      | 2,849.3  |
| 566+44.60           |    | 613+00.00 | 4,655.40  | 21.00   | 1,140.7    | 17.3      | 798.4    |
| 613+00.00           |    | 620+08.70 | 708.70    | 23.50   | 194.3      | 2.9       | 136.0    |
| 620+17.40           |    | 627+00.00 | 682.60    | 23.50   | 187.2      | 2.8       | 131.0    |
| 627+00.00           |    | 683+43.96 | 5,643.96  | 21.00   | 1,382.9    | 21.0      | 967.9    |
| 683+43.96           |    | 684+70.46 | 126.50    | VAR     | 64.9       | 1.0       | 45.4     |
| 16 MAILBOX TURNOUTS |    |           | 1,152.00  | 1.50    | 20.2       | 0.3       | 11.3     |
| 141 ENTRANCES       |    |           | 5,217.00  | 1.50    | 91.3       | 1.4       | 51.1     |
| 18 SIDEROADS        |    |           | 1,530.00  | 1.50    | 26.8       | 0.4       | 15.0     |

TOTALS = 17,815 GALLONS 270 TONS 12,450 TONS

## 40600982 HMA SURFACE REMOVAL - BUTT JOINT

| STATION   | TO | STATION   | LENGTH | WIDTH  | SQ YDS |
|-----------|----|-----------|--------|--------|--------|
| 2+74.50   |    | 3+04.50   | 30.00  | 24.00' | 80.0   |
| 619+78.70 |    | 620+08.70 | 30.00  | 23.50' | 78.3   |
| 620+17.40 |    | 620+47.40 | 30.00  | 23.50' | 78.3   |
| 684+40.46 |    | 684+70.46 | 30.00  | VAR    | 300.5  |

TOTAL = 537 SQ YDS

## 40600990 TEMPORARY RAMP

| STATION   | TO | STATION   | LENGTH | WIDTH   | SQ YDS |
|-----------|----|-----------|--------|---------|--------|
| 2+74.50   |    | 2+79.50   | 5.00   | 24.00'  | 13.3   |
| 620+03.70 |    | 620+08.70 | 5.00   | 23.50'  | 13.0   |
| 620+17.40 |    | 620+22.40 | 5.00   | 23.50'  | 13.0   |
| 684+65.46 |    | 684+70.46 | 5.00   | 145.37' | 80.6   |

TOTAL = 120 SQ YDS

## 48102100 AGGREGATE WEDGE SHOULDER, TYPE B

| STATION                               | TO | STATION      | LENGTH   | WIDTH | TONS   |
|---------------------------------------|----|--------------|----------|-------|--------|
| LT 2+74.50                            |    | LT 620+08.70 | 7,154.80 | 1.50  | 676.9  |
| RT 2+74.50                            |    | RT 620+08.70 | 7,154.80 | 1.50  | 676.9  |
| LT 620+17.40                          |    | LT 684+70.46 | 1,400.00 | 1.50  | 70.7   |
| RT 620+17.40                          |    | RT 684+70.46 | 1,400.00 | 1.50  | 70.7   |
| DEDUCTION FOR 18 SIDEROADS @ 80' EACH |    |              | 1,440.00 | 1.50  | (15.8) |
| DED FOR 141 ENTRANCES @ 37' EACH AVG  |    |              | 5,217.00 | 1.50  | (57.1) |
| DEDUCTION FOR 16 MB's @ 70' EACH AVG  |    |              | 1,120.00 | 1.50  | (12.3) |

TOTAL = 1,410 TONS

# SCHEDULE OF QUANTITIES

| ROUTE             | SECTION        | COUNTY | TOTAL SHEETS | SHEET NO. |
|-------------------|----------------|--------|--------------|-----------|
| FAS 679<br>(CH 8) | 10-00105-02-RS | EDGAR  | 21           | 7         |

CONTRACT NO. 91491

## 70300100 SHORT TERM PAVEMENT MARKING

| STATION   | TO | STATION   | LENGTH    | FOOT  |
|-----------|----|-----------|-----------|-------|
| 2+74.50   |    | 620+08.70 | 61,805.40 | 6,180 |
| 620+17.40 |    | 684+70.46 | 6,453.06  | 648   |

TOTAL = 6,828 FOOT

ASSUME: 4 FOOT IN 40 FOOT OR 10%  
ASSUME: 2 APPLICATIONS

## 70301000 WORK ZONE PAVEMENT MARKING REMOVAL

| STATION   | TO | STATION   | LENGTH   | SQ FT |
|-----------|----|-----------|----------|-------|
| 2+74.50   |    | 620+08.70 | 6,180.00 | 2,060 |
| 620+17.40 |    | 684+70.46 | 648.00   | 216   |

TOTAL = 2,276 SQ FT

## 78001100 PAINT PAVEMENT MARKING - LETTERS & SYMBOLS

| STATION      | LOCATION   | COLOR | SQ FT |
|--------------|------------|-------|-------|
| RT 617+18.70 | RAILROAD R | WHITE | 3.6   |
| RT 617+18.70 | RAILROAD R | WHITE | 3.6   |
| RT 617+18.70 | RAILROAD X | WHITE | 54.0  |
| LT 623+07.40 | RAILROAD X | WHITE | 54.0  |
| LT 623+07.40 | RAILROAD R | WHITE | 3.6   |
| LT 623+07.40 | RAILROAD R | WHITE | 3.6   |

TOTAL = 122.4 SQ FT

## 78001110 PAINT PAVEMENT MARKING - LINE 4"

| STATION                          | TO | STATION      | LOCATION   | TYPE      | WHITE   | YELLOW |
|----------------------------------|----|--------------|------------|-----------|---------|--------|
| LT 2+74.50                       |    | LT 620+08.70 | EDGE LINE  | SOLID     | 61,806  |        |
| RT 2+74.50                       |    | RT 620+08.70 | EDGE LINE  | SOLID     | 61,806  |        |
| CL 2+74.50                       |    | CL 616+83.70 | CENTERLINE | SKIP/DASH |         | 15,380 |
| LT 620+17.40                     |    | LT 684+70.46 | EDGE LINE  | SOLID     | 6,453   |        |
| RT 620+17.40                     |    | RT 684+70.46 | EDGE LINE  | SOLID     | 6,453   |        |
| CL 623+42.40                     |    | CL 684+70.46 | CENTERLINE | SKIP/DASH |         | 1,540  |
| LT 616+83.70                     |    | LT 620+08.70 | NO-PASS    | SOLID     |         | 325    |
| RT 616+83.70                     |    | RT 620+08.70 | NO-PASS    | SOLID     |         | 325    |
| LT 620+17.40                     |    | LT 623+42.40 | NO-PASS    | SOLID     |         | 325    |
| RT 620+17.40                     |    | RT 623+42.40 | NO-PASS    | SOLID     |         | 325    |
| DEDUCTION FOR 18 SIDEROADS @ 80' |    |              | EDGE LINE  | SOLID     | (1,440) |        |

INDIVIDUAL TOTALS = 135,078 FOOT      18,220 FOOT

TOTAL QUANTITY = 153,298 FOOT

## 78001180 PAINT PAVEMENT MARKING - LINE 24"

| STATION      | TO | STATION      | LOCATION  | WHITE |
|--------------|----|--------------|-----------|-------|
| RT 616+91.70 |    | RT 616+93.70 | RR SYMBOL | 11.5  |
| RT 617+41.70 |    | RT 617+43.70 | RR SYMBOL | 11.5  |
| RT 619+91.70 |    | RT 619+93.70 | STOP BAR  | 11.5  |
| RT 620+32.40 |    | RT 620+34.40 | STOP BAR  | 11.5  |
| LT 622+82.40 |    | LT 622+84.40 | RR SYMBOL | 11.5  |
| LT 623+31.40 |    | LT 623+33.40 | RR SYMBOL | 11.5  |
| RT 684+33.60 |    | RT 684+42.89 | STOP BAR  | 23    |

TOTAL = 92 FOOT

# SCHEDULE OF QUANTITIES

| ROUTE             | SECTION        | COUNTY | TOTAL SHEETS | SHEET NO. |
|-------------------|----------------|--------|--------------|-----------|
| FAS 679<br>(CH B) | 10-00105-02-RS | EDGAR  | 21           | 8         |

CONTRACT NO. 91491

## 78100100 RAISED REFLECTIVE PAVEMENT MARKERS

| STATION   | TO | STATION   | LOCATION   | TYPE            | EACH |
|-----------|----|-----------|------------|-----------------|------|
| 2+74.50   |    | 620+08.70 | CENTERLINE | BI-DIRECT AMBER | 774  |
| 620+17.40 |    | 684+70.46 | CENTERLINE | BI-DIRECT AMBER | 81   |

TOTAL = 855 EACH

## 78300200 RAISED REFLECTIVE PAVEMENT MARKER REMOVAL

| STATION   | TO | STATION   | EACH |
|-----------|----|-----------|------|
| 2+74.50   |    | 620+08.70 | 774  |
| 620+17.40 |    | 684+70.46 | 81   |

TOTAL = 855 EACH

EXISTING TYPICAL CROSS SECTION

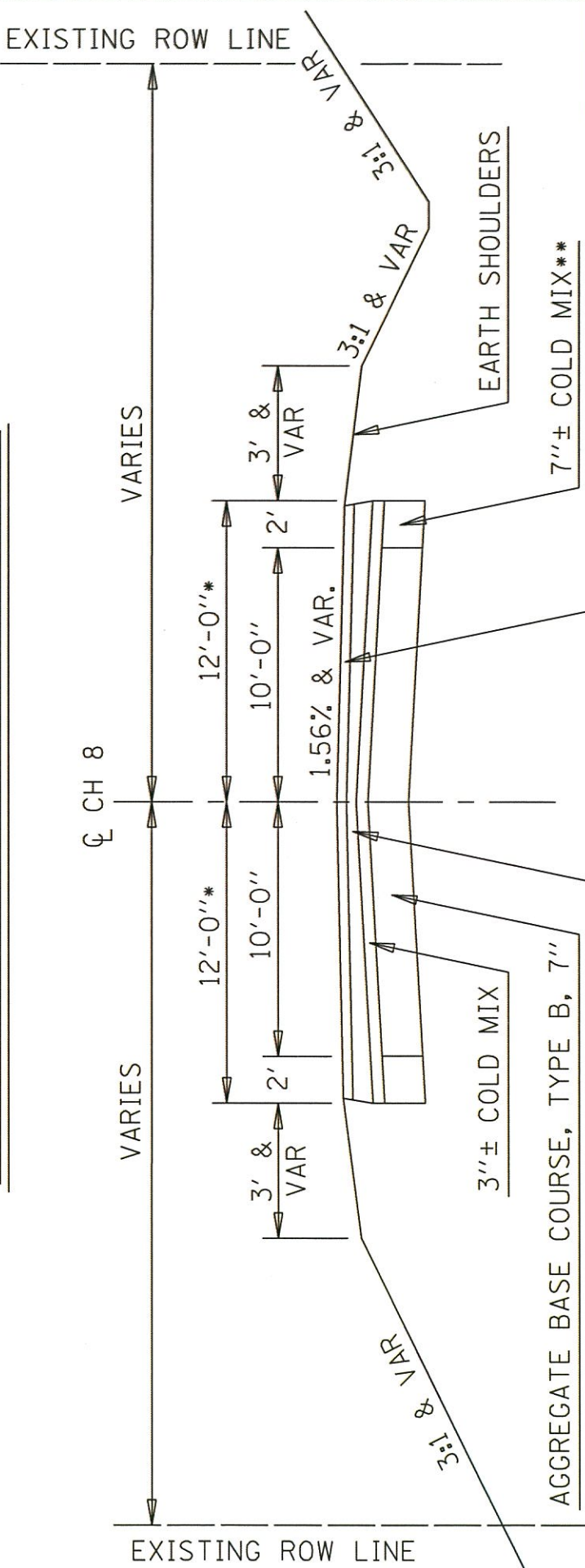

|                 |                |        |              |           |
|-----------------|----------------|--------|--------------|-----------|
| ROUTE           | SECTION        | COUNTY | TOTAL SHEETS | SHEET NO. |
| FAS 679<br>CH 8 | 10-00105-02-RS | EDGAR  | 21           | 9         |

CONTRACT NO. 91491

- \* SURFACE WIDTH TAPERS FROM 24 FEET AT STATION 98+47 TO 21 FEET AT STATION 103+47
- \*\* COLD MIX WIDENING CONSTRUCTED ONLY FROM STATION 2+74.50 TO STATION 103+47

COUNTY HIGHWAY 8  
 BEGIN SECTION STATION 2+74.50 (13-1-Q) TO STATION 103+47 (13-1-Q)



EXISTING TYPICAL CROSS SECTION

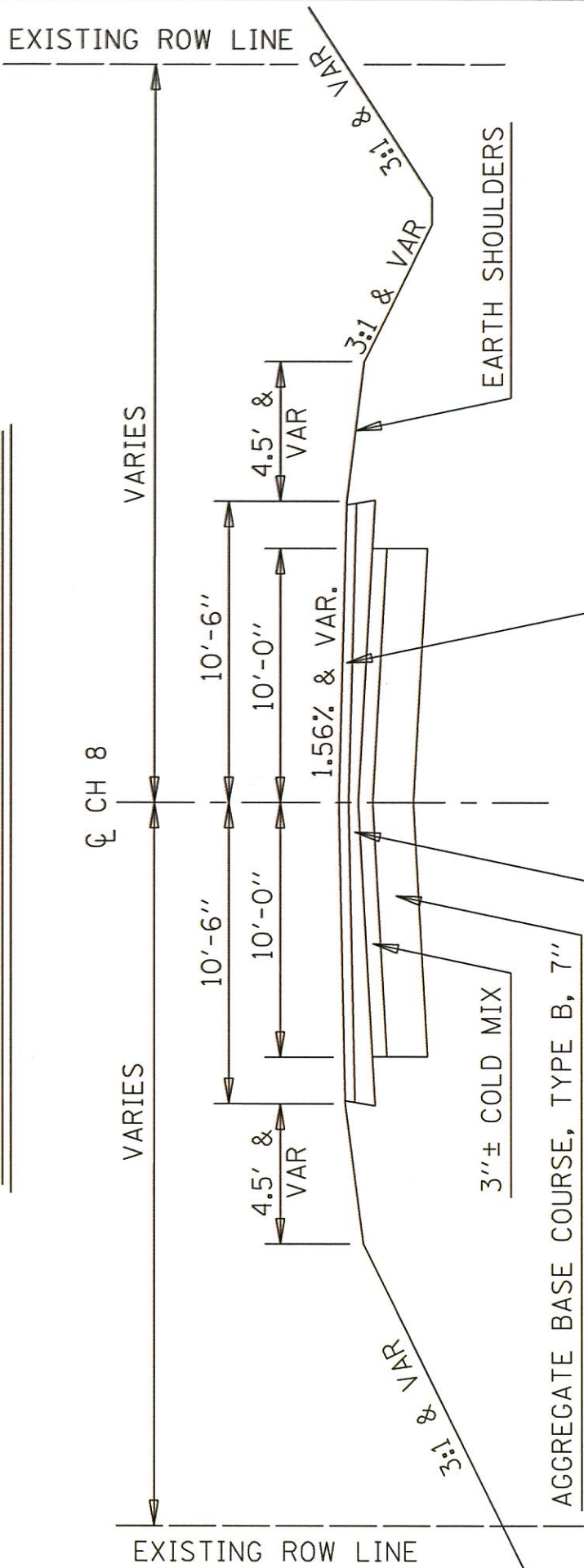

| ROUTE           | SECTION        | COUNTY | TOTAL SHEETS | SHEET NO. |
|-----------------|----------------|--------|--------------|-----------|
| FAS 679<br>CH 8 | 10-00105-02-RS | EDGAR  | 21           | 10        |

CONTRACT NO. 91491

3"± COLD MIX  
 AGGREGATE BASE COURSE, TYPE B, 7"  
 LEVELING BINDER (MACHINE METHOD)  
 VARIABLE DEPTH 1" ± AT CH 3"± AT EDGE

1 1/2" HMA SURFACE COURSE

COUNTY HIGHWAY 8  
 STATION 103+47 (13-1-Q) TO STATION 192+30.02 (13-1-Q)  
 STATION 566+44.60 (13-2-G) TO STATION 613+00 (13-2-G)  
 STATION 627+00 (13-2-G) TO STATION 684+70.46 (13-2-G)

# EXISTING TYPICAL CROSS SECTION

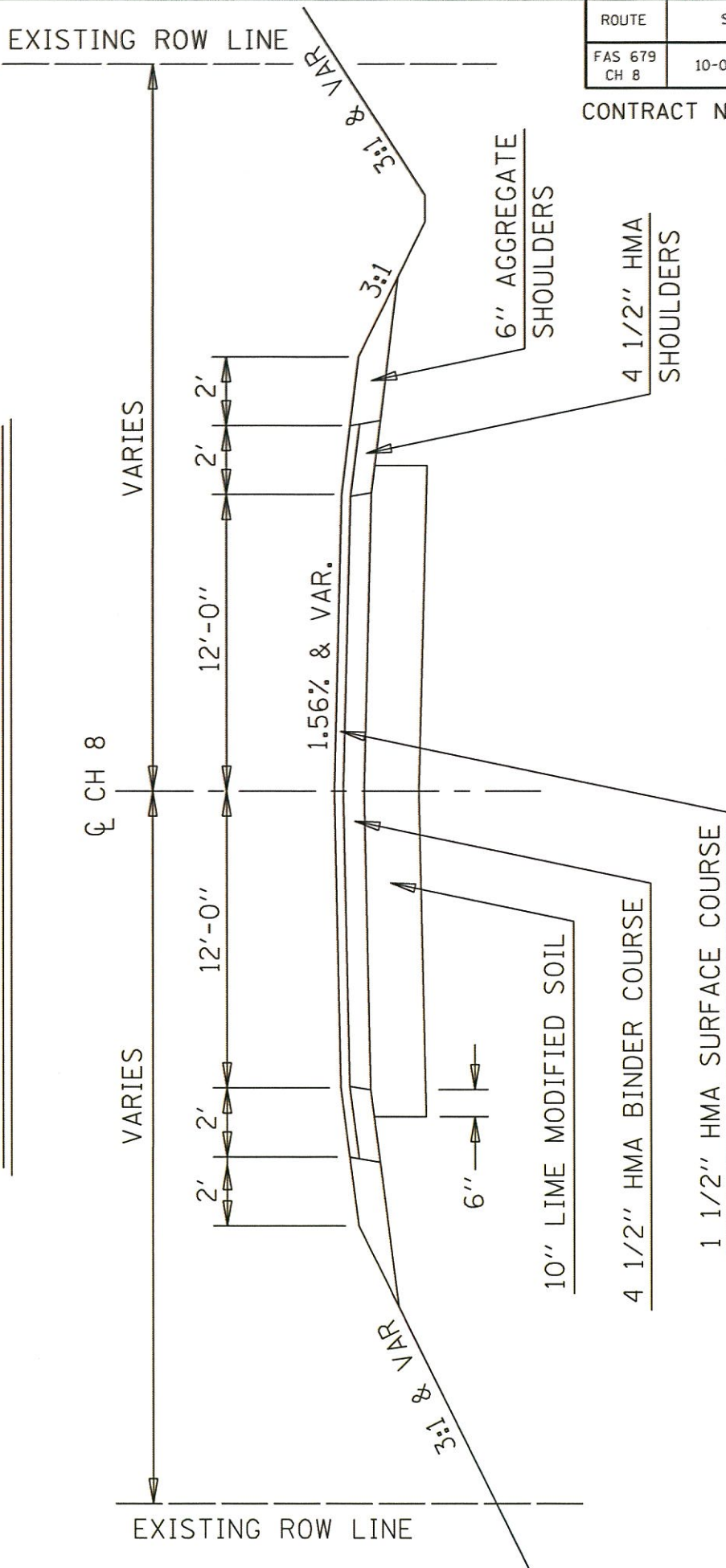

| ROUTE           | SECTION        | COUNTY | TOTAL SHEETS | SHEET NO. |
|-----------------|----------------|--------|--------------|-----------|
| FAS 679<br>CH 8 | 10-00105-02-R5 | EDGAR  | 21           | 11        |

CONTRACT NO. 91491

COUNTY HIGHWAY 8

STATION 192+30.02 (13-1-Q) TO STATION 205+00 (13-1-Q)  
 STATION 0+00 (13-3-Q) TO STATION 5+75.42 (13-3-Q)

STATION EQUATION:  
 STATION 205+00 (13-1-Q) (BACK) =  
 STATION 0+00 (13-3-Q) (AHEAD)

EXISTING TYPICAL CROSS SECTION

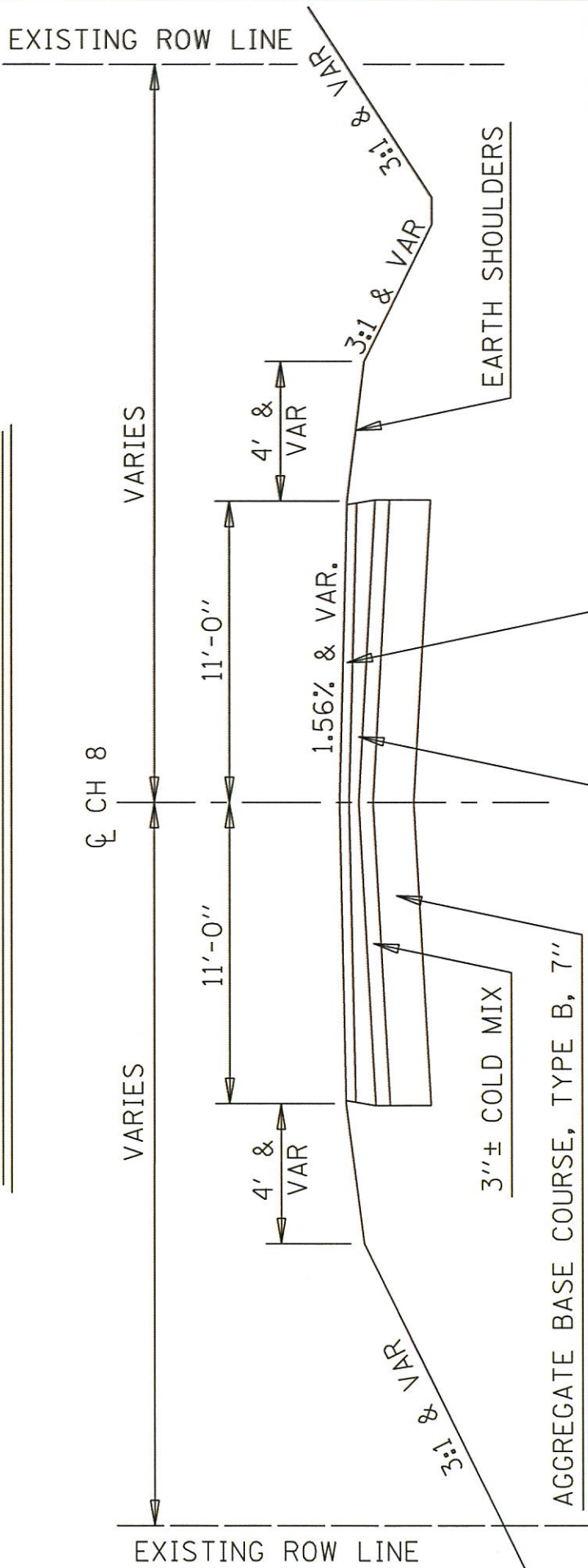

| ROUTE           | SECTION        | COUNTY | TOTAL SHEETS | SHEET NO. |
|-----------------|----------------|--------|--------------|-----------|
| FAS 679<br>CH 8 | 10-00105-02-RS | EDGAR  | 21           | 12        |

CONTRACT NO. 91491

STATION EQUATION:  
 STATION 203+56.60 (13-3-Q) (BACK)  
 STATION 0+00 (13-4-Q) (AHEAD)

COUNTY HIGHWAY 8  
 STATION 5+75.42 (13-3-Q) TO STATION 203+56.60 (13-3-Q)  
 STATION 0+00 (13-4-Q) TO STATION 158+59.20 (13-4-Q)

EXISTING TYPICAL CROSS SECTION

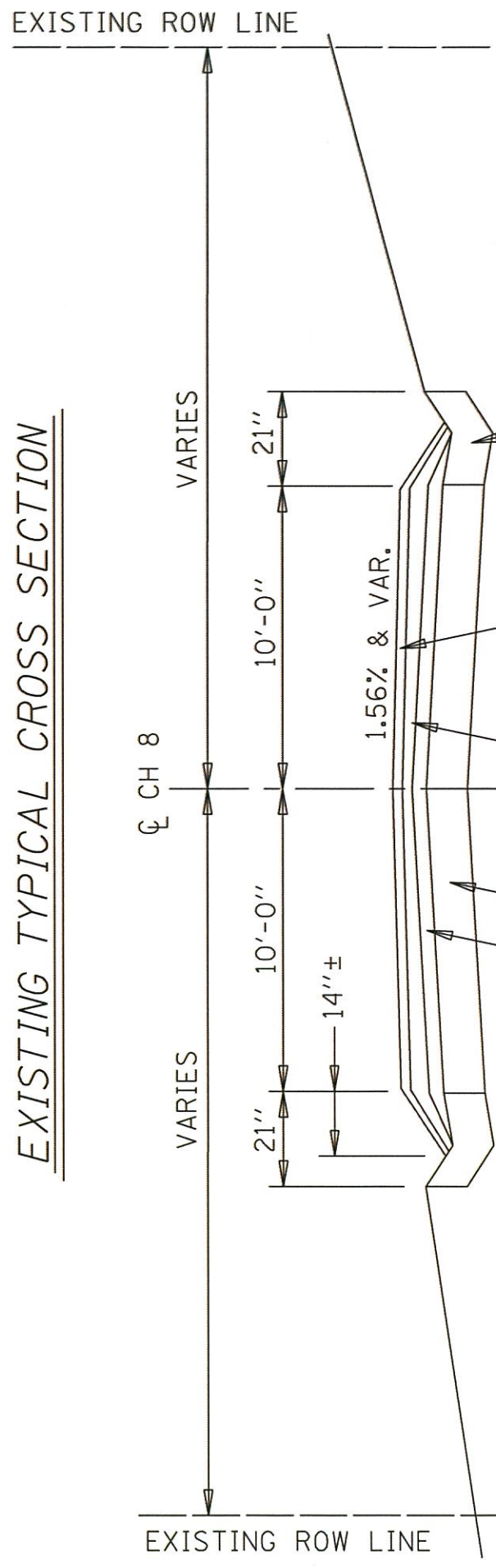

| ROUTE           | SECTION        | COUNTY | TOTAL SHEETS | SHEET NO. |
|-----------------|----------------|--------|--------------|-----------|
| FAS 679<br>CH 8 | 10-00105-02-RS | EDGAR  | 21           | 13        |

CONTRACT NO. 91491

OMMISSION FROM RESURFACING:  
STATION 620+08.70 TO STATION 620+17.40

COUNTY HIGHWAY 8  
STATION 613+00 (13-2-G) TO STATION 620+08.70 (13-2-G)  
STATION 620+17.40 (13-2-G) TO STATION 627+00 (13-2-G)

PROPOSED TYPICAL CROSS SECTION

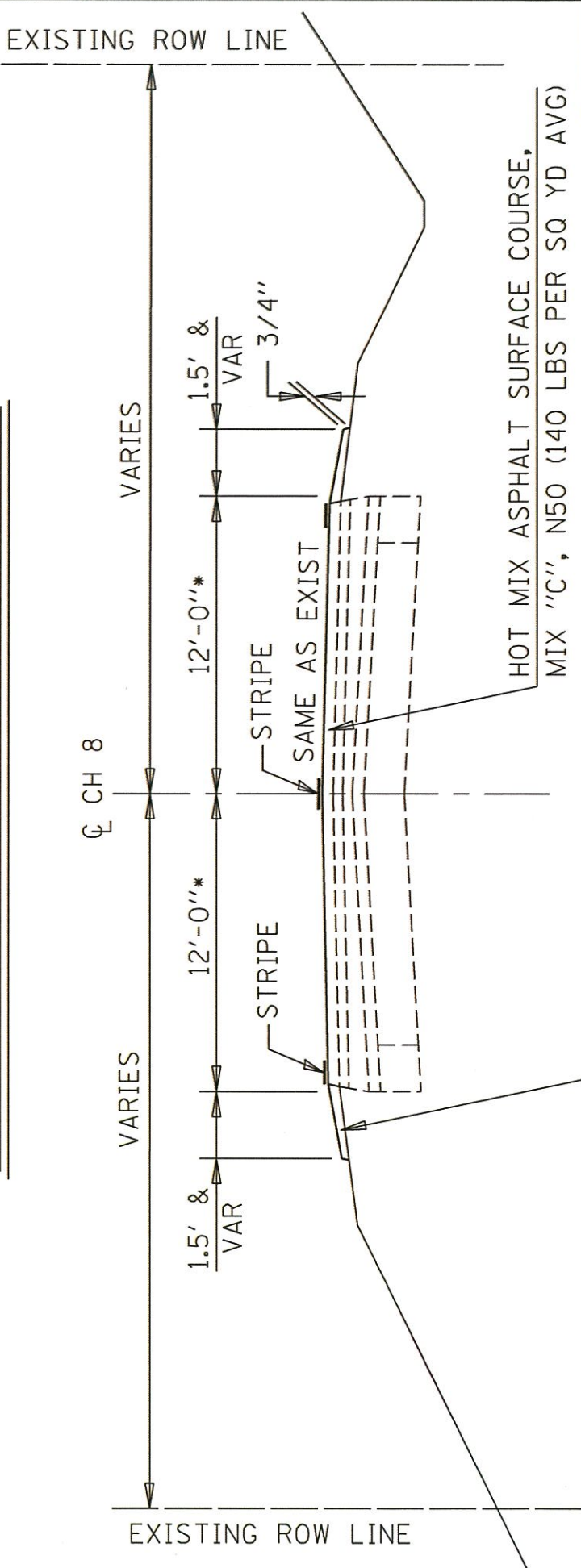

| ROUTE           | SECTION        | COUNTY | TOTAL SHEETS | SHEET NO. |
|-----------------|----------------|--------|--------------|-----------|
| FAS 679<br>CH 8 | 10-00105-02-RS | EDGAR  | 21           | 14        |

CONTRACT NO. 91491

\* SURFACE WIDTH TAPERS FROM 24 FEET AT STATION 98+47 TO 21 FEET AT STATION 103+47

COUNTY HIGHWAY 8  
 BEGIN SECTION STATION 2+74.50 (13-1-Q) TO STATION 103+47 (13-1-Q)

PROPOSED TYPICAL CROSS SECTION

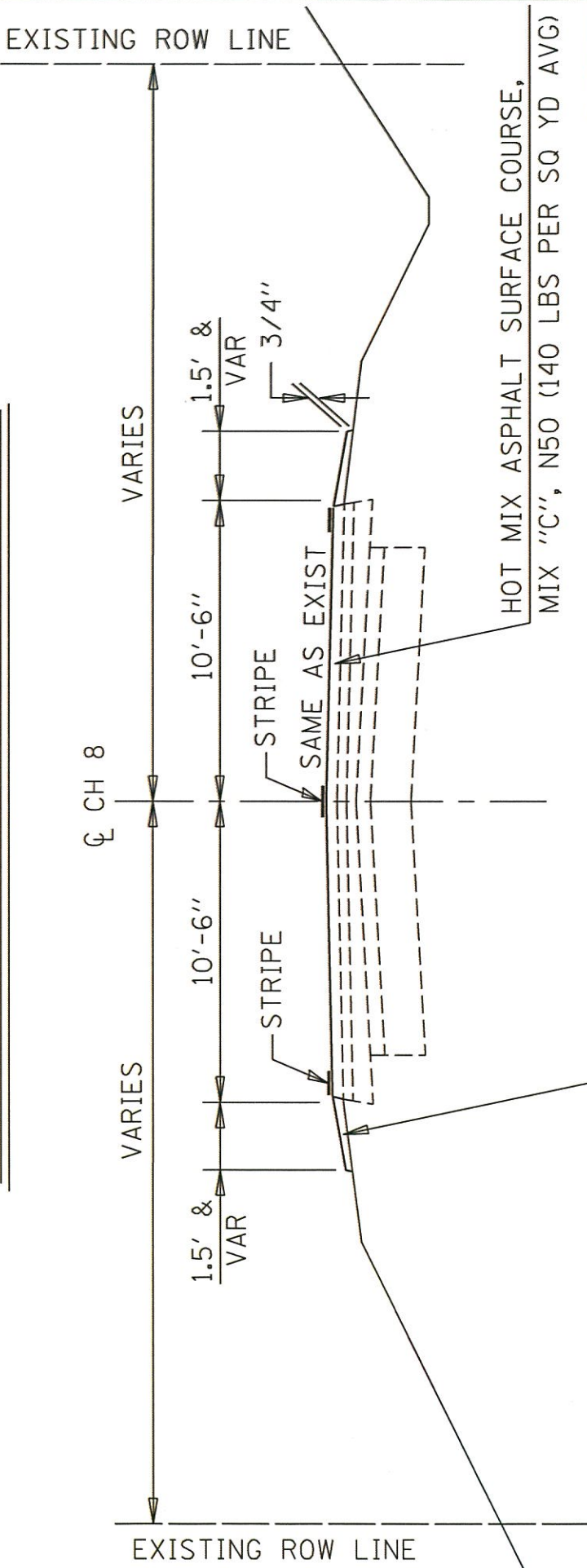

| ROUTE           | SECTION        | COUNTY | TOTAL SHEETS | SHEET NO. |
|-----------------|----------------|--------|--------------|-----------|
| FAS 679<br>CH 8 | 10-00105-02-RS | EDGAR  | 21           | 15        |

CONTRACT NO. 91491

AGGREGATE WEDGE SHOULDER, TYPE B  
SLOPE VARIES: 4% MINIMUM, 12.5% MAXIMUM

COUNTY HIGHWAY 8  
STATION 103+47 (13-1-Q) TO STATION 192+30.02 (13-1-Q)  
STATION 566+44.60 (13-2-G) TO STATION 613+00 (13-2-G)  
STATION 627+00 (13-2-G) TO STATION 684+70.46 (13-2-G)

PROPOSED TYPICAL CROSS SECTION

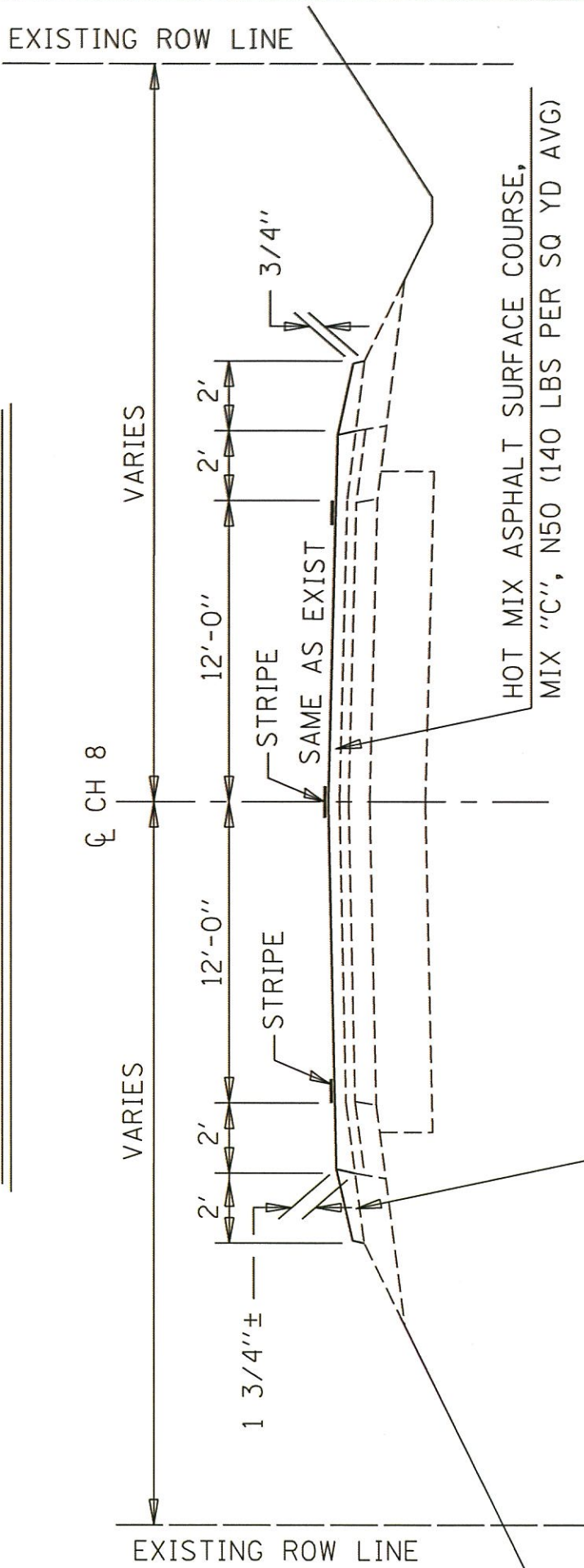

| ROUTE           | SECTION        | COUNTY | TOTAL SHEETS | SHEET NO. |
|-----------------|----------------|--------|--------------|-----------|
| FAS 679<br>CH 8 | 10-00105-02-RS | EDGAR  | 21           | 16        |

CONTRACT NO. 91491

AGGREGATE WEDGE SHOULDER, TYPE B  
 SLOPE VARIES: 4% MINIMUM,  
 12.5% MAXIMUM

COUNTY HIGHWAY 8

STATION 192+30.02 (13-1-Q) TO STATION 205+00 (13-1-Q)  
 STATION 0+00 (13-3-Q) TO STATION 5+75.42 (13-3-Q)

STATION EQUATION:  
 STATION 205+00 (13-1-Q) (BACK) =  
 STATION 0+00 (13-3-Q) (AHEAD)

PROPOSED TYPICAL CROSS SECTION

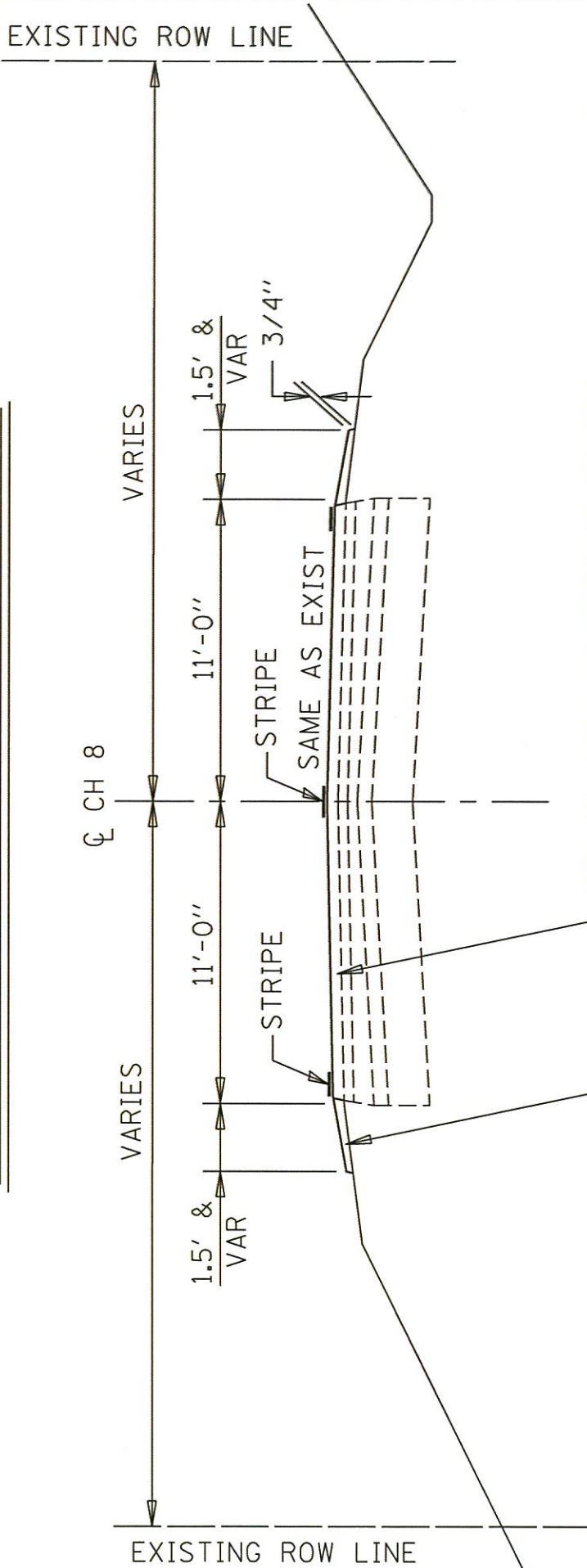

|                 |                |        |              |           |
|-----------------|----------------|--------|--------------|-----------|
| ROUTE           | SECTION        | COUNTY | TOTAL SHEETS | SHEET NO. |
| FAS 679<br>CH 8 | 10-00105-02-RS | EDGAR  | 21           | 17        |

CONTRACT NO. 91491

HOT MIX ASPHALT SURFACE COURSE,  
MIX "C", N50 (140 LBS PER SQ YD AVG)

AGGREGATE WEDGE SHOULDER,  
TYPE B  
SLOPE VARIES: 4% MINIMUM,  
12.5% MAXIMUM

COUNTY HIGHWAY 8  
STATION 5+75.42 (13-3-Q) TO STATION 203+56.60 (13-3-Q)  
STATION 0+00 (13-4-Q) TO STATION 158+59.20 (13-4-Q)

STATION EQUATION:  
STATION 203+56.60 (13-3-Q) (BACK) =  
STATION 0+00 (13-4-Q) (AHEAD)



EXISTING ROW LINE

PROPOSED TYPICAL CROSS SECTION

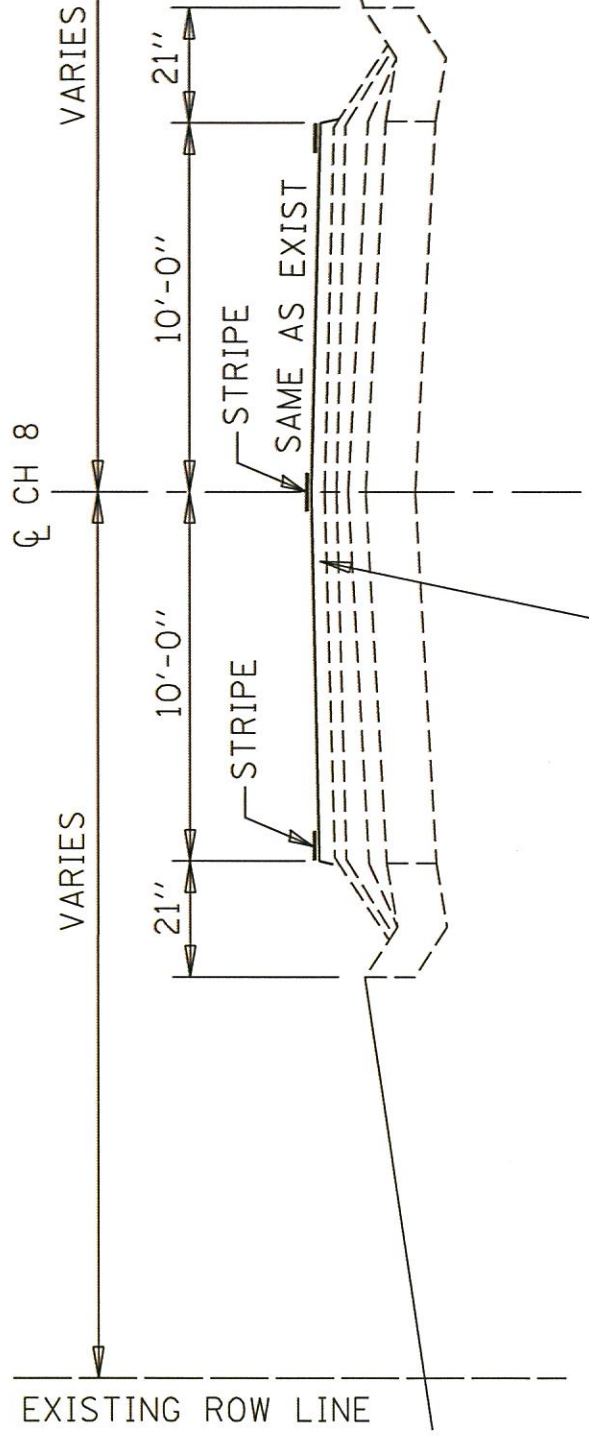

HOT MIX ASPHALT SURFACE COURSE,  
MIX "C", N50 (140 LBS PER SQ YD AVG)

|                 |                |        |              |           |
|-----------------|----------------|--------|--------------|-----------|
| ROUTE           | SECTION        | COUNTY | TOTAL SHEETS | SHEET NO. |
| FAS 679<br>CH 8 | 10-00105-02-RS | EDGAR  | 21           | 18        |

CONTRACT NO. 91491

COUNTY HIGHWAY 8

STATION 613+00 (13-2-G) TO STATION 620+08.70 (13-2-G)  
STATION 620+17.40 (13-2-G) TO STATION 627+00 (13-2-G)

OMMISSION FROM RESURFACING:  
STATION 620+08.70 TO STATION 620+17.40

# BUTT JOINT DETAILS

| ROUTE             | SECTION        | COUNTY | TOTAL SHEETS | SHEET NO. |
|-------------------|----------------|--------|--------------|-----------|
| FAS 679<br>(CH B) | 10-00105-02-R5 | EDGAR  | 21           | 19        |

CONTRACT NO. 91491

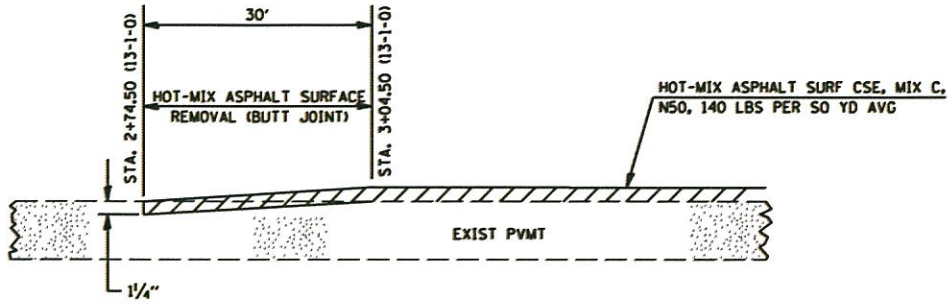

## BUTT JOINT DETAIL

STATION 2+74.50 (13-1-0)  
TO STATION 3+04.50 (13-1-0)

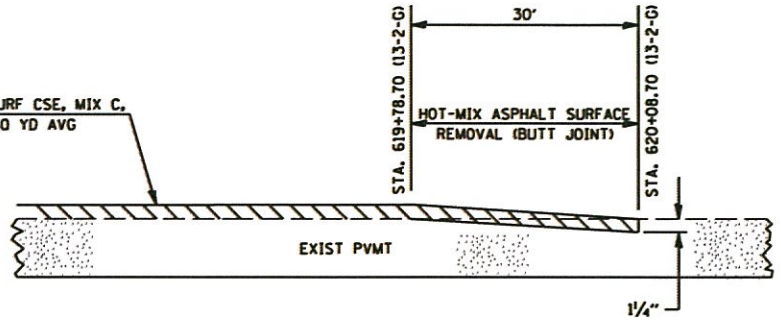

## BUTT JOINT DETAIL

STATION 619+78.70 (13-2-G)  
TO STATION 620+08.70 (13-2-G)

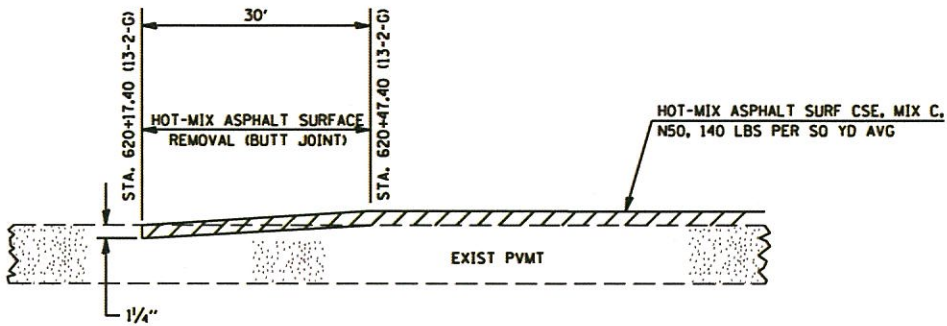

## BUTT JOINT DETAIL

STATION 620+17.40 (13-2-G)  
TO STATION 620+47.40 (13-2-G)

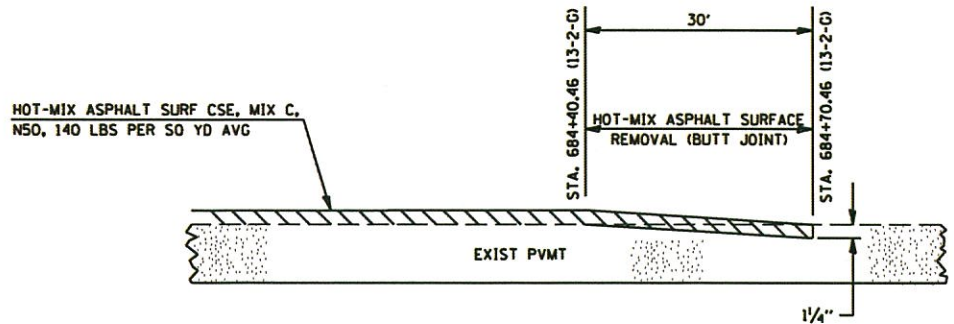

## BUTT JOINT DETAIL

STATION 684+40.46 (13-2-G)  
TO STATION 684+70.46 (13-2-G)

# SIDEROAD, ENTRANCE & MAILBOX

## RETURN RESURFACING DETAILS

| ROUTE              | SECTION        | COUNTY | TOTAL SHEETS | SHEET NO. |
|--------------------|----------------|--------|--------------|-----------|
| FAS 679<br>(CH. 8) | 10-00105-02-R5 | EDGAR  | 21           | 20        |

CONTRACT NO. 91491

 HMA SURFACE COURSE, MIX "C", N50  
TO BE LAID WITH THE MAINLINE PAVING

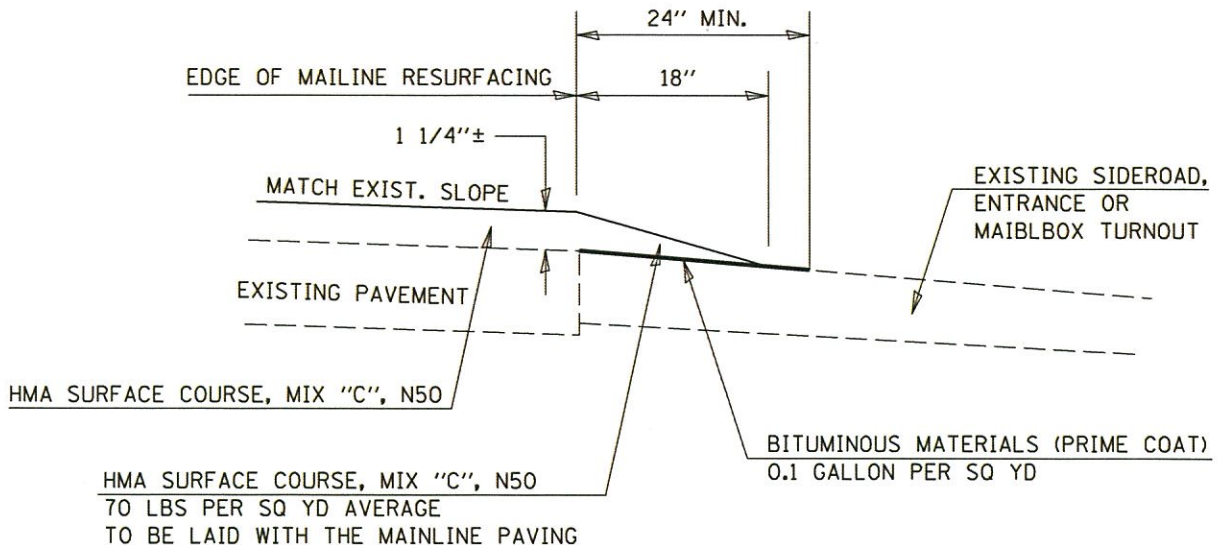
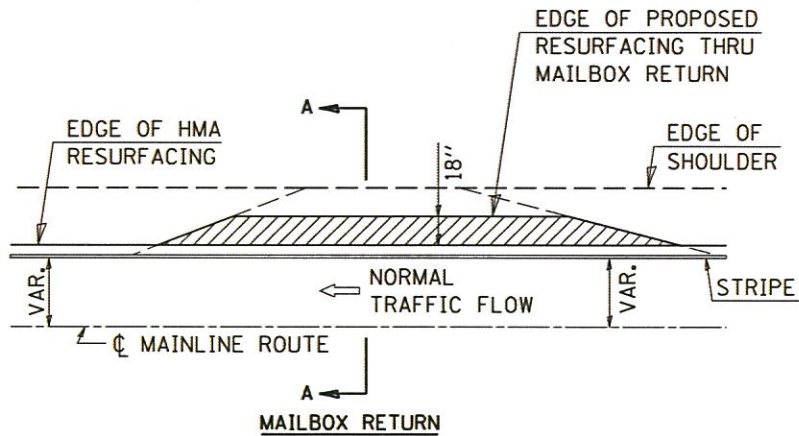
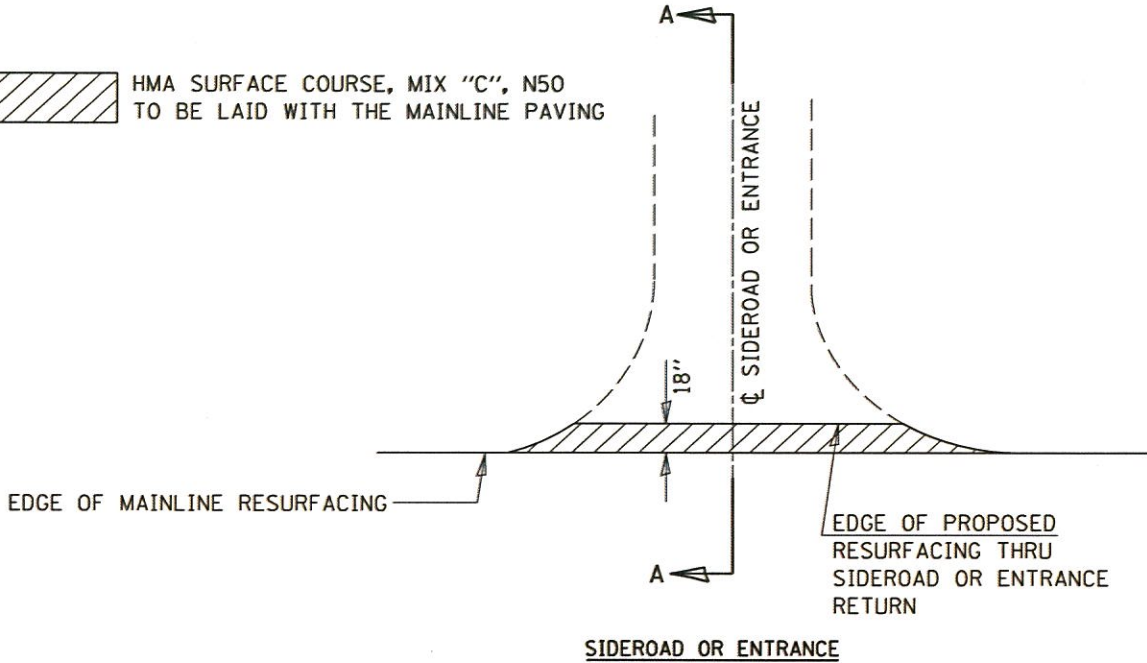

# STRIPING DETAILS

| ROUTE              | SECTION        | COUNTY | TOTAL SHEETS | SHEET NO. |
|--------------------|----------------|--------|--------------|-----------|
| FAS 679<br>(CH. 6) | 10-00105-02-R5 | EDGAR  | 21           | 21        |

CONTRACT NO. 91491

## TYPICAL PAVEMENT MARKING LEGEND

- 1 4" (100) SKIP-DASH (YELLOW)
- 2 4" (100) SOLID (YELLOW)
- 4 4" (100) DOUBLE YELLOW (NARROW)
- 8 4" (100) SOLID (WHITE)
- 11 24" (600) STOP BAR (WHITE)

## TYPICAL PAVEMENT MARKERS LEGEND

- TWO-WAY AMBER MARKER
- ONE-WAY AMBER MARKER
- ONE-WAY CRYSTAL MARKER

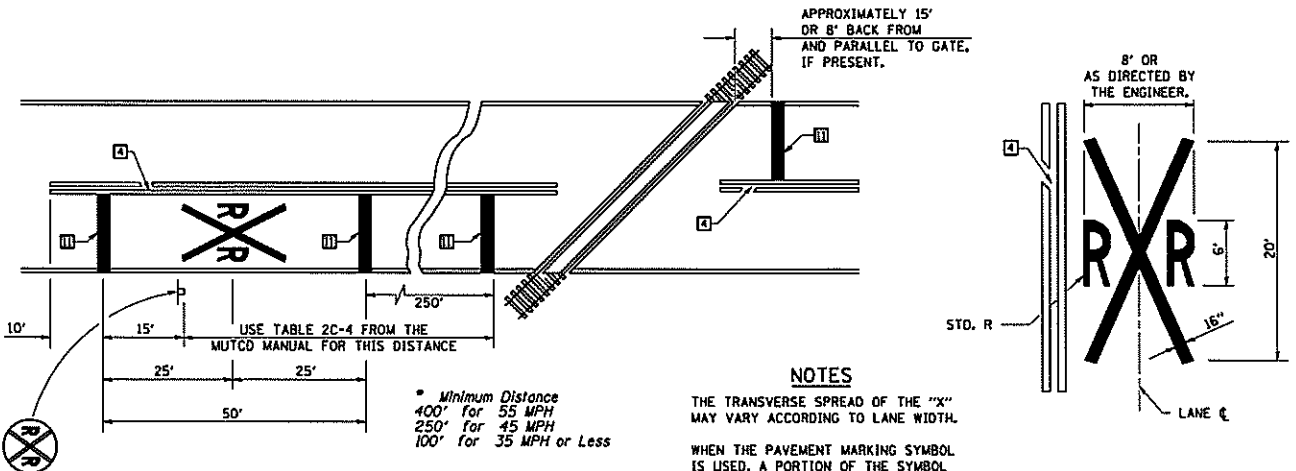
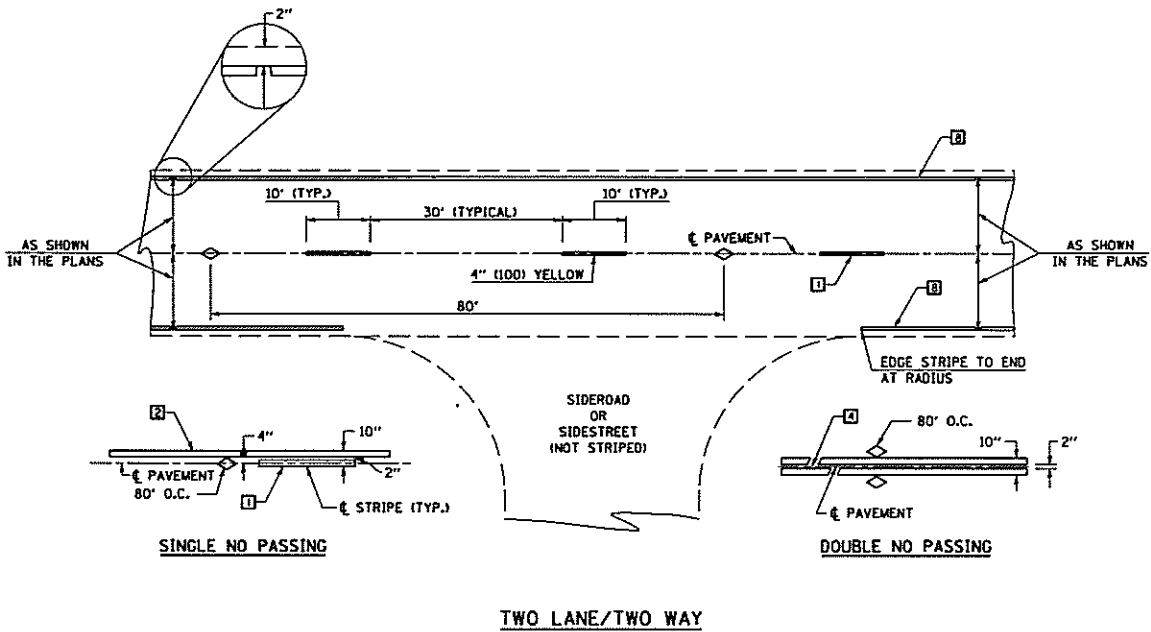

PAVEMENT MARKINGS AT  
RAILROAD-HIGHWAY GRADE CROSSING

DECIMAL OF AN INCH AND OF A FOOT

| A        |       | B        |       | A        |       | B        |       | A        |       | B        |       | A        |       | B        |       |
|----------|-------|----------|-------|----------|-------|----------|-------|----------|-------|----------|-------|----------|-------|----------|-------|
| 0.0052   | 1/200 | 0.0052   | 1/200 | 0.0052   | 1/200 | 0.0052   | 1/200 | 0.0052   | 1/200 | 0.0052   | 1/200 | 0.0052   | 1/200 | 0.0052   | 1/200 |
| 0.0104   | 1/100 | 0.0104   | 1/100 | 0.0104   | 1/100 | 0.0104   | 1/100 | 0.0104   | 1/100 | 0.0104   | 1/100 | 0.0104   | 1/100 | 0.0104   | 1/100 |
| 0.015625 | 1/64  | 0.015625 | 1/64  | 0.015625 | 1/64  | 0.015625 | 1/64  | 0.015625 | 1/64  | 0.015625 | 1/64  | 0.015625 | 1/64  | 0.015625 | 1/64  |
| 0.0208   | 1/48  | 0.0208   | 1/48  | 0.0208   | 1/48  | 0.0208   | 1/48  | 0.0208   | 1/48  | 0.0208   | 1/48  | 0.0208   | 1/48  | 0.0208   | 1/48  |
| 0.0260   | 1/38  | 0.0260   | 1/38  | 0.0260   | 1/38  | 0.0260   | 1/38  | 0.0260   | 1/38  | 0.0260   | 1/38  | 0.0260   | 1/38  | 0.0260   | 1/38  |
| 0.03125  | 1/32  | 0.03125  | 1/32  | 0.03125  | 1/32  | 0.03125  | 1/32  | 0.03125  | 1/32  | 0.03125  | 1/32  | 0.03125  | 1/32  | 0.03125  | 1/32  |
| 0.0365   | 1/27  | 0.0365   | 1/27  | 0.0365   | 1/27  | 0.0365   | 1/27  | 0.0365   | 1/27  | 0.0365   | 1/27  | 0.0365   | 1/27  | 0.0365   | 1/27  |
| 0.0417   | 1/24  | 0.0417   | 1/24  | 0.0417   | 1/24  | 0.0417   | 1/24  | 0.0417   | 1/24  | 0.0417   | 1/24  | 0.0417   | 1/24  | 0.0417   | 1/24  |
| 0.046875 | 1/21  | 0.046875 | 1/21  | 0.046875 | 1/21  | 0.046875 | 1/21  | 0.046875 | 1/21  | 0.046875 | 1/21  | 0.046875 | 1/21  | 0.046875 | 1/21  |
| 0.0520   | 1/19  | 0.0520   | 1/19  | 0.0520   | 1/19  | 0.0520   | 1/19  | 0.0520   | 1/19  | 0.0520   | 1/19  | 0.0520   | 1/19  | 0.0520   | 1/19  |
| 0.0573   | 1/17  | 0.0573   | 1/17  | 0.0573   | 1/17  | 0.0573   | 1/17  | 0.0573   | 1/17  | 0.0573   | 1/17  | 0.0573   | 1/17  | 0.0573   | 1/17  |
| 0.0625   | 1/16  | 0.0625   | 1/16  | 0.0625   | 1/16  | 0.0625   | 1/16  | 0.0625   | 1/16  | 0.0625   | 1/16  | 0.0625   | 1/16  | 0.0625   | 1/16  |
| 0.0677   | 1/15  | 0.0677   | 1/15  | 0.0677   | 1/15  | 0.0677   | 1/15  | 0.0677   | 1/15  | 0.0677   | 1/15  | 0.0677   | 1/15  | 0.0677   | 1/15  |
| 0.0729   | 1/14  | 0.0729   | 1/14  | 0.0729   | 1/14  | 0.0729   | 1/14  | 0.0729   | 1/14  | 0.0729   | 1/14  | 0.0729   | 1/14  | 0.0729   | 1/14  |
| 0.078125 | 1/13  | 0.078125 | 1/13  | 0.078125 | 1/13  | 0.078125 | 1/13  | 0.078125 | 1/13  | 0.078125 | 1/13  | 0.078125 | 1/13  | 0.078125 | 1/13  |
| 0.0833   | 1/12  | 0.0833   | 1/12  | 0.0833   | 1/12  | 0.0833   | 1/12  | 0.0833   | 1/12  | 0.0833   | 1/12  | 0.0833   | 1/12  | 0.0833   | 1/12  |
| 0.0885   | 1/11  | 0.0885   | 1/11  | 0.0885   | 1/11  | 0.0885   | 1/11  | 0.0885   | 1/11  | 0.0885   | 1/11  | 0.0885   | 1/11  | 0.0885   | 1/11  |
| 0.09375  | 1/10  | 0.09375  | 1/10  | 0.09375  | 1/10  | 0.09375  | 1/10  | 0.09375  | 1/10  | 0.09375  | 1/10  | 0.09375  | 1/10  | 0.09375  | 1/10  |
| 0.0990   | 1/9   | 0.0990   | 1/9   | 0.0990   | 1/9   | 0.0990   | 1/9   | 0.0990   | 1/9   | 0.0990   | 1/9   | 0.0990   | 1/9   | 0.0990   | 1/9   |
| 0.1042   | 1/8   | 0.1042   | 1/8   | 0.1042   | 1/8   | 0.1042   | 1/8   | 0.1042   | 1/8   | 0.1042   | 1/8   | 0.1042   | 1/8   | 0.1042   | 1/8   |
| 0.109375 | 1/7   | 0.109375 | 1/7   | 0.109375 | 1/7   | 0.109375 | 1/7   | 0.109375 | 1/7   | 0.109375 | 1/7   | 0.109375 | 1/7   | 0.109375 | 1/7   |
| 0.1146   | 1/6   | 0.1146   | 1/6   | 0.1146   | 1/6   | 0.1146   | 1/6   | 0.1146   | 1/6   | 0.1146   | 1/6   | 0.1146   | 1/6   | 0.1146   | 1/6   |
| 0.1198   | 1/5   | 0.1198   | 1/5   | 0.1198   | 1/5   | 0.1198   | 1/5   | 0.1198   | 1/5   | 0.1198   | 1/5   | 0.1198   | 1/5   | 0.1198   | 1/5   |
| 0.1250   | 1/4   | 0.1250   | 1/4   | 0.1250   | 1/4   | 0.1250   | 1/4   | 0.1250   | 1/4   | 0.1250   | 1/4   | 0.1250   | 1/4   | 0.1250   | 1/4   |
| 0.1302   | 1/3   | 0.1302   | 1/3   | 0.1302   | 1/3   | 0.1302   | 1/3   | 0.1302   | 1/3   | 0.1302   | 1/3   | 0.1302   | 1/3   | 0.1302   | 1/3   |
| 0.1354   | 1/2   | 0.1354   | 1/2   | 0.1354   | 1/2   | 0.1354   | 1/2   | 0.1354   | 1/2   | 0.1354   | 1/2   | 0.1354   | 1/2   | 0.1354   | 1/2   |
| 0.140625 | 1/2   | 0.140625 | 1/2   | 0.140625 | 1/2   | 0.140625 | 1/2   | 0.140625 | 1/2   | 0.140625 | 1/2   | 0.140625 | 1/2   | 0.140625 | 1/2   |
| 0.1458   | 1/2   | 0.1458   | 1/2   | 0.1458   | 1/2   | 0.1458   | 1/2   | 0.1458   | 1/2   | 0.1458   | 1/2   | 0.1458   | 1/2   | 0.1458   | 1/2   |
| 0.1510   | 1/2   | 0.1510   | 1/2   | 0.1510   | 1/2   | 0.1510   | 1/2   | 0.1510   | 1/2   | 0.1510   | 1/2   | 0.1510   | 1/2   | 0.1510   | 1/2   |
| 0.15625  | 1/2   | 0.15625  | 1/2   | 0.15625  | 1/2   | 0.15625  | 1/2   | 0.15625  | 1/2   | 0.15625  | 1/2   | 0.15625  | 1/2   | 0.15625  | 1/2   |
| 0.1615   | 1/2   | 0.1615   | 1/2   | 0.1615   | 1/2   | 0.1615   | 1/2   | 0.1615   | 1/2   | 0.1615   | 1/2   | 0.1615   | 1/2   | 0.1615   | 1/2   |
| 0.1667   | 1/2   | 0.1667   | 1/2   | 0.1667   | 1/2   | 0.1667   | 1/2   | 0.1667   | 1/2   | 0.1667   | 1/2   | 0.1667   | 1/2   | 0.1667   | 1/2   |

DECIMAL OF AN INCH AND OF A FOOT

| DATE   | REVISIONS     |
|--------|---------------|
| 1-1-97 | New Standard. |
|        |               |
|        |               |
|        |               |
|        |               |

A = Fractions of Inch or Foot  
 B = Inch Equivalents to Foot Fractions

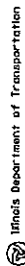
 Illinois Department of Transportation  
 PASSED \_\_\_\_\_ 1997  
 APPROVED \_\_\_\_\_ 1997  
 ENGINEER OF DESIGN AND ENVIRONMENT

ISSUED 1-1-97

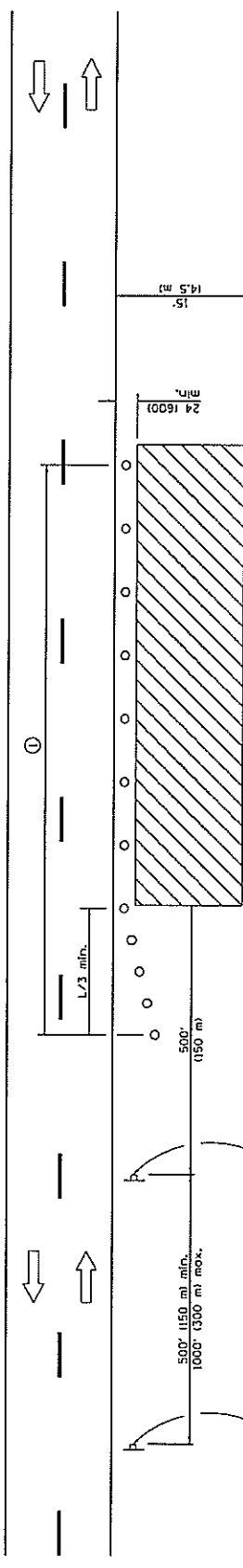

For contract construction projects

For maintenance and utility projects

W21-1101-48

W20-1103101-48

W20-1101-48

**TYPICAL APPLICATIONS**

- Utility operations
- Culvert extensions
- Side slope changes
- Guardrail installation and maintenance
- Delimitation installation
- Landscaping operations
- Shoulder repair
- Sign installation and maintenance

**SYMBOLS**

- Work area
- Sign
- Cone, drum or barricade

① When the work operation exceeds one hour, cones, drums or barricades shall be placed at 25' (8 m) centers for L/3 distance, and at 50' (15 m) centers through the remainder of the work area.

**GENERAL NOTES**

This Standard is used where any vehicles, equipment, workers or their activities will encroach on the travel area (5' (1.5 m) to 24' (7.62 m) from the edge of pavement).

Calculate L as follows:

**SPEED LIMIT**

| FORMULAS              |                        |
|-----------------------|------------------------|
| English               | (Metric)               |
| $L = \frac{WS^2}{60}$ | $L = \frac{WS^2}{150}$ |
| $L = (W)(S)$          | $L = 0.65(W)(S)$       |

W = Width of offset in feet (meters),

S = Normal posted speed in mph (km/h).

All dimensions are in inches (millimeters) unless otherwise shown.

| DATE   | REVISIONS   |
|--------|---|
| 1-1-14 | Revised workers' sign number to agree with current MUTCD. |
| 1-1-13 | Unifed text 'WORKERS' sign.                               |

**OFF-RD OPERATIONS, 2L, 2W, 15' (4.5 m) TO 24" (600 mm) FROM PAVEMENT EDGE**

STANDARD 701006-05

Illinois Department of Transportation

APPROVED: January 1, 2014  
ENGINEER OF SAFETY ENGINEERING

APPROVED: January 1, 2014  
ENGINEER OF DESIGN AND ENVIRONMENT

ISSUED 1-1-97

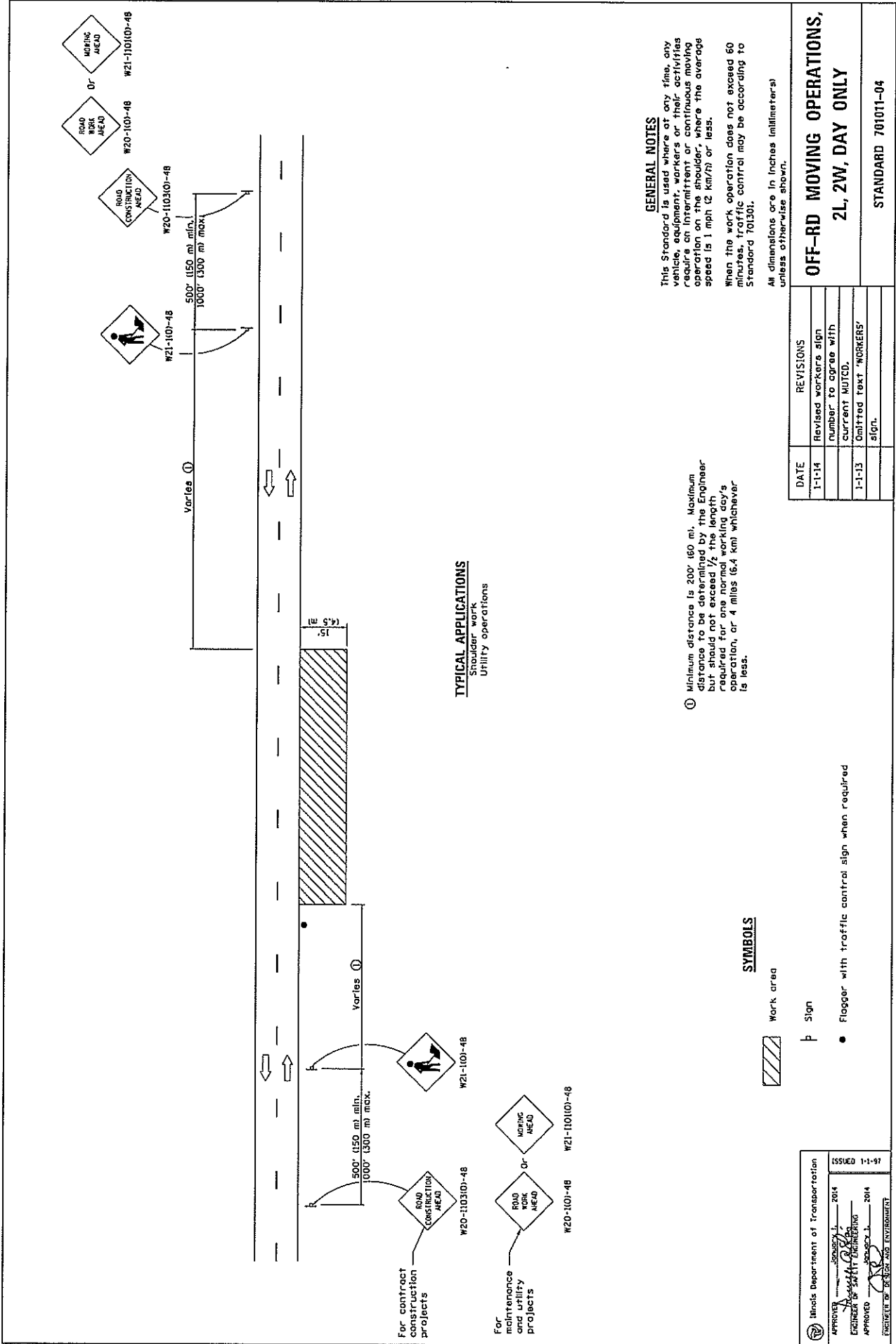

**TYPICAL APPLICATIONS**  
Shoulder work  
Utility operations

For contract construction projects

For maintenance and utility projects

① Minimum distance is 200' (60 m). Maximum distance to be determined by the Engineer but should not exceed 1/2 the length required for one normal working day's operation, or 4 miles (6.4 km) whichever is less.

**GENERAL NOTES**

This Standard is used where at any time, any vehicle, equipment, workers or their activities require an intermittent or continuous moving operation on the shoulder, where the average speed is 1 mph (1.6 km/h) or less. When the work operation does not exceed 60 minutes, traffic control may be according to Standard 701301.

All dimensions are in inches (millimeters) unless otherwise shown.

**SYMBOLS**

Work area

Sign

● Flagger with traffic control sign when required

| DATE   | REVISIONS   |
|--------|---|
| 1-1-14 | Revised worker's sign number to agree with current MUTCD. |
| 1-1-13 | Omitted text "WORKERS" sign.                              |

**OFF-RD MOVING OPERATIONS,  
2L, 2W, DAY ONLY**

STANDARD 701011-04

Illinois Department of Transportation  
ISSUED 1-1-97

APPROVED \_\_\_\_\_ 2014  
ENGINEER OF SAFETY ENGINEERING

APPROVED \_\_\_\_\_ 2014  
CHIEF OF DESIGN AND ENVIRONMENT

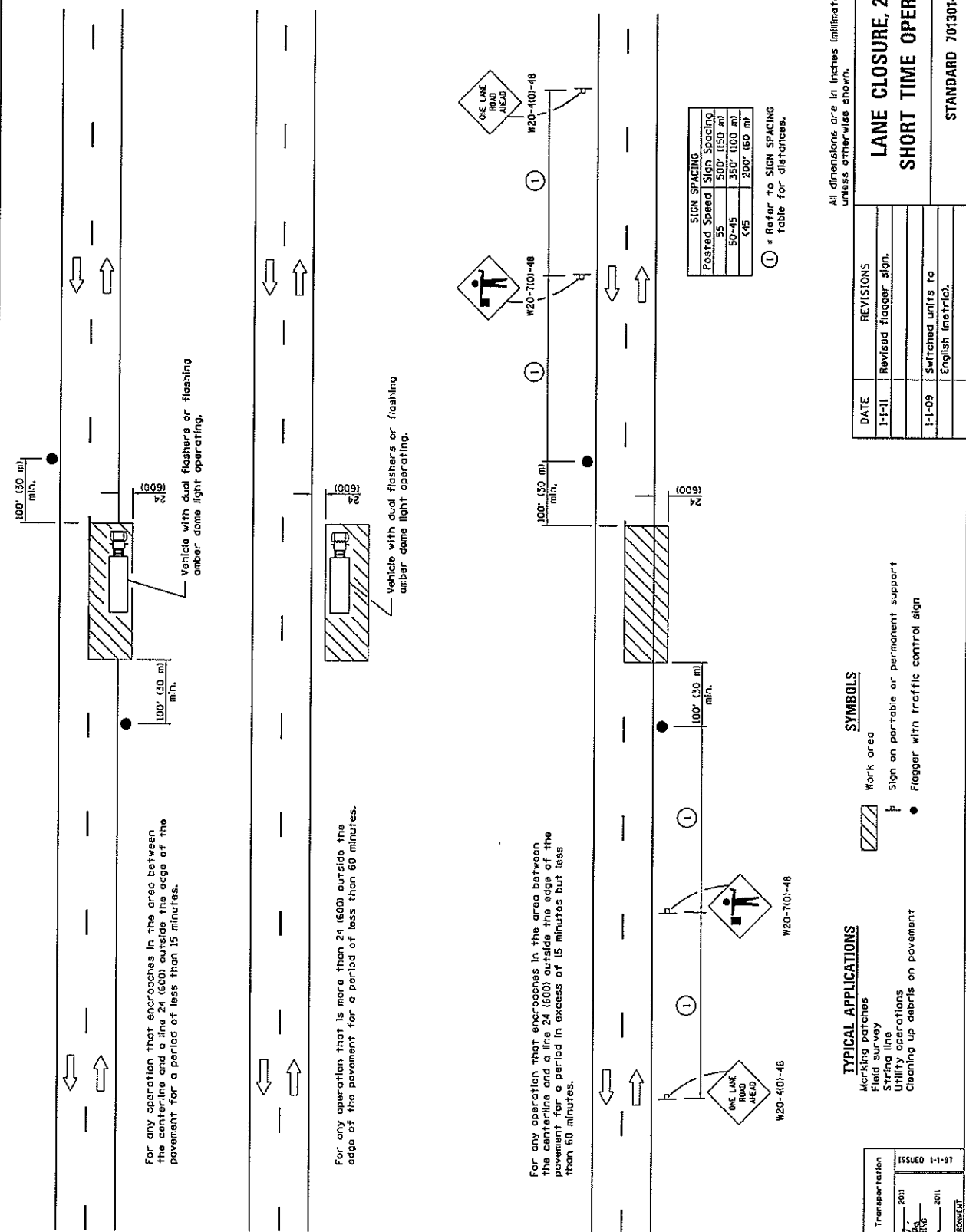

For any operation that encroaches in the area between the centerline and a line 24 (600) outside the edge of the pavement for a period of less than 15 minutes.

For any operation that is more than 24 (600) outside the edge of the pavement for a period of less than 60 minutes.

For any operation that encroaches in the area between the centerline and a line 24 (600) outside the edge of the pavement for a period in excess of 15 minutes but less than 80 minutes.

| Posted Speed | Sign Spacing |
|--------------|--------------|
| 55           | 500' (150 m) |
| 50-45        | 350' (100 m) |
| 45           | 200' (60 m)  |

① = Refer to SIGN SPACING Table for distances.

**TYPICAL APPLICATIONS**

- Marking patches
- Field survey
- Striping lanes
- Utility operations
- Cleaning up debris on pavement

**SYMBOLS**

- Work area
- Sign on portable or permanent support
- Flagger with traffic control sign

All dimensions are in inches (millimeters) unless otherwise shown.

Illinois Department of Transportation

APPROVED: [Signature] 2011

ENGINEER OF SAFETY

APPROVED: [Signature] 2011

ENGINEER OF TRAFFIC AND ENVIRONMENT

ISSUED 1-1-97

| DATE   | REVISIONS                           |
|--------|-------------------------------------|
| 1-1-11 | Revised flagger sign.               |
| 1-1-09 | Switched units to English (metric). |

**LANE CLOSURE, 2L, 2W, SHORT TIME OPERATIONS**

STANDARD 701301-04



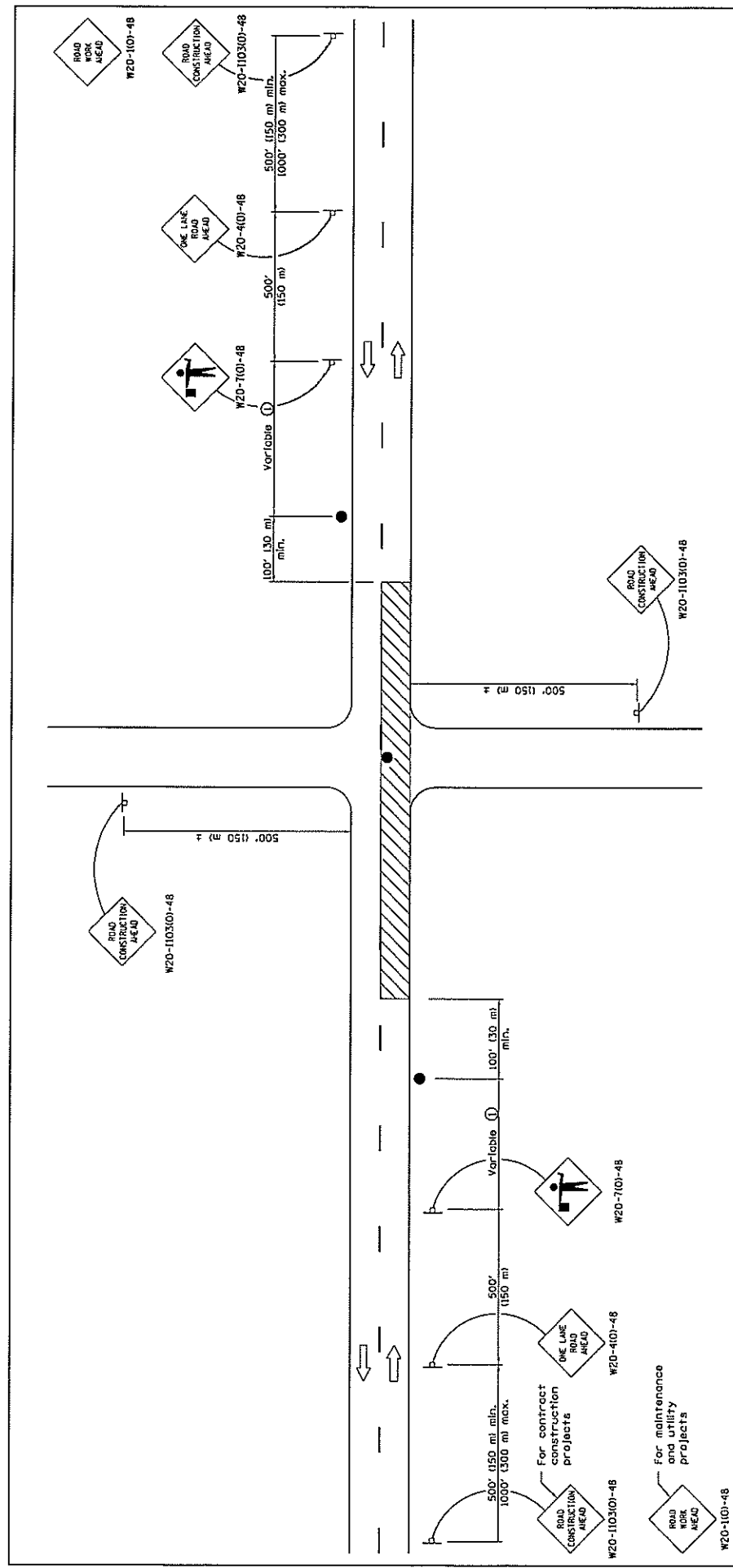

**GENERAL NOTES**  
 This Standard is used where at any time, any vehicle, equipment, workers or their activities require an intermittent or continuous moving operation on the pavement where the average speed of movement is greater than 1 mph (2 km/h) and less than 4 mph (6 km/h).  
 When the operation does not exceed 60 minutes, traffic control may be according to Standard 701301.  
 All dimensions are in inches (millimeters) unless otherwise shown.

**TYPICAL APPLICATIONS**  
 Bituminous resurfacing  
 Milling operations  
 Utility operations  
 Shoulder operations

**SYMBOLS**  
 [Hatched Box] Work area  
 [Sign] Sign on portable or permanent support  
 [Dot] Flagger with traffic control sign

**REVISIONS**

| DATE   | REVISIONS                           |
|--------|-------------------------------------|
| 1-1-11 | Revised flagger sign.               |
| 1-1-09 | Switched units to English (metric). |
|        | Corrected sign No.'s.               |

**MINIMUM DISTANCE IS 200' (60 m). Maximum distance to be determined by the Engineer but should not exceed 1/2 the length required for one normal working day's operation or 2 miles (3200 m), whichever is less.**

**LANE CLOSURE, 2L, 2W, SLOW MOVING OPERATIONS DAY ONLY, FOR SPEEDS ≥ 45 MPH**

STANDARD 701306-03

Illinois Department of Transportation

APPROVED: [Signature] JOURNAL 2011  
 ENGINEER OF SAFETY ENGINEERING

ISSUED 1-1-11

APPROVED: [Signature] 2011  
 ENGINEER OF DESIGN AND ENVIRONMENT

WET PAINT  
↓

C20-1101-2430  
(appropriate arrow)

WET PAINT  
↓

C20-1101-2430  
(appropriate arrow)

KEEP RIGHT  
↑

R4-70-2430

200' (60. m)  
min.

\* Distance varies depending on terrain and susceptibility of pavement marking or crack sealant to wheel tracking.

**TYPICAL APPLICATIONS**

- Landscape work
- Utility work
- Pavement marking
- Seed spraying
- Soil erosion measurements
- Debris cleanup
- Crack pouring

**SYMBOLS**

- Arrow board hazard (see only)
- Truck with headlights, emergency flashers and flashing amber light (visible from all directions)
- 18x18 (450x450) min. orange flag (use when guide wheel is used)
- Truck mounted attenuator

**GENERAL NOTES**

This Standard is used where any vehicle, equipment, workers or their activities will require a continuous moving operation where the average speed is greater than 5 mph (8 km/h).

For shoulder operations not encroaching on the pavement, use DETAIL A, Standard 701425. All dimensions are in inches (millimeter) unless otherwise shown.

Illinois Department of Transportation  
 APPROVED JANUARY 1, 2009  
 ENGINEER OF OPERATIONS  
 APPROVED JANUARY 1, 2009  
 ENGINEER OF DESIGN AND ENVIRONMENT

| DATE   | REVISIONS  |
|--------|--|
| 1-1-09 | Switched units to English metric. Omitted Post with Core sign. Elim. speed restrictions in Standard title. |
| 1-1-00 |  |

**LANE CLOSURE 2L, 2W  
MOVING OPERATIONS—  
DAY ONLY**  
STANDARD 701311-03

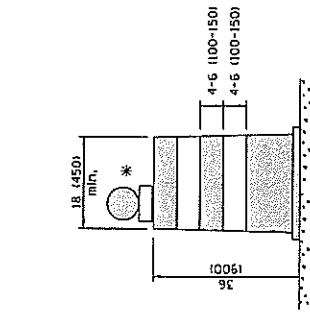

**DRUM**

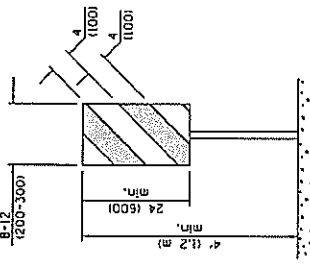

**VERTICAL PANEL  
POST MOUNTED**

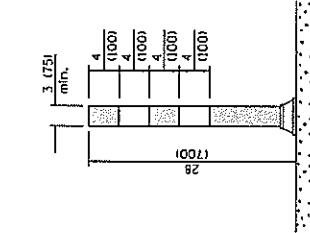

**FLEXIBLE DELINEATOR**

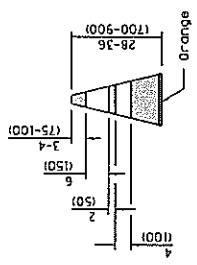

**REFLECTORIZED CONE**

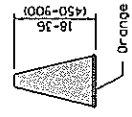

**CONE**

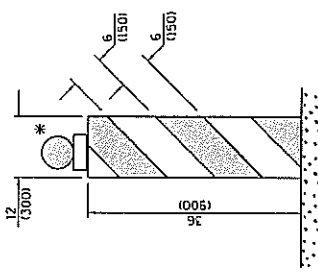

**VERTICAL BARRICADE**

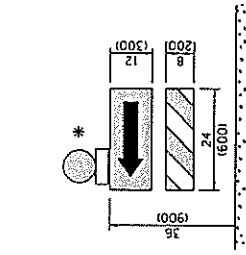

**DIRECTION INDICATOR  
BARRICADE**

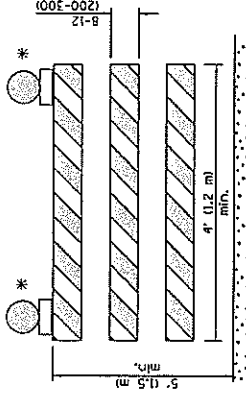

**TYPE III BARRICADE**

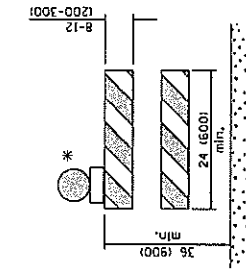

**TYPE II BARRICADE**

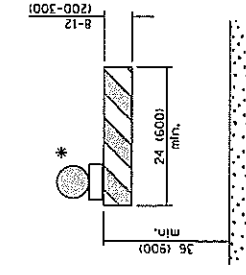

**TYPE I BARRICADE**

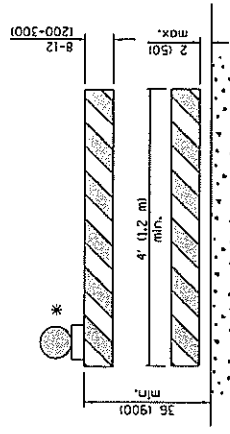

**DETECTABLE PEDESTRIAN  
CHANNELIZING BARRICADE**

\* Warning lights (if required)

**GENERAL NOTES**  
All heights shown shall be measured above the pavement surface.  
All dimensions are in inches (millimeters) unless otherwise shown.

| DATE   | REVISIONS   |
|--------|---|
| 1-1-14 | Modified flagger sign height.                       |
|        | Added highway construction                          |
|        | speed zone signs.                                   |
| 1-1-12 | Added DETECTABLE PEDESTRIAN CHANNELIZING BARRICADE. |

**TRAFFIC CONTROL  
DEVICES**

STANDARD 701901-03  
(Sheet 1 of 3)

|                                       |              |
|---------------------------------------|--------------|
| Illinois Department of Transportation | ISSUED 03/55 |
| APPROVED [Signature] 2011             |              |
| ENGINEER OF OPERATIONS                |              |
| APPROVED [Signature] 2014             |              |
| ENGINEER OF DESIGN AND ENVIRONMENT    |              |

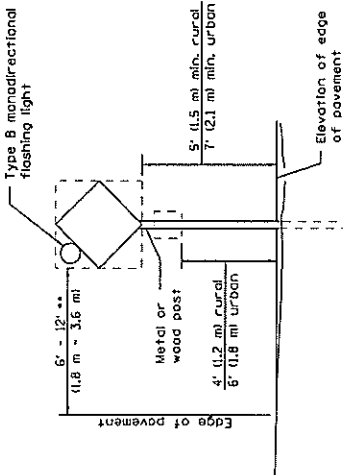

5' (1.5 m) min. embedment

**POST MOUNTED SIGNS**

\*\* When curb or paved shoulder are present this dimension shall be 24 (600) to the face of curb or 5' (1.8 m) to the outside edge of the paved shoulder.

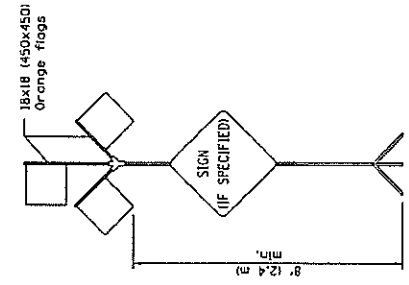

**HIGH LEVEL WARNING DEVICE**

**SIGNS ON TEMPORARY SUPPORTS**

\*\*\* When work operations exceed four days, this dimension shall be 5' (1.5 m) min. If located behind other devices, the height shall be sufficient to be seen completely above the devices.

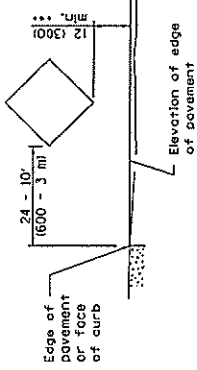

ROAD CONSTRUCTION NEXT X MILES

G20-1101-6036

END CONSTRUCTION

G20-2001-6024

This display is required for all projects 2 miles (3200 m) or more in length.

ROAD CONSTRUCTION NEXT X MILES sign shall be placed 500' (150 m) in advance of project limits.

END CONSTRUCTION sign shall be erected at the end of the job unless another job is within 2 miles (3200 m).

Dual sign displays shall be utilized on multi-lane highways.

**WORK LIMIT SIGNING**

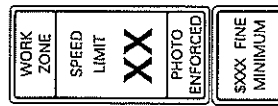

WZ1-11501-3618  
R2-1-3648  
R10-1108p-3618  
R2-1106p-3618

Sign assembly as shown on Standards or as allowed by District Operations.

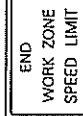

G20-110301-3660

This sign shall be used when the above sign assembly is used.

**HIGHWAY CONSTRUCTION SPEED ZONE SIGNS**

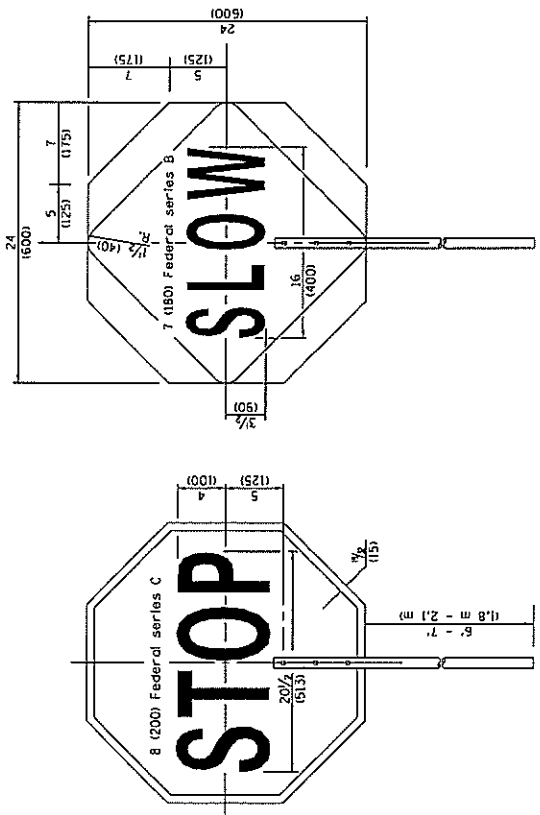

**FLAGGER TRAFFIC CONTROL SIGN**

Illinois Department of Transportation

APPROVED: [Signature] 2014

ENGINEER OF OPERATIONS

APPROVED: [Signature] 2014

ENGINEER OF DESIGN AND ENVIRONMENT

REVERSE SIDE

FRONT SIDE

**TRAFFIC CONTROL DEVICES**

(Sheet 2 of 3)

STANDARD 701901-03

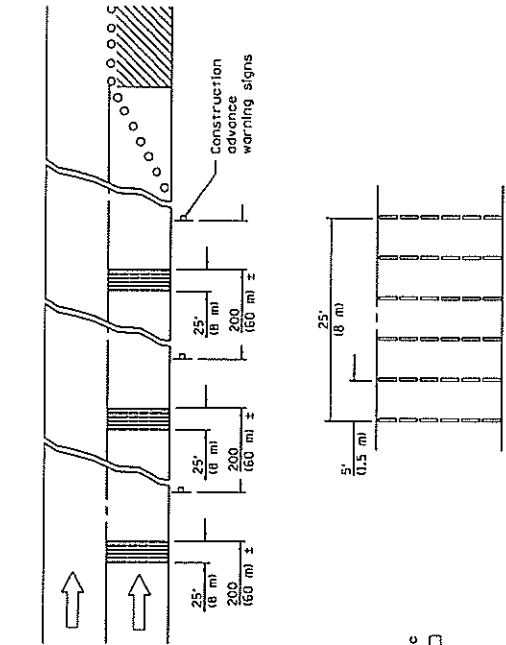

TYPICAL INSTALLATION

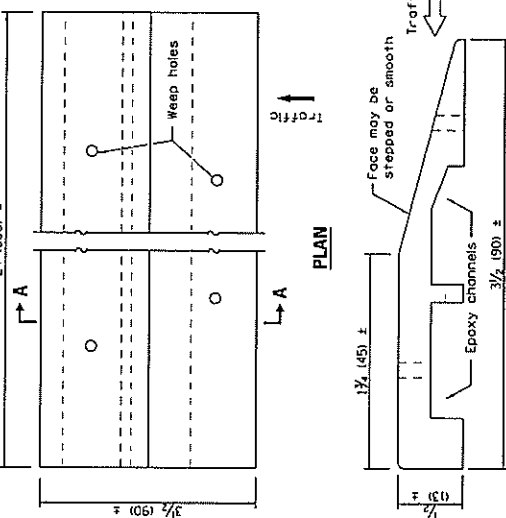

SECTION A-A

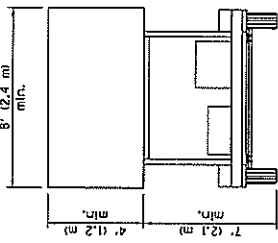

TYPE C  
TRAILER  
MOUNTED

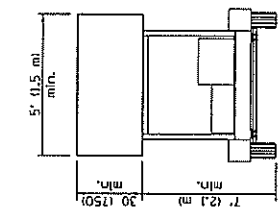

TYPE B  
ROOF OR TRAILER  
MOUNTED

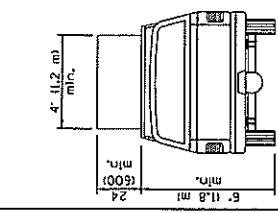

TYPE A  
ROOF  
MOUNTED

ARROW BOARDS

TEMPORARY RUMBLE STRIPS

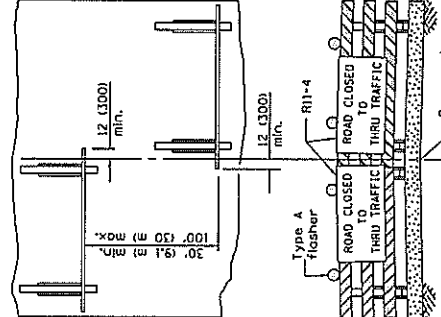

ROAD CLOSED TO THRU TRAFFIC

Reflectorized striping shall appear on both sides of the barricades. If a Type III barricade with an attached sign panel which meets NCHRP 350 is not available, the signs may be mounted on NCHRP 350 temporary sign supports directly in front of the barricade.

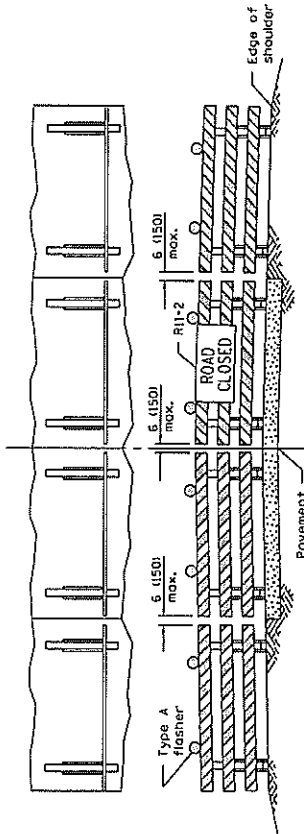

ROAD CLOSED TO ALL TRAFFIC

Reflectorized striping may be omitted if the back side of the barricades. If a Type III barricade with an attached sign panel which meets NCHRP 350 is not available, the signs may be mounted on NCHRP 350 temporary sign supports directly in front of the barricade.

TYPICAL APPLICATIONS OF  
TYPE III BARRICADES CLOSING A ROAD

TRAFFIC CONTROL  
DEVICES

STANDARD 701901-03

(Sheet 3 of 3)

Illinois Department of Transportation  
 APPROVED: [Signature] JUNE 11, 2014  
 ENGINEER OF OPERATIONS  
 APPROVED: [Signature] JUNE 11, 2014  
 ENGINEER OF DESIGN AND ESTIMATION  
 ISSUED 1-1-97

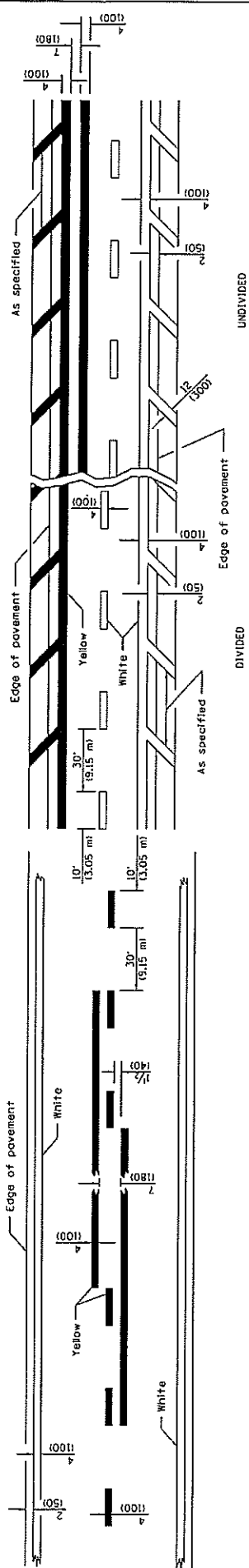

2 LANE

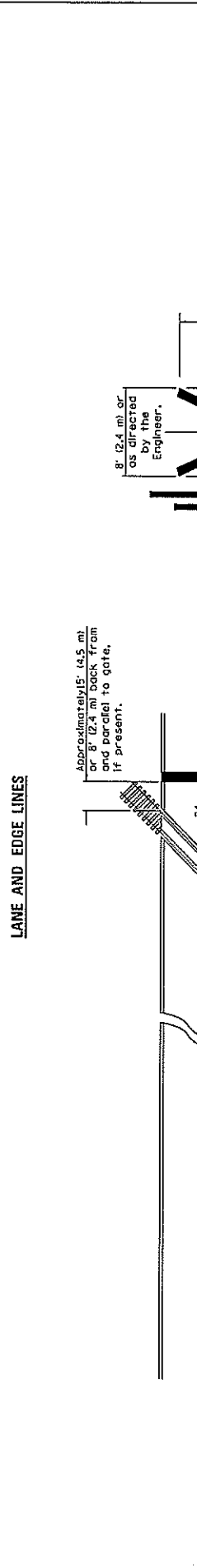

DIVIDED MULTI LANE

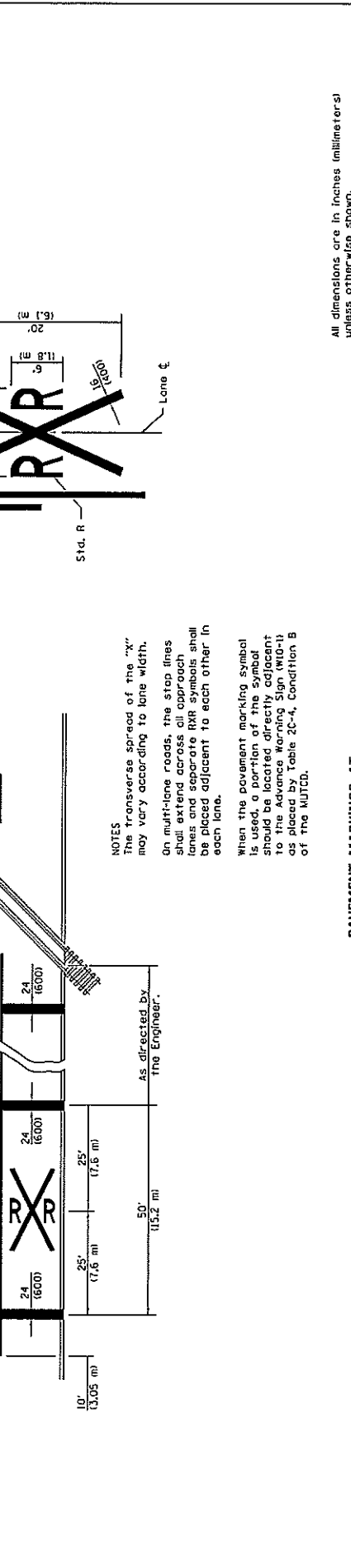

UNDIVIDED MULTI LANE

LANE AND EDGE LINES

Approximately 15' (4.5 m) or 8' (2.4 m) back from and parallel to gate, if present.

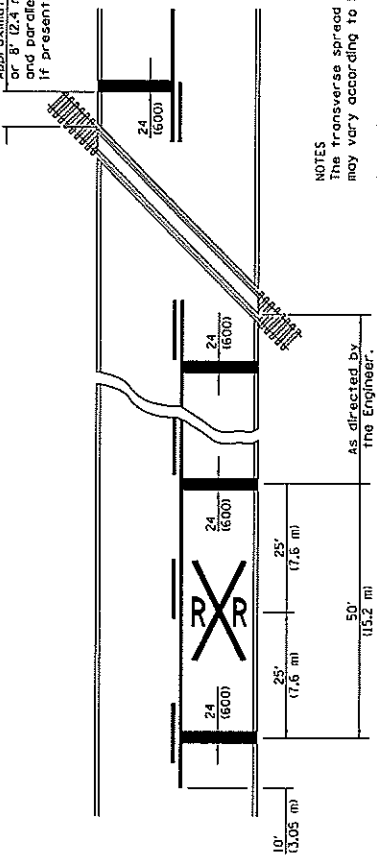

NOTES

The transverse spread of the "X" may vary according to lane width. On multi-lane roads, the stop lines shall extend across all approach lanes and separate fix symbols shall be placed adjacent to each other in each lane. When the pavement marking symbol is used, a portion of the symbol should be located directly adjacent to the Advance Warning Sign (W10-1) as placed by Table 2C-4, Condition B of the MUTCD.

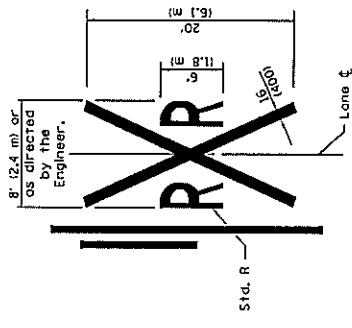

All dimensions are in inches (millimeters) unless otherwise shown.

PAVEMENT MARKINGS AT RAILROAD-HIGHWAY GRADE CROSSING

| DATE   | REVISIONS  |
|--------|--|
| 1-1-14 | Added Bike symbol. Renamed 'LANE DROP ARROW' detail to 'LANE-REDUCTION ARROW'. |
| 1-1-12 | Updated reference to current MUTCD Table in notes.                             |

|                                   |      |
|-----------------------------------|------|
| APPROVED                          | 2014 |
| ENGINEER OF OPERATIONS            | 2014 |
| ENGINEER OF DESIGN AND ESTIMATION |      |

TYPICAL PAVEMENT MARKINGS

STANDARD 780001-04 (Sheet 1 of 2)

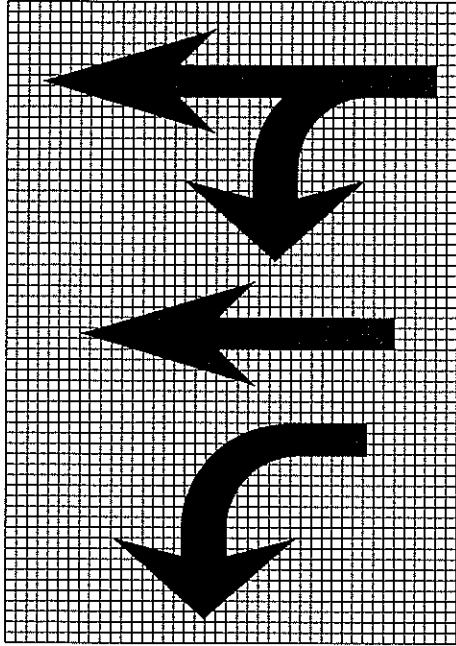
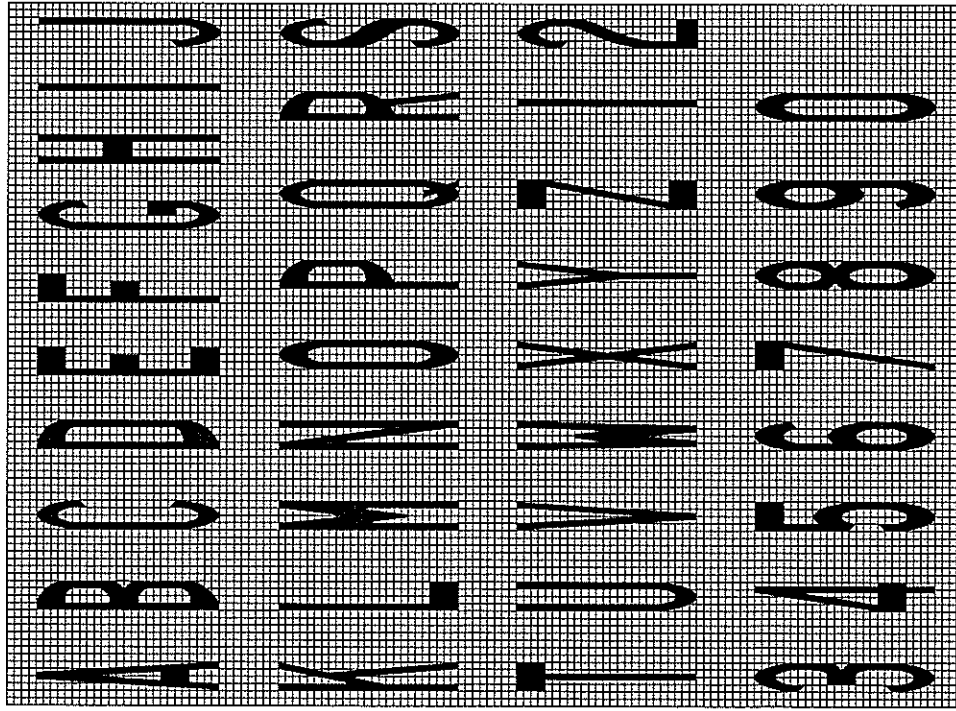

| Legend | Height     | Arrow Size | a        |
|--------|------------|------------|----------|
|        | 6' (1.8 m) | Small      | 2.9 (74) |
|        | 8' (2.4 m) | Large      | 3.8 (96) |

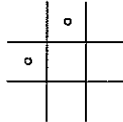

The space between adjacent letters or numerals should be approximately 3 (75) for 6' (1.8 m) legend and 4 (100) for 8' (2.4 m) legend.

**LETTER AND ARROW GRID SCALE**

**WORD AND ARROW LAYOUT**

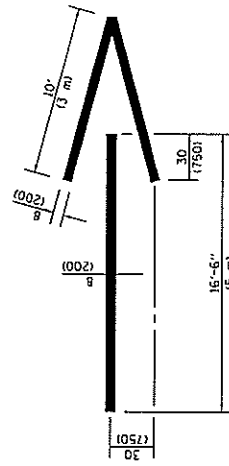

**WRONG WAY ARROW**

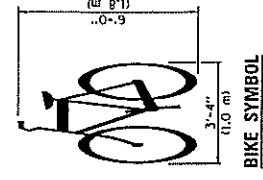

**BIKE SYMBOL**

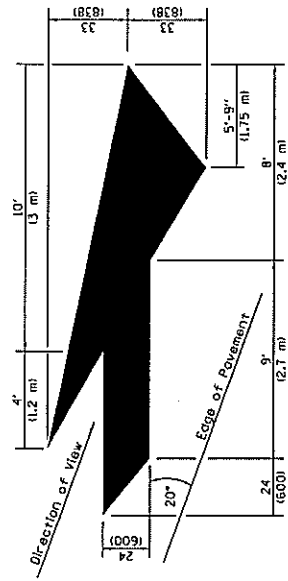

**LANE-REDUCTION ARROW**

Right lane-reduction arrow shown. Use mirror image for left lane.

**TYPICAL PAVEMENT MARKINGS**

(Sheet 2 of 2)

STANDARD 780001-04

Illinois Department of Transportation

APPROVED: [Signature] JUNE 1, 2014  
 ENGINEER IN CHARGE

APPROVED: [Signature] JUNE 1, 2014  
 ENGINEER OF RECORD

ISSUED 1-1-97

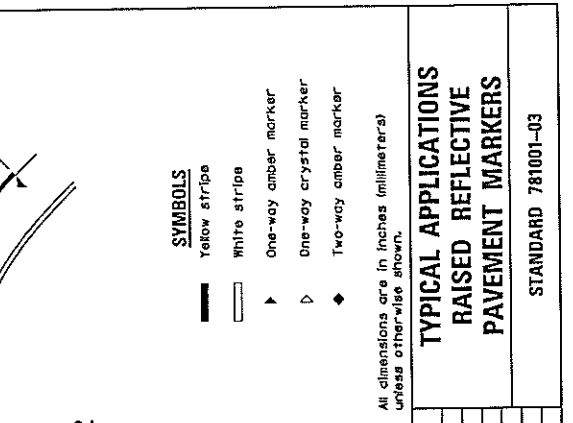
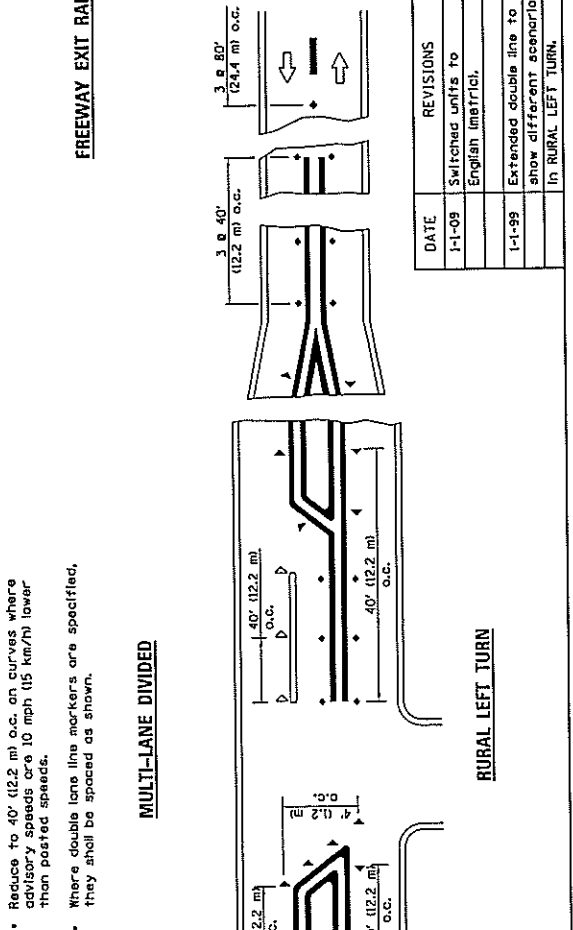
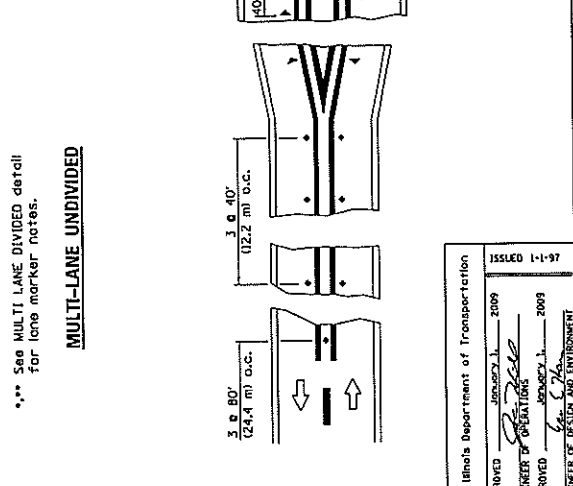
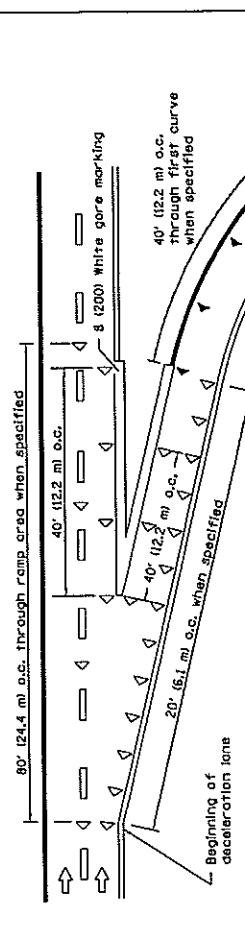
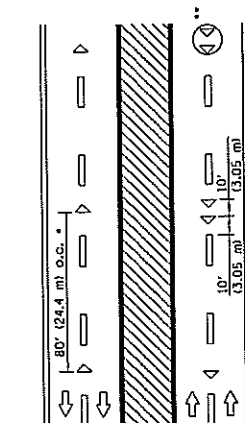
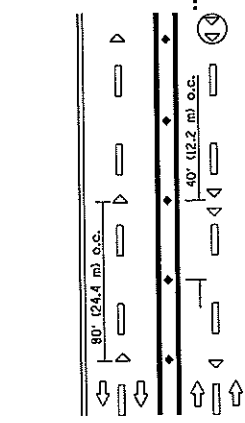
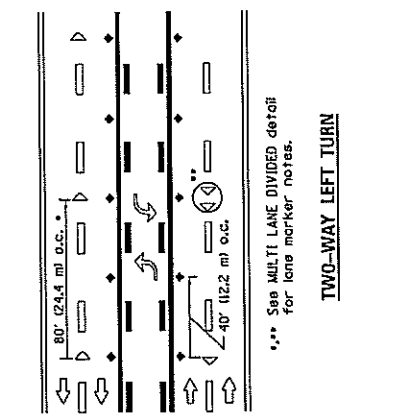
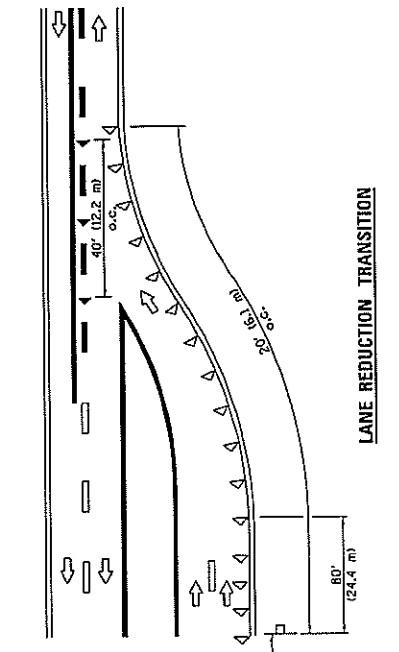
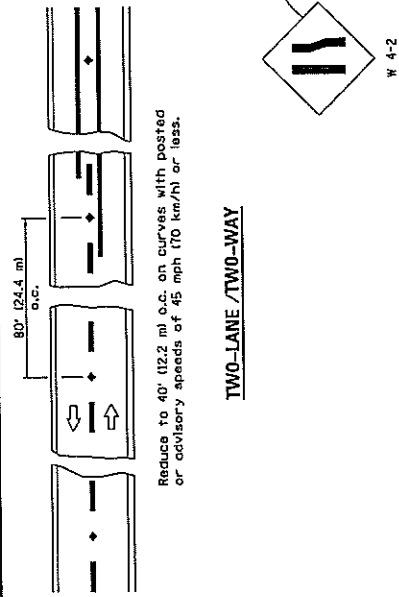

**SYMBOLS**

- Yellow stripe
- White stripe
- One-way amber marker
- One-way crystal marker
- Two-way amber marker

All dimensions are in inches (millimeter) unless otherwise shown.

**TYPICAL APPLICATIONS**

**RAISED REFLECTIVE PAVEMENT MARKERS**

| DATE   | REVISIONS   |
|--------|---|
| 1-1-09 | Switched units to English (metric).                                 |
| 1-1-99 | Extended double line to show different scenario in RURAL LEFT TURN. |

STANDARD 781001-03

Illinois Department of Transportation

APPROVED: [Signature] JUNE 1, 2009

ENGINEER: [Signature] JUNE 1, 2009

APPROVED: [Signature] JUNE 1, 2009

ENGINEER OF DESIGN AND ENVIRONMENT

ISSUED 1-1-97



## REQUIRED CONTRACT PROVISIONS FEDERAL-AID CONSTRUCTION CONTRACTS

- I. General
- II. Nondiscrimination
- III. Nonsegregated Facilities
- IV. Davis-Bacon and Related Act Provisions
- V. Contract Work Hours and Safety Standards Act Provisions
- VI. Subletting or Assigning the Contract
- VII. Safety: Accident Prevention
- VIII. False Statements Concerning Highway Projects
- IX. Implementation of Clean Air Act and Federal Water Pollution Control Act
- X. Compliance with Governmentwide Suspension and Debarment Requirements
- XI. Certification Regarding Use of Contract Funds for Lobbying

### ATTACHMENTS

A. Employment and Materials Preference for Appalachian Development Highway System or Appalachian Local Access Road Contracts (included in Appalachian contracts only)

#### I. GENERAL

1. Form FHWA-1273 must be physically incorporated in each construction contract funded under Title 23 (excluding emergency contracts solely intended for debris removal). The contractor (or subcontractor) must insert this form in each subcontract and further require its inclusion in all lower tier subcontracts (excluding purchase orders, rental agreements and other agreements for supplies or services).

The applicable requirements of Form FHWA-1273 are incorporated by reference for work done under any purchase order, rental agreement or agreement for other services. The prime contractor shall be responsible for compliance by any subcontractor, lower-tier subcontractor or service provider.

Form FHWA-1273 must be included in all Federal-aid design-build contracts, in all subcontracts and in lower tier subcontracts (excluding subcontracts for design services, purchase orders, rental agreements and other agreements for supplies or services). The design-builder shall be responsible for compliance by any subcontractor, lower-tier subcontractor or service provider.

Contracting agencies may reference Form FHWA-1273 in bid proposal or request for proposal documents, however, the Form FHWA-1273 must be physically incorporated (not referenced) in all contracts, subcontracts and lower-tier subcontracts (excluding purchase orders, rental agreements and other agreements for supplies or services related to a construction contract).

2. Subject to the applicability criteria noted in the following sections, these contract provisions shall apply to all work performed on the contract by the contractor's own organization and with the assistance of workers under the contractor's immediate superintendence and to all work performed on the contract by piecework, station work, or by subcontract.

3. A breach of any of the stipulations contained in these Required Contract Provisions may be sufficient grounds for withholding of progress payments, withholding of final payment, termination of the contract, suspension / debarment or any other action determined to be appropriate by the contracting agency and FHWA.

4. Selection of Labor: During the performance of this contract, the contractor shall not use convict labor for any purpose within the limits of a construction project on a Federal-aid highway unless it is labor performed by convicts who are on parole, supervised release, or probation. The term Federal-aid highway does not include roadways functionally classified as local roads or rural minor collectors.

#### II. NONDISCRIMINATION

The provisions of this section related to 23 CFR Part 230 are applicable to all Federal-aid construction contracts and to all related construction subcontracts of \$10,000 or more. The provisions of 23 CFR Part 230 are not applicable to material supply, engineering, or architectural service contracts.

In addition, the contractor and all subcontractors must comply with the following policies: Executive Order 11246, 41 CFR 60, 29 CFR 1625-1627, Title 23 USC Section 140, the Rehabilitation Act of 1973, as amended (29 USC 794), Title VI of the Civil Rights Act of 1964, as amended, and related regulations including 49 CFR Parts 21, 26 and 27; and 23 CFR Parts 200, 230, and 633.

The contractor and all subcontractors must comply with: the requirements of the Equal Opportunity Clause in 41 CFR 60-1.4(b) and, for all construction contracts exceeding \$10,000, the Standard Federal Equal Employment Opportunity Construction Contract Specifications in 41 CFR 60-4.3.

Note: The U.S. Department of Labor has exclusive authority to determine compliance with Executive Order 11246 and the policies of the Secretary of Labor including 41 CFR 60, and 29 CFR 1625-1627. The contracting agency and the FHWA have the authority and the responsibility to ensure compliance with Title 23 USC Section 140, the Rehabilitation Act of 1973, as amended (29 USC 794), and Title VI of the Civil Rights Act of 1964, as amended, and related regulations including 49 CFR Parts 21, 26 and 27; and 23 CFR Parts 200, 230, and 633.

The following provision is adopted from 23 CFR 230, Appendix A, with appropriate revisions to conform to the U.S. Department of Labor (US DOL) and FHWA requirements.

**1. Equal Employment Opportunity:** Equal employment opportunity (EEO) requirements not to discriminate and to take affirmative action to assure equal opportunity as set forth under laws, executive orders, rules, regulations (28 CFR 35, 29 CFR 1630, 29 CFR 1625-1627, 41 CFR 60 and 49 CFR 27) and orders of the Secretary of Labor as modified by the provisions prescribed herein, and imposed pursuant to 23 U.S.C. 140 shall constitute the EEO and specific affirmative action standards for the contractor's project activities under this contract. The provisions of the Americans with Disabilities Act of 1990 (42 U.S.C. 12101 et seq.) set forth under 28 CFR 35 and 29 CFR 1630 are incorporated by reference in this contract. In the execution of this contract, the contractor agrees to comply with the following minimum specific requirement activities of EEO:

a. The contractor will work with the contracting agency and the Federal Government to ensure that it has made every good faith effort to provide equal opportunity with respect to all of its terms and conditions of employment and in their review of activities under the contract.

b. The contractor will accept as its operating policy the following statement:

"It is the policy of this Company to assure that applicants are employed, and that employees are treated during employment, without regard to their race, religion, sex, color, national origin, age or disability. Such action shall include: employment, upgrading, demotion, or transfer; recruitment or recruitment advertising; layoff or termination; rates of pay or other forms of compensation; and selection for training, including apprenticeship, pre-apprenticeship, and/or on-the-job training."

**2. EEO Officer:** The contractor will designate and make known to the contracting officers an EEO Officer who will have the responsibility for and must be capable of effectively administering and promoting an active EEO program and who must be assigned adequate authority and responsibility to do so.

**3. Dissemination of Policy:** All members of the contractor's staff who are authorized to hire, supervise, promote, and discharge employees, or who recommend such action, or who are substantially involved in such action, will be made fully cognizant of, and will implement, the contractor's EEO policy and contractual responsibilities to provide EEO in each grade and classification of employment. To ensure that the above agreement will be met, the following actions will be taken as a minimum:

a. Periodic meetings of supervisory and personnel office employees will be conducted before the start of work and then not less often than once every six months, at which time the contractor's EEO policy and its implementation will be reviewed and explained. The meetings will be conducted by the EEO Officer.

b. All new supervisory or personnel office employees will be given a thorough indoctrination by the EEO Officer, covering all major aspects of the contractor's EEO obligations within thirty days following their reporting for duty with the contractor.

c. All personnel who are engaged in direct recruitment for the project will be instructed by the EEO Officer in the contractor's procedures for locating and hiring minorities and women.

d. Notices and posters setting forth the contractor's EEO policy will be placed in areas readily accessible to employees, applicants for employment and potential employees.

e. The contractor's EEO policy and the procedures to implement such policy will be brought to the attention of employees by means of meetings, employee handbooks, or other appropriate means.

**4. Recruitment:** When advertising for employees, the contractor will include in all advertisements for employees the notation: "An Equal Opportunity Employer." All such advertisements will be placed in publications having a large circulation among minorities and women in the area from which the project work force would normally be derived.

a. The contractor will, unless precluded by a valid bargaining agreement, conduct systematic and direct recruitment through public and private employee referral sources likely to yield qualified minorities and women. To meet this requirement, the contractor will identify sources of potential minority group employees, and establish with such identified sources procedures whereby minority and women applicants may be referred to the contractor for employment consideration.

b. In the event the contractor has a valid bargaining agreement providing for exclusive hiring hall referrals, the contractor is expected to observe the provisions of that agreement to the extent that the system meets the contractor's compliance with EEO contract provisions. Where implementation of such an agreement has the effect of discriminating against minorities or women, or obligates the contractor to do the same, such implementation violates Federal nondiscrimination provisions.

c. The contractor will encourage its present employees to refer minorities and women as applicants for employment. Information and procedures with regard to referring such applicants will be discussed with employees.

**5. Personnel Actions:** Wages, working conditions, and employee benefits shall be established and administered, and personnel actions of every type, including hiring, upgrading, promotion, transfer, demotion, layoff, and termination, shall be taken without regard to race, color, religion, sex, national origin, age or disability. The following procedures shall be followed:

a. The contractor will conduct periodic inspections of project sites to insure that working conditions and employee facilities do not indicate discriminatory treatment of project site personnel.

b. The contractor will periodically evaluate the spread of wages paid within each classification to determine any evidence of discriminatory wage practices.

c. The contractor will periodically review selected personnel actions in depth to determine whether there is evidence of discrimination. Where evidence is found, the contractor will promptly take corrective action. If

the review indicates that the discrimination may extend beyond the actions reviewed, such corrective action shall include all affected persons.

d. The contractor will promptly investigate all complaints of alleged discrimination made to the contractor in connection with its obligations under this contract, will attempt to resolve such complaints, and will take appropriate corrective action within a reasonable time. If the investigation indicates that the discrimination may affect persons other than the complainant, such corrective action shall include such other persons. Upon completion of each investigation, the contractor will inform every complainant of all of their avenues of appeal.

## **6. Training and Promotion:**

a. The contractor will assist in locating, qualifying, and increasing the skills of minorities and women who are applicants for employment or current employees. Such efforts should be aimed at developing full journey level status employees in the type of trade or job classification involved.

b. Consistent with the contractor's work force requirements and as permissible under Federal and State regulations, the contractor shall make full use of training programs, i.e., apprenticeship, and on-the-job training programs for the geographical area of contract performance. In the event a special provision for training is provided under this contract, this subparagraph will be superseded as indicated in the special provision. The contracting agency may reserve training positions for persons who receive welfare assistance in accordance with 23 U.S.C. 140(a).

c. The contractor will advise employees and applicants for employment of available training programs and entrance requirements for each.

d. The contractor will periodically review the training and promotion potential of employees who are minorities and women and will encourage eligible employees to apply for such training and promotion.

**7. Unions:** If the contractor relies in whole or in part upon unions as a source of employees, the contractor will use good faith efforts to obtain the cooperation of such unions to increase opportunities for minorities and women. Actions by the contractor, either directly or through a contractor's association acting as agent, will include the procedures set forth below:

a. The contractor will use good faith efforts to develop, in cooperation with the unions, joint training programs aimed toward qualifying more minorities and women for membership in the unions and increasing the skills of minorities and women so that they may qualify for higher paying employment.

b. The contractor will use good faith efforts to incorporate an EEO clause into each union agreement to the end that such union will be contractually bound to refer applicants without regard to their race, color, religion, sex, national origin, age or disability.

c. The contractor is to obtain information as to the referral practices and policies of the labor union except that to the extent such information is within the exclusive possession of the labor union and such labor union refuses to furnish such information to the contractor, the contractor shall so certify to the contracting agency and shall set forth what efforts have been made to obtain such information.

d. In the event the union is unable to provide the contractor with a reasonable flow of referrals within the time limit set forth in the collective bargaining agreement, the contractor will, through independent recruitment efforts, fill the employment vacancies without regard to race, color, religion, sex, national origin, age or disability; making full efforts to obtain qualified and/or qualifiable minorities and women. The failure of a union to provide sufficient referrals (even though it is obligated to provide exclusive referrals under the terms of a collective bargaining agreement) does not relieve the contractor from the requirements of this paragraph. In the event the union referral practice prevents the contractor from meeting the obligations pursuant to Executive Order 11246, as amended, and these special provisions, such contractor shall immediately notify the contracting agency.

**8. Reasonable Accommodation for Applicants / Employees with Disabilities:** The contractor must be familiar with the requirements for and comply with the Americans with Disabilities Act and all rules and regulations established there under. Employers must provide reasonable accommodation in all employment activities unless to do so would cause an undue hardship.

**9. Selection of Subcontractors, Procurement of Materials and Leasing of Equipment:** The contractor shall not discriminate on the grounds of race, color, religion, sex, national origin, age or disability in the selection and retention of subcontractors, including procurement of materials and leases of equipment. The contractor shall take all necessary and reasonable steps to ensure nondiscrimination in the administration of this contract.

a. The contractor shall notify all potential subcontractors and suppliers and lessors of their EEO obligations under this contract.

b. The contractor will use good faith efforts to ensure subcontractor compliance with their EEO obligations.

#### **10. Assurance Required by 49 CFR 26.13(b):**

a. The requirements of 49 CFR Part 26 and the State DOT's U.S. DOT-approved DBE program are incorporated by reference.

b. The contractor or subcontractor shall not discriminate on the basis of race, color, national origin, or sex in the performance of this contract. The contractor shall carry out applicable requirements of 49 CFR Part 26 in the award and administration of DOT-assisted contracts. Failure by the contractor to carry out these requirements is a material breach of this contract, which may result in the termination of this contract or such other remedy as the contracting agency deems appropriate.

**11. Records and Reports:** The contractor shall keep such records as necessary to document compliance with the EEO requirements. Such records shall be retained for a period of three years following the date of the final payment to the contractor for all contract work and shall be available at reasonable times and places for inspection by authorized representatives of the contracting agency and the FHWA.

a. The records kept by the contractor shall document the following:

(1) The number and work hours of minority and non-minority group members and women employed in each work classification on the project;

(2) The progress and efforts being made in cooperation with unions, when applicable, to increase employment opportunities for minorities and women; and

(3) The progress and efforts being made in locating, hiring, training, qualifying, and upgrading minorities and women;

b. The contractors and subcontractors will submit an annual report to the contracting agency each July for the duration of the project, indicating the number of minority, women, and non-minority group employees currently engaged in each work classification required by the contract work. This information is to be reported on [Form FHWA-1391](#). The staffing data should represent the project work force on board in all or any part of the last payroll period preceding the end of July. If on-the-job training is being required by special provision, the contractor will be required to collect and report training data. The employment data should reflect the work force on board during all or any part of the last payroll period preceding the end of July.

#### **III. NONSEGREGATED FACILITIES**

This provision is applicable to all Federal-aid construction contracts and to all related construction subcontracts of \$10,000 or more.

The contractor must ensure that facilities provided for employees are provided in such a manner that segregation on the basis of race, color,

religion, sex, or national origin cannot result. The contractor may neither require such segregated use by written or oral policies nor tolerate such use by employee custom. The contractor's obligation extends further to ensure that its employees are not assigned to perform their services at any location, under the contractor's control, where the facilities are segregated. The term "facilities" includes waiting rooms, work areas, restaurants and other eating areas, time clocks, restrooms, washrooms, locker rooms, and other storage or dressing areas, parking lots, drinking fountains, recreation or entertainment areas, transportation, and housing provided for employees. The contractor shall provide separate or single-user restrooms and necessary dressing or sleeping areas to assure privacy between sexes.

#### **IV. Davis-Bacon and Related Act Provisions**

This section is applicable to all Federal-aid construction projects exceeding \$2,000 and to all related subcontracts and lower-tier subcontracts (regardless of subcontract size). The requirements apply to all projects located within the right-of-way of a roadway that is functionally classified as Federal-aid highway. This excludes roadways functionally classified as local roads or rural minor collectors, which are exempt. Contracting agencies may elect to apply these requirements to other projects.

The following provisions are from the U.S. Department of Labor regulations in 29 CFR 5.5 "Contract provisions and related matters" with minor revisions to conform to the FHWA-1273 format and FHWA program requirements.

##### **1. Minimum wages**

a. All laborers and mechanics employed or working upon the site of the work, will be paid unconditionally and not less often than once a week, and without subsequent deduction or rebate on any account (except such payroll deductions as are permitted by regulations issued by the Secretary of Labor under the Copeland Act (29 CFR part 3)), the full amount of wages and bona fide fringe benefits (or cash equivalents thereof) due at time of payment computed at rates not less than those contained in the wage determination of the Secretary of Labor which is attached hereto and made a part hereof, regardless of any contractual relationship which may be alleged to exist between the contractor and such laborers and mechanics.

Contributions made or costs reasonably anticipated for bona fide fringe benefits under section 1(b)(2) of the Davis-Bacon Act on behalf of laborers or mechanics are considered wages paid to such laborers or mechanics, subject to the provisions of paragraph 1.d. of this section; also, regular contributions made or costs incurred for more than a weekly period (but not less often than quarterly) under plans, funds, or programs which cover the particular weekly period, are deemed to be constructively made or incurred during such weekly period. Such laborers and mechanics shall be paid the appropriate wage rate and fringe benefits on the wage determination for the classification of work actually performed, without regard to skill, except as provided in 29 CFR 5.5(a)(4). Laborers or mechanics performing work in more than one classification may be compensated at the rate specified for each classification for the time actually worked therein: Provided, That the employer's payroll records accurately set forth the time spent in each classification in which work is performed. The wage determination (including any additional classification and wage rates conformed under paragraph 1.b. of this section) and the Davis-Bacon poster (WH-1321) shall be posted at all times by the contractor and its subcontractors at the site of the work in a prominent and accessible place where it can be easily seen by the workers.

b.(1) The contracting officer shall require that any class of laborers or mechanics, including helpers, which is not listed in the wage determination and which is to be employed under the contract shall be classified in conformance with the wage determination. The contracting officer shall approve an additional classification and wage rate and fringe benefits therefore only when the following criteria have been met:

(i) The work to be performed by the classification requested is not performed by a classification in the wage determination; and

(ii) The classification is utilized in the area by the construction industry; and

(iii) The proposed wage rate, including any bona fide fringe benefits, bears a reasonable relationship to the wage rates contained in the wage determination.

(2) If the contractor and the laborers and mechanics to be employed in the classification (if known), or their representatives, and the contracting officer agree on the classification and wage rate (including the amount designated for fringe benefits where appropriate), a report of the action taken shall be sent by the contracting officer to the Administrator of the Wage and Hour Division, Employment Standards Administration, U.S. Department of Labor, Washington, DC 20210. The Administrator, or an authorized representative, will approve, modify, or disapprove every additional classification action within 30 days of receipt and so advise the contracting officer or will notify the contracting officer within the 30-day period that additional time is necessary.

(3) In the event the contractor, the laborers or mechanics to be employed in the classification or their representatives, and the contracting officer do not agree on the proposed classification and wage rate (including the amount designated for fringe benefits, where appropriate), the contracting officer shall refer the questions, including the views of all interested parties and the recommendation of the contracting officer, to the Wage and Hour Administrator for determination. The Wage and Hour Administrator, or an authorized representative, will issue a determination within 30 days of receipt and so advise the contracting officer or will notify the contracting officer within the 30-day period that additional time is necessary.

(4) The wage rate (including fringe benefits where appropriate) determined pursuant to paragraphs 1.b.(2) or 1.b.(3) of this section, shall be paid to all workers performing work in the classification under this contract from the first day on which work is performed in the classification.

c. Whenever the minimum wage rate prescribed in the contract for a class of laborers or mechanics includes a fringe benefit which is not expressed as an hourly rate, the contractor shall either pay the benefit as stated in the wage determination or shall pay another bona fide fringe benefit or an hourly cash equivalent thereof.

d. If the contractor does not make payments to a trustee or other third person, the contractor may consider as part of the wages of any laborer or mechanic the amount of any costs reasonably anticipated in providing bona fide fringe benefits under a plan or program, Provided, That the Secretary of Labor has found, upon the written request of the contractor, that the applicable standards of the Davis-Bacon Act have been met. The Secretary of Labor may require the contractor to set aside in a separate account assets for the meeting of obligations under the plan or program.

## 2. Withholding

The contracting agency shall upon its own action or upon written request of an authorized representative of the Department of Labor, withhold or cause to be withheld from the contractor under this contract, or any other Federal contract with the same prime contractor, or any other federally-assisted contract subject to Davis-Bacon prevailing wage requirements, which is held by the same prime contractor, so much of the accrued payments or advances as may be considered necessary to pay laborers and mechanics, including apprentices, trainees, and helpers, employed by the contractor or any subcontractor the full amount of wages required by the contract. In the event of failure to pay any laborer or mechanic, including any apprentice, trainee, or helper, employed or working on the site of the work, all or part of the wages required by the contract, the contracting agency may, after written notice to the contractor, take such

action as may be necessary to cause the suspension of any further payment, advance, or guarantee of funds until such violations have ceased.

## 3. Payrolls and basic records

a. Payrolls and basic records relating thereto shall be maintained by the contractor during the course of the work and preserved for a period of three years thereafter for all laborers and mechanics working at the site of the work. Such records shall contain the name, address, and social security number of each such worker, his or her correct classification, hourly rates of wages paid (including rates of contributions or costs anticipated for bona fide fringe benefits or cash equivalents thereof of the types described in section 1(b)(2)(B) of the Davis-Bacon Act), daily and weekly number of hours worked, deductions made and actual wages paid. Whenever the Secretary of Labor has found under 29 CFR 5.5(a)(1)(iv) that the wages of any laborer or mechanic include the amount of any costs reasonably anticipated in providing benefits under a plan or program described in section 1(b)(2)(B) of the Davis-Bacon Act, the contractor shall maintain records which show that the commitment to provide such benefits is enforceable, that the plan or program is financially responsible, and that the plan or program has been communicated in writing to the laborers or mechanics affected, and records which show the costs anticipated or the actual cost incurred in providing such benefits. Contractors employing apprentices or trainees under approved programs shall maintain written evidence of the registration of apprenticeship programs and certification of trainee programs, the registration of the apprentices and trainees, and the ratios and wage rates prescribed in the applicable programs.

b. (1) The contractor shall submit weekly for each week in which any contract work is performed a copy of all payrolls to the contracting agency. The payrolls submitted shall set out accurately and completely all of the information required to be maintained under 29 CFR 5.5(a)(3)(i), except that full social security numbers and home addresses shall not be included on weekly transmittals. Instead the payrolls shall only need to include an individually identifying number for each employee ( e.g. , the last four digits of the employee's social security number). The required weekly payroll information may be submitted in any form desired. Optional Form WH-347 is available for this purpose from the Wage and Hour Division Web site at <http://www.dol.gov/esa/whd/forms/wh347instr.htm> or its successor site. The prime contractor is responsible for the submission of copies of payrolls by all subcontractors. Contractors and subcontractors shall maintain the full social security number and current address of each covered worker, and shall provide them upon request to the contracting agency for transmission to the State DOT, the FHWA or the Wage and Hour Division of the Department of Labor for purposes of an investigation or audit of compliance with prevailing wage requirements. It is not a violation of this section for a prime contractor to require a subcontractor to provide addresses and social security numbers to the prime contractor for its own records, without weekly submission to the contracting agency..

(2) Each payroll submitted shall be accompanied by a "Statement of Compliance," signed by the contractor or subcontractor or his or her agent who pays or supervises the payment of the persons employed under the contract and shall certify the following:

(i) That the payroll for the payroll period contains the information required to be provided under §5.5 (a)(3)(ii) of Regulations, 29 CFR part 5, the appropriate information is being maintained under §5.5 (a)(3)(i) of Regulations, 29 CFR part 5, and that such information is correct and complete;

(ii) That each laborer or mechanic (including each helper, apprentice, and trainee) employed on the contract during the payroll period has been paid the full weekly wages earned, without rebate, either directly or indirectly, and that no deductions have been made either directly or indirectly from the full wages earned, other than permissible deductions as set forth in Regulations, 29 CFR part 3;

(iii) That each laborer or mechanic has been paid not less than the applicable wage rates and fringe benefits or cash equivalents for the classification of work performed, as specified in the applicable wage determination incorporated into the contract.

(3) The weekly submission of a properly executed certification set forth on the reverse side of Optional Form WH-347 shall satisfy the requirement for submission of the "Statement of Compliance" required by paragraph 3.b.(2) of this section.

(4) The falsification of any of the above certifications may subject the contractor or subcontractor to civil or criminal prosecution under section 1001 of title 18 and section 231 of title 31 of the United States Code.

c. The contractor or subcontractor shall make the records required under paragraph 3.a. of this section available for inspection, copying, or transcription by authorized representatives of the contracting agency, the State DOT, the FHWA, or the Department of Labor, and shall permit such representatives to interview employees during working hours on the job. If the contractor or subcontractor fails to submit the required records or to make them available, the FHWA may, after written notice to the contractor, the contracting agency or the State DOT, take such action as may be necessary to cause the suspension of any further payment, advance, or guarantee of funds. Furthermore, failure to submit the required records upon request or to make such records available may be grounds for debarment action pursuant to 29 CFR 5.12.

#### 4. Apprentices and trainees

##### a. Apprentices (programs of the USDOL).

Apprentices will be permitted to work at less than the predetermined rate for the work they performed when they are employed pursuant to and individually registered in a bona fide apprenticeship program registered with the U.S. Department of Labor, Employment and Training Administration, Office of Apprenticeship Training, Employer and Labor Services, or with a State Apprenticeship Agency recognized by the Office, or if a person is employed in his or her first 90 days of probationary employment as an apprentice in such an apprenticeship program, who is not individually registered in the program, but who has been certified by the Office of Apprenticeship Training, Employer and Labor Services or a State Apprenticeship Agency (where appropriate) to be eligible for probationary employment as an apprentice.

The allowable ratio of apprentices to journeymen on the job site in any craft classification shall not be greater than the ratio permitted to the contractor as to the entire work force under the registered program. Any worker listed on a payroll at an apprentice wage rate, who is not registered or otherwise employed as stated above, shall be paid not less than the applicable wage rate on the wage determination for the classification of work actually performed. In addition, any apprentice performing work on the job site in excess of the ratio permitted under the registered program shall be paid not less than the applicable wage rate on the wage determination for the work actually performed. Where a contractor is performing construction on a project in a locality other than that in which its program is registered, the ratios and wage rates (expressed in percentages of the journeyman's hourly rate) specified in the contractor's or subcontractor's registered program shall be observed.

Every apprentice must be paid at not less than the rate specified in the registered program for the apprentice's level of progress, expressed as a percentage of the journeymen hourly rate specified in the applicable wage determination. Apprentices shall be paid fringe benefits in accordance with the provisions of the apprenticeship program. If the apprenticeship program does not specify fringe benefits, apprentices must be paid the full amount of fringe benefits listed on the wage determination for the applicable classification. If the Administrator determines that a different practice prevails for the applicable apprentice classification, fringes shall be paid in accordance with that determination.

In the event the Office of Apprenticeship Training, Employer and Labor Services, or a State Apprenticeship Agency recognized by the Office, withdraws approval of an apprenticeship program, the contractor will no longer be permitted to utilize apprentices at less than the applicable predetermined rate for the work performed until an acceptable program is approved.

##### b. Trainees (programs of the USDOL).

Except as provided in 29 CFR 5.16, trainees will not be permitted to work at less than the predetermined rate for the work performed unless they are employed pursuant to and individually registered in a program which has received prior approval, evidenced by formal certification by the U.S. Department of Labor, Employment and Training Administration.

The ratio of trainees to journeymen on the job site shall not be greater than permitted under the plan approved by the Employment and Training Administration.

Every trainee must be paid at not less than the rate specified in the approved program for the trainee's level of progress, expressed as a percentage of the journeyman hourly rate specified in the applicable wage determination. Trainees shall be paid fringe benefits in accordance with the provisions of the trainee program. If the trainee program does not mention fringe benefits, trainees shall be paid the full amount of fringe benefits listed on the wage determination unless the Administrator of the Wage and Hour Division determines that there is an apprenticeship program associated with the corresponding journeyman wage rate on the wage determination which provides for less than full fringe benefits for apprentices. Any employee listed on the payroll at a trainee rate who is not registered and participating in a training plan approved by the Employment and Training Administration shall be paid not less than the applicable wage rate on the wage determination for the classification of work actually performed. In addition, any trainee performing work on the job site in excess of the ratio permitted under the registered program shall be paid not less than the applicable wage rate on the wage determination for the work actually performed.

In the event the Employment and Training Administration withdraws approval of a training program, the contractor will no longer be permitted to utilize trainees at less than the applicable predetermined rate for the work performed until an acceptable program is approved.

c. Equal employment opportunity. The utilization of apprentices, trainees and journeymen under this part shall be in conformity with the equal employment opportunity requirements of Executive Order 11246, as amended, and 29 CFR part 30.

##### d. Apprentices and Trainees (programs of the U.S. DOT).

Apprentices and trainees working under apprenticeship and skill training programs which have been certified by the Secretary of Transportation as promoting EEO in connection with Federal-aid highway construction programs are not subject to the requirements of paragraph 4 of this Section IV. The straight time hourly wage rates for apprentices and trainees under such programs will be established by the particular programs. The ratio of apprentices and trainees to journeymen shall not be greater than permitted by the terms of the particular program.

**5. Compliance with Copeland Act requirements.** The contractor shall comply with the requirements of 29 CFR part 3, which are incorporated by reference in this contract.

**6. Subcontracts.** The contractor or subcontractor shall insert Form FHWA-1273 in any subcontracts and also require the subcontractors to include Form FHWA-1273 in any lower tier subcontracts. The prime contractor shall be responsible for the compliance by any subcontractor or lower tier subcontractor with all the contract clauses in 29 CFR 5.5.

**7. Contract termination: debarment.** A breach of the contract clauses in 29 CFR 5.5 may be grounds for termination of the contract, and for

debarment as a contractor and a subcontractor as provided in 29 CFR 5.12.

**8. Compliance with Davis-Bacon and Related Act requirements.** All rulings and interpretations of the Davis-Bacon and Related Acts contained in 29 CFR parts 1, 3, and 5 are herein incorporated by reference in this contract.

**9. Disputes concerning labor standards.** Disputes arising out of the labor standards provisions of this contract shall not be subject to the general disputes clause of this contract. Such disputes shall be resolved in accordance with the procedures of the Department of Labor set forth in 29 CFR parts 5, 6, and 7. Disputes within the meaning of this clause include disputes between the contractor (or any of its subcontractors) and the contracting agency, the U.S. Department of Labor, or the employees or their representatives.

#### **10. Certification of eligibility.**

a. By entering into this contract, the contractor certifies that neither it (nor he or she) nor any person or firm who has an interest in the contractor's firm is a person or firm ineligible to be awarded Government contracts by virtue of section 3(a) of the Davis-Bacon Act or 29 CFR 5.12(a)(1).

b. No part of this contract shall be subcontracted to any person or firm ineligible for award of a Government contract by virtue of section 3(a) of the Davis-Bacon Act or 29 CFR 5.12(a)(1).

c. The penalty for making false statements is prescribed in the U.S. Criminal Code, 18 U.S.C. 1001.

#### **V. CONTRACT WORK HOURS AND SAFETY STANDARDS ACT**

The following clauses apply to any Federal-aid construction contract in an amount in excess of \$100,000 and subject to the overtime provisions of the Contract Work Hours and Safety Standards Act. These clauses shall be inserted in addition to the clauses required by 29 CFR 5.5(a) or 29 CFR 4.6. As used in this paragraph, the terms laborers and mechanics include watchmen and guards.

**1. Overtime requirements.** No contractor or subcontractor contracting for any part of the contract work which may require or involve the employment of laborers or mechanics shall require or permit any such laborer or mechanic in any workweek in which he or she is employed on such work to work in excess of forty hours in such workweek unless such laborer or mechanic receives compensation at a rate not less than one and one-half times the basic rate of pay for all hours worked in excess of forty hours in such workweek.

**2. Violation; liability for unpaid wages; liquidated damages.** In the event of any violation of the clause set forth in paragraph (1.) of this section, the contractor and any subcontractor responsible therefor shall be liable for the unpaid wages. In addition, such contractor and subcontractor shall be liable to the United States (in the case of work done under contract for the District of Columbia or a territory, to such District or to such territory), for liquidated damages. Such liquidated damages shall be computed with respect to each individual laborer or mechanic, including watchmen and guards, employed in violation of the clause set forth in paragraph (1.) of this section, in the sum of \$10 for each calendar day on which such individual was required or permitted to work in excess of the standard workweek of forty hours without payment of the overtime wages required by the clause set forth in paragraph (1.) of this section.

**3. Withholding for unpaid wages and liquidated damages.** The FHWA or the contacting agency shall upon its own action or upon written request of an authorized representative of the Department of Labor withhold or cause to be withheld, from any moneys payable on account of work performed by the contractor or subcontractor under any such

contract or any other Federal contract with the same prime contractor, or any other federally-assisted contract subject to the Contract Work Hours and Safety Standards Act, which is held by the same prime contractor, such sums as may be determined to be necessary to satisfy any liabilities of such contractor or subcontractor for unpaid wages and liquidated damages as provided in the clause set forth in paragraph (2.) of this section.

**4. Subcontracts.** The contractor or subcontractor shall insert in any subcontracts the clauses set forth in paragraph (1.) through (4.) of this section and also a clause requiring the subcontractors to include these clauses in any lower tier subcontracts. The prime contractor shall be responsible for compliance by any subcontractor or lower tier subcontractor with the clauses set forth in paragraphs (1.) through (4.) of this section.

#### **VI. SUBLETTING OR ASSIGNING THE CONTRACT**

This provision is applicable to all Federal-aid construction contracts on the National Highway System.

1. The contractor shall perform with its own organization contract work amounting to not less than 30 percent (or a greater percentage if specified elsewhere in the contract) of the total original contract price, excluding any specialty items designated by the contracting agency. Specialty items may be performed by subcontract and the amount of any such specialty items performed may be deducted from the total original contract price before computing the amount of work required to be performed by the contractor's own organization (23 CFR 635.116).

a. The term "perform work with its own organization" refers to workers employed or leased by the prime contractor, and equipment owned or rented by the prime contractor, with or without operators. Such term does not include employees or equipment of a subcontractor or lower tier subcontractor, agents of the prime contractor, or any other assignees. The term may include payments for the costs of hiring leased employees from an employee leasing firm meeting all relevant Federal and State regulatory requirements. Leased employees may only be included in this term if the prime contractor meets all of the following conditions:

(1) the prime contractor maintains control over the supervision of the day-to-day activities of the leased employees;

(2) the prime contractor remains responsible for the quality of the work of the leased employees;

(3) the prime contractor retains all power to accept or exclude individual employees from work on the project; and

(4) the prime contractor remains ultimately responsible for the payment of predetermined minimum wages, the submission of payrolls, statements of compliance and all other Federal regulatory requirements.

b. "Specialty Items" shall be construed to be limited to work that requires highly specialized knowledge, abilities, or equipment not ordinarily available in the type of contracting organizations qualified and expected to bid or propose on the contract as a whole and in general are to be limited to minor components of the overall contract.

2. The contract amount upon which the requirements set forth in paragraph (1) of Section VI is computed includes the cost of material and manufactured products which are to be purchased or produced by the contractor under the contract provisions.

3. The contractor shall furnish (a) a competent superintendent or supervisor who is employed by the firm, has full authority to direct performance of the work in accordance with the contract requirements, and is in charge of all construction operations (regardless of who performs the work) and (b) such other of its own organizational resources (supervision, management, and engineering services) as the contracting officer determines is necessary to assure the performance of the contract.

4. No portion of the contract shall be sublet, assigned or otherwise disposed of except with the written consent of the contracting officer, or authorized representative, and such consent when given shall not be construed to relieve the contractor of any responsibility for the fulfillment of the contract. Written consent will be given only after the contracting agency has assured that each subcontract is evidenced in writing and that it contains all pertinent provisions and requirements of the prime contract.

5. The 30% self-performance requirement of paragraph (1) is not applicable to design-build contracts; however, contracting agencies may establish their own self-performance requirements.

## **VII. SAFETY: ACCIDENT PREVENTION**

This provision is applicable to all Federal-aid construction contracts and to all related subcontracts.

1. In the performance of this contract the contractor shall comply with all applicable Federal, State, and local laws governing safety, health, and sanitation (23 CFR 635). The contractor shall provide all safeguards, safety devices and protective equipment and take any other needed actions as it determines, or as the contracting officer may determine, to be reasonably necessary to protect the life and health of employees on the job and the safety of the public and to protect property in connection with the performance of the work covered by the contract.

2. It is a condition of this contract, and shall be made a condition of each subcontract, which the contractor enters into pursuant to this contract, that the contractor and any subcontractor shall not permit any employee, in performance of the contract, to work in surroundings or under conditions which are unsanitary, hazardous or dangerous to his/her health or safety, as determined under construction safety and health standards (29 CFR 1926) promulgated by the Secretary of Labor, in accordance with Section 107 of the Contract Work Hours and Safety Standards Act (40 U.S.C. 3704).

3. Pursuant to 29 CFR 1926.3, it is a condition of this contract that the Secretary of Labor or authorized representative thereof, shall have right of entry to any site of contract performance to inspect or investigate the matter of compliance with the construction safety and health standards and to carry out the duties of the Secretary under Section 107 of the Contract Work Hours and Safety Standards Act (40 U.S.C.3704).

## **VIII. FALSE STATEMENTS CONCERNING HIGHWAY PROJECTS**

This provision is applicable to all Federal-aid construction contracts and to all related subcontracts.

In order to assure high quality and durable construction in conformity with approved plans and specifications and a high degree of reliability on statements and representations made by engineers, contractors, suppliers, and workers on Federal-aid highway projects, it is essential that all persons concerned with the project perform their functions as carefully, thoroughly, and honestly as possible. Willful falsification, distortion, or misrepresentation with respect to any facts related to the project is a violation of Federal law. To prevent any misunderstanding regarding the seriousness of these and similar acts, Form FHWA-1022 shall be posted on each Federal-aid highway project (23 CFR 635) in one or more places where it is readily available to all persons concerned with the project:

18 U.S.C. 1020 reads as follows:

"Whoever, being an officer, agent, or employee of the United States, or of any State or Territory, or whoever, whether a person, association, firm, or corporation, knowingly makes any false statement, false representation, or false report as to the character, quality, quantity, or cost of the material used or to be used, or the quantity or quality of the work performed or to be performed, or the cost thereof in connection with the submission of plans, maps, specifications, contracts, or costs of construction on any highway or related project submitted for approval to the Secretary of Transportation; or

Whoever knowingly makes any false statement, false representation, false report or false claim with respect to the character, quality, quantity, or cost of any work performed or to be performed, or materials furnished or to be furnished, in connection with the construction of any highway or related project approved by the Secretary of Transportation; or

Whoever knowingly makes any false statement or false representation as to material fact in any statement, certificate, or report submitted pursuant to provisions of the Federal-aid Roads Act approved July 1, 1916, (39 Stat. 355), as amended and supplemented;

Shall be fined under this title or imprisoned not more than 5 years or both."

## **IX. IMPLEMENTATION OF CLEAN AIR ACT AND FEDERAL WATER POLLUTION CONTROL ACT**

This provision is applicable to all Federal-aid construction contracts and to all related subcontracts.

By submission of this bid/proposal or the execution of this contract, or subcontract, as appropriate, the bidder, proposer, Federal-aid construction contractor, or subcontractor, as appropriate, will be deemed to have stipulated as follows:

1. That any person who is or will be utilized in the performance of this contract is not prohibited from receiving an award due to a violation of Section 508 of the Clean Water Act or Section 306 of the Clean Air Act.

2. That the contractor agrees to include or cause to be included the requirements of paragraph (1) of this Section X in every subcontract, and further agrees to take such action as the contracting agency may direct as a means of enforcing such requirements.

## **X. CERTIFICATION REGARDING DEBARMENT, SUSPENSION, INELIGIBILITY AND VOLUNTARY EXCLUSION**

This provision is applicable to all Federal-aid construction contracts, design-build contracts, subcontracts, lower-tier subcontracts, purchase orders, lease agreements, consultant contracts or any other covered transaction requiring FHWA approval or that is estimated to cost \$25,000 or more – as defined in 2 CFR Parts 180 and 1200.

### **1. Instructions for Certification – First Tier Participants:**

a. By signing and submitting this proposal, the prospective first tier participant is providing the certification set out below.

b. The inability of a person to provide the certification set out below will not necessarily result in denial of participation in this covered transaction. The prospective first tier participant shall submit an explanation of why it cannot provide the certification set out below. The certification or explanation will be considered in connection with the department or agency's determination whether to enter into this transaction. However, failure of the prospective first tier participant to furnish a certification or an explanation shall disqualify such a person from participation in this transaction.

c. The certification in this clause is a material representation of fact upon which reliance was placed when the contracting agency determined to enter into this transaction. If it is later determined that the prospective participant knowingly rendered an erroneous certification, in addition to other remedies available to the Federal Government, the contracting agency may terminate this transaction for cause of default.

d. The prospective first tier participant shall provide immediate written notice to the contracting agency to whom this proposal is submitted if any time the prospective first tier participant learns that its certification was erroneous when submitted or has become erroneous by reason of changed circumstances.

e. The terms "covered transaction," "debarred," "suspended," "ineligible," "participant," "person," "principal," and "voluntarily excluded,"

as used in this clause, are defined in 2 CFR Parts 180 and 1200. "First Tier Covered Transactions" refers to any covered transaction between a grantee or subgrantee of Federal funds and a participant (such as the prime or general contract). "Lower Tier Covered Transactions" refers to any covered transaction under a First Tier Covered Transaction (such as subcontracts). "First Tier Participant" refers to the participant who has entered into a covered transaction with a grantee or subgrantee of Federal funds (such as the prime or general contractor). "Lower Tier Participant" refers any participant who has entered into a covered transaction with a First Tier Participant or other Lower Tier Participants (such as subcontractors and suppliers).

f. The prospective first tier participant agrees by submitting this proposal that, should the proposed covered transaction be entered into, it shall not knowingly enter into any lower tier covered transaction with a person who is debarred, suspended, declared ineligible, or voluntarily excluded from participation in this covered transaction, unless authorized by the department or agency entering into this transaction.

g. The prospective first tier participant further agrees by submitting this proposal that it will include the clause titled "Certification Regarding Debarment, Suspension, Ineligibility and Voluntary Exclusion-Lower Tier Covered Transactions," provided by the department or contracting agency, entering into this covered transaction, without modification, in all lower tier covered transactions and in all solicitations for lower tier covered transactions exceeding the \$25,000 threshold.

h. A participant in a covered transaction may rely upon a certification of a prospective participant in a lower tier covered transaction that is not debarred, suspended, ineligible, or voluntarily excluded from the covered transaction, unless it knows that the certification is erroneous. A participant is responsible for ensuring that its principals are not suspended, debarred, or otherwise ineligible to participate in covered transactions. To verify the eligibility of its principals, as well as the eligibility of any lower tier prospective participants, each participant may, but is not required to, check the Excluded Parties List System website (<https://www.epls.gov/>), which is compiled by the General Services Administration.

i. Nothing contained in the foregoing shall be construed to require the establishment of a system of records in order to render in good faith the certification required by this clause. The knowledge and information of the prospective participant is not required to exceed that which is normally possessed by a prudent person in the ordinary course of business dealings.

j. Except for transactions authorized under paragraph (f) of these instructions, if a participant in a covered transaction knowingly enters into a lower tier covered transaction with a person who is suspended, debarred, ineligible, or voluntarily excluded from participation in this transaction, in addition to other remedies available to the Federal Government, the department or agency may terminate this transaction for cause or default.

\* \* \* \* \*

## **2. Certification Regarding Debarment, Suspension, Ineligibility and Voluntary Exclusion – First Tier Participants:**

a. The prospective first tier participant certifies to the best of its knowledge and belief, that it and its principals:

(1) Are not presently debarred, suspended, proposed for debarment, declared ineligible, or voluntarily excluded from participating in covered transactions by any Federal department or agency;

(2) Have not within a three-year period preceding this proposal been convicted of or had a civil judgment rendered against them for commission of fraud or a criminal offense in connection with obtaining, attempting to obtain, or performing a public (Federal, State or local) transaction or contract under a public transaction; violation of Federal or State antitrust statutes or commission of embezzlement, theft, forgery, bribery, falsification or destruction of records, making false statements, or receiving stolen property;

(3) Are not presently indicted for or otherwise criminally or civilly charged by a governmental entity (Federal, State or local) with

commission of any of the offenses enumerated in paragraph (a)(2) of this certification; and

(4) Have not within a three-year period preceding this application/proposal had one or more public transactions (Federal, State or local) terminated for cause or default.

b. Where the prospective participant is unable to certify to any of the statements in this certification, such prospective participant shall attach an explanation to this proposal.

### **2. Instructions for Certification - Lower Tier Participants:**

(Applicable to all subcontracts, purchase orders and other lower tier transactions requiring prior FHWA approval or estimated to cost \$25,000 or more - 2 CFR Parts 180 and 1200)

a. By signing and submitting this proposal, the prospective lower tier is providing the certification set out below.

b. The certification in this clause is a material representation of fact upon which reliance was placed when this transaction was entered into. If it is later determined that the prospective lower tier participant knowingly rendered an erroneous certification, in addition to other remedies available to the Federal Government, the department, or agency with which this transaction originated may pursue available remedies, including suspension and/or debarment.

c. The prospective lower tier participant shall provide immediate written notice to the person to which this proposal is submitted if at any time the prospective lower tier participant learns that its certification was erroneous by reason of changed circumstances.

d. The terms "covered transaction," "debarred," "suspended," "ineligible," "participant," "person," "principal," and "voluntarily excluded," as used in this clause, are defined in 2 CFR Parts 180 and 1200. You may contact the person to which this proposal is submitted for assistance in obtaining a copy of those regulations. "First Tier Covered Transactions" refers to any covered transaction between a grantee or subgrantee of Federal funds and a participant (such as the prime or general contract). "Lower Tier Covered Transactions" refers to any covered transaction under a First Tier Covered Transaction (such as subcontracts). "First Tier Participant" refers to the participant who has entered into a covered transaction with a grantee or subgrantee of Federal funds (such as the prime or general contractor). "Lower Tier Participant" refers any participant who has entered into a covered transaction with a First Tier Participant or other Lower Tier Participants (such as subcontractors and suppliers).

e. The prospective lower tier participant agrees by submitting this proposal that, should the proposed covered transaction be entered into, it shall not knowingly enter into any lower tier covered transaction with a person who is debarred, suspended, declared ineligible, or voluntarily excluded from participation in this covered transaction, unless authorized by the department or agency with which this transaction originated.

f. The prospective lower tier participant further agrees by submitting this proposal that it will include this clause titled "Certification Regarding Debarment, Suspension, Ineligibility and Voluntary Exclusion-Lower Tier Covered Transaction," without modification, in all lower tier covered transactions and in all solicitations for lower tier covered transactions exceeding the \$25,000 threshold.

g. A participant in a covered transaction may rely upon a certification of a prospective participant in a lower tier covered transaction that is not debarred, suspended, ineligible, or voluntarily excluded from the covered transaction, unless it knows that the certification is erroneous. A participant is responsible for ensuring that its principals are not suspended, debarred, or otherwise ineligible to participate in covered transactions. To verify the eligibility of its principals, as well as the eligibility of any lower tier prospective participants, each participant may, but is not required to, check the Excluded Parties List System website (<https://www.epls.gov/>), which is compiled by the General Services Administration.

h. Nothing contained in the foregoing shall be construed to require establishment of a system of records in order to render in good faith the



certification required by this clause. The knowledge and information of participant is not required to exceed that which is normally possessed by a prudent person in the ordinary course of business dealings.

i. Except for transactions authorized under paragraph e of these instructions, if a participant in a covered transaction knowingly enters into a lower tier covered transaction with a person who is suspended, debarred, ineligible, or voluntarily excluded from participation in this transaction, in addition to other remedies available to the Federal Government, the department or agency with which this transaction originated may pursue available remedies, including suspension and/or debarment.

\* \* \* \* \*

**Certification Regarding Debarment, Suspension, Ineligibility and Voluntary Exclusion--Lower Tier Participants:**

1. The prospective lower tier participant certifies, by submission of this proposal, that neither it nor its principals is presently debarred, suspended, proposed for debarment, declared ineligible, or voluntarily excluded from participating in covered transactions by any Federal department or agency.

2. Where the prospective lower tier participant is unable to certify to any of the statements in this certification, such prospective participant shall attach an explanation to this proposal.

\* \* \* \* \*

**XI. CERTIFICATION REGARDING USE OF CONTRACT FUNDS FOR LOBBYING**

This provision is applicable to all Federal-aid construction contracts and to all related subcontracts which exceed \$100,000 (49 CFR 20).

1. The prospective participant certifies, by signing and submitting this bid or proposal, to the best of his or her knowledge and belief, that:

a. No Federal appropriated funds have been paid or will be paid, by or on behalf of the undersigned, to any person for influencing or attempting to influence an officer or employee of any Federal agency, a Member of Congress, an officer or employee of Congress, or an employee of a Member of Congress in connection with the awarding of any Federal contract, the making of any Federal grant, the making of any Federal loan, the entering into of any cooperative agreement, and the extension, continuation, renewal, amendment, or modification of any Federal contract, grant, loan, or cooperative agreement.

b. If any funds other than Federal appropriated funds have been paid or will be paid to any person for influencing or attempting to influence an officer or employee of any Federal agency, a Member of Congress, an officer or employee of Congress, or an employee of a Member of Congress in connection with this Federal contract, grant, loan, or cooperative agreement, the undersigned shall complete and submit Standard Form-LLL, "Disclosure Form to Report Lobbying," in accordance with its instructions.

2. This certification is a material representation of fact upon which reliance was placed when this transaction was made or entered into. Submission of this certification is a prerequisite for making or entering into this transaction imposed by 31 U.S.C. 1352. Any person who fails to file the required certification shall be subject to a civil penalty of not less than \$10,000 and not more than \$100,000 for each such failure.

3. The prospective participant also agrees by submitting its bid or proposal that the participant shall require that the language of this certification be included in all lower tier subcontracts, which exceed \$100,000 and that all such recipients shall certify and disclose accordingly.

**MINIMUM WAGES FOR FEDERAL AND FEDERALLY  
ASSISTED CONSTRUCTION CONTRACTS**

This project is funded, in part, with Federal-aid funds and, as such, is subject to the provisions of the Davis-Bacon Act of March 3, 1931, as amended (46 Sta. 1494, as amended, 40 U.S.C. 276a) and of other Federal statutes referred to in a 29 CFR Part 1, Appendix A, as well as such additional statutes as may from time to time be enacted containing provisions for the payment of wages determined to be prevailing by the Secretary of Labor in accordance with the Davis-Bacon Act and pursuant to the provisions of 29 CFR Part 1. The prevailing rates and fringe benefits shown in the General Wage Determination Decisions issued by the U.S. Department of Labor shall, in accordance with the provisions of the foregoing statutes, constitute the minimum wages payable on Federal and federally assisted construction projects to laborers and mechanics of the specified classes engaged on contract work of the character and in the localities described therein.

General Wage Determination Decisions, modifications and supersedes decisions thereto are to be used in accordance with the provisions of 29 CFR Parts 1 and 5. Accordingly, the applicable decision, together with any modifications issued, must be made a part of every contract for performance of the described work within the geographic area indicated as required by an applicable DBRA Federal prevailing wage law and 29 CFR Part 5. The wage rates and fringe benefits contained in the General Wage Determination Decision shall be the minimum paid by contractors and subcontractors to laborers and mechanics.

**NOTICE**

The most current **General Wage Determination Decisions** (wage rates) are available on the IDOT web site. They are located on the Letting and Bidding page at <http://www.dot.state.il.us/desenv/delett.html>.

In addition, ten (10) days prior to the letting, the applicable Federal wage rates will be e-mailed to subscribers. It is recommended that all contractors subscribe to the Federal Wage Rates List or the Contractor's Packet through IDOT's subscription service.

PLEASE NOTE: if you have already subscribed to the Contractor's Packet you will automatically receive the Federal Wage Rates.

The instructions for subscribing are at <http://www.dot.state.il.us/desenv/subsc.html>.

If you have any questions concerning the wage rates, please contact IDOT's Chief Contract Official at 217-782-7806.