

125

Letting April 26, 2019

Notice to Bidders, Specifications and Proposal



**Contract No. 99616
JACKSON County
Section 14-00173-00-RS
Route FAS 1918 (Ava Road)
Project 1LXJ-606 ()
District 9 Construction Funds**

Prepared by

Checked by

F

(Printed by authority of the State of Illinois)



- 1. TIME AND PLACE OF OPENING BIDS.** Electronic bids are to be submitted to the electronic bidding system (iCX-Integrated Contractors Exchange). All bids must be submitted to the iCX system prior to 10:00 a.m. April 26, 2019 at which time the bids will be publicly opened from the iCX SecureVault.
- 2. DESCRIPTION OF WORK.** The proposed improvement is identified and advertised for bids in the Invitation for Bids as:

**Contract No. 99616
JACKSON County
Section 14-00173-00-RS
Project 1LXJ-606 ()
Route FAS 1918 (Ava Road)
District 9 Construction Funds**

Resurfacing Ava Road from IL 4 to South of Francis Lane.

- 3. INSTRUCTIONS TO BIDDERS.** (a) This Notice, the invitation for bids, proposal and letter of award shall, together with all other documents in accordance with Article 101.09 of the Standard Specifications for Road and Bridge Construction, become part of the contract. Bidders are cautioned to read and examine carefully all documents, to make all required inspections, and to inquire or seek explanation of the same prior to submission of a bid.

(b) State law, and, if the work is to be paid wholly or in part with Federal-aid funds, Federal law requires the bidder to make various certifications as a part of the proposal and contract. By execution and submission of the proposal, the bidder makes the certification contained therein. A false or fraudulent certification shall, in addition to all other remedies provided by law, be a breach of contract and may result in termination of the contract.
- 4. AWARD CRITERIA AND REJECTION OF BIDS.** This contract will be awarded to the lowest responsive and responsible bidder considering conformity with the terms and conditions established by the Department in the rules, Invitation for Bids and contract documents. The issuance of plans and proposal forms for bidding based upon a prequalification rating shall not be the sole determinant of responsibility. The Department reserves the right to determine responsibility at the time of award, to reject any or all proposals, to readvertise the proposed improvement, and to waive technicalities.

By Order of the
Illinois Department of Transportation

Omer Osman,
Acting Secretary

INDEX
FOR
SUPPLEMENTAL SPECIFICATIONS
AND RECURRING SPECIAL PROVISIONS

Adopted January 1, 2019

This index contains a listing of SUPPLEMENTAL SPECIFICATIONS, frequently used RECURRING SPECIAL PROVISIONS, and LOCAL ROADS AND STREETS RECURRING SPECIAL PROVISIONS.

ERRATA Standard Specifications for Road and Bridge Construction (Adopted 4-1-16) (Revised 1-1-19)

SUPPLEMENTAL SPECIFICATIONS

<u>Std. Spec. Sec.</u>	<u>Page No.</u>
106 Control of Materials	1
107 Legal Regulations and Responsibility to Public	2
403 Bituminous Surface Treatment (Class A-1, A-2, A-3)	3
404 Micro-Surfacing and Slurry Sealing	4
405 Cape Seal	15
406 Hot-Mix Asphalt Binder and Surface Course	25
420 Portland Cement Concrete Pavement	26
424 Portland Cement Concrete Sidewalk	28
442 Pavement Patching	29
502 Excavation for Structures	30
503 Concrete Structures	32
504 Precast Concrete Structures	35
542 Pipe Culverts	36
586 Sand Backfill for Vaulted Abutments	37
602 Catch Basin, Manhole, Inlet, Drainage Structure, and Valve Vault Construction, Adjustment, and Reconstruction	39
630 Steel Plate Beam Guardrail	40
631 Traffic Barrier Terminals	43
670 Engineer's Field Office and Laboratory	44
701 Work Zone Traffic Control and Protection	45
704 Temporary Concrete Barrier	46
780 Pavement Striping	48
781 Raised Reflective Pavement Markers	49
888 Pedestrian Push-Button.....	50
1001 Cement	51
1003 Fine Aggregates	52
1004 Coarse Aggregates	53
1006 Metals	56
1020 Portland Cement Concrete	58
1043 Adjusting Rings	60
1050 Poured Joint Sealers	62
1069 Pole and Tower	64
1077 Post and Foundation	65
1096 Pavement Markers	66
1101 General Equipment	67
1102 Hot-Mix Asphalt Equipment	68
1103 Portland Cement Concrete Equipment	70
1105 Pavement Marking Equipment	72
1106 Work Zone Traffic Control Devices	74

RECURRING SPECIAL PROVISIONS

The following RECURRING SPECIAL PROVISIONS indicated by an "X" are applicable to this contract and are included by reference:

<u>CHECK SHEET #</u>			<u>PAGE NO.</u>
1	X	Additional State Requirements for Federal-Aid Construction Contracts	75
2	X	Subletting of Contracts (Federal-Aid Contracts)	78
3	X	EEO	79
4		Specific EEO Responsibilities Non Federal-Aid Contracts	89
5		Required Provisions - State Contracts	94
6		Asbestos Bearing Pad Removal	100
7		Asbestos Waterproofing Membrane and Asbestos HMA Surface Removal	101
8		Temporary Stream Crossings and In-Stream Work Pads	102
9		Construction Layout Stakes Except for Bridges	103
10		Construction Layout Stakes	106
11		Use of Geotextile Fabric for Railroad Crossing	109
12		Subsealing of Concrete Pavements	111
13		Hot-Mix Asphalt Surface Correction	115
14		Pavement and Shoulder Resurfacing	117
15		Patching with Hot-Mix Asphalt Overlay Removal	118
16		Polymer Concrete	120
17		PVC Pipeliner	122
18		Bicycle Racks	123
19		Temporary Portable Bridge Traffic Signals	125
20		Work Zone Public Information Signs	127
21		Nighttime Inspection of Roadway Lighting	128
22		English Substitution of Metric Bolts	129
23		Calcium Chloride Accelerator for Portland Cement Concrete	130
24		Quality Control of Concrete Mixtures at the Plant	131
25		Quality Control/Quality Assurance of Concrete Mixtures	139
26		Digital Terrain Modeling for Earthwork Calculations	155
27		Reserved	157
28		Preventive Maintenance – Bituminous Surface Treatment (A-1)	158
29		Reserved	164
30		Reserved	165
31		Reserved	166
32		Temporary Raised Pavement Markers	167
33		Restoring Bridge Approach Pavements Using High-Density Foam	168
34		Portland Cement Concrete Inlay or Overlay	171
35		Portland Cement Concrete Partial Depth Hot-Mix Asphalt Patching	175

LOCAL ROADS AND STREETS RECURRING SPECIAL PROVISIONS

The following LOCAL ROADS AND STREETS RECURRING SPECIAL PROVISIONS indicated by an "X" are applicable to this contract and are included by reference:

<u>CHECK SHEET #</u>	<u>PAGE NO.</u>
LRS1	Reserved 179
LRS2	Furnished Excavation 180
LRS3	X Work Zone Traffic Control Surveillance 181
LRS4	Flaggers in Work Zones 182
LRS5	Contract Claims 183
LRS6	Bidding Requirements and Conditions for Contract Proposals 184
LRS7	Bidding Requirements and Conditions for Material Proposals 190
LRS8	Reserved 196
LRS9	Bituminous Surface Treatments 197
LRS10	Reserved 198
LRS11	Employment Practices 199
LRS12	Wages of Employees on Public Works 201
LRS13	Selection of Labor 203
LRS14	Paving Brick and Concrete Paver Pavements and Sidewalks 204
LRS15	Partial Payments 207
LRS16	Protests on Local Lettings 208
LRS17	Substance Abuse Prevention Program 209
LRS18	Multigrade Cold Mix Asphalt 210

SPECIAL PROVISIONS

INDEX

<u>ITEM</u>	<u>PAGE</u>
DESCRIPTION OF WORK	1
TRAFFIC CONTROL AND PROTECTION, (SPECIAL)	1
UTILITIES	3
HOT-MIX ASPHALT SURFACE REMOVAL, BUTT JOINT	4
HOT-MIX ASPHALT SURFACE REMOVAL, ½”	4
HOT-MIX ASPHALT SURFACE REMOVAL, 1.5”	4
HOT-MIX ASPHALT SHOULDERS	5
JACKSON COUNTY PROGRESS SIGN	5

LOCAL ROADS AND STREETS SPECIAL PROVISIONS

INDEX

<u>ITEM</u>	<u>PAGE</u>
LR 107-4 INSURANCE	7

BDE SPECIAL PROVISIONS

The following special provisions indicated by an "X" are applicable to this contract. An * indicates a new or revised special provision for the letting.

<u>File Name</u>	<u>Pg.</u>	<u>Special Provision Title</u>	<u>Effective</u>	<u>Revised</u>
80099		Accessible Pedestrian Signals (APS)	April 1, 2003	Jan. 1, 2014
80274		Aggregate Subgrade Improvement	April 1, 2012	April 1, 2016
80192		Automated Flagger Assistance Device	Jan. 1, 2008	
80173	8	X Bituminous Materials Cost Adjustments	Nov. 2, 2006	Aug. 1, 2017
80241		Bridge Demolition Debris	July 1, 2009	
50261		Building Removal-Case I (Non-Friable and Friable Asbestos)	Sept. 1, 1990	April 1, 2010
50481		Building Removal-Case II (Non-Friable Asbestos)	Sept. 1, 1990	April 1, 2010
50491		Building Removal-Case III (Friable Asbestos)	Sept. 1, 1990	April 1, 2010
50531		Building Removal-Case IV (No Asbestos)	Sept. 1, 1990	April 1, 2010
80404		Coarse Aggregate Quality for Micro-Surfacing and Cape Seals	Jan. 1, 2019	
* 80384	10	X Compensable Delay Costs	June 2, 2017	April 1, 2019
80198		Completion Date (via calendar days)	April 1, 2008	
80199		Completion Date (via calendar days) Plus Working Days	April 1, 2008	
80293		Concrete Box Culverts with Skews > 30 Degrees and Design Fills ≤ 5 Feet	April 1, 2012	July 1, 2016
80311		Concrete End Sections for Pipe Culverts	Jan. 1, 2013	April 1, 2016
80277		Concrete Mix Design – Department Provided	Jan. 1, 2012	April 1, 2016
80261		Construction Air Quality – Diesel Retrofit	June 1, 2010	Nov. 1, 2014
80387		Contrast Preformed Plastic Pavement Marking	Nov. 1, 2017	
* 80029	14	X Disadvantaged Business Enterprise Participation	Sept. 1, 2000	Mar. 2, 2019
80402	24	X Disposal Fees	Nov. 1, 2018	
80378		Dowel Bar Inserter	Jan. 1, 2017	Jan. 1, 2018
80405		Elastomeric Bearings	Jan. 1, 2019	
80388	26	X Equipment Parking and Storage	Nov. 1, 2017	
80229		Fuel Cost Adjustment	April 1, 2009	Aug. 1, 2017
80304		Grooving for Recessed Pavement Markings	Nov. 1, 2012	Nov. 1, 2017
80246	27	X Hot-Mix Asphalt – Density Testing of Longitudinal Joints	Jan. 1, 2010	Aug. 1, 2018
80398	29	X Hot-Mix Asphalt – Longitudinal Joint Sealant	Aug. 1, 2018	Jan. 1, 2019
80406		Hot-Mix Asphalt – Mixture Design Verification and Production (Modified for I-FIT Projects)	Jan. 1, 2019	
80399	33	X Hot-Mix Asphalt – Oscillatory Roller	Aug. 1, 2018	Nov. 1, 2018
80347		Hot-Mix Asphalt – Pay for Performance Using Percent Within Limits – Jobsite Sampling	Nov. 1, 2014	Aug. 1, 2018
80383		Hot-Mix Asphalt – Quality Control for Performance	April 1, 2017	Jan. 1, 2019
80376	35	X Hot-Mix Asphalt – Tack Coat	Nov. 1, 2016	
80392	36	X Lights on Barricades	Jan. 1, 2018	
80336		Longitudinal Joint and Crack Patching	April 1, 2014	April 1, 2016
* 80411		Luminaires, LED	April 1, 2019	
* 80393		Manholes, Valve Vaults, and Flat Slab Tops	Jan. 1, 2018	Mar. 1, 2019
80400		Mast Arm Assembly and Pole	Aug. 1, 2018	
80045		Material Transfer Device	June 15, 1999	Aug. 1, 2014
80394		Metal Flared End Section for Pipe Culverts	Jan. 1, 2018	April 1, 2018
80165		Moisture Cured Urethane Paint System	Nov. 1, 2006	Jan. 1, 2010
80349		Pavement Marking Blackout Tape	Nov. 1, 2014	April 1, 2016
80371		Pavement Marking Removal	July 1, 2016	
80390	38	X Payments to Subcontractors	Nov. 2, 2017	
80389	39	X Portland Cement Concrete	Nov. 1, 2017	
80359		Portland Cement Concrete Bridge Deck Curing	April 1, 2015	Nov. 1, 2017

<u>File Name</u>	<u>Pg.</u>	<u>Special Provision Title</u>	<u>Effective</u>	<u>Revised</u>
80300		Preformed Plastic Pavement Marking Type D - Inlaid	April 1, 2012	April 1, 2016
80328	40	X Progress Payments	Nov. 2, 2013	
34261		Railroad Protective Liability Insurance	Dec. 1, 1986	Jan. 1, 2006
80157		Railroad Protective Liability Insurance (5 and 10)	Jan. 1, 2006	
80306	41	X Reclaimed Asphalt Pavement (RAP) and Reclaimed Asphalt Shingles (RAS)	Nov. 1, 2012	Jan. 1, 2019
80407	51	X Removal and Disposal of Regulated Substances	Jan. 1, 2019	
80395		Sloped Metal End Section for Pipe Culverts	Jan. 1, 2018	
80340		Speed Display Trailer	April 2, 2014	Jan. 1, 2017
80127		Steel Cost Adjustment	April 2, 2014	Aug. 1, 2017
80408		Steel Plate Beam Guardrail Manufacturing	Jan. 1, 2019	
80397	63	X Subcontractor and DBE Payment Reporting	April 2, 2018	
* 80391	64	X Subcontractor Mobilization Payments	Nov. 2, 2017	April 1, 2019
80317		Surface Testing of Hot-Mix Asphalt Overlays	Jan. 1, 2013	April 1, 2016
80298		Temporary Pavement Marking	April 1, 2012	April 1, 2017
20338		Training Special Provision	Oct. 15, 1975	
80403		Traffic Barrier Terminal, Type 1 Special	Nov. 1, 2018	
80409	65	X Traffic Control Devices – Cones	Jan. 1, 2019	
80410		Traffic Spotters	Jan. 1, 2019	
80318		Traversable Pipe Grate for Concrete End Sections	Jan. 1, 2013	Jan. 1, 2018
80288		Warm Mix Asphalt	Jan. 1, 2012	April 1, 2016
80302	66	X Weekly DBE Trucking Reports	June 2, 2012	April 2, 2015
80071	67	X Working Days	Jan. 1, 2002	

The following special provisions are in the 2019 Supplemental Specifications and Recurring Special Provisions.

<u>File Name</u>	<u>Special Provision Title</u>	<u>New Location(s)</u>	<u>Effective</u>	<u>Revised</u>
80382	Adjusting Frames and Grates	Articles 602.02(s) and (t), 1043.04, and 1043.05	April 1, 2017	
80366	Butt Joints	Article 406.08(c)	July 1, 2016	
80386	Calcium Aluminate Cement for Class PP-5 Concrete Patching	Article 1001.01(e)	Nov. 1, 2017	
80396	Class A and B Patching	Articles 442.06(a)(1) and (2)	Jan. 1, 2018	Nov. 1, 2018
80377	Portable Changeable Message Signs	Articles 701.20(h) and 1106.02(i)	Nov. 1, 2016	April 1, 2017
80385	Portland Cement Concrete Sidewalk	Article 424.12	Aug. 1, 2017	

The following special provision has been deleted from use.

<u>File Name</u>	<u>Special Provision Title</u>	<u>Effective</u>	<u>Revised</u>
80401	Portland Cement Concrete Pavement Connector for Bridge Approach Slab	Aug. 1, 2018	

SPECIAL PROVISIONS

The following Special Provisions supplement the "Standard Specifications for Road and Bridge Construction", adopted April 1, 2016, the latest edition of the "Illinois Manual on Uniform Traffic Control Devices for Streets and Highways" and the "Manual on Test Procedures for Materials" in effect on the date of invitation for bids, and the Supplemental Specifications and Recurring Special Provisions indicated on the Check Sheet included herein which apply to and govern the construction of FAS Route 1918, Section 14-00173-00-RS in Jackson County, and in case of conflict with any part, or parts, of said Specifications, the said Special Provisions shall take precedence and shall govern.

DESCRIPTION OF WORK:

The proposed improvement consists of constructing a 2" HMA surface course functional overlay, 1/2" HMA surface removal, 1.5" HMA surface course overlay/inlay on urban section, a 4' wide HMA shoulder and a shoulder wedge composed of excavated shoulder material generated on site, pavement markings and raised reflective pavement markers on a portion of FAS 1918 (Ava Road).

TRAFFIC CONTROL AND PROTECTION, (SPECIAL):

Description: The Contractor will be required to maintain at least one-way traffic during the construction of the proposed improvement.

Traffic control shall be in accordance with the applicable sections of the Standard Specifications, the applicable guidelines contained in the Illinois Manual on Uniform Traffic Control Devices, these Special Provisions, and the Highway Standards contained herein and in the plans.

At least one week in advance of implementing traffic control, the contractor shall furnish to the Department the name of the individual in the Contractor's direct employ who is to be responsible for the installation and maintenance of the traffic control for the project. When the actual installation and maintenance are to be accomplished by a subcontractor, consent shall be requested of the Department at least one week in advance of implementing traffic control. This shall not relieve the Contractor of furnishing a responsible individual in the Contractor's direct employ.

Special attention is called to Articles 107.09 and 107.14 of the Standard Specifications and the following Highway Standards: 701006, 701011, 701301, 701306, 701311, 701326, and 701901.

This work shall conform to the applicable portions of Section 701 of the Standards Specifications and applicable portions of the Traffic Control Plan included in the contract documents. This item of work shall consist of furnishing, installing, maintaining, relocating and removing all traffic control devices used for regulating, warning or directing traffic during the construction of this project.

All traffic control devices used in this project shall conform to the plans, special provisions, traffic control standards and the "Illinois Manual on Uniform Traffic Control Devices for Streets and Highways". No modification of these requirements will be allowed without prior written approval from the Engineer.

Traffic control devices shall include all temporary traffic control and regulatory signs as described herein, and their supports, barricades with sand bags, plastic drums, channelizing devices, warning lights, flaggers or any other device used for regulating, warning or guiding traffic through the construction zone and guiding traffic around the construction.

The Contractor shall be responsible for the proper location, installation and arrangement of all traffic control devices as shown on the plans or as directed by the Engineer. The Contractor, when directed by the Engineer, shall remove all traffic control devices which were furnished, installed and maintained by him/her under this contract, and such devices shall remain in place until specific authorization for relocation or removal is received from the Engineer.

All labor, equipment and materials required to complete this work shall be paid for at the contract unit price per LUMP SUM for TRAFFIC CONTROL AND PROTECTION, (SPECIAL).

UTILITIES

Effective 1984 Revised 2/10/17

Add the following after the first paragraph of Article 105.07 of the Standard Specifications:

Underground utilities have been plotted from available surveys and records and, therefore, their locations must be considered approximate only. There also may be utilities for which the locations are unknown. Verification of locations of underground utilities, shown or not shown, will be the responsibility of the Contractor. The following utility companies have facilities within the project limits which will require adjustment:

Name and Address of Utility	Type	Locations	Estimated Date Adjustment Completed

Additional utility information may be obtained by calling the "Joint Utility Location Information for Excavators" phone number, 800-892-0123. This project is located in the _____.

Add the following after the first paragraph of Article 107.31 of the Standard Specifications:

The Contractor is advised that this project includes areas of highway illumination and/or signalized intersections. These areas have underground cable or conduit throughout which is to remain in service. Before driving any posts or beginning any excavation operations, the Contractor shall locate, uncover by hand and relocate any wiring which conflicts with the proposed work. Any cable or conduit which is damaged as a result of the Contractor's operations shall be replaced by him at his expense. Replacement material and methods shall meet or exceed the original specifications for the wiring. Splicing will not be permitted.

HOT-MIX ASPHALT SURFACE REMOVAL, BUTT JOINT:

Description: Hot-mix Asphalt surface removal shall be done in accordance with Section 440 of the Standard Specifications with the following exceptions. The depth of the removal shall be between 0" & 1.5". All removed material shall become the property of the Jackson County Highway Department and shall be delivered to its maintenance facility at 1200 Enterprise Avenue, Murphysboro, Illinois. The cost of which shall not be paid for separately, but shall be considered incidental to the cost of BITUMINOUS SURFACE REMOVAL, VARIABLE DEPTH".

Basis of Payment: This work shall be paid for at the contract unit price per square yard for HOT-MIX ASPHALT SURFACE REMOVAL BUTT JOINT.

HOT-MIX ASPHALT SURFACE REMOVAL, ½”:

Description: Hot-mix Asphalt surface removal shall be done in accordance with Section 440 of the Standard Specifications except all removed material shall become the property of the Jackson County Highway Department and shall be delivered to its maintenance facility at 1200 Enterprise Avenue, Murphysboro, Illinois. The cost of which shall not be paid for separately, but shall be considered incidental to the cost of BITUMINOUS SURFACE REMOVAL, ½".

Basis of Payment: This work shall be paid for at the contract unit price per square yard for HOT-MIX ASPHALT SURFACE REMOVAL, ½”.

HOT-MIX ASPHALT SURFACE REMOVAL, 1.5”

Description: This item of work shall be performed in accordance with Section 406 of the Standard Specifications except as modified herein. The area of HMA surface removal shall include the existing 22' wide surface and 4' paved shoulder as shown on the Typical Section. The depth will generally be 1.5” but may vary in some areas in order to correct pavement cross-slope and sideroad/private entrance approach grade. Saw cuts and temporary ramps at butt joints shall not be paid for separately, but shall be considered incidental to HOT-MIX ASPHALT SURFACE REMOVAL, 1.5”. The milled material shall become the property of the Jackson County Highway Department and shall be delivered to its maintenance facility at 1200 Enterprise Avenue, Murphysboro, Illinois.

Basis of Payment: This work will be paid for at the contract unit price per Sq. Yd. for HOT-MIX ASPHALT SURFACE REMOVAL, 1.5” which price shall include saw cuts and temporary ramps at butt joints and all other work required to construct this item.

HOT-MIX ASPHALT SHOULDERS:

Description: This item of work shall consist of the construction of 6” HOT-MIX ASPHALT SHOULDERS adjacent to the pavement at the locations shown on the Typical Section. The shoulders shall be constructed as specified in Section 482. The excavation for the bituminous shoulder shall be done with an approved, self-propelled milling machine. The excavated material shall be conveyed to trucks and stockpiled. The excavated material shall be conveyed to trucks and stockpiled. A portion of the stockpiled material will be used to fill in areas needing a transition wedge between the proposed bituminous concrete shoulder and the existing shoulder as directed by the Engineer. This wedge shall be placed with a self-propelled road widener and compacted to the satisfaction of the Engineer. Access to all private entrances and side roads not gapped shall be maintained. This item of work shall also include HMA placed as an overlay on existing paved shoulders, sideroads, private entrances, and mailbox turnouts. Any remaining stockpiled material shall be disposed of by the contractor.

Basis of Payment: This work will be paid for at the contract unit price per Ton for HOT-MIX ASPHALT SHOULDERS which price shall include all necessary earth excavation and other work required to construct this item.

JACKSON COUNTY PROGRESS SIGN:

Description: This item of work shall consist of erecting two 48” x 30” “JACKSON COUNTY MAKING PROGRESS FOR YOU” signs. The signs, which will be provided by the Department, shall be erected by the Contractor on two metal posts furnished by the Contractor. These signs shall be erected according to all applicable portions of Article 701.14 and Standard 701901, 720001, 728001, and 729001. These signs shall be erected midway between the first and second warning signs as required by the traffic control plan and standards utilized for this project. If the second warning sign is defining a moving or intermittent operation, the Jackson County Progress sign may be maintained at a distance of 500 ft beyond the first post mounted ROAD CONSTRUCTION AHEAD sign. The Jackson County Progress signs shall remain in place for the duration of the project. Upon completion of the project, the signs shall be removed and returned to the department. The posts shall remain the property of the Contractor.

Jackson County
FAS 1918 (Ava Rd)
Section 14-00173-00-RS
Project No. 1LXJ(606)

Basis of Payment: The cost of furnishing the materials, labor and equipment necessary for the installation of the Jackson County Progress signs in accordance with the above standards shall be incidental to the contract, and no additional compensation will be allowed.

State of Illinois
Department of Transportation
Bureau of Local Roads and Streets

SPECIAL PROVISION
FOR
INSURANCE

Effective: February 1, 2007
Revised: August 1, 2007

All references to Sections or Articles in this specification shall be construed to mean specific Section or Article of the Standard Specifications for Road and Bridge Construction, adopted by the Department of Transportation.

The Contractor shall name the following entities as additional insured under the Contractor's general liability insurance policy in accordance with Article 107.27:

The entities listed above and their officers, employees, and agents shall be indemnified and held harmless in accordance with Article 107.26.

BITUMINOUS MATERIALS COST ADJUSTMENTS (BDE)

Effective: November 2, 2006

Revised: August 1, 2017

Description. Bituminous material cost adjustments will be made to provide additional compensation to the Contractor, or credit to the Department, for fluctuations in the cost of bituminous materials when optioned by the Contractor. The bidder shall indicate with their bid whether or not this special provision will be part of the contract.

The adjustments shall apply to permanent and temporary hot-mix asphalt (HMA) mixtures, bituminous surface treatments (cover and seal coats), and preventative maintenance type surface treatments that are part of the original proposed construction, or added as extra work and paid for by agreed unit prices. The adjustments shall not apply to bituminous prime coats, tack coats, crack filling/sealing, joint filling/sealing, or extra work paid for at a lump sum price or by force account.

Method of Adjustment. Bituminous materials cost adjustments will be computed as follows.

$$CA = (BPI_P - BPI_L) \times (\%AC_V / 100) \times Q$$

- Where: CA = Cost Adjustment, \$.
- BPI_P = Bituminous Price Index, as published by the Department for the month the work is performed, \$/ton (\$/metric ton).
- BPI_L = Bituminous Price Index, as published by the Department for the month prior to the letting for work paid for at the contract price; or for the month the agreed unit price letter is submitted by the Contractor for extra work paid for by agreed unit price, \$/ton (\$/metric ton).
- %AC_V = Percent of virgin Asphalt Cement in the Quantity being adjusted. For HMA mixtures, the % AC_V will be determined from the adjusted job mix formula. For bituminous materials applied, a performance graded or cutback asphalt will be considered to be 100% AC_V and undiluted emulsified asphalt will be considered to be 65% AC_V.
- Q = Authorized construction Quantity, tons (metric tons) (see below).

For HMA mixtures measured in square yards: $Q, \text{ tons} = A \times D \times (G_{mb} \times 46.8) / 2000$. For HMA mixtures measured in square meters: $Q, \text{ metric tons} = A \times D \times (G_{mb} \times 1) / 1000$. When computing adjustments for full-depth HMA pavement, separate calculations will be made for the binder and surface courses to account for their different G_{mb} and % AC_V.

For bituminous materials measured in gallons: $Q, \text{ tons} = V \times 8.33 \text{ lb/gal} \times SG / 2000$
For bituminous materials measured in liters: $Q, \text{ metric tons} = V \times 1.0 \text{ kg/L} \times SG / 1000$

- Where: A = Area of the HMA mixture, sq yd (sq m).
D = Depth of the HMA mixture, in. (mm).
G_{mb} = Average bulk specific gravity of the mixture, from the approved mix design.

V = Volume of the bituminous material, gal (L).
SG = Specific Gravity of bituminous material as shown on the bill of lading.

Basis of Payment. Bituminous materials cost adjustments may be positive or negative but will only be made when there is a difference between the BPI_L and BPI_P in excess of five percent, as calculated by:

$$\text{Percent Difference} = \{(BPI_L - BPI_P) \div BPI_L\} \times 100$$

Bituminous materials cost adjustments will be calculated for each calendar month in which applicable bituminous material is placed; and will be paid or deducted when all other contract requirements for the work placed during the month are satisfied. The adjustments shall not apply during contract time subject to liquidated damages for completion of the entire contract.

80173

COMPENSABLE DELAY COSTS (BDE)

Effective: June 2, 2017

Revised: April 1, 2019

Revise Article 107.40(b) of the Standard Specifications to read:

“(b) Compensation. Compensation will not be allowed for delays, inconveniences, or damages sustained by the Contractor from conflicts with facilities not meeting the above definition; or if a conflict with a utility in an unanticipated location does not cause a shutdown of the work or a documentable reduction in the rate of progress exceeding the limits set herein. The provisions of Article 104.03 notwithstanding, compensation for delays caused by a utility in an unanticipated location will be paid according to the provisions of this Article governing minor and major delays or reduced rate of production which are defined as follows.

- (1) Minor Delay. A minor delay occurs when the work in conflict with the utility in an unanticipated location is completely stopped for more than two hours, but not to exceed two weeks.
- (2) Major Delay. A major delay occurs when the work in conflict with the utility in an unanticipated location is completely stopped for more than two weeks.
- (3) Reduced Rate of Production Delay. A reduced rate of production delay occurs when the rate of production on the work in conflict with the utility in an unanticipated location decreases by more than 25 percent and lasts longer than seven calendar days.”

Revise Article 107.40(c) of the Standard Specifications to read:

“(c) Payment. Payment for Minor, Major, and Reduced Rate of Production Delays will be made as follows.

- (1) Minor Delay. Labor idled which cannot be used on other work will be paid for according to Article 109.04(b)(1) and (2) for the time between start of the delay and the minimum remaining hours in the work shift required by the prevailing practice in the area.

Equipment idled which cannot be used on other work, and which is authorized to standby on the project site by the Engineer, will be paid for according to Article 109.04(b)(4).

- (2) Major Delay. Labor will be the same as for a minor delay.

Equipment will be the same as for a minor delay, except Contractor-owned equipment will be limited to two weeks plus the cost of move-out to either the

Contractor's yard or another job and the cost to re-mobilize, whichever is less. Rental equipment may be paid for longer than two weeks provided the Contractor presents adequate support to the Department (including lease agreement) to show retaining equipment on the job is the most economical course to follow and in the public interest.

- (3) Reduced Rate of Production Delay. The Contractor will be compensated for the reduced productivity for labor and equipment time in excess of the 25 percent threshold for that portion of the delay in excess of seven calendar days. Determination of compensation will be in accordance with Article 104.02, except labor and material additives will not be permitted.

Payment for escalated material costs, escalated labor costs, extended project overhead, and extended traffic control will be determined according to Article 109.13.”

Revise Article 108.04(b) of the Standard Specifications to read:

“(b) No working day will be charged under the following conditions.

- (1) When adverse weather prevents work on the controlling item.
- (2) When job conditions due to recent weather prevent work on the controlling item.
- (3) When conduct or lack of conduct by the Department or its consultants, representatives, officers, agents, or employees; delay by the Department in making the site available; or delay in furnishing any items required to be furnished to the Contractor by the Department prevents work on the controlling item.
- (4) When delays caused by utility or railroad adjustments prevent work on the controlling item.
- (5) When strikes, lock-outs, extraordinary delays in transportation, or inability to procure critical materials prevent work on the controlling item, as long as these delays are not due to any fault of the Contractor.
- (6) When any condition over which the Contractor has no control prevents work on the controlling item.”

Revise Article 109.09(f) of the Standard Specifications to read:

“(f) Basis of Payment. After resolution of a claim in favor of the Contractor, any adjustment in time required for the work will be made according to Section 108. Any adjustment in the costs to be paid will be made for direct labor, direct materials, direct equipment, direct jobsite overhead, direct offsite overhead, and other direct costs allowed by the resolution. Adjustments in costs will not be made for interest charges, loss of anticipated profit, undocumented loss of efficiency, home office overhead and unabsorbed overhead

other than as allowed by Article 109.13, lost opportunity, preparation of claim expenses and other consequential indirect costs regardless of method of calculation.

The above Basis of Payment is an essential element of the contract and the claim cost recovery of the Contractor shall be so limited.”

Add the following to Section 109 of the Standard Specifications.

“109.13 Payment for Contract Delay. Compensation for escalated material costs, escalated labor costs, extended project overhead, and extended traffic control will be allowed when such costs result from a delay meeting the criteria in the following table.

Contract Type	Cause of Delay	Length of Delay
Working Days	Article 108.04(b)(3) or Article 108.04(b)(4)	No working days have been charged for two consecutive weeks.
Completion Date	Article 108.08(b)(1) or Article 108.08(b)(7)	The Contractor has been granted a minimum two week extension of contract time, according to Article 108.08.

Payment for each of the various costs will be according to the following.

- (a) Escalated Material and/or Labor Costs. When the delay causes work, which would have otherwise been completed, to be done after material and/or labor costs have increased, such increases will be paid. Payment for escalated material costs will be limited to the increased costs substantiated by documentation furnished by the Contractor. Payment for escalated labor costs will be limited to those items in Article 109.04(b)(1) and (2), except the 35 percent and 10 percent additives will not be permitted.
- (b) Extended Project Overhead. For the duration of the delay, payment for extended project overhead will be paid as follows.
 - (1) Direct Jobsite and Offsite Overhead. Payment for documented direct jobsite overhead and documented direct offsite overhead, including onsite supervisory and administrative personnel, will be allowed according to the following table.

Original Contract Amount	Supervisory and Administrative Personnel
Up to \$5,000,000	One Project Superintendent
Over \$ 5,000,000 - up to \$25,000,000	One Project Manager, One Project Superintendent or Engineer, and One Clerk
Over \$25,000,000 - up to \$50,000,000	One Project Manager, One Project Superintendent, One Engineer, and

	One Clerk
Over \$50,000,000	One Project Manager, Two Project Superintendents, One Engineer, and One Clerk

(2) Home Office and Unabsorbed Overhead. Payment for home office and unabsorbed overhead will be calculated as 8 percent of the total delay cost.

(c) Extended Traffic Control. Traffic control required for an extended period of time due to the delay will be paid for according to Article 109.04.

When an extended traffic control adjustment is paid under this provision, an adjusted unit price as provided for in Article 701.20(a) for increase or decrease in the value of work by more than ten percent will not be paid.

Upon payment for a contract delay under this provision, the Contractor shall assign subrogation rights to the Department for the Department's efforts of recovery from any other party for monies paid by the Department as a result of any claim under this provision. The Contractor shall fully cooperate with the Department in its efforts to recover from another party any money paid to the Contractor for delay damages under this provision."

80384

DISADVANTAGED BUSINESS ENTERPRISE PARTICIPATION (DBE)

Effective: September 1, 2000

Revised: March 2, 2019

FEDERAL OBLIGATION. The Department of Transportation, as a recipient of federal financial assistance, is required to take all necessary and reasonable steps to ensure nondiscrimination in the award and administration of contracts. Consequently, the federal regulatory provisions of 49 CFR Part 26 apply to this contract concerning the utilization of disadvantaged business enterprises. For the purposes of this Special Provision, a disadvantaged business enterprise (DBE) means a business certified by the Department in accordance with the requirements of 49 CFR Part 26 and listed in the Illinois Unified Certification Program (IL UCP) DBE Directory.

STATE OBLIGATION. This Special Provision will also be used by the Department to satisfy the requirements of the Business Enterprise for Minorities, Females, and Persons with Disabilities Act, 30 ILCS 575. When this Special Provision is used to satisfy state law requirements on 100 percent state-funded contracts, the federal government has no involvement in such contracts (not a federal-aid contract) and no responsibility to oversee the implementation of this Special Provision by the Department on those contracts. DBE participation on 100 percent state-funded contracts will not be credited toward fulfilling the Department's annual overall DBE goal required by the US Department of Transportation to comply with the federal DBE program requirements.

CONTRACTOR ASSURANCE. The Contractor makes the following assurance and agrees to include the assurance in each subcontract the Contractor signs with a subcontractor.

The Contractor, subrecipient, or subcontractor shall not discriminate on the basis of race, color, national origin, or sex in the performance of this contract. The Contractor shall carry out applicable requirements of 49 CFR Part 26 in the award and administration of contracts funded in whole or in part with federal or state funds. Failure by the Contractor to carry out these requirements is a material breach of this contract, which may result in the termination of this contract or such other remedy as the recipient deems appropriate, which may include, but is not limited to:

- (a) Withholding progress payments;
- (b) Assessing sanctions;
- (c) Liquidated damages; and/or
- (d) Disqualifying the Contractor from future bidding as non-responsible.

OVERALL GOAL SET FOR THE DEPARTMENT. As a requirement of compliance with 49 CFR Part 26, the Department has set an overall goal for DBE participation in its federally assisted contracts. That goal applies to all federal-aid funds the Department will expend in its federally assisted contracts for the subject reporting fiscal year. The Department is required to make a

good faith effort to achieve the overall goal. The dollar amount paid to all approved DBE companies performing work called for in this contract is eligible to be credited toward fulfillment of the Department's overall goal.

CONTRACT GOAL TO BE ACHIEVED BY THE CONTRACTOR. This contract includes a specific DBE utilization goal established by the Department. The goal has been included because the Department has determined the work of this contract has subcontracting opportunities that may be suitable for performance by DBE companies. The determination is based on an assessment of the type of work, the location of the work, and the availability of DBE companies to do a part of the work. The assessment indicates, in the absence of unlawful discrimination and in an arena of fair and open competition, DBE companies can be expected to perform 2.00 % of the work. This percentage is set as the DBE participation goal for this contract. Consequently, in addition to the other award criteria established for this contract, the Department will only award this contract to a bidder who makes a good faith effort to meet this goal of DBE participation in the performance of the work. A bidder makes a good faith effort for award consideration if either of the following is done in accordance with the procedures set for in this Special Provision:

- (a) The bidder documents enough DBE participation has been obtained to meet the goal or,
- (b) The bidder documents a good faith effort has been made to meet the goal, even though the effort did not succeed in obtaining enough DBE participation to meet the goal.

DBE LOCATOR REFERENCES. Bidders shall consult the IL UCP DBE Directory as a reference source for DBE-certified companies. In addition, the Department maintains a letting and item specific DBE locator information system whereby DBE companies can register their interest in providing quotes on particular bid items advertised for letting. Information concerning DBE companies willing to quote work for particular contracts may be obtained by contacting the Department's Bureau of Small Business Enterprises at telephone number (217) 785-4611, or by visiting the Department's website at:

<http://www.idot.illinois.gov/doing-business/certifications/disadvantaged-business-enterprise-certification/il-ucp-directory/index>.

BIDDING PROCEDURES. Compliance with this Special Provision is a material bidding requirement and failure of the bidder to comply will render the bid not responsive.

The bidder shall submit a DBE Utilization Plan (form SBE 2026), and a DBE Participation Statement (form SBE 2025) for each DBE company proposed for the performance of work to achieve the contract goal, with the bid. If the Utilization Plan indicates the contract goal will not be met, documentation of good faith efforts shall also be submitted. The documentation of good faith efforts must include copies of each DBE and non-DBE subcontractor quote submitted to the bidder when a non-DBE subcontractor is selected over a DBE for work on the contract. The required forms and documentation must be submitted as a single .pdf file using the "Integrated Contractor Exchange (iCX)" application within the Department's "EBids System".

The Department will not accept a Utilization Plan if it does not meet the bidding procedures set forth herein and the bid will be declared not responsive. In the event the bid is declared not responsive, the Department may elect to cause the forfeiture of the penal sum of the bidder's proposal guaranty and may deny authorization to bid the project if re-advertised for bids.

GOOD FAITH EFFORT PROCEDURES. The contract will not be awarded until the Utilization Plan is approved. All information submitted by the bidder must be complete, accurate and adequately document enough DBE participation has been obtained or document the good faith efforts of the bidder, in the event enough DBE participation has not been obtained, before the Department will commit to the performance of the contract by the bidder. The Utilization Plan will be approved by the Department if the Utilization Plan documents sufficient commercially useful DBE work to meet the contract goal or the bidder submits sufficient documentation of a good faith effort to meet the contract goal pursuant to 49 CFR Part 26, Appendix A. This means the bidder must show that all necessary and reasonable steps were taken to achieve the contract goal. Necessary and reasonable steps are those which, by their scope, intensity and appropriateness to the objective, could reasonably be expected to obtain sufficient DBE participation, even if they were not successful. The Department will consider the quality, quantity, and intensity of the kinds of efforts the bidder has made. Mere *pro forma* efforts, in other words efforts done as a matter of form, are not good faith efforts; rather, the bidder is expected to have taken genuine efforts that would be reasonably expected of a bidder actively and aggressively trying to obtain DBE participation sufficient to meet the contract goal.

- (a) The following is a list of types of action that the Department will consider as part of the evaluation of the bidder's good faith efforts to obtain participation. These listed factors are not intended to be a mandatory checklist and are not intended to be exhaustive. Other factors or efforts brought to the attention of the Department may be relevant in appropriate cases and will be considered by the Department.
 - (1) Soliciting through all reasonable and available means (e.g. attendance at pre-bid meetings, advertising and/or written notices) the interest of all certified DBE companies that have the capability to perform the work of the contract. The bidder must solicit this interest within sufficient time to allow the DBE companies to respond to the solicitation. The bidder must determine with certainty if the DBE companies are interested by taking appropriate steps to follow up initial solicitations.
 - (2) Selecting portions of the work to be performed by DBE companies in order to increase the likelihood that the DBE goals will be achieved. This includes, where appropriate, breaking out contract work items into economically feasible units to facilitate DBE participation, even when the Contractor might otherwise prefer to perform these work items with its own forces.
 - (3) Providing interested DBE companies with adequate information about the plans, specifications, and requirements of the contract in a timely manner to assist them in responding to a solicitation.

- (4) a. Negotiating in good faith with interested DBE companies. It is the bidder's responsibility to make a portion of the work available to DBE subcontractors and suppliers and to select those portions of the work or material needs consistent with the available DBE subcontractors and suppliers, so as to facilitate DBE participation. Evidence of such negotiation includes the names, addresses, and telephone numbers of DBE companies that were considered; a description of the information provided regarding the plans and specifications for the work selected for subcontracting; and evidence as to why additional agreements could not be reached for DBE companies to perform the work.
 - b. A bidder using good business judgment would consider a number of factors in negotiating with subcontractors, including DBE subcontractors, and would take a firm's price and capabilities as well as contract goals into consideration. However, the fact that there may be some additional costs involved in finding and using DBE companies is not in itself sufficient reason for a bidder's failure to meet the contract DBE goal, as long as such costs are reasonable. Also the ability or desire of a bidder to perform the work of a contract with its own organization does not relieve the bidder of the responsibility to make good faith efforts. Bidders are not, however, required to accept higher quotes from DBE companies if the price difference is excessive or unreasonable. In accordance with the above Bidding Procedures, the documentation of good faith efforts must include copies of each DBE and non-DBE subcontractor quote submitted to the bidder when a non-DBE subcontractor was selected over a DBE for work on the contract.
- (5) Not rejecting DBE companies as being unqualified without sound reasons based on a thorough investigation of their capabilities. The bidder's standing within its industry, membership in specific groups, organizations, or associations and political or social affiliations (for example union vs. non-union employee status) are not legitimate causes for the rejection or non-solicitation of bids in the bidder's efforts to meet the project goal.
 - (6) Making efforts to assist interested DBE companies in obtaining bonding, lines of credit, or insurance as required by the recipient or Contractor.
 - (7) Making efforts to assist interested DBE companies in obtaining necessary equipment, supplies, materials, or related assistance or services.
 - (8) Effectively using the services of available minority/women community organizations; minority/women contractors' groups; local, state, and federal minority/women business assistance offices; and other organizations as allowed on a case-by-case basis to provide assistance in the recruitment and placement of DBE companies.
- (b) If the Department determines the bidder has made a good faith effort to secure the work commitment of DBE companies to meet the contract goal, the Department will award the contract provided it is otherwise eligible for award. If the Department determines the

bidder has failed to meet the requirements of this Special Provision or that a good faith effort has not been made, the Department will notify the responsible company official designated in the Utilization Plan that the bid is not responsive. The notification will also include a statement of reasons for the adverse determination. If the Utilization Plan is not approved because it is deficient as a technical matter, unless waived by the Department, the bidder will be notified and will be allowed no more than a five calendar day period to cure the deficiency.

- (c) The bidder may request administrative reconsideration of an adverse determination by emailing the Department at "DOT.DBE.UP@illinois.gov" within the five calendar days after the receipt of the notification of the determination. The determination shall become final if a request is not made on or before the fifth calendar day. A request may provide additional written documentation or argument concerning the issues raised in the determination statement of reasons, provided the documentation and arguments address efforts made prior to submitting the bid. The request will be reviewed by the Department's Reconsideration Officer. The Reconsideration Officer will extend an opportunity to the bidder to meet in person to consider all issues of documentation and whether the bidder made a good faith effort to meet the goal. After the review by the Reconsideration Officer, the bidder will be sent a written decision within ten working days after receipt of the request for reconsideration, explaining the basis for finding that the bidder did or did not meet the goal or make adequate good faith efforts to do so. A final decision by the Reconsideration Officer that a good faith effort was made shall approve the Utilization Plan submitted by the bidder and shall clear the contract for award. A final decision that a good faith effort was not made shall render the bid not responsive.

CALCULATING DBE PARTICIPATION. The Utilization Plan values represent work anticipated to be performed and paid for upon satisfactory completion. The Department is only able to count toward the achievement of the overall goal and the contract goal the value of payments made for the work actually performed by DBE companies. In addition, a DBE must perform a commercially useful function on the contract to be counted. A commercially useful function is generally performed when the DBE is responsible for the work and is carrying out its responsibilities by actually performing, managing, and supervising the work involved. The Department and Contractor are governed by the provisions of 49 CFR Part 26.55(c) on questions of commercially useful functions as it affects the work. Specific counting guidelines are provided in 49 CFR Part 26.55, the provisions of which govern over the summary contained herein.

- (a) DBE as the Contractor: 100 percent goal credit for that portion of the work performed by the DBE's own forces, including the cost of materials and supplies. Work that a DBE subcontracts to a non-DBE does not count toward the DBE goals.
- (b) DBE as a joint venture Contractor: 100 percent goal credit for that portion of the total dollar value of the contract equal to the distinct, clearly defined portion of the work performed by the DBE's own forces.

- (c) DBE as a subcontractor: 100 percent goal credit for the work of the subcontract performed by the DBE's own forces, including the cost of materials and supplies, excluding the purchase of materials and supplies or the lease of equipment by the DBE subcontractor from the Contractor or its affiliates. Work that a DBE subcontractor in turn subcontracts to a non-DBE does not count toward the DBE goal.
- (d) DBE as a trucker: 100 percent goal credit for trucking participation provided the DBE is responsible for the management and supervision of the entire trucking operation for which it is responsible. At least one truck owned, operated, licensed, and insured by the DBE must be used on the contract. Credit will be given for the following:
 - (1) The DBE may lease trucks from another DBE firm, including an owner-operator who is certified as a DBE. The DBE who leases trucks from another DBE receives credit for the total value of the transportation services the lessee DBE provides on the contract.
 - (2) The DBE may also lease trucks from a non-DBE firm, including from an owner-operator. The DBE who leases trucks from a non-DBE is entitled to credit only for the fee or commission is receives as a result of the lease arrangement.
- (e) DBE as a material supplier:
 - (1) 60 percent goal credit for the cost of the materials or supplies purchased from a DBE regular dealer.
 - (2) 100 percent goal credit for the cost of materials of supplies obtained from a DBE manufacturer.
 - (3) 100 percent credit for the value of reasonable fees and commissions for the procurement of materials and supplies if not a DBE regular dealer or DBE manufacturer.

CONTRACT COMPLIANCE. Compliance with this Special Provision is an essential part of the contract. The Department is prohibited by federal regulations from crediting the participation of a DBE included in the Utilization Plan toward either the contract goal or the Department's overall goal until the amount to be applied toward the goals has been paid to the DBE. The following administrative procedures and remedies govern the compliance by the Contractor with the contractual obligations established by the Utilization Plan. After approval of the Utilization Plan and award of the contract, the Utilization Plan and individual DBE Participation Statements become part of the contract. If the Contractor did not succeed in obtaining enough DBE participation to achieve the advertised contract goal, and the Utilization Plan was approved and contract awarded based upon a determination of good faith, the total dollar value of DBE work calculated in the approved Utilization Plan as a percentage of the awarded contract value shall become the amended contract goal. All work indicated for performance by an approved DBE shall be performed, managed, and supervised by the DBE executing the DBE Participation Commitment Statement.

- (a) NO AMENDMENT. No amendment to the Utilization Plan may be made without prior written approval from the Department's Bureau of Small Business Enterprises. All requests for amendment to the Utilization Plan shall be emailed to the Department at DOT.DBE.UP@illinois.gov.
- (b) CHANGES TO WORK. Any deviation from the DBE condition-of-award or contract plans, specifications, or special provisions must be approved, in writing, by the Department as provided elsewhere in the Contract. The Contractor shall notify affected DBEs in writing of any changes in the scope of work which result in a reduction in the dollar amount condition-of-award to the contract. Where the revision includes work committed to a new DBE subcontractor, not previously involved in the project, then a Request for Approval of Subcontractor, Department form BC 260A or AER 260A, must be signed and submitted. If the commitment of work is in the form of additional tasks assigned to an existing subcontract, a new Request for Approval of Subcontractor will not be required. However, the Contractor must document efforts to assure the existing DBE subcontractor is capable of performing the additional work and has agreed in writing to the change.
- (c) SUBCONTRACT. The Contractor must provide copies of DBE subcontracts to the Department upon request. Subcontractors shall ensure that all lower tier subcontracts or agreements with DBEs to supply labor or materials be performed in accordance with this Special Provision.
- (d) ALTERNATIVE WORK METHODS. In addition to the above requirements for reductions in the condition of award, additional requirements apply to the two cases of Contractor-initiated work substitution proposals. Where the contract allows alternate work methods which serve to delete or create underruns in condition of award DBE work, and the Contractor selects that alternate method or, where the Contractor proposes a substitute work method or material that serves to diminish or delete work committed to a DBE and replace it with other work, then the Contractor must demonstrate one of the following:
- (1) The replacement work will be performed by the same DBE (as long as the DBE is certified in the respective item of work) in a modification of the condition of award; or
 - (2) The DBE is aware its work will be deleted or will experience underruns and has agreed in writing to the change. If this occurs, the Contractor shall substitute other work of equivalent value to a certified DBE or provide documentation of good faith efforts to do so; or
 - (3) The DBE is not capable of performing the replacement work or has declined to perform the work at a reasonable competitive price. If this occurs, the Contractor shall substitute other work of equivalent value to a certified DBE or provide documentation of good faith efforts to do so.

(e) TERMINATION AND REPLACEMENT PROCEDURES. The Contractor shall not terminate or replace a DBE listed on the approved Utilization Plan, or perform with other forces work designated for a listed DBE except as provided in this Special Provision. The Contractor shall utilize the specific DBEs listed to perform the work and supply the materials for which each is listed unless the Contractor obtains the Department's written consent as provided in subsection (a) of this part. Unless Department consent is provided for termination of a DBE subcontractor, the Contractor shall not be entitled to any payment for work or material unless it is performed or supplied by the DBE in the Utilization Plan.

As stated above, the Contractor shall not terminate or replace a DBE subcontractor listed in the approved Utilization Plan without prior written consent. This includes, but is not limited to, instances in which the Contractor seeks to perform work originally designated for a DBE subcontractor with its own forces or those of an affiliate, a non-DBE firm, or with another DBE firm. Written consent will be granted only if the Bureau of Small Business Enterprises agrees, for reasons stated in its concurrence document, that the Contractor has good cause to terminate or replace the DBE firm. Before transmitting to the Bureau of Small Business Enterprises any request to terminate and/or substitute a DBE subcontractor, the Contractor shall give notice in writing to the DBE subcontractor, with a copy to the Bureau, of its intent to request to terminate and/or substitute, and the reason for the request. The Contractor shall give the DBE five days to respond to the Contractor's notice. The DBE so notified shall advise the Bureau and the Contractor of the reasons, if any, why it objects to the proposed termination of its subcontract and why the Bureau should not approve the Contractor's action. If required in a particular case as a matter of public necessity, the Bureau may provide a response period shorter than five days.

For purposes of this paragraph, good cause includes the following circumstances:

- (1) The listed DBE subcontractor fails or refuses to execute a written contract;
- (2) The listed DBE subcontractor fails or refuses to perform the work of its subcontract in a way consistent with normal industry standards. Provided, however, that good cause does not exist if the failure or refusal of the DBE subcontractor to perform its work on the subcontract results from the bad faith or discriminatory action of the Contractor;
- (3) The listed DBE subcontractor fails or refuses to meet the Contractor's reasonable, nondiscriminatory bond requirements;
- (4) The listed DBE subcontractor becomes bankrupt, insolvent, or exhibits credit unworthiness;
- (5) The listed DBE subcontractor is ineligible to work on public works projects because of suspension and debarment proceedings pursuant 2 CFR Parts 180, 215 and 1200 or applicable state law.

- (6) The Contractor has determined the listed DBE subcontractor is not a responsible contractor;
- (7) The listed DBE subcontractor voluntarily withdraws from the projects and provides written notice to the Contractor of its withdrawal;
- (8) The listed DBE is ineligible to receive DBE credit for the type of work required;
- (9) A DBE owner dies or becomes disabled with the result that the listed DBE subcontractor is unable to complete its work on the contract;
- (10) Other documented good cause that compels the termination of the DBE subcontractor. Provided, that good cause does not exist if the Contractor seeks to terminate a DBE it relied upon to obtain the contract so that the Contractor can self-perform the work for which the DBE contractor was engaged or so that the Contractor can substitute another DBE or non-DBE contractor after contract award.

When a DBE is terminated or fails to complete its work on the Contract for any reason, the Contractor shall make a good faith effort to find another DBE to substitute for the original DBE to perform at least the same amount of work under the contract as the terminated DBE to the extent needed to meet the established Contract goal. The good faith efforts shall be documented by the Contractor. If the Department requests documentation under this provision, the Contractor shall submit the documentation within seven days, which may be extended for an additional seven days if necessary at the request of the Contractor. The Department will provide a written determination to the Contractor stating whether or not good faith efforts have been demonstrated.

- (f) FINAL PAYMENT. After the performance of the final item of work or delivery of material by a DBE and final payment therefore to the DBE by the Contractor, but not later than 30 calendar days after payment has been made by the Department to the Contractor for such work or material, the Contractor shall submit a DBE Payment Agreement on Department form SBE 2115 to the Resident Engineer. If full and final payment has not been made to the DBE, the DBE Payment Agreement shall indicate whether a disagreement as to the payment required exists between the Contractor and the DBE or if the Contractor believes the work has not been satisfactorily completed. If the Contractor does not have the full amount of work indicated in the Utilization Plan performed by the DBE companies indicated in the Utilization Plan and after good faith efforts are reviewed, the Department may deduct from contract payments to the Contractor the amount of the goal not achieved as liquidated and ascertained damages. The Contractor may request an administrative reconsideration of any amount deducted as damages pursuant to subsection (h) of this part.
- (g) ENFORCEMENT. The Department reserves the right to withhold payment to the Contractor to enforce the provisions of this Special Provision. Final payment shall not be

made on the contract until such time as the Contractor submits sufficient documentation demonstrating achievement of the goal in accordance with this Special Provision or after liquidated damages have been determined and collected.

- (h) RECONSIDERATION. Notwithstanding any other provision of the contract, including but not limited to Article 109.09 of the Standard Specifications, the Contractor may request administrative reconsideration of a decision to deduct the amount of the goal not achieved as liquidated damages. A request to reconsider shall be delivered to the Contract Compliance Section and shall be handled and considered in the same manner as set forth in paragraph (c) of “Good Faith Effort Procedures” of this Special Provision, except a final decision that a good faith effort was not made during contract performance to achieve the goal agreed to in the Utilization Plan shall be the final administrative decision of the Department. The result of the reconsideration process is not administratively appealable to the U.S. Department of Transportation.

80029

DISPOSAL FEES (BDE)

Effective: November 1, 2018

Replace Articles 109.04(b)(5) – 109.04(b)(8) of the Standard Specifications with the following:

- “(5) Disposal Fees. When the extra work performed includes paying for disposal fees at a clean construction and demolition debris facility, an uncontaminated soil fill operation or a landfill, the Contractor shall receive, as administrative costs, an amount equal to five percent of the first \$10,000 and one percent of any amount over \$10,000 of the total approved costs of such fees.
- (6) Miscellaneous. No additional allowance will be made for general superintendence, the use of small tools, or other costs for which no specific allowance is herein provided.
- (7) Statements. No payment will be made for work performed on a force account basis until the Contractor has furnished the Engineer with itemized statements of the cost of such force account work. Statements shall be accompanied and supported by invoices for all materials used and transportation charges. However, if materials used on the force account work are not specifically purchased for such work but are taken from the Contractor’s stock, then in lieu of the invoices, the Contractor shall furnish an affidavit certifying that such materials were taken from his/her stock, that the quantity claimed was actually used, and that the price and transportation claimed represent the actual cost to the Contractor.

Itemized statements at the cost of force account work shall be detailed as follows.

- a. Name, classification, date, daily hours, total hours, rate, and extension for each laborer and foreman. Payrolls shall be submitted to substantiate actual wages paid if so requested by the Engineer.
 - b. Designation, dates, daily hours, total hours, rental rate, and extension for each unit of machinery and equipment.
 - c. Quantities of materials, prices and extensions.
 - d. Transportation of materials.
 - e. Cost of property damage, liability and workmen’s compensation insurance premiums, unemployment insurance contributions, and social security tax.
- (8) Work Performed by an Approved Subcontractor. When extra work is performed by an approved subcontractor, the Contractor shall receive, as administrative costs, an amount equal to five percent of the total approved costs of such work with the minimum payment being \$100.

- (9) All statements of the cost of force account work shall be furnished to the Engineer not later than 60 days after receipt of the Central Bureau of Construction form "Extra Work Daily Report". If the statement is not received within the specified time frame, all demands for payment for the extra work are waived and the Department is released from any and all such demands. It is the responsibility of the Contractor to ensure that all statements are received within the specified time regardless of the manner or method of delivery."

80402

EQUIPMENT PARKING AND STORAGE (BDE)

Effective: November 1, 2017

Replace the first paragraph of Article 701.11 of the Standard Specifications with the following.

“701.11 Equipment Parking and Storage. During working hours, all vehicles and/or nonoperating equipment which are parked, two hours or less, shall be parked at least 8 ft (2.5 m) from the open traffic lane. For other periods of time during working and for all nonworking hours, all vehicles, materials, and equipment shall be parked or stored as follows.

- (a) When the project has adequate right-of-way, vehicles, materials, and equipment shall be located a minimum of 30 ft (9 m) from the pavement.
- (b) When adequate right-of-way does not exist, vehicles, materials, and equipment shall be located a minimum of 15 ft (4.5 m) from the edge of any pavement open to traffic.
- (c) Behind temporary concrete barrier, vehicles, materials, and equipment shall be located a minimum of 24 in. (600 mm) behind free standing barrier or a minimum of 6 in. (150 mm) behind barrier that is either pinned or restrained according to Article 704.04. The 24 in. or 6 in. measurement shall be from the base of the non-traffic side of the barrier.
- (d) Behind other man-made or natural barriers meeting the approval of the Engineer.”

80388

HOT-MIX ASPHALT - DENSITY TESTING OF LONGITUDINAL JOINTS (BDE)

Effective: January 1, 2010

Revised: August 1, 2018

Description. This work shall consist of testing the density of longitudinal joints as part of the quality control/quality assurance (QC/QA) of hot-mix asphalt (HMA). Work shall be according to Section 1030 of the Standard Specifications except as follows.

Quality Control/Quality Assurance (QC/QA). Delete the second and third sentence of the third paragraph of Article 1030.05(d)(3) of the Standard Specifications.

Add the following paragraphs to the end of Article 1030.05(d)(3) of the Standard Specifications:

“Longitudinal joint density testing shall be performed at each random density test location. Longitudinal joint testing shall be located at a distance equal to the lift thickness or a minimum of 4 in. (100 mm), from each pavement edge. (i.e. for a 5 in. (125 mm) lift the near edge of the density gauge or core barrel shall be within 5 in. (125 mm) from the edge of pavement.) Longitudinal joint density testing shall be performed using either a correlated nuclear gauge or cores.

- a. Confined Edge. Each confined edge density shall be represented by a one-minute nuclear density reading or a core density and shall be included in the average of density readings or core densities taken across the mat which represents the Individual Test.
- b. Unconfined Edge. Each unconfined edge joint density shall be represented by an average of three one-minute density readings or a single core density at the given density test location and shall meet the density requirements specified herein. The three one-minute readings shall be spaced 10 ft (3 m) apart longitudinally along the unconfined pavement edge and centered at the random density test location.

When a longitudinal joint sealant (LJS) is applied, longitudinal joint density testing will not be required on the joint(s) sealed.”

Revise the Density Control Limits table in Article 1030.05(d)(4) of the Standard Specifications to read:

“Mixture Composition	Parameter	Individual Test (includes confined edges)	Unconfined Edge Joint Density Minimum
IL-4.75	Ndesign = 50	93.0 – 97.4% ^{1/}	91.0%
IL-9.5	Ndesign = 90	92.0 – 96.0%	90.0%
IL-9.5,IL-9.5L	Ndesign < 90	92.5 – 97.4%	90.0%
IL-19.0	Ndesign = 90	93.0 – 96.0%	90.0%
IL-19.0, IL-19.0L	Ndesign < 90	93.0 ^{2/} – 97.4%	90.0%

SMA	Ndesign = 50 & 80	93.5 – 97.4%	91.0%”
-----	-------------------	--------------	--------

80246

HOT-MIX ASPHALT – LONGITUDINAL JOINT SEALANT (BDE)

Effective: August 1, 2018

Revised: January 1, 2019

Add the following to Article 406.02 of the Standard Specifications.

“(d) Longitudinal Joint Sealant (LJS)1032”

Add the following to Article 406.03 of the Standard Specifications.

“(k) Longitudinal Joint Sealant (LJS) Pressure Distributor (Note 2)

(l) Longitudinal Joint Sealant (LJS) Melter Kettle (Note 3)

Note 2. When a pressure distributor is used to apply the LJS, the distributor shall be equipped with a heating and recirculating system along with a functioning auger agitating system or vertical shaft mixer in the hauling tank to prevent localized overheating. The distributor shall be equipped with a guide or laser system to aid in proper placement of the LJS application.

Note 3. When a melter kettle is used to transport and apply the LJS, the melter kettle shall be an oil jacketed double-boiler with agitating and recirculating systems. Material from the kettle may be dispensed through a pressure feed wand with an applicator shoe or through a pressure feed wand into a hand-operated thermal push cart.”

Revise Article 406.06(g)(2) of the Standard Specifications to read:

“(2) Longitudinal Joints. Unless prohibited by stage construction, any HMA lift shall be complete before construction of the subsequent lift. The longitudinal joint in all lifts shall be at the centerline of the pavement if the roadway comprises two lanes in width, or at lane width if the roadway is more than two lanes in width.

When stage construction prohibits the total completion of a particular lift, the longitudinal joint in one lift shall be offset from the longitudinal joint in the preceding lift by not less than 3 in. (75 mm). The longitudinal joint in the surface course shall be at the centerline of the pavement if the roadway comprises two lanes in width, or at lane width if the roadway is more than two lanes in width.

A notched wedge longitudinal joint shall be used between successive passes of HMA binder course that has a difference in elevation of greater than 2 in. (50 mm) between lanes on pavement that is open to traffic.

The notched wedge longitudinal joint shall consist of a 1 to 1 1/2 in. (25 to 38 mm) vertical notch at the lane line, a 9 to 12 in. (230 to 300 mm) wide uniform taper sloped toward and extending into the open lane, and a second 1 to 1 1/2 in. (25 to 38 mm) vertical notch at the outside edge.

The notched wedge longitudinal joint shall be formed by the strike off device on the paver. The wedge shall then be compacted by the joint roller.

Tack coat shall be applied to the entire surface of the notched wedge joint immediately prior to placing the adjacent lift of binder. The material shall be uniformly applied at a rate of 0.05 to 0.1 gal/sq yd (0.2 to 0.5 L/sq m).

When the use of LJS is specified, it shall be applied for the lift(s) of paving as shown on the plans. The surface to which the LJS is applied shall be dry and cleaned of all dust, debris, and any substances that will prevent the LJS from adhering. Cleaning shall be accomplished by means of a sweeper/vacuum truck, power broom, air compressor or by hand. The LJS may be placed before or after the tack or prime coat. When placed after the tack or prime coat, the tack or prime shall be fully cured prior to placement of the LJS.

The LJS shall be centered ± 2 in. (± 50 mm) under the joint of the next HMA lift to be constructed.

The width and minimum application rate of LJS shall be according to the following table.

LJS Application Table		
Overlay Thickness in. (mm)	LJS Width in. (mm)	Application Rate ^{1/} lb/ft (kg/m)
HMA Mixtures		
3/4 (19)	18 (450)	0.88 (1.31)
1 (25)	18 (450)	1.15 (1.71)
1 1/4 (32)	18 (450)	1.31 (1.95)
1 1/2 (38)	18 (450)	1.47 (2.19)
1 3/4 (44)	18 (450)	1.63 (2.43)
2 (50)	18 (450)	1.80 (2.68)
2 1/4 (60)	18 (450)	1.96 (2.92)
2 1/2 (63)	18 (450)	2.12 (3.16)
2 3/4 (70)	18 (450)	2.29 (3.41)
3 (75)	18 (450)	2.45 (3.65)
3 1/4 (83)	18 (450)	2.61 (3.89)
3 1/2 (90)	18 (450)	2.78 (4.14)
3 3/4 (95)	18 (450)	2.94 (4.38)
4 (100)	18 (450)	3.10 (4.62)
SMA Mixtures		
1 1/2 (38)	18 (450)	1.26 (1.88)
1 3/4 (44)	18 (450)	1.38 (2.06)

2 (50)	18 (450)	1.51 (2.25)
--------	----------	-------------

- 1/ The application rate has a surface demand for liquid included within it. The thickness of the LJS may taper from the center of the application to a lesser thickness on the edge of the application, provided the correct width and application rate are maintained.

The Contractor shall furnish to the Engineer a bill of lading for each tanker supplying material to the project. The application rate of LJS shall be verified within the first 1000 ft (300 m) of the day's scheduled application length and every 12,000 ft (3600 m) the remainder of the day. For projects less than 3000 ft (900 m), the rate shall be verified once. A suitable paper or pan shall be placed at a random location in the path of the LJS. After application of the LJS, the paper or pan shall be picked up, weighed, and the application rate calculated. The tolerance between the application rate shown in the LJS Application Table and the calculated rate shall be ± 15 percent. The Contractor shall replace the LJS in the area where the sample was taken.

A 1 qt (1 L) sample shall be taken from the pressure distributor or melting kettle at the jobsite once for each contract and sent to the Central Bureau of Materials.

The LJS shall be applied in a single pass with a pressure distributor, melter kettle, or hand applied from a roll for HMA lifts up to 2 in. (50 mm) in thickness. The LJS shall be applied in two passes for HMA lifts between 2 and 4 in. (50 and 100 mm) in thickness. At the time of installation, the pavement surface temperature and the ambient temperature shall be a minimum of 40 °F (4 °C) and rising.

The LJS shall be applied at a width of not less than or greater than 1 1/2 in. (38 mm) of the width specified. If the LJS flows more than 2 in. (50 mm) from the initial placement width, LJS placement shall stop and remedial action shall be taken.

When starting another run of LJS placement, suitable release paper shall be placed over the previous application of LJS to prevent doubling up of thickness of LJS.

The LJS shall be suitable for construction traffic to drive on without pickup or tracking of the LJS within 30 minutes of placement. If pickup or tracking occurs, LJS placement shall stop and damaged areas shall be repaired.

Prior to paving, the Contractor shall ensure the paver end plate and grade control device is adequately raised above the finished height of the LJS.

The LJS shall not flush to the final surface of the HMA pavement."

Add the following paragraph after the second paragraph of Article 406.13(b) of the Standard Specifications.

“Application of longitudinal joint sealant (LJS) will be measured for payment in place in feet (meters).”

Add the following paragraph after the first paragraph of Article 406.14 of the Standard Specifications.

“Longitudinal joint sealant will be paid for at the contract unit price per foot (meter) for LONGITUDINAL JOINT SEALANT.”

Add the following to Section 1032 of the Standard Specifications.

“1032.12 Longitudinal Joint Sealant (LJS). Longitudinal joint sealant (LJS) will be accepted according to the current Bureau of Materials and Physical Research Policy Memorandum, “Performance Graded Asphalt Binder Acceptance Procedure” with the following exceptions: Article 3.1.9 and 3.4.1.4 of the policy memorandum will be excluded. The bituminous material used for the LJS shall be according to the following table. Elastomers shall be added to a base asphalt and shall be either a styrene-butadiene diblock or triblock copolymer without oil extension, or a styrene-butadiene rubber. Air blown asphalt, acid modification, or other modifiers will not be allowed. LJS in the form of pre-formed rollout banding may also be used.

Test	Test Requirement	Test Method
Dynamic shear @ 88°C (unaged), G*/sin δ, kPa	1.00 min.	AASHTO T 315
Creep stiffness @ -18°C (unaged), Stiffness (S), MPa m-value	300 max. 0.300 min.	AASHTO T 313
Ash, %	1.0 – 4.0	AASHTO T 111
Elastic Recovery, 100 mm elongation, cut immediately, 25°C, %	70 min.	ASTM D 6084 (Procedure A)
Separation of Polymer, Difference in °C of the softening point (ring and ball)	3 max.	ITP Separation of Polymer from Asphalt Binder”

80398

HOT-MIX ASPHALT – OSCILLATORY ROLLER (BDE)

Effective: August 1, 2018
 Revised: November 1, 2018

Add the following to Article 406.03 of the Standard Specifications:

“(j) Oscillatory Roller 1101.01”

Revise Table 1 and Note 3/ of Table 1 in Article 406.07(a) of the Standard Specifications to read:

“TABLE 1 - MINIMUM ROLLER REQUIREMENTS FOR HMA				
	Breakdown Roller (one of the following)	Intermediate Roller	Final Roller (one or more of the following)	Density Requirement
Level Binder: (When the density requirements of Article 406.05(c) do not apply.)	P ^{3/}	--	V _S , P ^{3/} , T _B , T _F , 3W, O _T	To the satisfaction of the Engineer.
Binder and Surface ^{1/} Level Binder ^{1/} : (When the density requirements of Article 406.05(c) apply.)	V _D , P ^{3/} , T _B , 3W, O _T , O _B	P ^{3/} , O _T , O _B	V _S , T _B , T _F , O _T	As specified in Articles: 1030.05(d)(3), (d)(4), and (d)(7).
IL-4.75 and SMA ^{4/5/}	T _B , 3W, O _T	--	T _F , 3W, O _T	
Bridge Decks ^{2/}	T _B	--	T _F	As specified in Articles 582.05 and 582.06.

3/ A vibratory roller (V_D) or oscillatory roller (O_T or O_B) may be used in lieu of the pneumatic-tired roller on mixtures containing polymer modified asphalt binder.”

Add the following to EQUIPMENT DEFINITION in Article 406.07(a) contained in the Errata of the Supplemental Specifications:

“O_T - Oscillatory roller, tangential impact mode. Maximum speed is 3.0 mph (4.8 km/h) or 264 ft/min (80 m/min).

O_B - Oscillatory roller, tangential and vertical impact mode, operated at a speed to produce not less than 10 vertical impacts/ft (30 impacts/m).”

Add the following to Article 1101.01 of the Standard Specifications:

“(h) Oscillatory Roller. The oscillatory roller shall be self-propelled and provide a smooth operation when starting, stopping, or reversing directions. The oscillatory roller shall be able to operate in a mode that will provide tangential impact force with or without vertical impact force by using at least one drum. The oscillatory roller shall be equipped with water tanks and sprinkling devices, or other approved methods, which shall be used to wet the drums to prevent material pickup. The drum(s) amplitude and frequency of the tangential and vertical impact force shall be approximately the same in each direction and meet the following requirements:

- (1) The minimum diameter of the drum(s) shall be 42 in. (1070 mm)48 in. (1200 mm);
- (2) The minimum length of the drum(s) shall be 57 in. (1480 mm)66 in. (1650 mm);
- (3) The minimum unit static force on the drum(s) shall be 125 lb/in. (22 N/m); and
- (4) The minimum force on the oscillatory drum shall be 18,000 lb (80 kN).”; and
- (5) Self-adjusting eccentrics, and reversible eccentrics on non-driven drum(s).”

80399

HOT-MIX ASPHALT – TACK COAT (BDE)

Effective: November 1, 2016

Revise Article 1032.06(a) of the Standard Specifications to read:

“(a) Anionic Emulsified Asphalt. Anionic emulsified asphalts shall be according to AASHTO M 140. SS-1h emulsions used as a tack coat shall have the cement mixing test waived.”

80376

LIGHTS ON BARRICADES (BDE)

Effective: January 1, 2018

Revise Article 701.16 of the Standard Specifications to read:

“701.16 Lights. Lights shall be used on devices as required in the plans, the traffic control plan, and the following table.

Circumstance	Lights Required
Daylight operations	None
First two warning signs on each approach to the work involving a nighttime lane closure and “ROUGH GROOVED SURFACE” (W8-I107) signs	Flashing mono-directional lights
Devices delineating isolated obstacles, excavations, or hazards at night (Does not apply to patching)	Flashing bi-directional lights
Devices delineating obstacles, excavations, or hazards exceeding 100 ft (30 m) in length at night (Does not apply to widening)	Steady burn bi-directional lights
Channelizing devices for nighttime lane closures on two-lane roads	None
Channelizing devices for nighttime lane closures on multi-lane roads	None
Channelizing devices for nighttime lane closures on multi-lane roads separating opposing directions of traffic	None
Channelizing devices for nighttime along lane shifts on multilane roads	Steady burn mono-directional lights
Channelizing devices for night time along lane shifts on two lane roads	Steady burn bi-directional lights
Devices in nighttime lane closure tapers on Standards 701316 and 701321	Steady burn bi-directional lights
Devices in nighttime lane closure tapers	Steady burn mono-directional lights
Devices delineating a widening trench	None
Devices delineating patches at night on roadways with an ADT less than 25,000	None
Devices delineating patches at night on roadways with an ADT of 25,000 or more	None

Batteries for the lights shall be replaced on a group basis at such times as may be specified by the Engineer.”

Delete the fourth sentence of the first paragraph of Article 701.17(c)(2) of the Standard Specifications.

Revise the first paragraph of Article 603.07 of the Standard Specifications to read:

“603.07 Protection Under Traffic. After the casting has been adjusted and Class SI concrete has been placed, the work shall be protected by a barricade for at least 72 hours.”

80392

PAYMENTS TO SUBCONTRACTORS (BDE)

Effective: November 2, 2017

Add the following to the end of the fourth paragraph of Article 109.11 of the Standard Specifications:

“If reasonable cause is asserted, written notice shall be provided to the applicable subcontractor and/or material supplier and the Engineer within five days of the Contractor receiving payment. The written notice shall identify the contract number, the subcontract or material purchase agreement, a detailed reason for refusal, the value of payment being withheld, and the specific remedial actions required of the subcontractor and/or material supplier so that payment can be made.”

80390

PORTLAND CEMENT CONCRETE (BDE)

Effective: November 1, 2017

Revise the Air Content % of Class PP Concrete in Table 1 Classes of Concrete and Mix Design Criteria in Article 1020.04 of the Standard Specifications to read:

"TABLE 1. CLASSES OF CONCRETE AND MIX DESIGN CRITERIA		
Class of Conc.	Use	Air Content %
PP	Pavement Patching Bridge Deck Patching (10)	4.0 - 8.0"
	PP-1	
	PP-2	
	PP-3	
	PP-4	
	PP-5	

Revise Note (4) at the end of Table 1 Classes of Concrete and Mix Design Criteria in Article 1020.04 of the Standard Specifications to read:

“(4) For all classes of concrete, the maximum slump may be increased to 7 in (175 mm) when a high range water-reducing admixture is used. For Class SC, the maximum slump may be increased to 8 in. (200 mm). For Class PS, the maximum slump may be increased to 8 1/2 in. (215 mm) if the high range water-reducing admixture is the polycarboxylate type.”

80389

PROGRESS PAYMENTS (BDE)

Effective: November 2, 2013

Revise Article 109.07(a) of the Standard Specifications to read:

“(a) Progress Payments. At least once each month, the Engineer will make a written estimate of the quantity of work performed in accordance with the contract, and the value thereof at the contract unit prices. The amount of the estimate approved as due for payment will be vouchered by the Department and presented to the State Comptroller for payment. No amount less than \$1000.00 will be approved for payment other than the final payment.

Progress payments may be reduced by liens filed pursuant to Section 23(c) of the Mechanics' Lien Act, 770 ILCS 60/23(c).

If a Contractor or subcontractor has defaulted on a loan issued under the Department's Disadvantaged Business Revolving Loan Program (20 ILCS 2705/2705-610), progress payments may be reduced pursuant to the terms of that loan agreement. In such cases, the amount of the estimate related to the work performed by the Contractor or subcontractor, in default of the loan agreement, will be offset, in whole or in part, and vouchered by the Department to the Working Capital Revolving Fund or designated escrow account. Payment for the work shall be considered as issued and received by the Contractor or subcontractor on the date of the offset voucher. Further, the amount of the offset voucher shall be a credit against the Department's obligation to pay the Contractor, the Contractor's obligation to pay the subcontractor, and the Contractor's or subcontractor's total loan indebtedness to the Department. The offset shall continue until such time as the entire loan indebtedness is satisfied. The Department will notify the Contractor and Fund Control Agent in a timely manner of such offset. The Contractor or subcontractor shall not be entitled to additional payment in consideration of the offset.

The failure to perform any requirement, obligation, or term of the contract by the Contractor shall be reason for withholding any progress payments until the Department determines that compliance has been achieved.”

80328

RECLAIMED ASPHALT PAVEMENT AND RECLAIMED ASPHALT SHINGLES (BDE)

Effective: November 1, 2012

Revise: January 1, 2019

Revise Section 1031 of the Standard Specifications to read:

“SECTION 1031. RECLAIMED ASPHALT PAVEMENT AND RECLAIMED ASPHALT SHINGLES

1031.01 Description. Reclaimed asphalt pavement and reclaimed asphalt shingles shall be according to the following.

- (a) Reclaimed Asphalt Pavement (RAP). RAP is the material produced by cold milling or crushing an existing hot-mix asphalt (HMA) pavement. The Contractor shall supply written documentation that the RAP originated from routes or airfields under federal, state, or local agency jurisdiction.
- (b) Reclaimed Asphalt Shingles (RAS). Reclaimed asphalt shingles (RAS). RAS is from the processing and grinding of preconsumer or post-consumer shingles. RAS shall be a clean and uniform material with a maximum of 0.5 percent unacceptable material, as defined in Central Bureau of Materials Policy Memorandum, “Reclaimed Asphalt Shingle (RAS) Sources”, by weight of RAS. All RAS used shall come from a Central Bureau of Materials approved processing facility where it shall be ground and processed to 100 percent passing the 3/8 in. (9.5 mm) sieve and 93 percent passing the #4 (4.75 mm) sieve based on a dry shake gradation. RAS shall be uniform in gradation and asphalt binder content and shall meet the testing requirements specified herein. In addition, RAS shall meet the following Type 1 or Type 2 requirements.
 - (1) Type 1. Type 1 RAS shall be processed, preconsumer asphalt shingles salvaged from the manufacture of residential asphalt roofing shingles.
 - (2) Type 2. Type 2 RAS shall be processed post-consumer shingles only, salvaged from residential, or four unit or less dwellings not subject to the National Emission Standards for Hazardous Air Pollutants (NESHAP).

1031.02 Stockpiles. RAP and RAS stockpiles shall be according to the following.

- (a) RAP Stockpiles. The Contractor shall construct individual, sealed RAP stockpiles meeting one of the following definitions. No additional RAP shall be added to the pile after the pile has been sealed. Stockpiles shall be sufficiently separated to prevent intermingling at the base. Stockpiles shall be identified by signs indicating the type as listed below (i.e. “Homogeneous Surface”).

Prior to milling, the Contractor shall request the District provide documentation on the quality of the RAP to clarify the appropriate stockpile.

- (1) Fractionated RAP (FRAP). FRAP shall consist of RAP from Class I, HMA (High and Low ESAL) mixtures. The coarse aggregate in FRAP shall be crushed aggregate and may represent more than one aggregate type and/or quality, but shall be at least C quality. All FRAP shall be fractionated prior to testing by screening into a minimum of two size fractions with the separation occurring on or between the #4 (4.75 mm) and 1/2 in. (12.5 mm) sieves. Agglomerations shall be minimized such that 100 percent of the RAP shall pass the sieve size specified below for the mix into which the FRAP will be incorporated.

Mixture FRAP will be used in:	Sieve Size that 100 % of FRAP Shall Pass
IL-19.0	1 1/2 in. (40 mm)
IL-9.5	3/4 in. (20 mm)
IL-4.75	1/2 in. (13 mm)

- (2) Homogeneous. Homogeneous RAP stockpiles shall consist of RAP from Class I, HMA (High and Low ESAL) mixtures and represent: 1) the same aggregate quality, but shall be at least C quality; 2) the same type of crushed aggregate (either crushed natural aggregate, ACBF slag, or steel slag); 3) similar gradation; and 4) similar asphalt binder content. If approved by the Engineer, combined single pass surface/binder millings may be considered “homogeneous” with a quality rating dictated by the lowest coarse aggregate quality present in the mixture.
- (3) Conglomerate. Conglomerate RAP stockpiles shall consist of RAP from Class I, HMA (High and Low ESAL) mixtures. The coarse aggregate in this RAP shall be crushed aggregate and may represent more than one aggregate type and/or quality, but shall be at least C quality. This RAP may have an inconsistent gradation and/or asphalt binder content prior to processing. All conglomerate RAP shall be processed prior to testing by crushing to where all RAP shall pass the 5/8 in. (16 mm) or smaller screen. Conglomerate RAP stockpiles shall not contain steel slag.
- (4) Non-Quality. RAP stockpiles that do not meet the requirements of the stockpile categories listed above shall be classified as “Non-Quality”.

RAP/FRAP containing contaminants, such as earth, brick, sand, concrete, sheet asphalt, bituminous surface treatment (i.e. chip seal), pavement fabric, joint sealants, etc., will be unacceptable unless the contaminants are removed to the satisfaction of the Engineer. Sheet asphalt shall be stockpiled separately.

- (b) RAS Stockpiles. Type 1 and Type 2 RAS shall be stockpiled separately and shall not be intermingled. Each stockpile shall be signed indicating what type of RAS is present.

Unless otherwise specified by the Engineer, mechanically blending manufactured sand (FM 20 or FM 22) up to an equal weight of RAS with the processed RAS will be permitted to improve workability. The sand shall be “B Quality” or better from an

approved Aggregate Gradation Control System source. The sand shall be accounted for in the mix design and during HMA production.

Records identifying the shingle processing facility supplying the RAS, RAS type, and lot number shall be maintained by project contract number and kept for a minimum of three years.

1031.03 Testing. RAP/FRAP and RAS testing shall be according to the following.

(a) RAP/FRAP Testing. When used in HMA, the RAP/FRAP shall be sampled and tested either during or after stockpiling.

(1) During Stockpiling. For testing during stockpiling, washed extraction samples shall be run at the minimum frequency of one sample per 500 tons (450 metric tons) for the first 2000 tons (1800 metric tons) and one sample per 2000 tons (1800 metric tons) thereafter. A minimum of five tests shall be required for stockpiles less than 4000 tons (3600 metric tons).

(2) After Stockpiling. For testing after stockpiling, the Contractor shall submit a plan for approval to the District proposing a satisfactory method of sampling and testing the RAP/FRAP pile either in-situ or by restockpiling. The sampling plan shall meet the minimum frequency required above and detail the procedure used to obtain representative samples throughout the pile for testing.

Each sample shall be split to obtain two equal samples of test sample size. One of the two test samples from the final split shall be labeled and stored for Department use. The Contractor shall extract the other test sample according to Department procedure. The Engineer reserves the right to test any sample (split or Department-taken) to verify Contractor test results.

(b) RAS Testing. RAS or RAS blended with manufactured sand shall be sampled and tested during stockpiling according to Central Bureau of Materials Policy Memorandum, "Reclaimed Asphalt Shingle (RAS) Source".

Samples shall be collected during stockpiling at the minimum frequency of one sample per 200 tons (180 metric tons) for the first 1000 tons (900 metric tons) and one sample per 250 tons (225 metric tons) thereafter. A minimum of five samples are required for stockpiles less than 1000 tons (900 metric tons). Once a ≤ 1000 ton (900 metric ton), five-sample/test stockpile has been established it shall be sealed. Additional incoming RAS or RAS blended with manufactured sand shall be stockpiled in a separate working pile as designated in the Quality Control plan and only added to the sealed stockpile when the test results of the working pile are complete and are found to meet the tolerances specified herein for the original sealed RAS stockpile.

Before testing, each sample shall be split to obtain two test samples. One of the two test samples from the final split shall be labeled and stored for Department use. The

Contractor shall perform a washed extraction and test for unacceptable materials on the other test sample according to Department procedures. The Engineer reserves the right to test any sample (split or Department-taken) to verify Contractor test results.

If the sampling and testing was performed at the shingle processing facility in accordance with the QC Plan, the Contractor shall obtain and make available all of the test results from start of the initial stockpile.

1031.04 Evaluation of Tests. Evaluation of test results shall be according to the following.

- (a) Evaluation of RAP/FRAP Test Results. All of the extraction results shall be compiled and averaged for asphalt binder content and gradation, and when applicable G_{mm} . Individual extraction test results, when compared to the averages, will be accepted if within the tolerances listed below.

Parameter	FRAP/Homogeneous/ Conglomerate
1 in. (25 mm)	
1/2 in. (12.5 mm)	± 8 %
No. 4 (4.75 mm)	± 6 %
No. 8 (2.36 mm)	± 5 %
No. 16 (1.18 mm)	
No. 30 (600 µm)	± 5 %
No. 200 (75 µm)	± 2.0 %
Asphalt Binder	± 0.4 % ^{1/}
G_{mm}	± 0.03

1/ The tolerance for FRAP shall be ± 0.3 %.

If more than 20 percent of the individual sieves and/or asphalt binder content tests are out of the above tolerances, the RAP/FRAP shall not be used in HMA unless the RAP/FRAP representing the failing tests is removed from the stockpile. All test data and acceptance ranges shall be sent to the District for evaluation.

With the approval of the Engineer, the ignition oven may be substituted for extractions according to the ITP, "Calibration of the Ignition Oven for the Purpose of Characterizing Reclaimed Asphalt Pavement (RAP)".

- (b) Evaluation of RAS and RAS Blended with Manufactured Sand Test Results. All of the test results, with the exception of percent unacceptable materials, shall be compiled and averaged for asphalt binder content and gradation. Individual test results, when compared to the averages, will be accepted if within the tolerances listed below.

Parameter	RAS
No. 8 (2.36 mm)	± 5 %

No. 16 (1.18 mm)	± 5 %
No. 30 (600 µm)	± 4 %
No. 200 (75 µm)	± 2.0 %
Asphalt Binder Content	± 1.5 %

If more than 20 percent of the individual sieves and/or asphalt binder content tests are out of the above tolerances, or if the percent unacceptable material exceeds 0.5 percent by weight of material retained on the # 4 (4.75 mm) sieve, the RAS or RAS blend shall not be used in Department projects. All test data and acceptance ranges shall be sent to the District for evaluation.

1031.05 Quality Designation of Aggregate in RAP/FRAP.

(a) RAP. The aggregate quality of the RAP for homogeneous and conglomerate stockpiles shall be set by the lowest quality of coarse aggregate in the RAP stockpile and are designated as follows.

(1) RAP from Class I, Superpave/HMA (High ESAL), or (Low ESAL) IL-9.5L surface mixtures are designated as containing Class B quality coarse aggregate.

(2) RAP from Class I binder, Superpave/HMA (High ESAL) binder, or (Low ESAL) IL-19.0L binder mixtures are designated as containing Class C quality coarse aggregate.

(b) FRAP. If the Engineer has documentation of the quality of the FRAP aggregate, the Contractor shall use the assigned quality provided by the Engineer.

If the quality is not known, the quality shall be determined as follows. Coarse and fine FRAP stockpiles containing plus #4 (4.75 mm) sieve coarse aggregate shall have a maximum tonnage of 5000 tons (4500 metric tons). The Contractor shall obtain a representative sample witnessed by the Engineer. The sample shall be a minimum of 50 lb (25 kg). The sample shall be extracted according to Illinois Modified AASHTO T 164 by a consultant laboratory prequalified by the Department for the specified testing. The consultant laboratory shall submit the test results along with the recovered aggregate to the District Office. The cost for this testing shall be paid by the Contractor. The District will forward the sample to the Central Bureau of Materials Aggregate Lab for MicroDeval Testing, according to ITP 327. A maximum loss of 15.0 percent will be applied for all HMA applications.

1031.06 Use of RAP/FRAP and/or RAS in HMA. The use of RAP/FRAP and/or RAS shall be the Contractor’s option when constructing HMA in all contracts.

(a) RAP/FRAP. The use of RAP/FRAP in HMA shall be as follows.

(1) Coarse Aggregate Size. The coarse aggregate in all RAP shall be equal to or less than the nominal maximum size requirement for the HMA mixture to be produced.

- (2) Steel Slag Stockpiles. Homogeneous RAP stockpiles containing steel slag will be approved for use in all HMA (High ESAL and Low ESAL) Surface and Binder Mixture applications.
- (3) Use in HMA Surface Mixtures (High and Low ESAL). RAP/FRAP stockpiles for use in HMA surface mixtures (High and Low ESAL) shall be FRAP or homogeneous in which the coarse aggregate is Class B quality or better. FRAP from Conglomerate stockpiles shall be considered equivalent to limestone for frictional considerations. Known frictional contributions from plus #4 (4.75 mm) homogeneous FRAP stockpiles will be accounted for in meeting frictional requirements in the specified mixture.
- (4) Use in HMA Binder Mixtures (High and Low ESAL), HMA Base Course, and HMA Base Course Widening. RAP/FRAP stockpiles for use in HMA binder mixtures (High and Low ESAL), HMA base course, and HMA base course widening shall be FRAP, homogeneous, or conglomerate, in which the coarse aggregate is Class C quality or better.
- (5) Use in Shoulders and Subbase. RAP/FRAP stockpiles for use in HMA shoulders and stabilized subbase (HMA) shall be FRAP, homogeneous, or conglomerate.
- (6) When the Contractor chooses the RAP option, the percentage of RAP shall not exceed the amounts indicated in Article 1031.06(c)(1) below for a given Ndesign.
- (b) RAS. RAS meeting Type 1 or Type 2 requirements will be permitted in all HMA applications as specified herein.
- (c) RAP/FRAP and/or RAS Usage Limits. Type 1 or Type 2 RAS may be used alone or in conjunction with RAP or FRAP in HMA mixtures up to a maximum of 5.0 percent by weight of the total mix.
- (1) RAP/RAS. When RAP is used alone or RAP is used in conjunction with RAS, the percentage of virgin asphalt binder replacement shall not exceed the amounts listed in the Max RAP/RAS ABR table listed below for the given Ndesign.

RAP/RAS Maximum Asphalt Binder Replacement (ABR) Percentage

HMA Mixtures <i>1/, 2/</i>	RAP/RAS Maximum ABR %		
	Binder/Leveling Binder	Surface	Polymer Modified
30	30	30	10
50	25	15	10
70	15	10	10
90	10	10	10

- 1/ For Low ESAL HMA shoulder and stabilized subbase, the RAP/RAS ABR shall not exceed 50 percent of the mixture.
 - 2/ When RAP/RAS ABR exceeds 20 percent, the high and low virgin asphalt binder grades shall each be reduced by one grade (i.e. 25 percent ABR would require a virgin asphalt binder grade of PG 64-22 to be reduced to a PG 58-28). If warm mix asphalt (WMA) technology is utilized and production temperatures do not exceed 275 °F (135 °C), the high and low virgin asphalt binder grades shall each be reduced by one grade when RAP/RAS ABR exceeds 25 percent (i.e. 26 percent RAP/RAS ABR would require a virgin asphalt binder grade of PG 64-22 to be reduced to a PG 58-28).
- (2) FRAP/RAS. When FRAP is used alone or FRAP is used in conjunction with RAS, the percentage of virgin asphalt binder replacement shall not exceed the amounts listed in the FRAP/RAS table listed below for the given Ndesign.

FRAP/RAS Maximum Asphalt Binder Replacement (ABR) Percentage

HMA Mixtures <i>1/, 2/</i>	FRAP/RAS Maximum ABR %						
	Ndesign	Binder/Leveling Binder		Surface		Polymer Modified	
		w/o I-FIT	with I-FIT	w/o I-FIT	with I-FIT	w/o I-FIT	with I-FIT
30	50	55	40	45	10	15	
50	40	45	35	40	10	15	
70	40	45	30	35	10	15	
90	40	45	30	35	10	15	
SMA	--	--	--	--	20	25	
IL-4.75	--	--	--	--	30	35	

- 1/ For Low ESAL HMA shoulder and stabilized subbase, the FRAP/RAS ABR shall not exceed 50 percent of the mixture.
- 2/ When FRAP/RAS ABR exceeds 20 percent for all mixes, the high and low virgin asphalt binder grades shall each be reduced by one grade (i.e. 25 percent ABR would require a virgin asphalt binder grade of PG 64-22 to be reduced to a PG 58-28). If warm mix asphalt (WMA) technology is utilized and production temperatures do not exceed 275 °F (135 °C), the high and low virgin asphalt binder grades shall each be reduced by one grade when FRAP/RAS ABR exceeds 25 percent (i.e. 26 percent ABR would require a virgin asphalt binder grade of PG 64-22 to be reduced to a PG 58-28).

1031.07 HMA Mix Designs. At the Contractor's option, HMA mixtures may be constructed utilizing RAP/FRAP and/or RAS material meeting the detailed requirements specified herein.

- (a) RAP/FRAP and/or RAS. RAP/FRAP and/or RAS mix designs shall be submitted for verification. If additional RAP/FRAP and/or RAS stockpiles are tested and found that no more than 20 percent of the results, as defined under “Testing” herein, are outside of the control tolerances set for the original RAP/FRAP and/or RAS stockpile and HMA mix design, and meets all of the requirements herein, the additional RAP/FRAP and/or RAS stockpiles may be used in the original mix design at the percent previously verified.
- (b) RAS. Type 1 and Type 2 RAS are not interchangeable in a mix design.

The RAP, FRAP, and RAS stone bulk specific gravities (G_{sb}) shall be according to the “Determination of Aggregate Bulk (Dry) Specific Gravity (G_{sb}) of Reclaimed Asphalt Pavement (RAP) and Reclaimed Asphalt Shingles (RAS)” procedure in the Department’s Manual of Test Procedures for Materials.

1031.08 HMA Production. HMA production utilizing RAP/FRAP and/or RAS shall be as follows.

- (a) RAP/FRAP. The coarse aggregate in all RAP/FRAP used shall be equal to or less than the nominal maximum size requirement for the HMA mixture being produced.

To remove or reduce agglomerated material, a scalping screen, gator, crushing unit, or comparable sizing device approved by the Engineer shall be used in the RAP feed system to remove or reduce oversized material.

If the RAP/FRAP control tolerances or QC/QA test results require corrective action, the Contractor shall cease production of the mixture containing RAP/FRAP and either switch to the virgin aggregate design or submit a new RAP/FRAP design.

- (b) RAS. RAS shall be incorporated into the HMA mixture either by a separate weight depletion system or by using the RAP weigh belt. Either feed system shall be interlocked with the aggregate feed or weigh system to maintain correct proportions for all rates of production and batch sizes. The portion of RAS shall be controlled accurately to within ± 0.5 percent of the amount of RAS utilized. When using the weight depletion system, flow indicators or sensing devices shall be provided and interlocked with the plant controls such that the mixture production is halted when RAS flow is interrupted.

- (c) RAP/FRAP and/or RAS. HMA plants utilizing RAP/FRAP and/or RAS shall be capable of automatically recording and printing the following information.

(1) Dryer Drum Plants.

- a. Date, month, year, and time to the nearest minute for each print.
- b. HMA mix number assigned by the Department.

- c. Accumulated weight of dry aggregate (combined or individual) in tons (metric tons) to the nearest 0.1 ton (0.1 metric ton).
- d. Accumulated dry weight of RAP/FRAP/RAS in tons (metric tons) to the nearest 0.1 ton (0.1 metric ton).
- e. Accumulated mineral filler in revolutions, tons (metric tons), etc. to the nearest 0.1 unit.
- f. Accumulated asphalt binder in gallons (liters), tons (metric tons), etc. to the nearest 0.1 unit.
- g. Residual asphalt binder in the RAP/FRAP material as a percent of the total mix to the nearest 0.1 percent.
- h. Aggregate and RAP/FRAP moisture compensators in percent as set on the control panel. (Required when accumulated or individual aggregate and RAP/FRAP are printed in wet condition.)

(2) Batch Plants.

- a. Date, month, year, and time to the nearest minute for each print.
- b. HMA mix number assigned by the Department.
- c. Individual virgin aggregate hot bin batch weights to the nearest pound (kilogram).
- d. Mineral filler weight to the nearest pound (kilogram).
- e. RAP/FRAP/RAS weight to the nearest pound (kilogram).
- f. Virgin asphalt binder weight to the nearest pound (kilogram).
- g. Residual asphalt binder in the RAP/FRAP/RAS material as a percent of the total mix to the nearest 0.1 percent.

The printouts shall be maintained in a file at the plant for a minimum of one year or as directed by the Engineer and shall be made available upon request. The printing system will be inspected by the Engineer prior to production and verified at the beginning of each construction season thereafter.

1031.09 RAP in Aggregate Surface Course and Aggregate Wedge Shoulders, Type B.

The use of RAP in aggregate surface course (temporary access entrances only) and aggregate wedge shoulders, Type B shall be as follows.

- (a) Stockpiles and Testing. RAP stockpiles may be any of those listed in Article 1031.02, except “Non-Quality” and “FRAP”. The testing requirements of Article 1031.03 shall not apply. RAP used shall be according to the current Central Bureau of Materials Policy Memorandum, “Reclaimed Asphalt Pavement (RAP) for Aggregate Applications”.
- (b) Gradation. One hundred percent of the RAP material shall pass the 1 1/2 in. (37.5 mm) sieve. The RAP material shall be reasonably well graded from coarse to fine. RAP material that is gap-graded or single sized will not be accepted.”

80306

REMOVAL AND DISPOSAL OF REGULATED SUBSTANCES (BDE)

Effective: January 1, 2019

Revise Section 669 of the Standard Specifications to read:

“SECTION 669. REMOVAL AND DISPOSAL OF REGULATED SUBSTANCES

669.01 Description. This work shall consist of the transportation and proper disposal of contaminated soil and groundwater. This work shall also consist of the removal, transportation, and proper disposal of underground storage tanks (UST), their content and associated underground piping to the point where the piping is above the ground, including determining the content types and estimated quantities.

669.02 Equipment. The Contractor shall notify the Engineer of the delivery of all excavation, storage, and transportation equipment to a work area location. The equipment shall comply with OSHA and American Petroleum Institute (API) guidelines and shall be furnished in a clean condition. Clean condition means the equipment does not contain any residual material classified as a non-special waste, non-hazardous special waste, or hazardous waste. Residual materials include, but are not limited to, petroleum products, chemical products, sludges, or any other material present in or on equipment.

Before beginning any associated soil or groundwater management activity, the Contractor shall provide the Engineer with the opportunity to visually inspect and approve the equipment. If the equipment contains any contaminated residual material, decontamination shall be performed on the equipment as appropriate to the regulated substance and degree of contamination present according to OSHA and API guidelines. All cleaning fluids used shall be treated as the contaminant unless laboratory testing proves otherwise.

669.03 Pre-construction Submittals. Prior to beginning this work, or working in areas with regulated substances, the Contractor shall submit a Regulated Substance Pre-Construction Plan (RSPCP) to the Engineer for review and approval using form BDE 2730. The form shall be signed by an Illinois licensed Professional Engineer or Professional Geologist.

As part of the RSPCP, the qualifications of Contractor(s) or firm(s) performing the following work shall be listed.

- (a) On-Site Monitoring. Qualification for on-site monitoring of regulated substance work and on-site monitoring of UST removal requires either pre-qualification in Hazardous Waste by the Department or demonstration of acceptable project experience in remediation and special waste operations for contaminated sites in accordance with applicable Federal, State, or local regulatory requirements.

Qualification for each individual performing on-site monitoring requires a minimum of one-year of experience in similar activities as those required for the project.

(b) Underground Storage Tank. Qualification for underground storage tank (UST) work requires licensing and certification with the Office of the State Fire Marshall (OSFM) and possession of all permits required to perform the work. A copy of the permit shall be provided to the Engineer prior to tank removal.

The qualified Contractor(s) or firm(s) shall also document it does not have any current or former ties with any of the properties contained within, adjoining, or potentially affecting the work.

The Engineer will require up to 30 calendar days for review of the RSPCP. The review may involve rejection or revision and resubmittal; in which case, an additional 30 days will be required for each subsequent review. Work shall not commence until the RSPCP has been approved by the Engineer. After approval, the RSPCP shall be revised as necessary to reflect changed conditions in the field.

CONSTRUCTION REQUIREMENTS

669.04 Contaminated Soil and/or Groundwater Monitoring. Prior to beginning excavation, the Contractor shall mark the limits of removal for approval by the Engineer. Once excavation begins, the work and work area involving regulated substances shall be monitored by qualified personnel. The qualified personnel shall be on-site continuously during excavation and loading of material containing regulated substances. The qualified personnel shall be equipped with either a photoionization detector (PID) (minimum 10.6eV lamp), or a flame ionization detector (FID), and other equipment, as appropriate, to monitor for potential contaminants associated with volatile organic compounds (VOCs) or semi-volatile organic compounds (SVOCs). The PID or FID meter shall be calibrated on-site and background level readings taken and recorded daily, and as field and weather conditions change. Any field screen reading on the PID or FID in excess of background levels indicates the potential presence of contaminated material requiring handling as a non-special waste, special waste, or hazardous waste. PID or FID readings may be used as the basis of increasing the limits of removal with the approval of the Engineer but shall in no case be used to decrease the limits.

The qualified personnel shall document field activities using form BDE 2732 (Regulated Substances Monitoring Daily Record) including the name(s) of personnel conducting the monitoring, weather conditions, PID or FID calibration records, a list of equipment used on-site, a narrative of activities completed, photo log sheets, manifests and landfill tickets, monitoring results, how regulated substances were managed and other pertinent information.

Samples will be collected in accordance with the RSPCP. Samples shall be analyzed for the contaminants of concern (COCs), including pH, based on the property's land use history, the encountered abnormality and/or the parameters listed in the maximum allowable concentration (MAC) for chemical constituents in uncontaminated soil established pursuant to Subpart F of 35 Ill. Adm. Code 1100.605. The analytical results shall serve to document the level of contamination.

Samples shall be grab samples (not combined with other locations). The samples shall be taken with decontaminated or disposable instruments. The samples shall be placed in sealed containers and transported in an insulated container to the laboratory. The container shall maintain a temperature of 39 °F (4 °C). All samples shall be clearly labeled. The labels shall indicate the sample number, date sampled, collection location and depth, and any other relevant observations.

The laboratory shall use analytical methods which are able to meet the lowest appropriate practical quantitation limits (PQL) or estimated quantitation limit (EQL) specified in "Test Methods for Evaluating Solid Wastes, Physical/Chemical Methods", EPA Publication No. SW-846; "Methods for the Determination of Organic Compounds in Drinking Water", EPA, EMSL, EPA-600/4-88/039; and "Methods for the Determination of Organic Compounds in Drinking Water, Supplement III", EPA 600/R-95/131, August 1995. For parameters where the specified cleanup objective is below the acceptable detection limit (ADL), the ADL shall serve as the cleanup objective. For other parameters the ADL shall be equal to or below the specified cleanup objective.

669.05 Contaminated Soil and/or Groundwater Management and Disposal. The management and disposal of contaminated soil and/or groundwater shall be according to the following:

- (a) Soil Analytical Results Exceed Most Stringent MAC. When the soil analytical results indicate that detected levels exceed the most stringent maximum allowable concentration (MAC) for chemical constituents in uncontaminated soil established pursuant to Subpart F of 35 Illinois Administrative Code 1100.605, the soil shall be managed as follows:
 - (1) When analytical results indicate inorganic chemical constituents exceed the most stringent MAC but they are still considered within area background levels by the Engineer, the excavated soil can be utilized within the construction limits as fill, when suitable. If the soils cannot be utilized within the construction limits, they shall be managed and disposed of off-site as a non-special waste, special waste, or hazardous waste as applicable.
 - (2) When analytical results indicate chemical constituents exceed the most stringent MAC but do not exceed the MAC for a Metropolitan Statistical Area (MSA) County, the excavated soil can be utilized within the construction limits as fill, when suitable, or managed and disposed of off-site as "uncontaminated soil" at a clean construction and demolition debris (CCDD) facility or an uncontaminated soil fill operation (USFO) within an MSA County provided the pH of the soil is within the range of 6.25 - 9.0, inclusive.
 - (3) When analytical results indicate chemical constituents exceed the most stringent MAC but do not exceed the MAC for an MSA County excluding Chicago, or the MAC within the Chicago corporate limits, the excavated soil can be utilized within the construction limits as fill, when suitable, or managed and disposed of off-site as "uncontaminated soil" at a CCDD facility or an USFO within an MSA County excluding Chicago or within

the Chicago corporate limits provided the pH of the soil is within the range of 6.25 - 9.0, inclusive.

- (4) When analytical results indicate chemical constituents exceed the most stringent MAC but do not exceed the MAC for an MSA County excluding Chicago, the excavated soil can be utilized within the construction limits as fill, when suitable, or managed and disposed of off-site as "uncontaminated soil" at a CCDD facility or an USFO within an MSA County excluding Chicago provided the pH of the soil is within the range of 6.25 - 9.0, inclusive.
 - (5) When the Engineer determines soil cannot be managed according to Articles 669.05(a)(1) through (a)(4) above, the soil shall be managed and disposed of off-site as a non-special waste, special waste, or hazardous waste as applicable.
- (b) Soil Analytical Results Do Not Exceed Most Stringent MAC. When the soil analytical results indicate that detected levels do not exceed the most stringent MAC, the excavated soil can be utilized within the construction limits or managed and disposed off-site as "uncontaminated soil" according to Article 202.03. However, the excavated soil cannot be taken to a CCDD facility or an USFO for any of the following reasons.
- (1) The pH of the soil is less than 6.25 or greater than 9.0.
 - (2) The soil exhibited PID or FID readings in excess of background levels.
- (c) Soil Analytical Results Exceed Most Stringent MAC but Do Not Exceed Tiered Approach to Corrective Action Objectives (TACO) Residential. When the soil analytical results indicate that detected levels exceed the most stringent MAC but do not exceed TACO Tier 1 Soil Remediation Objectives for Residential Properties pursuant to 35 IAC 742 Appendix B Table A, the excavated soil can be utilized within the right-of-way or managed and disposed off-site as "uncontaminated soil" according to Article 202.03. However, the excavated soil cannot be taken to a CCDD facility or an USFO.
- (d) Groundwater. When groundwater analytical results indicate the detected levels are above Appendix B, Table E of 35 Illinois Administrative Code 742, the most stringent Tier 1 Groundwater Remediation Objectives for Groundwater Component of the Groundwater Ingestion Route for Class 1 groundwater, the groundwater shall be managed off-site as a special waste. The groundwater shall be containerized and trucked to an off-site treatment facility or may be discharged to a sanitary sewer or combined sewer when permitted by the local sewer authority. Groundwater discharged to a sewer shall be pre-treated to remove particulates and measured with a calibrated flow meter to comply with applicable discharge limits. A copy of the permit shall be provided to the Engineer prior to discharging groundwater to the sewer.

All groundwater encountered within trenches may be managed within the trench and allowed to infiltrate back into the ground. If the groundwater cannot be managed within the trench it must be removed as a special or hazardous waste. The Contractor is

prohibited from managing groundwater within the trench by discharging it through any existing or new storm sewer. The Contractor shall install backfill plugs within the area of groundwater contamination.

One backfill plug shall be placed down gradient to the area of groundwater contamination. Backfill plugs shall be installed at intervals not to exceed 50 ft (15 m). Backfill plugs are to be 4 ft (1.2 m) long, measured parallel to the trench, full trench width and depth. Backfill plugs shall not have any fine aggregate bedding or backfill, but shall be entirely cohesive soil or any class of concrete. The Contractor shall provide test data that the material has a permeability of less than 10^{-7} cm/sec according to ASTM D 5084, Method A or per another test method approved by the Engineer.

The Contractor shall use due care when transferring contaminated material from the area of origin to the transporter. Should releases of contaminated material to the environment occur (i.e., spillage onto the ground, etc.), the Contractor shall clean-up spilled material and place in the appropriate storage containers as previously specified. Clean-up shall include, but not be limited to, sampling beneath the material staging area to determine complete removal of the spilled material.

The Contractor shall be responsible for transporting and disposing all material classified as a non-special waste, special waste, or hazardous waste from the job site to an appropriately permitted landfill facility. The transporter and the vehicles used for transportation shall comply with all federal, state, and local rules and regulations governing the transportation of non-special waste, special waste, or hazardous waste.

All equipment used by the Contractor to haul contaminated material to the landfill facility shall be lined with a 6 mil (150 micron) polyethylene liner and securely covered during transportation. The Contractor shall obtain all documentation including any permits and/or licenses required to transport the contaminated material to the disposal facility.

The Contractor shall provide engineered barriers, when required, and shall include materials sufficient to completely line excavation surfaces, including sloped surfaces, bottoms, and sidewall faces, within the areas designated for protection.

The Engineer shall coordinate with the Contractor on the completion of all documentation. The Contractor shall make all arrangements for collection and analysis of landfill acceptance testing. The Contractor shall coordinate for waste disposal approval with the disposal facility. After the Contractor completes these activities and upon receipt of authorization from the Engineer, the Contractor shall initiate the disposal process.

The Contractor shall provide the Engineer with all transport-related documentation within two days of transport or receipt of said document(s). The Engineer shall maintain the file for all such documentation. For management of special or hazardous waste, the Contractor shall provide the Engineer with documentation the Contractor (or subcontractor, if a subcontractor is used for transportation) is operating with a valid Illinois special waste transporter permit at least two weeks before transporting the first load of contaminated material.

The Contractor shall schedule and arrange the transport and disposal of each load of contaminated material produced. The Contractor shall make all transport and disposal arrangements so no contaminated material remains within the project area at the close of business each day. Exceptions to this specification require prior approval from the Engineer within 24 hours of close of business. The Contractor shall be responsible for all other pre-disposal/transport preparations necessary daily to accomplish management activities.

Any waste generated as a special or hazardous waste from a non-fixed facility shall be manifested off-site using the Department's county generator number. An authorized representative of the Department shall sign all manifests for the disposal of the contaminated material and confirm the Contractor's transported volume. Any waste generated as a non-special waste may be managed off-site without a manifest, a special waste transporter, or a generator number.

The Contractor shall select a landfill mandated by definition of the contaminant within the State of Illinois. The Department will review and approve or reject the facility proposed by the Contractor to use as a landfill. The Contractor shall verify whether the selected disposal facility is compliant with those applicable standards as mandated by definition of the contaminant and whether the disposal facility is presently, has previously been, or has never been, on the United States Environmental Protection Agency (U.S. EPA) National Priorities List or the Resource Conservation and Recovery Act (RCRA) List of Violating Facilities. The Contractor shall be responsible for coordinating permits with the IEPA. The use of a Contractor selected landfill shall in no manner delay the construction schedule or alter the Contractor's responsibilities as set forth.

669.06 Non-Special Waste Certification. An authorized representative of the Department shall sign and date all non-special waste certifications. The Contractor shall be responsible for providing the Engineer with the required information that will allow the Engineer to certify the waste is not a special waste.

(a) Definition. A waste is considered a non-special waste as long as it is not:

- (1) a potentially infectious medical waste;
- (2) a hazardous waste as defined in 35 IAC 721;
- (3) an industrial process waste or pollution control waste that contains liquids, as determined using the paint filter test set forth in subdivision (3)(A) of subsection (m) of 35 IAC 811.107;
- (4) a regulated asbestos-containing waste material, as defined under the National Emission Standards for Hazardous Air Pollutants in 40 CFR 61.141;
- (5) a material containing polychlorinated biphenyls (PCB's) regulated pursuant to 40 CFR Part 761;

- (6) a material subject to the waste analysis and recordkeeping requirements of 35 IAC 728.107 under land disposal restrictions of 35 IAC 728;
 - (7) a waste material generated by processing recyclable metals by shredding and required to be managed as a special waste under Section 22.29 of the Environmental Protection Act; or
 - (8) an empty portable device or container in which a special or hazardous waste has been stored, transported, treated, disposed of, or otherwise handled.
- (b) Certification Information. All information used to determine the waste is not a special waste shall be attached to the certification. The information shall include but not be limited to:
- (1) the means by which the generator has determined the waste is not a hazardous waste;
 - (2) the means by which the generator has determined the waste is not a liquid;
 - (3) if the waste undergoes testing, the analytic results obtained from testing, signed and dated by the person responsible for completing the analysis;
 - (4) if the waste does not undergo testing, an explanation as to why no testing is needed;
 - (5) a description of the process generating the waste; and
 - (6) relevant material safety data sheets.

669.07 Temporary Staging. The Contractor shall excavate and dispose of all waste material as mandated by the contaminants without temporary staging. If circumstances require temporary staging, he/she shall request in writing, approval from the Engineer.

When approved, the Contractor shall prepare a secure location within the project area capable of housing containerized waste materials. The Contractor shall contain all waste material in leak-proof storage containers such as lined roll-off boxes or 55 gal (208 L) drums, or stored in bulk fashion on storage pads. The design and construction of such storage pad(s) for bulk materials shall be subject to approval by the Engineer. The Contractor shall place the staged storage containers on an all-weather gravel-packed, asphalt, or concrete surface. The Contractor shall maintain a clearance both above and beside the storage units to provide maneuverability during loading and unloading. The Contractor shall provide any assistance or equipment requested by the Engineer for authorized personnel to inspect and/or sample contents of each storage container. All containers and their contents shall remain intact and undisturbed by unauthorized persons until the manner of disposal is determined. The Contractor shall keep the storage containers covered, except when access is requested by authorized personnel of the Department. The Engineer shall authorize any additional material added to the contents of any storage container before being filled.

The Contractor shall ensure the staging area is enclosed (by a fence or other structure) to ensure direct access to the area is restricted, and he/she shall procure and place all required regulatory identification signs applicable to an area containing the waste material. The Contractor shall be responsible for all activities associated with the storage containers including, but not limited to, the procurement, transport, and labeling of the containers. The Contractor shall clearly mark all containers in permanent marker or paint with the date of waste generation, location and/or area of waste generation, and type of waste (e.g., decontamination water, contaminated clothing, etc.). The Contractor shall place these identifying markings on an exterior side surface of the container. The Contractor shall separately containerize each contaminated medium, i.e. contaminated clothing is placed in a separate container from decontamination water. Containers used to store liquids shall not be filled in excess of 80 percent of the rated capacity. The Contractor shall not use a storage container if visual inspection of the container reveals the presence of free liquids or other substances that could classify the material as a hazardous waste in the container.

The Department will not be responsible for any additional costs incurred, if mismanagement of the staging area, storage containers, or their contents by the Contractor results in excess cost expenditure for disposal or other material management requirements.

669.08 Underground Storage Tank Removal. For the purposes of this section, an underground storage tank (UST) includes the underground storage tank, piping, electrical controls, pump island, vent pipes and appurtenances.

Prior to removing an UST, the Engineer shall determine whether the Department is considered an "owner" or "operator" of the UST as defined by the UST regulations (41 Ill. Adm. Code Part 176). Ownership of the UST refers to the Department's owning title to the UST during storage, use or dispensing of regulated substances. The Department may be considered an "operator" of the UST if it has control of, or has responsibility for, the daily operation of the UST. The Department may however voluntarily undertake actions to remove an UST from the ground without being deemed an "operator" of the UST.

In the event the Department is deemed not to be the "owner" or "operator" of the UST, the OSFM removal permit shall reflect who was the past "owner" or "operator" of the UST. If the "owner" or "operator" cannot be determined from past UST registration documents from OSFM, then the OSFM removal permit will state the "owner" or "operator" of the UST is the Department. The Department's Office of Chief Counsel (OCC) will review all UST removal permits prior to submitting any removal permit to the OSFM. If the Department is not the "owner" or "operator" of the UST then it will not register the UST or pay any registration fee.

The Contractor shall be responsible for obtaining all permits required for removing the UST, notification to the OSFM, using an OSFM certified tank contractor, removal and disposal of the UST and its contents, and preparation and submittal of the OSFM Site Assessment Report in accordance with 41 Ill. Adm. Code Part 176.330.

The Contractor shall contact the Engineer and the OSFM's office at least 72 hours prior to removal to confirm the OSFM inspector's presence during the UST removal. Removal, transport,

and disposal of the UST shall be according to the applicable portions of the latest revision of the "American Petroleum Institute (API) Recommended Practice 1604".

The Contractor shall collect and analyze tank content (sludge) for disposal purposes. The Contractor shall remove as much of the regulated substance from the UST system as necessary to prevent further release into the environment. All contents within the tank shall be removed, transported and disposed of, or recycled. The tank shall be removed and rendered empty according to IEPA definition.

The Contractor shall collect soil samples from the bottom and sidewalls of the excavated area in accordance with 35 Ill. Adm. Code Part 734.210(h) after the required backfill has been removed during the initial response action, to determine the level of contamination remaining in the ground, regardless if a release is confirmed or not by the OSFM on-site inspector.

In the event the UST is designated a leaking underground storage tank (LUST) by the OSFM's inspector, or confirmation by analytical results, the Contractor shall notify the Engineer and the DESU. Upon confirmation of a release of contaminants from the UST and notifications to the Engineer and DESU, the Contractor shall report the release to the Illinois Emergency Management Agency (IEMA) (e.g., by telephone or electronic mail) and provide them with whatever information is available ("owner" or "operator" shall be stated as the past registered "owner" or "operator", or the IDOT District in which the UST is located and the DESU Manager);

The Contractor shall perform the following initial response actions if a release is indicated by the OSFM inspector:

- (a) Take immediate action to prevent any further release of the regulated substance to the environment, which may include removing, at the Engineer's discretion, and disposing of up to 4 ft (1.2 m) of the contaminated material, as measured from the outside dimension of the tank
- (b) Identify and mitigate fire, explosion and vapor hazards;
- (c) Visually inspect any above ground releases or exposed below ground releases and prevent further migration of the released substance into surrounding soils and groundwater; and
- (d) Continue to monitor and mitigate any additional fire and safety hazards posed by vapors and free product that have migrated from the UST excavation zone and entered into subsurface structures (such as sewers or basements).

The UST excavation shall be backfilled according to applicable portions of Sections 205, 208, and 550 with a material that will compact and develop stability. The material shall be approved prior to placement. All uncontaminated concrete and soil removed during tank extraction may be used to backfill the excavation, at the discretion of the Engineer.

After backfilling the excavation, the site shall be graded and cleaned.

669.09 Regulated Substance Final Construction Report. Not later than 90 days after completing this work, the Contractor shall submit a Regulated Substance Final Construction Report (RSFCR) to the Engineer using form BDE 2733 and required attachments. The form shall be signed by an Illinois licensed Professional Engineer or Professional Geologist.

669.10 Method of Measurement. Non-special waste, special waste, and hazardous waste soil will be measured for payment according to Article 202.07(b) when performing earth excavation, Article 502.12(b) when excavating for structures, or by computing the volume of the trench using the maximum trench width permitted and the actual depth of the trench.

Groundwater containerized and transported off-site for management, storage, and disposal will be measured for payment in gallons (liters).

Backfill plugs will be measured in cubic yards (cubic meters) in place, except the quantity for which payment will be made shall not exceed the volume of the trench, as computed by using the maximum width of trench permitted by the Specifications and the actual depth of the trench, with a deduction for the volume of the pipe.

Engineered Barriers will be measured for payment in square yards (square meters).

669.11 Basis of Payment. The work of preparing, submitting and administering a Regulated Substances Pre-Construction Plan will be paid for at the contract lump sum price for REGULATED SUBSTANCES PRE-CONSTRUCTION PLAN.

On-site monitoring of regulated substances, including completion of form BDE 2732 for each day of work, will be paid for at the contract unit price per calendar day, or fraction thereof, for ON-SITE MONITORING OF REGULATED SUBSTANCES.

The installation of engineered barriers will be paid for at the contract unit price per square yard (square meter) for ENGINEERED BARRIER.

The work of removing a UST, soil excavation, soil and content sampling, and the excavated soil, UST content, and UST disposal will be paid for at the contract unit price per each for UNDERGROUND STORAGE TANK REMOVAL.

The transportation and disposal of soil and other materials from an excavation determined to be contaminated will be paid for at the contract unit price per cubic yard (cubic meter) for NON-SPECIAL WASTE DISPOSAL, SPECIAL WASTE DISPOSAL, or HAZARDOUS WASTE DISPOSAL.

The transportation and disposal of groundwater from an excavation determined to be contaminated will be paid for at the contract unit price per gallon (liter) for SPECIAL WASTE GROUNDWATER DISPOSAL or HAZARDOUS WASTE GROUNDWATER DISPOSAL. When groundwater is discharged to a sanitary or combined sewer by permit, the cost will be paid for according to Article 109.05.

Backfill plugs will be paid for at the contract unit price per cubic yard (cubic meter) for BACKFILL PLUGS.

Payment for temporary staging, if required, will be paid for according to Article 109.04.

Payment for accumulated stormwater removal and disposal will be according to Article 109.04. Payment will only be allowed if appropriate stormwater and erosion control methods were used.

Payment for decontamination, labor, material, and equipment for monitoring areas beyond the specified areas, with the Engineer's prior written approval, will be according to Article 109.04.

The sampling and testing associated with this work will be paid for as follows.

- (a) BETX Soil/Groundwater Analysis. When the contaminants of concern are gasoline only, soil or groundwater samples shall be analyzed for benzene, ethylbenzene, toluene, and xylenes (BETX). The analysis will be paid for at the contract unit price per each for BETX SOIL ANALYSIS and/or BETX GROUNDWATER ANALYSIS using EPA Method 8021B.
- (b) BETX-PNAS Soil/Groundwater Analysis. When the contaminants of concern are middle distillate and heavy ends, soil or groundwater samples shall be analyzed for BETX and polynuclear aromatics (PNAS). The analysis will be paid for at the contract unit price per each for BETX-PNAS SOIL ANALYSIS and/or BETX-PNAS GROUNDWATER ANALYSIS using EPA Method 8021B for BETX and EPA Method 8310 for PNAS.
- (c) Priority Pollutants Soil Analysis. When the contaminants of concern are used oils, soil samples shall be analyzed for priority pollutant VOCs, priority pollutants SVOCs, and priority pollutants metals. The analysis will be paid for at the contract unit price per each for PRIORITY POLLUTANTS SOIL ANALYSIS using EPA Method 8260B for VOCs, EPA Method 8270C for SVOCs, and using an ICP instrument and EPA Methods 6010B and 7471A for metals.
- (d) Priority Pollutant Groundwater Analysis. When the contaminants of concern are used oils, non-petroleum material, or unknowns, groundwater samples shall be analyzed for priority pollutant VOCs, priority pollutants SVOCs, and priority pollutants metals. The analysis will be paid for at the contract unit price per each for PRIORITY POLLUTANTS GROUNDWATER ANALYSIS using EPA Method 8260B for VOCs, EPA Method 8270C for SVOCs, and EPA Methods 6010B and 7470A for metals.
- (e) Target Compound List (TCL) Soil Analysis. When the contaminants of concern are unknowns or non-petroleum material, soil samples shall be analyzed for priority pollutant VOCs, priority pollutants SVOCs, priority pollutants metals, pesticides, and Resource Conservation and Recovery Act (RCRA) metals by the toxicity characteristic leaching procedure (TCLP). The analysis will be paid for at the contract unit price per each for TCL SOIL ANALYSIS using EPA Method 8260B for VOCs, EPA Method 8270C for SVOCs,

EPA Method 8081 for pesticides, and ICP instrument and EPA Methods 6010B, 7471A, 1311 (extraction), 6010B, and 7470A for metals.

- (f) Soil Disposal Analysis. When the waste material for disposal requires sampling for disposal acceptance, the samples shall be analyzed for TCLP VOCs, SVOCs, RCRA metals, pH, ignitability, and paint filter test. The analysis will be paid for at the contract unit price per each for SOIL DISPOSAL ANALYSIS using EPA Methods 1311 (extraction), 8260B for VOCs, 8270C for SVOCs, 6010B and 7470A for RCRA metals, 9045C for pH, 1030 for ignitability, and 9095A for paint filter.

The work of preparing, submitting and administering a Regulated Substances Final Construction Report will be paid for at the contract lump sum price REGULATED SUBSTANCES FINAL CONSTRUCTION REPORT.”

80407

SUBCONTRACTOR AND DBE PAYMENT REPORTING (BDE)

Effective: April 2, 2018

Add the following to Section 109 of the Standard Specifications.

“109.14 Subcontractor and Disadvantaged Business Enterprise Payment Reporting.
The Contractor shall report all payments made to the following parties:

- (a) first tier subcontractors;
- (b) lower tier subcontractors affecting disadvantaged business enterprise (DBE) goal credit;
- (c) material suppliers or trucking firms that are part of the Contractor’s submitted DBE utilization plan.

The report shall be made through the Department’s on-line subcontractor payment reporting system within 21 days of making the payment.”

80397

SUBCONTRACTOR MOBILIZATION PAYMENTS (BDE)

Effective: November 2, 2017

Revised: April 1, 2019

Replace the second paragraph of Article 109.12 of the Standard Specifications with the following:

“This mobilization payment shall be made at least seven days prior to the subcontractor starting work. The amount paid shall be at the following percentage of the amount of the subcontract reported on form BC 260A submitted for the approval of the subcontractor’s work.

Value of Subcontract Reported on Form BC 260A	Mobilization Percentage
Less than \$10,000	25%
\$10,000 to less than \$20,000	20%
\$20,000 to less than \$40,000	18%
\$40,000 to less than \$60,000	16%
\$60,000 to less than \$80,000	14%
\$80,000 to less than \$100,000	12%
\$100,000 to less than \$250,000	10%
\$250,000 to less than \$500,000	9%
\$500,000 to \$750,000	8%
Over \$750,000	7%”

80391

TRAFFIC CONTROL DEVICES - CONES (BDE)

Effective: January 1, 2019

Revise Article 701.15(a) of the Standard Specifications to read:

“(a) Cones. Cones are used to channelize traffic. Cones used to channelize traffic at night shall be reflectorized; however, cones shall not be used in nighttime lane closure tapers or nighttime lane shifts.”

Revise Article 1106.02(b) of the Standard Specifications to read:

“(b) Cones. Cones shall be predominantly orange. Cones used at night that are 28 to 36 in. (700 to 900 mm) in height shall have two white circumferential stripes. If non-reflective spaces are left between the stripes, the spaces shall be no more than 2 in. (50mm) in width. Cones used at night that are taller than 36 in. (900 mm) shall have a minimum of two white and two fluorescent orange alternating, circumferential stripes with the top stripe being fluorescent orange. If non-reflective spaces are left between the stripes, the spaces shall be no more than 3 in. (75 mm) in width.

The minimum weights for the various cone heights shall be 4 lb for 18 in. (2 kg for 450 mm), 7 lb for 28 in. (3 kg for 700 mm), and 10 lb for 36 in. (5 kg for 900 mm) with a minimum of 60 percent of the total weight in the base. Cones taller than 36 in. shall be weighted per the manufacturer’s specifications such that they are not moved by wind or passing traffic.”

80409

WEEKLY DBE TRUCKING REPORTS (BDE)

Effective: June 2, 2012

| Revised: April 2, 2015

| The Contractor shall submit a weekly report of Disadvantaged Business Enterprise (DBE) trucks hired by the Contractor or subcontractors (i.e. not owned by the Contractor or subcontractors) that are used for DBE goal credit.

| The report shall be submitted to the Engineer on Department form "SBE 723" within ten business days following the reporting period. The reporting period shall be Monday through Sunday for each week reportable trucking activities occur.

Any costs associated with providing weekly DBE trucking reports shall be considered as included in the contract unit prices bid for the various items of work involved and no additional compensation will be allowed.

80302

WORKING DAYS (BDE)

Effective: January 1, 2002

The Contractor shall complete the work within 40 working days.

80071

STATE OF ILLINOIS DEPARTMENT OF TRANSPORTATION PLANS
 FOR PROPOSED SURFACE TRANSPORTATION RURAL PROGRAM
 FAS 1918 (AVA RD) SECTION 14-00173-00-RS
 JACKSON COUNTY PROJECT NO 1 LXJ(606)
 JOB NO. C-99-508-15 CONTRACT NO. 99616

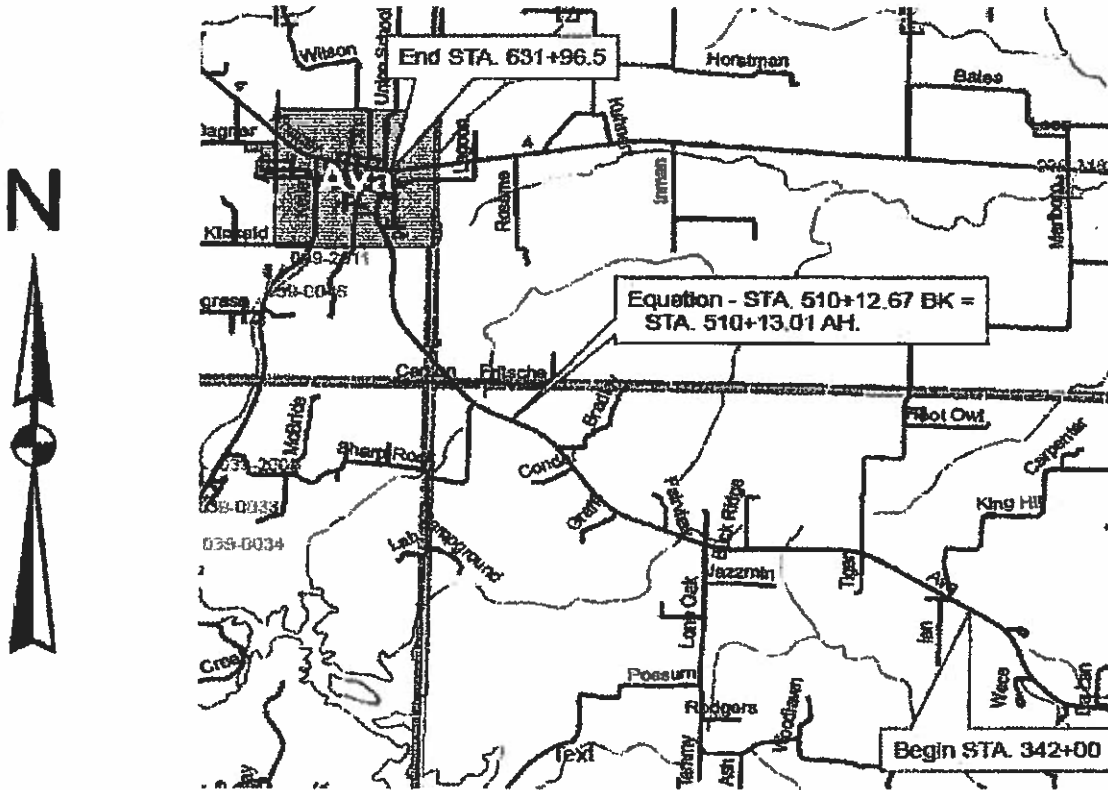

T.7S., R.4W., 3RD P.M. & T. 7S & 8S. R.3W 3RD P.M.

MAP NOT TO SCALE

NET LENGTH OF SECTION = 28,996 FEET = 5.49 MILES

CLASSIFICATION: MAJOR COLLECTOR

ADT(16): 2750

DESIGN SPEED: 55 MPH

MITCHELL J. BURDICK
 52489
 REGISTERED PROFESSIONAL ENGINEER
 ILLINOIS LICENSED PROFESSIONAL ENGINEER NO. 062-039450
 EXPIRES 11/30/2019

ILLINOIS DEPARTMENT OF TRANSPORTATION	
Approved	<u>1/8/2019</u> <i>[Signature]</i> Jackson County Engineer
Passed	<u>FEBRUARY 19, 2019</u> <i>[Signature]</i> District 9 Engineer of Local Roads & Streets
Releasing for Bid Based on Limited Review	<u>FEBRUARY 19, 2019</u> <i>[Signature]</i> Region 5 Engineer <i>JK</i>

INDEX OF SHEETS

SHEET NO.	CONTENTS
1	COVER SHEET
2	INDEX OF SHEETS AND HIGHWAY STANDARDS
3	SUMMARY OF QUANTITIES
4	TYPICAL SECTION 342+00 TO 603+00
5	TYPICAL SECTION 603+00 TO 631+96.5
6	BUTT JOINT 342+00
7	TRANSITION 602+70 TO 603+00
8	HMA SURFACE REMOVAL 2" DETAIL
9	TYPICAL ENTRANCE/SIDEROAD DETAIL 342+00 TO 603+00
10	TYPICAL ENTRANCE/SIDEROAD DETAIL 603+00 TO 631+96.5
11	BUTT JOINT 631+96.5
12	MIXTURE REQUIREMENTS/PAVEMENT MARKING SCHEDULE
13	SUPER ELEVATION DATA
14	LOCATIONS OF PEDESTRIAN CROSSINGS
15	IDOT STANDARDS

HIGHWAY STANDARDS:

4240001-11 PERPENDICULAR CURB RAMPS FOR SIDEWALKS
424021-05 DEPRESSED CORNER FOR SIDEWALKS
424026-03 ENTRANCE/ALLEY PEDESTRIAN CROSSINGS
701006-05 OFF ROAD OPERATIONS 2L, 2W, 4.5M(15") TO 600 MM (24") FROM PAVEMENT EDGE
701011-04 OFF ROAD MOVING OPERATIONS 2L, 2W, DAY ONLY
701301-04 LANE CLOSURE 2L, 2W, SHORT TIME OPERATIONS
701306-04 LANE CLOSURE 2L, 2W, SLOW MOVING OPERATIONS -DAY ONLY FOR SPEEDS \geq 45 MPH
701311-03 LANE CLOSURE 2L, 2W, MOVING OPERATIONS, DAY ONLY
701326-04 LANE CLOSURE 2L, 2W, PAVEMENT WIDENING FOR SPEEDS \geq 45 MPH
701901-08 TRAFFIC CONTROL DEVICES
780001-05 TYPICAL PAVEMENT MARKINGS
781001-04 TYPICAL RAISED REFLECTIVE PAVEMENT MARKERS

SUMMARY OF QUANTITIES

QUANTITY	UNIT	ITEM	CODE NO.	
1	L SUM	TRAF CONT & PROT SPL	X7010216	*
28,996	FOOT	LONGITUDINAL JOINT SEALANT	Z0033700	*
38,274	POUND	BITUMINOUS MATERIALS (TACK COAT)	40600290	
98	SQ YD	HOT-MIX SURFACE REMOVAL - BUTT JOINT	40600982	
8,000	TON	HOT-MIX ASPHALT SURFACE COURSE, MIX "C", N70	40603315	
270	SQ FT	PORTLAND CEMENT CONCRETE SIDEWALK, 4 INCH	42400100	
65	SQ FT	DETECTABLE WARNINGS	42400800	
63,727	SQ YD	HMA SURF REM 1/2	44000151	
9,655	SQ YD	HOT-MIX ASPHALT SURFACE REMOVAL, 1 1/2"	44000155	
320	SQ FT	SIDEWALK REMOVAL	44000600	
5,400	TON	HOT-MIX ASPHALT SHOULDERS	48203100	
1	L SUM	MOBILIZATION	67100100	
2,900	FOOT	SHORT-TERM PAVEMENT MARKING	70300100	
2,900	SQ FT	SHORT-TERM PAVEMENT MARKING REMOVAL	70300150	
162	FOOT	PREFORMED PLASTIC PAVEMENT MARKING, TY B INLAID 12"	78004250	
72,500	FOOT	PAINT PAVEMENT MARKING-LINE 4"	78001110	△
364	EACH	RAISED REFLECTIVE PAVEMENT MARKER	78100100	△
364	EACH	RAISED REFLECTIVE PAVEMENT MARKER REMOVAL	78300200	△

△ SPECIALTY ITEMS

* SEE SPECIAL PROVISION

TYPICAL SECTION

(NOT TO SCALE)

Sta. 342+00 to 603+00

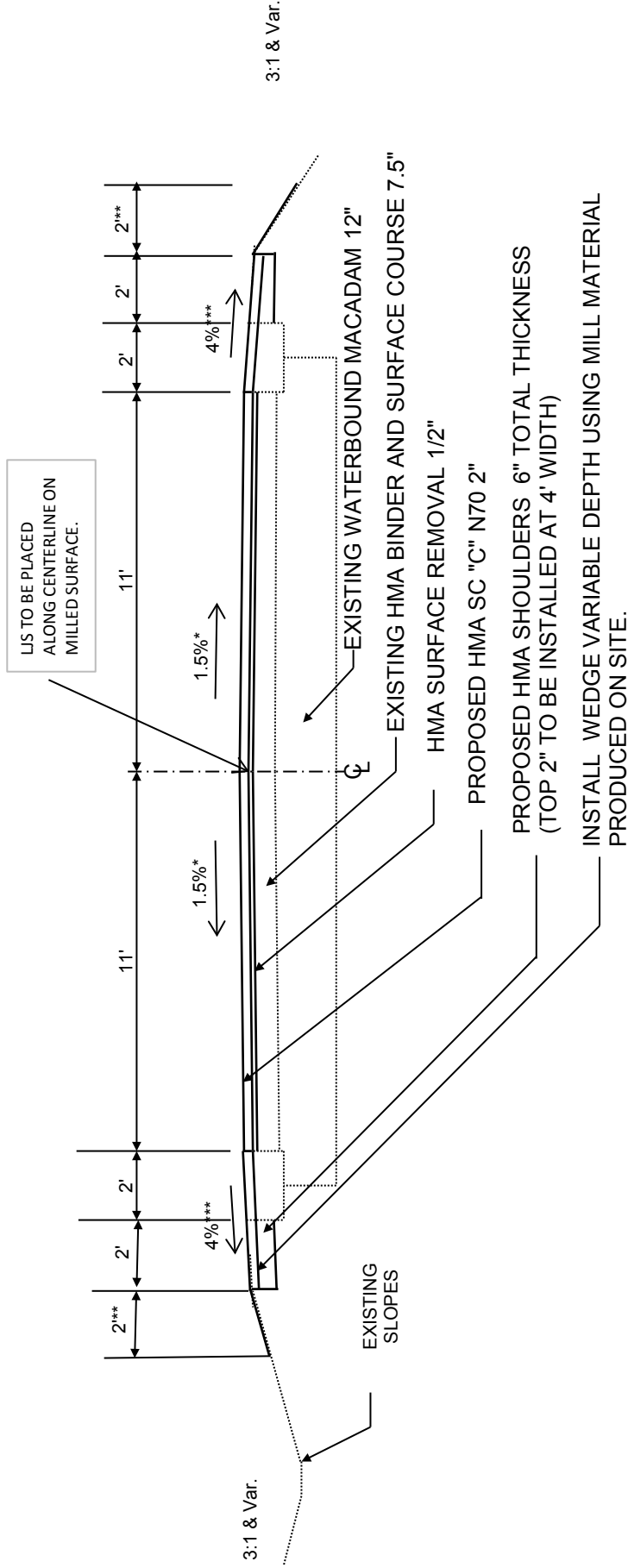

Jackson County
 FAS 1918 (Ava Rd)
 Section 14-00173-00-RS
 Project No. 1LXJ (606)
 Contract 99616

* 1.56% CROSS SLOPE IN TANGENT AND VARIABLE THROUGH CURVES (see Superlevation Data Sheet)
 ** 2' TYPICAL EXCEPT ADJACENT TO GUARD RAIL, INCREASE WEDGE WIDTH TO FACE OF RAIL AND SLOPE NOT TO EXCEED 10%
 *** 4% CROSS SLOPE IN TANGENT, BREAK-OVER NOT TO EXCEED 0.08 FT/FT THROUGH CURVES

TYPICAL SECTION

TO BE USED STA. 603+00 TO 631+96.5
(NOT TO SCALE)

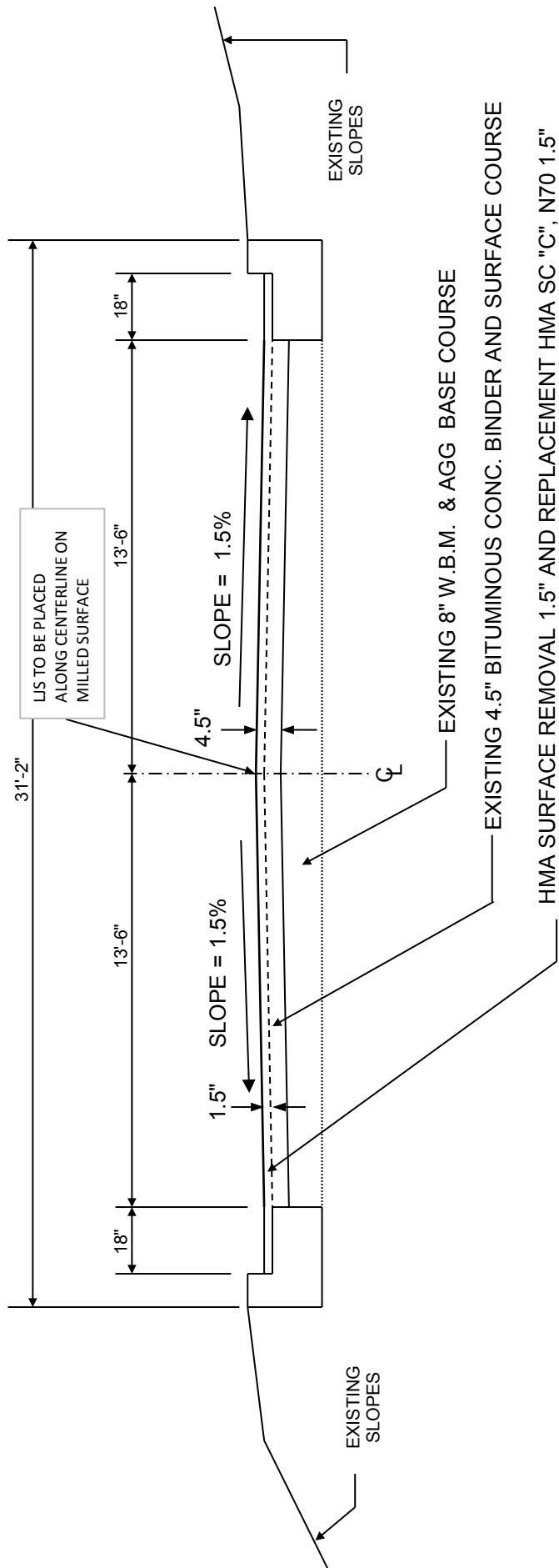

Jackson County
FAS 1918 (Ava Rd)
Section 14-00173-00-RS
Project No. 1LXJ (606)
Contract 99616

BUTT JOINT DETAIL

STA 342+00

(NOT TO SCALE)

SAWED BUTT JOINT STA. 342+00*

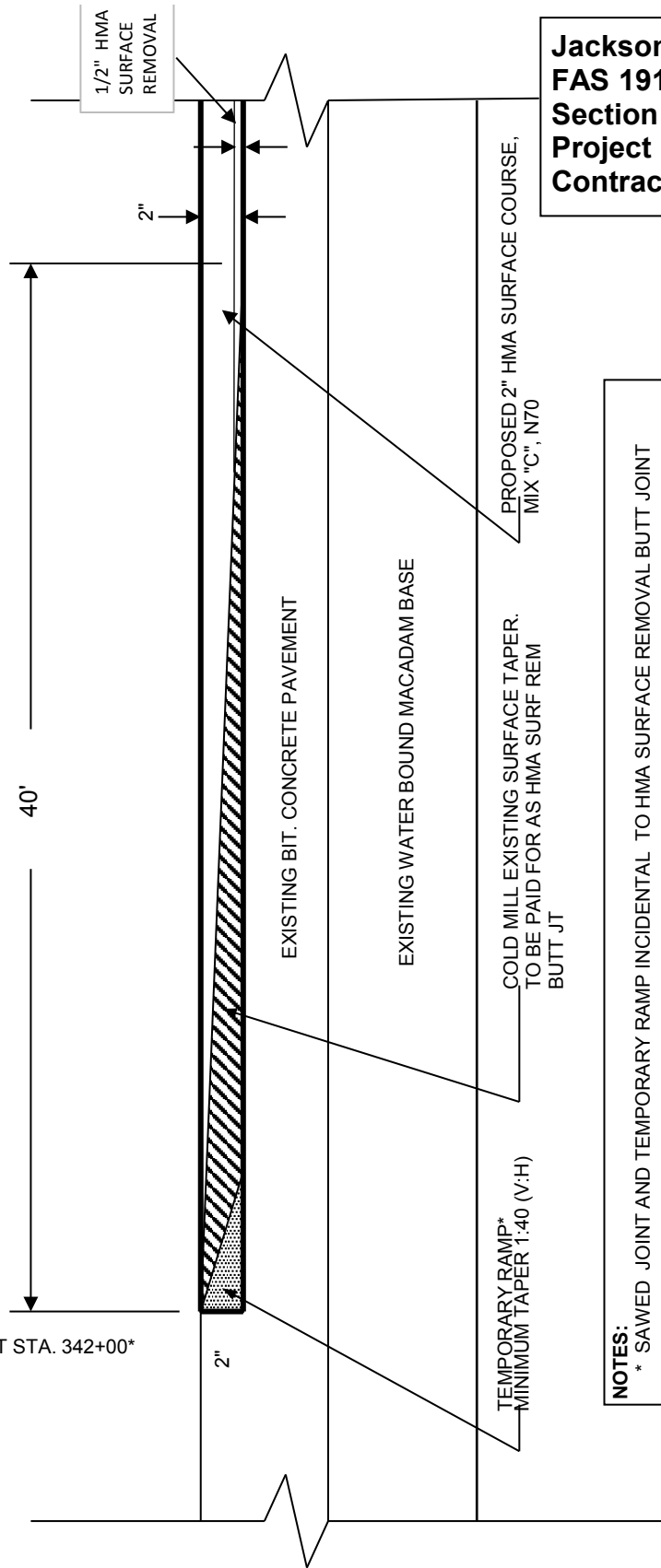

**Jackson County
FAS 1918 (Ava Rd)
Section 14-00173-00-RS
Project No. 1LXJ (606)
Contract 99616**

NOTES:
* SAWED JOINT AND TEMPORARY RAMP INCIDENTAL TO HMA SURFACE REMOVAL BUTT JOINT

TRANSITION DETAIL

STA. 602+70 - 603+00

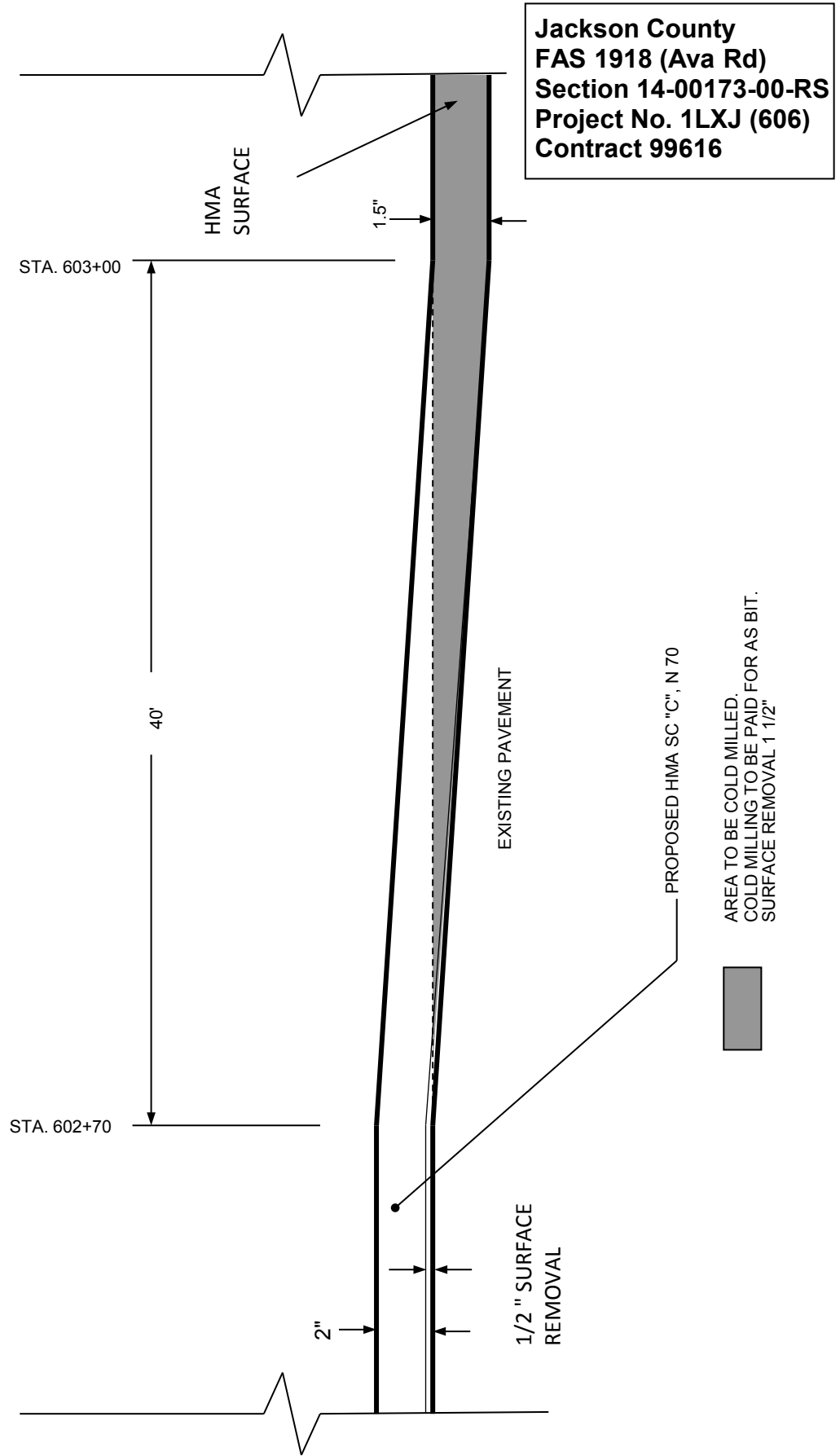

HMA SURFACE REMOVAL 2" DETAIL

(Not to Scale)

Sta. 603+00 to 631+96.5

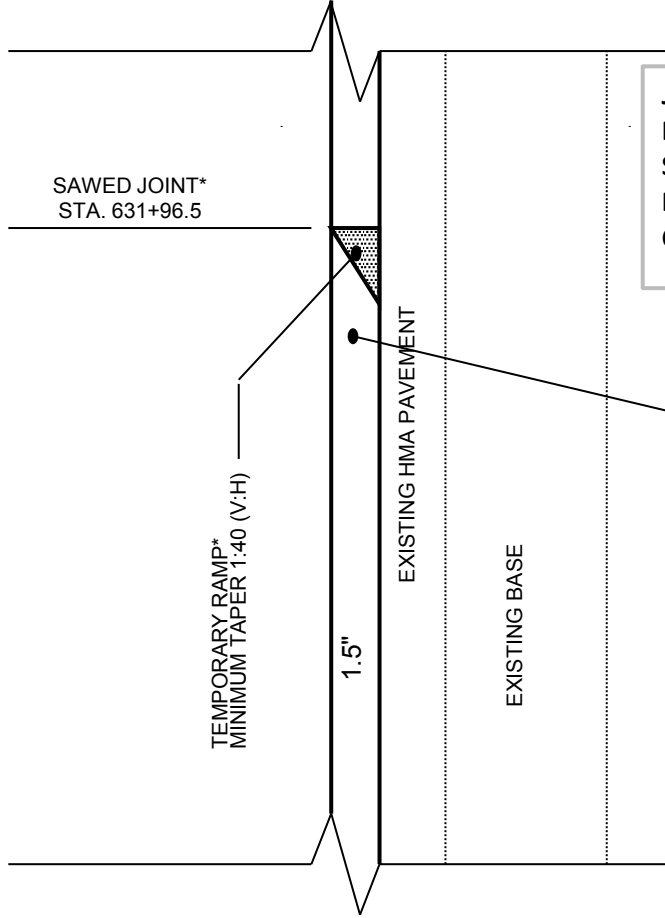

Jackson County
FAS 1918 (Ava Rd)
Section 14-00173-00-RS
Project No. 1LXJ(606)
Contract 99616

** PROPOSED HOT-MIX ASPHALT SURFACE REMOVAL/REPLACE 1.5"

NOTES:
* SAWED JOINT AND TEMPORARY RAMP INCIDENTAL TO HOT-MIX ASPHALT SURFACE REMOVAL 1.5"
** HMA SURFACE REMOVAL INCLUDES PAVEMENT SURFACE AND SHOULDER, TOTAL 30' WIDE

TYPICAL PRIVATE AND SIDE ROAD ENTRANCE DETAIL

STA. 342+00 TO STA. 603+00
(NOT TO SCALE)

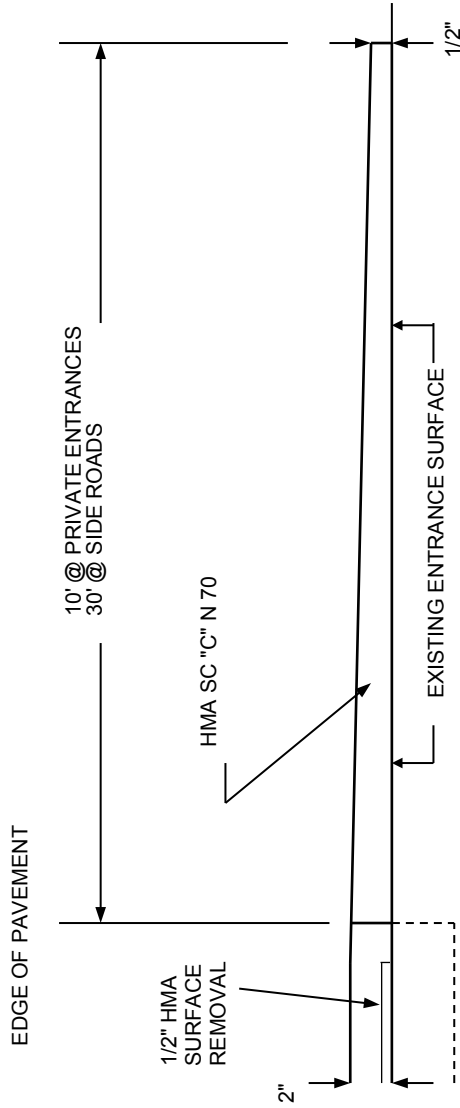

ENTRANCE TYPE	QUANTITY	LOCATION	NAME
PRIVATE	53	VARIOUS	VARIOUS
SIDE ROAD	1	345+00	KING HILL ROAD
SIDE ROAD	1	379+15	MARLBORO ROAD
SIDE ROAD	1	432+29	LONE OAK ROAD
SIDE ROAD	1	446+89	FAIRVIEW LANE
SIDE ROAD	1	530+41	SHARP ROCK ROAD
SIDE ROAD	1	540+00	FRITSCHE ROAD
SIDE ROAD	1	540+70	CARSON ROAD

- NOTES:**
- 1) WIDTH IS VARIABLE AND SHALL INCLUDE RADII AS DIRECTED BY THE ENGINEER.
 - 2) RESURFACE TO DISTANCES SHOWN OR AS DIRECTED BY ENGINEER.
 - 3) PREPARATION OF THE EXISTING SURFACE AND ANY EXCAVATION FOR ENTRANCES SHALL BE IN ACCORDANCE WITH ARTICLE 406.05 OF THE STANDARD SPECIFICATIONS.
 - 4) BIT. SURFACE REMOVAL MAY BE REQUIRED AT SIDEROADS AS DIRECTED BY ENGINEER; IF SO IT SHALL BE PAID FOR AS HMA SURFACE REMOVAL 1 1/2"
 - 5) TOTAL ESTIMATED QUANTITY OF HMA SURFACE COURSES "C", N 70 = 200 TONS

Jackson County
FAS 1918 (Ava Rd)
Section 14-00173-00-RS
Project No. 1LXJ (606)
Contract 99616

TYPICAL SIDE ROAD AND ENTRANCE DETAIL

TO BE USED STA. 603+00 TO 631+96.5

(NOT TO SCALE)

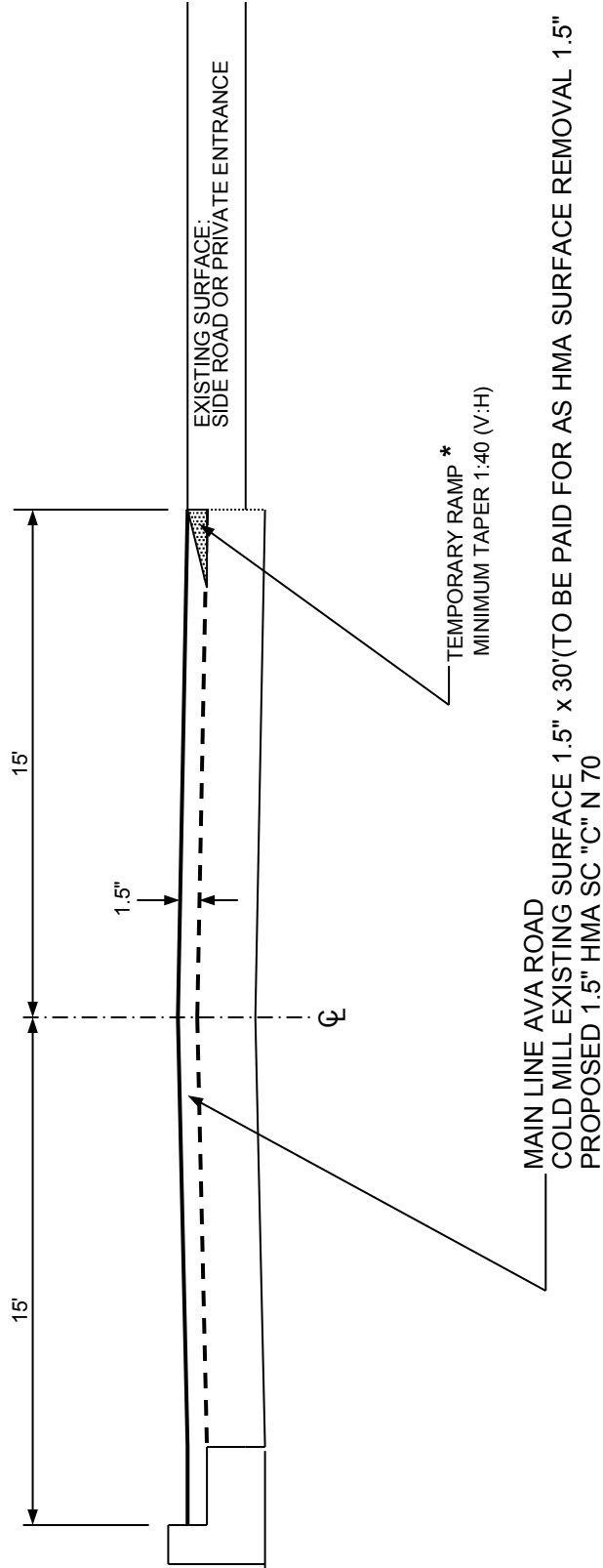

Jackson County
 FAS 1918 (Ava Rd)
 Section 14-00173-00-RS
 Project No. 1LXJ (606)
 Contract 99616

TOTAL ESTIMATED NO. OF PRIVATE ENTRANCES = 21
 TOTAL ESTIMATED NO. OF SIDE ROADS = 10

NOTES:
 * TEMPORARY RAMP INCIDENTAL TO BIT. SURFACE REMOVAL (COLD MILLING)
 NO EXTRA COMPENSATION WILL BE ALLOWED

BUTT JOINT DETAIL

STA. 631+96.5
(NOT TO SCALE)

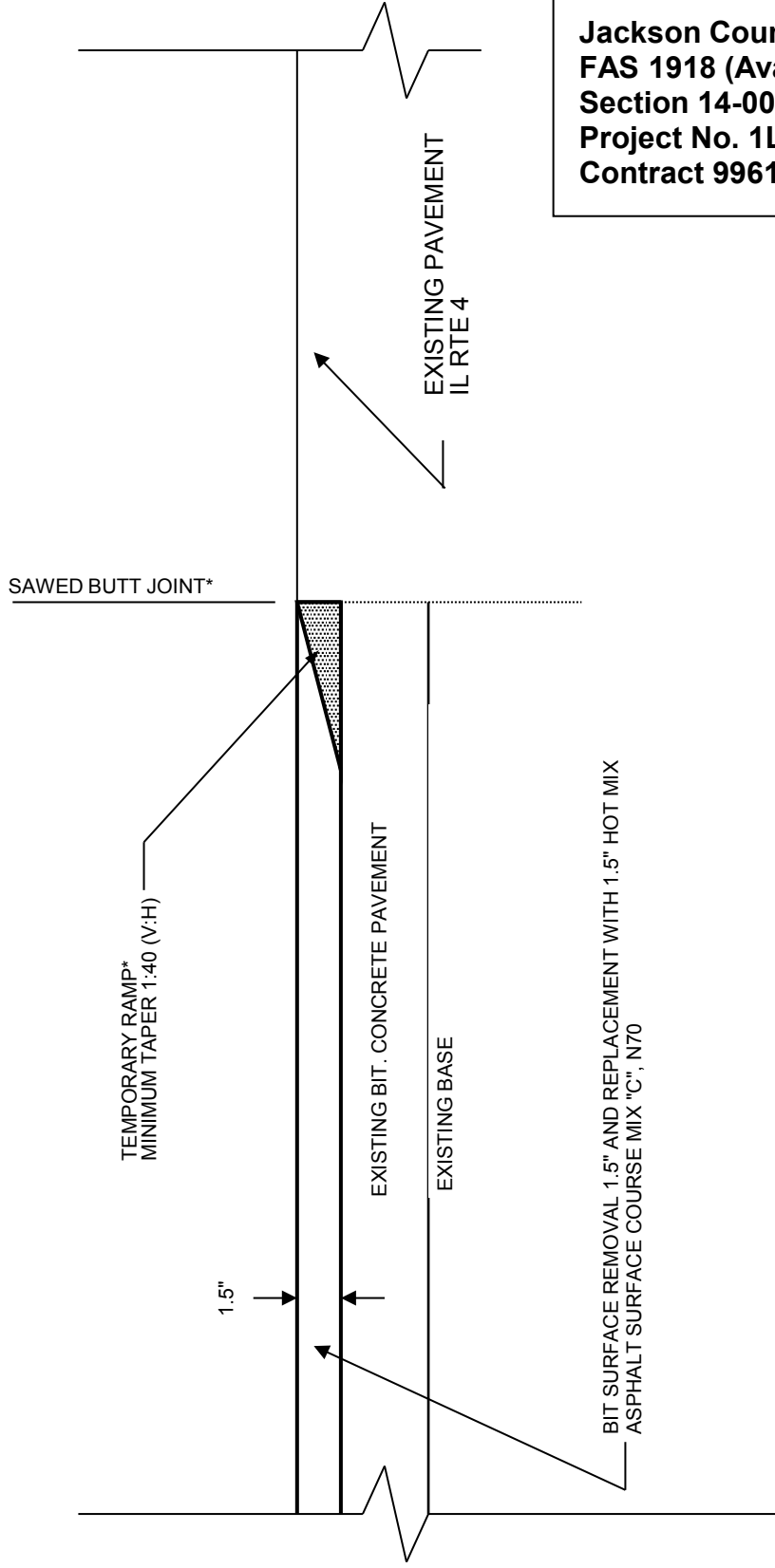

**Jackson County
FAS 1918 (Ava Rd)
Section 14-00173-00-RS
Project No. 1LXJ (606)
Contract 99616**

NOTES:
* SAWED JOINT AND TEMPORARY RAMP INCIDENTAL TO BITUMINOUS SURFACE REMOVAL 1 1/2"
NO EXTRA COMPENSATION WILL BE ALLOWED

Jackson County
 FAS 1918 (Ava Rd)
 Section 14-00173-00-RS
 Project No. 1XLJ(606)
 Contract 99616

MIXTURE REQUIREMENTS	
LOCATIONS:	AVA ROAD
MIXTURE USES:	HOT-MIX ASPHALT SURFACE COURSE MIX "C" N70
	HMA SHOULDER (TOP LIFT), P.E., S.R., MAIL BOX TURN-OUT
AC/PG:	PG 64-22
RAP % (MAX):	10%
DESIGN AIR VOIDS:	4% @ Ndes 70
MIXTURE COMPOSITION (GRADATION COMPOSTION):	IL 9.5 or IL 12.5
FRICITION AGGREGATE:	MIXTURE C
MIXTURE WEIGHTS:	112 LBS/SY/INCH THICKNESS

MIXTURE REQUIREMENTS	
LOCATIONS:	AVA ROAD
MIXTURE USES:	HOT-MIX ASPHALT SHOULDERS (BOTTOM LIFT)
AC/PG:	PG 64-22
RAP % (MAX):	25%
DESIGN AIR VOIDS:	4% @ Ndes 30
MIXTURE COMPOSITION (GRADATION COMPOSTION):	IL 9.5, IL 12.5, or IL 19.0
FRICITION AGGREGATE:	NONE
MIXTURE WEIGHTS:	112 LBS/SY/INCH THICKNESS

SCHEDULE OF PAVEMENT MARKING LINE 4" (LIN. FT.)		
LOCATION	WHITE EDGE LINE	YELLOW CENTERLINE
342+00 TO 631+96.5	52200	20300

SUPER ELEVATION DATA

Super Elevation Rate (Ft/Ft)

0.058	To be attained To be removed	Sta.372+39 to Sta. 374+39 Sta.386+12 to Sta. 388+12
0.058	To be attained To be removed	Sta. 420+01 to Sta. 422+01 Sta. 431+96 to Sta. 433+96
0.058	To be attained To be removed	Sta. 457+75 to Sta. 459+75 Sta. 474+92 to Sta. 476+92
0.058	To be attained To be removed	Sta.493+50 to Sta. 495+50 Sta.509+46 to Sta. 511+46
0.058	To be attained To be removed	Sta. 521+39 to Sta. 523+39 Sta. 535+70 to Sta. 537+70
0.058	To be attained To be removed	Sta. 565+01 to Sta. 567+01 Sta. 581+25 to Sta. 583+25
0.058	To be attained To be removed	Sta. 592+08 to Sta. 594+08 Sta. 603+63 to Sta. 605+63

PEDESTRIAN CROSSINGS IN AVA

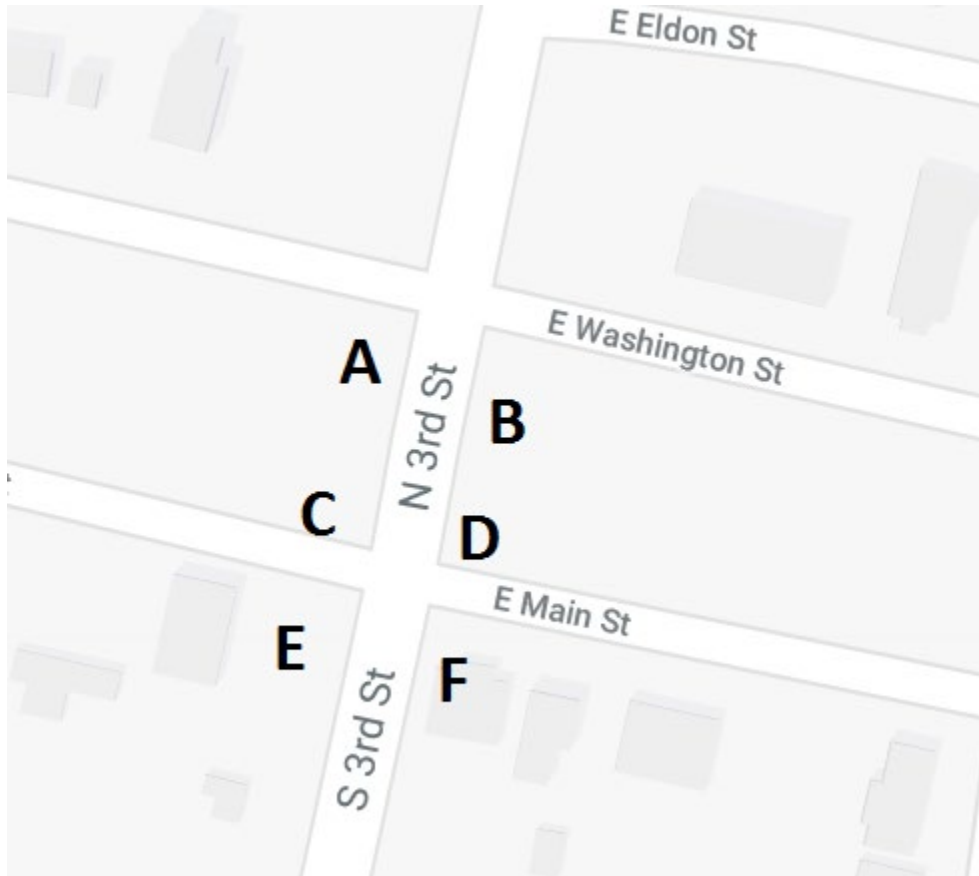

LOCATION	PORTLAND CEMENT CONCRETE SIDEWALK 4 INCH SQ FT	DETECTABLE WARNINGS SQ FT
A	27.0	9.0
B	27.0	9.0
C	27.0	9.0
D	27.0	9.0
E	27.0	20.0
F	135.0	9.0
TOTALS:	270.0	65.0

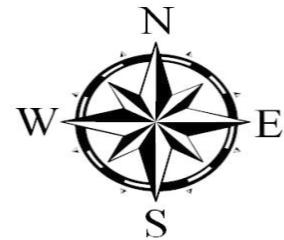

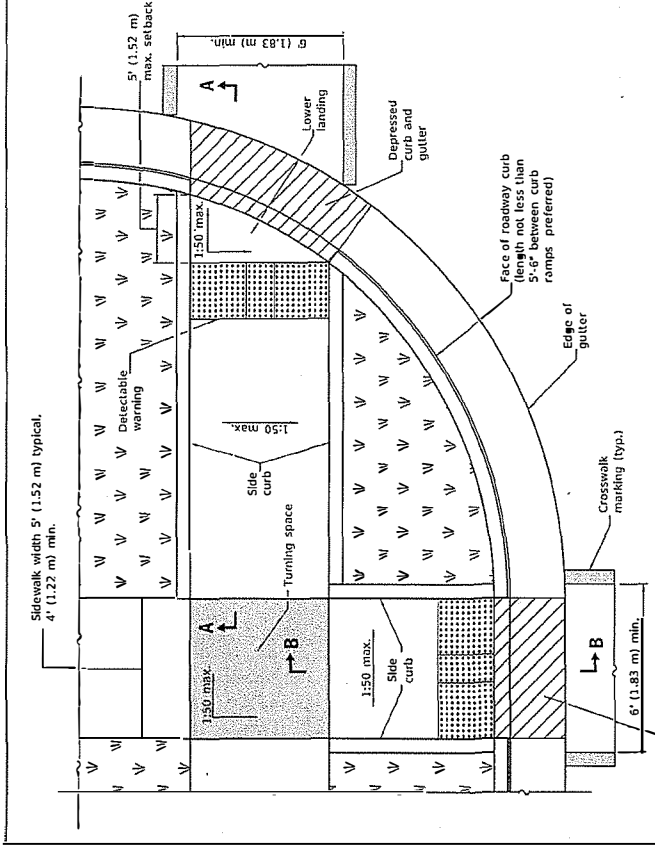

**RAMPS IN LANDSCAPED AREA
SETBACK ≤ 5'**

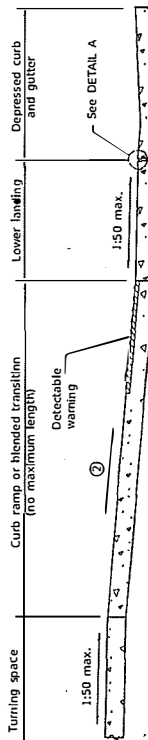

SECTION A-A

② The running slope of a curb ramp shall be 1:20 min. and 1:12 max. The running slope of a blended transition shall be 1:20 max.

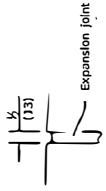

DETAIL A

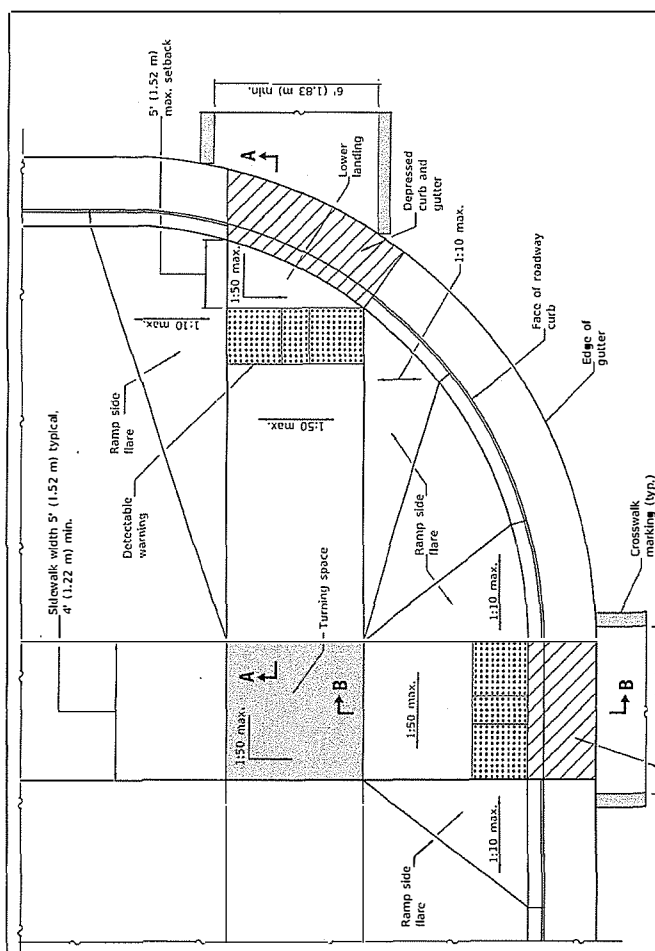

**RAMPS IN PAVED AREA
SETBACK ≤ 5'**

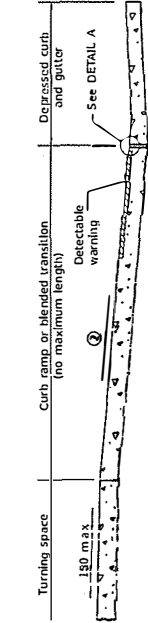

SECTION B-B

② The running slope of a curb ramp shall be 1:20 min. and 1:12 max. The running slope of a blended transition shall be 1:20 max.

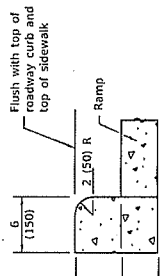

SIDE CURB DETAIL

See Sheet 2 for GENERAL NOTES.

**PERPENDICULAR CURB RAMPS
FOR SIDEWALKS**
(Sheet 1 of 2)

DATE	REVISIONS
1-1-19	Removed "15-foot rule", added "blended transitions" and placement tolerances for detectable warnings.
1-1-18	Omitted diagonal slope at turning spaces and lower landings.

STANDARD 424001-11

Illinois Department of Transportation
 PASSED: [Signature] 2019
 ENGINEER OF POLICY AND PROCEDURES
 APPROVED: [Signature] 2019
 REGISTERED PROFESSIONAL ENGINEER

ISSUED 1-1-07

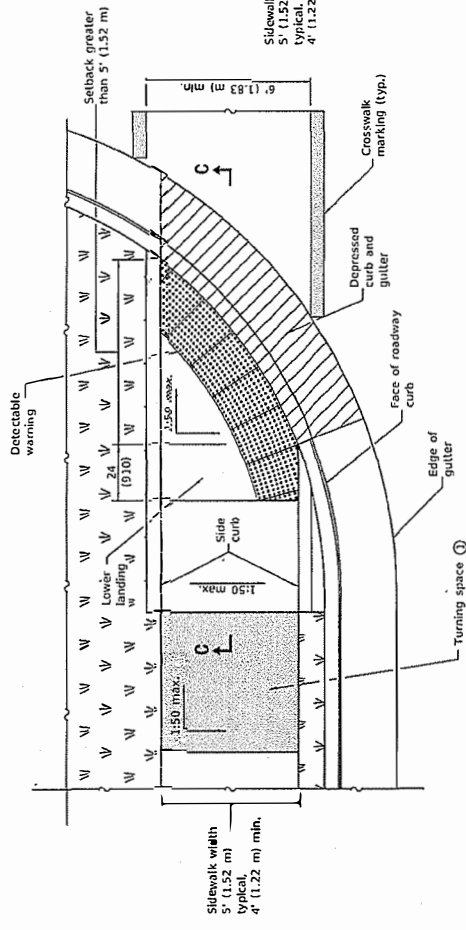
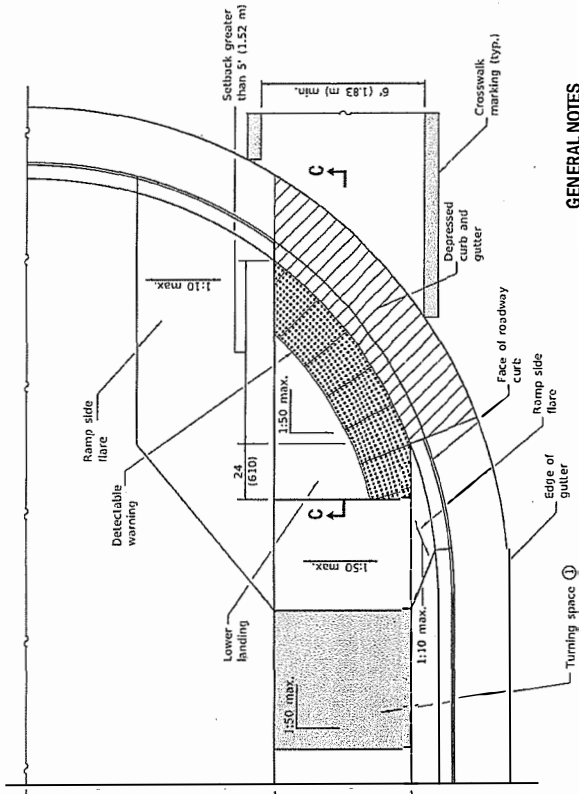

RAMP IN LANDSCAPED AREA
SETBACK > 5'

RAMP IN PAVED AREA
SETBACK > 5'

GENERAL NOTES

All slope ratios are expressed as units of vertical displacement to units of horizontal displacement (V:H).

Where the turning space is constrained on a side opposite a ramp, the minimum length of the turning space in the direction of the ramp-run shall be 5' (1.52 m).

Where 1:50 maximum slope is shown, 1:64 is preferred.

Detectable warnings are shown in their ideal locations but the following placement tolerances are allowed.

Side Border - Detectable warnings should extend the full width of the walking surface (excluding flared sides) but a border along each side up to 2 in. (50 mm) in width is allowed.

Curb Set-Back - Detectable warnings located at the back of curb should closely align with the curb but a gap up to 6 in. (150 mm) behind the curb is allowed.

See Standard 605001 for details of depressed curb adjacent to curb ramp.

All dimensions are in inches (millimeters) unless otherwise shown.



SECTION C-C

- ① This turning space not required for blended transitions.
- ② The running slope of a curb ramp shall be 1:20 min. and 1:12 max. The running slope of a blended transition shall be 1:20 max.

PERPENDICULAR CURB RAMPS FOR SIDEWALKS
(Sheet 2 of 2)

STANDARD 424001-11

	PASSED 12/20/20, 11/2019 2019	ISSUED 1-1-97
	APPROVED [Signature] ENGINEER OF PORTS AND PROCEDURES DIVISION 3, 2019	[Signature] ENGINEER OF DESIGN AND TECHNOLOGY

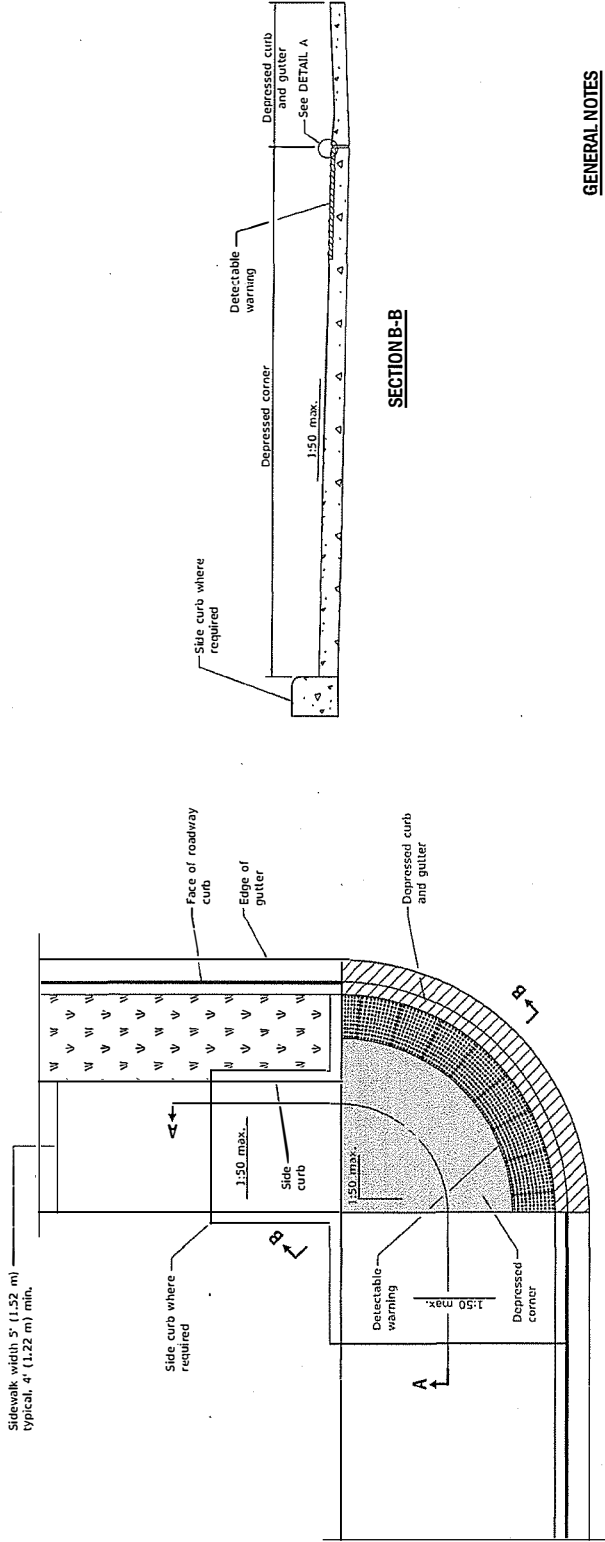

SECTION B-B

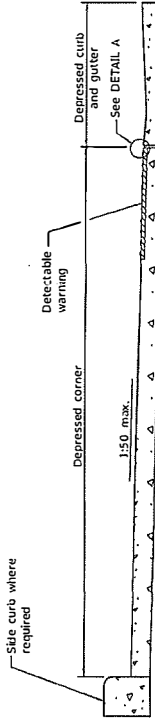

DEPRESSED CORNER

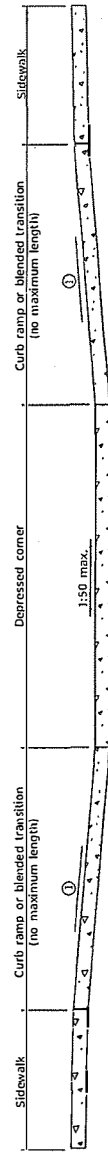

SECTION A-A

① The running slope of a curb ramp shall be 1:20 min. and 1:12 max. The running slope of a blended transition shall be 1:20 max.

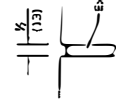

DETAIL A

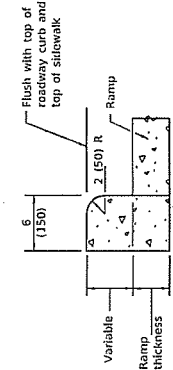

SIDE CURB DETAIL

GENERAL NOTES

- This standard shall only be used for curb radii of 6 ft. (1.83 m) or greater.
- All slope ratios are expressed as units of vertical displacement to units of horizontal displacement (V:H).
- Where 1:50 maximum slope is shown, 1:64 is preferred.
- Detectable warnings are shown in their ideal tolerances but the following placement tolerances are allowed.
- Side Border** - Detectable warnings should extend the full width of the walking surface (excluding the gutter) and be placed at least 2 in. (50 mm) from the curb. A gap up to 2 in. (50 mm) in width is allowed.
- Curb Set-Back** - Detectable warnings located at the back of curb should closely align with the curb but a gap up to 6 in. (150 mm) behind the curb is allowed.
- See Standard 606001 for details of depressed curb adjacent to curb ramp.
- All dimensions are in inches (millimeters) unless otherwise shown.

Illinois Department of Transportation
 PASSED BY [Signature] 2019
 ENGINEER OF POLICY AND PROCEDURES
 REGISTERED PROFESSIONAL ENGINEER
 ISSUED 1-1-12

DATE	REVISIONS
1-1-19	Removed upper landings, added blended transition and detectable warning tolerances.
1-1-18	Omitted diagonal slope at turning spaces and upper landings.

DEPRESSED CORNER FOR SIDEWALKS

STANDARD 424021-05

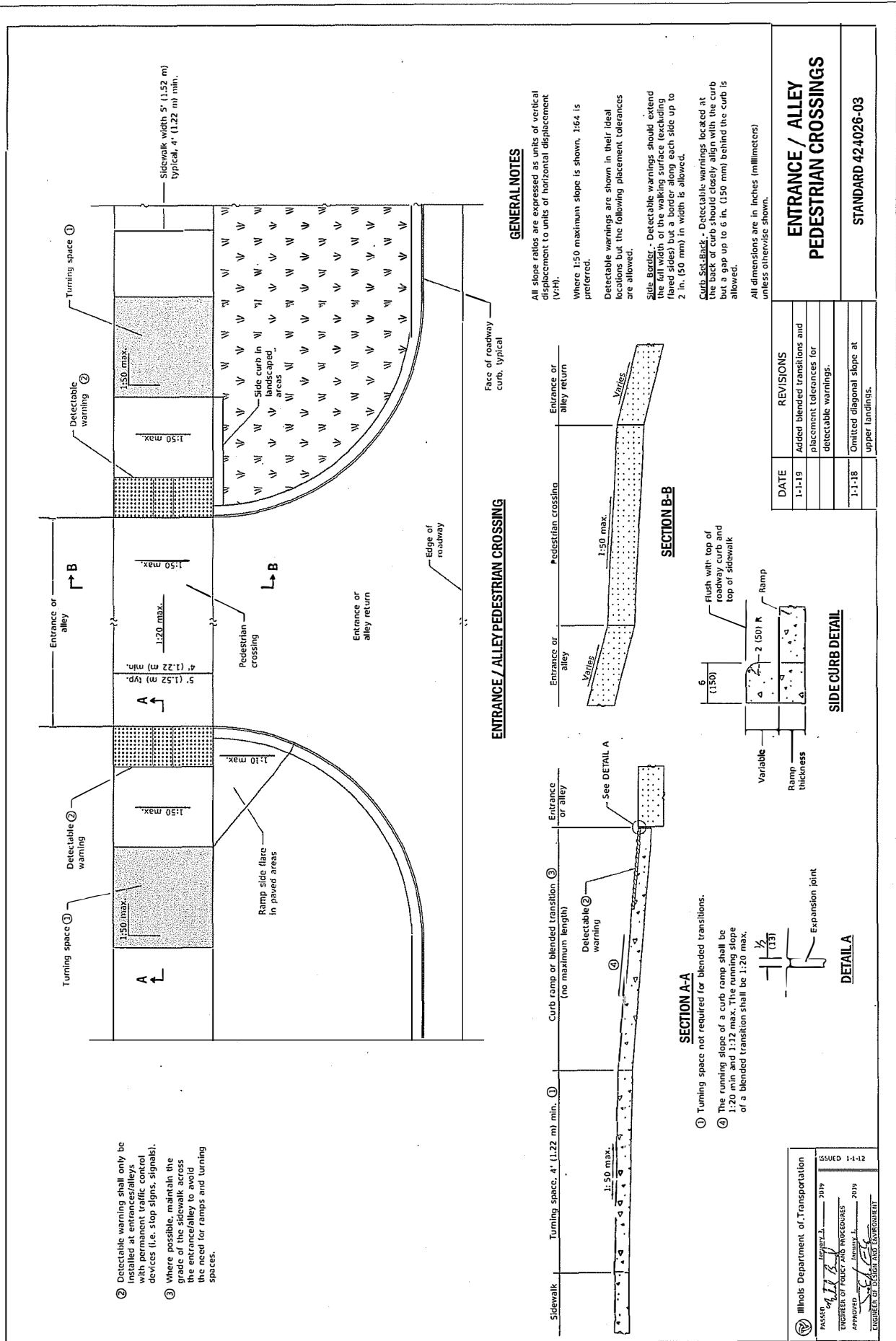

- ② Detectable warning shall only be installed at entrance/alleys with a minimum of three detectable devices (i.e. stop signs, signals).
- ③ Where possible, maintain the grade of the sidewalk across the entrance/alley to avoid the need for ramps and turning spaces.

ENTRANCE / ALLEY PEDESTRIAN CROSSING

GENERAL NOTES

All slope ratios are expressed as units of vertical displacement to units of horizontal displacement (V:H).

Where 1:50 maximum slope is shown, 1:64 is preferred.

Detectable warnings are shown in their ideal locations but the following placement tolerances are allowed.

Side Border - Detectable warnings should extend the full width of the walking surface (excluding flared sides) but a border along each side up to 2 in. (50 mm) in width is allowed.

Curb Set-Back - Detectable warnings located at the back of curb should closely align with the curb but a gap up to 6 in. (150 mm) behind the curb is allowed.

All dimensions are in inches (millimeters) unless otherwise shown.

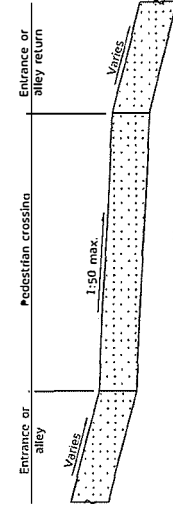

SECTION B-B

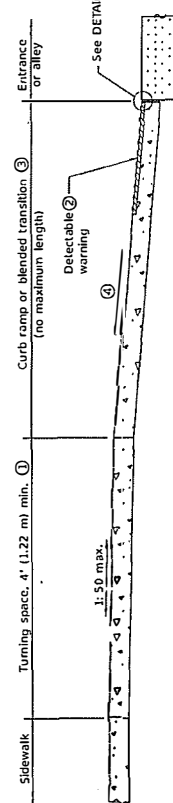

SECTION A-A

- ① Turning space not required for blended transitions.
- ④ The running slope of a curb ramp shall be 1:20 min and 1:12 max. The running slope of a blended transition shall be 1:20 max.



DETAIL A

DATE	REVISIONS
1-1-19	Added blended transitions and placement tolerances for detectable warnings.
1-1-18	Omitted diagonal slope at upper landings.

PASSED ILLINOIS DEPARTMENT OF TRANSPORTATION APPROVED ENGINEER OF POLICE AND PROCEDURES ISSUED 1-1-12	2019 2019 ENGINEER OF DESIGN AND ENVIRONMENT
---	--

ENTRANCE / ALLEY PEDESTRIAN CROSSINGS

STANDARD 42.4026-03

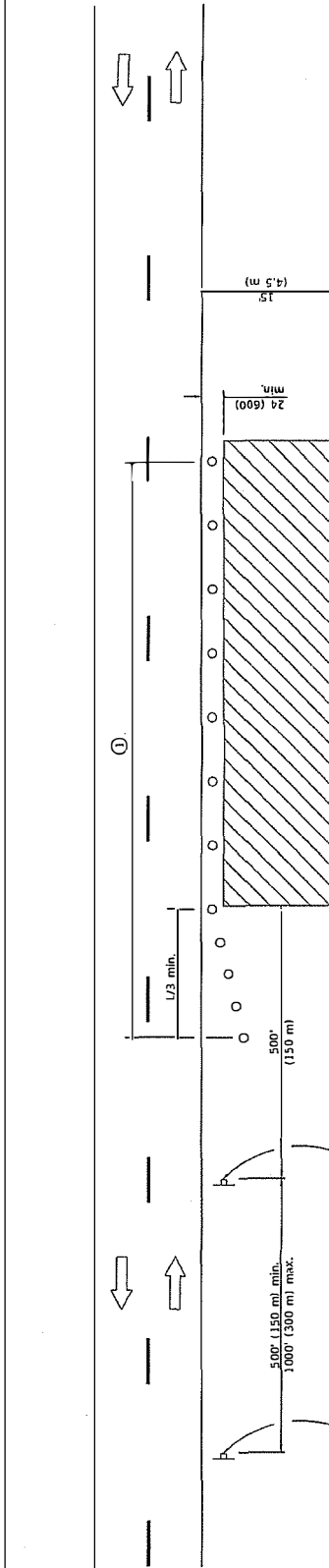

For contract construction projects

W20-110(0)-48

For maintenance and utility projects

W21-110(0)-48

① When the work operation exceeds one hour, cones, drums or barricades shall be placed at 25' (8 m) intervals and at 50' (15 m) centers through the remainder of the work area.

TYPICAL APPLICATIONS

- Utility operations
- Culvert extensions
- Site slope changes
- Overhaul installation and maintenance
- Landscaping operations
- Shoulder repair
- Sign installation and maintenance

SYMBOLS

- Work area
- Sign
- Cone, drum or barricade

GENERAL NOTES

This Standard is used where any vehicles, equipment, workers or their activities will encroach in the area 15' (4.5 m) to 24' (600) from the edge of pavement.

Calculate L as follows:

SPEED LIMIT	FORMULAS
40 mph (70 km/h) or less:	English (Metric) $L = \frac{WS^2}{200}$ $L = \frac{WS^2}{150}$
45 mph (80 km/h) or greater:	$L = (W/S)$ $L = 0.65(V/S)$

W = Width of offset in feet (meters).

S = Normal posted speed mph (km/h).

All dimensions are in inches (millimeters) unless otherwise shown.

DATE	REVISIONS
1-1-14	Revised workers sign number to agree with current MUTCD.
1-1-13	Omitted text "WORKERS" sign.

OFF-RD OPERATIONS, 2L, 2W, 15' (4.5 m) TO 24" (600 mm) FROM PAVEMENT EDGE

STANDARD 701006-05

Illinois Department of Transportation

PASSED *[Signature]* 2014

APPROVED *[Signature]* 2014

ENGINEER OF SAFETY ENGINEERING

ENGINEER OF DESIGN AND ENVIRONMENT

ISSUED 1-1-07

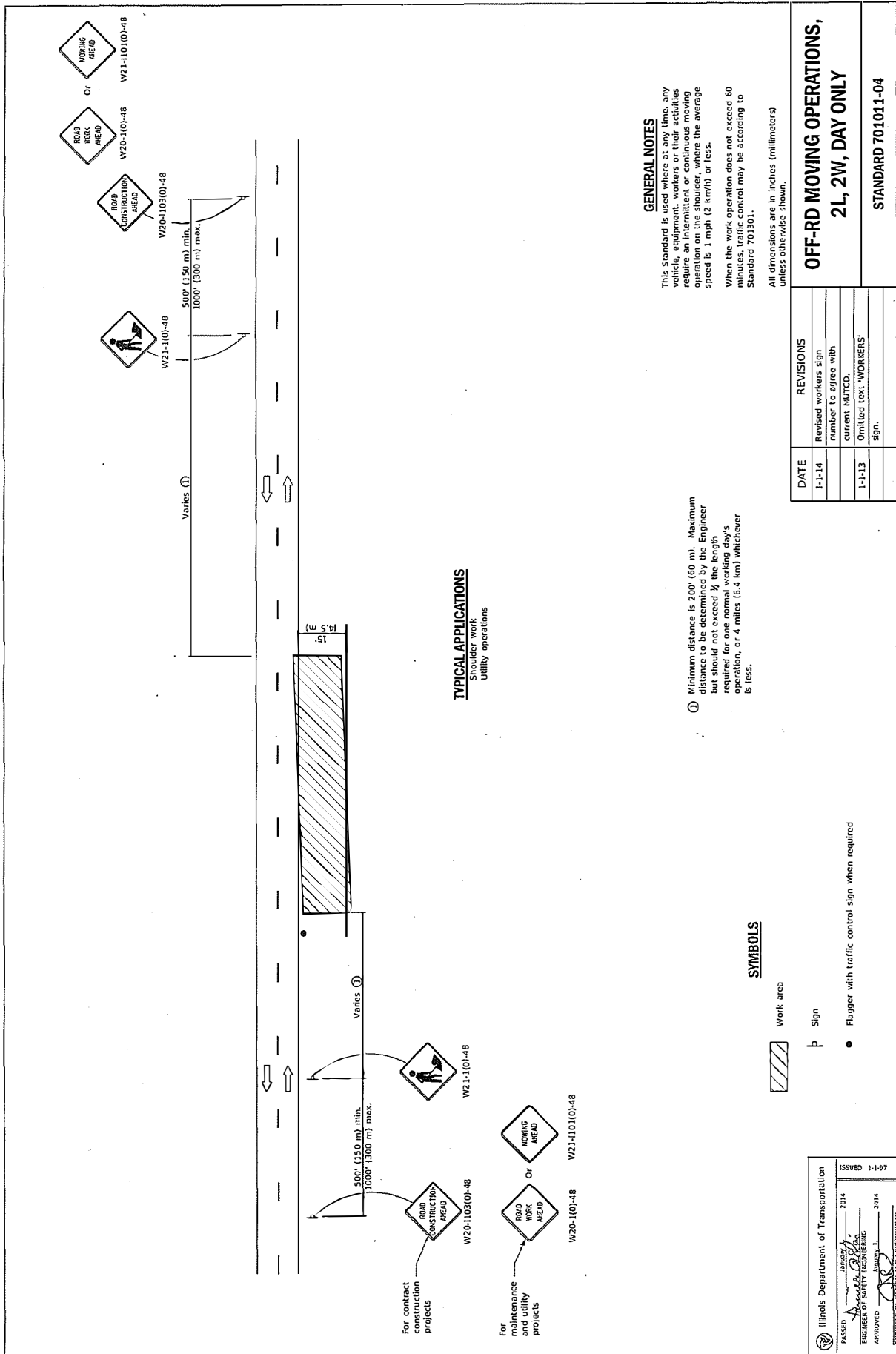

TYPICAL APPLICATIONS

Shoulder work
Utility operations

① Minimum distance is 700' (60 m). Maximum distance to be determined by the Engineer but should not exceed 1/2 the length required for one normal working day's operation, or 4 miles (6.4 km) whichever is less.

GENERAL NOTES

This Standard is used where at any time, any vehicle, equipment, workers or their activities require an intermittent or continuous moving operation on the shoulder, where the average speed is 1 mph (2 km/h) or less.
When the work operation does not exceed 60 minutes, traffic control may be according to Standard 701301.
All dimensions are in inches (millimeters) unless otherwise shown.

SYMBOLS

- Work area
- Sign
- Flagger with traffic control sign when required

**OFF-RD MOVING OPERATIONS,
2L, 2W, DAY ONLY**

STANDARD 701011-04

DATE	REVISIONS
1-1-14	Revised workers sign number to agree with current MUTCD.
1-1-13	Omitted text 'WORKERS' sign.

Illinois Department of Transportation
 PASSED 2014
 APPROVED 2014
 ISSUED 1-1-97
 ENGINEER OF DESIGN AND EQUIPMENT

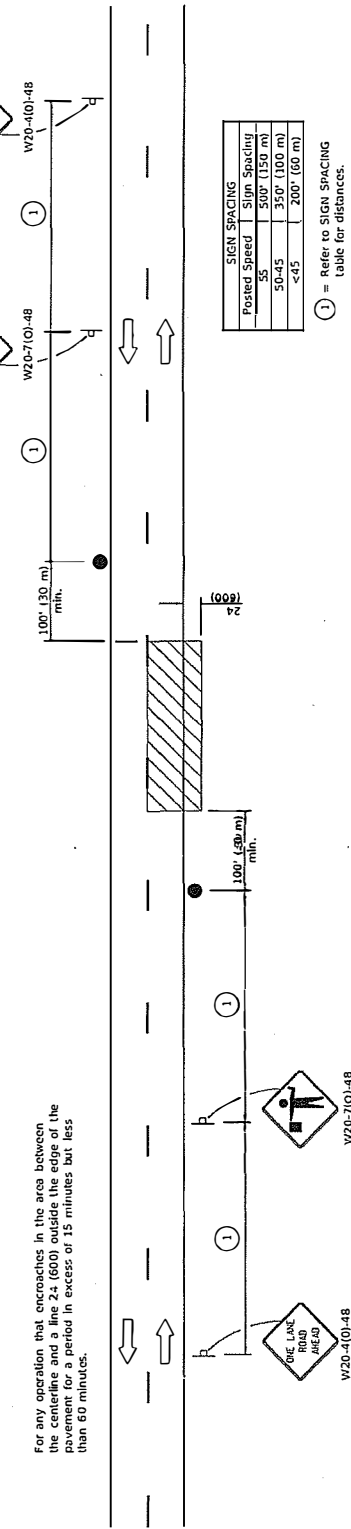
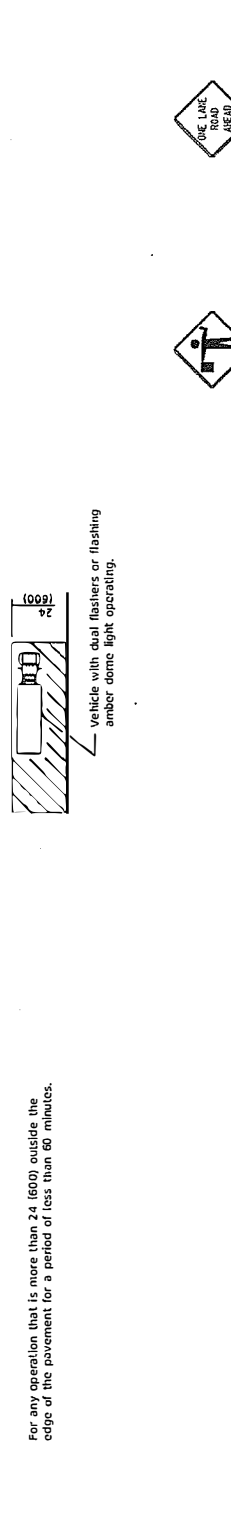
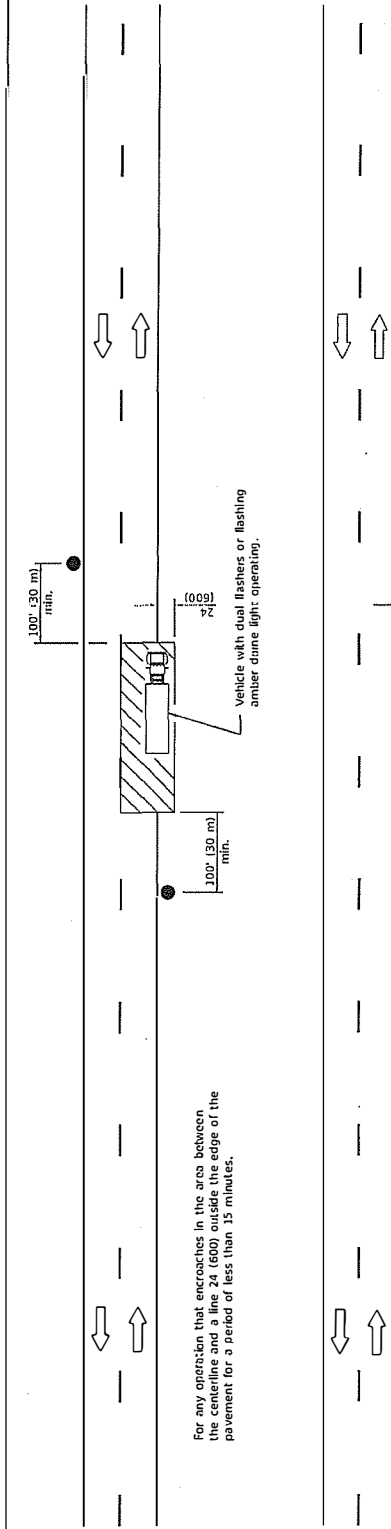

All dimensions are in inches (millimeters) unless otherwise shown.

SYMBOLS

- Work area
- Sign on portable or permanent support
- Flagger with traffic control sign

TYPICAL APPLICATIONS

- Marking patches
- Field survey
- String line
- Utility operations
- Cleaning up debris on pavement

LANE CLOSURE, 2L, 2W, SHORT TIME OPERATIONS

STANDARD 701301-04

DATE	REVISIONS
1-1-11	Revised flagger sign.
1-1-09	Switched units to English (metric).

ISSUED 1-1-07

Illinois Department of Transportation

APPROVED: [Signature]

ENGINEER OF DESIGN AND CONSTRUCTION

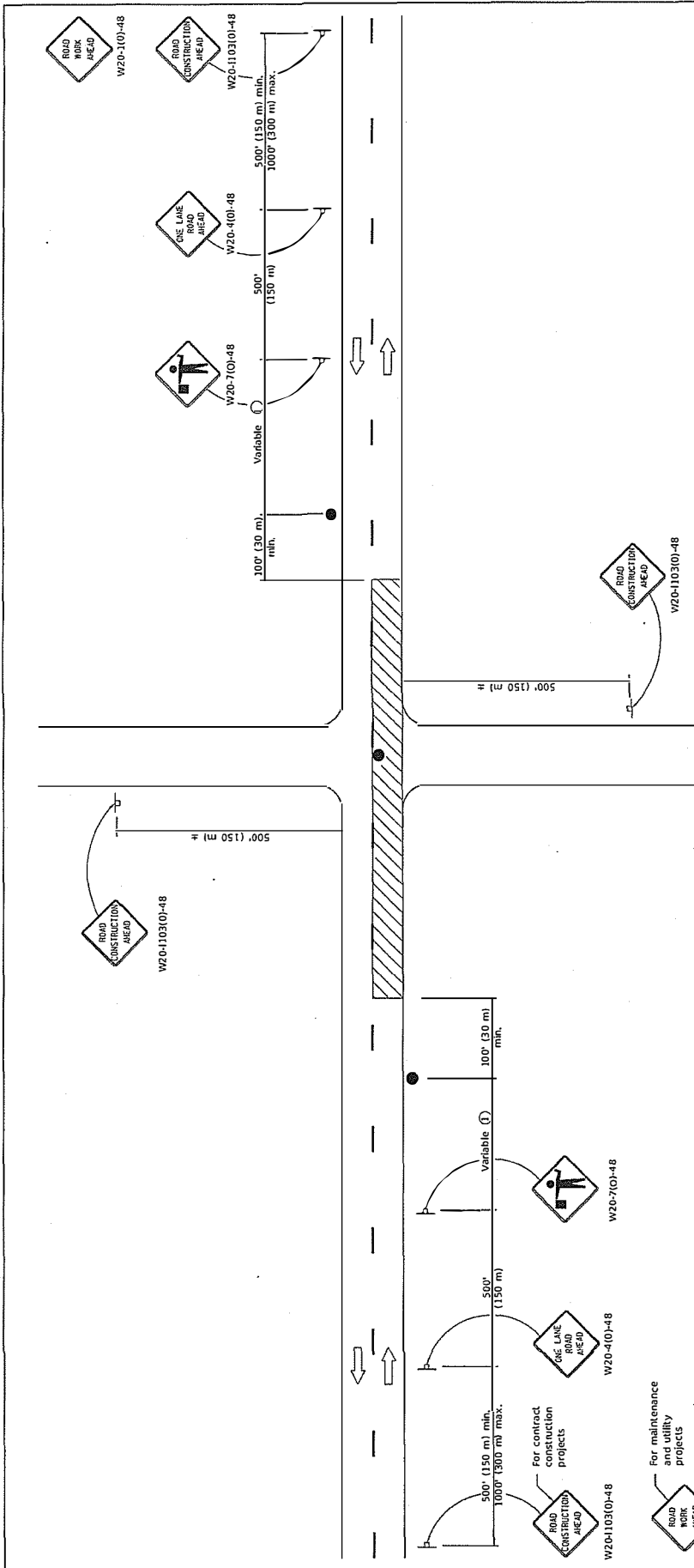

GENERAL NOTES

This Standard is used where at any time, any vehicle, equipment, workers or their activities require an intermittent or continuous moving operation on the pavement where the average speed of movement is greater than 1/2 mph (1 km/h) and less than 4 mph (6 km/h).
When the operation does not exceed 60 minutes, the contractor may be according to Standard 701301.

① Minimum distance is 200' (60 m). Maximum distance to be determined by the Engineer but should not exceed 1/2 the length required for one normal working day's operation or 2 miles (3200 m), whichever is less.

TYPICAL APPLICATIONS

- Bituminous resurfacing
- Paving operations
- Utility operations
- Shoulder operations

SYMBOLS

- Work area
- Sign on portable or permanent support
- Flagger with traffic control sign

PASSED	ILLINOIS DEPARTMENT OF TRANSPORTATION	ISSUED 1-1-97
	JANUARY 1, 2018	
APPROVED	ENGINEER OF SAFETY PROG. AND ENGINEERING	
	JANUARY 1, 2018	
	MANAGER	
	EMPLOYEE OF DESIGN AND ENVIRONMENT	

DATE	REVISIONS
1-1-18	Revised lower speed limit for operation to 1/2 mph.
1-1-11	Revised flagger sign.

LANE CLOSURE, 2L, 2W, SLOW MOVING OPERATIONS DAY ONLY, FOR SPEEDS ≥ 45 MPH

STANDARD 701306-04

All dimensions are in inches (millimeters) unless otherwise shown.

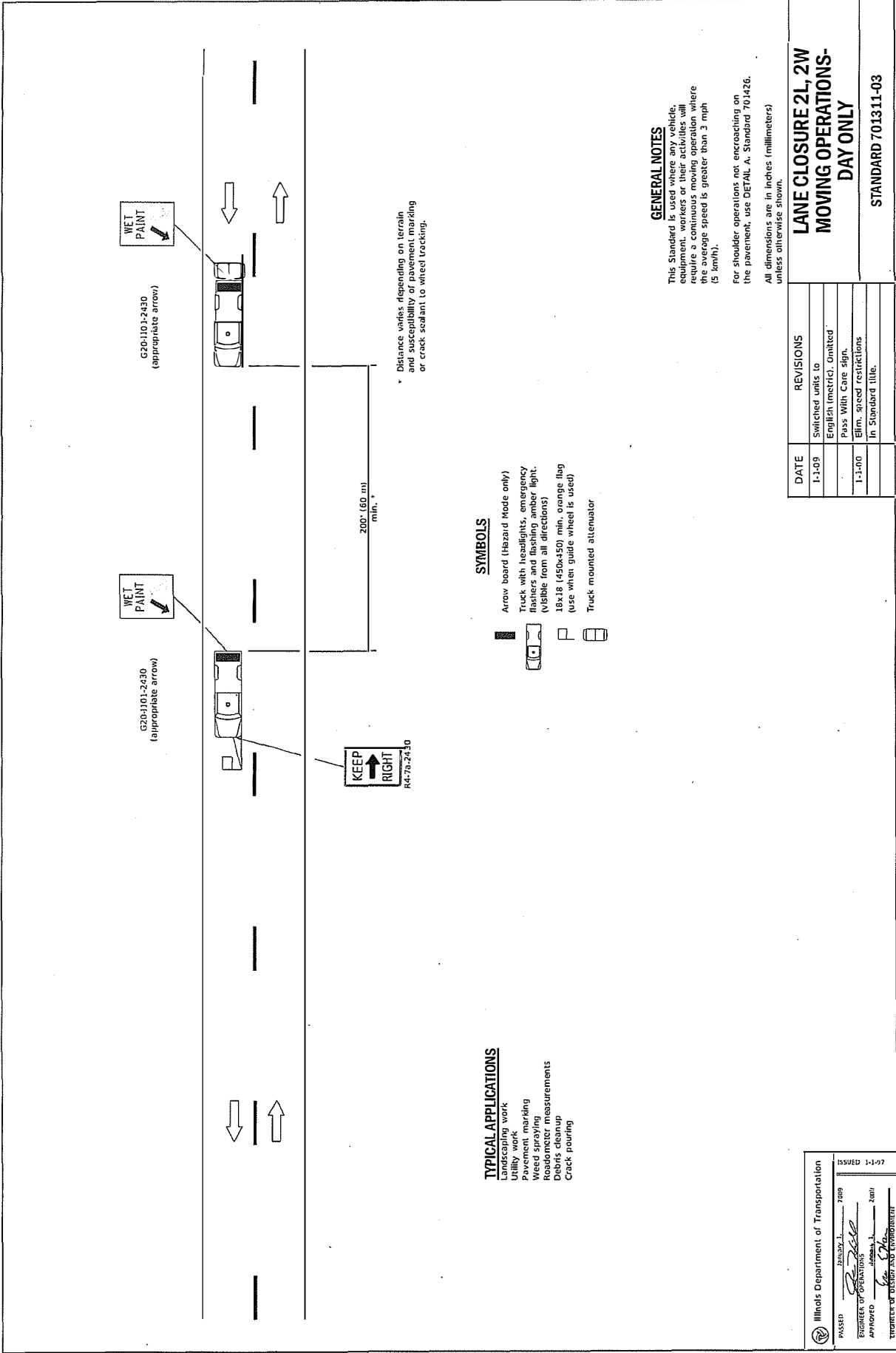

TYPICAL APPLICATIONS

- Landscaping work
- Utility work
- Pavement marking
- Weed spraying
- Roadmeter measurements
- Debris cleanup
- Crack pouring

SYMBOLS

- Arrow board (Hazard Mode only)
- Truck with headlights, emergency flashers and flashing amber light (Visible from all directions)
- 18x18 (450x450) min. orange flag (use when guide wheel is used)
- Truck mounted attenuator

GENERAL NOTES

This Standard is used where any vehicle, equipment, workers or their activities will require a continuous moving operation where the average speed is greater than 3 mph (5 km/h).

For shoulder operations not encroaching on the pavement, use DETAIL A, Standard 701426. All dimensions are in inches (millimeters) unless otherwise shown.

REVISIONS	
DATE	REVISIONS
1-1-09	Switched units to English (metric). Omitted "Pass With Care Sign. Elim. speed restrictions in Standard title.
1-1-00	

LANE CLOSURE 2L, 2W MOVING OPERATIONS- DAY ONLY

STANDARD 701311-03

ISSUED 1-1-07
 PREPARED BY: [Signature] 2009
 ENGINEER OF OPERATIONS: [Signature]
 APPROVED BY: [Signature] 2009
 OFFICE OF DESIGN AND CONSTRUCTION

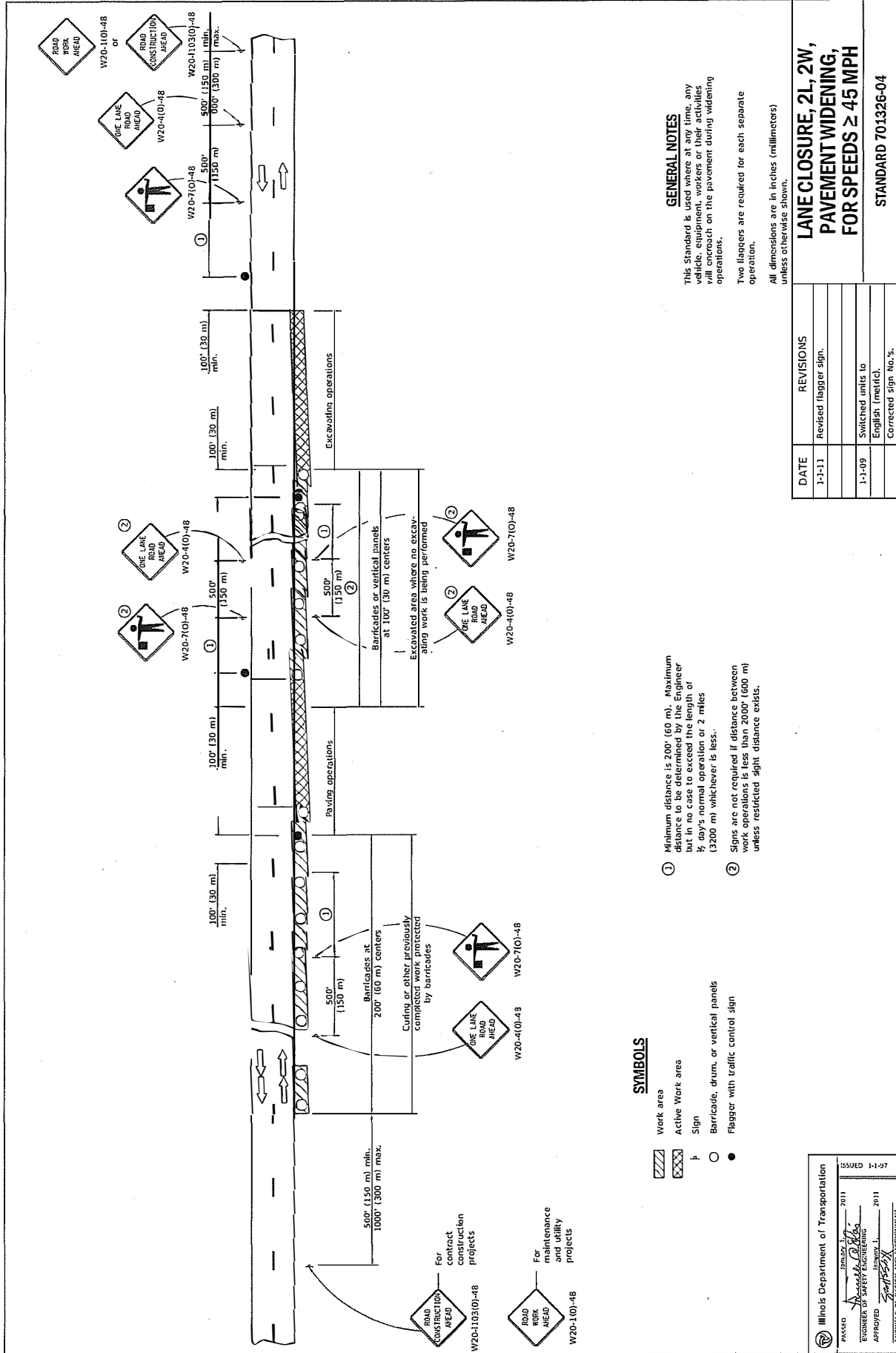

SYMBOLS

- Work area
- Active Work area
- Sign
- Barricade, drum, or vertical panels
- Flagger with traffic control sign

- ① Minimum distance is 200' (60 m). Maximum distance is determined by the Engineer but in no case to exceed the length of 1/2 day's normal operation or 2 miles (3200 m) whichever is less.
- ② Signs are not required if distance between work operations is less than 2000' (600 m) unless restricted sight distance exists.

GENERAL NOTES
 This Standard is used where at any time, any vehicle, equipment, workers or their activities will encroach on the pavement during widening operations.
 Two flaggers are required for each separate operation.
 All dimensions are in inches (millimeters) unless otherwise shown.

REVISIONS	
DATE	REVISIONS
1-1-11	Revised flagger sign.
1-1-09	Switched units to English (metric).
	Corrected sign No.'s.

**LANE CLOSURE, 2L, 2W,
 PAVEMENT WIDENING,
 FOR SPEEDS ≥ 45 MPH**

STANDARD 701326-04

Illinois Department of Transportation
 ISSUED 1-1-07

APPROVED
 ENGINEER OF SAFETY ENGINEERING
 IN CHARGE

DESIGNED AND DRAWN BY
 ENGINEER OF DESIGN AND EQUIPMENT

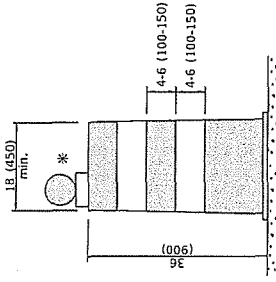

DRUM

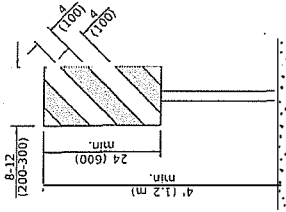

VERTICAL PANEL
POST MOUNTED

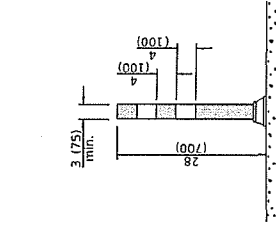

TUBULAR MARKER

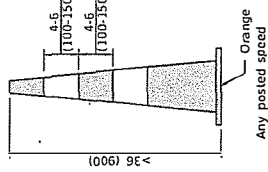

DAY OR NIGHTTIME USE

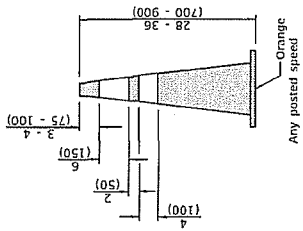

CONES

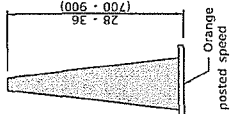

DAYTIME USE

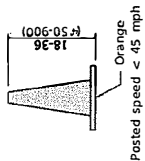

Posted speed < 45 mph

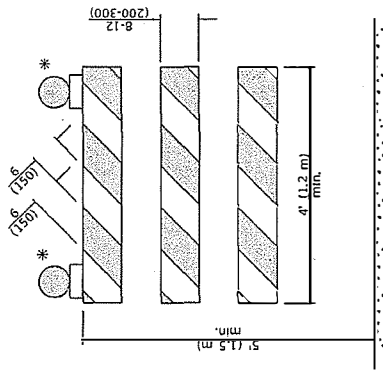

TYPE III BARRICADE

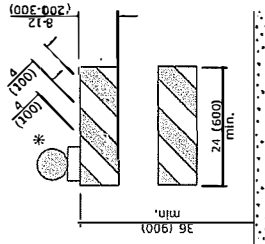

TYPE II BARRICADE

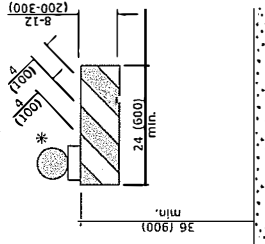

TYPE I BARRICADE

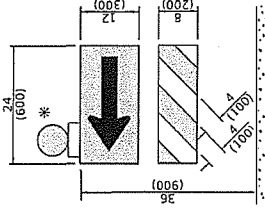

DIRECTION INDICATOR
BARRICADE

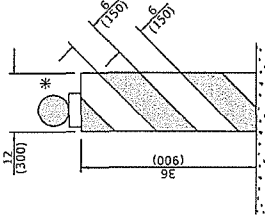

VERTICAL BARRICADE

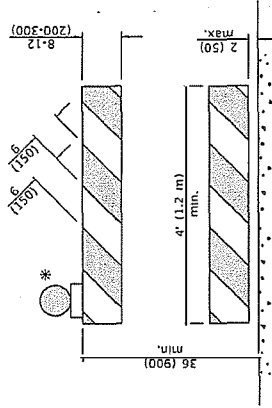

DETECTABLE PEDESTRIAN
CHANNELIZING BARRICADE

* Warning lights (if required)

GENERAL NOTES

All heights shown shall be measured above the pavement surface.
All dimensions are in inches (millimeters) unless otherwise shown.

DATE	REVISIONS
1-1-19	Revised cone usage and added cones >36" (900 mm) height
1-1-18	Revised END WORK ZONE SPEED LIMIT sign from orange to white background.

TRAFFIC CONTROL DEVICES

(Sheet 1 of 3)

STANDARD 701901-08

Illinois Department of Transportation
 Approved: [Signature] 2018
 ENGINEER OF SURVEYING, ROAD AND PAVEMENTING
 APP-610-2-1-2019
 ENGINEER OF DESIGN AND ENVIRONMENT

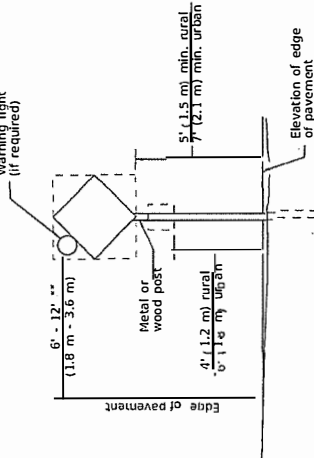

5'-11.5 m. min. embedment.

POST MOUNTED SIGNS

** When curb or paved shoulder are present this dimension shall be 24 (600) to the face of curb or 6' (1.8 m) to the outside edge of the paved shoulder.

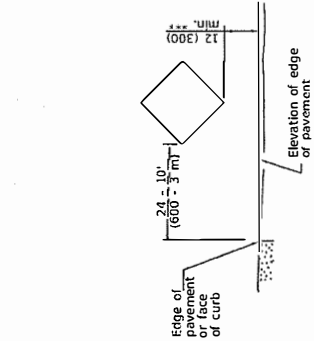

SIGNS ON TEMPORARY SUPPORTS

*** When work operations exceed four days, this dimension shall be 5' (1.5 m) min. If located behind other devices, the height shall be 10' (3.0 m) min. and shall be completely above the devices.

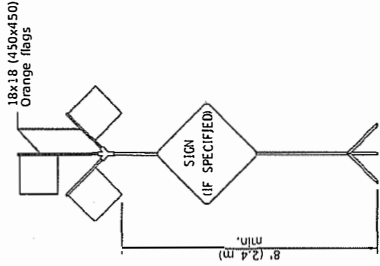

HIGH LEVEL WARNING DEVICE

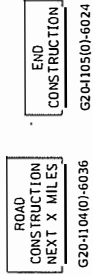

This signing is required for all projects 2 miles (3200 m) or more in length.
 ROAD CONSTRUCTION NEXT X MILES sign shall be placed 500' (150 m) in advance of project limits.
 END CONSTRUCTION sign shall be erected at the end of the job unless another job is within 2 miles (3200 m).
 Dual sign displays shall be utilized on multi-lane highways.

WORK LIMIT SIGNING

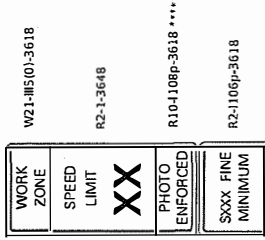

Sign assembly as shown on Standards or as allowed by District Operations.

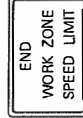

This sign shall be used when the above sign assembly is used.

HIGHWAY CONSTRUCTION SPEED ZONE SIGNS

**** R10-108p shall only be used along roadways under the jurisdiction of the State.

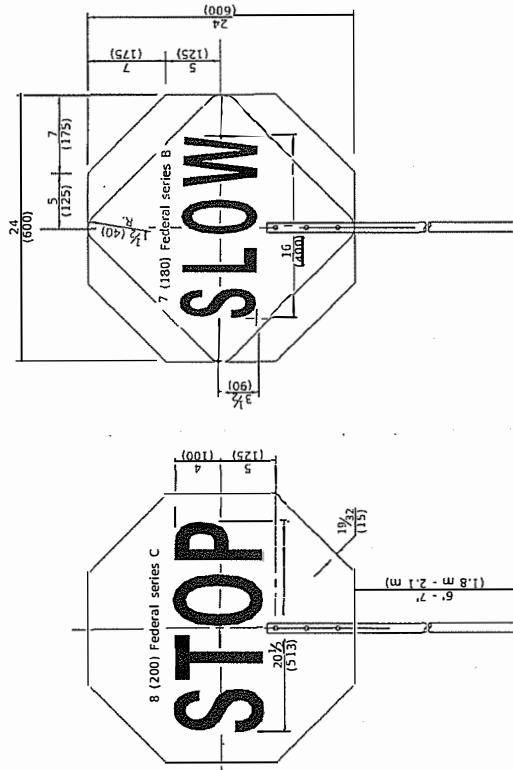

FRONT SIDE

REVERSE SIDE

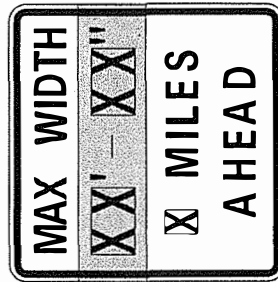

W12-1103-4848

WIDTH RESTRICTION SIGN

XX'-XX' width and X miles are variable.

Illinois Department of Transportation
 APPROVED: [Signature] January 1, 2019
 ENGINEER OF SAFETY PROB. AND ENGINEERING
 APPROVED: [Signature] January 1, 2019
 ENGINEER OF ENERGY AND ENVIRONMENT

FLAGGER TRAFFIC CONTROL SIGN

TRAFFIC CONTROL DEVICES

(Sheet 2 of 3)

STANDARD 701901-08

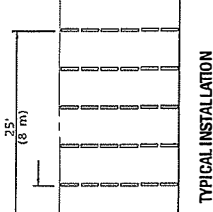
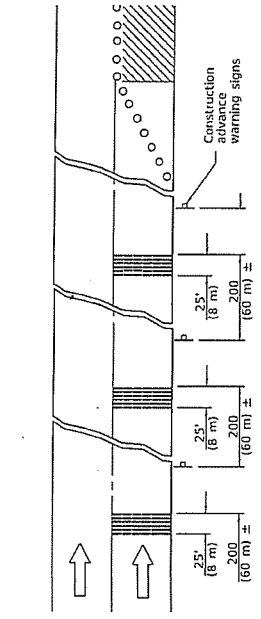

TYPICAL INSTALLATION

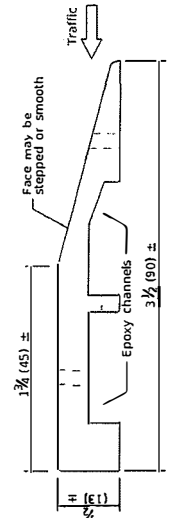
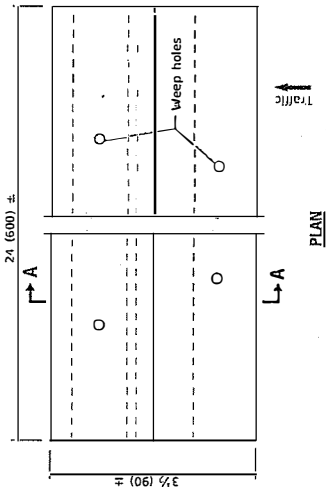

TEMPORARY RUMBLE STRIPS

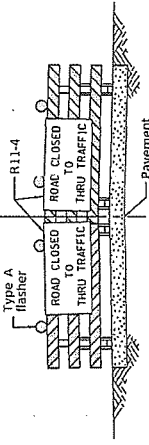
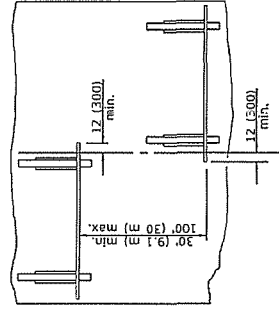

ROAD CLOSED TO THRU TRAFFIC

Reflectized striping shall appear on both sides of the barricades. If a sign panel which meets NCHRP 350 is not available, the signs may be mounted on NCHRP 350 temporary sign supports directly in front of the barricade.

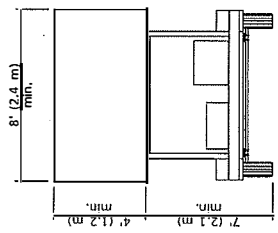

TYPE C ARROW BOARD TRAILER MOUNTED

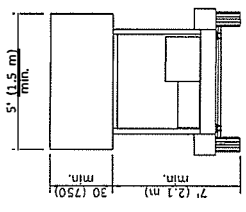

TYPE B ARROW BOARD ROOF OR TRAILER MOUNTED

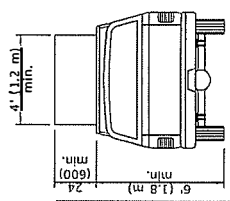

TYPE A ARROW BOARD ROOF MOUNTED

ARROW BOARDS

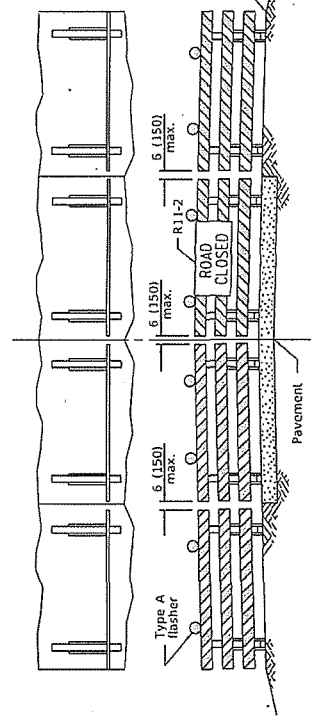

ROAD CLOSED TO ALL TRAFFIC

Reflectized striping may be omitted if a Type III barricade with an attached sign panel which meets NCHRP 350 is not available, the sign may be mounted on an NCHRP 350 temporary sign support directly in front of the barricade.

TYPICAL APPLICATIONS OF TYPE III BARRICADES CLOSING A ROAD

Illinois Department of Transportation

APPROVED: [Signature] 7919

ENGINEER OF SAFETY PROG. AND ENGINEERING

ISSUED 1-1-13

APPROVED: [Signature] 7913

ENGINEER OF SAFETY AND ENGINEERING

TRAFFIC CONTROL DEVICES

(Sheet 3 of 3)

STANDARD 701901-08

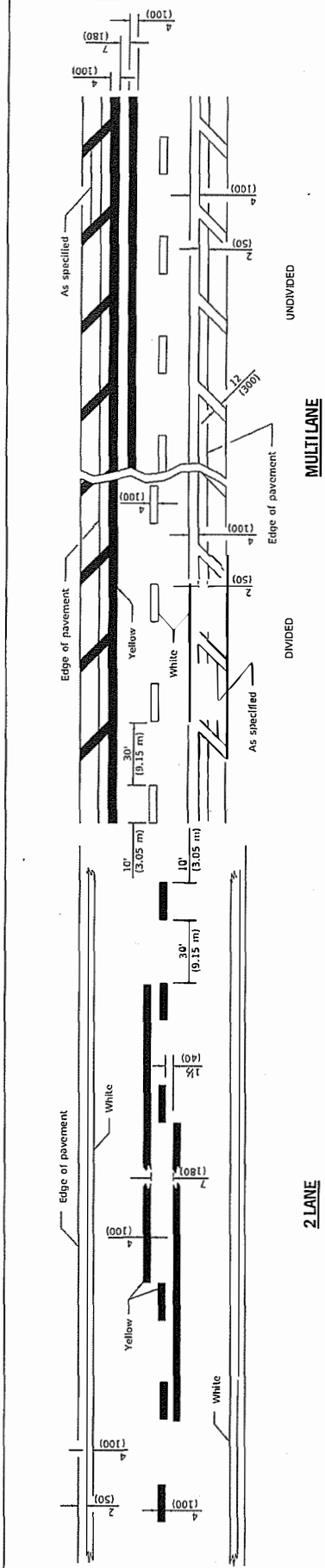

LANE AND EDGE LINES

2 LANE

MULTILANE

DIVIDED

UNDIVIDED

Approximately 15' (4.5 m) from nearest rail or 8' (2.4 m) back from gate, if present. Stop line placed perpendicular to center line.

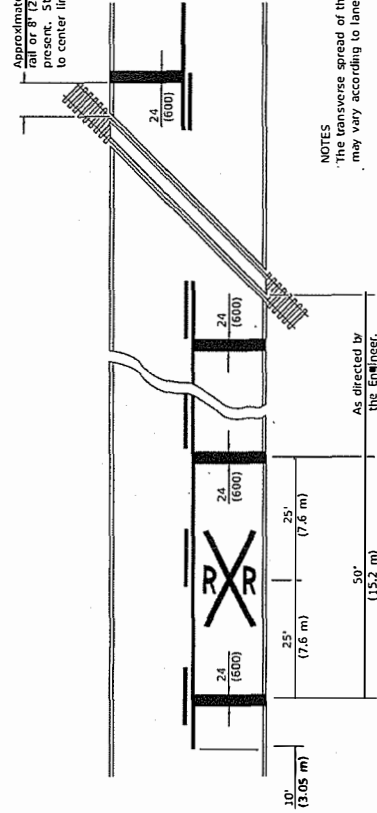

NOTES
The transverse spread of the 'X' may vary according to lane width.
On multi-lane roads, the stop lines shall extend across all approach lanes and separate RRR symbols shall be placed adjacent to each other in each lane.
When the pavement marking symbol is used, a portion of the symbol should be placed directly adjacent to the Advance Warning Sign (W10-1) as placed by Table 2C-4, Condition B of the MUTCD.

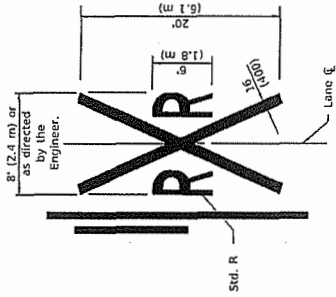

All dimensions are in inches (millimeters) unless otherwise shown.

PAVEMENT MARKINGS AT RAILROAD-HIGHWAY GRADE CROSSING

DATE	REVISIONS
1-1-15	Added symbols. Revised bike symbol. Revised note for stop line at RR crossing.
3-1-14	Added bike symbol. Renamed 'LANE DROP ARROW' detail to 'LANE-REDUCTION ARROW'.

Illinois Department of Transportation
 1/15/15
 ISSUED 1-1-07
 APPROVED
 ENGINEER OF OPERATIONS
 ENGINEER OF DESIGN AND ENVIRONMENT

TYPICAL PAVEMENT MARKINGS

(Sheet 1 of 2)

STANDARD 780001-05

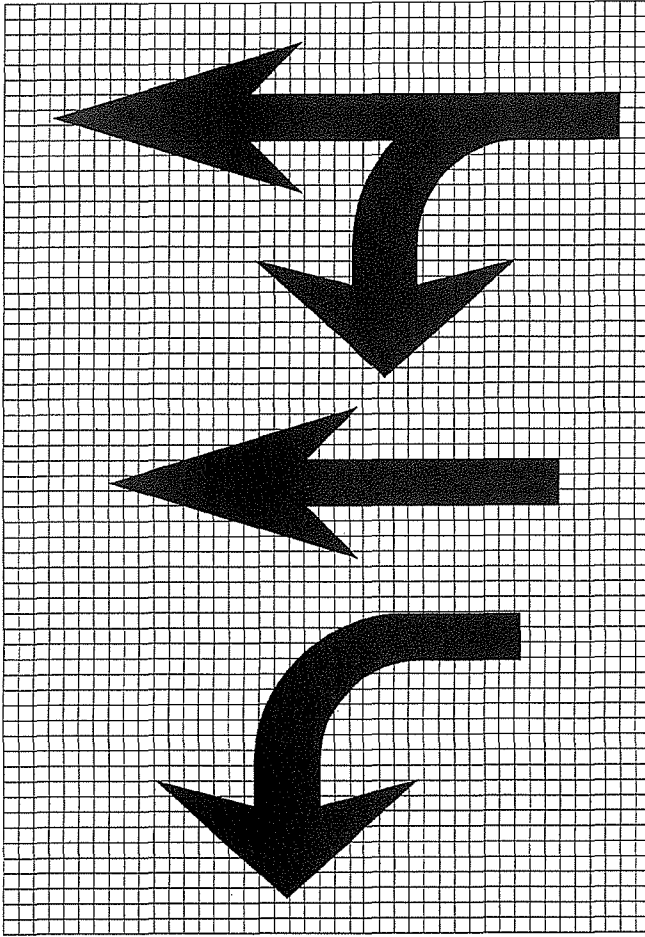
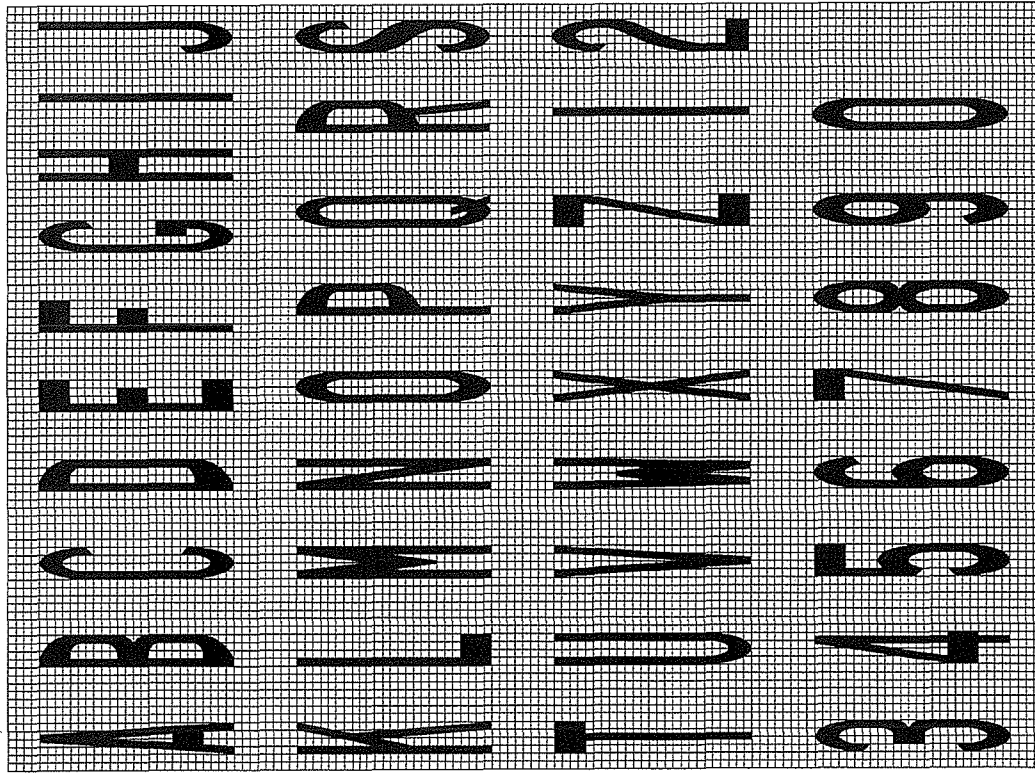

Legend Height	Arrow Size	a
6' (1.8 m)	Small	2.9 (74)
8' (2.4 m)	Large	3.8 (96)

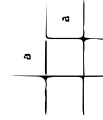

The space between adjacent letters or numerals should be approximately 3/75 for 6' (1.8 m) legend and 4/100 for 8' (2.4 m) legend.

LETTER AND ARROW GRID SCALE

Illinois Department of Transportation

ISSUED 1-1-97

DESIGNED BY: [Signature] 2015

APPROVED BY: [Signature] 2015

REGISTERED PROFESSIONAL ENGINEER OF OPERATIONS

REGISTERED PROFESSIONAL ENGINEER OF DESIGN AND CONSTRUCTION

TYPICAL PAVEMENT MARKINGS

(Sheet 2 of 3)

STANDARD 780001-05

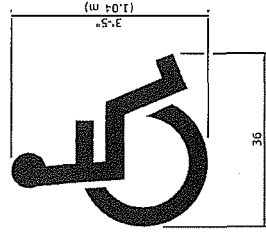

INTERNATIONAL SYMBOL OF ACCESSIBILITY

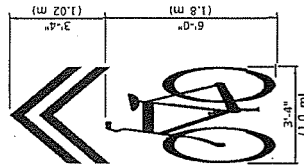

SHARED LANE SYMBOL

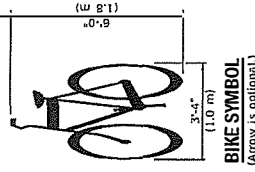

BIKE SYMBOL
(Arrow is optional)

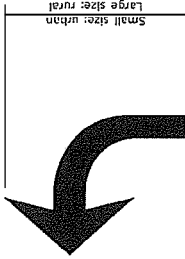
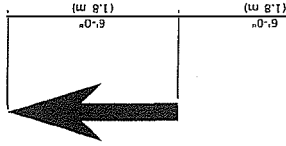

20' (6.1 m): urban
50' (15.2 m): rural
(between arrow
heads and words)

ONLY

WORD AND ARROW LAYOUT

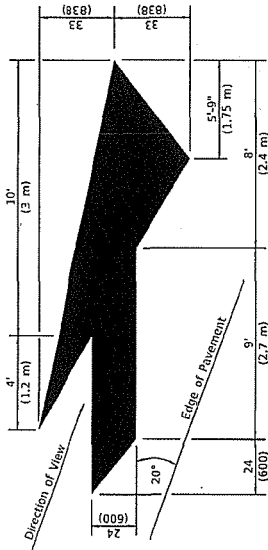

LANE-REDUCTION ARROW

Right lane-reduction arrow shown.
Use mirror image for left lane.

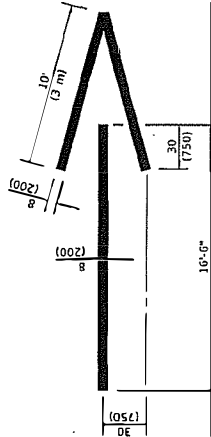

WRONG WAY ARROW

Illinois Department of Transportation
 PASSED January 1, 2015
 ENGINEER OF OPERATIONS
 APPROVED January 1, 2015
 SUPERVISOR OF DESIGN AND ENVIRONMENT

TYPICAL PAVEMENT MARKINGS

(Sheet 2 of 3)

STANDARD 780001-05

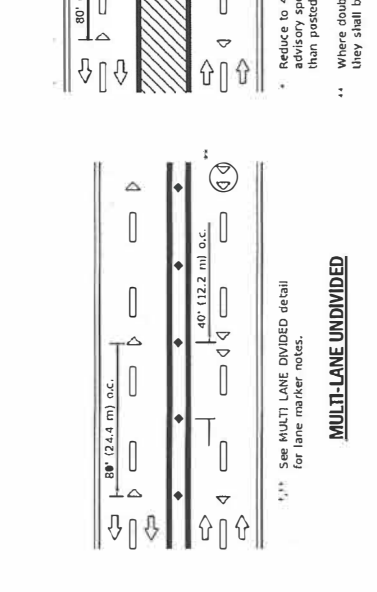
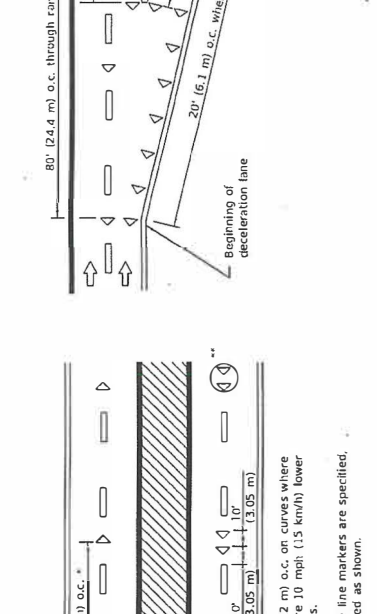
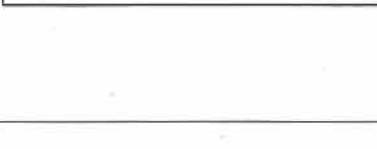
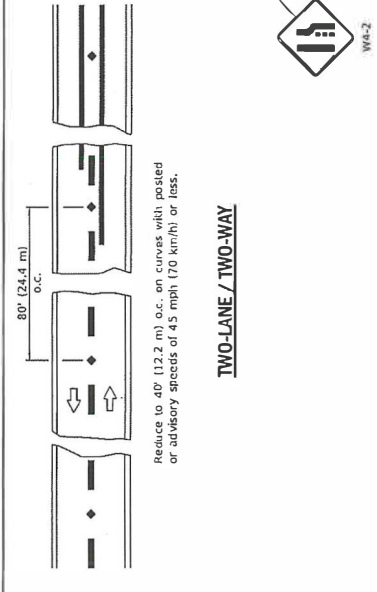
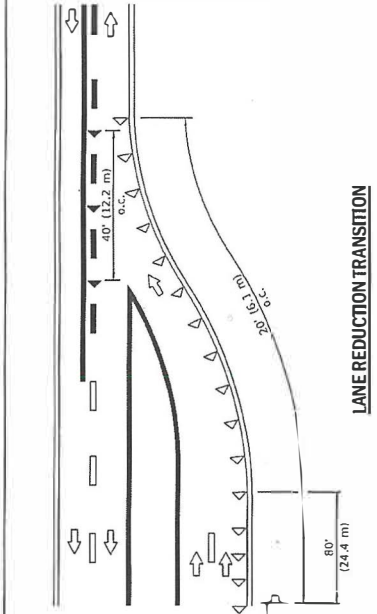

- SYMBOLS**
- Yellow stripe
 - White stripe
 - One-way amber marker
 - One-way crystal marker
 - Two-way amber marker

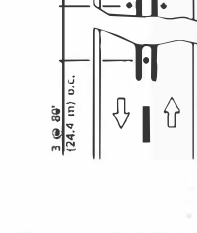
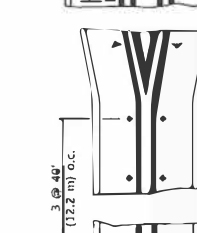
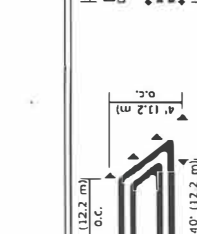
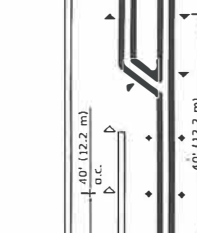
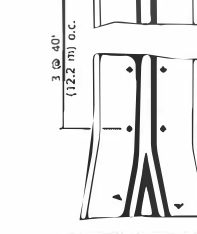
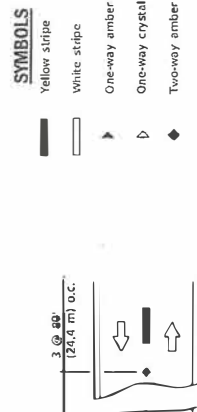

All dimensions are in inches (millimeters) unless otherwise shown.

**TYPICAL APPLICATIONS
RAISED REFLECTIVE
PAVEMENT MARKERS**

DATE	REVISIONS
4-1-16	Revised LANE ENDS sign
WA-2 to agree with current MUTCD.	
1-1-09	Switched units to English (metric).

STANDARD 78.1001-04

Illinois Department of Transportation
 PASSED: 2/28/16
 ENGINEER OF TRANSPORTATION
 ISSUED: 1-1-97
 2016

**REQUIRED CONTRACT PROVISIONS
FEDERAL-AID CONSTRUCTION CONTRACTS**

- I. General
- II. Nondiscrimination
- III. Nonsegregated Facilities
- IV. Davis-Bacon and Related Act Provisions
- V. Contract Work Hours and Safety Standards Act Provisions
- VI. Subletting or Assigning the Contract
- VII. Safety: Accident Prevention
- VIII. False Statements Concerning Highway Projects
- IX. Implementation of Clean Air Act and Federal Water Pollution Control Act
- X. Compliance with Governmentwide Suspension and Debarment Requirements
- XI. Certification Regarding Use of Contract Funds for Lobbying

ATTACHMENTS

A. Employment and Materials Preference for Appalachian Development Highway System or Appalachian Local Access Road Contracts (included in Appalachian contracts only)

I. GENERAL

1. Form FHWA-1273 must be physically incorporated in each construction contract funded under Title 23 (excluding emergency contracts solely intended for debris removal). The contractor (or subcontractor) must insert this form in each subcontract and further require its inclusion in all lower tier subcontracts (excluding purchase orders, rental agreements and other agreements for supplies or services).

The applicable requirements of Form FHWA-1273 are incorporated by reference for work done under any purchase order, rental agreement or agreement for other services. The prime contractor shall be responsible for compliance by any subcontractor, lower-tier subcontractor or service provider.

Form FHWA-1273 must be included in all Federal-aid design-build contracts, in all subcontracts and in lower tier subcontracts (excluding subcontracts for design services, purchase orders, rental agreements and other agreements for supplies or services). The design-builder shall be responsible for compliance by any subcontractor, lower-tier subcontractor or service provider.

Contracting agencies may reference Form FHWA-1273 in bid proposal or request for proposal documents, however, the Form FHWA-1273 must be physically incorporated (not referenced) in all contracts, subcontracts and lower-tier subcontracts (excluding purchase orders, rental agreements and other agreements for supplies or services related to a construction contract).

2. Subject to the applicability criteria noted in the following sections, these contract provisions shall apply to all work performed on the contract by the contractor's own organization and with the assistance of workers under the contractor's immediate superintendence and to all work performed on the contract by piecework, station work, or by subcontract.

3. A breach of any of the stipulations contained in these Required Contract Provisions may be sufficient grounds for withholding of progress payments, withholding of final payment, termination of the contract, suspension / debarment or any other action determined to be appropriate by the contracting agency and FHWA.

4. Selection of Labor: During the performance of this contract, the contractor shall not use convict labor for any purpose within the limits of a construction project on a Federal-aid highway unless it is labor

performed by convicts who are on parole, supervised release, or probation. The term Federal-aid highway does not include roadways functionally classified as local roads or rural minor collectors.

II. NONDISCRIMINATION

The provisions of this section related to 23 CFR Part 230 are applicable to all Federal-aid construction contracts and to all related construction subcontracts of \$10,000 or more. The provisions of 23 CFR Part 230 are not applicable to material supply, engineering, or architectural service contracts.

In addition, the contractor and all subcontractors must comply with the following policies: Executive Order 11246, 41 CFR 60, 29 CFR 1625-1627, Title 23 USC Section 140, the Rehabilitation Act of 1973, as amended (29 USC 794), Title VI of the Civil Rights Act of 1964, as amended, and related regulations including 49 CFR Parts 21, 26 and 27; and 23 CFR Parts 200, 230, and 633.

The contractor and all subcontractors must comply with: the requirements of the Equal Opportunity Clause in 41 CFR 60-1.4(b) and, for all construction contracts exceeding \$10,000, the Standard Federal Equal Employment Opportunity Construction Contract Specifications in 41 CFR 60-4.3.

Note: The U.S. Department of Labor has exclusive authority to determine compliance with Executive Order 11246 and the policies of the Secretary of Labor including 41 CFR 60, and 29 CFR 1625-1627. The contracting agency and the FHWA have the authority and the responsibility to ensure compliance with Title 23 USC Section 140, the Rehabilitation Act of 1973, as amended (29 USC 794), and Title VI of the Civil Rights Act of 1964, as amended, and related regulations including 49 CFR Parts 21, 26 and 27; and 23 CFR Parts 200, 230, and 633.

The following provision is adopted from 23 CFR 230, Appendix A, with appropriate revisions to conform to the U.S. Department of Labor (US DOL) and FHWA requirements.

1. Equal Employment Opportunity: Equal employment opportunity (EEO) requirements not to discriminate and to take affirmative action to assure equal opportunity as set forth under laws, executive orders, rules, regulations (28 CFR 35, 29 CFR 1630, 29 CFR 1625-1627, 41 CFR 60 and 49 CFR 27) and orders of the Secretary of Labor as modified by the provisions prescribed herein, and imposed pursuant to 23 U.S.C. 140 shall constitute the EEO and specific affirmative action standards for the contractor's project activities under this contract. The provisions of the Americans with Disabilities Act of 1990 (42 U.S.C. 12101 et seq.) set forth under 28 CFR 35 and 29 CFR 1630 are incorporated by reference in this contract. In the execution of this contract, the contractor agrees to comply with the following minimum specific requirement activities of EEO:

a. The contractor will work with the contracting agency and the Federal Government to ensure that it has made every good faith effort to provide equal opportunity with respect to all of its terms and conditions of employment and in their review of activities under the contract.

b. The contractor will accept as its operating policy the following statement:

"It is the policy of this Company to assure that applicants are employed, and that employees are treated during employment, without regard to their race, religion, sex, color, national origin, age or disability. Such action shall include: employment, upgrading, demotion, or transfer; recruitment or recruitment advertising; layoff or termination; rates of pay or other forms of compensation; and selection

for training, including apprenticeship, pre-apprenticeship, and/or on-the-job training."

2. EEO Officer: The contractor will designate and make known to the contracting officers an EEO Officer who will have the responsibility for and must be capable of effectively administering and promoting an active EEO program and who must be assigned adequate authority and responsibility to do so.

3. Dissemination of Policy: All members of the contractor's staff who are authorized to hire, supervise, promote, and discharge employees, or who recommend such action, or who are substantially involved in such action, will be made fully cognizant of, and will implement, the contractor's EEO policy and contractual responsibilities to provide EEO in each grade and classification of employment. To ensure that the above agreement will be met, the following actions will be taken as a minimum:

a. Periodic meetings of supervisory and personnel office employees will be conducted before the start of work and then not less often than once every six months, at which time the contractor's EEO policy and its implementation will be reviewed and explained. The meetings will be conducted by the EEO Officer.

b. All new supervisory or personnel office employees will be given a thorough indoctrination by the EEO Officer, covering all major aspects of the contractor's EEO obligations within thirty days following their reporting for duty with the contractor.

c. All personnel who are engaged in direct recruitment for the project will be instructed by the EEO Officer in the contractor's procedures for locating and hiring minorities and women.

d. Notices and posters setting forth the contractor's EEO policy will be placed in areas readily accessible to employees, applicants for employment and potential employees.

e. The contractor's EEO policy and the procedures to implement such policy will be brought to the attention of employees by means of meetings, employee handbooks, or other appropriate means.

4. Recruitment: When advertising for employees, the contractor will include in all advertisements for employees the notation: "An Equal Opportunity Employer." All such advertisements will be placed in publications having a large circulation among minorities and women in the area from which the project work force would normally be derived.

a. The contractor will, unless precluded by a valid bargaining agreement, conduct systematic and direct recruitment through public and private employee referral sources likely to yield qualified minorities and women. To meet this requirement, the contractor will identify sources of potential minority group employees, and establish with such identified sources procedures whereby minority and women applicants may be referred to the contractor for employment consideration.

b. In the event the contractor has a valid bargaining agreement providing for exclusive hiring hall referrals, the contractor is expected to observe the provisions of that agreement to the extent that the system meets the contractor's compliance with EEO contract provisions. Where implementation of such an agreement has the effect of discriminating against minorities or women, or obligates the contractor to do the same, such implementation violates Federal nondiscrimination provisions.

c. The contractor will encourage its present employees to refer minorities and women as applicants for employment. Information and procedures with regard to referring such applicants will be discussed with employees.

5. Personnel Actions: Wages, working conditions, and employee benefits shall be established and administered, and personnel actions of every type, including hiring, upgrading, promotion, transfer, demotion, layoff, and termination, shall be taken without regard to race, color, religion, sex, national origin, age or disability. The following procedures shall be followed:

a. The contractor will conduct periodic inspections of project sites to insure that working conditions and employee facilities do not indicate discriminatory treatment of project site personnel.

b. The contractor will periodically evaluate the spread of wages paid within each classification to determine any evidence of discriminatory wage practices.

c. The contractor will periodically review selected personnel actions in depth to determine whether there is evidence of discrimination. Where evidence is found, the contractor will promptly take corrective action. If the review indicates that the discrimination may extend beyond the actions reviewed, such corrective action shall include all affected persons.

d. The contractor will promptly investigate all complaints of alleged discrimination made to the contractor in connection with its obligations under this contract, will attempt to resolve such complaints, and will take appropriate corrective action within a reasonable time. If the investigation indicates that the discrimination may affect persons other than the complainant, such corrective action shall include such other persons. Upon completion of each investigation, the contractor will inform every complainant of all of their avenues of appeal.

6. Training and Promotion:

a. The contractor will assist in locating, qualifying, and increasing the skills of minorities and women who are applicants for employment or current employees. Such efforts should be aimed at developing full journey level status employees in the type of trade or job classification involved.

b. Consistent with the contractor's work force requirements and as permissible under Federal and State regulations, the contractor shall make full use of training programs, i.e., apprenticeship, and on-the-job training programs for the geographical area of contract performance. In the event a special provision for training is provided under this contract, this subparagraph will be superseded as indicated in the special provision. The contracting agency may reserve training positions for persons who receive welfare assistance in accordance with 23 U.S.C. 140(a).

c. The contractor will advise employees and applicants for employment of available training programs and entrance requirements for each.

d. The contractor will periodically review the training and promotion potential of employees who are minorities and women and will encourage eligible employees to apply for such training and promotion.

7. Unions: If the contractor relies in whole or in part upon unions as a source of employees, the contractor will use good faith efforts to obtain the cooperation of such unions to increase opportunities for minorities and women. Actions by the contractor, either directly or through a contractor's association acting as agent, will include the procedures set forth below:

a. The contractor will use good faith efforts to develop, in cooperation with the unions, joint training programs aimed toward qualifying more minorities and women for membership in the unions and increasing the skills of minorities and women so that they may qualify for higher paying employment.

b. The contractor will use good faith efforts to incorporate an EEO clause into each union agreement to the end that such union will be contractually bound to refer applicants without regard to their race, color, religion, sex, national origin, age or disability.

c. The contractor is to obtain information as to the referral practices and policies of the labor union except that to the extent such information is within the exclusive possession of the labor union and such labor union refuses to furnish such information to the contractor, the contractor shall so certify to the contracting agency and shall set forth what efforts have been made to obtain such information.

d. In the event the union is unable to provide the contractor with a reasonable flow of referrals within the time limit set forth in the collective bargaining agreement, the contractor will, through independent recruitment efforts, fill the employment vacancies without regard to race, color, religion, sex, national origin, age or disability; making full efforts to obtain qualified and/or qualifiable minorities and women. The failure of a union to provide sufficient referrals (even though it is obligated to provide exclusive referrals under the terms of a collective bargaining agreement) does not relieve the contractor from the requirements of this paragraph. In the event the union referral practice prevents the contractor from meeting the obligations pursuant to Executive Order 11246, as amended, and these special provisions, such contractor shall immediately notify the contracting agency.

8. Reasonable Accommodation for Applicants / Employees with Disabilities: The contractor must be familiar with the requirements for and comply with the Americans with Disabilities Act and all rules and regulations established there under. Employers must provide reasonable accommodation in all employment activities unless to do so would cause an undue hardship.

9. Selection of Subcontractors, Procurement of Materials and Leasing of Equipment: The contractor shall not discriminate on the grounds of race, color, religion, sex, national origin, age or disability in the selection and retention of subcontractors, including procurement of materials and leases of equipment. The contractor shall take all necessary and reasonable steps to ensure nondiscrimination in the administration of this contract.

a. The contractor shall notify all potential subcontractors and suppliers and lessors of their EEO obligations under this contract.

b. The contractor will use good faith efforts to ensure subcontractor compliance with their EEO obligations.

10. Assurance Required by 49 CFR 26.13(b):

a. The requirements of 49 CFR Part 26 and the State DOT's U.S. DOT-approved DBE program are incorporated by reference.

b. The contractor or subcontractor shall not discriminate on the basis of race, color, national origin, or sex in the performance of this contract. The contractor shall carry out applicable requirements of 49 CFR Part 26 in the award and administration of DOT-assisted contracts. Failure by the contractor to carry out these requirements is a material breach of this contract, which may result in the termination of this contract or such other remedy as the contracting agency deems appropriate.

11. Records and Reports: The contractor shall keep such records as necessary to document compliance with the EEO requirements. Such records shall be retained for a period of three years following the date of the final payment to the contractor for all contract work and shall be available at reasonable times and places for inspection by authorized representatives of the contracting agency and the FHWA.

a. The records kept by the contractor shall document the following:

(1) The number and work hours of minority and non-minority group members and women employed in each work classification on the project;

(2) The progress and efforts being made in cooperation with unions, when applicable, to increase employment opportunities for minorities and women; and

(3) The progress and efforts being made in locating, hiring, training, qualifying, and upgrading minorities and women;

b. The contractors and subcontractors will submit an annual report to the contracting agency each July for the duration of the project, indicating the number of minority, women, and non-minority group employees currently engaged in each work classification required by the contract work. This information is to be reported on [Form FHWA-1391](#).

The staffing data should represent the project work force on board in all or any part of the last payroll period preceding the end of July. If on-the-job training is being required by special provision, the contractor will be required to collect and report training data. The employment data should reflect the work force on board during all or any part of the last payroll period preceding the end of July.

III. NONSEGREGATED FACILITIES

This provision is applicable to all Federal-aid construction contracts and to all related construction subcontracts of \$10,000 or more.

The contractor must ensure that facilities provided for employees are provided in such a manner that segregation on the basis of race, color, religion, sex, or national origin cannot result. The contractor may neither require such segregated use by written or oral policies nor tolerate such use by employee custom. The contractor's obligation extends further to ensure that its employees are not assigned to perform their services at any location, under the contractor's control, where the facilities are segregated. The term "facilities" includes waiting rooms, work areas, restaurants and other eating areas, time clocks, restrooms, washrooms, locker rooms, and other storage or dressing areas, parking lots, drinking fountains, recreation or entertainment areas, transportation, and housing provided for employees. The contractor shall provide separate or single-user restrooms and necessary dressing or sleeping areas to assure privacy between sexes.

IV. DAVIS-BACON AND RELATED ACT PROVISIONS

This section is applicable to all Federal-aid construction projects exceeding \$2,000 and to all related subcontracts and lower-tier subcontracts (regardless of subcontract size). The requirements apply to all projects located within the right-of-way of a roadway that is functionally classified as Federal-aid highway. This excludes roadways functionally classified as local roads or rural minor collectors, which are exempt. Contracting agencies may elect to apply these requirements to other projects.

The following provisions are from the U.S. Department of Labor regulations in 29 CFR 5.5 "Contract provisions and related matters" with minor revisions to conform to the FHWA-1273 format and FHWA program requirements.

1. Minimum wages

a. All laborers and mechanics employed or working upon the site of the work, will be paid unconditionally and not less often than once a week, and without subsequent deduction or rebate on any account (except such payroll deductions as are permitted by regulations issued by the Secretary of Labor under the Copeland Act (29 CFR part 3)), the full amount of wages and bona fide fringe benefits (or cash equivalents thereof) due at time of payment computed at rates not less than those contained in the wage determination of the Secretary of Labor which is attached hereto and made a part hereof, regardless of any contractual relationship which may be alleged to exist between the contractor and such laborers and mechanics.

Contributions made or costs reasonably anticipated for bona fide fringe benefits under section 1(b)(2) of the Davis-Bacon Act on behalf of laborers or mechanics are considered wages paid to such laborers or mechanics, subject to the provisions of paragraph 1.d. of this section; also, regular contributions made or costs incurred for more than a weekly period (but not less often than quarterly) under plans, funds, or programs which cover the particular weekly period, are deemed to be constructively made or incurred during such weekly period. Such laborers and mechanics shall be paid the appropriate wage rate and fringe benefits on the wage determination for the classification of work actually performed, without regard to skill, except as provided in 29 CFR 5.5(a)(4). Laborers or mechanics performing work in more than one classification may be compensated at the rate specified for each

classification for the time actually worked therein: Provided, That the employer's payroll records accurately set forth the time spent in each classification in which work is performed. The wage determination (including any additional classification and wage rates conformed under paragraph 1.b. of this section) and the Davis-Bacon poster (WH-1321) shall be posted at all times by the contractor and its subcontractors at the site of the work in a prominent and accessible place where it can be easily seen by the workers.

b. (1) The contracting officer shall require that any class of laborers or mechanics, including helpers, which is not listed in the wage determination and which is to be employed under the contract shall be classified in conformance with the wage determination. The contracting officer shall approve an additional classification and wage rate and fringe benefits therefore only when the following criteria have been met:

(i) The work to be performed by the classification requested is not performed by a classification in the wage determination; and

(ii) The classification is utilized in the area by the construction industry; and

(iii) The proposed wage rate, including any bona fide fringe benefits, bears a reasonable relationship to the wage rates contained in the wage determination.

(2) If the contractor and the laborers and mechanics to be employed in the classification (if known), or their representatives, and the contracting officer agree on the classification and wage rate (including the amount designated for fringe benefits where appropriate), a report of the action taken shall be sent by the contracting officer to the Administrator of the Wage and Hour Division, Employment Standards Administration, U.S. Department of Labor, Washington, DC 20210. The Administrator, or an authorized representative, will approve, modify, or disapprove every additional classification action within 30 days of receipt and so advise the contracting officer or will notify the contracting officer within the 30-day period that additional time is necessary.

(3) In the event the contractor, the laborers or mechanics to be employed in the classification or their representatives, and the contracting officer do not agree on the proposed classification and wage rate (including the amount designated for fringe benefits, where appropriate), the contracting officer shall refer the questions, including the views of all interested parties and the recommendation of the contracting officer, to the Wage and Hour Administrator for determination. The Wage and Hour Administrator, or an authorized representative, will issue a determination within 30 days of receipt and so advise the contracting officer or will notify the contracting officer within the 30-day period that additional time is necessary.

(4) The wage rate (including fringe benefits where appropriate) determined pursuant to paragraphs 1.b.(2) or 1.b.(3) of this section, shall be paid to all workers performing work in the classification under this contract from the first day on which work is performed in the classification.

c. Whenever the minimum wage rate prescribed in the contract for a class of laborers or mechanics includes a fringe benefit which is not expressed as an hourly rate, the contractor shall either pay the benefit as stated in the wage determination or shall pay another bona fide fringe benefit or an hourly cash equivalent thereof.

d. If the contractor does not make payments to a trustee or other third person, the contractor may consider as part of the wages of any laborer or mechanic the amount of any costs reasonably anticipated in providing bona fide fringe benefits under a plan or program, Provided, That the Secretary of Labor has found, upon the written request of the contractor, that the applicable standards of the Davis-Bacon Act have been met. The Secretary of Labor may require the contractor to set aside in a

separate account assets for the meeting of obligations under the plan or program.

2. Withholding

The contracting agency shall upon its own action or upon written request of an authorized representative of the Department of Labor, withhold or cause to be withheld from the contractor under this contract, or any other Federal contract with the same prime contractor, or any other federally-assisted contract subject to Davis-Bacon prevailing wage requirements, which is held by the same prime contractor, so much of the accrued payments or advances as may be considered necessary to pay laborers and mechanics, including apprentices, trainees, and helpers, employed by the contractor or any subcontractor the full amount of wages required by the contract. In the event of failure to pay any laborer or mechanic, including any apprentice, trainee, or helper, employed or working on the site of the work, all or part of the wages required by the contract, the contracting agency may, after written notice to the contractor, take such action as may be necessary to cause the suspension of any further payment, advance, or guarantee of funds until such violations have ceased.

3. Payrolls and basic records

a. Payrolls and basic records relating thereto shall be maintained by the contractor during the course of the work and preserved for a period of three years thereafter for all laborers and mechanics working at the site of the work. Such records shall contain the name, address, and social security number of each such worker, his or her correct classification, hourly rates of wages paid (including rates of contributions or costs anticipated for bona fide fringe benefits or cash equivalents thereof of the types described in section 1(b)(2)(B) of the Davis-Bacon Act), daily and weekly number of hours worked, deductions made and actual wages paid. Whenever the Secretary of Labor has found under 29 CFR 5.5(a)(1)(iv) that the wages of any laborer or mechanic include the amount of any costs reasonably anticipated in providing benefits under a plan or program described in section 1(b)(2)(B) of the Davis-Bacon Act, the contractor shall maintain records which show that the commitment to provide such benefits is enforceable, that the plan or program is financially responsible, and that the plan or program has been communicated in writing to the laborers or mechanics affected, and records which show the costs anticipated or the actual cost incurred in providing such benefits. Contractors employing apprentices or trainees under approved programs shall maintain written evidence of the registration of apprenticeship programs and certification of trainee programs, the registration of the apprentices and trainees, and the ratios and wage rates prescribed in the applicable programs.

b. (1) The contractor shall submit weekly for each week in which any contract work is performed a copy of all payrolls to the contracting agency. The payrolls submitted shall set out accurately and completely all of the information required to be maintained under 29 CFR 5.5(a)(3)(i), except that full social security numbers and home addresses shall not be included on weekly transmittals. Instead the payrolls shall only need to include an individually identifying number for each employee (e.g. , the last four digits of the employee's social security number). The required weekly payroll information may be submitted in any form desired. Optional Form WH-347 is available for this purpose from the Wage and Hour Division Web site at <http://www.dol.gov/esa/whd/forms/wh347instr.htm> or its successor site. The prime contractor is responsible for the submission of copies of payrolls by all subcontractors. Contractors and subcontractors shall maintain the full social security number and current address of each covered worker, and shall provide them upon request to the contracting agency for transmission to the State DOT, the FHWA or the Wage and Hour Division of the Department of Labor for purposes of an investigation or audit of compliance with prevailing wage requirements. It is not a violation of this section for a prime contractor to require a subcontractor to provide addresses and social security numbers to the prime contractor for its own records, without weekly submission to the contracting agency..

(2) Each payroll submitted shall be accompanied by a "Statement of Compliance," signed by the contractor or subcontractor or his or her agent who pays or supervises the payment of the persons employed under the contract and shall certify the following:

(i) That the payroll for the payroll period contains the information required to be provided under §5.5 (a)(3)(ii) of Regulations, 29 CFR part 5, the appropriate information is being maintained under §5.5 (a)(3)(i) of Regulations, 29 CFR part 5, and that such information is correct and complete;

(ii) That each laborer or mechanic (including each helper, apprentice, and trainee) employed on the contract during the payroll period has been paid the full weekly wages earned, without rebate, either directly or indirectly, and that no deductions have been made either directly or indirectly from the full wages earned, other than permissible deductions as set forth in Regulations, 29 CFR part 3;

(iii) That each laborer or mechanic has been paid not less than the applicable wage rates and fringe benefits or cash equivalents for the classification of work performed, as specified in the applicable wage determination incorporated into the contract.

(3) The weekly submission of a properly executed certification set forth on the reverse side of Optional Form WH-347 shall satisfy the requirement for submission of the "Statement of Compliance" required by paragraph 3.b.(2) of this section.

(4) The falsification of any of the above certifications may subject the contractor or subcontractor to civil or criminal prosecution under section 1001 of title 18 and section 231 of title 31 of the United States Code.

c. The contractor or subcontractor shall make the records required under paragraph 3.a. of this section available for inspection, copying, or transcription by authorized representatives of the contracting agency, the State DOT, the FHWA, or the Department of Labor, and shall permit such representatives to interview employees during working hours on the job. If the contractor or subcontractor fails to submit the required records or to make them available, the FHWA may, after written notice to the contractor, the contracting agency or the State DOT, take such action as may be necessary to cause the suspension of any further payment, advance, or guarantee of funds. Furthermore, failure to submit the required records upon request or to make such records available may be grounds for debarment action pursuant to 29 CFR 5.12.

4. Apprentices and trainees

a. Apprentices (programs of the USDOL).

Apprentices will be permitted to work at less than the predetermined rate for the work they performed when they are employed pursuant to and individually registered in a bona fide apprenticeship program registered with the U.S. Department of Labor, Employment and Training Administration, Office of Apprenticeship Training, Employer and Labor Services, or with a State Apprenticeship Agency recognized by the Office, or if a person is employed in his or her first 90 days of probationary employment as an apprentice in such an apprenticeship program, who is not individually registered in the program, but who has been certified by the Office of Apprenticeship Training, Employer and Labor Services or a State Apprenticeship Agency (where appropriate) to be eligible for probationary employment as an apprentice.

The allowable ratio of apprentices to journeymen on the job site in any craft classification shall not be greater than the ratio permitted to the contractor as to the entire work force under the registered program. Any worker listed on a payroll at an apprentice wage rate, who is not registered or otherwise employed as stated above, shall be paid not less than the applicable wage rate on the wage determination for the classification of work actually performed. In addition, any apprentice

performing work on the job site in excess of the ratio permitted under the registered program shall be paid not less than the applicable wage rate on the wage determination for the work actually performed. Where a contractor is performing construction on a project in a locality other than that in which its program is registered, the ratios and wage rates (expressed in percentages of the journeyman's hourly rate) specified in the contractor's or subcontractor's registered program shall be observed.

Every apprentice must be paid at not less than the rate specified in the registered program for the apprentice's level of progress, expressed as a percentage of the journeymen hourly rate specified in the applicable wage determination. Apprentices shall be paid fringe benefits in accordance with the provisions of the apprenticeship program. If the apprenticeship program does not specify fringe benefits, apprentices must be paid the full amount of fringe benefits listed on the wage determination for the applicable classification. If the Administrator determines that a different practice prevails for the applicable apprentice classification, fringes shall be paid in accordance with that determination.

In the event the Office of Apprenticeship Training, Employer and Labor Services, or a State Apprenticeship Agency recognized by the Office, withdraws approval of an apprenticeship program, the contractor will no longer be permitted to utilize apprentices at less than the applicable predetermined rate for the work performed until an acceptable program is approved.

b. Trainees (programs of the USDOL).

Except as provided in 29 CFR 5.16, trainees will not be permitted to work at less than the predetermined rate for the work performed unless they are employed pursuant to and individually registered in a program which has received prior approval, evidenced by formal certification by the U.S. Department of Labor, Employment and Training Administration.

The ratio of trainees to journeymen on the job site shall not be greater than permitted under the plan approved by the Employment and Training Administration.

Every trainee must be paid at not less than the rate specified in the approved program for the trainee's level of progress, expressed as a percentage of the journeyman hourly rate specified in the applicable wage determination. Trainees shall be paid fringe benefits in accordance with the provisions of the trainee program. If the trainee program does not mention fringe benefits, trainees shall be paid the full amount of fringe benefits listed on the wage determination unless the Administrator of the Wage and Hour Division determines that there is an apprenticeship program associated with the corresponding journeyman wage rate on the wage determination which provides for less than full fringe benefits for apprentices. Any employee listed on the payroll at a trainee rate who is not registered and participating in a training plan approved by the Employment and Training Administration shall be paid not less than the applicable wage rate on the wage determination for the classification of work actually performed. In addition, any trainee performing work on the job site in excess of the ratio permitted under the registered program shall be paid not less than the applicable wage rate on the wage determination for the work actually performed.

In the event the Employment and Training Administration withdraws approval of a training program, the contractor will no longer be permitted to utilize trainees at less than the applicable predetermined rate for the work performed until an acceptable program is approved.

c. Equal employment opportunity. The utilization of apprentices, trainees and journeymen under this part shall be in conformity with the equal employment opportunity requirements of Executive Order 11246, as amended, and 29 CFR part 30.

d. Apprentices and Trainees (programs of the U.S. DOT).

Apprentices and trainees working under apprenticeship and skill training programs which have been certified by the Secretary of Transportation as promoting EEO in connection with Federal-aid highway construction programs are not subject to the requirements of paragraph 4 of this Section IV. The straight time hourly wage rates for apprentices and trainees under such programs will be established by the particular programs. The ratio of apprentices and trainees to journeymen shall not be greater than permitted by the terms of the particular program.

5. Compliance with Copeland Act requirements. The contractor shall comply with the requirements of 29 CFR part 3, which are incorporated by reference in this contract.

6. Subcontracts. The contractor or subcontractor shall insert Form FHWA-1273 in any subcontracts and also require the subcontractors to include Form FHWA-1273 in any lower tier subcontracts. The prime contractor shall be responsible for the compliance by any subcontractor or lower tier subcontractor with all the contract clauses in 29 CFR 5.5.

7. Contract termination: debarment. A breach of the contract clauses in 29 CFR 5.5 may be grounds for termination of the contract, and for debarment as a contractor and a subcontractor as provided in 29 CFR 5.12.

8. Compliance with Davis-Bacon and Related Act requirements. All rulings and interpretations of the Davis-Bacon and Related Acts contained in 29 CFR parts 1, 3, and 5 are herein incorporated by reference in this contract.

9. Disputes concerning labor standards. Disputes arising out of the labor standards provisions of this contract shall not be subject to the general disputes clause of this contract. Such disputes shall be resolved in accordance with the procedures of the Department of Labor set forth in 29 CFR parts 5, 6, and 7. Disputes within the meaning of this clause include disputes between the contractor (or any of its subcontractors) and the contracting agency, the U.S. Department of Labor, or the employees or their representatives.

10. Certification of eligibility.

a. By entering into this contract, the contractor certifies that neither it (nor he or she) nor any person or firm who has an interest in the contractor's firm is a person or firm ineligible to be awarded Government contracts by virtue of section 3(a) of the Davis-Bacon Act or 29 CFR 5.12(a)(1).

b. No part of this contract shall be subcontracted to any person or firm ineligible for award of a Government contract by virtue of section 3(a) of the Davis-Bacon Act or 29 CFR 5.12(a)(1).

c. The penalty for making false statements is prescribed in the U.S. Criminal Code, 18 U.S.C. 1001.

V. CONTRACT WORK HOURS AND SAFETY STANDARDS ACT

The following clauses apply to any Federal-aid construction contract in an amount in excess of \$100,000 and subject to the overtime provisions of the Contract Work Hours and Safety Standards Act. These clauses shall be inserted in addition to the clauses required by 29 CFR 5.5(a) or 29 CFR 4.6. As used in this paragraph, the terms laborers and mechanics include watchmen and guards.

1. Overtime requirements. No contractor or subcontractor contracting for any part of the contract work which may require or involve the employment of laborers or mechanics shall require or permit any such laborer or mechanic in any workweek in which he or she is employed on such work to work in excess of forty hours in such workweek unless such laborer or mechanic receives compensation at a rate not less than one

and one-half times the basic rate of pay for all hours worked in excess of forty hours in such workweek.

2. Violation; liability for unpaid wages; liquidated damages. In the event of any violation of the clause set forth in paragraph (1.) of this section, the contractor and any subcontractor responsible therefor shall be liable for the unpaid wages. In addition, such contractor and subcontractor shall be liable to the United States (in the case of work done under contract for the District of Columbia or a territory, to such District or to such territory), for liquidated damages. Such liquidated damages shall be computed with respect to each individual laborer or mechanic, including watchmen and guards, employed in violation of the clause set forth in paragraph (1.) of this section, in the sum of \$10 for each calendar day on which such individual was required or permitted to work in excess of the standard workweek of forty hours without payment of the overtime wages required by the clause set forth in paragraph (1.) of this section.

3. Withholding for unpaid wages and liquidated damages. The FHWA or the contracting agency shall upon its own action or upon written request of an authorized representative of the Department of Labor withhold or cause to be withheld, from any moneys payable on account of work performed by the contractor or subcontractor under any such contract or any other Federal contract with the same prime contractor, or any other federally-assisted contract subject to the Contract Work Hours and Safety Standards Act, which is held by the same prime contractor, such sums as may be determined to be necessary to satisfy any liabilities of such contractor or subcontractor for unpaid wages and liquidated damages as provided in the clause set forth in paragraph (2.) of this section.

4. Subcontracts. The contractor or subcontractor shall insert in any subcontracts the clauses set forth in paragraph (1.) through (4.) of this section and also a clause requiring the subcontractors to include these clauses in any lower tier subcontracts. The prime contractor shall be responsible for compliance by any subcontractor or lower tier subcontractor with the clauses set forth in paragraphs (1.) through (4.) of this section.

VI. SUBLETTING OR ASSIGNING THE CONTRACT

This provision is applicable to all Federal-aid construction contracts on the National Highway System.

1. The contractor shall perform with its own organization contract work amounting to not less than 30 percent (or a greater percentage if specified elsewhere in the contract) of the total original contract price, excluding any specialty items designated by the contracting agency. Specialty items may be performed by subcontract and the amount of any such specialty items performed may be deducted from the total original contract price before computing the amount of work required to be performed by the contractor's own organization (23 CFR 635.116).

a. The term "perform work with its own organization" refers to workers employed or leased by the prime contractor, and equipment owned or rented by the prime contractor, with or without operators. Such term does not include employees or equipment of a subcontractor or lower tier subcontractor, agents of the prime contractor, or any other assignees. The term may include payments for the costs of hiring leased employees from an employee leasing firm meeting all relevant Federal and State regulatory requirements. Leased employees may only be included in this term if the prime contractor meets all of the following conditions:

(1) the prime contractor maintains control over the supervision of the day-to-day activities of the leased employees;

(2) the prime contractor remains responsible for the quality of the work of the leased employees;

(3) the prime contractor retains all power to accept or exclude individual employees from work on the project; and

(4) the prime contractor remains ultimately responsible for the payment of predetermined minimum wages, the submission of payrolls, statements of compliance and all other Federal regulatory requirements.

b. "Specialty Items" shall be construed to be limited to work that requires highly specialized knowledge, abilities, or equipment not ordinarily available in the type of contracting organizations qualified and expected to bid or propose on the contract as a whole and in general are to be limited to minor components of the overall contract.

2. The contract amount upon which the requirements set forth in paragraph (1) of Section VI is computed includes the cost of material and manufactured products which are to be purchased or produced by the contractor under the contract provisions.

3. The contractor shall furnish (a) a competent superintendent or supervisor who is employed by the firm, has full authority to direct performance of the work in accordance with the contract requirements, and is in charge of all construction operations (regardless of who performs the work) and (b) such other of its own organizational resources (supervision, management, and engineering services) as the contracting officer determines is necessary to assure the performance of the contract.

4. No portion of the contract shall be sublet, assigned or otherwise disposed of except with the written consent of the contracting officer, or authorized representative, and such consent when given shall not be construed to relieve the contractor of any responsibility for the fulfillment of the contract. Written consent will be given only after the contracting agency has assured that each subcontract is evidenced in writing and that it contains all pertinent provisions and requirements of the prime contract.

5. The 30% self-performance requirement of paragraph (1) is not applicable to design-build contracts; however, contracting agencies may establish their own self-performance requirements.

VII. SAFETY: ACCIDENT PREVENTION

This provision is applicable to all Federal-aid construction contracts and to all related subcontracts.

1. In the performance of this contract the contractor shall comply with all applicable Federal, State, and local laws governing safety, health, and sanitation (23 CFR 635). The contractor shall provide all safeguards, safety devices and protective equipment and take any other needed actions as it determines, or as the contracting officer may determine, to be reasonably necessary to protect the life and health of employees on the job and the safety of the public and to protect property in connection with the performance of the work covered by the contract.

2. It is a condition of this contract, and shall be made a condition of each subcontract, which the contractor enters into pursuant to this contract, that the contractor and any subcontractor shall not permit any employee, in performance of the contract, to work in surroundings or under conditions which are unsanitary, hazardous or dangerous to his/her health or safety, as determined under construction safety and health standards (29 CFR 1926) promulgated by the Secretary of Labor, in accordance with Section 107 of the Contract Work Hours and Safety Standards Act (40 U.S.C. 3704).

3. Pursuant to 29 CFR 1926.3, it is a condition of this contract that the Secretary of Labor or authorized representative thereof, shall have right of entry to any site of contract performance to inspect or investigate the matter of compliance with the construction safety and health standards and to carry out the duties of the Secretary under Section 107 of the Contract Work Hours and Safety Standards Act (40 U.S.C.3704).

VIII. FALSE STATEMENTS CONCERNING HIGHWAY PROJECTS

This provision is applicable to all Federal-aid construction contracts and to all related subcontracts.

In order to assure high quality and durable construction in conformity with approved plans and specifications and a high degree of reliability on statements and representations made by engineers, contractors, suppliers, and workers on Federal-aid highway projects, it is essential that all persons concerned with the project perform their functions as carefully, thoroughly, and honestly as possible. Willful falsification, distortion, or misrepresentation with respect to any facts related to the project is a violation of Federal law. To prevent any misunderstanding regarding the seriousness of these and similar acts, Form FHWA-1022 shall be posted on each Federal-aid highway project (23 CFR 635) in one or more places where it is readily available to all persons concerned with the project:

18 U.S.C. 1020 reads as follows:

"Whoever, being an officer, agent, or employee of the United States, or of any State or Territory, or whoever, whether a person, association, firm, or corporation, knowingly makes any false statement, false representation, or false report as to the character, quality, quantity, or cost of the material used or to be used, or the quantity or quality of the work performed or to be performed, or the cost thereof in connection with the submission of plans, maps, specifications, contracts, or costs of construction on any highway or related project submitted for approval to the Secretary of Transportation; or

Whoever knowingly makes any false statement, false representation, false report or false claim with respect to the character, quality, quantity, or cost of any work performed or to be performed, or materials furnished or to be furnished, in connection with the construction of any highway or related project approved by the Secretary of Transportation; or

Whoever knowingly makes any false statement or false representation as to material fact in any statement, certificate, or report submitted pursuant to provisions of the Federal-aid Roads Act approved July 1, 1916, (39 Stat. 355), as amended and supplemented;

Shall be fined under this title or imprisoned not more than 5 years or both."

IX. IMPLEMENTATION OF CLEAN AIR ACT AND FEDERAL WATER POLLUTION CONTROL ACT

This provision is applicable to all Federal-aid construction contracts and to all related subcontracts.

By submission of this bid/proposal or the execution of this contract, or subcontract, as appropriate, the bidder, proposer, Federal-aid construction contractor, or subcontractor, as appropriate, will be deemed to have stipulated as follows:

1. That any person who is or will be utilized in the performance of this contract is not prohibited from receiving an award due to a violation of Section 508 of the Clean Water Act or Section 306 of the Clean Air Act.

2. That the contractor agrees to include or cause to be included the requirements of paragraph (1) of this Section X in every subcontract, and further agrees to take such action as the contracting agency may direct as a means of enforcing such requirements.

X. CERTIFICATION REGARDING DEBARMENT, SUSPENSION, INELIGIBILITY AND VOLUNTARY EXCLUSION

This provision is applicable to all Federal-aid construction contracts, design-build contracts, subcontracts, lower-tier subcontracts, purchase orders, lease agreements, consultant contracts or any other covered transaction requiring FHWA approval or that is estimated to cost \$25,000 or more – as defined in 2 CFR Parts 180 and 1200.

1. Instructions for Certification – First Tier Participants:

a. By signing and submitting this proposal, the prospective first tier participant is providing the certification set out below.

b. The inability of a person to provide the certification set out below will not necessarily result in denial of participation in this covered transaction. The prospective first tier participant shall submit an explanation of why it cannot provide the certification set out below. The certification or explanation will be considered in connection with the department or agency's determination whether to enter into this transaction. However, failure of the prospective first tier participant to furnish a certification or an explanation shall disqualify such a person from participation in this transaction.

c. The certification in this clause is a material representation of fact upon which reliance was placed when the contracting agency determined to enter into this transaction. If it is later determined that the prospective participant knowingly rendered an erroneous certification, in addition to other remedies available to the Federal Government, the contracting agency may terminate this transaction for cause of default.

d. The prospective first tier participant shall provide immediate written notice to the contracting agency to whom this proposal is submitted if any time the prospective first tier participant learns that its certification was erroneous when submitted or has become erroneous by reason of changed circumstances.

e. The terms "covered transaction," "debarred," "suspended," "ineligible," "participant," "person," "principal," and "voluntarily excluded," as used in this clause, are defined in 2 CFR Parts 180 and 1200. "First Tier Covered Transactions" refers to any covered transaction between a grantee or subgrantee of Federal funds and a participant (such as the prime or general contract). "Lower Tier Covered Transactions" refers to any covered transaction under a First Tier Covered Transaction (such as subcontracts). "First Tier Participant" refers to the participant who has entered into a covered transaction with a grantee or subgrantee of Federal funds (such as the prime or general contractor). "Lower Tier Participant" refers any participant who has entered into a covered transaction with a First Tier Participant or other Lower Tier Participants (such as subcontractors and suppliers).

f. The prospective first tier participant agrees by submitting this proposal that, should the proposed covered transaction be entered into, it shall not knowingly enter into any lower tier covered transaction with a person who is debarred, suspended, declared ineligible, or voluntarily excluded from participation in this covered transaction, unless authorized by the department or agency entering into this transaction.

g. The prospective first tier participant further agrees by submitting this proposal that it will include the clause titled "Certification Regarding Debarment, Suspension, Ineligibility and Voluntary Exclusion-Lower Tier Covered Transactions," provided by the department or contracting agency, entering into this covered transaction, without modification, in all lower tier covered transactions and in all solicitations for lower tier covered transactions exceeding the \$25,000 threshold.

h. A participant in a covered transaction may rely upon a certification of a prospective participant in a lower tier covered transaction that is not debarred, suspended, ineligible, or voluntarily excluded from the covered transaction, unless it knows that the certification is erroneous. A participant is responsible for ensuring that its principals are not suspended, debarred, or otherwise ineligible to participate in covered transactions. To verify the eligibility of its principals, as well as the eligibility of any lower tier prospective participants, each participant may, but is not required to, check the Excluded Parties List System website (<https://www.epls.gov/>), which is compiled by the General Services Administration.

i. Nothing contained in the foregoing shall be construed to require the establishment of a system of records in order to render in good faith the certification required by this clause. The knowledge and information of the prospective participant is not required to exceed that which is normally possessed by a prudent person in the ordinary course of business dealings.

j. Except for transactions authorized under paragraph (f) of these instructions, if a participant in a covered transaction knowingly enters into a lower tier covered transaction with a person who is suspended, debarred, ineligible, or voluntarily excluded from participation in this transaction, in addition to other remedies available to the Federal Government, the department or agency may terminate this transaction for cause or default.

* * * * *

2. Certification Regarding Debarment, Suspension, Ineligibility and Voluntary Exclusion – First Tier Participants:

a. The prospective first tier participant certifies to the best of its knowledge and belief, that it and its principals:

(1) Are not presently debarred, suspended, proposed for debarment, declared ineligible, or voluntarily excluded from participating in covered transactions by any Federal department or agency;

(2) Have not within a three-year period preceding this proposal been convicted of or had a civil judgment rendered against them for commission of fraud or a criminal offense in connection with obtaining, attempting to obtain, or performing a public (Federal, State or local) transaction or contract under a public transaction; violation of Federal or State antitrust statutes or commission of embezzlement, theft, forgery, bribery, falsification or destruction of records, making false statements, or receiving stolen property;

(3) Are not presently indicted for or otherwise criminally or civilly charged by a governmental entity (Federal, State or local) with commission of any of the offenses enumerated in paragraph (a)(2) of this certification; and

(4) Have not within a three-year period preceding this application/proposal had one or more public transactions (Federal, State or local) terminated for cause or default.

b. Where the prospective participant is unable to certify to any of the statements in this certification, such prospective participant shall attach an explanation to this proposal.

2. Instructions for Certification - Lower Tier Participants:

(Applicable to all subcontracts, purchase orders and other lower tier transactions requiring prior FHWA approval or estimated to cost \$25,000 or more - 2 CFR Parts 180 and 1200)

a. By signing and submitting this proposal, the prospective lower tier is providing the certification set out below.

b. The certification in this clause is a material representation of fact upon which reliance was placed when this transaction was entered into. If it is later determined that the prospective lower tier participant knowingly rendered an erroneous certification, in addition to other remedies available to the Federal Government, the department, or agency with which this transaction originated may pursue available remedies, including suspension and/or debarment.

c. The prospective lower tier participant shall provide immediate written notice to the person to which this proposal is submitted if at any time the prospective lower tier participant learns that its certification was erroneous by reason of changed circumstances.

d. The terms "covered transaction," "debarred," "suspended," "ineligible," "participant," "person," "principal," and "voluntarily excluded," as used in this clause, are defined in 2 CFR Parts 180 and 1200. You may contact the person to which this proposal is submitted for assistance in obtaining a copy of those regulations. "First Tier Covered Transactions" refers to any covered transaction between a grantee or subgrantee of Federal funds and a participant (such as the prime or general contract). "Lower Tier Covered Transactions" refers to any covered transaction under a First Tier Covered Transaction (such as subcontracts). "First Tier Participant" refers to the participant who has entered into a covered transaction with a grantee or subgrantee of

Federal funds (such as the prime or general contractor). "Lower Tier Participant" refers any participant who has entered into a covered transaction with a First Tier Participant or other Lower Tier Participants (such as subcontractors and suppliers).

e. The prospective lower tier participant agrees by submitting this proposal that, should the proposed covered transaction be entered into, it shall not knowingly enter into any lower tier covered transaction with a person who is debarred, suspended, declared ineligible, or voluntarily excluded from participation in this covered transaction, unless authorized by the department or agency with which this transaction originated.

f. The prospective lower tier participant further agrees by submitting this proposal that it will include this clause titled "Certification Regarding Debarment, Suspension, Ineligibility and Voluntary Exclusion-Lower Tier Covered Transaction," without modification, in all lower tier covered transactions and in all solicitations for lower tier covered transactions exceeding the \$25,000 threshold.

g. A participant in a covered transaction may rely upon a certification of a prospective participant in a lower tier covered transaction that is not debarred, suspended, ineligible, or voluntarily excluded from the covered transaction, unless it knows that the certification is erroneous. A participant is responsible for ensuring that its principals are not suspended, debarred, or otherwise ineligible to participate in covered transactions. To verify the eligibility of its principals, as well as the eligibility of any lower tier prospective participants, each participant may, but is not required to, check the Excluded Parties List System website (<https://www.epls.gov/>), which is compiled by the General Services Administration.

h. Nothing contained in the foregoing shall be construed to require establishment of a system of records in order to render in good faith the certification required by this clause. The knowledge and information of participant is not required to exceed that which is normally possessed by a prudent person in the ordinary course of business dealings.

i. Except for transactions authorized under paragraph e of these instructions, if a participant in a covered transaction knowingly enters into a lower tier covered transaction with a person who is suspended, debarred, ineligible, or voluntarily excluded from participation in this transaction, in addition to other remedies available to the Federal Government, the department or agency with which this transaction originated may pursue available remedies, including suspension and/or debarment.

* * * * *

Certification Regarding Debarment, Suspension, Ineligibility and Voluntary Exclusion--Lower Tier Participants:

1. The prospective lower tier participant certifies, by submission of this proposal, that neither it nor its principals is presently debarred, suspended, proposed for debarment, declared ineligible, or voluntarily excluded from participating in covered transactions by any Federal department or agency.

2. Where the prospective lower tier participant is unable to certify to any of the statements in this certification, such prospective participant shall attach an explanation to this proposal.

* * * * *

XI. CERTIFICATION REGARDING USE OF CONTRACT FUNDS FOR LOBBYING

This provision is applicable to all Federal-aid construction contracts and to all related subcontracts which exceed \$100,000 (49 CFR 20).

1. The prospective participant certifies, by signing and submitting this bid or proposal, to the best of his or her knowledge and belief, that:

a. No Federal appropriated funds have been paid or will be paid, by or on behalf of the undersigned, to any person for influencing or attempting to influence an officer or employee of any Federal agency, a Member of

Congress, an officer or employee of Congress, or an employee of a Member of Congress in connection with the awarding of any Federal contract, the making of any Federal grant, the making of any Federal loan, the entering into of any cooperative agreement, and the extension, continuation, renewal, amendment, or modification of any Federal contract, grant, loan, or cooperative agreement.

b. If any funds other than Federal appropriated funds have been paid or will be paid to any person for influencing or attempting to influence an officer or employee of any Federal agency, a Member of Congress, an officer or employee of Congress, or an employee of a Member of Congress in connection with this Federal contract, grant, loan, or cooperative agreement, the undersigned shall complete and submit Standard Form-LLL, "Disclosure Form to Report Lobbying," in accordance with its instructions.

2. This certification is a material representation of fact upon which reliance was placed when this transaction was made or entered into. Submission of this certification is a prerequisite for making or entering into this transaction imposed by 31 U.S.C. 1352. Any person who fails to file the required certification shall be subject to a civil penalty of not less than \$10,000 and not more than \$100,000 for each such failure.

3. The prospective participant also agrees by submitting its bid or proposal that the participant shall require that the language of this certification be included in all lower tier subcontracts, which exceed \$100,000 and that all such recipients shall certify and disclose accordingly.

ATTACHMENT A - EMPLOYMENT AND MATERIALS PREFERENCE FOR APPALACHIAN DEVELOPMENT HIGHWAY SYSTEM OR APPALACHIAN LOCAL ACCESS ROAD CONTRACTS

This provision is applicable to all Federal-aid projects funded under the Appalachian Regional Development Act of 1965.

1. During the performance of this contract, the contractor undertaking to do work which is, or reasonably may be, done as on-site work, shall give preference to qualified persons who regularly reside in the labor area as designated by the DOL wherein the contract work is situated, or the subregion, or the Appalachian counties of the State wherein the contract work is situated, except:

a. To the extent that qualified persons regularly residing in the area are not available.

b. For the reasonable needs of the contractor to employ supervisory or specially experienced personnel necessary to assure an efficient execution of the contract work.

c. For the obligation of the contractor to offer employment to present or former employees as the result of a lawful collective bargaining contract, provided that the number of nonresident persons employed under this subparagraph (1c) shall not exceed 20 percent of the total number of employees employed by the contractor on the contract work, except as provided in subparagraph (4) below.

2. The contractor shall place a job order with the State Employment Service indicating (a) the classifications of the laborers, mechanics and other employees required to perform the contract work, (b) the number of employees required in each classification, (c) the date on which the participant estimates such employees will be required, and (d) any other pertinent information required by the State Employment Service to complete the job order form. The job order may be placed with the State Employment Service in writing or by telephone. If during the course of the contract work, the information submitted by the contractor in the original job order is substantially modified, the participant shall promptly notify the State Employment Service.

3. The contractor shall give full consideration to all qualified job applicants referred to him by the State Employment Service. The contractor is not required to grant employment to any job applicants who, in his opinion, are not qualified to perform the classification of work required.

4. If, within one week following the placing of a job order by the contractor with the State Employment Service, the State Employment Service is unable to refer any qualified job applicants to the contractor, or less than the number requested, the State Employment Service will forward a certificate to the contractor indicating the unavailability of applicants. Such certificate shall be made a part of the contractor's permanent project records. Upon receipt of this certificate, the contractor may employ persons who do not normally reside in the labor area to fill positions covered by the certificate, notwithstanding the provisions of subparagraph (1c) above.

5. The provisions of 23 CFR 633.207(e) allow the contracting agency to provide a contractual preference for the use of mineral resource materials native to the Appalachian region.

6. The contractor shall include the provisions of Sections 1 through 4 of this Attachment A in every subcontract for work which is, or reasonably may be, done as on-site work.

Contract Provision - Cargo Preference Requirements

In accordance with Title 46 CFR § 381.7 (b), the contractor agrees—

“(1) To utilize privately owned United States-flag commercial vessels to ship at least 50 percent of the gross tonnage (computed separately for dry bulk carriers, dry cargo liners, and tankers) involved, whenever shipping any equipment, material, or commodities pursuant to this contract, to the extent such vessels are available at fair and reasonable rates for United States-flag commercial vessels.

(2) To furnish within 20 days following the date of loading for shipments originating within the United States or within 30 working days following the date of loading for shipments originating outside the United States, a legible copy of a rated, ‘on-board’ commercial ocean bill-of-lading in English for each shipment of cargo described in paragraph (b) (1) of this section to both the Contracting Officer (through the prime contractor in the case of subcontractor bills-of-lading) and to the Division of National Cargo, Office of Market Development, Maritime Administration, Washington, DC 20590.

(3) To insert the substance of the provisions of this clause in all subcontracts issued pursuant to this contract.”

Provisions (1) and (2) apply to materials or equipment that are acquired solely for the project. The two provisions do not apply to goods or materials that come into inventories independent of the project, such as shipments of Portland cement, asphalt cement, or aggregates, when industry suppliers and contractors use these materials to replenish existing inventories.

**MINIMUM WAGES FOR FEDERAL AND FEDERALLY
ASSISTED CONSTRUCTION CONTRACTS**

This project is funded, in part, with Federal-aid funds and, as such, is subject to the provisions of the Davis-Bacon Act of March 3, 1931, as amended (46 Sta. 1494, as amended, 40 U.S.C. 276a) and of other Federal statutes referred to in a 29 CFR Part 1, Appendix A, as well as such additional statutes as may from time to time be enacted containing provisions for the payment of wages determined to be prevailing by the Secretary of Labor in accordance with the Davis-Bacon Act and pursuant to the provisions of 29 CFR Part 1. The prevailing rates and fringe benefits shown in the General Wage Determination Decisions issued by the U.S. Department of Labor shall, in accordance with the provisions of the foregoing statutes, constitute the minimum wages payable on Federal and federally assisted construction projects to laborers and mechanics of the specified classes engaged on contract work of the character and in the localities described therein.

General Wage Determination Decisions, modifications and supersedes decisions thereto are to be used in accordance with the provisions of 29 CFR Parts 1 and 5. Accordingly, the applicable decision, together with any modifications issued, must be made a part of every contract for performance of the described work within the geographic area indicated as required by an applicable DBRA Federal prevailing wage law and 29 CFR Part 5. The wage rates and fringe benefits contained in the General Wage Determination Decision shall be the minimum paid by contractors and subcontractors to laborers and mechanics.