

## **If you plan to submit a bid directly to the Department of Transportation**

### **PREQUALIFICATION**

Any contractor who desires to become pre-qualified to bid on work advertised by IDOT must submit the properly completed pre-qualification forms to the Bureau of Construction no later than 4:30 p.m. prevailing time twenty-one days prior to the letting of interest. This pre-qualification requirement applies to first time contractors, contractors renewing expired ratings, contractors maintaining continuous pre-qualification or contractors requesting revised ratings. To be eligible to bid, existing pre-qualification ratings must be effective through the date of letting.

### **REQUESTS FOR AUTHORIZATION TO BID**

Contractors downloading and/or ordering CD-ROM's and are wanting to bid on items included in a particular letting must submit the properly completed "Request for Authorization to Bid/or Not For Bid Status" (BDE 124INT) and the ORIGINAL, signed and notarized, "Affidavit of Availability" (BC 57) to the proper office no later than 4:30 p.m. prevailing time, three (3) days prior to the letting date.

### **WHO CAN BID ?**

Bids will be accepted from only those companies that request and receive written **Authorization to Bid** from IDOT's Central Bureau of Construction.

**WHAT CONSTITUTES WRITTEN AUTHORIZATION TO BID?** When a prospective prime bidder submits a "Request for Authorization to Bid/or Not For Bid Status" (BDE 124INT) he/she must indicate at that time which items are being requested For Bidding purposes. Only those items requested For Bidding will be analyzed. After the request has been analyzed, the bidder will be issued a **Proposal Denial and/or Authorization Form**, approved by the Central Bureau of Construction, that indicates which items have been approved For Bidding. If **Authorization to Bid** cannot be approved, the **Proposal Denial and/or Authorization Form** will indicate the reason for denial.

**ABOUT AUTHORIZATION TO BID:** Firms that have not received an authorization form within a reasonable time of complete and correct original document submittal should contact the department as to status. This is critical in the week before the letting. These documents must be received three days before the letting date. Firms unsure as to authorization status should call the Prequalification Section of the Bureau of Construction at the number listed at the end of these instructions.

**ADDENDA AND REVISIONS:** It is the contractor's responsibility to determine which, if any, addenda or revisions pertain to any project they may be bidding. Failure to incorporate all relevant addenda or revisions may cause the bid to be declared unacceptable.

Each addendum will be placed with the contract number. Addenda and revisions will also be placed on the Addendum/Revision Checklist and each subscription service subscriber will be notified by e-mail of each addendum and revision issued.

The Internet is the Department's primary way of doing business. The subscription server e-mails are an added courtesy the Department provides. It is suggested that bidder check IDOT's website <http://www.dot.il.gov/desenv/delett.html> before submitting final bid information.

**IDOT is not responsible for any e-mail related failures.**

Addenda Questions may be directed to the Contracts Office at (217)782-7806 or [D&Econtracts@dot.il.gov](mailto:D&Econtracts@dot.il.gov)

Technical Questions about downloading these files may be directed to Tim Garman (217)524-1642 or [garmantr@dot.il.gov](mailto:garmantr@dot.il.gov).

**WHAT MUST BE INCLUDED WHEN BIDS ARE SUBMITTED?:** Bidders need not return the entire proposal when bids are submitted. That portion of the proposal that must be returned includes the following:

1. All documents from the Proposal Cover Sheet through the Proposal Bid Bond
2. Other special documentation and/or information that may be required by the contract special provisions

All proposal documents, including Proposal Guaranty Checks or Proposal Bid Bonds, should be stapled together to prevent loss when bids are processed by IDOT personnel.

**ABOUT SUBMITTING BIDS:** It is recommended that bidders deliver bids in person to insure they arrive at the proper location prior to the time specified for the receipt of bids. Any bid received at the place of letting after the time specified will not be accepted.

**WHO SHOULD BE CALLED IF ASSISTANCE IS NEEDED?**

<b>Questions Regarding</b>	<b>Call</b>
Prequalification and/or Authorization to Bid	(217)782-3413
Preparation and submittal of bids	(217)782-7806
Mailing of plans and proposals	(217)782-7806
Electronic plans and proposals	(217)524-1642

**ADDENDUMS AND REVISIONS TO THE PROPOSAL FORMS**

Planholders should verify that they have received and incorporated the addendum and/or revision prior to submitting their bid. Failure by the bidder to include an addendum could result in a bid being rejected as irregular.

# 81

RETURN WITH BID

Proposal Submitted By
Name
Address
City

## Letting April 27, 2007

**BIDDERS NEED NOT RETURN THE ENTIRE PROPOSAL**  
(See instructions inside front cover)

**NOTICE TO PROSPECTIVE BIDDERS**  
 This proposal can be used for bidding purposes  
 by only those companies that request and receive  
 written AUTHORIZATION TO BID from IDOT's  
 Central Bureau of Construction.  
 (SEE INSTRUCTIONS ON THE INSIDE OF COVER)

# Notice To Bidders, Specifications, Proposal, Contract and Contract Bond



**Illinois Department  
of Transportation**

Springfield, Illinois 62764

**Contract No. 44952  
Various Counties  
Section INT ATTRACT SIGN 2007-19  
District TR Construction Funds  
Various Routes**

PLEASE MARK THE APPROPRIATE BOX BELOW:

A Bid Bond is included.

A Cashier's Check or a Certified Check is included.

Plans Included  
Herein

Prepared by	S
Checked by	

(Printed by authority of the State of Illinois)

---

---

## INSTRUCTIONS

**ABOUT IDOT PROPOSALS:** All proposals issued by IDOT are potential bidding proposals. Each proposal contains all Certifications and Affidavits, a Proposal Signature Sheet and a Proposal Bid Bond required for Prime Contractors to submit a bid after written **Authorization to Bid** has been issued by IDOT's Central Bureau of Construction.

**WHO CAN BID?:** Bids will be accepted from only those companies that request and receive written **Authorization to Bid** from IDOT's Central Bureau of Construction. To request authorization, a potential bidder must complete and submit Part B of the Request for Authorization to Bid/or Not For Bid Status form (BDE 124 INT) and submit an original Affidavit of Availability (BC 57).

**WHAT CONSTITUTES WRITTEN AUTHORIZATION TO BID?:** When a prospective prime bidder submits a "Request for Proposal Forms and Plans" he/she must indicate at that time which items are being requested For Bidding purposes. Only those items requested For Bidding will be analyzed. After the request has been analyzed, the bidder will be issued a **Proposal Denial and/or Authorization Form**, approved by the Central Bureau of Construction, that indicates which items have been approved For Bidding. If **Authorization to Bid** cannot be approved, the **Proposal Denial and/or Authorization Form** will indicate the reason for denial. If a contractor has requested to bid but has not received a **Proposal Denial and/or Authorization Form**, they should contact the Central Bureau of Construction in advance of the letting date.

**WHAT MUST BE INCLUDED WHEN BIDS ARE SUBMITTED?:** Bidders need not return the entire proposal when bids are submitted. That portion of the proposal that must be returned includes the following:

1. All documents from the Proposal Cover Sheet through the Proposal Bid Bond
2. Other special documentation and/or information that may be required by the contract special provisions

All proposal documents, including Proposal Guaranty Checks or Proposal Bid Bonds, should be stapled together to prevent loss when bids are processed by IDOT personnel.

**ABOUT SUBMITTING BIDS:** It is recommended that bidders deliver bids in person to insure they arrive at the proper location prior to the time specified for the receipt of bids. Any bid received at the place of letting after the time specified will not be accepted.

### WHO SHOULD BE CALLED IF ASSISTANCE IS NEEDED?

Questions Regarding	Call
Prequalification and/or Authorization to Bid	217/782-3413
Preparation and submittal of bids	217/782-7806
Mailing of CD-ROMS	217/782-7806

RETURN WITH BID



PROPOSAL

TO THE DEPARTMENT OF TRANSPORTATION

1. Proposal of \_\_\_\_\_

\_\_\_\_\_

Taxpayer Identification Number (Mandatory) \_\_\_\_\_ a

for the improvement identified and advertised for bids in the Invitation for Bids as:

**Contract No. 44952**  
**Various Counties**  
**Section INT ATTRACT SIGN 2007-19**  
**Various Routes**  
**District TR Construction Funds**

**Install or replace tourist attraction signs and supports at various locations in the state.**

2. The undersigned bidder will furnish all labor, material and equipment to complete the above described project in a good and workmanlike manner as provided in the contract documents provided by the Department of Transportation. This proposal will become part of the contract and the terms and conditions contained in the contract documents shall govern performance and payments.

**RETURN WITH BID**

3. **ASSURANCE OF EXAMINATION AND INSPECTION/WAIVER.** The undersigned further declares that he/she has carefully examined the proposal, plans, specifications, form of contract and contract bond, and special provisions, and that he/she has inspected in detail the site of the proposed work, and that he/she has familiarized themselves with all of the local conditions affecting the contract and the detailed requirements of construction, and understands that in making this proposal he/she waives all right to plead any misunderstanding regarding the same.
4. **EXECUTION OF CONTRACT AND CONTRACT BOND.** The undersigned further agrees to execute a contract for this work and present the same to the department within fifteen (15) days after the contract has been mailed to him/her. The undersigned further agrees that he/she and his/her surety will execute and present within fifteen (15) days after the contract has been mailed to him/her contract bond satisfactory to and in the form prescribed by the Department of Transportation, in the penal sum of the full amount of the contract, guaranteeing the faithful performance of the work in accordance with the terms of the contract.
5. **PROPOSAL GUARANTY.** Accompanying this proposal is either a bid bond on the department form, executed by a corporate surety company satisfactory to the department, or a proposal guaranty check consisting of a bank cashier's check or a properly certified check for not less than 5 per cent of the amount bid or for the amount specified in the following schedule:

<u>Amount of Bid</u>		<u>Proposal Guaranty</u>	<u>Amount of Bid</u>		<u>Proposal Guaranty</u>
Up to	\$5,000	\$150	\$2,000,000	to	\$3,000,000
\$5,000	to	\$300	\$3,000,000	to	\$5,000,000
\$10,000	to	\$1,000	\$5,000,000	to	\$7,500,000
\$50,000	to	\$3,000	\$7,500,000	to	\$10,000,000
\$100,000	to	\$5,000	\$10,000,000	to	\$15,000,000
\$150,000	to	\$7,500	\$15,000,000	to	\$20,000,000
\$250,000	to	\$12,500	\$20,000,000	to	\$25,000,000
\$500,000	to	\$25,000	\$25,000,000	to	\$30,000,000
\$1,000,000	to	\$50,000	\$30,000,000	to	\$35,000,000
\$1,500,000	to	\$75,000	over		\$35,000,000

Bank cashier's checks or properly certified checks accompanying proposals shall be made payable to the Treasurer, State of Illinois, when the state is awarding authority; the county treasurer, when a county is the awarding authority; or the city, village, or town treasurer, when a city, village, or town is the awarding authority.

If a combination bid is submitted, the proposal guaranties which accompany the individual proposals making up the combination will be considered as also covering the combination bid.

The amount of the proposal guaranty check is \_\_\_\_\_ \$( \_\_\_\_\_ ). If this proposal is accepted and the undersigned shall fail to execute a contract bond as required herein, it is hereby agreed that the amount of the proposal guaranty shall become the property of the State of Illinois, and shall be considered as payment of damages due to delay and other causes suffered by the State because of the failure to execute said contract and contract bond; otherwise, the bid bond shall become void or the proposal guaranty check shall be returned to the undersigned.

**Attach Cashier's Check or Certified Check Here**

In the event that one proposal guaranty check is intended to cover two or more proposals, the amount must be equal to the sum of the proposal guaranties which would be required for each individual proposal. If the guaranty check is placed in another proposal, state below where it may be found.

The proposal guaranty check will be found in the proposal for:

Item \_\_\_\_\_

Section No. \_\_\_\_\_

County \_\_\_\_\_

Mark the proposal cover sheet as to the type of proposal guaranty submitted.

**RETURN WITH BID**

6. **COMBINATION BIDS.** The undersigned further agrees that if awarded the contract for the sections contained in the following combination, he/she will perform the work in accordance with the requirements of each individual proposal comprising the combination bid specified in the schedule below, and that the combination bid shall be prorated against each section in proportion to the bid submitted for the same. If an error is found to exist in the gross sum bid for one or more of the individual sections included in a combination, the combination bid shall be corrected as provided in the specifications.

**When a combination bid is submitted, the schedule below must be completed in each proposal comprising the combination.**

**If alternate bids are submitted for one or more of the sections comprising the combination, a combination bid must be submitted for each alternate.**

**Schedule of Combination Bids**

Combination No.	Sections Included in Combination	Combination Bid	
		Dollars	Cents

7. **SCHEDULE OF PRICES.** The undersigned bidder submits herewith, in accordance with the rules and instructions, a schedule of prices for the items of work for which bids are sought. The unit prices bid are in U.S. dollars and cents, and all extensions and summations have been made. The bidder understands that the quantities appearing in the bid schedule are approximate and are provided for the purpose of obtaining a gross sum for the comparison of bids. If there is an error in the extension of the unit prices, the unit prices shall govern. Payment to the contractor awarded the contract will be made only for actual quantities of work performed and accepted or materials furnished according to the contract. The scheduled quantities of work to be done and materials to be furnished may be increased, decreased or omitted as provided elsewhere in the contract.

8. **CERTIFICATE OF AUTHORITY.** The undersigned bidder, if a business organized under the laws of another State, assures the Department that it will furnish a copy of its certificate of authority to do business in the State of Illinois with the return of the executed contract and bond. Failure to furnish the certificate within the time provided for execution of an awarded contract may be cause for cancellation of the award and forfeiture of the proposal guaranty to the State.

ILLINOIS DEPARTMENT OF TRANSPORTATION  
 SCHEDULE OF PRICES  
 CONTRACT  
 NUMBER - 44952

State Job # - C-60-026-07  
 PPS NBR - 0-01050-0000  
 County Name - VARIOUS- -  
 Code - 0 - -  
 District - 0 - -  
 Section Number - INT ATTRACT SIGN 2007-19

Project Number

Route  
 VARIOUS

Item Number	Pay Item Description	Unit of Measure	Quantity	x	Unit Price	=	Total Price
T9990500	STR STL SIN SUP BA	POUND	146,440.000				
T9990900	CONC FOUNDATIONS	CU YD	290.000				
T9991300	REM EX SIGN PANEL	EACH	100.000				
T9991500	REM EX SIGN COMPL	EACH	10.000				
T9991700	REM CONC FDN-GR MT	EACH	10.000				
T9992700	REM & REIN SIGN PANEL	SQ FT	1,900.000				
T9994000	REM EX SIN SUP	EACH	30.000				
T9996600	INS SER SN OR MILE PL	EACH	400.000				
T9996700	REM SER OR MILE PLATE	EACH	100.000				
T9998500	TRANSFER SERVICE SIGN	EACH	100.000				
67100100	MOBILIZATION	L SUM	1.000				
72000300	SIGN PANEL T3	SQ FT	26,640.000				



**CONTRACT NUMBER**

**44952**

**THIS IS THE TOTAL BID**

**\$ \_\_\_\_\_**

**NOTES:**

1. Each PAY ITEM should have a UNIT PRICE and a TOTAL PRICE.
2. The UNIT PRICE shall govern if no TOTAL PRICE is shown or if there is a discrepancy between the product of the UNIT PRICE multiplied by the QUANTITY.
3. If a UNIT PRICE is omitted, the TOTAL PRICE will be divided by the QUANTITY in order to establish a UNIT PRICE.
4. A bid may be declared UNACCEPTABLE if neither a unit price nor a total price is shown.

## RETURN WITH BID

### **STATE REQUIRED ETHICAL STANDARDS GOVERNING CONTRACT PROCUREMENT: ASSURANCES, CERTIFICATIONS AND DISCLOSURES**

#### **I. GENERAL**

**A.** Article 50 of the Illinois Procurement Code establishes the duty of all State chief procurement officers, State purchasing officers, and their designees to maximize the value of the expenditure of public moneys in procuring goods, services, and contracts for the State of Illinois and to act in a manner that maintains the integrity and public trust of State government. In discharging this duty, they are charged by law to use all available information, reasonable efforts, and reasonable actions to protect, safeguard, and maintain the procurement process of the State of Illinois.

**B.** In order to comply with the provisions of Article 50 and to carry out the duty established therein, all bidders are to adhere to ethical standards established for the procurement process, and to make such assurances, disclosures and certifications required by law. By execution of the Proposal Signature Sheet, the bidder indicates that each of the mandated assurances has been read and understood, that each certification is made and understood, and that each disclosure requirement has been understood and completed.

**C.** In addition to all other remedies provided by law, failure to comply with any assurance, failure to make any disclosure or the making of a false certification shall be grounds for termination of the contract and the suspension or debarment of the bidder.

#### **II. ASSURANCES**

**A.** The assurances hereinafter made by the bidder are each a material representation of fact upon which reliance is placed should the Department enter into the contract with the bidder. The Department may terminate the contract if it is later determined that the bidder rendered a false or erroneous assurance, and the surety providing the performance bond shall be responsible for the completion of the contract.

##### **B. Felons**

1. The Illinois Procurement Code provides:

Section 50-10. Felons. Unless otherwise provided, no person or business convicted of a felony shall do business with the State of Illinois or any state agency from the date of conviction until 5 years after the date of completion of the sentence for that felony, unless no person held responsible by a prosecutorial office for the facts upon which the conviction was based continues to have any involvement with the business.

2. The bidder assures the Department that the award and execution of the contract would not cause a violation of Section 50-10.

##### **C. Conflicts of Interest**

1. The Illinois Procurement Code provides in pertinent part:

Section 50-13. Conflicts of Interest.

(a) Prohibition. It is unlawful for any person holding an elective office in this State, holding a seat in the General Assembly, or appointed to or employed in any of the offices or agencies of state government and who receives compensation for such employment in excess of 60% of the salary of the Governor of the State of Illinois, or who is an officer or employee of the Capital Development Board or the Illinois Toll Highway Authority, or who is the spouse or minor child of any such person to have or acquire any contract, or any direct pecuniary interest in any contract therein, whether for stationery, printing, paper, or any services, materials, or supplies, that will be wholly or partially satisfied by the payment of funds appropriated by the General Assembly of the State of Illinois or in any contract of the Capital Development Board or the Illinois Toll Highway authority.

(b) Interests. It is unlawful for any firm, partnership, association or corporation, in which any person listed in subsection (a) is entitled to receive (i) more than 7 1/2% of the total distributable income or (ii) an amount in excess of the salary of the Governor, to have or acquire any such contract or direct pecuniary interest therein.

(c) Combined interests. It is unlawful for any firm, partnership, association, or corporation, in which any person listed in subsection (a) together with his or her spouse or minor children is entitled to receive (i) more than 15%, in the aggregate, of the total distributable income or (ii) an amount in excess of 2 times the salary of the Governor, to have or acquire any such contract or direct pecuniary interest therein.

(d) Securities. Nothing in this Section invalidates the provisions of any bond or other security previously offered or to be offered for sale or sold by or for the State of Illinois.

(e) Prior interests. This Section does not affect the validity of any contract made between the State and an officer or employee of the State or member of the General Assembly, his or her spouse, minor child or any combination of those persons if that contract was in existence before his or her election or employment as an officer, member, or employee. The contract is voidable, however, if it cannot be completed within 365 days after the officer, member, or employee takes office or is employed.

The current salary of the Governor is \$150,700.00. Sixty percent of the salary is \$90,420.00.

## RETURN WITH BID

2. The bidder assures the Department that the award and execution of the contract would not cause a violation of Section 50-13, or that an effective exemption has been issued by the Board of Ethics to any individual subject to the Section 50-13 prohibitions pursuant to the provisions of Section 50-20 of the Code and Executive Order Number 3 (1998). Information concerning the exemption process is available from the Department upon request.

### **D. Negotiations**

1. The Illinois Procurement Code provides in pertinent part:

Section 50-15. Negotiations.

(a) It is unlawful for any person employed in or on a continual contractual relationship with any of the offices or agencies of State government to participate in contract negotiations on behalf of that office or agency with any firm, partnership, association, or corporation with whom that person has a contract for future employment or is negotiating concerning possible future employment.

2. The bidder assures the Department that the award and execution of the contract would not cause a violation of Section 50-15, and that the bidder has no knowledge of any facts relevant to the kinds of acts prohibited therein.

### **E. Inducements**

1. The Illinois Procurement Code provides:

Section 50-25. Inducement. Any person who offers or pays any money or other valuable thing to any person to induce him or her not to bid for a State contract or as recompense for not having bid on a State contract is guilty of a Class 4 felony. Any person who accepts any money or other valuable thing for not bidding for a State contract or who withholds a bid in consideration of the promise for the payment of money or other valuable thing is guilty of a Class 4 felony.

2. The bidder assures the Department that the award and execution of the contract would not cause a violation of Section 50-25, and that the bidder has no knowledge of any facts relevant to the kinds of acts prohibited therein.

### **F. Revolving Door Prohibition**

1. The Illinois Procurement Code provides:

Section 50-30. Revolving door prohibition. Chief procurement officers, associate procurement officers, State purchasing officers, their designees whose principal duties are directly related to State procurement, and executive officers confirmed by the Senate are expressly prohibited for a period of 2 years after terminating an affected position from engaging in any procurement activity relating to the State agency most recently employing them in an affected position for a period of at least 6 months. The prohibition includes, but is not limited to: lobbying the procurement process; specifying; bidding; proposing bid, proposal, or contract documents; on their own behalf or on behalf of any firm, partnership, association, or corporation. This Section applies only to persons who terminate an affected position on or after January 15, 1999.

2. The bidder assures the Department that the award and execution of the contract would not cause a violation of Section 50-30, and that the bidder has no knowledge of any facts relevant to the kinds of acts prohibited therein.

### **G. Reporting Anticompetitive Practices**

1. The Illinois Procurement Code provides:

Section 50-40. Reporting anticompetitive practices. When, for any reason, any vendor, bidder, contractor, chief procurement officer, State purchasing officer, designee, elected official, or State employee suspects collusion or other anticompetitive practice among any bidders, offerors, contractors, proposers, or employees of the State, a notice of the relevant facts shall be transmitted to the Attorney General and the chief procurement officer.

2. The bidder assures the Department that it has not failed to report any relevant facts concerning the practices addressed in Section 50-40 which may involve the contract for which the bid is submitted.

### **H. Confidentiality**

1. The Illinois Procurement Code provides:

Section 50-45. Confidentiality. Any chief procurement officer, State purchasing officer, designee, or executive officer who willfully uses or allows the use of specifications, competitive bid documents, proprietary competitive information, proposals, contracts, or selection information to compromise the fairness or integrity of the procurement, bidding, or contract process shall be subject to immediate dismissal, regardless of the Personnel code, any contract, or any collective bargaining agreement, and may in addition be subject to criminal prosecution.

2. The bidder assures the Department that it has no knowledge of any fact relevant to the practices addressed in Section 50-45 which may involve the contract for which the bid is submitted.

## RETURN WITH BID

### **I. Insider Information**

1. The Illinois Procurement Act provides:

Section 50-50. Insider information. It is unlawful for any current or former elected or appointed State official or State employee to knowingly use confidential information available only by virtue of that office or employment for actual or anticipated gain for themselves or another person.

2. The bidder assures the Department that it has no knowledge of any facts relevant to the practices addressed in Section 50-50 which may involve the contract for which the bid is submitted.

### **III. CERTIFICATIONS**

**A.** The certifications hereinafter made by the bidder are each a material representation of fact upon which reliance is placed should the Department enter into the contract with the bidder. The Department may terminate the contract if it is later determined that the bidder rendered a false or erroneous certification, and the surety providing the performance bond shall be responsible for completion of the contract.

#### **B. Bribery**

1. The Illinois Procurement Code provides:

Section 50-5. Bribery.

(a) Prohibition. No person or business shall be awarded a contract or subcontract under this Code who:

(1) has been convicted under the laws of Illinois or any other state of bribery or attempting to bribe an officer or employee of the State of Illinois or any other state in that officer's or employee's official capacity; or

(2) has made an admission of guilt of that conduct that is a matter of record but has not been prosecuted for that conduct.

(b) Businesses. No business shall be barred from contracting with any unit of State or local government as a result of a conviction under this Section of any employee or agent of the business if the employee or agent is no longer employed by the business and:

(1) the business has been finally adjudicated not guilty; or

(2) the business demonstrates to the governmental entity with which it seeks to contract, and that entity finds that the commission of the offense was not authorized, requested, commanded, or performed by a director, officer, or high managerial agent on behalf of the business as provided in paragraph (2) of subsection (a) of Section 5-4 of the Criminal Code of 1961.

(c) Conduct on behalf of business. For purposes of this Section, when an official, agent, or employee of a business committed the bribery or attempted bribery on behalf of the business and in accordance with the direction or authorization of a responsible official of the business, the business shall be chargeable with the conduct.

(d) Certification. Every bid submitted to and contract executed by the State shall contain a certification by the contractor that the contractor is not barred from being awarded a contract or subcontract under this Section. A contractor who makes a false statement, material to the certification, commits a Class 3 felony.

2. The bidder certifies that it is not barred from being awarded a contract under Section 50.5.

#### **C. Educational Loan**

1. Section 3 of the Educational Loan Default Act provides:

§ 3. No State agency shall contract with an individual for goods or services if that individual is in default, as defined in Section 2 of this Act, on an educational loan. Any contract used by any State agency shall include a statement certifying that the individual is not in default on an educational loan as provided in this Section.

2. The bidder, if an individual as opposed to a corporation, partnership or other form of business organization, certifies that the bidder is not in default on an educational loan as provided in Section 3 of the Act.

#### **D. Bid-Rigging/Bid Rotating**

1. Section 33E-11 of the Criminal Code of 1961 provides:

§ 33E-11. (a) Every bid submitted to and public contract executed pursuant to such bid by the State or a unit of local government shall contain a certification by the prime contractor that the prime contractor is not barred from contracting with any unit of State or local government as a result of a violation of either Section 33E-3 or 33E-4 of this Article. The State and units of local government shall provide the appropriate forms for such certification.

## RETURN WITH BID

(b) A contractor who makes a false statement, material to the certification, commits a Class 3 felony.

A violation of Section 33E-3 would be represented by a conviction of the crime of bid-rigging which, in addition to Class 3 felony sentencing, provides that any person convicted of this offense or any similar offense of any state or the United States which contains the same elements as this offense shall be barred for 5 years from the date of conviction from contracting with any unit of State or local government. No corporation shall be barred from contracting with any unit of State or local government as a result of a conviction under this Section of any employee or agent of such corporation if the employee so convicted is no longer employed by the corporation and: (1) it has been finally adjudicated not guilty or (2) if it demonstrates to the governmental entity with which it seeks to contract and that entity finds that the commission of the offense was neither authorized, requested, commanded, nor performed by a director, officer or a high managerial agent in behalf of the corporation.

A violation of Section 33E-4 would be represented by a conviction of the crime of bid-rotating which, in addition to Class 2 felony sentencing, provides that any person convicted of this offense or any similar offense of any state or the United States which contains the same elements as this offense shall be permanently barred from contracting with any unit of State or local government. No corporation shall be barred from contracting with any unit of State or local government as a result of a conviction under this Section of any employee or agent of such corporation if the employee so convicted is no longer employed by the corporation and: (1) it has been finally adjudicated not guilty or (2) if it demonstrates to the governmental entity with which it seeks to contract and that entity finds that the commission of the offense was neither authorized, requested, commanded, nor performed by a director, officer or a high managerial agent in behalf of the corporation.

2. The bidder certifies that it is not barred from contracting with the Department by reason of a violation of either Section 33E-3 or Section 33E-4.

### **E. International Anti-Boycott**

1. Section 5 of the International Anti-Boycott Certification Act provides:

§ 5. State contracts. Every contract entered into by the State of Illinois for the manufacture, furnishing, or purchasing of supplies, material, or equipment or for the furnishing of work, labor, or services, in an amount exceeding the threshold for small purchases according to the purchasing laws of this State or \$10,000.00, whichever is less, shall contain certification, as a material condition of the contract, by which the contractor agrees that neither the contractor nor any substantially-owned affiliated company is participating or shall participate in an international boycott in violation of the provisions of the U.S. Export Administration Act of 1979 or the regulations of the U.S. Department of Commerce promulgated under that Act.

2. The bidder makes the certification set forth in Section 5 of the Act.

### **F. Drug Free Workplace**

1. The Illinois "Drug Free Workplace Act" applies to this contract and it is necessary to comply with the provisions of the "Act" if the contractor is a corporation, partnership, or other entity (including a sole proprietorship) which has 25 or more employees.

2. The bidder certifies that if awarded a contract in excess of \$5,000 it will provide a drug free workplace by:

(a) Publishing a statement notifying employees that the unlawful manufacture, distribution, dispensation, possession or use of a controlled substance, including cannabis, is prohibited in the contractor's workplace; specifying the actions that will be taken against employees for violations of such prohibition; and notifying the employee that, as a condition of employment on such contract, the employee shall abide by the terms of the statement, and notify the employer of any criminal drug statute conviction for a violation occurring in the workplace no later than five (5) days after such conviction.

(b) Establishing a drug free awareness program to inform employees about the dangers of drug abuse in the workplace; the contractor's policy of maintaining a drug free workplace; any available drug counseling, rehabilitation, and employee assistance programs; and the penalties that may be imposed upon employees for drug violations.

(c) Providing a copy of the statement required by subparagraph (1) to each employee engaged in the performance of the contract and to post the statement in a prominent place in the workplace.

(d) Notifying the Department within ten (10) days after receiving notice from an employee or otherwise receiving actual notice of the conviction of an employee for a violation of any criminal drug statute occurring in the workplace.

(e) Imposing or requiring, within 30 days after receiving notice from an employee of a conviction or actual notice of such a conviction, an appropriate personnel action, up to and including termination, or the satisfactory participation in a drug abuse assistance or rehabilitation program approved by a federal, state or local health, law enforcement or other appropriate agency.

(f) Assisting employees in selecting a course of action in the event drug counseling, treatment, and rehabilitation is required and indicating that a trained referral team is in place.

(g) Making a good faith effort to continue to maintain a drug free workplace through implementation of the actions and efforts stated in this certification.

**G. Debt Delinquency**

1. The Illinois Procurement Code provides:

Section 50-11 and 50-12. Debt Delinquency.

The contractor or bidder certifies that it, or any affiliate, is not barred from being awarded a contract under 30 ILCS 500. Section 50-11 prohibits a person from entering into a contract with a State agency if it knows or should know that it, or any affiliate, is delinquent in the payment of any debt to the State as defined by the Debt Collection Board. Section 50-12 prohibits a person from entering into a contract with a State agency if it, or any affiliate, has failed to collect and remit Illinois Use Tax on all sales of tangible personal property into the State of Illinois in accordance with the provisions of the Illinois Use Tax Act. The contractor further acknowledges that the contracting State agency may declare the contract void if this certification is false or if the contractor, or any affiliate, is determined to be delinquent in the payment of any debt to the State during the term of the contract.

**H. Sarbanes-Oxley Act of 2002**

1. The Illinois Procurement Code provides:

Section 50-60(c).

The contractor certifies in accordance with 30 ILCS 500/50-10.5 that no officer, director, partner or other managerial agent of the contracting business has been convicted of a felony under the Sarbanes-Oxley Act of 2002 or a Class 3 or Class 2 felony under the Illinois Securities Law of 1953 for a period of five years prior to the date of the bid or contract. The contractor acknowledges that the contracting agency shall declare the contract void if this certification is false.

**I. Addenda**

The contractor or bidder certifies that all relevant addenda have been incorporated in to this contract. Failure to do so may cause the bid to be declared unacceptable.

**J. Section 42 of the Environmental Protection Act**

The contractor certifies in accordance with 30 ILCS 500/50-12 that the bidder or contractor is not barred from being awarded a contract under this Section which prohibits the bidding on or entering into contracts with the State of Illinois or a State agency by a person or business found by a court or the Pollution Control Board to have committed a willful or knowing violation of Section 42 of the Environmental Protection Act for a period of five years from the date of the order. The contractor acknowledges that the contracting agency may declare the contract void if this certification is false.

**K. Apprenticeship and Training Certification (Does not apply to federal aid projects)**

In accordance with the provisions of Section 30-22 (6) of the Illinois Procurement Code, the bidder certifies that it is a participant, either as an individual or as part of a group program, in the approved apprenticeship and training programs applicable to each type of work or craft that the bidder will perform with its own forces. The bidder further certifies for work that will be performed by subcontract that each of its subcontractors submitted for approval either (a) is, at the time of such bid, participating in an approved, applicable apprenticeship and training program; or (b) will, prior to commencement of performance of work pursuant to this contract, begin participation in an approved apprenticeship and training program applicable to the work of the subcontract. The Department, at any time before or after award, may require the production of a copy of each applicable Certificate of Registration issued by the United States Department of Labor evidencing such participation by the contractor and any or all of its subcontractors. Applicable apprenticeship and training programs are those that have been approved and registered with the United States Department of Labor. The bidder shall list in the space below, the official name of the program sponsor holding the Certificate of Registration for all of the types of work or crafts in which the bidder is a participant and that will be performed with the bidder's forces. Types of work or craft work that will be subcontracted shall be included and listed as subcontract work. The list shall also indicate any type of work or craft job category that does not have an applicable apprenticeship or training program. **The bidder is responsible for making a complete report and shall make certain that each type of work or craft job category that will be utilized on the project as reported on the Construction Employee Workforce Projection (Form BC-1256) and returned with the bid is accounted for and listed.**

---

---

---

The requirements of this certification and disclosure are a material part of the contract, and the contractor shall require this certification provision to be included in all approved subcontracts. In order to fulfill this requirement, it shall not be necessary that an applicable program sponsor be currently taking or that it will take applications for apprenticeship, training or employment during the performance of the work of this contract.

**L. Executive Order Number 1 (2007) Regarding Lobbying on Government Procurements**

The bidder hereby warrants and certifies that they have complied and will comply with the requirements set forth in this Order. The requirements of this warrant and certification are a material part of the contract, and the contractor shall require this warrant and certification provision to be included in all approved subcontracts.

**TO BE RETURNED WITH BID**

**IV. DISCLOSURES**

**A.** The disclosures hereinafter made by the bidder are each a material representation of fact upon which reliance is placed should the Department enter into the contract with the bidder. The Department may terminate the contract if it is later determined that the bidder rendered a false or erroneous disclosure, and the surety providing the performance bond shall be responsible for completion of the contract.

**B. Financial Interests and Conflicts of Interest**

1. Section 50-35 of the Illinois Procurement Code provides that all bids of more than \$10,000 shall be accompanied by disclosure of the financial interests of the bidder. This disclosed information for the successful bidder, will be maintained as public information subject to release by request pursuant to the Freedom of Information Act.

The financial interests to be disclosed shall include ownership or distributive income share that is in excess of 5%, or an amount greater than 60% of the annual salary of the Governor, of the bidding entity or its parent entity, whichever is less, unless the contractor or bidder is a publicly traded entity subject to Federal 10K reporting, in which case it may submit its 10K disclosure in place of the prescribed disclosure. If a bidder is a privately held entity that is exempt from Federal 10K reporting, but has more than 400 shareholders, it may submit the information that Federal 10K companies are required to report, and list the names of any person or entity holding any ownership share that is in excess of 5%. The disclosure shall include the names, addresses, and dollar or proportionate share of ownership of each person making the disclosure, their instrument of ownership or beneficial relationship, and notice of any potential conflict of interest resulting from the current ownership or beneficial interest of each person making the disclosure having any of the relationships identified in Section 50-35 and on the disclosure form.

In addition, all disclosures shall indicate any other current or pending contracts, proposals, leases, or other ongoing procurement relationships the bidding entity has with any other unit of state government and shall clearly identify the unit and the contract, proposal, lease, or other relationship.

2. Disclosure Forms. Disclosure Form A is attached for use concerning the individuals meeting the above ownership or distributive share requirements. Subject individuals should be covered each by one form. In addition, a second form (Disclosure Form B) provides for the disclosure of current or pending procurement relationships with other (non-IDOT) state agencies. **The forms must be included with each bid or incorporated by reference.**

**C. Disclosure Form Instructions**

**Form A: For bidders that have previously submitted the information requested in Form A**

The Department has retained the Form A disclosures submitted by all bidders responding to these requirements for the April 24, 1998 or any subsequent letting conducted by the Department. The bidder has the option of submitting the information again or the bidder may sign the following certification statement indicating that the information previously submitted by the bidder is, as of the date of signature, current and accurate. The Certification must be signed and dated by a person who is authorized to execute contracts for the bidding company. Before signing this certification, the bidder should carefully review its prior submissions to ensure the Certification is correct. If the Bidder signs the Certification, the Bidder should proceed to Form B instructions.

**CERTIFICATION STATEMENT**

**I have determined that the Form A disclosure information previously submitted is current and accurate, and all forms are hereby incorporated by reference in this bid. Any necessary additional forms or amendments to previously submitted forms are attached to this bid.**

\_\_\_\_\_  
(Bidding Company)

\_\_\_\_\_  
Name of Authorized Representative (type or print)

\_\_\_\_\_  
Title of Authorized Representative (type or print)

\_\_\_\_\_  
Signature of Authorized Representative

\_\_\_\_\_  
Date

**Form A: For bidders who have NOT previously submitted the information requested in Form A**

If the bidder is a publicly traded entity subject to Federal 10K reporting, the 10K Report may be submitted to meet the requirements of Form A. If a bidder is a privately held entity that is exempt from Federal 10K reporting, but has more than 400 shareholders, it may submit the information that Federal 10K companies are required to report, and list the names of any person or entity holding any ownership share that is in excess of 5%. If a bidder is not subject to Federal 10K reporting, the bidder must determine if any individuals are required by law to complete a financial disclosure form. To do this, the bidder should answer each of the following questions. A "YES" answer indicates Form A must be completed. If the answer to each of the following questions is "NO", then the NOT APPLICABLE STATEMENT on the second page of Form A must be signed and dated by a person that is authorized to execute contracts for the bidding company. Note: These questions are for assistance only and are not required to be completed.

1. Does anyone in your organization have a direct or beneficial ownership share of greater than 5% of the bidding entity or parent entity? YES \_\_\_ NO \_\_\_
2. Does anyone in your organization have a direct or beneficial ownership share of less than 5%, but which has a value greater than \$90,420.00? YES \_\_\_ NO \_\_\_
3. Does anyone in your organization receive more than \$90,420.00 of the bidding entity's or parent entity's distributive income? (Note: Distributive income is, for these purposes, any type of distribution of profits. An annual salary is not distributive income.) YES \_\_\_ NO \_\_\_
4. Does anyone in your organization receive greater than 5% of the bidding entity's or parent entity's total distributive income, but which is less than \$90,420.00? YES \_\_\_ NO \_\_\_

(Note: Only one set of forms needs to be completed per person per bid even if a specific individual would require a yes answer to more than one question.)

A "YES" answer to any of these questions requires the completion of Form A. The bidder must determine each individual in the bidding entity or the bidding entity's parent company that would cause the questions to be answered "Yes". Each form must be signed and dated by a person that is authorized to execute contracts for your organization. **Photocopied or stamped signatures are not acceptable.** The person signing can be, but does not have to be, the person for which the form is being completed. The bidder is responsible for the accuracy of any information provided.

If the answer to each of the above questions is "NO", then the NOT APPLICABLE STATEMENT on page 2 of Form A must be signed and dated by a person that is authorized to execute contracts for your company.

**Form B: Identifying Other Contracts & Procurement Related Information** Disclosure Form B must be completed for each bid submitted by the bidding entity. It must be signed by an individual who is authorized to execute contracts for the bidding entity. *Note: Signing the NOT APPLICABLE STATEMENT on Form A does not allow the bidder to ignore Form B. Form B must be completed, signed and dated or the bidder may be considered nonresponsive and the bid will not be accepted.*

The Bidder shall identify, by checking Yes or No on Form B, whether it has any pending contracts (including leases), bids, proposals, or other ongoing procurement relationship with any other (non-IDOT) State of Illinois agency. If "No" is checked, the bidder only needs to complete the signature box on the bottom of Form B. If "Yes" is checked, the bidder must do one of the following:

Option I: If the bidder did not submit an Affidavit of Availability to obtain authorization to bid, the bidder must list all non-IDOT State of Illinois agency pending contracts, leases, bids, proposals, and other ongoing procurement relationships. These items may be listed on Form B or on an attached sheet(s). Do not include IDOT contracts. Contracts with cities, counties, villages, etc. are not considered State of Illinois agency contracts and are not to be included. Contracts with other State of Illinois agencies such as the Department of Natural Resources or the Capital Development Board must be included. Bidders who submit Affidavits of Availability are suggested to use Option II.

Option II: If the bidder is required and has submitted an Affidavit of Availability in order to obtain authorization to bid, the bidder may write or type "See Affidavit of Availability" which indicates that the Affidavit of Availability is incorporated by reference and includes all non-IDOT State of Illinois agency pending contracts, leases, bids, proposals, and other ongoing procurement relationships. For any contracts that are not covered by the Affidavit of Availability, the bidder must identify them on Form B or on an attached sheet(s). These might be such things as leases.

**D. Bidders Submitting More Than One Bid**

Bidders submitting multiple bids may submit one set of forms consisting of all required Form A disclosures and one Form B for use with all bids. Please indicate in the space provided below the bid item that contains the original disclosure forms and the bid items which incorporate the forms by reference.

- The bid submitted for letting item \_\_\_\_\_ contains the Form A disclosures or Certification Statement and the Form B disclosures. The following letting items incorporate the said forms by reference:

---



---



**ILLINOIS DEPARTMENT  
OF TRANSPORTATION**

**Form A  
Financial Information &  
Potential Conflicts of Interest  
Disclosure**

Contractor Name		
Legal Address		
City, State, Zip		
Telephone Number	Email Address	Fax Number (if available)

Disclosure of the information contained in this Form is required by the Section 50-35 of the Illinois Procurement Code (30 ILCS 500). Vendors desiring to enter into a contract with the State of Illinois must disclose the financial information and potential conflict of interest information as specified in this Disclosure Form. This information shall become part of the publicly available contract file. This Form A must be completed for bids in excess of \$10,000, and for all open-ended contracts. **A publicly traded company may submit a 10K disclosure (or equivalent if applicable) in satisfaction of the requirements set forth in Form A. See Disclosure Form Instructions.**

**DISCLOSURE OF FINANCIAL INFORMATION**

**1. Disclosure of Financial Information.** The individual named below has an interest in the BIDDER (or its parent) in terms of ownership or distributive income share in excess of 5%, or an interest which has a value of more than \$90,420.00 (60% of the Governor's salary as of 7/1/01). **(Make copies of this form as necessary and attach a separate Disclosure Form A for each individual meeting these requirements)**

**FOR INDIVIDUAL (type or print information)**

**NAME:** \_\_\_\_\_

**ADDRESS** \_\_\_\_\_

**Type of ownership/distributable income share:**

stock \_\_\_\_\_ sole proprietorship \_\_\_\_\_ Partnership \_\_\_\_\_ other: (explain on separate sheet):  
% or \$ value of ownership/distributable income share: \_\_\_\_\_

**2. Disclosure of Potential Conflicts of Interest.** Check "Yes" or "No" to indicate which, if any, of the following potential conflict of interest relationships apply. If the answer to any question is "Yes", please attach additional pages and describe.

(a) State employment, currently or in the previous 3 years, including contractual employment of services. Yes \_\_\_ No \_\_\_

If your answer is yes, please answer each of the following questions.

1. Are you currently an officer or employee of either the Capitol Development Board or the Illinois Toll Highway Authority? Yes \_\_\_ No \_\_\_

2. Are you currently appointed to or employed by any agency of the State of Illinois? If you are currently appointed to or employed by any agency of the State of Illinois, and your annual salary exceeds \$90,420.00, (60% of the Governor's salary as of 7/1/01) provide the name the State agency for which you are employed and your annual salary. \_\_\_\_\_

**RETURN WITH BID/OFFER**

- 3. If you are currently appointed to or employed by any agency of the State of Illinois, and your annual salary exceeds \$90,420.00, (60% of the Governor's salary as of 7/1/01) are you entitled to receive (i) more than 7 1/2% of the total distributable income of your firm, partnership, association or corporation, or (ii) an amount in excess of the salary of the Governor? Yes \_\_\_ No \_\_\_
- 4. If you are currently appointed to or employed by any agency of the State of Illinois, and your annual salary exceeds \$90,420.00, (60% of the Governor's salary as of 7/1/01) are you and your spouse or minor children entitled to receive (i) more than 15 % in the aggregate of the total distributable income of your firm, partnership, association or corporation, or (ii) an amount in excess of 2 times the salary of the Governor? Yes \_\_\_ No \_\_\_

---

(b) State employment of spouse, father, mother, son, or daughter, including contractual employment services in the previous 2 years.

Yes \_\_\_ No \_\_\_

If your answer is yes, please answer each of the following questions.

- 1. Is your spouse or any minor children currently an officer or employee of the Capitol Development Board or the Illinois Toll Highway Authority? Yes \_\_\_ No \_\_\_
- 2. Is your spouse or any minor children currently appointed to or employed by any agency of the State of Illinois? If your spouse or minor children is/are currently appointed to or employed by any agency of the State of Illinois, and his/her annual salary exceeds \$90,420.00, (60 % of the Governor's salary as of 7/1/01) provide the name of your spouse and/or minor children, the name of the State agency for which he/she is employed and his/her annual salary. \_\_\_\_\_  
\_\_\_\_\_
- 3. If your spouse or any minor children is/are currently appointed to or employed by any agency of the State of Illinois, and his/her annual salary exceeds \$90,420.00, (60% of the salary of the Governor as of 7/1/01) are you entitled to receive (i) more then 71/2% of the total distributable income of your firm, partnership, association or corporation, or (ii) an amount in excess of the salary of the Governor? Yes \_\_\_ No \_\_\_
- 4. If your spouse or any minor children are currently appointed to or employed by any agency of the State of Illinois, and his/her annual salary exceeds \$90,420.00, (60% of the Governor's salary as of 7/1/01) are you and your spouse or minor children entitled to receive (i) more than 15 % in the aggregate of the total distributable income of your firm, partnership, association or corporation, or (ii) an amount in excess of 2 times the salary of the Governor? Yes \_\_\_ No \_\_\_

---

(c) Elective status; the holding of elective office of the State of Illinois, the government of the United States, any unit of local government authorized by the Constitution of the State of Illinois or the statutes of the State of Illinois currently or in the previous 3 years.

Yes \_\_\_ No \_\_\_

---

(d) Relationship to anyone holding elective office currently or in the previous 2 years; spouse, father, mother, son, or daughter.

Yes \_\_\_ No \_\_\_

---

(e) Appointive office; the holding of any appointive government office of the State of Illinois, the United States of America, or any unit of local government authorized by the Constitution of the State of Illinois or the statutes of the State of Illinois, which office entitles the holder to compensation in excess of the expenses incurred in the discharge of that office currently or in the previous 3 years.

Yes \_\_\_ No \_\_\_

---

(f) Relationship to anyone holding appointive office currently or in the previous 2 years; spouse, father, mother, son, or daughter.

Yes \_\_\_ No \_\_\_

---

(g) Employment, currently or in the previous 3 years, as or by any registered lobbyist of the State government.

Yes \_\_\_ No \_\_\_

---

**RETURN WITH BID/OFFER**

(h) Relationship to anyone who is or was a registered lobbyist in the previous 2 years; spouse, father, mother, son, or daughter. Yes \_\_\_ No \_\_\_

(i) Compensated employment, currently or in the previous 3 years, by any registered election or reelection committee registered with the Secretary of State or any county clerk of the State of Illinois, or any political action committee registered with either the Secretary of State or the Federal Board of Elections. Yes \_\_\_ No \_\_\_

(j) Relationship to anyone; spouse, father, mother, son, or daughter; who was a compensated employee in the last 2 years by any registered election or re-election committee registered with the Secretary of State or any county clerk of the State of Illinois, or any political action committee registered with either the Secretary of State or the Federal Board of Elections. Yes \_\_\_ No \_\_\_

**APPLICABLE STATEMENT**

**This Disclosure Form A is submitted on behalf of the INDIVIDUAL named on previous page.**

Completed by: \_\_\_\_\_  
Name of Authorized Representative (type or print)

Completed by: \_\_\_\_\_  
Title of Authorized Representative (type or print)

Completed by: \_\_\_\_\_ Date \_\_\_\_\_  
Signature of Individual or Authorized Representative

**NOT APPLICABLE STATEMENT**

**I have determined that no individuals associated with this organization meet the criteria that would require the completion of this Form A.**

**This Disclosure Form A is submitted on behalf of the CONTRACTOR listed on the previous page.**

\_\_\_\_\_  
Name of Authorized Representative (type or print)

\_\_\_\_\_  
Title of Authorized Representative (type or print)

\_\_\_\_\_  
Signature of Authorized Representative Date \_\_\_\_\_

RETURN WITH BID/OFFER

ILLINOIS DEPARTMENT  
OF TRANSPORTATION

Form B  
Other Contracts &  
Procurement Related Information  
Disclosure

Contractor Name		
Legal Address		
City, State, Zip		
Telephone Number	Email Address	Fax Number (if available)

Disclosure of the information contained in this Form is required by the Section 50-35 of the Illinois Procurement Act (30 ILCS 500). This information shall become part of the publicly available contract file. This Form B must be completed for bids in excess of \$10,000, and for all open-ended contracts.

**DISCLOSURE OF OTHER CONTRACTS AND PROCUREMENT RELATED INFORMATION**

**1. Identifying Other Contracts & Procurement Related Information.** The BIDDER shall identify whether it has any pending contracts (including leases), bids, proposals, or other ongoing procurement relationship with any other State of Illinois agency: Yes \_\_\_ No \_\_\_

If **“No” is checked**, the bidder only needs to complete the signature box on the bottom of this page.

**2. If “Yes” is checked.** Identify each such relationship by showing State of Illinois agency name and other descriptive information such as bid or project number (attach additional pages as necessary). SEE DISCLOSURE FORM INSTRUCTIONS:

**THE FOLLOWING STATEMENT MUST BE SIGNED**

_____	
Name of Authorized Representative (type or print)	
_____	
Title of Authorized Representative (type or print)	
_____	_____
Signature of Authorized Representative	Date

## **RETURN WITH BID**

### **SPECIAL NOTICE TO CONTRACTORS**

The following requirements of the Illinois Department of Human Rights' Rules and Regulations are applicable to bidders on all construction contracts advertised by the Illinois Department of Transportation:

#### **CONSTRUCTION EMPLOYEE UTILIZATION PROJECTION**

- (a) All bidders on construction contracts shall complete and submit, along with and as part of their bids, a Bidder's Employee Utilization Form (Form BC-1256) setting forth a projection and breakdown of the total workforce intended to be hired and/or allocated to such contract work by the bidder including a projection of minority and female employee utilization in all job classifications on the contract project.
- (b) The Department of Transportation shall review the Employee Utilization Form, and workforce projections contained therein, of the contract awardee to determine if such projections reflect an underutilization of minority persons and/or women in any job classification in accordance with the Equal Employment Opportunity Clause and Section 7.2 of the Illinois Department of Human Rights' Rules and Regulations for Public Contracts adopted as amended on September 17, 1980. If it is determined that the contract awardee's projections reflect an underutilization of minority persons and/or women in any job classification, it shall be advised in writing of the manner in which it is underutilizing and such awardee shall be considered to be in breach of the contract unless, prior to commencement of work on the contract project, it submits revised satisfactory projections or an acceptable written affirmative action plan to correct such underutilization including a specific timetable geared to the completion stages of the contract.
- (c) The Department of Transportation shall provide to the Department of Human Rights a copy of the contract awardee's Employee Utilization Form, a copy of any required written affirmative action plan, and any written correspondence related thereto. The Department of Human Rights may review and revise any action taken by the Department of Transportation with respect to these requirements.

RETURN WITH BID



**Contract No. 44952**  
**Various Counties**  
**Section INT ATTRACT SIGN 2007-19**  
**Various Routes**  
**District TR Construction Funds**

**PART I. IDENTIFICATION**

Dept. Human Rights # \_\_\_\_\_ Duration of Project: \_\_\_\_\_  
 Name of Bidder: \_\_\_\_\_

**PART II. WORKFORCE PROJECTION**

A. The undersigned bidder has analyzed minority group and female populations, unemployment rates and availability of workers for the location in which this contract work is to be performed, and for the locations from which the bidder recruits employees, and hereby submits the following workforce projection including a projection for minority and female employee utilization in all job categories in the workforce to be allocated to this contract:

TABLE A TOTAL Workforce Projection for Contract												TABLE B CURRENT EMPLOYEES TO BE ASSIGNED TO CONTRACT				
JOB CATEGORIES	TOTAL EMPLOYEES		MINORITY EMPLOYEES						TRAINEES				TOTAL EMPLOYEES		MINORITY EMPLOYEES	
			BLACK		HISPANIC		*OTHER MINOR.		APPRENTICES		ON THE JOB TRAINEES					
	M	F	M	F	M	F	M	F	M	F	M	F	M	F	M	F
OFFICIALS (MANAGERS)																
SUPERVISORS																
FOREMEN																
CLERICAL EQUIPMENT OPERATORS																
MECHANICS																
TRUCK DRIVERS																
IRONWORKERS																
CARPENTERS																
CEMENT MASONS																
ELECTRICIANS																
PIPEFITTERS, PLUMBERS																
PAINTERS																
LABORERS, SEMI-SKILLED																
LABORERS, UNSKILLED																
TOTAL																

TABLE C TOTAL Training Projection for Contract								
EMPLOYEES IN TRAINING	TOTAL EMPLOYEES		BLACK		HISPANIC		*OTHER MINOR.	
	M	F	M	F	M	F	M	F
APPRENTICES								
ON THE JOB TRAINEES								

FOR DEPARTMENT USE ONLY

\*Other minorities are defined as Asians (A) or Native Americans (N).  
 Please specify race of each employee shown in Other Minorities column.  
**Note: See instructions on the next page**

**RETURN WITH BID**

**Contract No. 44952  
Various Counties  
Section INT ATTRACT SIGN 2007-19  
Various Routes  
District TR Construction Funds**

**PART II. WORKFORCE PROJECTION - continued**

B. Included in "Total Employees" under Table A is the total number of **new hires** that would be employed in the event the undersigned bidder is awarded this contract.

The undersigned bidder projects that: (number) \_\_\_\_\_ new hires would be recruited from the area in which the contract project is located; and/or (number) \_\_\_\_\_ new hires would be recruited from the area in which the bidder's principal office or base of operation is located.

C. Included in "Total Employees" under Table A is a projection of numbers of persons to be employed directly by the undersigned bidder as well as a projection of numbers of persons to be employed by subcontractors.

The undersigned bidder estimates that (number) \_\_\_\_\_ persons will be directly employed by the prime contractor and that (number) \_\_\_\_\_ persons will be employed by subcontractors.

**PART III. AFFIRMATIVE ACTION PLAN**

A. The undersigned bidder understands and agrees that in the event the foregoing minority and female employee utilization projection included under **PART II** is determined to be an underutilization of minority persons or women in any job category, and in the event that the undersigned bidder is awarded this contract, he/she will, prior to commencement of work, develop and submit a written Affirmative Action Plan including a specific timetable (geared to the completion stages of the contract) whereby deficiencies in minority and/or female employee utilization are corrected. Such Affirmative Action Plan will be subject to approval by the contracting agency and the **Department of Human Rights**.

B. The undersigned bidder understands and agrees that the minority and female employee utilization projection submitted herein, and the goals and timetable included under an Affirmative Action Plan if required, are deemed to be part of the contract specifications.

Company \_\_\_\_\_ Telephone Number \_\_\_\_\_  
\_\_\_\_\_  
Address \_\_\_\_\_

**NOTICE REGARDING SIGNATURE**

The Bidder's signature on the Proposal Signature Sheet will constitute the signing of this form. The following signature block needs to be completed only if revisions are required.

Signature: \_\_\_\_\_ Title: \_\_\_\_\_ Date: \_\_\_\_\_

- Instructions: All tables must include subcontractor personnel in addition to prime contractor personnel.
- Table A - Include both the number of employees that would be hired to perform the contract work and the total number currently employed (Table B) that will be allocated to contract work, and include all apprentices and on-the-job trainees. The "Total Employees" column should include all employees including all minorities, apprentices and on-the-job trainees to be employed on the contract work.
- Table B - Include all employees currently employed that will be allocated to the contract work including any apprentices and on-the-job trainees currently employed.
- Table C - Indicate the racial breakdown of the total apprentices and on-the-job trainees shown in Table A.

**RETURN WITH BID**

**Contract No. 44952  
Various Counties  
Section INT ATTRACT SIGN 2007-19  
Various Routes  
District TR Construction Funds**

PROPOSAL SIGNATURE SHEET

The undersigned bidder hereby makes and submits this bid on the subject Proposal, thereby assuring the Department that all requirements of the Invitation for Bids and rules of the Department have been met, that there is no misunderstanding of the requirements of paragraph 3 of this Proposal, and that the contract will be executed in accordance with the rules of the Department if an award is made on this bid.

Firm Name \_\_\_\_\_  
(IF AN INDIVIDUAL) Signature of Owner \_\_\_\_\_  
Business Address \_\_\_\_\_  
\_\_\_\_\_

\_\_\_\_\_  
Firm Name \_\_\_\_\_  
By \_\_\_\_\_  
(IF A CO-PARTNERSHIP) Business Address \_\_\_\_\_  
\_\_\_\_\_  
Name and Address of All Members of the Firm:  
\_\_\_\_\_  
\_\_\_\_\_

\_\_\_\_\_  
Corporate Name \_\_\_\_\_  
By \_\_\_\_\_  
Signature of Authorized Representative  
\_\_\_\_\_  
Typed or printed name and title of Authorized Representative  
(IF A CORPORATION) Attest \_\_\_\_\_  
Signature  
(IF A JOINT VENTURE, USE THIS SECTION  
FOR THE MANAGING PARTY AND THE  
SECOND PARTY SHOULD SIGN BELOW) Business Address \_\_\_\_\_  
\_\_\_\_\_

\_\_\_\_\_  
Corporate Name \_\_\_\_\_  
By \_\_\_\_\_  
Signature of Authorized Representative  
\_\_\_\_\_  
Typed or printed name and title of Authorized Representative  
(IF A JOINT VENTURE) Attest \_\_\_\_\_  
Signature  
Business Address \_\_\_\_\_  
\_\_\_\_\_

If more than two parties are in the joint venture, please attach an additional signature sheet.





RETURN WITH BID

Division of Highways
Proposal Bid Bond
(Effective November 1, 1992)

Item No.
Letting Date

KNOW ALL MEN BY THESE PRESENTS, That We
as PRINCIPAL, and

held jointly, severally and firmly bound unto the STATE OF ILLINOIS in the penal sum of 5 percent of the total bid price, or for the amount specified in Article 102.09 of the "Standard Specifications for Road and Bridge Construction" in effect on the date of invitation for bids, whichever is the lesser sum, well and truly to be paid unto said STATE OF ILLINOIS, for the payment of which we bind ourselves, our heirs, executors, administrators, successors and assigns.

THE CONDITION OF THE FOREGOING OBLIGATION IS SUCH, That Whereas, the PRINCIPAL has submitted a bid proposal to the STATE OF ILLINOIS, acting through the Department of Transportation, for the improvement designated by the Transportation Bulletin Item Number and Letting Date indicated above.

NOW, THEREFORE, if the Department shall accept the bid proposal of the PRINCIPAL; and if the PRINCIPAL shall, within the time and as specified in the bidding and contract documents, submit a DBE Utilization Plan that is accepted and approved by the Department; and if, after award by the Department, the PRINCIPAL shall enter into a contract in accordance with the terms of the bidding and contract documents including evidence of the required insurance coverages and providing such bond as specified with good and sufficient surety for the faithful performance of such contract and for the prompt payment of labor and material furnished in the prosecution thereof; or if, in the event of the failure of the PRINCIPAL to make the required DBE submission or to enter into such contract and to give the specified bond, the PRINCIPAL pays to the Department the difference not to exceed the penalty hereof between the amount specified in the bid proposal and such larger amount for which the Department may contract with another party to perform the work covered by said bid proposal, then this obligation shall be null and void, otherwise, it shall remain in full force and effect.

IN THE EVENT the Department determines the PRINCIPAL has failed to comply with any requirement as set forth in the preceding paragraph, then Surety shall pay the penal sum to the Department within fifteen (15) days of written demand therefor. If Surety does not make full payment within such period of time, the Department may bring an action to collect the amount owed. Surety is liable to the Department for all its expenses, including attorney's fees, incurred in any litigation in which it prevails either in whole or in part.

In TESTIMONY WHEREOF, the said PRINCIPAL and the said SURETY have caused this instrument to be signed by their respective officers this day of A.D.,

PRINCIPAL SURETY
(Company Name) (Company Name)
By: (Signature & Title) By: (Signature of Attorney-in-Fact)

Notary Certification for Principal and Surety

STATE OF ILLINOIS,
COUNTY OF

I, a Notary Public in and for said County, do hereby certify that
and

(Insert names of individuals signing on behalf of PRINCIPAL & SURETY)

who are each personally known to me to be the same persons whose names are subscribed to the foregoing instrument on behalf of PRINCIPAL and SURETY, appeared before me this day in person and acknowledged respectively, that they signed and delivered said instrument as their free and voluntary act for the uses and purposes therein set forth.

Given under my hand and notarial seal this day of, A.D.

My commission expires
Notary Public

In lieu of completing the above section of the Proposal Bid Form, the Principal may file an Electronic Bid Bond. By signing below the Principal is ensuring the identified electronic bid bond has been executed and the Principal and Surety are firmly bound unto the State of Illinois under the conditions of the bid bond as shown above.

Electronic Bid Bond ID# Company/Bidder Name Signature and Title

# PROPOSAL ENVELOPE



## PROPOSALS

for construction work advertised for bids by the  
Illinois Department of Transportation

Item No.	Item No.	Item No.

Submitted By:

Name:
Address:
Phone No.

Bidders should use an IDOT proposal envelope or affix this form to the front of a 10" x 13" envelope for the submittal of bids. If proposals are mailed, they should be enclosed in a second or outer envelope addressed to:

Engineer of Design and Environment - Room 326  
Illinois Department of Transportation  
2300 South Dirksen Parkway  
Springfield, Illinois 62764

### **NOTICE**

**Individual bids, including Bid Bond and/or supplemental information if required, should be securely stapled.**

# CONTRACTOR OFFICE COPY OF CONTRACT SPECIFICATIONS

---

## NOTICE

None of the following material needs to be returned with the bid package unless the special provisions require documentation and/or other information to be submitted.

**Contract No. 44952**  
**Various Counties**  
**Section INT ATTRACT SIGN 2007-19**  
**Various Routes**  
**District TR Construction Funds**



**Illinois Department of Transportation**



## NOTICE TO BIDDERS

**1. TIME AND PLACE OF OPENING BIDS.** Sealed proposals for the improvement described herein will be received by the Department of Transportation at the Harry R. Hanley Building, 2300 South Dirksen Parkway, in Springfield, Illinois until 10:00 o'clock a.m., April 27, 2007. All bids will be gathered, sorted, publicly opened and read in the auditorium at the Department of Transportation's Harry R. Hanley Building shortly after the 10:00 a.m. cut off time.

**2. DESCRIPTION OF WORK.** The proposed improvement is identified and advertised for bids in the Invitation for Bids as:

**Contract No. 44952  
Various Counties  
Section INT ATTRACT SIGN 2007-19  
Various Routes  
District TR Construction Funds**

**Install or replace tourist attraction signs and supports at various locations in the state.**

**3. INSTRUCTIONS TO BIDDERS.** (a) This Notice, the invitation for bids, proposal and letter of award shall, together with all other documents in accordance with Article 101.09 of the Standard Specifications for Road and Bridge Construction, become part of the contract. Bidders are cautioned to read and examine carefully all documents, to make all required inspections, and to inquire or seek explanation of the same prior to submission of a bid.

(b) State law, and, if the work is to be paid wholly or in part with Federal-aid funds, Federal law requires the bidder to make various certifications as a part of the proposal and contract. By execution and submission of the proposal, the bidder makes the certification contained therein. A false or fraudulent certification shall, in addition to all other remedies provided by law, be a breach of contract and may result in termination of the contract.

**4. AWARD CRITERIA AND REJECTION OF BIDS.** This contract will be awarded to the lowest responsive and responsible bidder considering conformity with the terms and conditions established by the Department in the rules, Invitation for Bids and contract documents. The issuance of plans and proposal forms for bidding based upon a prequalification rating shall not be the sole determinant of responsibility. The Department reserves the right to determine responsibility at the time of award, to reject any or all proposals, to readvertise the proposed improvement, and to waive technicalities.

By Order of the  
Illinois Department of Transportation

Milton R. Sees, Acting Secretary

BD 351 (Rev. 01/2003)

INDEX  
FOR  
SUPPLEMENTAL SPECIFICATIONS  
AND RECURRING SPECIAL PROVISIONS

Adopted January 1, 2007

This index contains a listing of SUPPLEMENTAL SPECIFICATIONS, frequently used RECURRING SPECIAL PROVISIONS, and LOCAL ROADS AND STREETS RECURRING SPECIAL PROVISIONS.

No ERRATA this year.

SUPPLEMENTAL SPECIFICATIONS

Std. Spec. Sec.

No Supplemental Specifications this year.

Page No.

RECURRING SPECIAL PROVISIONS

The following RECURRING SPECIAL PROVISIONS indicated by an "X" are applicable to this contract and are included by reference:

<u>CHECK SHEET #</u>	<u>PAGE NO.</u>
1 Additional State Requirements For Federal-aid Construction Contracts (Eff. 2-1-69) (Rev. 1-1-07).....	1
2 Subletting of Contracts (Federal-aid Contracts) (Eff. 1-1-88) (Rev. 5-1-93).....	3
3 X EEO (Eff. 7-21-78) (Rev. 11-18-80).....	4
4 X Specific Equal Employment Opportunity Responsibilities NonFederal-aid Contracts (Eff. 3-20-69) (Rev. 1-1-94).....	14
5 X Required Provisions - State Contracts (Eff. 4-1-65) (Rev. 1-1-07).....	19
6 Reserved.....	24
7 National Pollutant Discharge Elimination System Permit (Eff. 7-1-94) (Rev. 1-1-03).....	25
8 Haul Road Stream Crossings, Other Temporary Stream Crossings and In-Stream Work Pads (Eff. 1-2-92) (Rev. 1-1-98).....	26
9 Construction Layout Stakes Except for Bridges (Eff. 1-1-99) (Rev. 1-1-07).....	27
10 Construction Layout Stakes (Eff. 5-1-93) (Rev. 1-1-07).....	30
11 Use of Geotextile Fabric for Railroad Crossing (Eff. 1-1-95) (Rev. 1-1-07).....	33
12 Subsealing of Concrete Pavements (Eff. 11-1-84) (Rev. 1-1-07).....	35
13 Hot-Mix Asphalt Surface Removal (Cold Milling) (Eff. 11-1-87) (Rev. 1-1-07).....	39
14 Pavement and Shoulder Resurfacing (Eff. 2-1-00) (Rev. 1-1-07).....	41
15 PCC Partial Depth Hot-Mix Asphalt Patching (Eff. 1-1-98) (Rev. 1-1-07).....	42
16 Patching with Hot-Mix Asphalt Overlay Removal (Eff. 10-1-95) (Rev. 1-1-07).....	44
17 Polymer Concrete (Eff. 8-1-95) (Rev. 3-1-05).....	45
18 PVC Pipeliner (Eff. 4-1-04) (Rev. 1-1-07).....	47
19 Pipe Underdrains (Eff. 9-9-87) (Rev. 1-1-07).....	48
20 Guardrail and Barrier Wall Delineation (Eff. 12-15-93) (Rev. 1-1-97).....	49
21 Bicycle Racks (Eff. 4-1-94) (Rev. 1-1-07).....	53
22 Temporary Modular Glare Screen System (Eff. 1-1-00) (Rev. 1-1-07).....	55
23 Temporary Portable Bridge Traffic Signals (Eff. 8-1-03) (Rev. 1-1-07).....	57
24 Work Zone Public Information Signs (Eff. 9-1-02) (Rev. 1-1-07).....	59
25 Night Time Inspection of Roadway Lighting (Eff. 5-1-96).....	60
26 English Substitution of Metric Bolts (Eff. 7-1-96).....	61
27 English Substitution of Metric Reinforcement Bars (Eff. 4-1-96) (Rev. 1-1-03).....	62
28 Calcium Chloride Accelerator for Portland Cement Concrete (Eff. 1-1-01).....	63
29 Quality Control of Concrete Mixtures at the Plant-Single A (Eff. 8-1-00) (Rev. 1-1-04).....	64
30 Quality Control of Concrete Mixtures at the Plant-Double A (Eff. 8-1-00) (Rev. 1-1-04).....	70
31 Quality Control/Quality Assurance of Concrete Mixtures (Eff. 4-1-92) (Rev. 1-1-07).....	78

**TABLE OF CONTENTS**

LOCATION OF IMPROVEMENT ..... 1  
DURATION OF CONTRACT ..... 1  
DESCRIPTION OF IMPROVEMENTS ..... 1  
WORK ORDERS..... 1  
FAILURE TO COMPLETE A WORK ORDER ON TIME ..... 2  
QUANTITIES..... 2  
EXTRA WORK ..... 2  
REIMBURSEMENT FROM THIRD PARTY FOR REPAIRS OR DAMAGES..... 3  
LOCATING UNDERGROUND CABLE ..... 3  
CONTRACTOR'S RESPONSIBILITY FOR DAMAGE ..... 3  
FINAL CLEANING UP..... 3  
TRAFFIC CONTROL AND PROTECTION ..... 3  
ARROW BOARDS ..... 4  
FURNISH AND ERECT SIGN PANEL..... 4  
INSTALL SERVICE SIGN OR MILEAGE PLATE ..... 5  
REMOVE SERVICE SIGN OR MILEAGE PLATE ..... 6  
TRANSFER SERVICE SIGNS..... 6  
REMOVE AND REINSTALL SIGN PANEL..... 6  
REMOVE EXISTING SIGN PANEL ..... 7  
REMOVE EXISTING SIGN COMPLETE ..... 7  
STRUCTURAL STEEL SIGN SUPPORT – BREAKAWAY ..... 7  
REMOVE EXISTING SIGN SUPPORT ..... 8  
CONCRETE FOUNDATIONS FOR SIGN SUPPORTS ..... 8  
REMOVE CONCRETE FOUNDATIONS ..... 8  
CEMENT (BDE) ..... 9  
ERRATA FOR THE 2007 STANDARD SPECIFICATIONS (BDE)..... 11  
PAYMENTS TO SUBCONTRACTORS (BDE) ..... 13  
REFLECTIVE SHEETING ON CHANNELIZING DEVICES (BDE) ..... 14  
RETROREFLECTIVE SHEETING, NONREFLECTIVE SHEETING, AND TRANSLUCENT OVERLAY  
FILM FOR HIGHWAY SIGNS (BDE)..... 15  
SUBCONTRACTOR MOBILIZATION PAYMENTS (BDE)..... 20  
TYPE ZZ RETROREFLECTIVE SHEETING, NONREFLECTIVE SHEETING, AND TRANSLUCENT  
OVERLAY FILM FOR HIGHWAY SIGNS (BDE)..... 21

## **SPECIAL PROVISIONS**

### **STATE OF ILLINOIS**

The following Special Provisions supplement the “Standard Specifications for Road and Bridge Construction, Adopted January 1, 2007”, the latest edition of the “Manual on Uniform Traffic Control Devices for Streets and Highways”, and the “Manual of Test Procedures for Materials” in effect on the date of invitation for bids, and the “Supplemental Specifications and Recurring Special Provisions” indicated on the Check Sheet included herein, which apply to and govern the construction of the Interstate Attraction Signing 2007-19 Contract and in case of conflict with any part, or parts, of said Specifications, the said Special Provisions shall take precedence and shall govern.

### **LOCATION OF IMPROVEMENT**

The work to be done under this contract will be on interstate routes throughout the State, although work may be required to be done on other State-maintained highways at various locations.

### **DURATION OF CONTRACT**

This contract shall become effective **May 1, 2007** or following the execution and acceptance of the contract, whichever is later, and will continue in effect until **December 31, 2008**.

### **DESCRIPTION OF IMPROVEMENTS**

The work shall consist of installing or replacing tourist attraction or business logo signs and supports at locations described in a work order.

### **WORK ORDERS**

No work of any kind is to be performed by the Contractor, unless a work order authorizing work has been issued by the Engineer of Traffic Operations. A work order will show the date of issue, job number, location, code number(s), pay item(s), quantity of such pay item, and total cost. A work order will normally indicate the amount of work required to complete the attraction signing required for an interstate interchange. Only the amount of work shown on the work order is to be done by the Contractor. **The Contractor shall notify the District Contact at least 72 hours before beginning any work in the field and shall obtain permission to begin such work.**

Some work orders may require that the Contractor complete the work outlined in the work order during a district’s night-time hours.



The Contractor shall complete all the work required on a work order within **90 calendar days** after the date of issue of the work order or its revision unless otherwise extended in the work order or agreed in writing between the Contractor and the Engineer.

A calendar day shall be defined as any day on the calendar. No calendar days shall be charged under the following conditions:

- (a) When adverse weather at the field work site prevents work on the controlling item of a work order.
- (b) When job conditions at the field work site due to recent weather conditions prevent work on the controlling item of a work order.
- (c) When work has been suspended by an act or omission of the Department or the Engineer.

Each individual work order shall be completed within the time noted above. Extension of time for individual work orders will conform to Article 108.08(b) with the "Completion Date" figured on a work order by work order basis.

#### **FAILURE TO COMPLETE A WORK ORDER ON TIME**

Should the Contractor fail to complete a work order on time, or such extended time as may have been allowed, the Contractor shall be liable to the Department, not as a penalty, but as liquidated damages, in the amount of **\$75.00 per calendar day** of overrun per work order, rather than the amount indicated in Article 108.09, of the "Standard Specifications for Road and Bridge Construction.

#### **QUANTITIES**

The quantities specified in this contract indicate the estimated amount of work required for the duration of the contract. This is merely an estimate to allow Contractors to establish unit prices and permit the Department to determine the low bidder. It shall be understood that the unit prices of this contract shall prevail throughout the period of this contract regardless of the quantity.

#### **EXTRA WORK**

The Engineer may authorize the Contractor to perform extra work as provided for by Article 104.02. However, the Department reserves the right to advertise for competitive bids to effect revisions of existing facilities or other extra work. Completion time of extra work shall conform to the Engineer's requirements. Extra work shall be paid for in accordance with Article 109.04.

## **REIMBURSEMENT FROM THIRD PARTY FOR REPAIRS OR DAMAGES**

The Department reserves the right to make recovery from Third Party or Parties for damage to any part of the existing installations and no part of such recovery or recoveries shall inure to the benefit of the Contractor.

To enable the Department to assess damages against said Third Party or Parties, the Contractor shall, upon request, furnish the Engineer an itemized statement of the cost of any repairs to Third Party damage, separating the cost of labor, materials, and equipment.

## **LOCATING UNDERGROUND CABLE**

At those locations, where concrete foundations are to be installed, **the Contractor shall notify the District Contact at least 72 hours before beginning any work in the field. The Contractor shall request that the Department locate and mark all underground electric cable owned and maintained by the Department which may be in conflict with the construction operations.** In the event the Contractor fails to notify the District Contact and cable is damaged, the Contractor shall replace the entire length of cable or conductors in conduit, in a manner satisfactory to the District Contact, at his/her own expense. Splicing below grade will not be permitted.

## **CONTRACTOR'S RESPONSIBILITY FOR DAMAGE**

The Contractor shall be held responsible for damages resulting from the operations of his equipment or employees and of any damage to a sign or sign structure prior to final inspection by the District Contact. The Contractor shall, at his own expense, restore any damaged property to a condition equal to that existing before damage was done, by repairing, rebuilding, or replacing it as directed by the Engineer.

## **FINAL CLEANING UP**

The final cleaning up shall conform to the requirements set forth in Article 104.06. Each time the Contractor accomplishes work at any location, he will be required to clean up the work area before payment for that work will be submitted.

All costs due to compliance with this Special Provision will be incidental to the contract and no additional compensation will be allowed.

## **TRAFFIC CONTROL AND PROTECTION**

The Contractor shall arrange his work in such a manner so as to keep interruptions to traffic flow at a minimum.

Traffic control and protection shall conform to Article 107.09 and Section 701 and to the following standards as required by the Engineer.

Standards 702001, 701006, 701101, 701106, 701201, 701301, 701400, 701401, 701406, 701411

Conformance to the traffic control and protection standards will not be paid for as a separate item, but will be considered incidental to the various contract items and no additional compensation will be allowed.

## **ARROW BOARDS**

A flashing arrow board meeting the requirements of the Standard Specifications shall be operating at all times when a lane is closed to traffic on a multilane highway. Arrow boards shall be provided and located in a head-on position within each lane closure taper. The cost of furnishing and operating arrow boards will be considered incidental to the contract.

## **FURNISH AND ERECT SIGN PANEL**

This work shall consist of furnishing and erecting extruded sign panels, complete with reflectorized sign face, legend, and supplemental panels or plates, on existing sign supports for tourist attraction signing along the Interstate. Typical layouts and sign designs are shown in the plans. Specific details and locations will be described in the work order(s).

The aluminum extrusions and the installation shall be in accordance to the requirements of Section 1090 of the Standard Specification, as shown on the plans and/or as directed by the Engineer.

All sign sheeting used on this contract shall be in accordance with the BDE Special Provisions for "Type ZZ Retroreflective Sheeting, Nonreflective Sheeting, and Translucent Overlay Film for Highway Signs" and "Retroreflective Sheeting, Nonreflective Sheeting, and Translucent Overlay Film for Highway Signs".

All Type III reflectorized signs, supplemental signs and supplemental panels shall be fabricated using faces and legend of Type ZZ retroreflective sheeting. This shall include mainline and ramp signs. All remaining signing shall be fabricated using a background material of Type AP retroreflective sheeting. All signs shall be fabricated such that the copy or text and background material is applied in the preferred orientation for the maximum retroreflectivity per the manufacturer's recommendation.

No nesting of legend copy will be permitted. Background sheeting and legend shall be provided by the same manufacturer.

**This specification shall apply to all colors of sheeting used in this contract except for blue and brown. Signs fabricated with blue and brown sheeting shall use Type AP sheeting for the background material with the border and legend material of Type ZZ reflective sheeting.**

No mounting on bridges or overhead sign structures will be required for this pay item. **The supplemental business panels and mileage plates will be furnished by others and made available to the Contractor at the appropriate District Sign Shop or at a location agreed upon by the Contractor and Engineer.** The supplemental panels and plates will be riveted onto the main sign panel as shown in the work order(s). In addition to the holes in the sign panel, necessary to install the supplemental panels and plates, the Contractor shall also drill the upper left hole for all other possible supplemental business panels. (This is to facilitate spacing of future business panels).

The attraction sign designs will be similar in design to the sample logo signs included in the plans. This work will also include the design and fabrication of state park signs. Each individual work order will include the appropriate sign design for each location.

This work will be measured for payment in square feet from edge-to-edge (horizontally and vertically).

The Contractor shall package all signs so as to prevent damage during shipment.

This work will be paid, for at the contract unit price per square foot, for SIGN PANEL – TYPE 3. This price shall include, furnishing all materials, fabricating the sign panel (including sign face and sign legend), and furnishing all mounting hardware, installing all supplemental business panels and mileage plates and installing the sign panel on previously erected sign supports and removing any existing sign panel as required for the proper installation of the new panel. Removal of any existing sign panel(s) will be paid for in accordance with REMOVE EXISTING SIGN PANEL.

The steel supports and concrete foundations for sign panels will be paid for under STRUCTURAL STEEL SIGN SUPPORT-BREAKAWAY and CONCRETE FOUNDATIONS respectively.

### **INSTALL SERVICE SIGN OR MILEAGE PLATE**

This work shall consist of installing a service plate advertising gas, food, lodging camping or tourist attraction business service establishment or a mileage plate **on a previously erected business service panel.** The service plates are fabricated from flat sheet aluminum and will be furnished predrilled by the business establishments and made available to the Contractor at the District Sign Shop where work is being performed or at such other location agreed upon by the Engineer and the Contractor.

**Mileage plates are fabricated from flat sheet aluminum and will be furnished predrilled by the District Sign Shop and made available to the Contractor at the District Sign Shop where work is being performed or at such other location agreed upon by the Engineer and the Contractor.**

The plates shall be installed using 5 mm (3/16-inch) aluminum rivets with 3 mm (0.125 inch) to 6 mm (0.250 inch) grip range to fully penetrate the sign panel extrusions and firmly attach the plates. Any plate damaged by the Contractor shall be replaced in exact kind at no cost to the Department. The business logo panel shall not be removed when installing a service or mileage plate

This work will be paid for at the contract unit price each for INSTALL SERVICE OR MILEAGE PLATE, which price shall include payment in full for installing a service or mileage plate on a previously erected business logo panel.

#### **REMOVE SERVICE SIGN OR MILEAGE PLATE**

This work shall consist of removing an existing business service plate advertising a business establishment or a mileage plate from a previously erected business service panel.

Extreme care shall be taken not to damage or mar the plate in any way. Any plate damaged by the Contractor shall be replaced in exact kind at no cost to the Department. The plates shall be delivered to the District Sign Shop where work is being performed or at such other location agreed upon by the Engineer.

This work will be paid for at the contract unit price each for REMOVE SERVICE OR MILEAGE PLATE, which price shall include payment in full for removing a service or mileage plate from a previously erected business logo panel.

#### **TRANSFER SERVICE SIGNS**

This work shall consist of removing an existing business service sign advertising a business establishment from a previously erected business panel and reinstalling the business service sign on a newly erected business panel.

Extreme care shall be taken not to damage or mar the sign in any way. Any sign damaged by the Contractor shall be replaced in exact kind at no cost to the Department.

This work will be paid for at the contract unit price each for TRANSFER SERVICE SIGN, which price shall include payment in full for removing an existing service sign from a previously erected business logo panel and reinstalling the existing service sign on a newly erected business logo panel. **The cost of transferring existing mileage plates and directional arrows for the service signs shall be considered incidental to this pay item.**

#### **REMOVE AND REINSTALL SIGN PANEL**

This work shall consist of removing an existing sign panel from steel sign supports and reinstalling it on previously erected new sign supports.

The removal of steel sign supports will not be included under this pay item but will be paid for as REMOVE EXISTING SIGN SUPPORT.

The replacement of any damaged or missing mounting hardware shall meet the requirements of Article 1090.03.

This work will be paid for at the contract unit price per square foot for REMOVE AND REINSTALL SIGN PANEL. This price shall include removing the sign panel from existing steel supports, installing the sign panel on new supports, and replacing any damaged or missing hardware where applicable.

#### **REMOVE EXISTING SIGN PANEL**

This work shall consist of removing an existing ground-mounted sign. The sign panel shall be removed completely, including exit panel and all hardware, and transported from the right-of-way. The panel and hardware shall become the property of the State and shall be delivered to the District Sign Shop in the District in which the work is being performed.

This work will be paid for at the contract unit price each for REMOVE EXISTING SIGN PANEL, which price shall include complete removal of the sign, including exit panel, if any, from the right-of-way.

#### **REMOVE EXISTING SIGN COMPLETE**

This work shall consist of removing an existing ground-mounted sign and supports as shown in the work order. The removal items shall consist of the sign panel and exit panel, and the structural steel supports. The sign panel shall become the property of the State and shall be delivered to the District Sign Shop in the District in which the work is being performed. The supports, including hardware, shall become the property of the Contractor. The bid price shall reflect any salvage value for the supports and hardware.

Where the existing sign and supports are to be removed and be replaced by a new sign and new supports, the new sign shall be completely installed prior to the removal of the existing sign. However, duplicate signs are not to exist for periods in excess of 24 hours.

This work will be paid for at the contract unit price each for REMOVE EXISTING SIGN COMPLETE and shall be payment in full for all labor and equipment necessary to remove the sign and supports as herein specified and no additional compensation will be allowed.

The removal of any concrete foundations will be paid for as REMOVE CONCRETE FOUNDATION-GROUND MOUNT.

#### **STRUCTURAL STEEL SIGN SUPPORT – BREAKAWAY**

This work shall consist of furnishing galvanized structural steel breakaway sign supports for ground-mount signs and stub posts of the sizes and lengths as shown in the work order and attaching the support to the stub post previously cast within a concrete foundation.

This work shall be done in accordance with the requirements of Section 727.

This work will be paid for at the contract unit price per pound for STRUCTURAL STEEL SIGN SUPPORT – BREAKAWAY, which price shall include payment in full for furnishing and erecting the galvanized posts with all components as specified.

## **REMOVE EXISTING SIGN SUPPORT**

This work shall consist of removing an existing steel sign support. The support, including hardware, shall become the property of the Contractor, and the bid price shall reflect any salvage value.

This work will be paid for at the contract unit price each for REMOVE EXISTING SIGN SUPPORT, which price shall include complete removal of the sign support, including hardware, from the right-of-way.

The removal of any concrete foundations will be paid for as REMOVE CONCRETE FOUNDATION - GROUND MOUNT.

## **CONCRETE FOUNDATIONS FOR SIGN SUPPORTS**

This work shall consist of constructing Class SI concrete foundations for the installation of structural steel sign supports.

The concrete shall be obtained from a predetermined approved source. A list of approved suppliers may be obtained from each District.

Concrete foundations of the type and size as specified in the work order shall be constructed in accordance with the applicable requirements of Section 734. The top segment of the foundations shall be formed down to a depth of at least one (1) foot below the ground line. The top of the foundation shall be finished level, and all exposed surfaces shall be rubbed in accordance with Article 503.16.

The excavated material removed for installation of the foundations shall be disposed of outside the right-of-way at the Contractor's expense.

Concrete foundations will be measured for payment in accordance with the requirements of Article 503.21.

This work will be paid for at the contract unit price per cubic yard of CONCRETE FOUNDATIONS. This price shall be payment in full for all necessary excavating, back-filling, form-work, and furnishing and placing all materials, including the Class SI Concrete, reinforcing steel, anchor bolts, nuts, and washers complete in place.

## **REMOVE CONCRETE FOUNDATIONS**

This work shall consist of removing a concrete foundation for a ground-mounted sign support. All components of the concrete foundation, including the concrete, reinforcing, and stub post, shall be removed to at least one foot below the grade line.

The use of explosives of any kind will not be permitted in removing concrete foundations. The hole shall be back-filled with suitable material approved by the Engineer. The surface of the filled hole shall be treated to match the surrounding area.

All debris resulting from this operation shall be removed from the right-of-way at the Contractor's expense.

This work will be paid for at the contract unit price each for REMOVE CONCRETE FOUNDATION-GROUND MOUNT, which price shall be payment in full for all equipment and labor necessary to complete the work and backfill the hole as herein described.

## **CEMENT (BDE)**

Effective: January 1, 2007

Revise Section 1001 of the Standard Specifications to read:

### **“SECTION 1001. CEMENT**

**1001.01 Cement Types.** Cement shall be according to the following.

- (a) Portland Cement. Acceptance of portland cement shall be according to the current Bureau of Materials and Physical Research's Policy Memorandum, "Portland or Blended Cement Acceptance Procedure for Qualified and Non-Qualified Plants".

Portland cement shall be according to ASTM C 150, and shall meet the standard physical and chemical requirements. Type I or Type II may be used for cast-in-place, precast, and precast prestressed concrete. Type III may be used according to Article 1020.04, or when approved by the Engineer. All other cements referenced in ASTM C 150 may be used when approved by the Engineer.

The total of all organic processing additions shall be a maximum of 1.0 percent by weight (mass) of the cement and the total of all inorganic processing additions shall be a maximum of 4.0 percent by weight (mass) of the cement. Organic processing additions shall be limited to grinding aids that improve the flowability of cement, reduce pack set, and improve grinding efficiency. Inorganic processing additions shall be limited to granulated blast-furnace slag according to the chemical requirements of AASHTO M 302 and Class C fly ash according to the chemical requirements of AASHTO M 295.

- (b) Portland-Pozzolan Cement. Acceptance of portland-pozzolan cement shall be according to the current Bureau of Materials and Physical Research's Policy Memorandum, "Portland or Blended Cement Acceptance Procedure for Qualified and Non-Qualified Plants".

Portland-pozzolan cement shall be according to ASTM C 595 and shall meet the standard physical and chemical requirements. Type IP or I(PM) may be used for cast-in-place, precast, and precast prestressed concrete, except when Class PP concrete is used. The pozzolan constituent for Type IP shall be a maximum of 21 percent of the weight (mass) of the portland-pozzolan cement. All other cements referenced in ASTM C 595 may be used when approved by the Engineer.



For cast-in-place construction, portland-pozzolan cements shall only be used from April 1 to October 15.

The total of all organic processing additions shall be a maximum of 1.0 percent by weight (mass) of the cement. Organic processing additions shall be limited to grinding aids as defined in (a) above. Inorganic processing additions shall not be used.

- (c) Portland Blast-Furnace Slag Cement. Acceptance of portland blast-furnace slag cement shall be according to the current Bureau of Materials and Physical Research's Policy Memorandum, "Portland or Blended Cement Acceptance Procedure for Qualified and Non-Qualified Plants".

Portland blast-furnace slag cement shall be according to ASTM C 595 and shall meet the standard physical and chemical requirements. Type I(SM) slag-modified portland cement may be used for cast-in-place, precast, and precast prestressed concrete, except when Class PP concrete is used. All other cements referenced in ASTM C 595 may be used when approved by the Engineer.

For cast-in-place construction, portland blast-furnace slag cements shall only be used from April 1 to October 15.

The total of all organic processing additions shall be a maximum of 1.0 percent by weight (mass) of the cement. Organic processing additions shall be limited to grinding aids as defined in (a) above. Inorganic processing additions shall not be used.

- (d) Rapid Hardening Cement. Rapid hardening cement shall be used according to Article 1020.04 or when approved by the Engineer. The cement shall be on the Department's current "Approved List of Packaged, Dry, Rapid Hardening Cementitious Materials for Concrete Repairs", and shall be according to the following.

- (1) The cement shall have a maximum final set of 25 minutes, according to Illinois Modified ASTM C 191.
- (2) The cement shall have a minimum compressive strength of 2000 psi (13,800 kPa) at 3.0 hours, and 4000 psi (27,600 kPa) at 24.0 hours, according to Illinois Modified ASTM C 109.
- (3) The cement shall have a maximum drying shrinkage of 0.050 percent at seven days, according to Illinois Modified ASTM C 596.
- (4) The cement shall have a maximum expansion of 0.020 percent at 14 days, according to Illinois Modified ASTM C 1038.
- (5) The cement shall have a minimum 80 percent relative dynamic modulus of elasticity; and shall not have a weight (mass) gain in excess of 0.15 percent or a weight (mass) loss in excess of 1.0 percent, after 100 cycles, according to Illinois Modified AASHTO T 161, Procedure B. At 100 cycles, the specimens are measured and weighed at 73 °F (23 °C).

- (e) Calcium Aluminate Cement. Calcium aluminate cement shall be used when specified by the Engineer. The cement shall meet the standard physical requirements for Type I cement according to ASTM C 150, except the time of setting shall not apply. The chemical requirements shall be determined according to ASTM C 114 and shall be as follows: minimum 38 percent aluminum oxide ( $Al_2O_3$ ), maximum 42 percent calcium oxide (CaO), maximum 1 percent magnesium oxide (MgO), maximum 0.4 percent sulfur trioxide ( $SO_3$ ), maximum 1 percent loss on ignition, and maximum 3.5 percent insoluble residue.

**1001.02 Uniformity of Color.** Cement contained in single loads or in shipments of several loads to the same project shall not have visible differences in color.

**1001.03 Mixing Brands and Types.** Different brands or different types of cement from the same manufacturing plant, or the same brand or type from different plants shall not be mixed or used alternately in the same item of construction unless approved by the Engineer.

**1001.04 Storage.** Cement shall be stored and protected against damage, such as dampness which may cause partial set or hardened lumps. Different brands or different types of cement from the same manufacturing plant, or the same brand or type from different plants shall be kept separate.”

#### **ERRATA FOR THE 2007 STANDARD SPECIFICATIONS (BDE)**

Effective: January 1, 2007

Revised: April 1, 2007

- Page 60 Article 109.07(a). In the second line of the first paragraph change “amount” to “quantity”.
- Page 207 Article 406.14. In the second line of the second paragraph change “MIXTURE FOR CRACKS, JOINTS, AND FLANGEWAYS, of the mixture composition specified;” to “MIXTURE FOR CRACKS, JOINTS, AND FLANGEWAYS;”.
- Page 345 Article 505.08(l). In the third line of the first paragraph change “1/8 mm” to “1/8 in.”.
- Page 345 Article 505.08(l). In the nineteenth line of the first paragraph change “is” to “in”.
- Page 383 Article 516.04(b)(1). In the fifth line of the first paragraph change “drillingpouring” to “pouring”.
- Page 390 Article 520.02(h). Change “1027.021” to “1027.01”.
- Page 398 Article 540.07(b). Add the following two paragraphs after the third paragraph:  
“Excavation in rock will be measured for payment according to Article 502.12.

Removal and disposal of unstable and/or unsuitable material below plan bedding grade will be measured for payment according to Article 202.07.”

Page 398 Article 540.08. Add the following two paragraphs after the fifth paragraph:

“Excavation in rock will be paid for according to Article 502.13.

Removal and disposal of unstable and/or unsuitable material below plan bedding grade will be paid for according to Article 202.08.”

Page 435 Article 542.04(b). Delete the last sentence of the last paragraph.

Page 465 Article 551.06. In the second line of the first paragraph change “or” to “and/or”.

Page 585 Article 701.19(a). Add “701400” to the second line of the first paragraph.

Page 586 Article 701.19(c). Delete “701400” from the second line of the first paragraph.

Page 586 Article 701.19. Add the following subparagraph to this Article:

“(f) Removal of existing pavement markings and raised reflective pavement markers will be measured for payment according to Article 783.05.”

Page 587 Article 701.20(b). Delete “TRAFFIC CONTROL AND PROTECTION 701400;” from the first paragraph.

Page 588 Article 701.20. Add the following subparagraph to this Article.

“(j) Removal of existing pavement markings and raised reflective pavement markers will be paid for according to Article 783.06.”

Page 762 Article 1020.04. In Table 1 Classes of Portland Cement Concrete and Mix Design Criteria, add to the minimum cement factor for Class PC Concrete “5.65 (TY III)”, and add to the maximum cement factor for Class PC Concrete “7.05 (TY III)”.

Page 765 Article 1020.04. In Table 1 Classes of Portland Cement Concrete and Mix Design Criteria (metric), add to the minimum cement factor for Class PC Concrete “335 (TY III)”, and add to the maximum cement factor for Class PC Concrete “418 (TY III)”.

Page 800 Article 1030.05(a)(12). Revise “Dust Collection Factor” to “Dust Correction Factor”.

Page 800 Article 1030.05(a)(14). Revise the first occurrence of Article 1030.05(a)(14) to Article 1030.05(a)(13).

- Page 809 Article 1030.05. Revise the subparagraph “(a) Quality Assurance by the Engineer.” to read “(e) Quality Assurance by the Engineer.”.
- Page 946 Article 1080.03(a)(1). In the third line of the first paragraph revise “(300 µm)” to “(600 µm)”.
- Page 963 Article 1083.02(b). In the second line of the first paragraph revise “ASTM D 4894” to “ASTM D 4895”.
- Page 1076 In the Index of Pay Items delete the pay item “BITUMINOUS SURFACE REMOVAL – BUTT JOINT”.

### **PAYMENTS TO SUBCONTRACTORS (BDE)**

Effective: June 1, 2000

Revised: January 1, 2006

Federal regulations found at 49 CFR §26.29 mandate the Department to establish a contract clause to require Contractors to pay subcontractors for satisfactory performance of their subcontracts and to set the time for such payments.

State law also addresses the timing of payments to be made to subcontractors and material suppliers. Section 7 of the Prompt Payment Act, 30 ILCS 540/7, requires that when a Contractor receives any payment from the Department, the Contractor shall make corresponding, proportional payments to each subcontractor and material supplier performing work or supplying material within 15 calendar days after receipt of the Department payment. Section 7 of the Act further provides that interest in the amount of two percent per month, in addition to the payment due, shall be paid to any subcontractor or material supplier by the Contractor if the payment required by the Act is withheld or delayed without reasonable cause. The Act also provides that the time for payment required and the calculation of any interest due applies to transactions between subcontractors and lower-tier subcontractors and material suppliers throughout the contracting chain.

This Special Provision establishes the required federal contract clause, and adopts the 15 calendar day requirement of the State Prompt Payment Act for purposes of compliance with the federal regulation regarding payments to subcontractors. This contract is subject to the following payment obligations.

When progress payments are made to the Contractor according to Article 109.07 of the Standard Specifications, the Contractor shall make a corresponding payment to each subcontractor and material supplier in proportion to the work satisfactorily completed by each subcontractor and for the material supplied to perform any work of the contract. The proportionate amount of partial payment due to each subcontractor and material supplier throughout the contracting chain shall be determined by the quantities measured or otherwise determined as eligible for payment by the Department and included in the progress payment to the Contractor. Subcontractors and material suppliers shall be paid by the Contractor within 15 calendar days after the receipt of payment from the Department. The Contractor shall not hold retainage from the subcontractors. These obligations shall also apply to any payments made

by subcontractors and material suppliers to their subcontractors and material suppliers; and to all payments made to lower tier subcontractors and material suppliers throughout the contracting chain. Any payment or portion of a payment subject to this provision may only be withheld from the subcontractor or material supplier to whom it is due for reasonable cause.

This Special Provision does not create any rights in favor of any subcontractor or material supplier against the State or authorize any cause of action against the State on account of any payment, nonpayment, delayed payment, or interest claimed by application of the State Prompt Payment Act. The Department will not approve any delay or postponement of the 15 day requirement except for reasonable cause shown after notice and hearing pursuant to Section 7(b) of the State Prompt Payment Act. State law creates other and additional remedies available to any subcontractor or material supplier, regardless of tier, who has not been paid for work properly performed or material furnished. These remedies are a lien against public funds set forth in Section 23(c) of the Mechanics Lien Act, 770 ILCS 60/23(c), and a recovery on the Contractor's payment bond according to the Public Construction Bond Act, 30 ILCS 550.

**REFLECTIVE SHEETING ON CHANNELIZING DEVICES (BDE)**

Effective: April 1, 2007

Revise the seventh paragraph of Article 1106.02 of the Standard Specifications to read:

“At the time of manufacturing, the retroreflective prismatic sheeting used on channelizing devices shall meet or exceed the initial minimum coefficient of retroreflection as specified in the following table. Measurements shall be conducted according to ASTM E 810, without averaging. Sheeting used on cones, drums and flexible delineators shall be reboundable as tested according to ASTM D 4956. Prestriped sheeting for rigid substrates on barricades shall be white and orange.

Initial Minimum Coefficient of Retroreflection candelas/foot candle/sq ft (candelas/lux/sq m) of material				
Observation Angle (deg.)	Entrance Angle (deg.)	White	Orange	Fluorescent Orange
0.2	-4	365	160	150
0.2	+30	175	80	70
0.5	-4	245	100	95
0.5	+30	100	50	40”

Revise the first sentence of the first paragraph of Article 1106.02(c) of the Standard Specifications to read:

“Barricades and vertical panels shall have alternating white and orange stripes sloping downward at 45 degrees toward the side on which traffic will pass.”

Revise the third sentence of the first paragraph of Article 1106.02(d) of the Standard Specifications to read:

“The bottom panels shall be 8 x 24 in. (200 x 600 mm) with alternating white and orange stripes sloping downward at 45 degrees toward the side on which traffic will pass.”

## **RETROREFLECTIVE SHEETING, NONREFLECTIVE SHEETING, AND TRANSLUCENT OVERLAY FILM FOR HIGHWAY SIGNS (BDE)**

Effective: April 1, 2007

General. This special provision covers retroreflective sheeting and translucent overlay films intended for application on new or refurbished aluminum. The sheeting serves as the reflectorized background for sign messages and as cutout legends and symbols applied to the reflectorized background. Messages may be applied in opaque black or transparent colors.

This special provision also covers nonreflective sheeting for application on new or refurbished aluminum, and as material for cutout legends and symbols applied to the reflectorized background.

All material furnished under this specification shall have been manufactured within 18 months of the delivery date. All material shall be supplied by the same manufacturer.

Retroreflective Sheeting Properties. Retroreflective sheeting shall consist of a flexible, colored, prismatic, or glass lens elements adhered to a synthetic resin, encapsulated by a flexible, transparent plastic having a smooth outer surface and shall meet the following requirements.

Only suppliers whose products have been tested and approved in the Department's periodic Sheeting Study will be eligible to supply material. All individual batches and or lots of material shall be tested and approved by the Department. The Department reserves the right to sample and test delivered materials according to Federal Specification LS-300.

- (a) Adhesive. The sheeting shall have a Class 1, pre-coated, pressure sensitive adhesive according to ASTM D 4956. The adhesive shall have a protective liner that is easily removed when tested according to ASTM D 4956. The adhesive shall be capable of being applied to new or refurbished aluminum and reflectorized backgrounds without additional adhesive.
- (b) Color. The sheeting shall be uniform in color and devoid of streaks throughout the length of each roll. The color shall conform to the latest appropriate standard color tolerance chart issued by the U.S. Department of Transportation, Federal Highway Administration and to the daytime and nighttime color requirements of ASTM D 4956. Sheeting used for side by side overlay applications shall have a Hunter Lab Delta E of less than 3.
- (c) Coefficient of Retroreflection. When tested according to ASTM E 810, without averaging, the sheeting shall have a minimum coefficient of retroreflection as shown in the following tables. The brightness of the sheeting when totally wet shall be a minimum of 90 percent of the values shown when tested according to the standard rainfall test specified in Section 7.10.1 of AASHTO M 268-84.

Type A Sheeting  
 Minimum Coefficient of Retroreflection  
 candelas/foot candle/sq ft (candelas/lux/sq m) of material

Type A

Observation Angle (deg.)	Entrance Angle (deg.)	White	Yellow	Orange	Red	Green	Blue	Brown
0.2	-4	250	170	100	45	45	20	12
0.2	+30	150	100	60	25	25	12	8.5
0.5	-4	95	65	30	15	15	8	5
0.5	+30	75	50	25	10	10	5	3.5

Type AA Sheeting  
 Minimum Coefficient of Retroreflection  
 candelas/foot candle/sq ft (candelas/lux/sq m) of material

Type AA (0 and 90 degree rotation)

Observation Angle (deg.)	Entrance Angle (deg.)	White	Yellow	Red	Green	Blue	FO
0.2	-4	800	660	215	80	43	200
0.2	+30	400	340	100	35	20	120
0.5	-4	200	160	45	20	9.8	80
0.5	+30	100	85	26	10	5.0	50

Type AA (45 degree rotation)

Observation Angle (deg.)	Entrance Angle (deg.)	Yellow	FO
0.2	-4	550	165
0.2	+30	130	45
0.5	-4	145	70
0.5	+30	70	40

Type AP Sheeting  
 Minimum Coefficient of Retroreflection  
 candelas/foot candle/sq ft (candelas/lux/sq m) of material

Type AP

Observation Angle (deg.)	Entrance Angle (deg.)	White	Yellow	Red	Green	Blue	Brown	FO
0.2	-4	550	425	100	75	50	30	275
0.2	+30	200	150	40	35	25	15	90
0.5	-4	300	250	60	35	25	20	150
0.5	+30	100	70	20	20	10	5	50

Type AZ Sheeting  
Minimum Coefficient of Retroreflection  
candelas/foot candle/sq ft (candelas/lux/sq m) of material

Type AZ (0 degree rotation)

Observation Angle (deg.)	Entrance Angle (deg.)	White	Yellow	Red	Green	Blue	FYG	FY
0.2	-4	430	350	110	45	20	325	240
0.2	+30	235	140	60	24	11	200	150
0.5	-4	250	200	60	25	10	235	165
0.5	+30	170	135	40	19	7	105	75
1.0	-4	70	45	10	10	4	70	30
1.0	+30	30	20	7	5	2.5	45	15

Type AZ (90 degree rotation)

Observation Angle (deg.)	Entrance Angle (deg.)	White	Yellow	Red	Green	Blue	FYG	FY
0.2	-4	320	250	100	45	20	300	220
0.2	+30	235	140	40	24	11	200	150
0.5	-4	240	200	60	25	10	235	165
0.5	+30	100	85	20	10	7	80	75
1.0	-4	30	30	7	5	4	65	20
1.0	+30	15	15	5	2	2	30	10

(d) Gloss. The sheeting surface shall exhibit a minimum 85 degree gloss-meter rating of 50 when tested according to ASTM D 523.

(e) Durability. When processed and applied, the sheeting shall be weather resistant.

Accelerated weathering testing will be performed for 1000 hours (300 hours for orange/FO) according to ASTM G 151. The testing cycle will consist of 8 hours of light at 140 °F (60 °C), followed by 4 hours of condensation at 104 °F (40 °C). Following accelerated weathering, the sheeting shall exhibit a minimum of 80 percent of its initial minimum coefficient of retroreflection as listed in the previous tables.

Outdoor weathering will entail an annual evaluation of material placed in an outdoor rack with a 45 degree angle and a southern sun exposure. The sheeting will be evaluated for five years. Following weathering, the test specimens will be cleaned by immersing them in a five percent hydrochloric acid solution for 45 seconds, then rinsed with water and blotted dry with a soft clean cloth. Following cleaning, the applied sheeting shall show no appreciable discoloration, cracking, streaking, crazing, blistering, or dimensional change. The sheeting shall exhibit a Hunter Lab Delta E of 5 or less when compared to the original.

(f) Shrinkage. When tested according to ASTM D 4956, the sheeting shall not shrink in any dimension more than 1/32 in. (0.8 mm) in ten minutes and not more than 1/8 in. (3 mm) in 24 hours.



- (g) Workability. The sheeting shall show no cracking, scaling, pitting, blistering, edge lifting, inter-film splitting, curling, or discoloration when processed and applied using mutually acceptable processing and application procedures.
- (h) Splices. A single roll of sheeting shall contain a maximum of four splices per 50 yd (45 m) length. The sheeting shall be overlapped a minimum of 3/16 in. (5 mm) at each splice.
- (i) Adhesive Bond. The sheeting shall form a durable bond to smooth, corrosion and weather-resistant surfaces and adhere securely when tested according to ASTM D 4956.
- (j) Positionability. Sheeting, with ASTM D 4956 Class 3 adhesive, used for manufacturing cutout legends and borders shall provide sufficient positionability during the fabrication process to permit removal and reapplication without damage to either the legend or sign background and shall have a plastic liner suitable for use on bed cutting machines. Thereafter, all other adhesive and bond requirements contained in the specification shall apply.

Positionability shall be verified by cutting 4 in. (100 mm) letters E, I, K, M, S, W, and Y out of the positionable material. The letters shall then be applied to a sheeted aluminum blank using a single pass of a two pound roller. The letters shall sit for five minutes and then a putty knife shall be used to lift a corner. The thumb and fore finger shall be used to slowly pull the lifted corner to lift letters away from the sheeted aluminum. The letters shall not tear or distort when removed.

- (k) Thickness. The thickness of the sheeting without the protective liner shall be less than or equal to 0.015 in. (0.4 mm), or 0.025 in. (0.6 mm) for prismatic material.
- (l) Processing. The sheeting shall permit cutting and color processing according to the sheeting manufacturer's specifications at temperatures of 60 to 100 °F (15 to 38 °C) and within a relative humidity range of 20 to 80 percent. The sheeting shall be heat resistant and permit forced curing without staining the applied or unapplied sheeting at temperatures recommended by the manufacturer. The sheeting shall be solvent resistant and capable of being cleaned with VM&P naphtha, mineral spirits, and turpentine.

Transparent color and opaque black inks shall be single component and low odor. The inks shall dry within eight hours and not require clear coating. After color processing on white sheeting, the sheeting shall show no appreciable discoloration, cracking, streaking, crazing, blistering, or dimensional change when tested for durability (e). The ink on the weathered, prepared panel shall exhibit a Hunter Lab Delta E of 5 or less when compared to the original.

Transparent color electronic cutting films shall be acrylic. After application to white sheeting, the films shall show no appreciable discoloration, cracking, streaking, crazing, blistering, or dimensional change when tested for durability (e). The films on the weathered, prepared panel shall exhibit a Hunter Lab Delta E of 5 or less when compared to the original.

Transparent colors screened, or transparent acrylic electronic cutting films, on white sheeting, shall have a minimum initial coefficient of retroreflection values of 50 percent for yellow and red, and a minimum 70 percent for green, blue, and brown of the 0.2 degree observation angle/-4.0 degree entrance angle values as listed in the previous tables for the color being applied. After durability testing, the colors shall retain a minimum 80 percent of the initial coefficient of retroreflection.

- (m) Identification. The sheeting shall have a distinctive overall pattern in the sheeting unique to the manufacturer. If material orientation is required for optimum retroreflectivity, permanent orientation marks shall be incorporated into the face of the sheeting. Neither the overall pattern nor the orientation marks shall interfere with the reflectivity of the sheeting.
- (n) Packaging. Both ends of each box shall be clearly labeled with the sheeting type, color, adhesive type, manufacturer's lot number, date of manufacture, and supplier's name. Material Safety Data Sheets and technical bulletins for all materials shall be furnished to the Department with each shipment.

Nonreflective Sheeting Properties. Nonreflective sheeting shall consist of a flexible, pigmented cast vinyl film having a smooth, flat outer surface and shall meet the following requirements.

The Department reserves the right to sample and test delivered materials according to Federal Specification LS-300.

- (a) Adhesive. The sheeting shall have a Class 1, pre-coated, pressure sensitive adhesive according to ASTM D 4956. The adhesive shall have a protective liner that is easily removed when tested according to ASTM D 4956. The adhesive shall be capable of being applied to new or refurbished aluminum and reflectorized backgrounds without additional adhesive.
- (b) Color. The sheeting shall be uniform in color and devoid of streaks throughout the length of each roll.
- (c) Gloss. The sheeting shall exhibit a minimum 85 degree gloss-meter rating of 40 when tested according to ASTM D 523.
- (d) Durability. Applied sheeting that has been vertically exposed to the elements for seven years shall show no appreciable discoloration, cracking, crazing, blistering, delamination, or loss of adhesion. A slight amount of chalking is permitted but the sheeting shall not support fungus growth.
- (e) Testing. Test panels shall be prepared by applying the sheeting to 6 1/2 x 6 1/2 in. (165 x 165 mm) pieces of aluminum according to the manufacturer's specifications. The edges of the panel shall be trimmed evenly and aged 48 hours at 70 to 90 °F (21 to 32 °C). Shrinkage and immersion testing shall be as follows.

- (1) Shrinkage. The sheeting shall not shrink more than 1/64 in. (0.4 mm) from any panel edge when subjected to a temperature of 150 °F (66 °C) for 48 hours and shall be sufficiently heat resistant to retain adhesion after one week at 150 °F (66 °C).
- (2) Immersion Testing. The sheeting shall show no appreciable decrease in adhesion, color, or general appearance when examined one hour after being immersed to a depth of 2 or 3 in. (50 or 75 mm) in the following solutions at 70 to 90 °F (21 to 32 °C) for specified times.

Solution	Immersion Time (hours)
Reference Fuel (M I L-F-8799A) (15 parts xylol and 85 parts mineral spirits by weight)	1
Distilled Water	24
SAE No. 20 Motor Oil	24
Antifreeze (1/2 ethylene glycol, 1/2 distilled water)	24

- (f) Adhesive Bond: The sheeting shall form a durable bond to smooth, corrosion and weather-resistant surfaces and adhere securely when tested according to ASTM D 4956.
- (g) Thickness. The thickness of the sheeting without the protective liner shall be a maximum of 0.005 in. (0.13 mm).
- (h) Cutting. Material used on bed cutting machines shall have a smooth plastic liner.
- (i) Identification. The sheeting shall have a distinctive overall pattern in the sheeting unique to the manufacturer. If material orientation is required for optimum retroreflectivity, permanent orientation marks shall be incorporated into the face of the sheeting. Neither the overall pattern nor the orientation marks shall interfere with the reflectivity of the sheeting.
- (j) Packaging. Both ends of each box shall be clearly labeled with the sheeting type, color, adhesive type, manufacturer's lot number, date of manufacture, and supplier's name. Material Safety Data Sheets and technical bulletins for all materials shall be furnished to the Department with each shipment.

**SUBCONTRACTOR MOBILIZATION PAYMENTS (BDE)**

Effective: April 2, 2005

To account for the preparatory work and operations necessary for the movement of subcontractor personnel, equipment, supplies, and incidentals to the project site and for all

other work or operations that must be performed or costs incurred when beginning work approved for subcontracting in accordance with Article 108.01 of the Standard Specifications, the Contractor shall make a mobilization payment to each subcontractor.

This mobilization payment shall be made at least 14 days prior to the subcontractor starting work. The amount paid shall be equal to 3 percent of the amount of the subcontract reported on form BC 260A submitted for the approval of the subcontractor's work.

This provision shall be incorporated directly or by reference into each subcontract approved by the Department.

**TYPE ZZ RETROREFLECTIVE SHEETING, NONREFLECTIVE SHEETING, AND TRANSLUCENT OVERLAY FILM FOR HIGHWAY SIGNS (BDE)**

Effective: April 1, 2007

General. This special provision covers Type ZZ retroreflective sheeting and translucent overlay films intended for application on new or refurbished aluminum. The sheeting serves as the reflectorized background for sign messages and as cutout legends and symbols applied to the reflectorized background. Messages may be applied in opaque black or transparent colors.

This special provision also covers nonreflective sheeting for application on new or refurbished aluminum, and as material for cutout legends and symbols applied to the reflectorized background.

All material furnished under this specification shall have been manufactured within 18 months of the delivery date. All material shall be supplied by the same manufacturer.

Type ZZ Retroreflective Sheeting Properties. Type ZZ retroreflective sheeting shall consist of a flexible, colored, cubed corner prismatic, retroreflective material encapsulated by a flexible, transparent plastic having a smooth outer surface and shall meet the following requirements.

Only suppliers whose products have been tested and approved in the Department's periodic Sheeting Study will be eligible to supply material. All individual batches and or lots of material shall be tested and approved by the Department. The Department reserves the right to sample and test delivered materials according to Federal Specification LS-300.

- (a) Adhesive. The sheeting shall have a Class 1, pre-coated, pressure sensitive adhesive according to ASTM D 4956. The adhesive shall have a protective liner that is easily removed when tested according to ASTM D 4956. The adhesive shall be capable of being applied to new or refurbished aluminum without additional adhesive.
- (b) Color. The sheeting shall be uniform in color and devoid of streaks throughout the length of each roll. The color shall conform to the latest appropriate standard color tolerance chart issued by the U.S. Department of Transportation, Federal Highway Administration and to the daytime and nighttime color requirements of ASTM D 4956. Sheeting used for side by side overlay applications shall have a Hunter Lab Delta E of less than 3.

- (c) Coefficient of Retroreflection. When tested according to ASTM E 810, the sheeting shall have a minimum coefficient of retroreflection as shown in the following tables. The brightness of the sheeting when totally wet shall be a minimum of 90 percent of the values shown when tested according to the standard rainfall test specified in Section 7.10.1 of AASHTO M 268-84.

Type ZZ Sheeting  
Minimum Coefficient of Retroreflection  
candelas/foot candle/sq ft (candelas/lux/sq m) of material

Type ZZ (0 degree rotation)

Observation Angle (deg.)	Entrance Angle (deg.)	White	Yellow	Red	Green	Blue	FYG	FY	FO
0.2	-4	725	545	145	75	35	580	435	255
0.2	+30	300	225	60	30	15	240	180	105
0.5	-4	450	340	90	45	20	360	270	160
0.5	+30	180	135	40	20	10	145	110	65
1.0	-4	130	100	30	15	6	105	80	50
1.0	+30	70	55	15	10	3	60	45	25

Type ZZ (90 degree rotation)

Observation Angle (deg.)	Entrance Angle (deg.)	White	Yellow	Red	Green	Blue	FYG	FY	FO
0.2	-4	415	305	85	42	17	340	145	85
0.2	+30	80	60	18	14	4.4	64	48	23
0.5	-4	350	260	70	35	16	280	210	80
0.5	+30	75	56	15	12	3.6	60	45	25
1.0	-4	110	80	18	11	4.8	87	64	22
1.0	+30	20	13	3	2	1	12	9	3

- (d) Gloss. The sheeting surface shall exhibit a minimum 85 degree gloss-meter rating of 50 when tested according to ASTM D 523.
- (e) Durability. When processed and applied, the sheeting shall be weather resistant.

Accelerated weathering testing will be performed for 1000 hours (300 hours for orange/FO) according to ASTM G 151. The testing cycle will consist of 8 hours of light at 140 °F (60 °C), followed by 4 hours of condensation at 104 °F (40 °C). Following accelerated weathering, the sheeting shall exhibit a minimum of 80 percent of its initial minimum coefficient of retroreflection as listed in the previous tables.

Outdoor weathering will entail an annual evaluation of material placed in an outdoor rack with a 45 degree angle and a southern sun exposure. The sheeting will be evaluated for five years. Following weathering, the test specimens will be cleaned by immersing them in a five percent hydrochloric acid solution for 45 seconds, then rinsed with water and blotted dry with a soft clean cloth. Following cleaning, the applied sheeting shall show no appreciable discoloration, cracking, streaking, crazing, blistering, or dimensional change. The sheeting shall exhibit a Hunter Lab Delta E of 5 or less when compared to the original.

- (f) Shrinkage. When tested according to ASTM D 4956, the sheeting shall not shrink in any dimension more than 1/32 in. (0.8 mm) in ten minutes and not more than 1/8 in. (3 mm) in 24 hours.
- (g) Workability. The sheeting shall show no cracking, scaling, pitting, blistering, edge lifting, inter-film splitting, curling, or discoloration when processed and applied using mutually acceptable processing and application procedures.
- (h) Splices. A single roll of sheeting shall contain a maximum of four splices per 50 yd (45 m) length. The sheeting shall be overlapped a minimum of 3/16 in. (5 mm) at each splice.
- (i) Adhesive Bond. The sheeting shall form a durable bond to smooth, corrosion and weather-resistant surfaces and adhere securely when tested according to ASTM D 4956.
- (j) Positionability. Sheeting, with ASTM D 4956 Class 3 adhesive, used for manufacturing cutout legends and borders shall provide sufficient positionability during the fabrication process to permit removal and reapplication without damage to either the legend or sign background and shall have a plastic liner suitable for use on bed cutting machines. Thereafter, all other adhesive and bond requirements contained in the specification shall apply.

Positionability shall be verified by cutting 4 in. (100 mm) letters E, I, K, M, S, W, and Y out of the positionable material. The letters shall then be applied to a sheeted aluminum blank using a single pass of a two pound roller. The letters shall sit for five minutes and then a putty knife shall be used to lift a corner. The thumb and fore finger shall be used to slowly pull the lifted corner to lift letters away from the sheeted aluminum. The letters shall not tear or distort when removed.

- (k) Thickness. The thickness of the sheeting without the protective liner shall be less than or equal to 0.025 in. (0.6 mm).
- (l) Processing. The sheeting shall permit cutting and color processing according to the sheeting manufacturer's specifications at temperatures of 60 to 100 °F (15 to 38 °C) and within a relative humidity range of 20 to 80 percent. The sheeting shall be heat resistant and permit forced curing without staining the applied or unapplied sheeting at temperatures recommended by the manufacturer. The sheeting shall be solvent resistant and capable of being cleaned with VM&P naphtha, mineral spirits, and turpentine.

Transparent color and opaque black inks shall be single component and low odor. The inks shall dry within eight hours and not require clear coating. After color processing on white sheeting, the sheeting shall show no appreciable discoloration, cracking, streaking, crazing, blistering, or dimensional change when tested for durability (e). The ink on the weathered, prepared panel shall exhibit a Hunter Lab Delta E of 5 or less when compared to the original.

Transparent color electronic cutting films shall be acrylic. After application to white sheeting, the films shall show no appreciable discoloration, cracking, streaking, crazing,

blistering, or dimensional change when tested for durability (e). The films on the weathered, prepared panel shall exhibit a Hunter Lab Delta E of 5 or less when compared to the original.

Transparent colors screened, or transparent acrylic electronic cutting films, on white sheeting, shall have a minimum initial coefficient of retroreflection values of 50 percent for yellow and red, and a minimum 70 percent for green, blue, and brown of the 0.2 degree observation angle/-4.0 degree entrance angle values as listed in the previous tables for the color being applied. After durability testing, the colors shall retain a minimum 80 percent of the initial coefficient of retroreflection.

- (m) Identification. The sheeting shall have a distinctive overall pattern in the sheeting unique to the manufacturer. If material orientation is required for optimum retroreflectivity, permanent orientation marks shall be incorporated into the face of the sheeting. Neither the overall pattern nor the orientation marks shall interfere with the reflectivity of the sheeting.
- (n) Packaging. Both ends of each box shall be clearly labeled with the sheeting type, color, adhesive type, manufacturer's lot number, date of manufacture, and supplier's name. Material Safety Data Sheets and technical bulletins for all materials shall be furnished to the Department with each shipment.

Nonreflective Sheeting Properties. Nonreflective sheeting shall consist of a flexible, pigmented cast vinyl film having a smooth, flat outer surface and shall meet the following requirements.

The Department reserves the right to sample and test delivered materials according to Federal Specification LS-300.

- (a) Adhesive. The sheeting shall have a Class 1, pre-coated, pressure sensitive adhesive according to ASTM D 4956. The adhesive shall have a protective liner that is easily removed when tested according to ASTM D 4956. The adhesive shall be capable of being applied to new or refurbished aluminum and reflectorized backgrounds without additional adhesive.
- (b) Color. The sheeting shall be uniform in color and devoid of streaks throughout the length of each roll.
- (c) Gloss. The sheeting shall exhibit a minimum 85 degree gloss-meter rating of 40 when tested according to ASTM D 523.
- (d) Durability. Applied sheeting that has been vertically exposed to the elements for seven years shall show no appreciable discoloration, cracking, crazing, blistering, delamination, or loss of adhesion. A slight amount of chalking is permitted but the sheeting shall not support fungus growth.
- (e) Testing. Test panels shall be prepared by applying the sheeting to 6 1/2 x 6 1/2 in. (165 x 165 mm) pieces of aluminum according to the manufacturer's specifications. The edges of the panel shall be trimmed evenly and aged 48 hours at 70 to 90 °F (21 to 32 °C). Shrinkage and immersion testing shall be as follows.

- (1) Shrinkage. The sheeting shall not shrink more than 1/64 in. (0.4 mm) from any panel edge when subjected to a temperature of 150 °F (66 °C) for 48 hours and shall be sufficiently heat resistant to retain adhesion after one week at 150 °F (66 °C).
- (2) Immersion Testing. The sheeting shall show no appreciable decrease in adhesion, color, or general appearance when examined one hour after being immersed to a depth of 2 or 3 in. (50 or 75 mm) in the following solutions at 70 to 90 °F (21 to 32 °C) for specified times.

Solution	Immersion Time (hours)
Reference Fuel (M I L-F-8799A) (15 parts xylol and 85 parts mineral spirits by weight)	1
Distilled Water	24
SAE No. 20 Motor Oil	24
Antifreeze (1/2 ethylene glycol, 1/2 distilled water)	24

- (f) Adhesive Bond. The sheeting shall form a durable bond to smooth, corrosion and weather-resistant surfaces and adhere securely when tested according to ASTM D 4956.
- (g) Thickness. The thickness of the sheeting without the protective liner shall be a maximum of 0.005 in. (0.13 mm).
- (h) Cutting. Material used on bed cutting machines shall have a smooth plastic liner.
- (i) Identification. The sheeting shall have a distinctive overall pattern in the sheeting unique to the manufacturer. If material orientation is required for optimum retroreflectivity, permanent orientation marks shall be incorporated into the face of the sheeting. Neither the overall pattern nor the orientation marks shall interfere with the reflectivity of the sheeting.
- (j) Packaging. Both ends of each box shall be clearly labeled with the sheeting type, color, adhesive type, manufacturer's lot number, date of manufacture, and supplier's name. Material Safety Data Sheets and technical bulletins for all materials shall be furnished to the Department with each shipment.



STATE OF ILLINOIS  
DEPARTMENT OF TRANSPORTATION  
INT ATTRACT SIGN 2007-19  
C-60-026-07

INDEX OF SHEETS

- 1 COVER SHEET
- 2 ESTIMATED SUMMARY OF QUANTITIES
- 3 SAMPLE WORK ORDER
- 4 CLEAR HEIGHT DETAIL
- 5 - 6 BREAK - AWAY STEEL SIGN POST DETAILS
- 7 - 15 SIGN SUPPORT REPAIR DETAIL

STANDARDS

701006-02	701401-03
701101-01	701406-04
701106-01	701411-03
701201-02	702001-06
701301-02	720021-01
701400-02	

CONTRACT NO. 44952

SUMMARY OF QUANTITIES

CODE NUMBER	PAY ITEM	UNIT	Y002 - 1C 100% STATE TOTAL QUANTITY
T9990500	STRUCTURAL STEEL SIGN SUPPORT - BREAKAWAY	POUND	146,440
T9990900	CONCRETE FOUNDATIONS	CJ YD	290
T9991300	REMOVE EXISTING SIGN PANEL	EACH	100
T9991500	REMOVE EXISTING SIGN COMPLETE	EACH	10
T9991700	REMOVE CONCRETE FOUNDATION - GROUND MOUNT	EACH	10
T9992700	REMOVE AND REINSTALL SIGN PANEL	SQ FT	1,900
T9994000	REMOVE EXISTING SIGN SUPPORT	EACH	30
T9996600	INSTALL SERVICE SIGN OR MILE PLATE	EACH	400
T9996700	REMOVE SERVICE OR MILEAGE PLATE	EACH	100
T9998500	TRANSFER SERVICE SIGN	EACH	100
67100100	MOBILIZATION	L SUM	1
72000300	SIGN PANEL - TYPE 3	SQ FT	26,640

\*

\* SFTY-3C

# WORK ORDER

INTERSTATE ATTRACTION SIGNING 2007-19

WORK ORDER NO. \_\_\_\_\_ DATE OF ISSUE \_\_\_\_\_ ROUTE \_\_\_\_\_

LOCATION DESCRIPTION \_\_\_\_\_

CONTRACT NO. 44952

CODE NUMBER	ITEM	UNIT	QUANTITY	UNIT PRICE	ITEM COST
T9990500	STR STL SIN SUP BA	POUND			
T9990900	CONC FOUNDATIONS	CU YD			
T9991300	REM EX SIGN PANEL	EACH			
T9991500	REM EX SIGN COMPL	EACH			
T9991700	REM CONC FDN-GR MT	EACH			
T9992700	REM & REIN SIGN PANEL	SQ FT			
T9994000	REM EX SIN SUP	EACH			
T9996600	IN SER SN OR MILE PL	EACH			
T9996700	REM SER OR MILE PLATE	EACH			
T9998500	TRANSFER SERVICE SIGN	EACH			
72000300	SIGN PANEL, TYPE 3	SQ FT			
				<b>TOTAL COST</b>	

DISTRICT CONTACT

NAME: \_\_\_\_\_

TELEPHONE: \_\_\_\_\_

SUBMITTED BY: \_\_\_\_\_

Deputy Director of Highways, Regional Engineer

DATE: \_\_\_\_\_

APPROVED BY: \_\_\_\_\_

Engineer of Operations

DATE: \_\_\_\_\_

SAMPLE

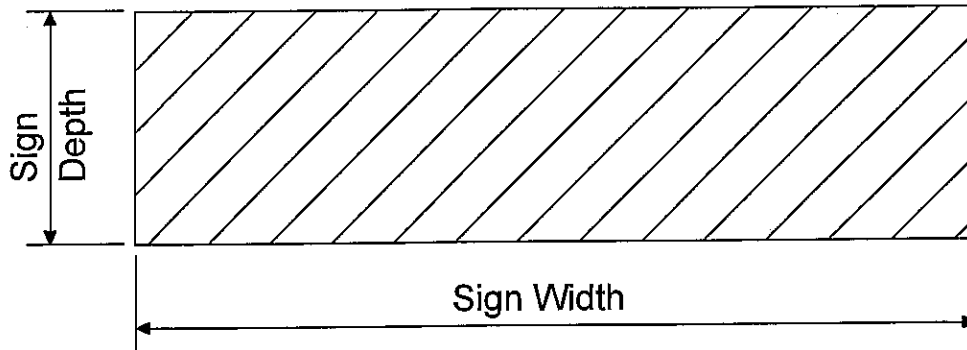

Figure 1

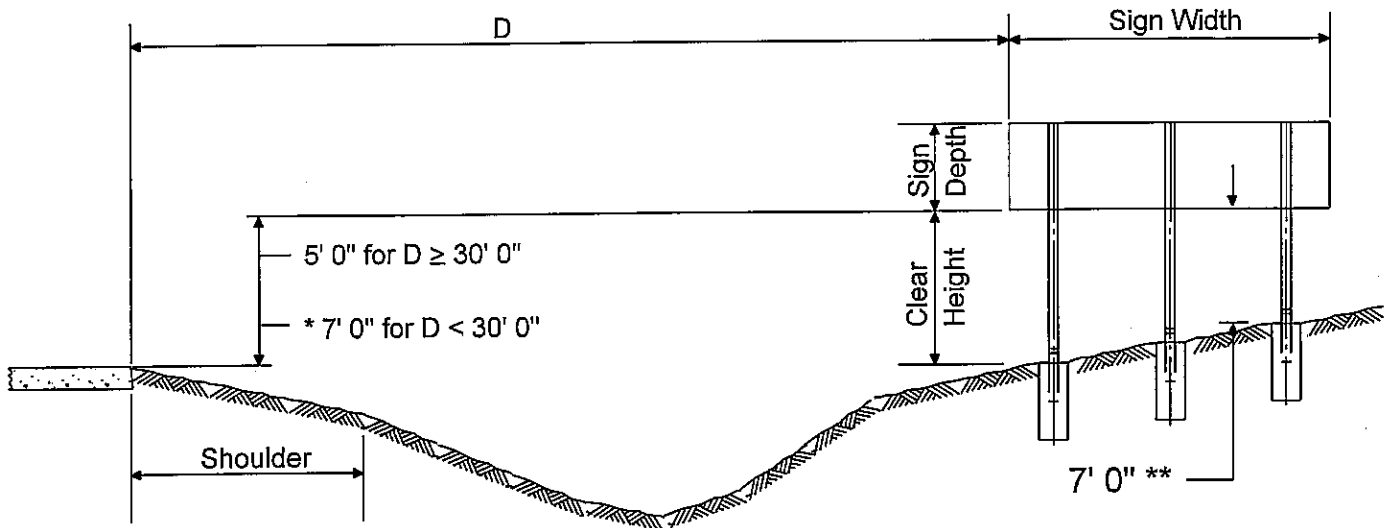

Figure 2

- \* May be reduced to 6' 0" when a supplemental panel is mounted below the main panel.
- \*\* Between top of stud post and fuse plate. May be reduced to 5' 0" when  $D = 30' 0''$  and the slope is 2:1 or steeper or where it would be unlikely for an out of control vehicle to reach the post.

The criteria illustrated in Figure 2 above is for expressways or fully access controlled freeways. All mounting heights shall be in accordance with the latest edition of the Illinois Manual on Uniform Traffic Control Devices.

Various Routes  
and Sign for Hwy & Rpt 2003-15  
Various Counties

Sheet No.	5 of 15
Project No.	INT ATTRACT SIGN 2007-19
Revision	

STATE OF ILLINOIS  
DEPARTMENT OF TRANSPORTATION

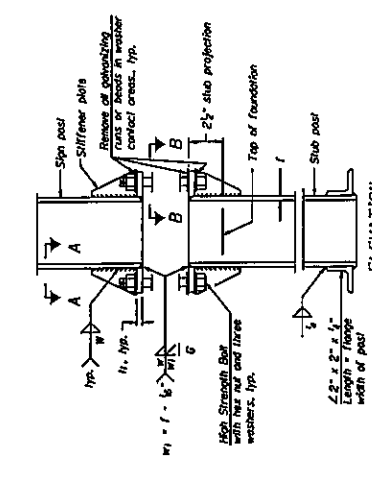

ELEVATION  
SIGN POST & STUB POST

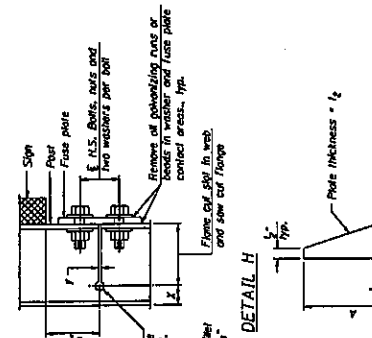

STIFFENER PLATE DETAIL  
(See table for dimensions.)

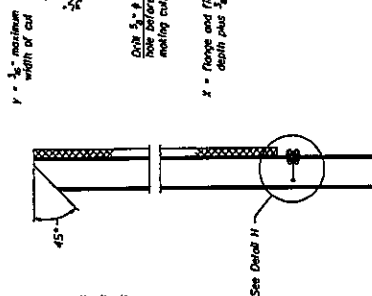

ELEVATION

0.15W	2 spaces of 0.15W	0.15W	For 3 posts
0.15W	3 spaces of 0.25W	0.15W	For 4 posts
0.1W	4 spaces of 0.2W	0.1W	For 5 posts

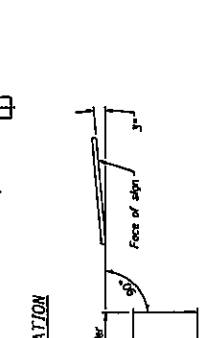

LOCATION SKETCH

FUSE PLATE DATA			
N = Bolt Diameter	G	H	H
1/2"	2"	1 1/2"	1 1/2"
3/4"	2 1/2"	1 3/4"	1 3/4"
1"	3"	1 3/4"	1 3/4"
1 1/4"	3 1/2"	1 3/4"	1 3/4"

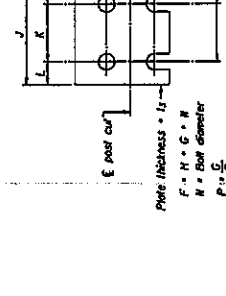

FUSE PLATE DETAIL  
(Mount with hex nuts, grom.)

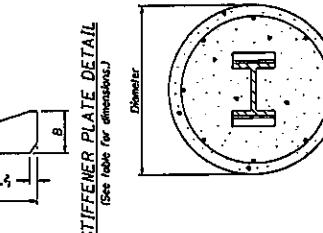

SECTION A-A

SECTION B-B

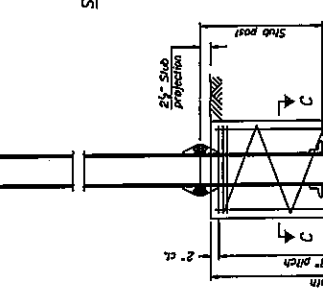

SECTION C-C

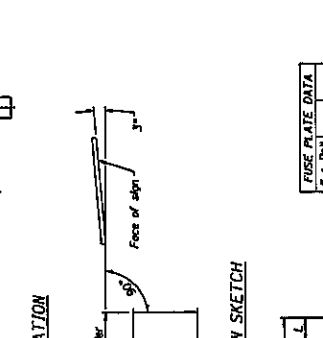

SECTION D-D

**GENERAL NOTES**  
Posts shall be fabricated by using shims with post-to-stub post connection bolts snug tight only. Final tightening of all high strength bolts shall be done by the contractor. The bolts shall be torqued to the top of the bolts and the nuts shall be torqued to the center punched to prevent the nut from loosening.  
LOADING: 80 mph, wind with 30% gust factor, normal to sign.  
DESIGN STRESSSES:  
Structural steel - 20,000 p.s.i.  
Reinforcing steel - 20,000 p.s.i.  
Concrete - 4,000 p.s.i.  
Filling soil pressure - 2,000 p.s.f.  
After fabrication, the post, fuse plate and upper 6' of stub post shall be galvanized in accordance with AASHTO M232. All bolts, nuts and washers shall be galvanized in accordance with AASHTO M232.  
Mount this sheet with Base Steel BAW-A-2.

BREAK-AWAY WIDE FLANGE  
STEEL SIGN POST DETAILS

SHIM DETAIL  
Furnish two 0.01" thick and two 0.03" thick shims per post.  
Furnish two 0.01" thick and two 0.03" thick shims per post.

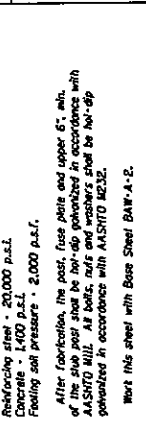

SHIM DETAIL  
Furnish two 0.01" thick and two 0.03" thick shims per post.

NUMBER	REVISION	DATE

DESIGNED	
CHECKED	
DRAWN	
CHECKED	

7/01/2006  
BAW-A-1

DATE	BY	CHK

Various Routes  
\*\* Old Sign Attr. Map & Rep. 2003-15  
\*\*\* Various Counties

STATE OF ILLINOIS  
DEPARTMENT OF TRANSPORTATION

POST	CONCRETE FOUNDATION TABLE			Side Post Length	POST TO STUB POST CONNECTION DATA											FOSE PLATE DATA				
	Foundation Depth	Concrete (ft)	Reinforcement (ft)		A	B	C	D	E	F	G	H	I	J	K	L	M			
WB29	6'-0"	0.70	5'-9"	1'-8 1/2"	2'-5 1/2"	6"	2 1/2"	1 1/2"	3 1/2"	1 1/2"	3 1/2"	1 1/2"	4"	2 1/2"	1 1/2"	1 1/2"				
WB15	6'-0"	0.70	5'-9"	1'-8 1/2"	2'-6"	6"	2 1/2"	1 1/2"	3 1/2"	1 1/2"	3 1/2"	1 1/2"	4"	2 1/2"	1 1/2"	1 1/2"				
WB18	6'-0"	0.70	5'-9"	1'-8 1/2"	2'-6"	6"	2 1/2"	1 1/2"	3 1/2"	1 1/2"	3 1/2"	1 1/2"	4"	2 1/2"	1 1/2"	1 1/2"				
WB22	6'-6"	1.18	6'-3"	2'-2 1/2"	3'-0"	6"	2 1/2"	1 1/2"	3 1/2"	1 1/2"	3 1/2"	1 1/2"	4"	2 1/2"	1 1/2"	1 1/2"				
WB26	6'-6"	1.41	7'-0"	2'-2 1/2"	3'-0"	6"	2 1/2"	1 1/2"	3 1/2"	1 1/2"	3 1/2"	1 1/2"	4"	2 1/2"	1 1/2"	1 1/2"				
WB30	7'-3"	1.50	7'-9"	2'-8 1/2"	3'-6"	6"	2 1/2"	1 1/2"	3 1/2"	1 1/2"	3 1/2"	1 1/2"	4"	2 1/2"	1 1/2"	1 1/2"				
WB45	8'-0"	2.09	7'-9"	2'-8 1/2"	3'-6"	6"	2 1/2"	1 1/2"	3 1/2"	1 1/2"	3 1/2"	1 1/2"	4"	2 1/2"	1 1/2"	1 1/2"				
WB45	8'-6"	2.23	8'-3"	2'-8 1/2"	3'-6"	6"	2 1/2"	1 1/2"	3 1/2"	1 1/2"	3 1/2"	1 1/2"	4"	2 1/2"	1 1/2"	1 1/2"				

\*Dimensional changes required for varying site conditions shall be approved by the Engineer.

POST	FOSE PLATE BOLT SIZE											
	4'-0"	5'-0"	6'-0"	7'-0"	8'-0"	9'-0"	10'-0"	11'-0"	12'-0"	13'-0"	14'-0"	15'-0"
WB29	1/2" x 1 1/2"	1/2" x 1 1/2"	1/2" x 1 1/2"	1/2" x 1 1/2"	1/2" x 1 1/2"	1/2" x 1 1/2"	1/2" x 1 1/2"	1/2" x 1 1/2"	1/2" x 1 1/2"	1/2" x 1 1/2"	1/2" x 1 1/2"	1/2" x 1 1/2"
WB15	1/2" x 1 1/2"	1/2" x 1 1/2"	1/2" x 1 1/2"	1/2" x 1 1/2"	1/2" x 1 1/2"	1/2" x 1 1/2"	1/2" x 1 1/2"	1/2" x 1 1/2"	1/2" x 1 1/2"	1/2" x 1 1/2"	1/2" x 1 1/2"	1/2" x 1 1/2"
WB18	1/2" x 1 1/2"	1/2" x 1 1/2"	1/2" x 1 1/2"	1/2" x 1 1/2"	1/2" x 1 1/2"	1/2" x 1 1/2"	1/2" x 1 1/2"	1/2" x 1 1/2"	1/2" x 1 1/2"	1/2" x 1 1/2"	1/2" x 1 1/2"	1/2" x 1 1/2"
WB22	1/2" x 1 1/2"	1/2" x 1 1/2"	1/2" x 1 1/2"	1/2" x 1 1/2"	1/2" x 1 1/2"	1/2" x 1 1/2"	1/2" x 1 1/2"	1/2" x 1 1/2"	1/2" x 1 1/2"	1/2" x 1 1/2"	1/2" x 1 1/2"	1/2" x 1 1/2"
WB26	1/2" x 1 1/2"	1/2" x 1 1/2"	1/2" x 1 1/2"	1/2" x 1 1/2"	1/2" x 1 1/2"	1/2" x 1 1/2"	1/2" x 1 1/2"	1/2" x 1 1/2"	1/2" x 1 1/2"	1/2" x 1 1/2"	1/2" x 1 1/2"	1/2" x 1 1/2"
WB26	1/2" x 1 1/2"	1/2" x 1 1/2"	1/2" x 1 1/2"	1/2" x 1 1/2"	1/2" x 1 1/2"	1/2" x 1 1/2"	1/2" x 1 1/2"	1/2" x 1 1/2"	1/2" x 1 1/2"	1/2" x 1 1/2"	1/2" x 1 1/2"	1/2" x 1 1/2"
WB30	1/2" x 1 1/2"	1/2" x 1 1/2"	1/2" x 1 1/2"	1/2" x 1 1/2"	1/2" x 1 1/2"	1/2" x 1 1/2"	1/2" x 1 1/2"	1/2" x 1 1/2"	1/2" x 1 1/2"	1/2" x 1 1/2"	1/2" x 1 1/2"	1/2" x 1 1/2"
WB45	1/2" x 1 1/2"	1/2" x 1 1/2"	1/2" x 1 1/2"	1/2" x 1 1/2"	1/2" x 1 1/2"	1/2" x 1 1/2"	1/2" x 1 1/2"	1/2" x 1 1/2"	1/2" x 1 1/2"	1/2" x 1 1/2"	1/2" x 1 1/2"	1/2" x 1 1/2"

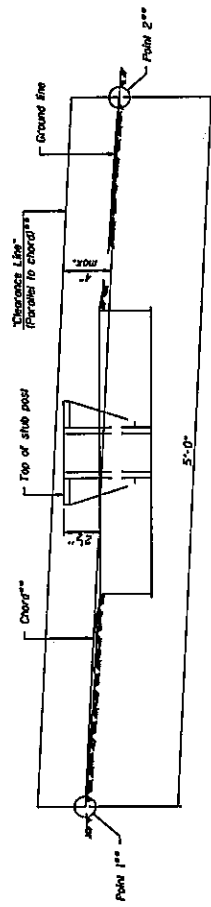

- ① Quantity includes of concrete necessary for one foundation.
- ② Includes reinforcement bars and spiral hooping for one foundation.

BREAK-AWAY WIDE FLANGE  
STEEL SIGN POST TABLES

NUMBER	REVISION	DATE

DESIGNED	
CHECKED	
DRAWN	
CHECKED	

# TYPICAL LOGO SIGNING

## Sign Layout

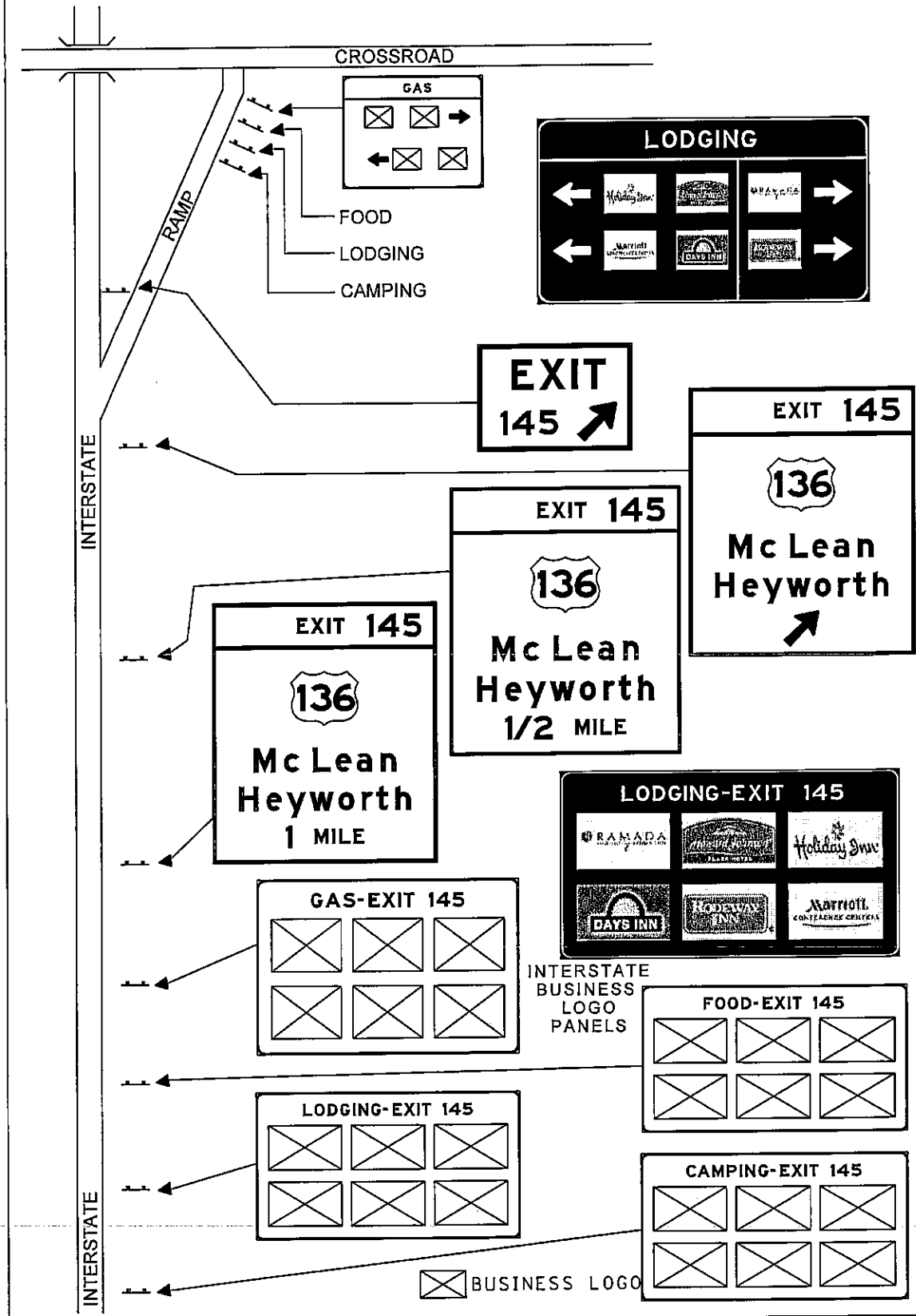

**GAS-EXIT 145**

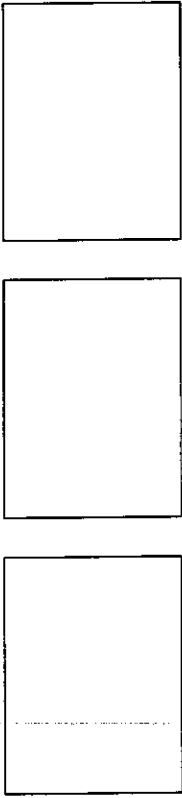

10 48 8 48 180 48  
9.0" Radius, 2.0" Border, White on Blue;

G3

**CAMPING-EXIT 145**

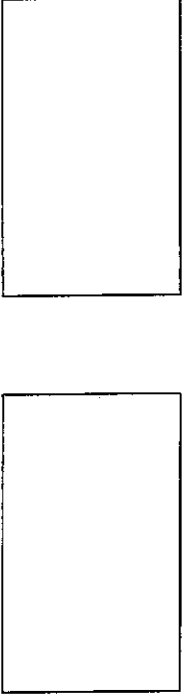

20 60 20 180 60 20  
9.0" Radius, 2.0" Border, White on Blue;

F2, L2, C2

**GAS-EXIT 145**

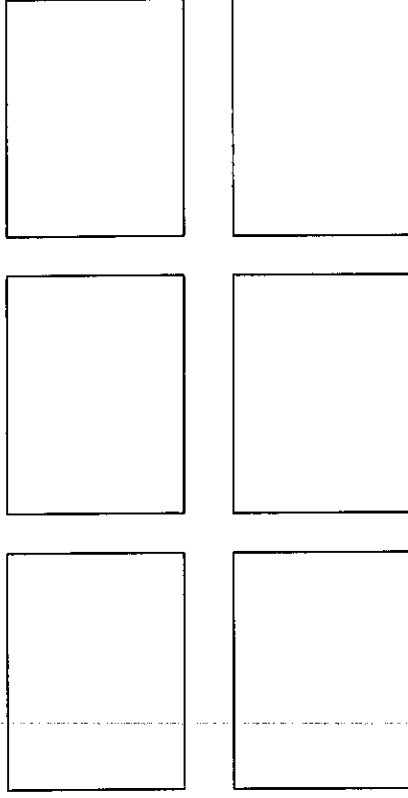

10 48 8 48 180 48  
9.0" Radius, 2.0" Border, White on Blue;

G6

**FOOD-EXIT 145**

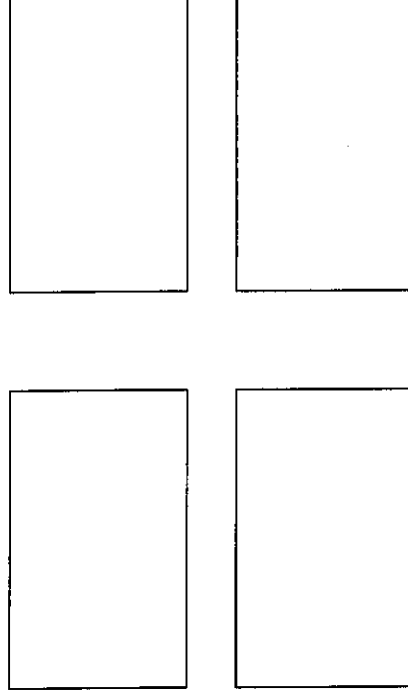

20 60 20 180 60 20  
9.0" Radius, 2.0" Border, White on Blue;

F4, L4, C4

**LOGO SERVICE SIGN DETAILS**

MAINLINE SIGNS

Various Routes  
INT ATTRACT SIGN 2007-19  
Various Counties  
Sheet 8 of 15  
Contract Number 44952



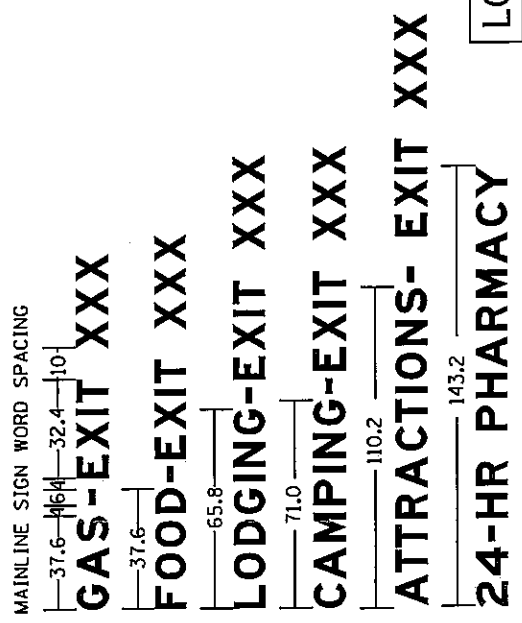
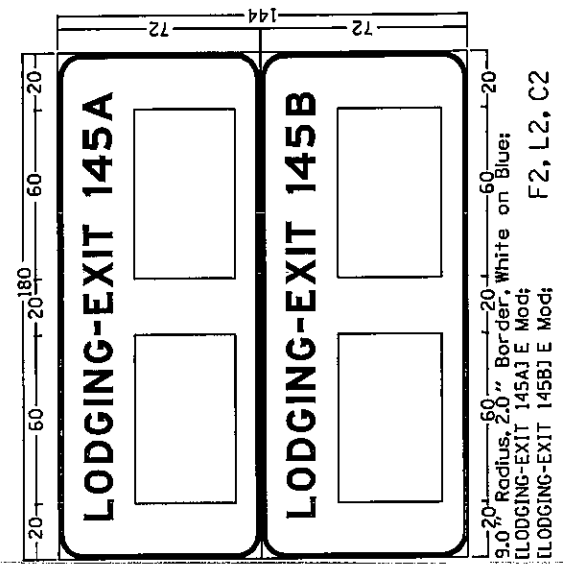
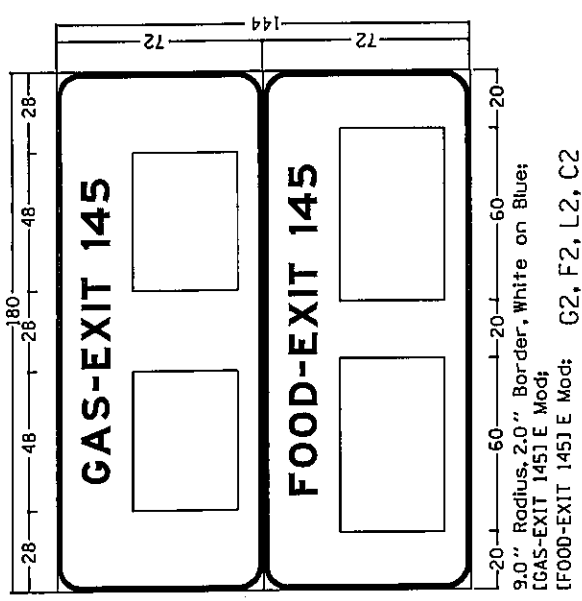
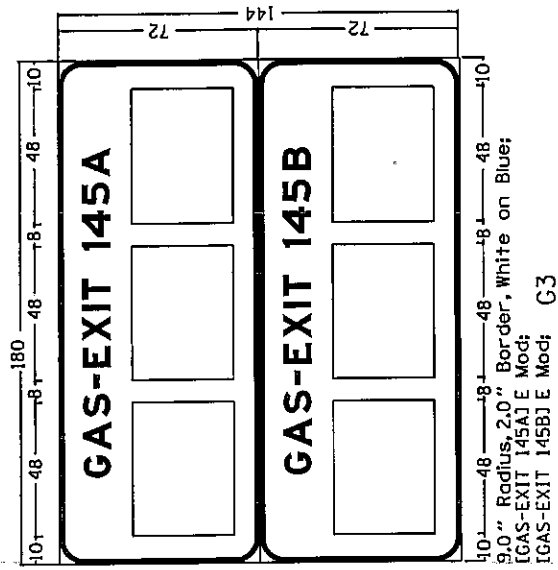

LOGO SERVICE SIGN DETAILS  
 MAINLINE SIGNS

Various Routes  
 INT ATTRACT SIGN 2007-19  
 Various Counties  
 Sheet 9 of 15  
 Contract Number 44952

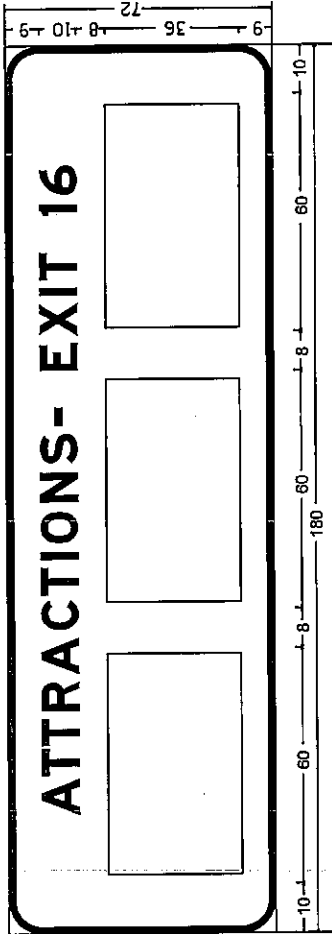

9.0" Radius, 2.0" Border, White on Blue;

A3, C3, F3, L3, P3

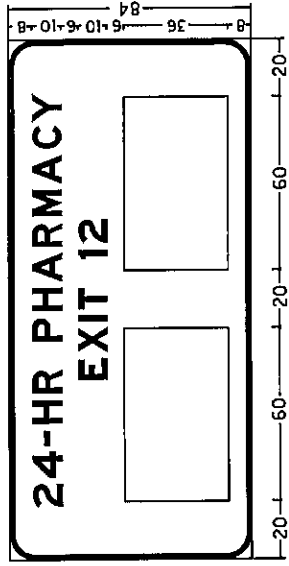

9.0" Radius, 2.0" Border, White on Blue;

[24-HR PHARMACY] E Mod; [EXIT 12] E Mod;

P2

**MAINLINE SERVICE PLATES**  
(Plates furnished by others)

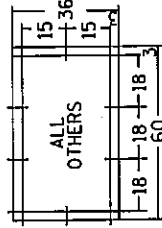
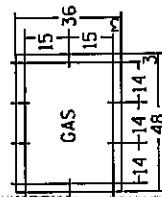

**GENERAL NOTES - MAINLINE SIGNS**

1. All legend 10" E modified.
2. All borders 2" wide.
3. All corners 9" radius.
4. Background blue / legend and border white.
5. Fabricate all 144" high signs as two separate 72" high panels.
6. All dimensions are shown in inches.

**LOGO SERVICE SIGN DETAILS**

**MAINLINE SIGNS**

Various Routes  
 INT ATTRACT SIGN 2007-19  
 Various Counties  
 Sheet 10 of 15  
 Contract Number 44952

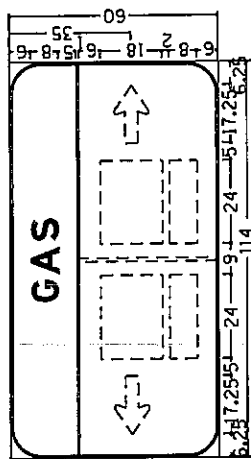

GSa, FSa, LSo

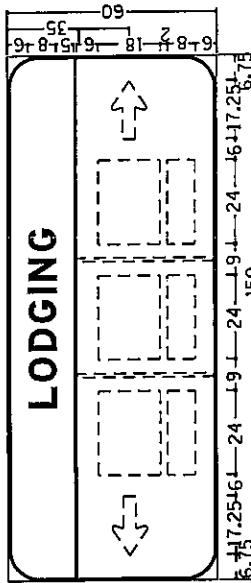

GSa, FSa, LSc

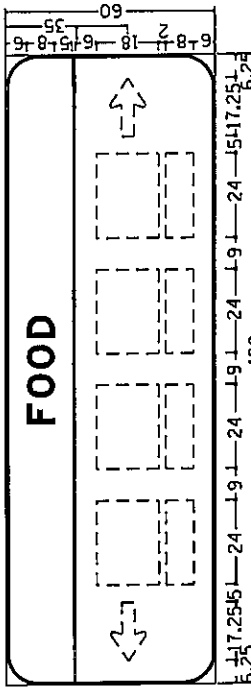

GSa, FSa, LSe

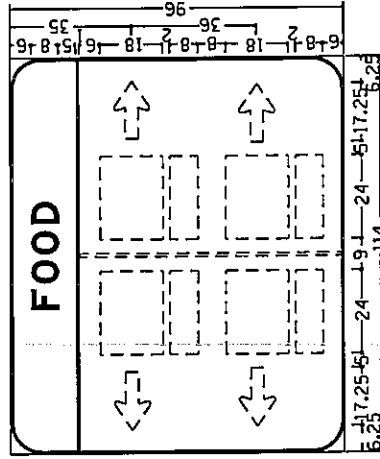

GSb, FSb, LSo

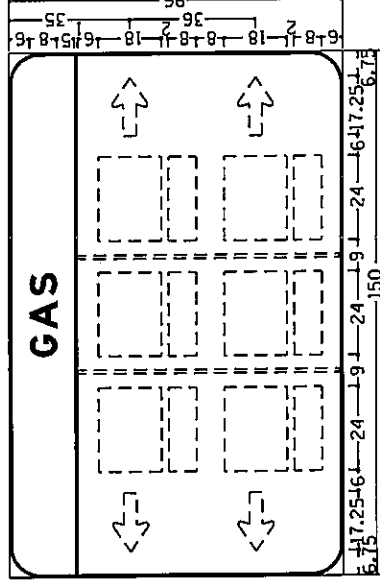

GSd, FSd, LSc

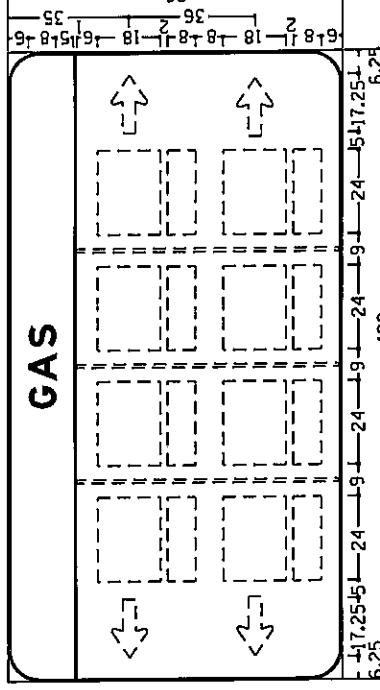

GSf, FSf, LSe

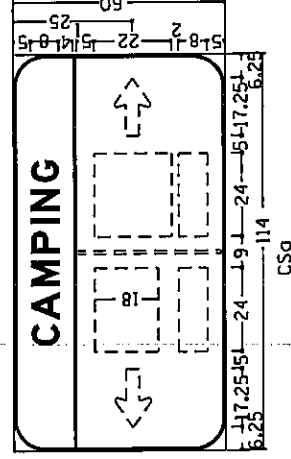

GSa

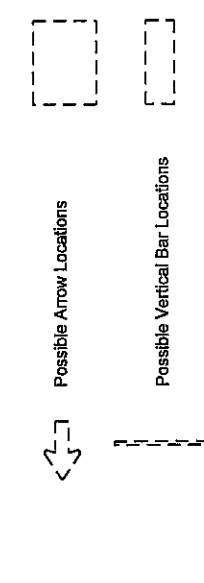

Possible Arrow Locations

Possible Vertical Bar Locations

Possible Service and Mileage Plate Locations

GENERAL NOTES - RAMP SIGNS

1. All legend 8 inch E modified.
2. All borders and vertical bars 1 inch.
3. All corners 9 inch radius.
4. Background blue / legend and border white.

LOGO SERVICE SIGN DETAILS

RAMP SIGNS FOR SINGLE-EXIT INTERCHANGES

Various Routes  
 INT ATTRACT SIGN 2007-19  
 Various Counties  
 Sheet 11 of 15  
 Contract Number 44952

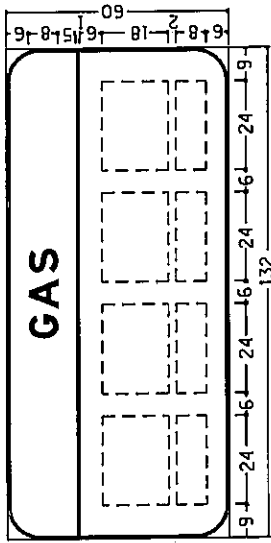

GDc, FDe, LDe

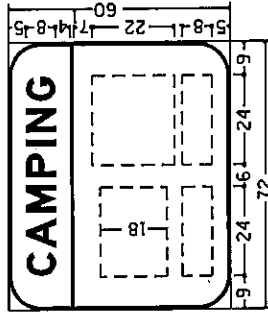

GDa

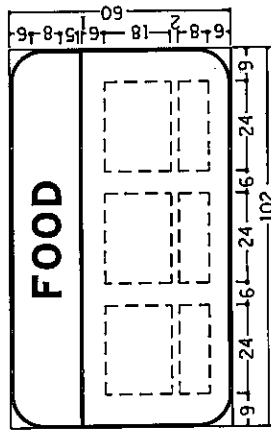

GDc, FDe, LDc

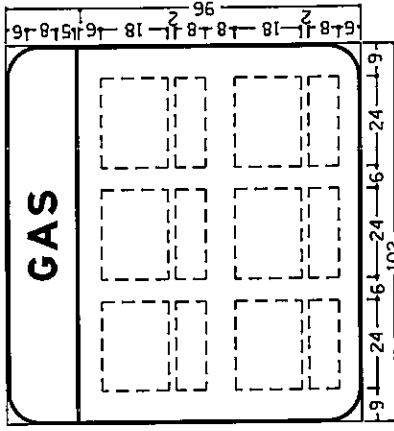

GDd, FDd, LDd

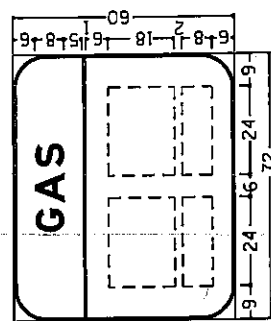

GDa, FDa, LDa

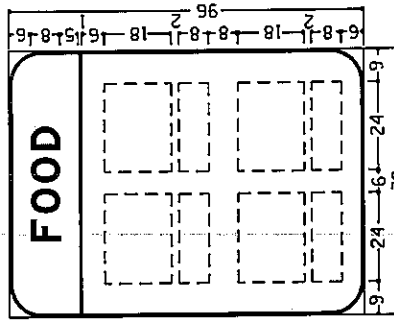

GDb, FDb, LDb

**RAMP SERVICE PLATES**  
(Plates furnished by others)

GAS, FOOD  
LOGGING &  
CAMPING

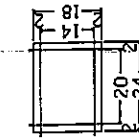

CAMPING  
OPEN  
SEASONALLY

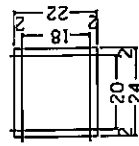

MILEAGE  
PLATE



RAMP  
ARROW  
SIZE

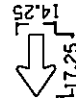

22.9  
**GAS**

30.1  
**FOOD**

52.5  
**LOGGING**

56.8  
**CAMPING**

Possible Arrow Locations



Possible Vertical Bar Locations

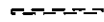

Possible Service and Mileage Plate Locations

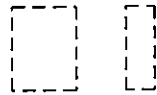

**GENERAL NOTES - RAMP SIGNS**

1. All legend 8 inch E modified.
2. All borders and vertical bars 1 inch.
3. All corners 9 inch radius.
4. Background blue / legend and border white.

**LOGO SERVICE SIGN DETAILS**

**MAINLINE SIGNS**

Various Routes  
INT ATTRACT SIGN 2007-19  
Various Counties  
Sheet 12 of 15  
Contract Number 44952

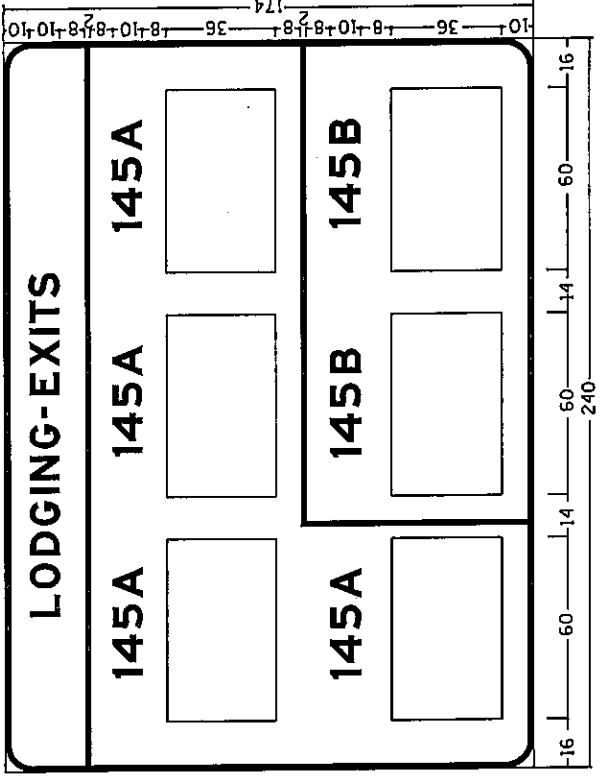
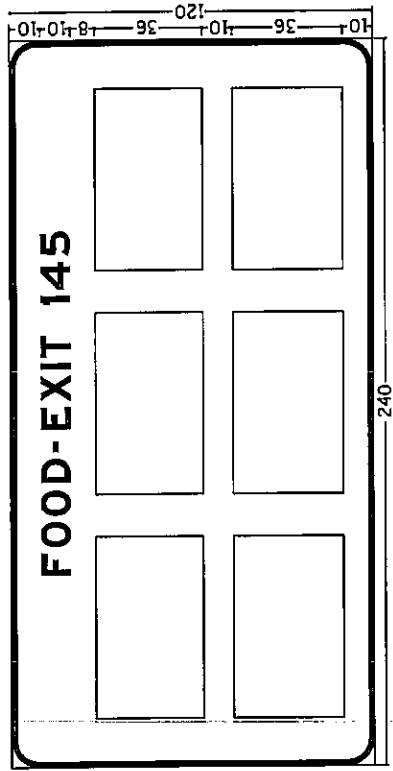

**GENERAL NOTES:**

1. All legend 10 inch E modified.
2. All borders 2 inches wide.
3. All corners 9 inch radius.
4. Background blue / legend and border white.
5. All dimensions are shown in inches.

**LOGO SERVICE SIGN DETAILS**  
**MAINLINE SIGNS WITH SIX LOGOS**  
**(FOOD, LODGING, OR CAMPING)**

Various Routes  
 INT ATTRACT SIGN 2007-19  
 Various Counties  
 Sheet 13 of 15  
 Contract Number 44952

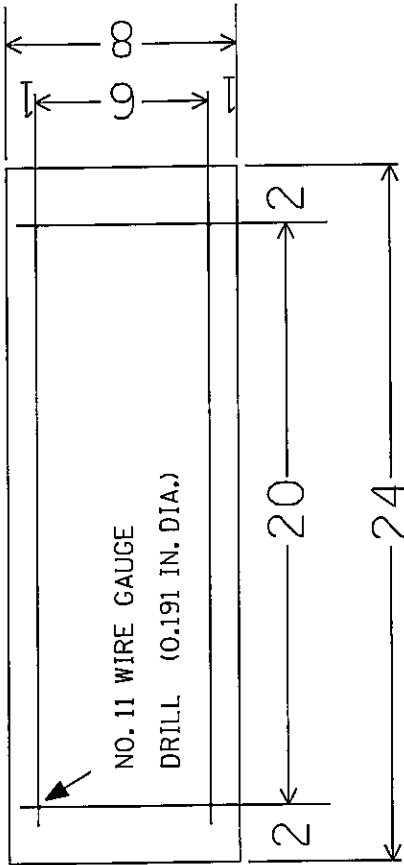

MILEAGE PLATE HOLE DETAIL

GENERAL NOTES

1. All legend C Series.
2. All legend to be centered.
3. All dimensions to be in inches.
4. White legend and blue background.

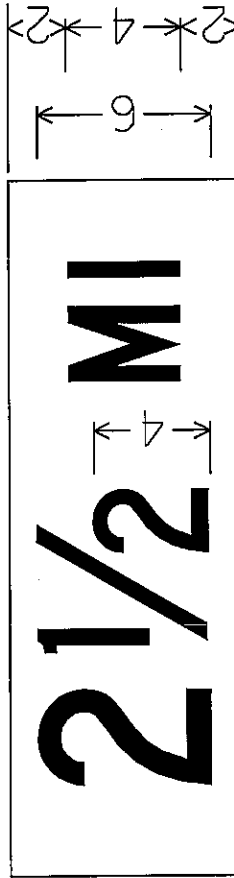

MILEAGE PLATE LEGEND DETAIL

LOGO SERVICE SIGN DETAILS
MILEAGE PLATE

Various Routes  
 INT ATTRACT SIGN 2007-19  
 Various Counties  
 Sheet 14 of 15  
 Contract Number 44952

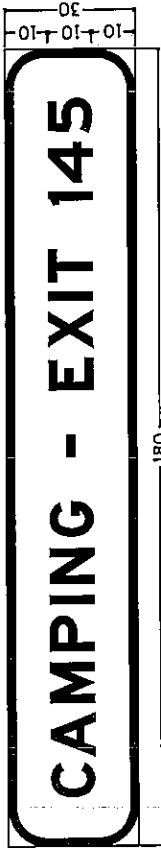

G5, F5, L5, C5  
**MAINLINE SIGN**



G5g, F5g, L5g, C5g



G5h, F5h, L5h, C5h

**NOTES:**

1. To be placed beneath Logo Service Signs where indicated.
2. Some general notes and legend sizes apply here as to other mainline and ramp Logo Service Signs.



G5i, F5i, L5i, C5i

**RAMP SIGNS**

<b>LOGO SERVICE SIGN DETAILS</b>
<b>SUPPLEMENTAL SERVICE SIGNS</b>

Various Routes  
 INT ATTRACT SIGN 2007-19  
 Various Counties  
 Sheet 15 of 15  
 Contract Number 44952

## ILLINOIS DEPARTMENT OF LABOR

### PREVAILING WAGES FOR VARIOUS COUNTIES EFFECTIVE APRIL 2007

The Prevailing rates of wages are included in the Contract proposals which are subject to Check Sheet #5 of the Supplemental Specifications and Recurring Special Provisions. The rates have been ascertained and certified by the Illinois Department of Labor for the locality in which the work is to be performed and for each craft or type of work or mechanic needed to execute the work of the Contract. As required by Prevailing Wage Act (820 ILCS 130/0.01, et seq.) and Check Sheet #5 of the Contract, not less than the rates of wages ascertained by the Illinois Department of Labor and as revised during the performance of a Contract shall be paid to all laborers, workers and mechanics performing work under the Contract. Post the scale of wages in a prominent and easily accessible place at the site of work.

If the Illinois Department of Labor revises the prevailing rates of wages to be paid as listed in the specification of rates, the contractor shall post the revised rates of wages and shall pay not less than the revised rates of wages. Current wage rate information shall be obtained by visiting the Illinois Department of Labor web site at <http://www.state.il.us/agency/idol/> or by calling 312-793-2814. It is the responsibility of the contractor to review the rates applicable to the work of the contract at regular intervals in order to insure the timely payment of current rates. Provision of this information to the contractor by means of the Illinois Department of Labor web site satisfies the notification of revisions by the Department to the contractor pursuant to the Act, and the contractor agrees that no additional notice is required. The contractor shall notify each of its subcontractors of the revised rates of wages.



# Adams County Prevailing Wage for April 2007

Trade Name	RG	TYP	C	Base	FRMAN	*M-F>8	OSA	OSH	H/W	Pensn	Vac	Trng
=====	==	==	=	=====	=====	=====	==	==	=====	=====	=====	=====
ASBESTOS ABT-GEN		BLD		16.580	16.580	1.5	1.5	2.0	5.300	7.030	0.000	0.600
ASBESTOS ABT-MEC		BLD		25.290	26.290	1.5	1.5	2.0	4.450	2.500	0.000	0.250
BOILERMAKER		BLD		38.540	42.000	2.0	2.0	2.0	6.720	7.440	0.000	0.300
BRICK MASON		BLD		24.370	25.370	1.5	1.5	2.0	6.000	5.400	0.000	0.490
CARPENTER		BLD		24.790	26.790	1.5	1.5	2.0	6.500	7.600	0.000	0.320
CARPENTER		HWY		24.600	26.350	1.5	1.5	2.0	6.500	7.450	0.000	0.300
CEMENT MASON		BLD		22.800	23.800	1.5	1.5	2.0	5.200	8.080	0.000	0.150
CEMENT MASON		HWY		22.170	23.170	1.5	1.5	2.0	5.200	7.300	0.000	0.250
CERAMIC TILE FNSHER		BLD		23.020	0.000	1.5	1.5	2.0	6.000	5.400	0.000	0.000
ELECTRIC PWR EQMT OP		ALL		30.750	0.000	1.5	1.5	2.0	4.750	8.610	0.000	0.000
ELECTRIC PWR GRNDMAN		ALL		21.090	0.000	1.5	1.5	2.0	4.750	5.905	0.000	0.000
ELECTRIC PWR LINEMAN		ALL		34.160	36.350	1.5	1.5	2.0	4.750	9.560	0.000	0.000
ELECTRIC PWR TRK DRV		ALL		22.130	0.000	1.5	1.5	2.0	4.750	6.200	0.000	0.000
ELECTRICIAN		BLD		25.290	27.290	1.5	1.5	2.0	5.150	6.460	0.000	0.250
ELECTRONIC SYS TECH		BLD		23.850	25.350	1.5	1.5	2.0	5.150	5.625	0.000	0.250
ELEVATOR CONSTRUCTOR		BLD		34.190	38.460	2.0	2.0	2.0	8.275	6.060	2.050	0.000
GLAZIER		BLD		27.130	28.130	1.5	2.0	2.0	5.430	4.000	0.000	0.280
HT/FROST INSULATOR		BLD		30.440	31.440	1.5	1.5	2.0	4.850	8.360	0.000	0.450
IRON WORKER		ALL		21.500	22.750	1.5	1.5	2.0	5.760	6.790	0.000	0.260
LABORER		BLD		16.580	16.580	1.5	1.5	2.0	5.300	7.030	0.000	0.600
LABORER		HWY		20.780	21.530	1.5	1.5	2.0	5.300	7.030	0.000	0.600
LATHER		BLD		24.790	26.790	1.5	1.5	2.0	6.500	7.600	0.000	0.320
MACHINIST		BLD		36.890	38.890	2.0	2.0	2.0	4.380	5.650	2.550	0.000
MARBLE FINISHERS		BLD		23.020	0.000	1.5	1.5	2.0	6.000	5.400	0.000	0.000
MARBLE MASON		BLD		24.520	25.270	1.5	1.5	2.0	6.000	5.400	0.000	0.000
MILLWRIGHT		BLD		26.000	28.000	1.5	1.5	2.0	6.500	6.850	0.000	0.320
MILLWRIGHT		HWY		19.070	20.320	1.5	1.5	2.0	2.800	3.000	0.000	0.000
OPERATING ENGINEER		BLD	1	26.550	0.000	1.5	1.5	2.0	6.150	6.200	0.000	0.850
OPERATING ENGINEER		BLD	2	24.200	0.000	1.5	1.5	2.0	6.150	6.200	0.000	0.850
OPERATING ENGINEER		BLD	3	20.600	0.000	1.5	1.5	2.0	6.150	6.200	0.000	0.850
OPERATING ENGINEER		BLD	4	28.050	0.000	1.5	1.5	2.0	6.150	6.200	0.000	0.850
OPERATING ENGINEER		HWY	1	26.800	0.000	1.5	1.5	2.0	6.150	6.200	0.000	0.850
OPERATING ENGINEER		HWY	2	24.030	0.000	1.5	1.5	2.0	6.150	6.200	0.000	0.850
OPERATING ENGINEER		HWY	3	19.800	0.000	1.5	1.5	2.0	6.150	6.200	0.000	0.850
OPERATING ENGINEER		HWY	4	28.300	0.000	1.5	1.5	2.0	6.150	6.200	0.000	0.850
PAINTER		ALL		25.390	26.390	1.5	1.5	2.0	4.650	5.500	0.000	0.250
PAINTER OVER 30FT		ALL		26.390	27.390	1.5	1.5	2.0	4.650	5.500	0.000	0.250
PAINTER PWR EQMT		ALL		26.390	27.390	1.5	1.5	2.0	4.650	5.500	0.000	0.250
PILEDRIVER		BLD		25.290	27.290	1.5	1.5	2.0	6.500	7.600	0.000	0.320
PILEDRIVER		HWY		25.100	26.850	1.5	1.5	2.0	6.500	7.450	0.000	0.300
PIPEFITTER		ALL		30.520	33.570	1.5	1.5	2.0	4.800	7.960	0.000	0.530
PLASTERER		BLD		25.000	26.500	1.5	1.5	2.0	4.830	8.050	0.000	0.500
PLUMBER		ALL		30.520	33.570	1.5	1.5	2.0	4.800	7.960	0.000	0.530
ROOFER		BLD		24.200	25.200	1.5	1.5	2.0	5.350	6.550	0.000	0.150
SHEETMETAL WORKER		BLD		24.150	25.710	1.5	1.5	2.0	6.040	7.000	0.000	0.380
SPRINKLER FITTER		BLD		31.240	33.240	1.5	1.5	2.0	6.500	5.350	0.000	0.250
STONE MASON		BLD		24.370	25.370	1.5	1.5	2.0	6.000	5.400	0.000	0.490
TERRAZZO FINISHER		BLD		23.020	0.000	1.5	1.5	2.0	6.000	5.400	0.000	0.000
TERRAZZO MASON		BLD		24.520	25.270	1.5	1.5	2.0	6.000	5.400	0.000	0.000
TILE LAYER		BLD		24.790	26.790	1.5	1.5	2.0	6.500	7.600	0.000	0.320
TILE MASON		BLD		24.520	25.270	1.5	1.5	2.0	6.000	5.400	0.000	0.000
TRUCK DRIVER		ALL	1	25.930	0.000	1.5	1.5	2.0	7.250	3.425	0.000	0.000
TRUCK DRIVER		ALL	2	26.330	0.000	1.5	1.5	2.0	7.250	3.425	0.000	0.000
TRUCK DRIVER		ALL	3	26.530	0.000	1.5	1.5	2.0	7.250	3.425	0.000	0.000
TRUCK DRIVER		ALL	4	26.780	0.000	1.5	1.5	2.0	7.250	3.425	0.000	0.000
TRUCK DRIVER		ALL	5	27.530	0.000	1.5	1.5	2.0	7.250	3.425	0.000	0.000
TRUCK DRIVER		O&C	1	20.740	0.000	1.5	1.5	2.0	7.250	3.425	0.000	0.000
TRUCK DRIVER		O&C	2	21.060	0.000	1.5	1.5	2.0	7.250	3.425	0.000	0.000

TRUCK DRIVER	O&C 3	21.220	0.000	1.5	1.5	2.0	7.250	3.425	0.000	0.000
TRUCK DRIVER	O&C 4	21.420	0.000	1.5	1.5	2.0	7.250	3.425	0.000	0.000
TRUCK DRIVER	O&C 5	22.020	0.000	1.5	1.5	2.0	7.250	3.425	0.000	0.000
TUCKPINTER	BLD	24.370	25.370	1.5	1.5	2.0	6.000	5.400	0.000	0.490

Legend:

M-F>8 (Overtime is required for any hour greater than 8 worked each day, Monday through Friday.)

OSA (Overtime is required for every hour worked on Saturday)

OSH (Overtime is required for every hour worked on Sunday and Holidays)

H/W (Health & Welfare Insurance)

Pensn (Pension)

Vac (Vacation)

Trng (Training)

## Explanations

The following list is considered as those days for which holiday rates of wages for work performed apply: New Years Day, Memorial/Decoration Day, Fourth of July, Labor Day, Veterans Day, Thanksgiving Day, Christmas Day. Generally, any of these holidays which fall on a Sunday is celebrated on the following Monday. This then makes work performed on that Monday payable at the appropriate overtime rate for holiday pay. Common practice in a given local may alter certain days of celebration such as the day after Thanksgiving for Veterans Day. If in doubt, please check with IDOL.

Oil and chip resealing (O&C) means the application of road oils and liquid asphalt to coat an existing road surface, followed by application of aggregate chips or gravel to coated surface, and subsequent rolling of material to seal the surface.

### EXPLANATION OF CLASSES

ASBESTOS - GENERAL - removal of asbestos material/mold and hazardous materials from any place in a building, including mechanical systems where those mechanical systems are to be removed. This includes the removal of asbestos materials/mold and hazardous materials from ductwork or pipes in a building when the building is to be demolished at the time or at some close future date.

ASBESTOS - MECHANICAL - removal of asbestos material from mechanical systems, such as pipes, ducts, and boilers, where the mechanical systems are to remain.

### CERAMIC TILE FINISHER, MARBLE FINISHER, TERRAZZO FINISHER

Assisting, helping or supporting the tile, marble and terrazzo mechanic by performing their historic and traditional work assignments required to complete the proper installation of the work covered by said crafts. The term "Ceramic" is used for naming the classification only and is in no way a limitation of the product handled. Ceramic takes into consideration most hard tiles.

## ELECTRONIC SYSTEMS TECHNICIAN

Installation, service and maintenance of low-voltage systems which utilizes the transmission and/or transference of voice, sound, vision, or digital for commercial, education, security and entertainment purposes for the following: TV monitoring and surveillance, background/foreground music, intercom and telephone interconnect, field programming, inventory control systems, microwave transmission, multi-media, multiplex, radio page, school, intercom and sound burglar alarms and low voltage master clock systems.

Excluded from this classification are energy management systems, life safety systems, supervisory controls and data acquisition systems not intrinsic with the above listed systems, fire alarm systems, nurse call systems and raceways exceeding fifteen feet in length

## TRUCK DRIVER - BUILDING, HEAVY AND HIGHWAY CONSTRUCTION

Class 1. Drivers on 2 axle trucks hauling less than 9 ton. Air compressor and welding machines and brooms, including those pulled by separate units, truck driver helpers, warehouse employees, mechanic helpers, greasers and tiremen, pickup trucks when hauling materials, tools, or workers to and from and on-the-job site, and fork lifts up to 6,000 lb. capacity.

Class 2. Two or three axle trucks hauling more than 9 ton but hauling less than 16 ton. A-frame winch trucks, hydrolift trucks, vector trucks or similar equipment when used for transportation purposes. Fork lifts over 6,000 lb. capacity, winch trucks, four axle combination units, and ticket writers.

Class 3. Two, three or four axle trucks hauling 16 ton or more. Drivers on water pulls, articulated dump trucks, mechanics and working forepersons, and dispatchers. Five axle or more combination units.

Class 4. Low Boy and Oil Distributors.

Class 5. Drivers who require special protective clothing while employed on hazardous waste work.

## TRUCK DRIVER - OIL AND CHIP RESEALING ONLY.

This shall encompass laborers, workers and mechanics who drive contractor or subcontractor owned, leased, or hired pickup, dump, service, or oil distributor trucks. The work includes transporting materials and equipment (including but not limited to, oils, aggregate supplies, parts, machinery and tools) to or from the job site; distributing oil or liquid asphalt and aggregate; stock piling material when in connection with the actual oil and chip contract. The Truck Driver (Oil & Chip Resealing) wage classification does not include supplier delivered materials.

## OPERATING ENGINEERS - BUILDING

CLASS 1. Asphalt Screed Man; Aspco Concrete Spreaders; Asphalt Pavers; Asphalt Plant Engineer; Asphalt Rollers on Bituminous Concrete; Athey Loaders; Backfillers, Crane Type; Backhoes; Barber Green Loaders; Bulldozers; Cableways; Cherry Pickers; Clam Shells; C.M.I. & similar type autograde formless paver, autograde placer & finisher; Concrete Breakers; Concrete Pumps; Derricks; Derrick Boats;

Draglines; Earth Auger or Boring Machines; Elevating Graders; Engineers on Dredges; Gravel Processing Machines; Head Equipment Greaser; High Lifts or Fork Lifts; Hoists with two or more drums or two or more load lines; Locomotives, All; Mechanics; Motor Graders or Auto Patrols; Operators or Leverman on Dredges; Operators, Power Boat; Operators, Pug Mill (Asphalt Plants); Orange Peels; Overhead Cranes; Paving Mixers; Piledrivers; Pipe Wrapping and Painting Machines; Pushdozers, or Push Cats; Robotic Controlled Equipment in this Classification; Rock Crushers; Ross Carrier or Similar Machines; Rotomill; Scoops, Skimmer, two cu. yd. capacity and under; Scoops, All or Tournapull; Sheep-Foot Roller (Self Propelled); Shovels; Skid Steer; Skimmer Scoops; Temporary Concrete Plant Operators; Test Hole Drilling Machines; Tower Machines; Tower Mixers; Track Type End Loaders; Track Type Fork Lifts or High Lifts; Track Jacks and Tampers; Tractors, Sideboom; Trenching or Ditching Machine; Tunnelluggers; Vermeer Type Saws; Water Blaster Cutting Head; Wheel Type End Loaders; Winch Cat.

CLASS 2. Air Compressors (six to eight)\*; Asphalt Boosters and Heaters; Asphalt Distributors; Asphalt Plant Fireman; Oiler on Two Paving Mixers When Used in Tandem; Boom or Winch Trucks; Bull Floats or Flexplanes; Concrete Finishing Machine; Concrete Saws, Self-Propelled; Concrete Spreading Machines; Conveyors (six to eight)\*; Generators (six to eight)\*; Gravel or Stone Spreader, Power Operated; Hoist (with One Drum and One Load Line); Light Plants (six to eight)\*; Mechanical Heaters (six to eight)\*; Mud Jacks; Post Hole Digger, Mechanical; Pug Mills when used for other than Asphalt operation; Robotic Controlled Equipment in this Classification; Road or Street Sweeper, Self Propelled; Rollers (except bituminous concrete); Seaman Tiller; Straw Machine; Vibratory Compactor; Water Blaster, Power Unit; Welding Machines (six to eight)\*; Well Drill Machines.

CLASS 3. Air Compressors(one to five)\*; Air Compressors, Track or Self-Propelled; Automatic Hoist; Building Elevators; Bulk Cement Batching Plants; Conveyors (one to five)\*; Concrete Mixers (Except Plant, Paver, or Tower); Firemen; Generators (one to five)\*; Greasers; Helper on Single Paving Mixer; Hoist, Automatic; Light Plants (one to five)\*; Mechanic Helpers; Mechanical Heaters (one to five)\*; Oilers; Power Form Graders; Power Sub-Graders; Robotic Controlled Equipment in this Classification; Scissors Hoist; Tractors without power attachments regardless of size or type; Truck Crane Oiler and Driver (1 man); Vibratory Hammer (power source); Water Pumps (one to five)\*; Welding Machines (1/300 Amp. or over)\*; Welding machines (one to five)\*

CLASS 4. Lattice Boom Crawler Cranes; Lattice Boom Truck Cranes; Telescopic Truck-Mounted Cranes; Tower Cranes.

\* Combinations of one to eight of any Air Compressors, Conveyors, Welding Machines, Water Pumps, Light Plants, or Generators shall be in batteries or within 400 feet and shall be paid as per the Classification Schedule contained in this Article.

#### OPERATING ENGINEERS - HIGHWAY

CLASS 1. Asphalt Screed Man; Asphco Concrete Spreaders; Asphalt Pavers; Asphalt Plant Engineer; Asphalt Rollers on Bituminous Concrete; Athey Loaders; Backhoes; Barber Green Loaders; Bulldozers; Cableways; Carry Deck Pickers; Cherry Pickers (Rough Terrain); C.M.I. & similar type-autograde formless paver, autograde placer & finisher; Concrete Breakers; Concrete Plant Operators; Concrete Pumps; Derricks; Derrick Boats; Dewatering Systems; Earth Auger or Boring Machines;

Elevating Graders; Engineers on Dredges; Gravel Processing Machines; Grout Pump; Head Equipment Greaser; High Lifts or Fork Lifts; Hoists with two or more drums or two or more load lines; Hydro Jet or Hydro Laser; Locomotives, All; Mechanics; Motor Graders or Auto Patrols; Multi-Point Power Lifting Equipment; Operators or Leverman on Dredges; Operators, Power Boat; Operators, Pug Mill (Asphalt Plants); Overhead Cranes; Paving Mixers; Piledrivers; Pipe Wrapping and Painting Machines; Push-dozers, or Push Cats; Robotic Controlled Equipment in this Classification; Rock Crushers; Ross Carrier or Similar Machines; Roto-Mill; Scoops, Skimmer, two cu. yd. capacity and under; Sheep-Foot Roller (Self Propelled); Shovels; Skid Steer; Skimmer Scoops; Test Hole Drilling Machines; Tower Machines; Tower Mixers; Track Type End Loaders; Track Type Fork Lifts or High Lifts; Track Jacks and Tampers; Tractors, Side-boom; Trenching or Ditching Machine; Tunnelluggers; Vermeer-Type Saws; Wheel Type End Loaders; Winch Cat; Scoops, All or Tournapull.

CLASS 2. Air Compressors (six to eight)\*; Articulated Dumps; Asphalt Boosters and Heaters; Asphalt Distributors; Asphalt Plant Fireman; Boom or Winch Trucks; Building Elevators; Bull Floats or Flexplanes; Concrete Finishing Machine; Concrete Saws, Self-Propelled; Concrete Spreading Machines; Conveyors (six to eight)\*; Generators (six to eight)\*; Gravel or Stone Spreader, Power Operated; Hoist, Automatic; Hoist with One Drum and One Load Line; Light Plants (six to eight)\*; Mechanical Heaters (six to eight)\*; Mud Jacks; Off Road Water Wagons; Oiler on Two Paving Mixers When Used in Tandem; Post Hole Digger, Mechanical; Robotic Controlled Equipment in This Classification; Road or Street Sweeper, Self-Propelled; Rollers (except bituminous concrete); Scissor Hoist; Sea-man Tiller; Straw Machine; Vibratory Compactor; Water Pumps (six to eight)\*; Well Drill Machines.

CLASS 3. Air Compressors (one to five)\*; Air Compressors, Track or Self-Propelled; Bulk Cement Batching Plants; Conveyors (one to five)\*; Concrete Mixers (Except Plant, Paver, or Tower); Firemen; Generators (one to five)\*; Greasers; Helper on Single Paving Mixer; Light Plants (one to five)\*; Mechanic Helpers; Mechanical Heaters (one to five)\*; Oilers; Power Form Graders; Power Sub-Graders; Pug Mills when used for other than Asphalt operation; Robotic Controlled Equipment in This Classification; Tractors without power attachments, regardless of size or type; Truck Crane Oiler and Driver (1 man); Vibratory Hammer (power source); Water Pumps (one to five)\*; Welding Machines (one 300 Amp. or over)\*; Welding Machines (one to five)\*.

CLASS 4. Lattice Boom Crawler Crane; Lattice Boom Truck Crane; Telescopic Truck-Mounted Crane; Tower Crane.

\*Combinations of one to eight of any Air Compressors, Conveyors, Welding Machines, Water Pumps, Light Plants or Generators shall be in batteries or within 400 feet and shall be paid as per the Classification Schedule contained in this Article.

#### Other Classifications of Work:

For definitions of classifications not otherwise set out, the Department generally has on file such definitions which are available. If a task to be performed is not subject to one of the classifications of pay set out, the Department will upon being contacted state which neighboring county has such a classification and provide such rate, such rate being deemed to exist by reference in this document. If no neighboring county rate applies to the task, the Department shall undertake a special determination, such special determination being then deemed to have existed under this

determination. If a project requires these, or any classification not listed, please contact IDOL at 618/993-7271 for wage rates or clarifications.

#### LANDSCAPING

Landscaping work falls under the existing classifications for laborer, operating engineer and truck driver. The work performed by landscape plantsman and landscape laborer is covered by the existing classification of laborer. The work performed by landscape operators (regardless of equipment used or its size) is covered by the classifications of operating engineer. The work performed by landscape truck drivers (regardless of size of truck driven) is covered by the classifications of truck driver.

# Alexander County Prevailing Wage for April 2007

Trade Name	RG	TYP	C	Base	FRMAN	*M-F>8	OSA	OSH	H/W	Pensn	Vac	Trng
=====	==	==	=	=====	=====	=====	=====	=====	=====	=====	=====	=====
ASBESTOS ABT-GEN		ALL		20.750	21.200	1.5	1.5	2.0	5.250	5.600	0.000	0.700
ASBESTOS ABT-MEC		BLD		25.290	26.290	1.5	1.5	2.0	4.450	2.500	0.000	0.250
BOILERMAKER		BLD		28.500	31.000	1.5	1.5	2.0	6.820	11.03	0.000	0.300
BRICK MASON		BLD		25.470	26.970	1.5	1.5	2.0	6.000	5.400	0.000	0.425
CARPENTER		BLD		27.780	29.280	1.5	1.5	2.0	5.050	3.750	0.000	0.350
CARPENTER		HWY		27.730	29.230	1.5	1.5	2.0	5.050	3.750	0.000	0.350
CEMENT MASON		BLD		23.500	24.500	1.5	1.5	2.0	5.200	3.550	0.000	0.100
CEMENT MASON		HWY		23.750	24.750	1.5	1.5	2.0	5.300	3.700	0.000	0.300
CERAMIC TILE FNSHER		BLD		24.990	0.000	1.5	1.5	2.0	6.000	5.400	0.000	0.425
ELECTRICIAN		ALL		32.910	35.160	1.5	1.5	2.0	5.150	6.580	0.000	0.490
ELECTRONIC SYS TECH		BLD		25.700	27.200	1.5	1.5	2.0	5.150	3.340	0.000	0.250
FLOOR LAYER		BLD		26.930	27.680	1.5	1.5	2.0	5.000	3.750	0.000	0.350
GLAZIER		BLD		22.930	0.000	1.5	1.5	2.0	4.320	3.800	0.000	0.300
HT/FROST INSULATOR		BLD		30.440	31.440	1.5	1.5	2.0	4.850	8.360	0.000	0.450
IRON WORKER		ALL		22.650	23.650	1.5	1.5	2.0	5.760	6.450	0.000	0.310
LABORER		BLD		20.750	21.200	1.5	1.5	2.0	5.250	5.600	0.000	0.600
LABORER		HWY		21.000	21.450	1.5	1.5	2.0	5.350	6.150	0.000	0.600
LABORER		O&C		15.750	16.200	1.5	1.5	2.0	5.350	6.150	0.000	0.600
MACHINIST		BLD		36.890	38.890	2.0	2.0	2.0	4.380	5.650	2.550	0.000
MARBLE FINISHERS		BLD		24.990	0.000	1.5	1.5	2.0	6.000	5.400	0.000	0.425
MARBLE MASON		BLD		25.470	26.970	1.5	1.5	2.0	6.000	5.400	0.000	0.425
MILLWRIGHT		BLD		27.780	29.280	1.5	1.5	2.0	5.050	3.750	0.000	0.350
MILLWRIGHT		HWY		27.730	29.230	1.5	1.5	2.0	5.050	3.750	0.000	0.350
OE RIVER 1		RIV	1	26.900	0.000	1.5	1.5	2.0	5.650	6.100	0.000	1.100
OE RIVER 2		RIV	2	23.450	0.000	1.5	1.5	2.0	5.650	6.100	0.000	1.100
OPERATING ENGINEER		ALL	1	26.800	27.800	1.5	1.5	2.0	5.650	6.100	0.000	1.100
OPERATING ENGINEER		ALL	2	24.900	27.800	1.5	1.5	2.0	5.650	6.100	0.000	1.100
OPERATING ENGINEER		ALL	3	24.150	27.800	1.5	1.5	2.0	5.650	6.100	0.000	1.100
OPERATING ENGINEER		ALL	4	21.400	27.800	1.5	1.5	2.0	5.650	6.100	0.000	1.100
OPERATING ENGINEER		O&C	1	20.100	21.100	1.5	1.5	2.0	5.650	6.100	0.000	1.100
OPERATING ENGINEER		O&C	2	18.680	21.100	1.5	1.5	2.0	5.650	6.100	0.000	1.100
OPERATING ENGINEER		O&C	3	18.120	21.100	1.5	1.5	2.0	5.650	6.100	0.000	1.100
OPERATING ENGINEER		O&C	4	16.050	21.100	1.5	1.5	2.0	5.650	6.100	0.000	1.100
PAINTER		BLD		22.790	23.790	1.5	1.5	2.0	5.430	4.500	0.000	0.250
PAINTER		HWY		27.090	28.090	1.5	1.5	2.0	5.430	4.500	0.000	0.250
PAINTER OVER 30FT		BLD		23.790	24.790	1.5	1.5	2.0	5.430	4.500	0.000	0.250
PAINTER PWR EQMT		BLD		23.790	24.790	1.5	1.5	2.0	5.430	4.500	0.000	0.250
PAINTER PWR EQMT		HWY		28.090	29.090	1.5	1.5	2.0	5.430	4.500	0.000	0.250
PILEDRIVER		BLD		27.780	29.280	1.5	1.5	2.0	5.050	3.750	0.000	0.350
PILEDRIVER		HWY		27.730	29.230	1.5	1.5	2.0	5.050	3.750	0.000	0.350
PIPEFITTER		BLD		31.300	34.430	1.5	2.0	2.0	6.450	5.030	0.000	0.620
PLASTERER		BLD		23.500	24.500	1.5	1.5	2.0	5.200	3.550	0.000	0.100
PLUMBER		BLD		31.300	34.430	1.5	2.0	2.0	6.450	5.030	0.000	0.620
ROOFER		BLD		19.700	20.500	1.5	1.5	2.0	5.700	3.800	0.000	0.000
SHEETMETAL WORKER		ALL		27.210	28.460	1.5	1.5	2.0	6.000	4.770	1.630	0.120
SPRINKLER FITTER		BLD		31.240	33.240	1.5	1.5	2.0	6.500	5.350	0.000	0.250
STONE MASON		BLD		25.470	26.970	1.5	1.5	2.0	6.000	5.400	0.000	0.425
TERRAZZO FINISHER		BLD		24.990	0.000	1.5	1.5	2.0	6.000	5.400	0.000	0.425
TERRAZZO MASON		BLD		28.500	28.800	1.5	1.5	2.0	0.000	2.950	0.000	0.000
TRUCK DRIVER		ALL	1	24.990	0.000	1.5	1.5	2.0	7.250	4.200	0.000	0.000
TRUCK DRIVER		ALL	2	25.390	0.000	1.5	1.5	2.0	7.250	4.200	0.000	0.000
TRUCK DRIVER		ALL	3	25.590	0.000	1.5	1.5	2.0	7.250	4.200	0.000	0.000
TRUCK DRIVER		ALL	4	25.840	0.000	1.5	1.5	2.0	7.250	4.200	0.000	0.000
TRUCK DRIVER		ALL	5	26.590	0.000	1.5	1.5	2.0	7.250	4.200	0.000	0.000
TRUCK DRIVER		O&C	1	19.500	0.000	1.5	1.5	2.0	4.275	4.670	0.000	0.000
TRUCK DRIVER		O&C	2	15.900	0.000	1.5	1.5	2.0	4.275	4.670	0.000	0.000
TRUCK DRIVER		O&C	3	16.400	0.000	1.5	1.5	2.0	4.275	4.670	0.000	0.000
TUCK POINTER		BLD		24.370	25.370	1.5	1.5	2.0	6.000	5.400	0.000	0.490

Legend :

M-F>8 (Overtime is required for any hour greater than 8 worked each day, Monday through Friday.)

OSA (Overtime is required for every hour worked on Saturday)

OSH (Overtime is required for every hour worked on Sunday and Holidays)

H/W (Health & Welfare Insurance)

Pensn (Pension)

Vac (Vacation)

Trng (Training)

## Explanations

### ALEXANDER COUNTY

The following list is considered as those days for which holiday rates of wages for work performed apply: New Years Day, Memorial/Decoration Day, Fourth of July, Labor Day, Veterans Day, Thanksgiving Day, Christmas Day. Generally, any of these holidays which fall on a Sunday is celebrated on the following Monday. This then makes work performed on that Monday payable at the appropriate overtime rate for holiday pay. Common practice in a given local may alter certain days of celebration such as the day after Thanksgiving for Veterans Day. If in doubt, please check with IDOL.

Oil and chip resealing (O&C) means the application of road oils and liquid asphalt to coat an existing road surface, followed by application of aggregate chips or gravel to coated surface, and subsequent rolling of material to seal the surface.

### EXPLANATION OF CLASSES

ASBESTOS - GENERAL - removal of asbestos material/mold and hazardous materials from any place in a building, including mechanical systems where those mechanical systems are to be removed. This includes the removal of asbestos materials/mold and hazardous materials from ductwork or pipes in a building when the building is to be demolished at the time or at some close future date.

ASBESTOS - MECHANICAL - removal of asbestos material from mechanical systems, such as pipes, ducts, and boilers, where the mechanical systems are to remain.

### LABORER - OIL AND CHIP RESEALING ONLY

Hook and unhook chip box from aggregate truck; distribute material within chip box; perform flagging work related to oil and chip resealing; hand spray oil fluids; handle traffic control, including setting-up and maintaining barricades, drums, cones, delineators, signs and other such items, as well as laying-out and applying or removing temporary roadway markings used to control traffic in job site related to oil and chip resealing; and perform clean-up related to oil and chip resealing.



#### CERAMIC TILE FINISHER, MARBLE FINISHER, TERRAZZO FINISHER

Assisting, helping or supporting the tile, marble and terrazzo mechanic by performing their historic and traditional work assignments required to complete the proper installation of the work covered by said crafts. The term "Ceramic" is used for naming the classification only, and is in no a limitation of the product handled. Ceramic takes into consideration most hard tiles.

#### ELECTRONIC SYSTEMS TECHNICIAN

Installation, service and maintenance of low-voltage systems which utilizes the transmission and/or transference of voice, sound, vision, or digital for commercial, education, security and entertainment purposes for the following: TV monitoring and surveillance, background/foreground music, intercom and telephone interconnect, field programming, inventory control systems, microwave transmission, multi-media, multiplex, radio page, school, intercom and sound burglar alarms and low voltage master clock systems.

Excluded from this classification are energy management systems, life safety systems, supervisory controls and data acquisition systems not intrinsic with the above listed systems, fire alarm systems, nurse call systems and raceways exceeding fifteen feet in length.

#### TRUCK DRIVER - BUILDING, HEAVY AND HIGHWAY CONSTRUCTION

Class 1. Drivers on 2 axle trucks hauling less than 9 ton. Air compressor and welding machines and brooms, including those pulled by separate units, truck driver helpers, warehouse employees, mechanic helpers, greasers and tiremen, pickup trucks when hauling materials, tools, or workers to and from and on-the-job site, and fork lifts up to 6,000 lb. capacity.

Class 2. Two or three axle trucks hauling more than 9 ton but hauling less than 16 ton. A-frame winch trucks, hydrolift trucks, vector trucks or similar equipment when used for transportation purposes. Fork lifts over 6,000 lb. capacity, winch trucks, four axle combination units, and ticket writers.

Class 3. Two, three or four axle trucks hauling 16 ton or more. Drivers on water pulls, articulated dump trucks, mechanics and working forepersons, and dispatchers. Five axle or more combination units.

Class 4. Low Boy and Oil Distributors.

Class 5. Drivers who require special protective clothing while employed on hazardous waste work.

#### TRUCK DRIVER - O & C - (Oil and Chip Resealing ONLY)

It involves driving of contractor or subcontractor owned, leased, or hired pickup, dump, service, or oil distributor trucks. Includes transporting materials and equipment (including, but not limited to oils, aggregate supplies, parts, machinery and tools) to or from the job site; distributing oil or liquid asphalt and aggregate; stock piling material; and maintaining trucks at job site related to oil and chip resealing.

Class 1. Distributors, liquid asphalt hauling and hauling of asphalt rubber-tired rollers.

Class 2. Stockpiling.

Class 3. Tandem hauling to job site.

OPERATING ENGINEERS - BUILDING, HEAVY AND HIGHWAY CONSTRUCTION

Class 1. APSCO or Equal Spreading Machine, Backhoe, Backfiller, Boom or Winch Cat, Bituminous Mixplane Machine, Blacksmith, Bituminous Surfacing Machine, Bull-Dozer, Crane, Shovel, Dragline, Truck Crane, Pile Driver, Concrete Breaker, Concrete or Pumpcrete Pumps, Dinky or Standard Locomotives, Well or Caisson Drills, Elevating Grader, Fork Lifts, Flexplane, Gradeall, Hi-Lift Hoists, Guy-Derricks, Hysters, Mechanic Motor Patrol, Mixers-21 cu. ft. or over, Push Cats, Pulls and Scrapers, Two Well Point Pumps, Pulverizer or Tiller, PugMill, Rubber-Tired Farm Type Tractor with Bulldozer/Blade/Auger or hi-lift over 1/2 yd., Jersey Spreader, Tract-Air used with Drill or Hi-Lift, Trenching or Ditching Machines, Wood Chipper w/Tractor, Self-Propelled Roller w/Blade, Equipment Greaser, Self-Propelled Bump Grinder on Concrete pavement, Boat Operator, Skid-Loaders, Tuggers, Lazer Screed, and Self-Propelled Chip Spreader (when others run conveyors).

Class 2. Any type tractor pulling any type roller or disc, Two Air Compressors (220 cu. ft. capacity or over), Two AirTract Drills, Air-Track Drill w/Compressor, Automatic Bins or Scales w/Compressor or Generator, Pipeline Boring Machine, Bulk Cement Plant w/Separate Compressor, Power Operated Bull Float, Hydra-Lift w/Single Motor, Straw Mulcher Blower w/Spout, Self-Propelled Roller/Compactor, Back-End man on Bituminous Surfacing Machine, oiler on milling machine.

Class 3. Air Compressor w/Valve driving piling, Boom or Winch Type Truck, Two Conveyors, Self-Propelled Concrete Saw, Form Grader, Truck Crane Oiler, Self-Propelled Vibrator, Rubber Tired Farm Type Tractor w/Blade/Bulldozer/Auger/hi-lift - 1/2 yd. or less, Elevator Operator, Man Lift (scissor lift) when lifting materials.

Class 4. Air-Track Drill (one), Belt Drag Machine, Power Broom, Mechanical Plasterer Applicator, Trac-Air, Air Compressor (220 cu. ft. or over) One, Air Compressor (under 220 cu. ft) four, Automatic Bin, Bulk Cement Plant w/Built-in Compressor running off same motor or electric motor, Fireman or Switchman, Self-Propelled Form Tamper, Light Plants (4), Welding Machines (4), Pumps (4), or Combination of four (4) Pumps, Light Plants, Welding Machines, Air-Compressors (under 220 cu. ft.), Mudjacks or Wood Chipper, Mixers - less than 21 cu. ft. Mortar Mixer w/Skip or Pump, Pipeline Tract Jack. One Operating Engineer may operate and maintain any combination of the following pieces of equipment, not to exceed four (4) which shall be within a reasonable distance, such combination may include any equipment in this classification: (Compressors, Light Plants, Generators, Welding Machines, Pumps or Conveyors), One Well- Point Pump, Two Motor Driven Heaters, One Air Compressor (under 220 cu. ft.), One Engine-Driven Conveyor, One Motor Driven Heater, One Light Plant, One Pump, One Welding Machine, One Ulmac or Equal Spreader, Oilers, and one Generator 10 kw or greater.

OPERATING ENGINEER - O & C (Oil and Chip Resealing ONLY). Includes the operation of all motorized heavy equipment used in oil and chip rsealing, including but not limited to operating self-propelled chip spreaders, and all types of rollers (both hard and rubber tired); and other duties pertaining to the operation or maintenance of heavy equipment related to oil and chip resealing.

Class 1. See Class 1 above for types of equipment operated.

Class 2. See Class 2 above for types of equipment operated.

Class 3. See Class 3 above for types of equipment operated.

Class 4. See Class 4 above for types of equipment operated.

OPERATING ENGINEER RIVER WORK 1 - operate the following machines when working on River Work and Levee Work on the Mississippi and Ohio Rivers, Lakes and Tributaries: Crane, Shovel, Drageline, Scrapers, Dredge, Derrick, Pile-Driver, Push Boat, all power boat operators, Mechanic, Engineman on Dredge, Leverman on Dredge, All Bituminous Spreader machines, Backhoe, Backfiller, Boom, or Winch Cat, Bituminous Mixplane Machine, Blacksmith, Bituminous Surfacing Machine, Bulldozer, Truck Cranes, Hydraulic Truck Mounted Boom/Crane, Concrete Finishing Machine, or Spreader Machine, Concrete Breaker, Concrete or Pumpcrete Machines, Concrete Plant Operator, All Off Road Material Hauling Equipment, Dinky or Standard Locomotives, Well Drill, Elevating Grader, Fork-Lifts, Flexplane, Gradeall, Hi-Lift, Power Handblade Tugger type Hoist, Hoist Two Drum (or over one), Gyderrick, Hyster, Motor Patrol, Mixers - 21 Cu. Ft. or over, Push Cat, Pulls, & Scrapers, Pumps-Two Well Points, Equipment Greaser, P & H Pulverizer or Pulverizer equal to Pugmill, Pugmill, Rubber-Tired farm type tractor w/Bulldozer/Blade/Auger or Hi-Lift over ½ yard, Skimmer Scoops, Seaman Tiller, Jersey Spreader, Tract-Air used with Drill or Hi-Lift, Trenching or Ditching Machine, Wood Chipper w/Tractor, self-propelled roller w/Blade, Concrete Pumps and Small Equipment Operators.

OPERATING ENGINEER RIVER 2 - when working on River Work and Levee Work on the Mississippi and Ohio Rivers, Lakes and Tributaries shall be employed as the Oiler or Fireman on Crane, Dragline, Shovel, Dredge, Truck Crane, Pile Driver, Gradeall, Dinky or Standard Locomotive, Guy Derrick, Trenching Machine or Ditching Machine 80 H.P. and over, All Terrain (cherry-picker) with over 40 ton Lifting Capacity, Deck Oiler and Deckhands.

#### Other Classifications of Work:

For definitions of classifications not otherwise set out, the Department generally has on file such definitions which are available. If a task to be performed is not subject to one of the classifications of pay set out, the Department will upon being contacted state which neighboring county has such a classification and provide such rate, such rate being deemed to exist by reference in this document. If no neighboring county rate applies to the task, the Department shall undertake a special determination, such special determination being then deemed to have existed under this determination. If a project requires these, or any classification not listed, please contact IDOL at 618/993-7271 for wage rates or clarifications.

#### LANDSCAPING

Landscaping work falls under the existing classifications for laborer, operating engineer and truck driver. The work performed by landscape plantsman and landscape laborer is covered by the existing classification of laborer. The work performed by landscape operators (regardless of equipment used or its size) is covered by the classifications of operating engineer. The work performed by landscape truck drivers (regardless of size of truck driven) is covered by the classifications of truck driver.

# Bond County Prevailing Wage for April 2007

Trade Name	RG	TYP	C	Base	FRMAN	*M-F>8	OSA	OSH	H/W	Pensn	Vac	Trng
=====	==	===	=	=====	=====	=====	===	===	=====	=====	=====	=====
ASBESTOS ABT-GEN		ALL		23.150	23.650	1.5	1.5	2.0	5.050	7.850	0.000	0.600
ASBESTOS ABT-MEC		BLD		25.290	26.290	1.5	1.5	2.0	4.450	2.500	0.000	0.250
BOILERMAKER		BLD		28.500	31.000	1.5	1.5	2.0	6.820	11.03	0.000	0.300
BRICK MASON		BLD		26.400	28.100	1.5	1.5	5.0	4.750	8.250	2.000	0.390
CARPENTER		ALL		30.480	31.980	1.5	1.5	2.0	5.050	3.750	0.000	0.350
CEMENT MASON		ALL		26.750	27.500	1.5	1.5	2.0	5.650	8.250	0.000	0.200
CERAMIC TILE FNSHER		BLD		22.610	0.000	1.5	1.5	2.0	5.000	4.300	0.000	0.400
ELECTRIC PWR EQMT OP		ALL		31.510	37.980	1.5	2.0	2.0	4.530	7.880	0.000	0.160
ELECTRIC PWR GRNDMAN		ALL		23.530	37.980	1.5	2.0	2.0	3.380	5.890	0.000	0.120
ELECTRIC PWR LINEMAN		ALL		36.220	37.980	1.5	2.0	2.0	5.210	9.060	0.000	0.180
ELECTRIC PWR TRK DRV		ALL		25.710	37.980	1.5	2.0	2.0	3.700	6.430	0.000	0.130
ELECTRICIAN	E	ALL		32.910	35.160	1.5	1.5	2.0	5.150	6.580	0.000	0.490
ELECTRICIAN	W	ALL		32.590	34.550	1.5	1.5	2.0	5.210	6.360	0.000	0.490
ELECTRONIC SYS TECH	E	BLD		25.700	27.200	1.5	1.5	2.0	5.150	3.340	0.000	0.250
ELECTRONIC SYS TECH	W	BLD		25.810	27.310	1.5	1.5	2.0	2.800	5.490	0.000	0.250
ELEVATOR CONSTRUCTOR		BLD		37.115	41.750	2.0	2.0	2.0	8.275	4.460	2.227	0.000
FLOOR LAYER		BLD		26.930	27.680	1.5	1.5	2.0	5.000	3.750	0.000	0.350
GLAZIER		BLD		29.480	0.000	2.0	2.0	2.0	8.550	6.920	2.360	0.160
HT/FROST INSULATOR		BLD		30.440	31.440	1.5	1.5	2.0	4.850	8.360	0.000	0.450
IRON WORKER		ALL		26.350	27.850	1.5	1.5	2.0	6.360	8.250	0.000	0.420
LABORER		ALL		22.650	23.150	1.5	1.5	2.0	5.050	7.850	0.000	0.600
MACHINIST		BLD		36.890	38.890	2.0	2.0	2.0	4.380	5.650	2.550	0.000
MARBLE FINISHERS		BLD		22.610	0.000	1.5	1.5	2.0	5.000	4.300	0.000	0.400
MARBLE MASON		BLD		26.400	28.100	1.5	1.5	5.0	4.750	8.250	2.000	0.390
MILLWRIGHT		ALL		30.480	31.980	1.5	1.5	2.0	5.050	3.750	0.000	0.350
OPERATING ENGINEER		ALL	1	25.900	27.030	1.5	1.5	2.0	6.200	11.45	0.000	1.000
OPERATING ENGINEER		ALL	2	24.770	27.030	1.5	1.5	2.0	6.200	11.45	0.000	1.000
OPERATING ENGINEER		ALL	3	20.290	27.030	1.5	1.5	2.0	6.200	11.45	0.000	1.000
OPERATING ENGINEER		ALL	4	20.350	27.030	1.5	1.5	2.0	6.200	11.45	0.000	1.000
OPERATING ENGINEER		ALL	5	20.020	27.030	1.5	1.5	2.0	6.200	11.45	0.000	1.000
OPERATING ENGINEER		ALL	6	26.450	27.030	1.5	1.5	2.0	6.200	11.45	0.000	1.000
OPERATING ENGINEER		ALL	7	26.750	27.030	1.5	1.5	2.0	6.200	11.45	0.000	1.000
OPERATING ENGINEER		ALL	8	27.030	27.030	1.5	1.5	2.0	6.200	11.45	0.000	1.000
PAINTER		BLD		25.700	26.700	1.5	1.5	2.0	4.650	5.150	0.000	0.350
PAINTER		HWY		26.800	27.800	1.5	1.5	2.0	4.650	5.150	0.000	0.350
PAINTER OVER 30FT		BLD		26.700	27.700	1.5	1.5	2.0	4.650	5.150	0.000	0.350
PAINTER PWR EQMT		BLD		26.700	27.700	1.5	1.5	2.0	4.650	5.150	0.000	0.350
PAINTER PWR EQMT		HWY		27.800	28.800	1.5	1.5	2.0	4.650	5.150	0.000	0.350
PILEDRIVER		ALL		30.480	31.980	1.5	1.5	2.0	5.050	3.750	0.000	0.350
PIPEFITTER		BLD		30.600	32.100	2.0	2.0	2.0	5.350	6.100	0.000	0.130
PLASTERER		BLD		27.000	28.000	1.5	1.5	2.0	5.650	7.250	0.000	0.250
PLUMBER		BLD		30.600	32.100	2.0	2.0	2.0	5.350	6.100	0.000	0.130
ROOFER		BLD		26.250	28.250	1.5	1.5	2.0	6.100	5.950	0.000	0.200
SHEETMETAL WORKER		ALL		27.210	28.460	1.5	1.5	2.0	6.000	4.770	1.630	0.120
SPRINKLER FITTER		BLD		31.240	33.240	1.5	1.5	2.0	6.500	5.350	0.000	0.250
TERRAZZO FINISHER		BLD		31.240	0.000	1.5	1.5	2.0	0.000	0.000	0.000	0.000
TERRAZZO MASON		BLD		30.780	31.080	1.5	1.5	2.0	0.000	3.750	0.000	0.000
TRUCK DRIVER		ALL	1	25.930	0.000	1.5	1.5	2.0	7.250	3.425	0.000	0.000
TRUCK DRIVER		ALL	2	26.330	0.000	1.5	1.5	2.0	7.250	3.425	0.000	0.000
TRUCK DRIVER		ALL	3	26.530	0.000	1.5	1.5	2.0	7.250	3.425	0.000	0.000
TRUCK DRIVER		ALL	4	26.780	0.000	1.5	1.5	2.0	7.250	3.425	0.000	0.000
TRUCK DRIVER		ALL	5	27.530	0.000	1.5	1.5	2.0	7.250	3.425	0.000	0.000
TRUCK DRIVER		O&C	1	20.740	0.000	1.5	1.5	2.0	7.250	3.425	0.000	0.000
TRUCK DRIVER		O&C	2	21.060	0.000	1.5	1.5	2.0	7.250	3.425	0.000	0.000
TRUCK DRIVER		O&C	3	21.220	0.000	1.5	1.5	2.0	7.250	3.425	0.000	0.000
TRUCK DRIVER		O&C	4	21.420	0.000	1.5	1.5	2.0	7.250	3.425	0.000	0.000
TRUCK DRIVER		O&C	5	22.020	0.000	1.5	1.5	2.0	7.250	3.425	0.000	0.000

Legend:

M-F>8 (Overtime is required for any hour greater than 8 worked each day, Monday through Friday.)

OSA (Overtime is required for every hour worked on Saturday)

OSH (Overtime is required for every hour worked on Sunday and Holidays)

H/W (Health & Welfare Insurance)

Pensn (Pension)

Vac (Vacation)

Trng (Training)

## Explanations

### BOND COUNTY

ELECTRICIANS AND ELECTRONIC SYSTEMS TECHNICIAN (EAST) - Townships of Mulberry Grove, Pleasant Mount & Tamalco.

ELECTRICIANS AND ELECTRONIC SYSTEMS TECHNICIAN (WEST) - Townships of Shoal Creek, LaGrange, Old Ripley, Central, Burgess & Mills

The following list is considered as those days for which holiday rates of wages for work performed apply: New Years Day, Memorial/Decoration Day, Fourth of July, Labor Day, Veterans Day, Thanksgiving Day, Christmas Day. Generally, any of these holidays which fall on a Sunday is celebrated on the following Monday. This then makes work performed on that Monday payable at the appropriate overtime rate for holiday pay. Common practice in a given local may alter certain days of celebration such as the day after Thanksgiving for Veterans Day. If in doubt, please check with IDOL.

Oil and chip resealing (O&C) means the application of road oils and liquid asphalt to coat an existing road surface, followed by application of aggregate chips or gravel to coated surface, and subsequent rolling of material to seal the surface.

### EXPLANATION OF CLASSES

ASBESTOS - GENERAL - removal of asbestos material/mold and hazardous materials from any place in a building, including mechanical systems where those mechanical systems are to be removed. This includes the removal of asbestos materials/mold and hazardous materials from ductwork or pipes in a building when the building is to be demolished at the time or at some close future date.

ASBESTOS - MECHANICAL - removal of asbestos material from mechanical systems, such as pipes, ducts, and boilers, where the mechanical systems are to remain.

### CERAMIC TILE FINISHER AND MARBLE FINISHER

The handling, at the building site, of all sand, cement, tile, marble or stone and all other materials that may be used and installed by [a] tile layer or marble mason. In addition, the grouting, cleaning, sealing, and mixing on the job site, and all other work as required in

assisting the setter. The term "Ceramic" is used for naming the classification only and is in no way a limitation of the product handled. Ceramic takes into consideration most hard tiles.

#### ELECTRONIC SYSTEMS TECHNICIAN

Installation, service and maintenance of low-voltage systems which utilizes the transmission and/or transference of voice, sound, vision, or digital for commercial, education, security and entertainment purposes for the following: TV monitoring and surveillance, background/foreground music, intercom and telephone interconnect, field programming, inventory control systems, microwave transmission, multi-media, multiplex, radio page, school, intercom and sound burglar alarms and low voltage master clock systems.

Excluded from this classification are energy management systems, life safety systems, supervisory controls and data acquisition systems not intrinsic with the above listed systems, fire alarm systems, nurse call systems and raceways exceeding fifteen feet in length.

#### TRUCK DRIVER - BUILDING, HEAVY AND HIGHWAY CONSTRUCTION

Class 1. Drivers on 2 axle trucks hauling less than 9 ton. Air compressor and welding machines and brooms, including those pulled by separate units, truck driver helpers, warehouse employees, mechanic helpers, greasers and tiremen, pickup trucks when hauling materials, tools, or workers to and from and on-the-job site, and fork lifts up to 6,000 lb. capacity.

Class 2. Two or three axle trucks hauling more than 9 ton but hauling less than 16 ton. A-frame winch trucks, hydrolift trucks, vector trucks or similar equipment when used for transportation purposes. Fork lifts over 6,000 lb. capacity, winch trucks, four axle combination units, and ticket writers.

Class 3. Two, three or four axle trucks hauling 16 ton or more. Drivers on water pulls, articulated dump trucks, mechanics and working forepersons, and dispatchers. Five axle or more combination units.

Class 4. Low Boy and Oil Distributors.

Class 5. Drivers who require special protective clothing while employed on hazardous waste work.

#### TRUCK DRIVER - OIL AND CHIP RESEALING ONLY.

This shall encompass laborers, workers and mechanics who drive contractor or subcontractor owned, leased, or hired pickup, dump, service, or oil distributor trucks. The work includes transporting materials and equipment (including but not limited to, oils, aggregate supplies, parts, machinery and tools) to or from the job site; distributing oil or liquid asphalt and aggregate; stock piling material when in connection with the actual oil and chip contract. The Truck Driver (Oil & Chip Resealing) wage classification does not include supplier delivered materials.

#### OPERATING ENGINEERS

GROUP I. Cranes, Dragline, Shovels, Skimmer Scoops, Clamshells or Derrick Boats, Pile Drivers, Crane-Type Backhoes, Asphalt Plant Operators, Concrete Plant Operators, Dredges, Asphalt Spreading Machines, All Locomotives, Cable Ways, or Tower Machines, Hoists,

Hydraulic Backhoes, Ditching Machines or Backfiller, Cherrypickers, Overhead Cranes, Roller, Steam or Gas, Concrete Pavers, Excavators, Concrete Breakers, Concrete Pumps, Bulk Cement Plants, Cement Pumps, Derrick-Type Drills, Boat Operators, Motor Graders or Pushcats, Scoops or Tournapulls, Bulldozers, Endloaders or Fork Lifts, Power Blade or Elevating Graders, Winch Cats, Boom or Winch Trucks or Boom Tractors, Pipe Wrapping or Painting Machines, Asphalt Plant Engineer, Journeyman Lubricating Engineer, Drills (other than Derrick Type), Mud Jacks, or Well Drilling Machines, Boring Machines or Track Jacks, Mixers, Conveyors (Two), Air Compressors (Two), Water Pumps regardless of size (Two), Welding Machines (Two), Siphons or Jets (Two), Winch Heads or Apparatuses (Two), Light Plants (Two), Waterblasters (two), All Tractors regardless of size (straight tractor only), Fireman on Stationary Boilers, Automatic Elevators, Form Grading Machines, Finishing Machines, Power Sub-Grader or Ribbon Machines, Longitudinal Floats, Distributor Operators on Trucks, Winch Heads or Apparatuses (One), Mobil Track air and heaters (two to five), Heavy Equipment Greaser, Relief Operator, Assistant Master Mechanic and Heavy Duty Mechanic, all Operators (except those listed below).

GROUP II. Assistant Operators.

GROUP III. Air Compressors (One), Water Pumps, regardless of Size (One), Waterblasters (one), Welding Machine (One), Mixers (One Bag), Conveyor (One), Siphon or Jet (One), Light Plant (One), Heater (One), Immobile Track Air (One), and Self Propelled Walk-Behind Rollers.

GROUP IV. Asphalt Spreader Oilers, Fireman on Whirlies and Heavy Equipment Oilers, Truck Cranes, Dredges, Monigans, Large Cranes - (Over 65-ton rated capacity) Concrete Plant Oiler, Blacktop Plant Oiler, and Creter Crane Oiler (when required).

GROUP V. Oiler.

GROUP VI. Master Mechanics, Operators on equipment with Booms, including jibs, 100 feet and over, and less than 150 feet long.

GROUP VII. Operators on equipment with Booms, including jibs, 150 feet and over, and less than 200 feet long.

GROUP VIII. Operators on Equipment with Booms, including jibs, 200 feet and over; Tower Cranes; Whirlie Cranes; and Operator Foreman.

TERRAZZO FINISHER

The handling of all materials used for Mosaic and Terrazzo work including preparing, mixing by hand, by mixing machine or transporting of pre-mixed materials and distributing with shovel, rake, hoe, or pail, all kinds of concrete foundations necessary for Mosaic and Terrazzo work, all cement terrazzo, magnesite terrazzo, Do-O-Tex terrazzo, epoxy matrix ter-razzo, exposed aggregate, rustic or rough washed for exterior or interior of buildings placed either by machine or by hand, and any other kind of mixture of plastics composed of chips or granules when mixed with cement, rubber, neoprene, vinyl, magnesium chloride or any other resinous or chemical substances used for seamless flooring systems, and all other building materials, all similar materials and all precast terrazzo work on jobs, all scratch coat used for Mosaic and Terrazzo work and sub-bed, tar paper and wire mesh (2x2 etc.) or lath. The rubbing, grinding, cleaning and finishing of same either by hand or by machine or by terrazzo resurfacing equipment on new or existing floors. When necessary finishers shall be allowed to assist the mechanics to spread sand bed, lay tarpaper and wire mesh (2x2 etc.) or lath. The finishing of

cement floors where additional aggregate of stone is added by spreading or sprinkling on top of the finished base, and troweled or rolled into the finish and then the surface is ground by grinding machines.

#### Other Classifications of Work:

For definitions of classifications not otherwise set out, the Department generally has on file such definitions which are available. If a task to be performed is not subject to one of the classifications of pay set out, the Department will upon being contacted state which neighboring county has such a classification and provide such rate, such rate being deemed to exist by reference in this document. If no neighboring county rate applies to the task, the Department shall undertake a special determination, such special determination being then deemed to have existed under this determination. If a project requires these, or any classification not listed, please contact IDOL at 618/993-7271 for wage rates or clarifications.

#### LANDSCAPING

Landscaping work falls under the existing classifications for laborer, operating engineer and truck driver. The work performed by landscape plantsman and landscape laborer is covered by the existing classification of laborer. The work performed by landscape operators (regardless of equipment used or its size) is covered by the classifications of operating engineer. The work performed by landscape truck drivers (regardless of size of truck driven) is covered by the classifications of truck driver.



# Boone County Prevailing Wage for April 2007

Trade Name	RG	TYP	C	Base	FRMAN	*M-F>8	OSA	OSH	H/W	Pensn	Vac	Trng
=====	==	==	=	=====	=====	=====	==	==	=====	=====	=====	=====
ASBESTOS ABT-GEN		ALL		31.550	32.300	1.5	1.5	2.0	7.460	4.840	0.000	0.170
ASBESTOS ABT-MEC		BLD		22.750	24.250	1.5	1.5	2.0	3.390	5.170	0.000	0.000
BOILERMAKER		BLD		38.540	42.000	2.0	2.0	2.0	6.720	7.440	0.000	0.300
BRICK MASON		BLD		30.500	33.000	1.5	1.5	2.0	5.500	8.680	0.000	0.420
CARPENTER		BLD		30.230	33.560	1.5	1.5	2.0	5.500	7.450	0.000	0.600
CARPENTER		HWY		28.010	29.760	1.5	1.5	2.0	5.500	8.000	0.000	0.310
CEMENT MASON		ALL		30.250	32.750	1.5	1.5	2.0	5.500	7.550	0.000	0.100
CERAMIC TILE FNSHER		BLD		24.860	0.000	1.5	1.5	2.0	5.500	4.000	0.000	0.360
COMMUNICATION TECH		BLD		28.700	30.700	1.5	1.5	2.0	8.200	8.340	0.000	0.570
ELECTRIC PWR EQMT OP		ALL		27.920	35.880	1.5	1.5	2.0	4.750	7.820	0.000	0.210
ELECTRIC PWR GRNDMAN		ALL		21.640	35.880	1.5	1.5	2.0	4.750	6.060	0.000	0.160
ELECTRIC PWR LINEMAN		ALL		33.220	35.880	1.5	1.5	2.0	4.750	9.310	0.000	0.250
ELECTRIC PWR TRK DRV		ALL		22.340	35.880	1.5	1.5	2.0	4.750	6.260	0.000	0.170
ELECTRICIAN		BLD		33.570	36.930	1.5	1.5	2.0	8.200	11.15	0.000	0.670
ELEVATOR CONSTRUCTOR		BLD		38.620	43.450	2.0	2.0	2.0	8.275	6.060	2.320	0.000
GLAZIER		BLD		27.680	28.680	1.5	1.5	2.0	6.400	6.500	0.000	0.500
HT/FROST INSULATOR		BLD		29.630	31.850	1.5	1.5	2.0	6.000	8.720	0.000	0.000
IRON WORKER		ALL		30.760	32.300	2.0	2.0	2.0	6.950	16.62	0.000	0.550
LABORER		ALL		31.550	32.300	1.5	1.5	2.0	7.200	5.100	0.000	0.170
LATHER		BLD		30.230	33.560	1.5	1.5	2.0	5.500	7.450	0.000	0.600
MACHINIST		BLD		36.890	38.890	2.0	2.0	2.0	4.380	5.650	2.550	0.000
MARBLE FINISHERS		BLD		24.860	0.000	1.5	1.5	2.0	5.500	4.000	0.000	0.360
MARBLE MASON		BLD		28.140	28.390	1.5	1.5	2.0	5.500	5.220	0.000	0.380
MATERIAL TESTER 1		ALL		21.550	0.000	1.5	1.5	2.0	7.460	4.840	0.000	0.170
MATERIALS TESTER II		ALL		26.550	0.000	1.5	1.5	2.0	7.460	4.840	0.000	0.170
MILLWRIGHT		BLD		32.150	35.370	1.5	1.5	2.0	5.150	9.450	0.000	0.560
OPERATING ENGINEER		BLD	1	37.050	41.050	2.0	2.0	2.0	6.850	6.150	1.900	0.700
OPERATING ENGINEER		BLD	2	36.350	41.050	2.0	2.0	2.0	6.850	6.150	1.900	0.700
OPERATING ENGINEER		BLD	3	33.900	41.050	2.0	2.0	2.0	6.850	6.150	1.900	0.700
OPERATING ENGINEER		BLD	4	31.900	41.050	2.0	2.0	2.0	6.850	6.150	1.900	0.700
OPERATING ENGINEER		HWY	1	36.900	40.900	1.5	1.5	2.0	6.850	6.150	1.900	0.700
OPERATING ENGINEER		HWY	2	36.350	40.900	1.5	1.5	2.0	6.850	6.150	1.900	0.700
OPERATING ENGINEER		HWY	3	35.050	40.900	1.5	1.5	2.0	6.850	6.150	1.900	0.700
OPERATING ENGINEER		HWY	4	33.600	40.900	1.5	1.5	2.0	6.850	6.150	1.900	0.700
OPERATING ENGINEER		HWY	5	32.150	40.900	1.5	1.5	2.0	6.850	6.150	1.900	0.700
PAINTER		ALL		29.650	30.650	1.5	1.5	1.5	5.650	5.750	0.000	0.350
PAINTER SIGNS		BLD		28.970	32.520	1.5	1.5	1.5	2.600	2.310	0.000	0.000
PILEDRIVER		BLD		31.230	34.670	1.5	1.5	2.0	5.500	7.450	0.000	0.600
PILEDRIVER		HWY		28.010	29.760	1.5	1.5	2.0	5.500	8.000	0.000	0.310
PIPEFITTER		BLD		33.700	36.060	1.5	1.5	2.0	6.430	7.130	0.000	0.630
PLASTERER		BLD		29.540	32.490	1.5	1.5	2.0	5.500	7.350	0.000	0.100
PLUMBER		BLD		33.700	36.060	1.5	1.5	2.0	6.430	7.130	0.000	0.630
ROOFER		BLD		33.650	35.650	1.5	1.5	2.0	6.460	3.310	0.000	0.330
SHEETMETAL WORKER		BLD		31.690	33.620	1.5	1.5	2.0	4.850	10.29	0.520	0.290
SPRINKLER FITTER		BLD		31.240	33.240	1.5	1.5	2.0	6.500	5.350	0.000	0.250
STONE MASON		BLD		30.500	33.000	1.5	1.5	2.0	5.500	8.680	0.000	0.420
TERRAZZO FINISHER		BLD		24.860	0.000	1.5	1.5	2.0	5.500	4.000	0.000	0.360
TERRAZZO MASON		BLD		28.140	28.390	1.5	1.5	2.0	5.500	5.220	0.000	0.380
TILE LAYER		BLD		30.230	33.560	1.5	1.5	2.0	5.500	7.450	0.000	0.600
TILE MASON		BLD		28.140	28.390	1.5	1.5	2.0	5.500	5.220	0.000	0.380
TRUCK DRIVER		ALL	1	25.880	26.430	1.5	1.5	2.0	5.150	6.500	0.000	0.000
TRUCK DRIVER		ALL	2	26.030	26.430	1.5	1.5	2.0	5.150	6.500	0.000	0.000
TRUCK DRIVER		ALL	3	26.230	26.430	1.5	1.5	2.0	5.150	6.500	0.000	0.000
TRUCK DRIVER		ALL	4	26.430	26.430	1.5	1.5	2.0	5.150	6.500	0.000	0.000
TUCKPOINTER		BLD		30.500	33.000	1.5	1.5	2.0	5.500	8.680	0.000	0.420

Legend:

M-F>8 (Overtime is required for any hour greater than 8 worked each day, Monday through Friday.)

OSA (Overtime is required for every hour worked on Saturday)

OSH (Overtime is required for every hour worked on Sunday and Holidays)

H/W (Health & Welfare Insurance)

Pensn (Pension)

Vac (Vacation)

Trng (Training)

## Explanations

### BOONE COUNTY

The following list is considered as those days for which holiday rates of wages for work performed apply: new Years Day, Memorial/Decoration Day, Fourth of July, Labor Day, Veterans Day, Thanksgiving Day, Christmas Day. Generally, any of these holidays which fall on a Sunday is celebrated on the following Monday. This then makes work performed on that Monday payable at the appropriate overtime rate for holiday pay. Common practice in a given local may alter certain days of celebration such as the day after Thanksgiving for Veterans Day. If in doubt, please check with IDOL.

### EXPLANATION OF CLASSES

ASBESTOS - GENERAL - removal of asbestos material/mold and hazardous materials from any place in a building, including mechanical systems where those mechanical systems are to be removed. This includes the removal of asbestos materials/mold and hazardous materials from ductwork or pipes in a building when the building is to be demolished at the time or at some close future date.

ASBESTOS - MECHANICAL - removal of asbestos material from mechanical systems, such as pipes, ducts, and boilers, where the mechanical systems are to remain.

### CERAMIC TILE FINISHER, MARBLE FINISHER, TERRAZZO FINISHER

Assisting, helping or supporting the tile, marble and terrazzo mechanic by performing their historic and traditional work assignments required to complete the proper installation of the work covered by said crafts. The term "Ceramic" is used for naming the classification only and is in no way a limitation of the product handled. Ceramic takes into consideration most hard tiles.

### COMMUNICATION TECHNICIAN

Installing, manufacturing, assembling and maintaining sound and intercom, protection alarm (security), fire alarm, master antenna television, closed circuit television, low voltage control for computers and/or door monitoring, school communications systems, telephones and servicing of nurse and emergency calls, and the

installation and maintenance of transmit and receive antennas, transmitters, receivers, and associated apparatus which operates in conjunction with above systems. All work associated with these system installations will be included EXCEPT the installation of protective metallic conduit in new construction projects (excluding less than ten-foot runs strictly for protection of cable) and 120 volt AC (or higher) power wiring and associated hardware.

#### TRUCK DRIVER - BUILDING, HEAVY AND HIGHWAY CONSTRUCTION

Class 1. Two or three Axle Trucks. A-frame Truck when used for transportation purposes; Air Compressors and Welding Machines, including those pulled by cars, pick-up trucks and tractors; Ambulances; Batch Gate Lockers; Batch Hopperman; Car and Truck Washers; Carry-alls; Fork Lifts and Hoisters; Helpers; Mechanics Helpers and Greasers; Oil Distributors 2-man operation; Pavement Breakers; Pole Trailer, up to 40 feet; Power Mower Tractors; Self-propelled Chip Spreader; Skipman; Slurry Trucks, 2-man operation; Slurry Truck Conveyor Operation, 2 or 3 man; Teamsters; Unskilled dumpman; and Truck Drivers hauling warning lights, barricades, and portable toilets on the job site.

Class 2. Four axle trucks; Dump Crets and Adgetors under 7 yards; Dumpsters, Track Trucks, Euclids, Hug Bottom Dump Turnapulls or Turnatrailers when pulling other than self-loading equipment or similar equipment under 16 cubic yards; Mixer Trucks under 7 yards; Ready-mix Plant Hopper Operator, and Winch Trucks, 2 Axles.

Class 3. Five axle trucks; Dump Crets and Adgetors 7 yards and over; Dumpsters, Track Trucks, Euclids, Hug Bottom Dump Turnatrailers or turnapulls when pulling other than self-loading equipment or similar equipment over 16 cubic yards; Explosives and/or Fission Material Trucks; Mixer Trucks 7 yards or over; Mobile Cranes while in transit; Oil Distributors, 1-man operation; Pole Trailer, over 40 feet; Pole and Expandable Trailers hauling material over 50 feet long; Slurry trucks, 1-man operation; Winch trucks, 3 axles or more; Mechanic--Truck Welder and Truck Painter.

Class 4. Six axle trucks; Dual-purpose vehicles, such as mounted crane trucks with hoist and accessories; Foreman; Master Mechanic; Self-loading equipment like P.B. and trucks with scoops on the front.

MATERIAL TESTER I: Hand coring and drilling for testing of materials; field inspection of uncured concrete and asphalt.

MATERIAL TESTER II: Field inspection of welds, structural steel, fireproofing, masonry, soil, facade, reinforcing steel, formwork, cured concrete, and concrete and asphalt batch plants; adjusting proportions of bituminous mixtures.

#### OPERATING ENGINEERS - BUILDING

Class 1. Assistant Craft Foreman; Craft Foreman; Mechanic; Asphalt Plant; Asphalt Spreader; Autograde; Batch Plant; Benoto (requires Two Engineers); Boiler and Throttle Valve; Caisson Rigs; Central Redi-Mix Plant; Combination Back Hoe Front End-loader Machine; Compressor and Throttle Valve; Concrete Breaker (Truck Mounted); Concrete Conveyor; Concrete Paver; Concrete Placer; Concrete Pump (Truck Mounted); Concrete Tower, Cranes, All, Cranes, Hammerhead, Creter Crane; Crusher, Stone, etc.; Derricks, All; Derricks, Traveling; Formless Curb and Gutter Machine; Grader, Elevating; Grouting Machines; Highlift Shovels or Front Endloader 2-1/4 yd. and over; Hoists, Elevators, outside type rack and pinion and similar machines; Hoists,

one, two and three Drum; Hoists, Two tigger One Floor; Hydraulic Backhoes; Hydraulic Boom Trucks; Locomotives, All; Motor Patrol; Pile Drivers and Skid Rig; Post Hole Digger; Pre-Stress Machine; Pump Cretes; Squeeze Cretes-screw Type Pumps; Gypsum Bulker and Pump; Raised and Blind Hole Drill; Rock Drill; Roto Mill Grinder; Scoops - Tractor Drawn; Slip-form Paver; Straddle Buggies; Tie Back Machine; Tractor with Book and Side Boom; Trenching Machines.

Class 2. Bobcat (over 3/4 cu. yd.); Boilers Brick Forklift; Broom, All Power Propelled; Bulldozers; Concrete Mixer (Two Bag and Over); Conveyor, Portable; Forklift Trucks; Greaser Engineer; Highlift Shovels or Front Endloaders under 2-1/4 yd.; Hoists, Automatic; Hoists, Sewer Dragging Machine; Hoists, Tigger Single Drum; Rollers, All; Steam Generators; Tractors, All; Tractor Drawn Vibratory Roller; Winch Trucks with "A" Frame.

Class 3. Air Compressor; Asphalt Spreader; Combination - Small Equipment Operator; Generators; Heaters, Mechanical; Hoists, Inside Elevators - (Rheostat Manual Controlled); Hydraulic Power Units (Pile Driving and Extracting); Pumps, over 3" (1 to 3 not to exceed a total of 300 ft.); Pumps, Well Points; Welding Machines (2 through 5); Winches, 4 small Electric Drill Winches; Bobcat (up to and including 3/4 cu. yd.).

Class 4. Hoists, Inside Elevators, Push Button with Automatic Doors; Oilers; Brick Forklift.

#### OPERATING ENGINEERS - HEAVY AND HIGHWAY CONSTRUCTION

Class 1. Craft Foreman; Asphalt Plant, Asphalt Heater and Planer Combination; Asphalt Heater Scarfire; Asphalt Silo Tender; Asphalt Spreader; Autograder; ABG Paver; Backhoes with Caisson attachment; Ballast Regulator, Belt Loader; Caisson Rigs; Car Dumper; Central Redi-Mix Plant; Backhoe w/shear attachments; Combination Backhoe Front Endloader Machine, (1 cu. yd. Backhoe Bucket or over or with attachments); Concrete Breaker (Truck Mounted); Concrete Conveyor; Concrete Paver over 27E cu. ft.; Concrete Placer; Concrete Tube Float; Cranes, all attachments; Cranes, Hammerhead, Linden, Peco & Machines of a like nature; Crete Crane; Crusher, Stone, etc.; Derricks, All; Derrick Boats; Derricks, Traveling; Directional Boring Machine over 12"; Dredges; Field Mechanic-Welder; Formless Curb and Gutter Machine; Gradall and Machines of a like nature; Grader, Elevating; Grader, Motor Grader, Motor Patrol, Auto Patrol, Form Grader, Pull Grader, Subgrader; Guard Rail Post Driver Mounted; Hoists, One, Two and Three Drum; Hydraulic Backhoes; Pile Drivers and Skid Rig; Pre-Stress Machine; Pump Cretes Dual Ram; Rock Drill - Crawler or Skid Rig; Rock Drill - Truck Mounted; Rock/Track Tamper; Roto Mill Grinder; Slip-Form Paver; Soil Test Drill Rig (Truck Mounted); Straddle Buggies; GCI Crane; Hydraulic Telescoping form (Tunnel); Tie Back Machine; Tractor Drawn Belt Loader; Tractor with Boom; Tractor-aire with Attachments; Traffic Barrier conveyor machine; Raised or Blind Hole; Trenching Machine; Truck Mounted Concrete Pump with Boom; Truck Mounted Concrete Conveyor; Underground Boring and/or Mining Machines; Wheel Excavator; Widener (APSCO).

Class 2. Batch Plant; Bituminous Mixer; Boiler and Throttle Valve; Bulldozers; Car Loader Trailing Conveyors; Combination Backhoe Front Endloader Machine (less than 1 cu. yd. Backhoe Bucket or over or with attachments); Compressor and Throttle Valve; Compressor, Common Receiver (3); Concrete Breaker or Hydro Hammer; Concrete Grinding Machine; Concrete Mixer or Paver 7S Series to and including 27 cu. ft.; Concrete Spreader; Concrete Curing Machine, Burlap Machine, Belting Machine and Sealing Machine; Conveyor Muck Cars (Haglund or

Similar Type); Drills, all; Finishing Machine - Concrete; Greaser Engineer; Highlift Shovels or Front Endloader; Hoist - Sewer Dragging Machine; Hydraulic Boom Trucks (All Attachments); Hydro Blaster; Laser Screed; All Locomotives, Dinky; Pump Cretes; Squeeze Cretes-Screw Type Pumps, Gypsum Bulker and Pump; Roller, Asphalt; Rotary Snow Plows; Rototiller, Seaman, etc., self-propelled; Scoops - Tractor Drawn; Self-Propelled Compactor; Spreader - Chip - Stone, etc.; Scraper; Scraper - Prime Mover in Tandem (Regardless of Size); Tank Car Heater; Tractors, Push, Pulling Sheeps Foot, Disc, Compactor, etc. Tug Boats.

Class 3. Boilers; Brooms, All Power Propelled; Cement Supply Tender; Compressor, Common Receiver (2); Concrete Mixer (Two Bag and Over); Conveyor, Portable; Farm-Type Tractors Used for Mowing, Seeding, etc.; Fireman on Boilers; Forklift Trucks; Grouting Machine; Hoists, Automatic; Hoists, All Elevators; Hoists, Tugger Single Drum; Jeep Diggers, Low Boys; Pipe Jacking Machines; Post-Hole Digger; Power Saw, Concrete Power Driven; Pug Mills; Rollers, other than asphalt; Seed and Straw Blower; Steam Generators; Stump Machine; Winch Trucks with "A" Frame; Work Boats; Tamper - Form-Motor Driven.

Class 4. Air Compressor - Small and Large; Asphalt Spreader, Backend Man; Bobcat (Skid Steer) all; Combination - Small Equipment Operator; Directional Boring Machine up to 12"; Generators - Small 50kw and Under; Generators - Large over 50kw; Heaters, Mechanical; Hydraulic Power Unit (Pile Driving, Extracting, or Drilling); Hydro-Blaster; Light Plants, All (1 through 5); Pumps, over 3" (1 to 3 not to exceed a total of 300 ft.); Pumps, Well Points; Tract-aire; Welding Machines (2 through 5); Winches, 4 Small Electric Drill Winches.

Class 5. Oilers and Directional Boring Machine Locator.

Other Classifications of Work:

For definitions of classifications not otherwise set out, the Department generally has on file such definitions which are available. If a task to be performed is not subject to one of the classifications of pay set out, the Department will upon being contacted state which neighboring county has such a classification and provide such rate, such rate being deemed to exist by reference in this document. If no neighboring county rate applies to the task, the Department shall undertake a special determination, such special determination being then deemed to have existed under this determination. If a project requires these, or any classification not listed, please contact IDOL at 618/993-7271 for wage rates or clarifications.

#### LANDSCAPING

Landscaping work falls under the existing classifications for laborer, operating engineer and truck driver. The work performed by landscape plantsman and landscape laborer is covered by the existing classification of laborer. The work performed by landscape operators (regardless of equipment used or its size) is covered by the classifications of operating engineer. The work performed by landscape truck drivers (regardless of size of truck driven) is covered by the classifications of truck driver.

# Brown County Prevailing Wage for April 2007

Trade Name	RG	TYP	C	Base	FRMAN	*M-F>8	OSA	OSH	H/W	Pensn	Vac	Trng
=====	==	==	=	=====	=====	=====	==	==	=====	=====	=====	=====
ASBESTOS ABT-GEN		BLD		22.260	23.260	1.5	1.5	2.0	5.300	6.030	0.000	0.600
ASBESTOS ABT-MEC		BLD		25.290	26.290	1.5	1.5	2.0	4.450	2.500	0.000	0.250
BOILERMAKER		BLD		28.500	31.000	1.5	1.5	2.0	6.820	11.03	0.000	0.300
BRICK MASON		BLD		24.370	25.370	1.5	1.5	2.0	6.000	5.400	0.000	0.490
CARPENTER		BLD		24.490	26.490	1.5	1.5	2.0	6.500	7.900	0.000	0.320
CARPENTER		HWY		24.250	26.000	1.5	1.5	2.0	6.500	7.800	0.000	0.300
CEMENT MASON		BLD		22.800	23.800	1.5	1.5	2.0	5.200	8.080	0.000	0.150
CEMENT MASON		HWY		22.170	23.170	1.5	1.5	2.0	5.200	7.300	0.000	0.250
CERAMIC TILE FNSHER		BLD		23.020	0.000	1.5	1.5	2.0	6.000	5.400	0.000	0.000
ELECTRIC PWR EQMT OP		ALL		30.750	0.000	1.5	1.5	2.0	4.750	8.610	0.000	0.000
ELECTRIC PWR GRNDMAN		ALL		21.090	0.000	1.5	1.5	2.0	4.750	5.905	0.000	0.000
ELECTRIC PWR LINEMAN		ALL		34.160	36.350	1.5	1.5	2.0	4.750	9.560	0.000	0.000
ELECTRIC PWR TRK DRV		ALL		22.130	0.000	1.5	1.5	2.0	4.750	6.200	0.000	0.000
ELECTRICIAN		BLD		25.290	27.290	1.5	1.5	2.0	5.150	6.460	0.000	0.250
ELECTRONIC SYS TECH		BLD		23.850	25.350	1.5	1.5	2.0	5.150	5.625	0.000	0.250
ELEVATOR CONSTRUCTOR		BLD		34.190	38.460	2.0	2.0	2.0	8.275	6.060	2.050	0.000
GLAZIER		BLD		27.130	28.130	1.5	2.0	2.0	5.430	4.000	0.000	0.280
HT/FROST INSULATOR		BLD		30.440	31.440	1.5	1.5	2.0	4.850	8.360	0.000	0.450
IRON WORKER		BLD		25.400	27.150	1.5	1.5	2.0	5.860	7.900	0.000	0.300
IRON WORKER		HWY		25.400	26.900	1.5	1.5	2.0	5.860	7.900	0.000	0.300
LABORER		BLD		20.760	21.760	1.5	1.5	2.0	5.300	6.030	0.000	0.600
LABORER		HWY		21.680	22.430	1.5	1.5	2.0	5.300	6.030	0.000	0.600
LATHER		BLD		24.490	26.490	1.5	1.5	2.0	6.500	7.900	0.000	0.320
MACHINIST		BLD		36.890	38.890	2.0	2.0	2.0	4.380	5.650	2.550	0.000
MARBLE FINISHERS		BLD		23.020	0.000	1.5	1.5	2.0	6.000	5.400	0.000	0.000
MARBLE MASON		BLD		24.520	25.270	1.5	1.5	2.0	6.000	5.400	0.000	0.000
MILLWRIGHT		BLD		26.000	28.000	1.5	1.5	2.0	6.500	6.850	0.000	0.320
MILLWRIGHT		HWY		19.070	20.320	1.5	1.5	2.0	2.800	3.000	0.000	0.000
OPERATING ENGINEER		BLD	1	26.550	0.000	1.5	1.5	2.0	6.150	6.200	0.000	0.850
OPERATING ENGINEER		BLD	2	24.200	0.000	1.5	1.5	2.0	6.150	6.200	0.000	0.850
OPERATING ENGINEER		BLD	3	20.600	0.000	1.5	1.5	2.0	6.150	6.200	0.000	0.850
OPERATING ENGINEER		BLD	4	28.050	0.000	1.5	1.5	2.0	6.150	6.200	0.000	0.850
OPERATING ENGINEER		HWY	1	26.800	0.000	1.5	1.5	2.0	6.150	6.200	0.000	0.850
OPERATING ENGINEER		HWY	2	24.030	0.000	1.5	1.5	2.0	6.150	6.200	0.000	0.850
OPERATING ENGINEER		HWY	3	19.800	0.000	1.5	1.5	2.0	6.150	6.200	0.000	0.850
OPERATING ENGINEER		HWY	4	28.300	0.000	1.5	1.5	2.0	6.150	6.200	0.000	0.850
PAINTER		ALL		25.390	26.390	1.5	1.5	2.0	4.650	5.500	0.000	0.250
PAINTER OVER 30FT		ALL		26.390	27.390	1.5	1.5	2.0	4.650	5.500	0.000	0.250
PAINTER PWR EQMT		ALL		26.390	27.390	1.5	1.5	2.0	4.650	5.500	0.000	0.250
PILEDRIVER		BLD		24.990	26.990	1.5	1.5	2.0	6.500	7.900	0.000	0.320
PILEDRIVER		HWY		24.750	26.500	1.5	1.5	2.0	6.500	7.800	0.000	0.300
PIPEFITTER		ALL		30.520	33.570	1.5	1.5	2.0	4.800	7.960	0.000	0.530
PLUMBER		ALL		30.520	33.570	1.5	1.5	2.0	4.800	7.960	0.000	0.530
ROOFER		BLD		24.200	25.200	1.5	1.5	2.0	5.350	6.550	0.000	0.150
SHEETMETAL WORKER		BLD		27.820	29.570	1.5	1.5	2.0	7.150	7.880	0.000	0.350
SPRINKLER FITTER		BLD		31.240	33.240	1.5	1.5	2.0	6.500	5.350	0.000	0.250
STONE MASON		BLD		24.370	25.370	1.5	1.5	2.0	6.000	5.400	0.000	0.490
TERRAZZO FINISHER		BLD		23.020	0.000	1.5	1.5	2.0	6.000	5.400	0.000	0.000
TERRAZZO MASON		BLD		24.520	25.270	1.5	1.5	2.0	6.000	5.400	0.000	0.000
TILE MASON		BLD		24.520	25.270	1.5	1.5	2.0	6.000	5.400	0.000	0.000
TRUCK DRIVER		ALL	1	25.930	0.000	1.5	1.5	2.0	7.250	3.425	0.000	0.000
TRUCK DRIVER		ALL	2	26.330	0.000	1.5	1.5	2.0	7.250	3.425	0.000	0.000
TRUCK DRIVER		ALL	3	26.530	0.000	1.5	1.5	2.0	7.250	3.425	0.000	0.000
TRUCK DRIVER		ALL	4	26.780	0.000	1.5	1.5	2.0	7.250	3.425	0.000	0.000
TRUCK DRIVER		ALL	5	27.530	0.000	1.5	1.5	2.0	7.250	3.425	0.000	0.000
TRUCK DRIVER		O&C	1	20.740	0.000	1.5	1.5	2.0	7.250	3.425	0.000	0.000
TRUCK DRIVER		O&C	2	21.060	0.000	1.5	1.5	2.0	7.250	3.425	0.000	0.000
TRUCK DRIVER		O&C	3	21.220	0.000	1.5	1.5	2.0	7.250	3.425	0.000	0.000

TRUCK DRIVER	O&C 4	21.420	0.000	1.5	1.5	2.0	7.250	3.425	0.000	0.000
TRUCK DRIVER	O&C 5	22.020	0.000	1.5	1.5	2.0	7.250	3.425	0.000	0.000
TUCKPOINTER	BLD	25.470	26.970	1.5	1.5	2.0	6.000	5.400	0.000	0.425

Legend:

M-F>8 (Overtime is required for any hour greater than 8 worked each day, Monday through Friday.)

OSA (Overtime is required for every hour worked on Saturday)

OSH (Overtime is required for every hour worked on Sunday and Holidays)

H/W (Health & Welfare Insurance)

Pensn (Pension)

Vac (Vacation)

Trng (Training)

## Explanations

BROWN COUNTY

The following list is considered as those days for which holiday rates of wages for work performed apply: New Years Day, Memorial/Decoration Day, Fourth of July, Labor Day, Veterans Day, Thanksgiving Day, Christmas Day. Generally, any of these holidays which fall on a Sunday is celebrated on the following Monday. This then makes work performed on that Monday payable at the appropriate overtime rate for holiday pay. Common practice in a given local may alter certain days of celebration such as the day after Thanksgiving for Veterans Day. If in doubt, please check with IDOL.

Oil and chip resealing (O&C) means the application of road oils and liquid asphalt to coat an existing road surface, followed by application of aggregate chips or gravel to coated surface, and subsequent rolling of material to seal the surface.

### EXPLANATION OF CLASSES

ASBESTOS - GENERAL - removal of asbestos material/mold and hazardous materials from any place in a building, including mechanical systems where those mechanical systems are to be removed. This includes the removal of asbestos materials/mold and hazardous materials from ductwork or pipes in a building when the building is to be demolished at the time or at some close future date.

ASBESTOS - MECHANICAL - removal of asbestos material from mechanical systems, such as pipes, ducts, and boilers, where the mechanical systems are to remain.

### CERAMIC TILE FINISHER, MARBLE FINISHER, TERRAZZO FINISHER

Assisting, helping or supporting the tile, marble and terrazzo mechanic by performing their historic and traditional work assignments required to complete the proper installation of the work covered by said crafts. The term "Ceramic" is used for naming the classification

only and is in no way a limitation of the product handled. Ceramic takes into consideration most hard tiles.

#### ELECTRONIC SYSTEMS TECHNICIAN

Installation, service and maintenance of low-voltage systems which utilizes the transmission and/or transference of voice, sound, vision, or digital for commercial, education, security and entertainment purposes for the following: TV monitoring and surveillance, background/foreground music, intercom and telephone interconnect, field programming, inventory control systems, microwave transmission, multi-media, multiplex, radio page, school, intercom and sound burglar alarms and low voltage master clock systems.

Excluded from this classification are energy management systems, life safety systems, supervisory controls and data acquisition systems not intrinsic with the above listed systems, fire alarm systems, nurse call systems and raceways exceeding fifteen feet in length.

#### TRUCK DRIVER - BUILDING, HEAVY AND HIGHWAY CONSTRUCTION

Class 1. Drivers on 2 axle trucks hauling less than 9 ton. Air compressor and welding machines and brooms, including those pulled by separate units, truck driver helpers, warehouse employees, mechanic helpers, greasers and tiremen, pickup trucks when hauling materials, tools, or workers to and from and on-the-job site, and fork lifts up to 6,000 lb. capacity.

Class 2. Two or three axle trucks hauling more than 9 ton but hauling less than 16 ton. A-frame winch trucks, hydrolift trucks, vactor trucks or similar equipment when used for transportation purposes. Fork lifts over 6,000 lb. capacity, winch trucks, four axle combination units, and ticket writers.

Class 3. Two, three or four axle trucks hauling 16 ton or more. Drivers on water pulls, articulated dump trucks, mechanics and working forepersons, and dispatchers. Five axle or more combination units.

Class 4. Low Boy and Oil Distributors.

Class 5. Drivers who require special protective clothing while employed on hazardous waste work.

#### TRUCK DRIVER - OIL AND CHIP RESEALING ONLY.

This shall encompass laborers, workers and mechanics who drive contractor or subcontractor owned, leased, or hired pickup, dump, service, or oil distributor trucks. The work includes transporting materials and equipment (including but not limited to, oils, aggregate supplies, parts, machinery and tools) to or from the job site; distributing oil or liquid asphalt and aggregate; stock piling material when in connection with the actual oil and chip contract. The Truck Driver (Oil & Chip Resealing) wage classification does not include supplier delivered materials.

#### OPERATING ENGINEERS - BUILDING

CLASS 1. Asphalt Screed Man; Aspco Concrete Spreaders; Asphalt Pavers; Asphalt Plant Engineer; Asphalt Rollers on Bituminous



Concrete; Athey Loaders; Backfillers, Crane Type; Backhoes; Barber Green Loaders; Bulldozers; Cableways; Cherry Pickers; Clam Shells; C.M.I. & similar type autograde formless paver, autograde placer & finisher; Concrete Breakers; Concrete Pumps; Derricks; Derrick Boats; Draglines; Earth Auger or Boring Machines; Elevating Graders; Engineers on Dredges; Gravel Processing Machines; Head Equipment Greaser; High Lifts or Fork Lifts; Hoists with two or more drums or two or more load lines; Locomotives, All; Mechanics; Motor Graders or Auto Patrols; Operators or Leverman on Dredges; Operators, Power Boat; Operators, Pug Mill (Asphalt Plants); Orange Peels; Overhead Cranes; Paving Mixers; Piledrivers; Pipe Wrapping and Painting Machines; Pushdozers, or Push Cats; Robotic Controlled Equipment in this Classification; Rock Crushers; Ross Carrier or Similar Machines; Rotomill; Scoops, Skimmer, two cu. yd. capacity and under; Scoops, All or Tournapull; Sheep-Foot Roller (Self Propelled); Shovels; Skid Steer; Skimmer Scoops; Temporary Concrete Plant Operators; Test Hole Drilling Machines; Tower Machines; Tower Mixers; Track Type End Loaders; Track Type Fork Lifts or High Lifts; Track Jacks and Tampers; Tractors, Sideboom; Trenching or Ditching Machine; Tunnelluggers; Vermeer Type Saws; Water Blaster Cutting Head; Wheel Type End Loaders; Winch Cat.

CLASS 2. Air Compressors (six to eight)\*; Asphalt Boosters and Heaters; Asphalt Distributors; Asphalt Plant Fireman; Oiler on Two Paving Mixers When Used in Tandem; Boom or Winch Trucks; Bull Floats or Flexplanes; Concrete Finishing Machine; Concrete Saws, Self-Propelled; Concrete Spreading Machines; Conveyors (six to eight)\*; Generators (six to eight)\*; Gravel or Stone Spreader, Power Operated; Hoist (with One Drum and One Load Line); Light Plants (six to eight)\*; Mechanical Heaters (six to eight)\*; Mud Jacks; Post Hole Digger, Mechanical; Pug Mills when used for other than Asphalt operation; Robotic Controlled Equipment in this Classification; Road or Street Sweeper, Self Propelled; Rollers (except bituminous concrete); Seaman Tiller; Straw Machine; Vibratory Compactor; Water Blaster, Power Unit; Welding Machines (six to eight)\*; Well Drill Machines.

CLASS 3. Air Compressors(one to five)\*; Air Compressors, Track or Self-Propelled; Automatic Hoist; Building Elevators; Bulk Cement Batching Plants; Conveyors (one to five)\*; Concrete Mixers (Except Plant, Paver, or Tower); Firemen; Generators (one to five)\*; Greasers; Helper on Single Paving Mixer; Hoist, Automatic; Light Plants (one to five)\*; Mechanic Helpers; Mechanical Heaters (one to five)\*; Oilers; Power Form Graders; Power Sub-Graders; Robotic Controlled Equipment in this Classification; Scissors Hoist; Tractors without power attachments regardless of size or type; Truck Crane Oiler and Driver (1 man); Vibratory Hammer (power source); Water Pumps (one to five)\*; Welding Machines (1/300 Amp. or over)\*; Welding machines (one to five)\*

CLASS 4. Lattice Boom Crawler Cranes; Lattice Boom Truck Cranes; Telescopic Truck-Mounted Cranes; Tower Cranes.

\* Combinations of one to eight of any Air Compressors, Conveyors, Welding Machines, Water Pumps, Light Plants, or Generators shall be in batteries or within 400 feet and shall be paid as per the Classification Schedule contained in this Article.

#### OPERATING ENGINEERS - HIGHWAY

CLASS 1. Asphalt Screed Man; Asphco Concrete Spreaders; Asphalt Pavers; Asphalt Plant Engineer; Asphalt Rollers on Bituminous Concrete; Athey Loaders; Backhoes; Barber Green Loaders; Bulldozers;

Cableways; Carry Deck Pickers; Cherry Pickers (Rough Terrain); C.M.I. & similar type-autograde formless paver, autograde placer & finisher; Concrete Breakers; Concrete Plant Operators; Concrete Pumps; Derricks; Derrick Boats; Dewatering Systems; Earth Auger or Boring Machines; Elevating Graders; Engineers on Dredges; Gravel Processing Machines; Grout Pump; Head Equipment Greaser; High Lifts or Fork Lifts; Hoists with two or more drums or two or more load lines; Hydro Jet or Hydro Laser; Locomotives, All; Mechanics; Motor Graders or Auto Patrols; Multi-Point Power Lifting Equipment; Operators or Leverman on Dredges; Operators, Power Boat; Operators, Pug Mill (Asphalt Plants); Overhead Cranes; Paving Mixers; Piledrivers; Pipe Wrapping and Painting Machines; Push-dozers, or Push Cats; Robotic Controlled Equipment in this Classification; Rock Crushers; Ross Carrier or Similar Machines; Roto-Mill; Scoops, Skimmer, two cu. yd. capacity and under; Sheep-Foot Roller (Self Pro-pelled); Shovels; Skid Steer; Skimmer Scoops; Test Hole Drilling Machines; Tower Machines; Tower Mixers; Track Type End Loaders; Track Type Fork Lifts or High Lifts; Track Jacks and Tampers; Tractors, Side-boom; Trenching or Ditching Machine; Tunnelluggers; Vermeer-Type Saws; Wheel Type End Loaders; Winch Cat; Scoops, All or Tournapull.

CLASS 2. Air Compressors (six to eight)\*; Articulated Dumps; Asphalt Boosters and Heaters; Asphalt Distributors; Asphalt Plant Fireman; Boom or Winch Trucks; Building Elevators; Bull Floats or Flexplanes; Concrete Finishing Machine; Concrete Saws, Self-Propelled; Concrete Spreading Machines; Conveyors (six to eight)\*; Generators (six to eight)\*; Gravel or Stone Spreader, Power Operated; Hoist, Automatic; Hoist with One Drum and One Load Line; Light Plants (six to eight)\*; Mechanical Heaters (six to eight)\*; Mud Jacks; Off Road Water Wagons; Oiler on Two Paving Mixers When Used in Tandem; Post Hole Digger, Mechanical; Robotic Controlled Equipment in This Classification; Road or Street Sweeper, Self-Propelled; Rollers (except bituminous concrete); Scissor Hoist; Sea-man Tiller; Straw Machine; Vibratory Compactor; Water Pumps (six to eight)\*; Well Drill Machines.

CLASS 3. Air Compressors (one to five)\*; Air Compressors, Track or Self-Propelled; Bulk Cement Batching Plants; Conveyors (one to five)\*; Concrete Mixers (Except Plant, Paver, or Tower); Firemen; Generators (one to five)\*; Greasers; Helper on Single Paving Mixer; Light Plants (one to five)\*; Mechanic Helpers; Mechanical Heaters (one to five)\*; Oilers; Power Form Graders; Power Sub-Graders; Pug Mills when used for other than Asphalt operation; Robotic Controlled Equipment in This Classification; Tractors without power attachments, regardless of size or type; Truck Crane Oiler and Driver (1 man); Vibratory Hammer (power source); Water Pumps (one to five)\*; Welding Machines (one 300 Amp. or over)\*; Welding Machines (one to five)\*.

CLASS 4. Lattice Boom Crawler Crane; Lattice Boom Truck Crane; Telescopic Truck-Mounted Crane; Tower Crane.

\*Combinations of one to eight of any Air Compressors, Conveyors, Welding Machines, Water Pumps, Light Plants or Generators shall be in batteries or within 400 feet and shall be paid as per the Classification Schedule contained in this Article.

Other Classifications of Work:

For definitions of classifications not otherwise set out, the Department generally has on file such definitions which are available. If a task to be performed is not subject to one of the classifications of pay set out, the Department will upon being contacted state which neighboring county has such a classification and

provide such rate, such rate being deemed to exist by reference in this document. If no neighboring county rate applies to the task, the Department shall undertake a special determination, such special determination being then deemed to have existed under this determination. If a project requires these, or any classification not listed, please contact IDOL at 618/993-7271 for wage rates or clarifications.

#### LANDSCAPING

Landscaping work falls under the existing classifications for laborer, operating engineer and truck driver. The work performed by landscape plantsman and landscape laborer is covered by the existing classification of laborer. The work performed by landscape operators (regardless of equipment used or its size) is covered by the classifications of operating engineer. The work performed by landscape truck drivers (regardless of size of truck driven) is covered by the classifications of truck driver.

# Bureau County Prevailing Wage for April 2007

Trade Name	RG	TYP	C	Base	FRMAN	*M-F>8	OSA	OSH	H/W	Pensn	Vac	Trng
=====	==	==	=	=====	=====	=====	==	==	=====	=====	=====	=====
ASBESTOS ABT-GEN		ALL		25.460	26.460	1.5	1.5	2.0	5.850	4.500	0.000	0.600
ASBESTOS ABT-MEC		BLD		23.300	24.800	1.5	1.5	2.0	7.860	4.910	0.000	0.000
BOILERMAKER		BLD		30.970	33.970	2.0	2.0	2.0	8.270	7.740	0.000	0.300
BRICK MASON		BLD		29.500	30.500	1.5	1.5	5.0	6.070	6.000	0.000	0.400
CARPENTER		BLD		27.220	28.720	1.5	1.5	2.0	5.810	8.170	0.000	0.570
CARPENTER		HWY		26.480	28.230	1.5	1.5	2.0	5.810	7.670	0.000	0.500
CEMENT MASON		ALL		30.000	31.000	2.0	2.0	2.0	5.500	5.390	0.000	0.100
CERAMIC TILE FNSHER		BLD		24.860	0.000	1.5	1.5	2.0	5.500	4.000	0.000	0.360
COMMUNICATION TECH		BLD		29.110	30.610	1.5	1.5	2.0	8.270	8.670	0.000	0.290
ELECTRIC PWR EQMT OP		ALL		30.750	0.000	1.5	1.5	2.0	4.750	8.610	0.000	0.000
ELECTRIC PWR GRNDMAN		ALL		21.090	0.000	1.5	1.5	2.0	4.750	5.905	0.000	0.000
ELECTRIC PWR LINEMAN		ALL		34.160	36.350	1.5	1.5	2.0	4.750	9.560	0.000	0.000
ELECTRIC PWR TRK DRV		ALL		22.130	0.000	1.5	1.5	2.0	4.750	6.200	0.000	0.000
ELECTRICIAN		BLD		33.950	37.010	1.5	1.5	2.0	8.570	11.01	0.000	0.340
ELEVATOR CONSTRUCTOR		BLD		33.140	37.280	2.0	2.0	2.0	8.275	6.060	1.990	0.000
GLAZIER		BLD		26.320	27.070	1.5	1.5	2.0	5.650	5.750	0.000	0.350
HT/FROST INSULATOR		BLD		33.300	35.050	1.5	1.5	2.0	7.860	8.610	0.000	0.310
IRON WORKER		ALL		28.000	29.000	2.0	2.0	2.0	8.040	11.85	0.000	0.550
LABORER		ALL		24.460	25.460	1.5	1.5	2.0	5.850	4.500	0.000	0.600
LABORER, SKILLED		BLD		24.860	25.860	1.5	1.5	2.0	5.850	4.500	0.000	0.600
LABORER, SKILLED		HWY		24.860	25.860	1.5	1.5	2.0	5.850	4.500	0.000	0.600
LATHER		BLD		27.220	28.720	1.5	1.5	2.0	5.810	8.170	0.000	0.570
MACHINIST		BLD		36.890	38.890	2.0	2.0	2.0	4.380	5.650	2.550	0.000
MARBLE FINISHERS		BLD		24.860	0.000	1.5	1.5	2.0	5.500	4.000	0.000	0.360
MARBLE MASON		BLD		28.140	28.390	1.5	1.5	2.0	5.500	5.220	0.000	0.380
MILLWRIGHT		BLD		32.000	35.200	1.5	1.5	2.0	6.100	9.250	0.000	0.560
OPERATING ENGINEER	E	BLD	1	39.750	43.750	2.0	2.0	2.0	6.850	5.600	1.900	0.700
OPERATING ENGINEER	E	BLD	2	38.450	43.750	2.0	2.0	2.0	6.850	5.600	1.900	0.700
OPERATING ENGINEER	E	BLD	3	35.900	43.750	2.0	2.0	2.0	6.850	5.600	1.900	0.700
OPERATING ENGINEER	E	BLD	4	34.150	43.750	2.0	2.0	2.0	6.850	5.600	1.900	0.700
OPERATING ENGINEER	E	HWY	1	39.750	43.750	1.5	1.5	2.0	6.850	5.600	1.900	0.700
OPERATING ENGINEER	E	HWY	2	39.200	43.750	1.5	1.5	2.0	6.850	5.600	1.900	0.700
OPERATING ENGINEER	E	HWY	3	37.150	43.750	1.5	1.5	2.0	6.850	5.600	1.900	0.700
OPERATING ENGINEER	E	HWY	4	35.750	43.750	1.5	1.5	2.0	6.850	5.600	1.900	0.700
OPERATING ENGINEER	E	HWY	5	34.550	43.750	1.5	1.5	2.0	6.850	5.600	1.900	0.700
OPERATING ENGINEER	W	BLD	1	27.840	30.840	1.5	1.5	2.0	5.900	8.000	0.000	0.900
OPERATING ENGINEER	W	BLD	2	25.940	30.840	1.5	1.5	2.0	5.900	8.000	0.000	0.900
OPERATING ENGINEER	W	BLD	3	24.560	30.840	1.5	1.5	2.0	5.900	8.000	0.000	0.900
OPERATING ENGINEER	W	HWY	1	29.110	32.110	1.5	1.5	2.0	6.250	9.000	0.000	1.000
OPERATING ENGINEER	W	HWY	2	26.730	32.110	1.5	1.5	2.0	6.250	9.000	0.000	1.000
OPERATING ENGINEER	W	HWY	3	22.790	32.110	1.5	1.5	2.0	6.250	9.000	0.000	1.000
PAINTER		ALL		26.850	27.850	1.5	1.5	1.5	5.650	5.750	0.000	0.350
PAINTER SIGNS		BLD		28.970	32.520	1.5	1.5	1.5	2.600	2.310	0.000	0.000
PILEDRIVER		BLD		27.470	28.970	1.5	1.5	2.0	5.810	8.170	0.000	0.570
PILEDRIVER		HWY		26.480	28.230	1.5	1.5	2.0	5.810	7.670	0.000	0.500
PIPEFITTER		BLD		37.600	39.600	1.5	1.5	2.0	8.660	6.900	0.000	0.940
PLASTERER		BLD		30.000	31.000	2.0	2.0	2.0	5.500	5.390	0.000	0.100
PLUMBER		BLD		37.500	39.500	1.5	1.5	2.0	7.050	8.500	0.000	0.760
ROOFER		BLD		26.560	27.560	1.5	1.5	2.0	6.460	3.310	0.000	0.330
SHEETMETAL WORKER		BLD		29.890	31.140	1.5	1.5	2.0	5.770	6.730	0.000	0.200
SPRINKLER FITTER		BLD		31.240	33.240	1.5	1.5	2.0	6.500	5.350	0.000	0.250
STONE MASON		BLD		29.500	30.500	1.5	1.5	5.0	6.070	6.000	0.000	0.400
TERRAZZO FINISHER		BLD		24.860	0.000	1.5	1.5	2.0	5.500	4.000	0.000	0.360
TILE LAYER		BLD		27.220	28.720	1.5	1.5	2.0	5.810	8.170	0.000	0.570
TILE MASON		BLD		28.140	28.390	1.5	1.5	2.0	5.500	5.220	0.000	0.380
TRUCK DRIVER		ALL	1	25.787	0.000	1.5	1.5	2.0	7.250	3.317	0.000	0.000
TRUCK DRIVER		ALL	2	26.187	0.000	1.5	1.5	2.0	7.250	3.317	0.000	0.000
TRUCK DRIVER		ALL	3	26.387	0.000	1.5	1.5	2.0	7.250	3.317	0.000	0.000

TRUCK DRIVER	ALL	4	26.637	0.000	1.5	1.5	2.0	7.250	3.317	0.000	0.000
TRUCK DRIVER	ALL	5	27.387	0.000	1.5	1.5	2.0	7.250	3.317	0.000	0.000
TRUCK DRIVER	O&C	1	20.630	0.000	1.5	1.5	2.0	7.250	3.317	0.000	0.000
TRUCK DRIVER	O&C	2	20.950	0.000	1.5	1.5	2.0	7.250	3.317	0.000	0.000
TRUCK DRIVER	O&C	3	21.110	0.000	1.5	1.5	2.0	7.250	3.317	0.000	0.000
TRUCK DRIVER	O&C	4	21.310	0.000	1.5	1.5	2.0	7.250	3.317	0.000	0.000
TRUCK DRIVER	O&C	5	21.910	0.000	1.5	1.5	2.0	7.250	3.317	0.000	0.000
TUCKPOINTER	BLD		29.500	30.500	1.5	1.5	5.0	6.070	6.000	0.000	0.400

Legend:

M-F>8 (Overtime is required for any hour greater than 8 worked each day, Monday through Friday.)

OSA (Overtime is required for every hour worked on Saturday)

OSH (Overtime is required for every hour worked on Sunday and Holidays)

H/W (Health & Welfare Insurance)

Pensn (Pension)

Vac (Vacation)

Trng (Training)

## Explanations

BUREAU COUNTY

OPERATING ENGINEERS (EAST) - That part of the county East of Route 26.

The following list is considered as those days for which holiday rates of wages for work performed apply: New Years Day, Memorial/Decoration Day, Fourth of July, Labor Day, Veterans Day, Thanksgiving Day, Christmas Day. Generally, any of these holidays which fall on a Sunday is celebrated on the following Monday. This then makes work performed on that Monday payable at the appropriate overtime rate for holiday pay. Common practice in a given local may alter certain days of celebration such as the day after Thanksgiving for Veterans Day. If in doubt, please check with IDOL.

Oil and chip resealing (O&C) means the application of road oils and liquid asphalt to coat an existing road surface, followed by application of aggregate chips or gravel to coated surface, and subsequent rolling of material to seal the surface.

EXPLANATION OF CLASSES

ASBESTOS - GENERAL - removal of asbestos material/mold and hazardous materials from any place in a building, including mechanical systems where those mechanical systems are to be removed. This includes the removal of asbestos materials/mold and hazardous materials from ductwork or pipes in a building when the building is to be demolished at the time or at some close future date.

ASBESTOS - MECHANICAL - removal of asbestos material from mechanical systems, such as pipes, ducts, and boilers, where the mechanical systems are to remain.

#### CERAMIC TILE FINISHER, MARBLE FINISHER, TERRAZO FINISHER

Assisting, helping or supporting the tile, marble and terrazzo mechanic by performing their historic and traditional work assignments required to complete the proper installation of the work covered by said crafts. The term "Ceramic" is used for naming the classification only and is in no way a limitation of the product handled. Ceramic takes into consideration most hard tiles.

#### COMMUNICATION TECHNICIAN

Installation, operation, inspection, maintenance, repair and service of radio, television, recording, voice, sound and vision production and reproduction, telephone and telephone interconnect, facsimile, equipment and appliances used for domestic, commercial, educational and entertainment purposes, pulling of wire through conduit but not the installation of conduit.

#### LABORER, SKILLED - BUILDING AND HIGHWAY

The skilled laborer building (BLD) and heavy & highway (HWY) classification shall encompass the following types of work, irrespective of the site of the work: flagging, caisson worker plus depth, gunnite nozzle men, lead man on sewer work, welders, cutter burners and torchmen, chain saw operator, paving breaker, jackhammer and drill operators, layout man and/or drainage tile layer, steel form setter - street and highway, air tamping hammerman, signal man on crane, concrete saw operator, concrete saw operator walk behind, screenman on asphalt pavers, front end man on chip spreader, laborers tending masons with hot material or where foreign materials are used, multiple concrete duct - leadman, luteman, asphalt raker, curb asphalt machine operator, ready mix scalemen (permanent, portable or temporary plant), laborers handling masterplate or similar materials, laser beam operator, coring machine operator, plaster tenders, underpinning and shoring of buildings, material selector when working with fire-brick or castable material, fire watch, signaling of all power equipment, tree topper or trimmer when in connection with construction, and diver tender.

#### TRUCK DRIVER - BUILDING, HEAVY AND HIGHWAY CONSTRUCTION

Class 1. Drivers on 2 axle trucks hauling less than 9 ton. Air compressor and welding machines and brooms, including those pulled by separate units, truck driver helpers, warehouse employees, mechanic helpers, greasers and tiremen, pickup trucks when hauling materials, tools, or workers to and from and on-the-job site, and fork lifts up to 6,000 lb. capacity.

Class 2. Two or three axle trucks hauling more than 9 ton but hauling less than 16 ton. A-frame winch trucks, hydrolift trucks, vector trucks or similar equipment when used for transportation purposes. Fork lifts over 6,000 lb. capacity, winch trucks, four axle combination units, and ticket writers.

Class 3. Two, three or four axle trucks hauling 16 ton or more. Drivers on water pulls, articulated dump trucks, mechanics and working forepersons, and dispatchers. Five axle or more combination units.

Class 4. Low Boy and Oil Distributors.

Class 5. Drivers who require special protective clothing while employed on hazardous waste work.

TRUCK DRIVER - OIL AND CHIP RESEALING ONLY.

This shall encompass laborers, workers and mechanics who drive contractor or subcontractor owned, leased, or hired pickup, dump, service, or oil distributor trucks. The work includes transporting materials and equipment (including but not limited to, oils, aggregate supplies, parts, machinery and tools) to or from the job site; distributing oil or liquid asphalt and aggregate; stock piling material when in connection with the actual oil and chip contract. The Truck Driver (Oil & Chip Resealing) wage classification does not include supplier delivered materials.

OPERATING ENGINEERS - BUILDING - EAST

Class 1. Assistant Craft Foreman; Craft Foreman; Mechanic; Asphalt Plant; Asphalt Spreader; Autograde; Backhoes w/Caisson attachment; Batch Plant; Benoto; Boiler and Throttle Valve; Caisson Rigs; Central Redi-Mix Plant; Combination Back Hoe Front End-loader Machine; Compressor and Throttle Valve; Concrete Breaker (Truck Mounted); Concrete Conveyor; Concrete Paver; Concrete Placer; Concrete Pump (Truck Mounted); Concrete Tower; Cranes, All; Cranes, Hammerhead; Creter Crane; Crusher, Stone, etc.; Derricks, All; Derricks, Traveling; Formless Curb and Gutter Machine; Grader, Elevating; Grouting Machines; Highlift Shovels or Front Endloader 2-1/4 yd. and over; Hoists, Elevators, outside type rack and pinion and similar machines; Hoists, one, two and three Drum; Hoists, Two tigger One Floor; Hydraulic Backhoes; Hydraulic Boom Trucks; Hydro Vac (and similar equipment.); Locomotives, All; Motor Patrol; Pile Drivers and Skid Rig; Post Hole Digger; Pre-Stress Machine; Pump Cretes; Squeeze Cretes-screw Type Pumps; Gypsum Bulker and Pump; Roto Mill Grinder; Scoops - Tractor Drawn; Slip-form Paver; Straddle Buggies; Tournapull; Tractor with Boom and Side Boom; Trenching Machines.

Class 2. Boilers; Broom, All Power Propelled; Bulldozers; Concrete Mixer (Two Bag and Over); Conveyor, Portable; Forklift Trucks; Greaser Engineer; Highlift Shovels or Front Endloaders under 2-1/4 yd.; Hoists, Automatic; Hoists, inside Freight Elevators; Hoists, Sewer Dragging Machine; Hoists, Tigger Single Drum; Laser Screed; Rock Drill (self-propelled); Rock Drill (Truck mounted); Rollers, All; Steam Generators; Tractors, All; Tractor Drawn Vibratory Roller; Winch Trucks with "A" Frame.

Class 3. Air Compressors; Combination - Small Equipment Operator; Generators; Heaters, Mechanical; Hoists, Inside Elevators - (Rheostat Manual Controlled); Hoists, Inside Elevators; Hydraulic Power Units (Pile Driving and Extracting); Vibratory Roller; Lowboys; Pumps, over 3" (1 to 3 not to exceed a total of 300 ft.); Pumps, Well Points; Welding Machines (2 through 5); Winches, 4 small Electric Drill Winches.

Class 4. Bobcat/Skid Steer Loader; Brick Forklift; Hoists, Inside Elevators push button with automatic doors; Oilers.

OPERATING ENGINEERS - HEAVY AND HIGHWAY CONSTRUCTION - EAST

Class 1. Craft Foreman; Asphalt Plant; Asphalt Heater and Planer Combination; Asphalt Heater Scarfire; Asphalt Spreader; Autograder; ABC Paver; Backhoes with Caisson Attachment; Belt Loader; Caisson Rigs; Car Dumper; Central Redi-Mix Plant; Combination Backhoe Front Endloader Machine, (1 cu. yd. Backhoe Bucket or over or with attachments); Concrete Breaker (Truck Mounted); Concrete Conveyor; Concrete Paver over 27E cu. ft.; Concrete Placer; Concrete Tube Float;

Cranes, all attachments; Cranes, Hammerhead, Linden, Peco & Machines of a like nature; Creter Crane; Crusher, Stone, etc.; Derricks, All; Derrick Boats; Derricks, Traveling; Dowell Machine; Dredges; Field Mechanic-Welder; Formless Curb and Gutter Machine; Gradall and Machines of a like nature; Grader, Elevating; Grader, Motor Grader, Motor Patrol, Auto Patrol, Form Grader, Pull Grader, Subgrader; Guard Rail Post Driver Truck Mounted; Hoists, One, Two and Three Drum; Hydraulic Backhoes; Mucking Machine; Pile Drivers and Skid Rig; Pre-Stress Machine; Pump Cretes Dual Ram; Rock/Track Tamper; Rock Drill - Truck Mounted; Roto Mill Grinder; Slip-Form Paver; Soil Test Drill Rig (Truck Mounted); Straddle Buggies; Hydraulic Telescoping form (Tunnel); Tractor Drawn Belt Loader with attached pusher; Tractor with Boom; Tractaire with Attachments; Trenching Machine; Truck Mounted Concrete Pump with Boom; Raised or Blind Hole; Drills (Tunnel Shaft); Underground Boring and/or Mining Machines; Wheel Excavator; Widener (APSCO).

Class 2. Batch Plant; Bituminous Mixer; Boiler and Throttle Valve; Bulldozers; Car Loader Trailing Conveyors; Combination Backhoe Front Endloader Machine (less than 1 cu. yd. Backhoe Bucket or over or with attachments); Compressor and Throttle Valve; Compressor, Common Receiver (3); Concrete Breaker or Hydro Hammer; Concrete Grinding Machine; Concrete Mixer or Paver 7S Series to and including 27 cu. ft.; Concrete Spreader; Concrete Curing Machine, Burlap Machine, Belting Machine and Sealing Machine; Concrete Wheel Saw; Conveyor Muck Cars (Haglund or Similar Type); Drills, All; Finishing Machine - Concrete; Greaser Engine; Highlift Shovels or Front Endloader; Hoist - Sewer Dragging Machine; Hydraulic Boom Trucks (All Attachments); Hydro-Blaster; Locomotives, Dinky; Laser Screed; Pump Cretes; Squeeze Cretes-Screw Type Pumps, Gypsum Bulker and Pump; Rock Drill - Crawler or Skid Rig; Rock Drill - Truck Mounted; Roller, Asphalt; Rotary Snow Plows; Rototiller, Seaman, etc., self-propelled; Scoops - Tractor Drawn; Self-Propelled Compactor; Spreader - Chip - Stone, etc.; Scraper; Scraper - Prime Mover in Tandem; Tank Car Heater; Tractors, Push, Pulling Sheeps Foot, Disc, Compactor, etc. Tug Boats.

Class 3. Boilers; Brooms, All Power Propelled; Cement Supply Tender; Compressor, Common Receiver (2); Concrete Mixer (Two Bag and Over); Conveyor, Portable; Farm-Type Tractors Used for Mowing, Seeding, etc.; Fireman on Boilers; Forklift Trucks; Grouting Machine; Hoists, Automatic; Hoists, All Elevators; Hoists, Tugger Single Drum; Jeep Diggers; Pipe Jacking Machines; Post-Hole Digger; Power Saw, Concrete Power Driven; Pug Mills; Rollers, other than asphalt; Seed and Straw Blower; Steam Generators; Stump Machine; Winch Trucks with "A" Frame; Work Boats; Tamper - Form-Motor Driven.

Class 4. Air Compressor; Combination - Small Equipment Operator; Directional Boring Machine; Generators; Heaters, Mechanical; Hydraulic Power Unit (Pile Driving, Extracting, or Drilling); Hydro-Blaster; Light Plants, All (1 through 5); Pumps, over 3" (1 to 3 not to exceed a total of 300 ft.); Pumps; Tractaire; Welding Machines (2 through 5); Winches.

Class 5. Bobcats (All); Brick Forklifts; Oilers.

#### OPERATING ENGINEERS - BUILDING - WEST

Class 1. Cranes; Overhead Cranes; Gradall; All Cherry Pickers; Mechanics; Central Concrete Mixing Plant Operator; Road Pavers (27E - Dual Drum - Tri Batchers); Blacktop Plant Operators and Plant Engineers; 3 Drum Hoist; Derricks; Hydro Cranes; Shovels; Skimmer Scoops; Koehring Scooper; Drag Lines; Backhoe; Derrick Boats; Pile Drivers and Skid Rigs; Clamshells; Locomotive Cranes; Dredge (all



types) Motor Patrol; Power Blades - Dumore - Elevating and similar types; Tower Cranes (Crawler-Mobile) and Stationary; Crane-type Backfiller; Drott Yumbo and similar types considered as Cranes; Caisson Rigs; Dozer; Tournadozer; Work Boats; Ross Carrier; Helicopter; Tournapulls - all and similar types; Scoops (all sizes); Pushcats; Endloaders (all types); Asphalt Surfacing Machine; Slip Form Paver; Rock Crusher; Heavy Equipment Greaser; CMI, CMI Belt Placer, Auto Grade & 3 Track and similar types; Side Booms; Multiple Unit Earth Movers; Creter Crane; Trench Machine; Pump-crete-Belt Crete-Squeeze Cretes-Screw-type Pumps and Gypsum; Bulker & Pump - Operator will clean; Formless Finishing Machine; Flaherty Spreader or similar types; Screed Man on Laydown Machine; Wheel Tractors (industrial or Farm-type w/Dozer-Hoe-Endloader or other attachments); F.W.D. & Similar Types; Vermeer Concrete Saw.

Class 2. Dinkeys; Power Launches; PH One-pass Soil Cement Machine (and similar types); Pugmill with Pump; Backfillers; Euclid Loader; Forklifts; Jeeps w/Ditching Machine or other attachments; Tuneluger; Automatic Cement and Gravel Batching Plants; Mobile Drills (Soil Testing) and similar types; Gurries and Similar Types; (1) and (2) Drum Hoists (Buck Hoist and Similar Types); Chicago Boom; Boring Machine & Pipe Jacking Machine; Hydro Boom; Dewatering System; Straw Blower; Hydro Seeder; Assistant Heavy Equipment Greaser on Spread; Tractors (Track type) without Power Unit pulling Rollers; Rollers on Asphalt -- Brick Macadem; Concrete Breakers; Concrete Spreaders; Mule Pulling Rollers; Center Stripper; Cement Finishing Machines & CMI Texture & Reel Curing Machines; Cement Finishing Machine; Barber Green or similar loaders; Vibro Tamper (All similar types) Self-propelled; Winch or Boom Truck; Mechanical Bull Floats; Mixers over 3 Bag to 27E; Tractor pulling Power Blade or Elevating Grader; Porter Rex Rail; Clary Screed; Truck Type Hoptoe Oilers; Fireman; Spray Machine on Paving; Curb Machines; Truck Crane Oilers; Oil Distributor; Truck-Mounted Saws; Directional boring machine.

Class 3. Air Compressor; Power Subgrader; Straight Tractor; Trac Air without attachments; Herman Nelson Heater, Dravo, Warner, Silent Glo, and similar types; Roller: Five (5) Ton and under on Earth or Gravel; Form Grader; Crawler Crane & Skid Rig Oilers; Freight Elevators - permanently installed; Pump; Light Plant; Generator; Conveyor (1) or (2) - Operator will clean; Welding Machine; Mixer (3) Bag and Under (Standard Capacity with skip); Bulk Cement Plant; Oiler on Central Concrete Mixing Plant; Straight framed articulating end dump vehicle; Truck mounted vac unit (separately powered).

#### OPERATING ENGINEERS - HEAVY AND HIGHWAY CONSTRUCTION - WEST

Class 1. Cranes; Hydro Crane; Shovels; Crane Type Backfiller; Tower Cranes - Mobile & Crawler & Stationary; Derricks & Hoists (3 Drum); Draglines; Drott Yumbo & similar types considered as Cranes; Back Hoe; Derrick Boats; Pile Driver and Skid Rigs; Clam Shell; Locomotive - Cranes; Road Pavers - Single Drum - Dual Drum - Tri Batcher; Motor Patrols & Power Blades - Dumore - Elevating & Similar Types; Mechanics; Central Concrete Mixing Plant Operator; Asphalt Batch Plant Operators and Plant Engineers; Gradall; Caisson Rigs; Skimmer Scoop - Koering Scooper; Dredges (all types); Hoptoe; All Cherry Pickers; Work Boat; Ross Carrier; Helicopter; Dozer; Tournadozer; Tournapulls - all and similar types; Multiple Unit Earth Movers; Scoops (all sizes); Pushcats; Endloaders (all types); Asphalt Surfacing Machine; Slip Form Paver; Rock Crusher; Heavy Equipment Greaser (top greaser on spread); CMI, Auto Grade, CMI Belt Placer & 3 Track and similar types; Side Booms; Starting Engineer on Pipeline; Asphalt Heater & Planer Combination (used to plane streets); Wheel Tractors (with dozer, hoe or endloader attachments); F.W.D. and Similar types; Blaw

Knox Spreader and Similar types; Trench Machines; Pump Crete - Belt Crete - Squeeze Crete - screw type pumps and gypsum (operator will clean); Formless Finishing Machines; Flaherty Spreader or similar types; Screed Man on Laydown Machine; Vermeer Concrete Saw.

Class 2. Bulker & Pump; Power Launches; Boring Machine & Pipe Jacking Machine; Dinkeys; P-H One Pass Soil Cement Machines and similar types; Wheel Tractors (Industry or farm type - other); Back Fillers; Euclid Loader; Fork Lifts; Jeep w/Ditching Machine or other attachments; Tunneluger; Automatic Cement & Gravel Batching Plants; Mobile Drills - Soil Testing and similar types; Pugmill with pump; All (1) and (2) Drum Hoists; Dewatering System; Straw Blower; Hydro-Seeder; Boring Machine; Hydro-Boom; Bump Grinders (self-propelled); Assistant Heavy Equipment Greaser; Apsco Spreader; Tractors (track-type) without Power Units Pulling Rollers on Asphalt - Brick or Macadam; Concrete Breakers; Concrete Spreaders; Cement Strippers; Cement Finishing Machines & CMI Texture & Reel Curing Machines; Vibro-Tampers (all similar types self-propelled); Mechanical Bull Floats; Self-propelled Concrete Saws; Mixers-over three (3) bags to 27E; Winch and Boom Trucks; Tractor Pulling Power Blade or Elevating Grader; Porter Rex Rail; Clary Screed; Mule Pulling Rollers; Pugmill without Pump; Barber Greene or similar Loaders; Track Type Tractor w/Power Unit attached (minimum); Fireman; Spray Machine on Paving; Curb Machines; Paved Ditch Machine; Power Broom; Self-Propelled Conveyors; Power Subgrader; Oil Distributor; Straight Tractor; Truck Crane Oiler; Truck Type Oilers.

Class 3. Trac Air Machine (without attachments); Herman Nelson Heater, Dravo Warner, Silent Glo & similar types; Rollers - five ton and under on earth and gravel; Form Graders; Pumps; Light Plant; Generator; Air Compressor (1) or (2); Conveyor; Welding Machine; Mixer - 3 bags and under; Bulk Cement Plant; Oilers.

Other Classifications of Work:

For definitions of classifications not otherwise set out, the Department generally has on file such definitions which are available. If a task to be performed is not subject to one of the classifications of pay set out, the Department will upon being contacted state which neighboring county has such a classification and provide such rate, such rate being deemed to exist by reference in this document. If no neighboring county rate applies to the task, the Department shall undertake a special determination, such special determination being then deemed to have existed under this determination. If a project requires these, or any classification not listed, please contact IDOL at 618/993-7271 for wage rates or clarifications.

#### LANDSCAPING

Landscaping work falls under the existing classifications for laborer, operating engineer and truck driver. The work performed by landscape plantsman and landscape laborer is covered by the existing classification of laborer. The work performed by landscape operators (regardless of equipment used or its size) is covered by the classifications of operating engineer. The work performed by landscape truck drivers (regardless of size of truck driven) is covered by the classifications of truck driver.

# Calhoun County Prevailing Wage for April 2007

Trade Name	RG	TYP	C	Base	FRMAN	*M-F>8	OSA	OSH	H/W	Pensn	Vac	Trng
=====	==	==	=	=====	=====	=====	==	==	=====	=====	=====	=====
ASBESTOS ABT-GEN		ALL		24.250	24.750	1.5	1.5	2.0	5.050	6.750	0.000	0.600
ASBESTOS ABT-MEC		BLD		25.290	26.290	1.5	1.5	2.0	4.450	2.500	0.000	0.250
BOILERMAKER		BLD		28.500	31.000	1.5	1.5	2.0	6.820	11.03	0.000	0.300
BRICK MASON		BLD		26.400	28.100	1.5	1.5	5.0	4.750	8.250	2.000	0.390
CARPENTER		ALL		30.480	31.980	1.5	1.5	2.0	5.050	3.750	0.000	0.350
CEMENT MASON		ALL		26.750	27.500	1.5	1.5	2.0	5.650	8.250	0.000	0.200
CERAMIC TILE FNSHER		BLD		22.610	0.000	1.5	1.5	2.0	5.000	4.300	0.000	0.400
ELECTRIC PWR EQMT OP		ALL		29.470	36.150	1.5	2.0	2.0	5.400	7.380	0.000	0.150
ELECTRIC PWR GRNDMAN		ALL		19.820	36.150	1.5	2.0	2.0	5.400	4.960	0.000	0.100
ELECTRIC PWR LINEMAN		ALL		34.120	36.150	1.5	2.0	2.0	5.400	8.530	0.000	0.170
ELECTRIC PWR TRK DRV		ALL		22.060	36.150	1.5	2.0	2.0	5.400	5.530	0.000	0.110
ELECTRICIAN		ALL		30.110	32.110	1.5	1.5	2.0	5.400	6.950	0.000	0.210
ELECTRONIC SYS TECH		BLD		24.240	25.740	1.5	1.5	2.0	5.650	4.730	0.000	0.250
FLOOR LAYER		BLD		26.930	27.680	1.5	1.5	2.0	5.000	3.750	0.000	0.350
GLAZIER		BLD		29.480	0.000	2.0	2.0	2.0	8.550	6.920	2.360	0.160
HT/FROST INSULATOR		BLD		30.440	31.440	1.5	1.5	2.0	4.850	8.360	0.000	0.450
IRON WORKER		ALL		26.350	27.850	1.5	1.5	2.0	6.360	8.250	0.000	0.420
LABORER		ALL		23.750	24.250	1.5	1.5	2.0	5.050	6.750	0.000	0.600
MACHINIST		BLD		36.890	38.890	2.0	2.0	2.0	4.380	5.650	2.550	0.000
MARBLE FINISHERS		BLD		22.610	0.000	1.5	1.5	2.0	5.000	4.300	0.000	0.400
MILLWRIGHT		ALL		30.480	31.980	1.5	1.5	2.0	5.050	3.750	0.000	0.350
OPERATING ENGINEER		ALL	1	25.900	27.030	1.5	1.5	2.0	6.200	11.45	0.000	1.000
OPERATING ENGINEER		ALL	2	24.770	27.030	1.5	1.5	2.0	6.200	11.45	0.000	1.000
OPERATING ENGINEER		ALL	3	20.290	27.030	1.5	1.5	2.0	6.200	11.45	0.000	1.000
OPERATING ENGINEER		ALL	4	20.350	27.030	1.5	1.5	2.0	6.200	11.45	0.000	1.000
OPERATING ENGINEER		ALL	5	20.020	27.030	1.5	1.5	2.0	6.200	11.45	0.000	1.000
OPERATING ENGINEER		ALL	6	26.450	27.030	1.5	1.5	2.0	6.200	11.45	0.000	1.000
OPERATING ENGINEER		ALL	7	26.750	27.030	1.5	1.5	2.0	6.200	11.45	0.000	1.000
OPERATING ENGINEER		ALL	8	27.030	27.030	1.5	1.5	2.0	6.200	11.45	0.000	1.000
PAINTER		BLD		25.700	26.700	1.5	1.5	2.0	4.650	5.150	0.000	0.350
PAINTER		HWY		26.800	27.800	1.5	1.5	2.0	4.650	5.150	0.000	0.350
PAINTER OVER 30FT		BLD		26.700	27.700	1.5	1.5	2.0	4.650	5.150	0.000	0.350
PAINTER PWR EQMT		BLD		26.700	27.700	1.5	1.5	2.0	4.650	5.150	0.000	0.350
PAINTER PWR EQMT		HWY		27.800	28.800	1.5	1.5	2.0	4.650	5.150	0.000	0.350
PILEDRIIVER		ALL		30.480	31.980	1.5	1.5	2.0	5.050	3.750	0.000	0.350
PIPEFITTER		BLD		30.600	32.100	2.0	2.0	2.0	5.350	6.100	0.000	0.130
PLASTERER		BLD		27.000	28.000	1.5	1.5	2.0	5.650	7.250	0.000	0.250
PLUMBER		BLD		30.600	32.100	2.0	2.0	2.0	5.350	6.100	0.000	0.130
ROOFER		BLD		26.250	28.250	1.5	1.5	2.0	6.100	5.950	0.000	0.200
SHEETMETAL WORKER		BLD		24.150	25.710	1.5	1.5	2.0	6.040	7.000	0.000	0.380
SPRINKLER FITTER		BLD		34.230	36.480	2.0	2.0	2.0	6.650	7.850	0.000	0.650
TERRAZZO FINISHER		BLD		31.240	0.000	1.5	1.5	2.0	0.000	0.000	0.000	0.000
TERRAZZO MASON		BLD		30.780	31.080	1.5	1.5	2.0	0.000	3.750	0.000	0.000
TRUCK DRIVER		ALL	1	25.930	0.000	1.5	1.5	2.0	7.250	3.425	0.000	0.000
TRUCK DRIVER		ALL	2	26.330	0.000	1.5	1.5	2.0	7.250	3.425	0.000	0.000
TRUCK DRIVER		ALL	3	26.530	0.000	1.5	1.5	2.0	7.250	3.425	0.000	0.000
TRUCK DRIVER		ALL	4	26.780	0.000	1.5	1.5	2.0	7.250	3.425	0.000	0.000
TRUCK DRIVER		ALL	5	27.530	0.000	1.5	1.5	2.0	7.250	3.425	0.000	0.000
TRUCK DRIVER		O&C	1	20.740	0.000	1.5	1.5	2.0	7.250	3.425	0.000	0.000
TRUCK DRIVER		O&C	2	21.060	0.000	1.5	1.5	2.0	7.250	3.425	0.000	0.000
TRUCK DRIVER		O&C	3	21.220	0.000	1.5	1.5	2.0	7.250	3.425	0.000	0.000
TRUCK DRIVER		O&C	4	21.420	0.000	1.5	1.5	2.0	7.250	3.425	0.000	0.000
TRUCK DRIVER		O&C	5	22.020	0.000	1.5	1.5	2.0	7.250	3.425	0.000	0.000

Legend:

M-F>8 (Overtime is required for any hour greater than 8 worked each day, Monday through Friday.)

OSA (Overtime is required for every hour worked on Saturday)

OSH (Overtime is required for every hour worked on Sunday and Holidays)

H/W (Health & Welfare Insurance)

Pensn (Pension)

Vac (Vacation)

Trng (Training)

## Explanations

### CALHOUN COUNTY

The following list is considered as those days for which holiday rates of wages for work performed apply: New Years Day, Memorial/Decoration Day, Fourth of July, Labor Day, Veterans Day, Thanksgiving Day, Christmas Day. Generally, any of these holidays which fall on a Sunday is celebrated on the following Monday. This then makes work performed on that Monday payable at the appropriate overtime rate for holiday pay. Common practice in a given local may alter certain days of celebration such as the day after Thanksgiving for Veterans Day. If in doubt, please check with IDOL.

Oil and chip resealing (O&C) means the application of road oils and liquid asphalt to coat an existing road surface, followed by application of aggregate chips or gravel to coated surface, and subsequent rolling of material to seal the surface.

### EXPLANATION OF CLASSES

ASBESTOS - GENERAL - removal of asbestos material/mold and hazardous materials from any place in a building, including mechanical systems where those mechanical systems are to be removed. This includes the removal of asbestos materials/mold and hazardous materials from ductwork or pipes in a building when the building is to be demolished at the time or at some close future date.

ASBESTOS - MECHANICAL - removal of asbestos material from mechanical systems, such as pipes, ducts, and boilers, where the mechanical systems are to remain.

### CERAMIC TILE FINISHER AND MARBLE FINISHER

The handling, at the building site, of all sand, cement, tile, marble or stone and all other materials that may be used and installed by [a] tile layer or marble mason. In addition, the grouting, cleaning, sealing, and mixing on the job site, and all other work as required in assisting the setter. The term "Ceramic" is used for naming the classification only and is in no way a limitation of the product handled. Ceramic takes into consideration most hard tiles.

### ELECTRONIC SYSTEMS TECHNICIAN

Installation, service and maintenance of low-voltage systems which utilizes the transmission and/or transference of voice, sound, vision, or digital for commercial, education, security and entertainment

purposes for the following: TV monitoring and surveillance, background/foreground music, intercom and telephone interconnect, field programming, inventory control systems, microwave transmission, multi-media, multiplex, radio page, school, intercom and sound burglar alarms and low voltage master clock systems.

Excluded from this classification are energy management systems, life safety systems, supervisory controls and data acquisition systems not intrinsic with the above listed systems, fire alarm systems, nurse call systems and raceways exceeding fifteen feet in length.

#### TRUCK DRIVER - BUILDING, HEAVY AND HIGHWAY CONSTRUCTION

Class 1. Drivers on 2 axle trucks hauling less than 9 ton. Air compressor and welding machines and brooms, including those pulled by separate units, truck driver helpers, warehouse employees, mechanic helpers, greasers and tiremen, pickup trucks when hauling materials, tools, or workers to and from and on-the-job site, and fork lifts up to 6,000 lb. capacity.

Class 2. Two or three axle trucks hauling more than 9 ton but hauling less than 16 ton. A-frame winch trucks, hydrolift trucks, vector trucks or similar equipment when used for transportation purposes. Fork lifts over 6,000 lb. capacity, winch trucks, four axle combination units, and ticket writers.

Class 3. Two, three or four axle trucks hauling 16 ton or more. Drivers on water pulls, articulated dump trucks, mechanics and working forepersons, and dispatchers. Five axle or more combination units.

Class 4. Low Boy and Oil Distributors.

Class 5. Drivers who require special protective clothing while employed on hazardous waste work.

#### TRUCK DRIVER - OIL AND CHIP RESEALING ONLY.

This shall encompass laborers, workers and mechanics who drive contractor or subcontractor owned, leased, or hired pickup, dump, service, or oil distributor trucks. The work includes transporting materials and equipment (including but not limited to, oils, aggregate supplies, parts, machinery and tools) to or from the job site; distributing oil or liquid asphalt and aggregate; stock piling material when in connectin with the actual oil and chip contract. The Truck Driver (Oil & Chip Resealing) wage classification does not include supplier delivered materials.

#### OPERATING ENGINEERS

GROUP I. Cranes, Dragline, Shovels, Skimmer Scoops, Clamshells or Derrick Boats, Pile Drivers, Crane-Type Backhoes, Asphalt Plant Operators, Concrete Plant Operators, Dredges, Asphalt Spreading Machines, All Locomotives, Cable Ways, or Tower Machines, Hoists, Hydraulic Backhoes, Ditching Machines or Backfiller, Cherrypickers, Overhead Cranes, Roller, Steam or Gas, Concrete Pavers, Excavators, Concrete Breakers, Concrete Pumps, Bulk Cement Plants, Cement Pumps, Derrick-Type Drills, Boat Operators, Motor Graders or Pushcats, Scoops or Tournapulls, Bulldozers, Endloaders or Fork Lifts, Power Blade or Elevating Graders, Winch Cats, Boom or Winch Trucks or Boom Tractors, Pipe Wrapping or Painting Machines, Asphalt Plant Engineer, Journeyman Lubricating Engineer, Drills (other than Derrick Type), Mud Jacks, or Well Drilling Machines, Boring Machines or Track Jacks, Mixers, Conveyors (Two), Air Compressors (Two), Water Pumps

regardless of size (Two), Welding Machines (Two), Siphons or Jets (Two), Winch Heads or Apparatuses (Two), Light Plants (Two), Waterblasters (two), All Tractors regardless of size (straight tractor only), Fireman on Stationary Boilers, Automatic Elevators, Form Grading Machines, Finishing Machines, Power Sub-Grader or Ribbon Machines, Longitudinal Floats, Distributor Operators on Trucks, Winch Heads or Apparatuses (One), Mobil Track air and heaters (two to five), Heavy Equipment Greaser, Relief Operator, Assistant Master Mechanic and Heavy Duty Mechanic, all Operators (except those listed below).

GROUP II. Assistant Operators.

GROUP III. Air Compressors (One), Water Pumps, regardless of Size (One), Waterblasters (one), Welding Machine (One), Mixers (One Bag), Conveyor (One), Siphon or Jet (One), Light Plant (One), Heater (One), Immobile Track Air (One), and Self Propelled Walk-Behind Rollers.

GROUP IV. Asphalt Spreader Oilers, Fireman on Whirlies and Heavy Equipment Oilers, Truck Cranes, Dredges, Monigans, Large Cranes - (Over 65-ton rated capacity) Concrete Plant Oiler, Blacktop Plant Oiler, and Creter Crane Oiler (when required).

GROUP V. Oiler.

GROUP VI. Master Mechanics, Operators on equipment with Booms, including jibs, 100 feet and over, and less than 150 feet long

GROUP VII. Operators on equipment with Booms, including jibs, 150 feet and over, and less than 200 feet long.

GROUP VIII. Operators on Equipment with Booms, including jibs, 200 feet and over; Tower Cranes; Whirlie Cranes; and Operator Foreman.

#### TERRAZZO FINISHER

The handling of all materials used for Mosaic and Terrazzo work including preparing, mixing by hand, by mixing machine or transporting of pre-mixed materials and distributing with shovel, rake, hoe, or pail, all kinds of concrete foundations necessary for Mosaic and Terrazzo work, all cement terrazzo, magnesite terrazzo, Do-O-Tex terrazzo, epoxy matrix ter-razzo, exposed aggregate, rustic or rough washed for exterior or interior of buildings placed either by machine or by hand, and any other kind of mixture of plastics composed of chips or granules when mixed with cement, rubber, neoprene, vinyl, magnesium chloride or any other resinous or chemical substances used for seamless flooring systems, and all other building materials, all similar materials and all precast terrazzo work on jobs, all scratch coat used for Mosaic and Terrazzo work and sub-bed, tar paper and wire mesh (2x2 etc.) or lath. The rubbing, grinding, cleaning and finishing of same either by hand or by machine or by terrazzo resurfacing equipment on new or existing floors. When necessary finishers shall be allowed to assist the mechanics to spread sand bed, lay tarpaper and wire mesh (2x2 etc.) or lath. The finishing of cement floors where additional aggregate of stone is added by spreading or sprinkling on top of the finished base, and troweled or rolled into the finish and then the surface is ground by grinding machines.

Other Classifications of Work:

For definitions of classifications not otherwise set out, the

Department generally has on file such definitions which are available. If a task to be performed is not subject to one of the classifications of pay set out, the Department will upon being contacted state which neighboring county has such a classification and provide such rate, such rate being deemed to exist by reference in this document. If no neighboring county rate applies to the task, the Department shall undertake a special determination, such special determination being then deemed to have existed under this determination. If a project requires these, or any classification not listed, please contact IDOL at 618/993-7271 for wage rates or clarifications.

#### LANDSCAPING

Landscaping work falls under the existing classifications for laborer, operating engineer and truck driver. The work performed by landscape plantsman and landscape laborer is covered by the existing classification of laborer. The work performed by landscape operators (regardless of equipment used or its size) is covered by the classifications of operating engineer. The work performed by landscape truck drivers (regardless of size of truck driven) is covered by the classifications of truck driver.

# Carroll County Prevailing Wage for April 2007

Trade Name	RG	TYP	C	Base	FRMAN	*M-F>8	OSA	OSH	H/W	Pensn	Vac	Trng
=====	==	==	=	=====	=====	=====	==	==	=====	=====	=====	=====
ASBESTOS ABT-GEN		BLD		23.760	24.760	1.5	1.5	2.0	5.850	8.730	0.000	0.600
ASBESTOS ABT-MEC		BLD		18.750	19.750	1.5	1.5	2.0	4.750	2.000	0.000	0.000
BOILERMAKER		BLD		30.970	33.970	2.0	2.0	2.0	8.270	7.740	0.000	0.300
BRICK MASON		BLD		30.000	32.500	1.5	1.5	2.0	5.500	8.680	0.000	0.420
CARPENTER		BLD		27.040	30.010	1.5	1.5	2.0	6.100	8.220	0.000	0.600
CARPENTER		HWY		27.440	29.190	1.5	1.5	2.0	6.300	7.680	0.000	0.400
CEMENT MASON		ALL		30.000	32.500	1.5	1.5	2.0	5.500	7.530	0.000	0.100
CERAMIC TILE FNSHER		BLD		24.860	0.000	1.5	1.5	2.0	5.500	4.000	0.000	0.360
COMMUNICATION TECH	E	BLD		28.700	30.700	1.5	1.5	2.0	8.200	8.340	0.000	0.570
ELECTRIC PWR EQMT OP		ALL		27.920	35.880	1.5	1.5	2.0	4.750	7.820	0.000	0.210
ELECTRIC PWR GRNDMAN		ALL		21.640	35.880	1.5	1.5	2.0	4.750	6.060	0.000	0.160
ELECTRIC PWR LINEMAN		ALL		33.220	35.880	1.5	1.5	2.0	4.750	9.310	0.000	0.250
ELECTRIC PWR TRK DRV		ALL		22.340	35.880	1.5	1.5	2.0	4.750	6.260	0.000	0.170
ELECTRICIAN	E	BLD		33.570	36.930	1.5	1.5	2.0	8.200	11.15	0.000	0.670
ELECTRICIAN	W	BLD		27.770	29.770	1.5	1.5	2.0	5.500	7.660	0.000	0.310
ELECTRONIC SYS TECH	W	BLD		19.800	21.400	1.5	1.5	2.0	5.880	4.040	0.000	0.310
ELEVATOR CONSTRUCTOR		BLD		38.620	43.450	2.0	2.0	2.0	8.275	6.060	2.320	0.000
GLAZIER		BLD		20.720	21.810	1.5	1.5	2.0	4.750	3.900	0.000	0.200
HT/FROST INSULATOR		BLD		25.860	27.060	1.5	1.5	2.0	4.800	7.500	0.000	0.000
IRON WORKER	E	ALL		30.760	32.300	2.0	2.0	2.0	6.950	16.62	0.000	0.550
IRON WORKER	W	ALL		23.100	24.950	1.5	1.5	2.0	8.040	7.990	0.000	0.420
LABORER		BLD		23.760	24.760	1.5	1.5	2.0	5.850	8.730	0.000	0.600
LABORER		HWY		23.310	24.060	1.5	1.5	2.0	5.850	8.330	0.000	0.600
LABORER, SKILLED		HWY		24.710	25.460	1.5	1.5	2.0	5.850	8.330	0.000	0.600
LATHER		BLD		27.040	30.010	1.5	1.5	2.0	6.100	8.220	0.000	0.600
MACHINIST		BLD		36.890	38.890	2.0	2.0	2.0	4.380	5.650	2.550	0.000
MARBLE FINISHERS		BLD		24.860	0.000	1.5	1.5	2.0	5.500	4.000	0.000	0.360
MARBLE MASON		BLD		28.140	28.390	1.5	1.5	2.0	5.500	5.220	0.000	0.380
MATERIAL TESTER 1		ALL		21.550	0.000	1.5	1.5	2.0	7.460	4.840	0.000	0.170
MATERIALS TESTER II		ALL		26.550	0.000	1.5	1.5	2.0	7.460	4.840	0.000	0.170
MILLWRIGHT		BLD		29.820	32.800	1.5	1.5	2.0	4.300	8.730	0.000	0.560
OPERATING ENGINEER		BLD	1	37.050	41.050	2.0	2.0	2.0	6.850	6.150	1.900	0.700
OPERATING ENGINEER		BLD	2	36.350	41.050	2.0	2.0	2.0	6.850	6.150	1.900	0.700
OPERATING ENGINEER		BLD	3	33.900	41.050	2.0	2.0	2.0	6.850	6.150	1.900	0.700
OPERATING ENGINEER		BLD	4	31.900	41.050	2.0	2.0	2.0	6.850	6.150	1.900	0.700
OPERATING ENGINEER		HWY	1	36.900	40.900	1.5	1.5	2.0	6.850	6.150	1.900	0.700
OPERATING ENGINEER		HWY	2	36.350	40.900	1.5	1.5	2.0	6.850	6.150	1.900	0.700
OPERATING ENGINEER		HWY	3	35.050	40.900	1.5	1.5	2.0	6.850	6.150	1.900	0.700
OPERATING ENGINEER		HWY	4	33.600	40.900	1.5	1.5	2.0	6.850	6.150	1.900	0.700
OPERATING ENGINEER		HWY	5	32.150	40.900	1.5	1.5	2.0	6.850	6.150	1.900	0.700
PAINTER		ALL		23.470	24.470	1.5	1.5	1.5	4.650	4.850	0.000	0.600
PAINTER OVER 30FT		ALL		24.720	25.720	1.5	1.5	1.5	4.650	4.850	0.000	0.600
PAINTER PWR EQMT		ALL		23.970	24.970	1.5	1.5	1.5	4.650	4.850	0.000	0.600
PILEDRIVER		BLD		28.040	31.120	1.5	1.5	2.0	6.100	8.220	0.000	0.600
PILEDRIVER		HWY		27.440	29.190	1.5	1.5	2.0	6.300	7.680	0.000	0.400
PIPEFITTER	E	BLD		33.700	36.060	1.5	1.5	2.0	6.430	7.130	0.000	0.630
PIPEFITTER	W	ALL		30.520	33.570	1.5	1.5	2.0	4.800	7.960	0.000	0.530
PLASTERER		BLD		29.540	32.490	2.0	2.0	2.0	5.500	7.350	0.000	0.100
PLUMBER	E	BLD		33.700	36.060	1.5	1.5	2.0	6.430	7.130	0.000	0.630
PLUMBER	W	ALL		30.520	33.570	1.5	1.5	2.0	4.800	7.960	0.000	0.530
ROOFER		BLD		33.650	35.650	1.5	1.5	2.0	6.460	3.310	0.000	0.330
SHEETMETAL WORKER		BLD		31.690	33.620	1.5	1.5	2.0	4.850	10.29	0.520	0.290
SPRINKLER FITTER		BLD		31.240	33.240	1.5	1.5	2.0	6.500	5.350	0.000	0.250
STONE MASON		BLD		30.000	32.500	1.5	1.5	2.0	5.500	8.680	0.000	0.420
TERRAZZO FINISHER		BLD		24.860	0.000	1.5	1.5	2.0	5.500	4.000	0.000	0.360
TERRAZZO MASON		BLD		28.140	28.390	1.5	1.5	2.0	5.500	5.220	0.000	0.380
TILE LAYER		BLD		27.040	30.010	1.5	1.5	2.0	6.100	8.220	0.000	0.600
TILE MASON		BLD		28.140	28.390	1.5	1.5	2.0	5.500	5.220	0.000	0.380



TRUCK DRIVER	ALL	1	25.787	0.000	1.5	1.5	2.0	7.250	3.317	0.000	0.000
TRUCK DRIVER	ALL	2	26.187	0.000	1.5	1.5	2.0	7.250	3.317	0.000	0.000
TRUCK DRIVER	ALL	3	26.387	0.000	1.5	1.5	2.0	7.250	3.317	0.000	0.000
TRUCK DRIVER	ALL	4	26.637	0.000	1.5	1.5	2.0	7.250	3.317	0.000	0.000
TRUCK DRIVER	ALL	5	27.387	0.000	1.5	1.5	2.0	7.250	3.317	0.000	0.000
TRUCK DRIVER	O&C	1	20.630	0.000	1.5	1.5	2.0	7.250	3.317	0.000	0.000
TRUCK DRIVER	O&C	2	20.950	0.000	1.5	1.5	2.0	7.250	3.317	0.000	0.000
TRUCK DRIVER	O&C	3	21.110	0.000	1.5	1.5	2.0	7.250	3.317	0.000	0.000
TRUCK DRIVER	O&C	4	21.310	0.000	1.5	1.5	2.0	7.250	3.317	0.000	0.000
TRUCK DRIVER	O&C	5	21.910	0.000	1.5	1.5	2.0	7.250	3.317	0.000	0.000
TUCKPOINTER	BLD		30.000	32.500	1.5	1.5	2.0	5.500	8.680	0.000	0.420

Legend:

M-F>8 (Overtime is required for any hour greater than 8 worked each day, Monday through Friday.)

OSA (Overtime is required for every hour worked on Saturday)

OSH (Overtime is required for every hour worked on Sunday and Holidays)

H/W (Health & Welfare Insurance)

Pensn (Pension)

Vac (Vacation)

Trng (Training)

## Explanations

CARROLL COUNTY

COMMUNICATIONS TECHNICIAN (EAST) - Townships of Cherry Grove, Rock Creek, Shannon, Wysox, Lima, and Elkhorn Grove.

ELECTRICIANS (EAST) - Townships of Cherry Grove, Shannon, Rock Creek, Lima, Wysox, and Elkhorn Grove.

IRONWORKERS (EAST) - That part of the county East of a line between Fair Haven and Derinda Center (JoDaviess County).

PLUMBERS & PIPEFITTERS (EAST) - That part of the county East of Rt. 78 and including Mt. Carroll.

ELECTRONIC SYSTEMS TECHNICIAN -(WEST) - Portion west of Cherry Grove, Rock Creek and Wysox Townships.

The following list is considered as those days for which holiday rates of wages for work performed apply: New Years Day, Memorial/Decoration Day, Fourth of July, Labor Day, Veterans Day, Thanksgiving Day, Christmas Day. Generally, any of these holidays which fall on a Sunday is celebrated on the following Monday. This then makes work performed on that Monday payable at the appropriate overtime rate for holiday pay. Common practice in a given local may alter certain days of celebration such as the day after Thanksgiving for Veterans Day. If in doubt, please check with IDOL.

Oil and chip resealing (O&C) means the application of road oils and liquid asphalt to coat an existing road surface, followed by

application of aggregate chips or gravel to coated surface, and subsequent rolling of material to seal the surface.

#### EXPLANATION OF CLASSES

ASBESTOS - GENERAL - removal of asbestos material/mold and hazardous materials from any place in a building, including mechanical systems where those mechanical systems are to be removed. This includes the removal of asbestos materials/mold and hazardous materials from ductwork or pipes in a building when the building is to be demolished at the time or at some close future date.

ASBESTOS - MECHANICAL - removal of asbestos material from mechanical systems, such as pipes, ducts, and boilers, where the mechanical systems are to remain.

#### CERAMIC TILE FINISHER, MARBLE FINISHER, TERRAZZO FINISHER

Assisting, helping or supporting the tile, marble and terrazzo mechanic by performing their historic and traditional work assignments required to complete the proper installation of the work covered by said crafts. The term "Ceramic" is used for naming the classification only and is in no way a limitation of the product handled. Ceramic takes into consideration most hard tiles.

#### COMMUNICATIONS TECHNICIAN - East

Installing, manufacturing, assembling and maintaining sound and intercom, protection alarm (security), fire alarm, master antenna television, closed circuit television, low voltage control for computers and/or door monitoring, school communications systems, telephones and servicing of nurse and emergency calls, and the installation and maintenance of transmit and receive antennas, transmitters, receivers, and associated apparatus which operates in conjunction with above systems. All work associated with these system installations will be included EXCEPT the installation of protective metallic conduit in new construction projects (excluding less than ten-foot runs strictly for protection of cable) and 120 volt AC (or higher) power wiring and associated hardware.

#### ELECTRONIC SYSTEMS TECHNICIAN - West

Installing, assembling and maintaining sound and intercom, protection alarm (security), master antenna television, closed circuit television, computer hardware and software programming and installation to the network's outlet and input (EXCLUDING all cabling, power and cable termination work historically performed by wiremen), door monitoring and control, nurse and emergency call programming and installation to the system's outlet and input (EXCLUDING all cabling, power and cable termination work historically performed by wiremen), clock and timing; and the installation and maintenance of transmit and receive antennas, transmitters, receivers, and associated apparatus which operates in conjunction with the above systems. All work associated with these system installations will be included EXCEPT (1) installation of protective metallic conduit, excluding less than ten-foot runs strictly for protection of cable, and (2) 120 volt AC (or higher) power wiring and associated hardware.

#### LABORER, SKILLED - HIGHWAY

Individuals engaged in the following types of work, irrespective of the site of the work: asbestos abatement worker, handling of any materials with any foreign matter harmful to skin or clothing, track

laborer, cement handlers, chloride handlers, the unloading and loading with steel workers and re-bars, concrete workers wet, tunnel helpers in free air, batch dumpers, mason tenders, kettle and tar men, tank cleaners, plastic installers, scaffold workers, motorized buggies or motorized unit used for wet concrete or handling of building materials, laborers with de-watering systems, sewer workers plus depth, rod and chainmen with technical engineers, rod and chainmen with land surveyors, rod and chainmen with surveyors, vibrator operators, cement silica, clay, fly ash, lime and plasters, handlers (bulk or bag), cofferdam workers plus depth, on concrete paving, placing, cutting and tying of reinforcing, deck hand, dredge hand, and shore laborers, bankmen on floating plant, grade checker, power tools, front end man on chip spreaders, cession workers plus depth, gunnite nozzle men, lead man on sewer work, welders, cutters, burners and torchmen, chainsaw operators, jackhammer and drill operators, layout man and/or drainage tile layer, steel form setter - street and highway, air tamping hammermen, signal man on crane, concrete saw operator, screedman on asphalt pavers, laborers tending masons with hot material or where foreign materials are used, mortar mixer operators, multiple concrete duct - leadsman, lumen, asphalt raker, curb asphalt machine operator, ready mix scalemen (permanent, portable or temporary plant), laborers handling masterplate or similar materials, laser beam operator, concrete burning machine operator, coring machine operator, plaster tender, underpinning and shoring of buildings, pump men, manhole and catch basin, dirt and stone tamper, hose men on concrete pumps, hazardous waste worker, lead base paint abatement worker, lining of pipe, refusing machine, assisting on direct boring machine, the work of laying watermain, fire hydrants, all mechanical joints to watermain work, sewer worker, and tapping water service and forced lift station mechanical worker.

MATERIAL TESTER I: Hand coring and drilling for testing of materials; field inspection of uncured concrete and asphalt.

MATERIAL TESTER II: Field inspection of welds, structural steel, fireproofing, masonry, soil, facade, reinforcing steel, formwork, cured concrete, and concrete and asphalt batch plants; adjusting proportions of bituminous mixtures.

#### TRUCK DRIVER - BUILDING, HEAVY AND HIGHWAY CONSTRUCTION

Class 1. Drivers on 2 axle trucks hauling less than 9 ton. Air compressor and welding machines and brooms, including those pulled by separate units, truck driver helpers, warehouse employees, mechanic helpers, greasers and tiremen, pickup trucks when hauling materials, tools, or workers to and from and on-the-job site, and fork lifts up to 6,000 lb. capacity.

Class 2. Two or three axle trucks hauling more than 9 ton but hauling less than 16 ton. A-frame winch trucks, hydrolift trucks, vector trucks or similar equipment when used for transportation purposes. Fork lifts over 6,000 lb. capacity, winch trucks, four axle combination units, and ticket writers.

Class 3. Two, three or four axle trucks hauling 16 ton or more. Drivers on water pulls, articulated dump trucks, mechanics and working forepersons, and dispatchers. Five axle or more combination units.

Class 4. Low Boy and Oil Distributors.

Class 5. Drivers who require special protective clothing while employed on hazardous waste work.

## OPERATING ENGINEERS - BUILDING

Class 1. Assistant Craft Foreman; Craft Foreman; Mechanic; Asphalt Plant; Asphalt Spreader; Autograde; Batch Plant; Benoto (requires Two Engineers); Boiler and Throttle Valve; Caisson Rigs; Central Redi-Mix Plant; Combination Back Hoe Front End-loader Machine; Compressor and Throttle Valve; Concrete Breaker (Truck Mounted); Concrete Conveyor; Concrete Paver; Concrete Placer; Concrete Pump (Truck Mounted); Concrete Tower, Cranes, All, Cranes, Hammerhead, Creter Crane; Crusher, Stone, etc.; Derricks, All; Derricks, Traveling; Formless Curb and Gutter Machine; Grader, Elevating; Grouting Machines; Highlift Shovels or Front Endloader 2-1/4 yd. and over; Hoists, Elevators, outside type rack and pinion and similar machines; Hoists, one, two and three Drum; Hoists, Two tuggger One Floor; Hydraulic Backhoes; Hydraulic Boom Trucks; Locomotives, All; Motor Patrol; Pile Drivers and Skid Rig; Post Hole Digger; Pre-Stress Machine; Pump Cretes; Squeeze Cretes-screw Type Pumps; Gypsum Bulker and Pump; Raised and Blind Hole Drill; Rock Drill; Roto Mill Grinder; Scoops - Tractor Drawn; Slip-form Paver; Straddle Buggies; Tie Back Machine; Tractor with Book and Side Boom; Trenching Machines.

Class 2. Bobcat (over 3/4 cu. yd.); Boilers Brick Forklift; Broom, All Power Propelled; Bulldozers; Concrete Mixer (Two Bag and Over); Conveyor, Portable; Forklift Trucks; Greaser Engineer; Highlift Shovels or Front Endloaders under 2-1/4 yd.; Hoists, Automatic; Hoists, Sewer Dragging Machine; Hoists, Tuggger Single Drum; Rollers, All; Steam Generators; Tractors, All; Tractor Drawn Vibratory Roller; Winch Trucks with "A" Frame.

Class 3. Air Compressor; Asphalt Spreader; Combination - Small Equipment Operator; Generators; Heaters, Mechanical; Hoists, Inside Elevators - (Rheostat Manual Controlled); Hydraulic Power Units (Pile Driving and Extracting); Pumps, over 3" (1 to 3 not to exceed a total of 300 ft.); Pumps, Well Points; Welding Machines (2 through 5); Winches, 4 small Electric Drill Winches; Bobcat (up to and including 3/4 cu. yd.).

Class 4. Hoists, Inside Elevators, Push Button with Automatic Doors; Oilers; Brick Forklift.

## TRUCK DRIVER - OIL AND CHIP RESEALING ONLY.

This shall encompass laborers, workers and mechanics who drive contractor or subcontractor owned, leased, or hired pickup, dump, service, or oil distributor trucks. The work includes transporting materials and equipment (including but not limited to, oils, aggregate supplies, parts, machinery and tools) to or from the job site; distributing oil or liquid asphalt and aggregate; stock piling material when in connection with the actual oil and chip contract. The Truck Driver (Oil & Chip Resealing) wage classification does not include supplier delivered materials.

## OPERATING ENGINEERS - HEAVY AND HIGHWAY CONSTRUCTION

Class 1. Craft Foreman; Asphalt Plant, Asphalt Heater and Planer Combination; Asphalt Heater Scarfire; Asphalt Silo Tender; Asphalt Spreader; Autograder; ABG Paver; Backhoes with Caisson attachment; Ballast Regulator, Belt Loader; Caisson Rigs; Car Dumper; Central Redi-Mix Plant; Backhoe w/shear attachments; Combination Backhoe Front Endloader Machine, (1 cu. yd. Backhoe Bucket or over or with attachments); Concrete Breaker (Truck Mounted); Concrete Conveyor; Concrete Paver over 27E cu. ft.; Concrete Placer; Concrete Tube Float; Cranes, all attachments; Cranes, Hammerhead, Linden, Peco &

Machines of a like nature; Crete Crane; Crusher, Stone, etc.; Derricks, All; Derrick Boats; Derricks, Traveling; Directional Boring Machine over 12"; Dredges; Field Mechanic-Welder; Formless Curb and Gutter Machine; Gradall and Machines of a like nature; Grader, Elevating; Grader, Motor Grader, Motor Patrol, Auto Patrol, Form Grader, Pull Grader, Subgrader; Guard Rail Post Driver Mounted; Hoists, One, Two and Three Drum; Hydraulic Backhoes; Pile Drivers and Skid Rig; Pre-Stress Machine; Pump Cretes Dual Ram; Rock Drill - Crawler or Skid Rig; Rock Drill - Truck Mounted; Rock/Track Tamper; Roto Mill Grinder; Slip-Form Paver; Soil Test Drill Rig (Truck Mounted); Straddle Buggies; GCI Crane; Hydraulic Telescoping form (Tunnel); Tie Back Machine; Tractor Drawn Belt Loader; Tractor with Boom; Tractor-aire with Attachments; Traffic Barrier conveyor machine; Raised or Blind Hole; Trenching Machine; Truck Mounted Concrete Pump with Boom; Truck Mounted Concrete Conveyor; Underground Boring and/or Mining Machines; Wheel Excavator; Widener (APSCO).

Class 2. Batch Plant; Bituminous Mixer; Boiler and Throttle Valve; Bulldozers; Car Loader Trailing Conveyors; Combination Backhoe Front Endloader Machine (less than 1 cu. yd. Backhoe Bucket or over or with attachments); Compressor and Throttle Valve; Compressor, Common Receiver (3); Concrete Breaker or Hydro Hammer; Concrete Grinding Machine; Concrete Mixer or Paver 7S Series to and including 27 cu. ft.; Concrete Spreader; Concrete Curing Machine, Burlap Machine, Belting Machine and Sealing Machine; Conveyor Muck Cars (Haglund or Similar Type); Drills, all; Finishing Machine - Concrete; Greaser Engineer; Highlift Shovels or Front Endloader; Hoist - Sewer Dragging Machine; Hydraulic Boom Trucks (All Attachments); Hydro Blaster; Laser Scream; All Locomotives, Dinky; Pump Cretes; Squeeze Cretes-Screw Type Pumps, Gypsum Bulker and Pump; Roller, Asphalt; Rotary Snow Plows; Rototiller, Seaman, etc., self-propelled; Scoops - Tractor Drawn; Self-Propelled Compactor; Spreader - Chip - Stone, etc.; Scraper; Scraper - Prime Mover in Tandem (Regardless of Size); Tank Car Heater; Tractors, Push, Pulling Sheeps Foot, Disc, Compactor, etc. Tug Boats.

Class 3. Boilers; Brooms, All Power Propelled; Cement Supply Tender; Compressor, Common Receiver (2); Concrete Mixer (Two Bag and Over); Conveyor, Portable; Farm-Type Tractors Used for Mowing, Seeding, etc.; Fireman on Boilers; Forklift Trucks; Grouting Machine; Hoists, Automatic; Hoists, All Elevators; Hoists, Tugger Single Drum; Jeep Diggers, Low Boys; Pipe Jacking Machines; Post-Hole Digger; Power Saw, Concrete Power Driven; Pug Mills; Rollers, other than asphalt; Seed and Straw Blower; Steam Generators; Stump Machine; Winch Trucks with "A" Frame; Work Boats; Tamper - Form-Motor Driven.

Class 4. Air Compressor - Small and Large; Asphalt Spreader, Backend Man; Bobcat (Skid Steer) all; Combination - Small Equipment Operator; Directional Boring Machine up to 12"; Generators - Small 50kw and Under; Generators - Large over 50kw; Heaters, Mechanical; Hydraulic Power Unit (Pile Driving, Extracting, or Drilling); Hydro-Blaster; Light Plants, All (1 through 5); Pumps, over 3" (1 to 3 not to exceed a total of 300 ft.); Pumps, Well Points; Tract-aire; Welding Machines (2 through 5); Winches, 4 Small Electric Drill Winches.

Class 5. Oilers and Directional Boring Machine Locator.  
Other Classifications of Work:

For definitions of classifications not otherwise set out, the Department generally has on file such definitions which are available. If a task to be performed is not subject to one of the classifications of pay set out, the Department will upon being contacted state which neighboring county has such a classification and

provide such rate, such rate being deemed to exist by reference in this document. If no neighboring county rate applies to the task, the Department shall undertake a special determination, such special determination being then deemed to have existed under this determination. If a project requires these, or any classification not listed, please contact IDOL at 618/997-7271 for wage rates or clarifications.

#### LANDSCAPING

Landscaping work falls under the existing classifications for laborer, operating engineer and truck driver. The work performed by landscape plantsman and landscape laborer is covered by the existing classification of laborer. The work performed by landscape operators (regardless of equipment used or its size) is covered by the classifications of operating engineer. The work performed by landscape truck drivers (regardless of size of truck driven) is covered by the classifications of truck driver.

# Cass County Prevailing Wage for April 2007

Trade Name	RG	TYP	C	Base	FRMAN	*M-F>8	OSA	OSH	H/W	Pensn	Vac	Trng
=====	==	==	=	=====	=====	=====	==	==	=====	=====	=====	=====
ASBESTOS ABT-GEN		BLD		23.210	24.210	1.5	1.5	2.0	5.050	5.330	0.000	0.700
ASBESTOS ABT-MEC		BLD		25.290	26.290	1.5	1.5	2.0	4.450	2.500	0.000	0.250
BOILERMAKER		BLD		28.500	31.000	1.5	1.5	2.0	6.820	11.03	0.000	0.300
BRICK MASON		BLD		24.370	25.370	1.5	1.5	2.0	6.000	5.400	0.000	0.490
CARPENTER		BLD		24.490	26.490	1.5	1.5	2.0	6.500	7.900	0.000	0.320
CARPENTER		HWY		24.250	26.000	1.5	1.5	2.0	6.500	7.800	0.000	0.300
CEMENT MASON		BLD		22.800	23.800	1.5	1.5	2.0	5.200	8.080	0.000	0.150
CEMENT MASON		HWY		22.170	23.170	1.5	1.5	2.0	5.200	7.300	0.000	0.250
CERAMIC TILE FNSHER		BLD		23.020	0.000	1.5	1.5	2.0	6.000	5.400	0.000	0.000
ELECTRIC PWR EQMT OP		ALL		30.750	0.000	1.5	1.5	2.0	4.750	8.610	0.000	0.000
ELECTRIC PWR GRNDMAN		ALL		21.090	0.000	1.5	1.5	2.0	4.750	5.905	0.000	0.000
ELECTRIC PWR LINEMAN		ALL		34.160	36.350	1.5	1.5	2.0	4.750	9.560	0.000	0.000
ELECTRIC PWR TRK DRV		ALL		22.130	0.000	1.5	1.5	2.0	4.750	6.200	0.000	0.000
ELECTRICIAN		BLD		31.220	33.220	1.5	1.5	2.0	5.150	5.340	0.000	0.300
ELECTRONIC SYS TECH		BLD		24.830	26.330	1.5	1.5	2.0	5.150	3.190	0.000	0.250
ELEVATOR CONSTRUCTOR		BLD		34.190	38.460	2.0	2.0	2.0	8.275	6.060	2.050	0.000
GLAZIER		BLD		27.130	28.130	1.5	2.0	2.0	5.430	4.000	0.000	0.280
HT/FROST INSULATOR		BLD		30.440	31.440	1.5	1.5	2.0	4.850	8.360	0.000	0.450
IRON WORKER		BLD		25.400	27.150	1.5	1.5	2.0	5.860	7.900	0.000	0.300
IRON WORKER		HWY		25.400	26.900	1.5	1.5	2.0	5.860	7.900	0.000	0.300
LABORER		BLD		21.710	22.710	1.5	1.5	2.0	5.050	5.330	0.000	0.600
LABORER		HWY		22.680	23.430	1.5	1.5	2.0	5.050	5.330	0.000	0.600
LATHER		BLD		24.490	26.490	1.5	1.5	2.0	6.500	7.900	0.000	0.320
MACHINIST		BLD		36.890	38.890	2.0	2.0	2.0	4.380	5.650	2.550	0.000
MARBLE FINISHERS		BLD		23.020	0.000	1.5	1.5	2.0	6.000	5.400	0.000	0.000
MARBLE MASON		BLD		24.520	25.270	1.5	1.5	2.0	6.000	5.400	0.000	0.000
MILLWRIGHT		BLD		26.000	28.000	1.5	1.5	2.0	6.500	6.850	0.000	0.320
MILLWRIGHT		HWY		19.070	20.320	1.5	1.5	2.0	2.800	3.000	0.000	0.000
OPERATING ENGINEER		BLD	1	26.550	0.000	1.5	1.5	2.0	6.150	6.200	0.000	0.850
OPERATING ENGINEER		BLD	2	24.200	0.000	1.5	1.5	2.0	6.150	6.200	0.000	0.850
OPERATING ENGINEER		BLD	3	20.600	0.000	1.5	1.5	2.0	6.150	6.200	0.000	0.850
OPERATING ENGINEER		BLD	4	28.050	0.000	1.5	1.5	2.0	6.150	6.200	0.000	0.850
OPERATING ENGINEER		HWY	1	26.800	0.000	1.5	1.5	2.0	6.150	6.200	0.000	0.850
OPERATING ENGINEER		HWY	2	24.030	0.000	1.5	1.5	2.0	6.150	6.200	0.000	0.850
OPERATING ENGINEER		HWY	3	19.800	0.000	1.5	1.5	2.0	6.150	6.200	0.000	0.850
OPERATING ENGINEER		HWY	4	28.300	0.000	1.5	1.5	2.0	6.150	6.200	0.000	0.850
PAINTER		ALL		25.390	26.390	1.5	1.5	2.0	4.650	5.500	0.000	0.250
PAINTER OVER 30FT		ALL		26.390	27.390	1.5	1.5	2.0	4.650	5.500	0.000	0.250
PAINTER PWR EQMT		ALL		26.390	27.390	1.5	1.5	2.0	4.650	5.500	0.000	0.250
PILEDRIVER		BLD		24.990	26.990	1.5	1.5	2.0	6.500	7.900	0.000	0.320
PILEDRIVER		HWY		24.750	26.500	1.5	1.5	2.0	6.500	7.800	0.000	0.300
PIPEFITTER		BLD		34.700	37.200	1.5	1.5	2.0	6.450	4.750	0.000	0.350
PLASTERER		BLD		25.000	26.500	1.5	1.5	2.0	4.830	8.050	0.000	0.500
PLUMBER		BLD		34.700	37.200	1.5	1.5	2.0	6.450	4.750	0.000	0.350
ROOFER		BLD		24.310	26.740	1.5	1.5	2.0	4.650	5.250	0.000	0.100
SHEETMETAL WORKER		BLD		27.820	29.570	1.5	1.5	2.0	7.150	7.880	0.000	0.350
SPRINKLER FITTER		BLD		31.240	33.240	1.5	1.5	2.0	6.500	5.350	0.000	0.250
STONE MASON		BLD		24.370	25.370	1.5	1.5	2.0	6.000	5.400	0.000	0.490
TERRAZZO FINISHER		BLD		23.020	0.000	1.5	1.5	2.0	6.000	5.400	0.000	0.000
TERRAZZO MASON		BLD		24.520	25.270	1.5	1.5	2.0	6.000	5.400	0.000	0.000
TILE MASON		BLD		24.520	25.270	1.5	1.5	2.0	6.000	5.400	0.000	0.000
TRUCK DRIVER		ALL	1	25.930	0.000	1.5	1.5	2.0	7.250	3.425	0.000	0.000
TRUCK DRIVER		ALL	2	26.330	0.000	1.5	1.5	2.0	7.250	3.425	0.000	0.000
TRUCK DRIVER		ALL	3	26.530	0.000	1.5	1.5	2.0	7.250	3.425	0.000	0.000
TRUCK DRIVER		ALL	4	26.780	0.000	1.5	1.5	2.0	7.250	3.425	0.000	0.000
TRUCK DRIVER		ALL	5	27.530	0.000	1.5	1.5	2.0	7.250	3.425	0.000	0.000
TRUCK DRIVER		O&C	1	20.740	0.000	1.5	1.5	2.0	7.250	3.425	0.000	0.000
TRUCK DRIVER		O&C	2	21.060	0.000	1.5	1.5	2.0	7.250	3.425	0.000	0.000

TRUCK DRIVER	O&C 3	21.220	0.000	1.5	1.5	2.0	7.250	3.425	0.000	0.000
TRUCK DRIVER	O&C 4	21.420	0.000	1.5	1.5	2.0	7.250	3.425	0.000	0.000
TRUCK DRIVER	O&C 5	22.020	0.000	1.5	1.5	2.0	7.250	3.425	0.000	0.000
TUCKPOINTER	BLD	24.370	25.370	1.5	1.5	2.0	6.000	5.400	0.000	0.490

Legend:

M-F>8 (Overtime is required for any hour greater than 8 worked each day, Monday through Friday.)

OSA (Overtime is required for every hour worked on Saturday)

OSH (Overtime is required for every hour worked on Sunday and Holidays)

H/W (Health & Welfare Insurance)

Pensn (Pension)

Vac (Vacation)

Trng (Training)

## Explanations

### CASS COUNTY

The following list is considered as those days for which holiday rates of wages for work performed apply: New Years Day, Memorial/Decoration Day, Fourth of July, Labor Day, Veterans Day, Thanksgiving Day, Christmas Day. Generally, any of these holidays which fall on a Sunday is celebrated on the following Monday. This then makes work performed on that Monday payable at the appropriate overtime rate for holiday pay. Common practice in a given local may alter certain days of celebration such as the day after Thanksgiving for Veterans Day. If in doubt, please check with IDOL.

Oil and chip resealing (O&C) means the application of road oils and liquid asphalt to coat an existing road surface, followed by application of aggregate chips or gravel to coated surface, and subsequent rolling of material to seal the surface.

### EXPLANATION OF CLASSES

ASBESTOS - GENERAL - removal of asbestos material/mold and hazardous materials from any place in a building, including mechanical systems where those mechanical systems are to be removed. This includes the removal of asbestos materials/mold and hazardous materials from ductwork or pipes in a building when the building is to be demolished at the time or at some close future date.

ASBESTOS - MECHANICAL - removal of asbestos material from mechanical systems, such as pipes, ducts, and boilers, where the mechanical systems are to remain.

### CERAMIC TILE FINISHER, MARBLE FINISHER, TERRAZZO FINISHER

Assisting, helping or supporting the tile, marble and terrazzo mechanic by performing their historic and traditional work assignments required to complete the proper installation of the work covered by said crafts. The term "Ceramic" is used for naming the classification



only and is in no way a limitation of the product handled. Ceramic takes into consideration most hard tiles.

#### ELECTRONIC SYSTEMS TECHNICIAN

Installation, service and maintenance of low-voltage systems which utilizes the transmission and/or transference of voice, sound, vision, or digital for commercial, education, security and entertainment purposes for the following: TV monitoring and surveillance, background/foreground music, intercom and telephone interconnect, field programming, inventory control systems, microwave transmission, multi-media, multiplex, radio page, school, intercom and sound burglar alarms and low voltage master clock systems.

Excluded from this classification are energy management systems, life safety systems, supervisory controls and data acquisition systems not intrinsic with the above listed systems, fire alarm systems, nurse call systems and raceways exceeding fifteen feet in length.

#### TRUCK DRIVER - BUILDING, HEAVY AND HIGHWAY CONSTRUCTION

Class 1. Drivers on 2 axle trucks hauling less than 9 ton. Air compressor and welding machines and brooms, including those pulled by separate units, truck driver helpers, warehouse employees, mechanic helpers, greasers and tiremen, pickup trucks when hauling materials, tools, or workers to and from and on-the-job site, and fork lifts up to 6,000 lb. capacity.

Class 2. Two or three axle trucks hauling more than 9 ton but hauling less than 16 ton. A-frame winch trucks, hydrolift trucks, vector trucks or similar equipment when used for transportation purposes. Fork lifts over 6,000 lb. capacity, winch trucks, four axle combination units, and ticket writers.

Class 3. Two, three or four axle trucks hauling 16 ton or more. Drivers on water pulls, articulated dump trucks, mechanics and working forepersons, and dispatchers. Five axle or more combination units.

Class 4. Low Boy and Oil Distributors.

Class 5. Drivers who require special protective clothing while employed on hazardous waste work.

#### TRUCK DRIVER - OIL AND CHIP RESEALING ONLY.

This shall encompass laborers, workers and mechanics who drive contractor or subcontractor owned, leased, or hired pickup, dump, service, or oil distributor trucks. The work includes transporting materials and equipment (including but not limited to, oils, aggregate supplies, parts, machinery and tools) to or from the job site; distributing oil or liquid asphalt and aggregate; stock piling material when in connection with the actual oil and chip contract. The Truck Driver (Oil & Chip Resealing) wage classification does not include supplier delivered materials.

#### OPERATING ENGINEERS - BUILDING

CLASS 1. Asphalt Screed Man; Aspco Concrete Spreaders; Asphalt Pavers; Asphalt Plant Engineer; Asphalt Rollers on Bituminous Concrete; Athey Loaders; Backfillers, Crane Type; Backhoes; Barber Green Loaders; Bulldozers; Cableways; Cherry Pickers; Clam Shells; C.M.I. & similar type autograde formless paver, autograde placer & finisher; Concrete Breakers; Concrete Pumps; Derricks; Derrick Boats;

Draglines; Earth Auger or Boring Machines; Elevating Graders; Engineers on Dredges; Gravel Processing Machines; Head Equipment Greaser; High Lifts or Fork Lifts; Hoists with two or more drums or two or more load lines; Locomotives, All; Mechanics; Motor Graders or Auto Patrols; Operators or Leverman on Dredges; Operators, Power Boat; Operators, Pug Mill (Asphalt Plants); Orange Peels; Overhead Cranes; Paving Mixers; Piledrivers; Pipe Wrapping and Painting Machines; Pushdozers, or Push Cats; Robotic Controlled Equipment in this Classification; Rock Crushers; Ross Carrier or Similar Machines; Rotomill; Scoops, Skimmer, two cu. yd. capacity and under; Scoops, All or Tournapull; Sheep-Foot Roller (Self Propelled); Shovels; Skid Steer; Skimmer Scoops; Temporary Concrete Plant Operators; Test Hole Drilling Machines; Tower Machines; Tower Mixers; Track Type End Loaders; Track Type Fork Lifts or High Lifts; Track Jacks and Tampers; Tractors, Sideboom; Trenching or Ditching Machine; Tunnelluggers; Vermeer Type Saws; Water Blaster Cutting Head; Wheel Type End Loaders; Winch Cat.

CLASS 2. Air Compressors (six to eight)\*; Asphalt Boosters and Heaters; Asphalt Distributors; Asphalt Plant Fireman; Oiler on Two Paving Mixers When Used in Tandem; Boom or Winch Trucks; Bull Floats or Flexplanes; Concrete Finishing Machine; Concrete Saws, Self-Propelled; Concrete Spreading Machines; Conveyors (six to eight)\*; Generators (six to eight)\*; Gravel or Stone Spreader, Power Operated; Hoist (with One Drum and One Load Line); Light Plants (six to eight)\*; Mechanical Heaters (six to eight)\*; Mud Jacks; Post Hole Digger, Mechanical; Pug Mills when used for other than Asphalt operation; Robotic Controlled Equipment in this Classification; Road or Street Sweeper, Self Propelled; Rollers (except bituminous concrete); Seaman Tiller; Straw Machine; Vibratory Compactor; Water Blaster, Power Unit; Welding Machines (six to eight)\*; Well Drill Machines.

CLASS 3. Air Compressors(one to five)\*; Air Compressors, Track or Self-Propelled; Automatic Hoist; Building Elevators; Bulk Cement Batching Plants; Conveyors (one to five)\*; Concrete Mixers (Except Plant, Paver, or Tower); Firemen; Generators (one to five)\*; Greasers; Helper on Single Paving Mixer; Hoist, Automatic; Light Plants (one to five)\*; Mechanic Helpers; Mechanical Heaters (one to five)\*; Oilers; Power Form Graders; Power Sub-Graders; Robotic Controlled Equipment in this Classification; Scissors Hoist; Tractors without power attachments regardless of size or type; Truck Crane Oiler and Driver (1 man); Vibratory Hammer (power source); Water Pumps (one to five)\*; Welding Machines (1/300 Amp. or over)\*; Welding machines (one to five)\*

CLASS 4. Lattice Boom Crawler Cranes; Lattice Boom Truck Cranes; Telescopic Truck-Mounted Cranes; Tower Cranes.

\* Combinations of one to eight of any Air Compressors, Conveyors, Welding Machines, Water Pumps, Light Plants, or Generators shall be in batteries or within 400 feet and shall be paid as per the Classification Schedule contained in this Article.

#### OPERATING ENGINEERS - HIGHWAY

CLASS 1. Asphalt Screed Man; Asphco Concrete Spreaders; Asphalt Pavers; Asphalt Plant Engineer; Asphalt Rollers on Bituminous Concrete; Athey Loaders; Backhoes; Barber Green Loaders; Bulldozers; Cableways; Carry Deck Pickers; Cherry Pickers (Rough Terrain); C.M.I. & similar type-autograde formless paver, autograde placer & finisher; Concrete Breakers; Concrete Plant Operators; Concrete Pumps; Derricks;

Derrick Boats; Dewatering Systems; Earth Auger or Boring Machines; Elevating Graders; Engineers on Dredges; Gravel Processing Machines; Grout Pump; Head Equipment Greaser; High Lifts or Fork Lifts; Hoists with two or more drums or two or more load lines; Hydro Jet or Hydro Laser; Locomotives, All; Mechanics; Motor Graders or Auto Patrols; Multi-Point Power Lifting Equipment; Operators or Leverman on Dredges; Operators, Power Boat; Operators, Pug Mill (Asphalt Plants); Overhead Cranes; Paving Mixers; Piledrivers; Pipe Wrapping and Painting Machines; Push-dozers, or Push Cats; Robotic Controlled Equipment in this Classification; Rock Crushers; Ross Carrier or Similar Machines; Roto-Mill; Scoops, Skimmer, two cu. yd. capacity and under; Sheep-Foot Roller (Self Pro-pelled); Shovels; Skid Steer; Skimmer Scoops; Test Hole Drilling Machines; Tower Machines; Tower Mixers; Track Type End Loaders; Track Type Fork Lifts or High Lifts; Track Jacks and Tampers; Tractors, Side-boom; Trenching or Ditching Machine; Tunnelluggers; Vermeer-Type Saws; Wheel Type End Loaders; Winch Cat; Scoops, All or Tournapull.

CLASS 2. Air Compressors (six to eight)\*; Articulated Dumps; Asphalt Boosters and Heaters; Asphalt Distributors; Asphalt Plant Fireman; Boom or Winch Trucks; Building Elevators; Bull Floats or Flexplanes; Concrete Finishing Machine; Concrete Saws, Self-Propelled; Concrete Spreading Machines; Conveyors (six to eight)\*; Generators (six to eight)\*; Gravel or Stone Spreader, Power Operated; Hoist, Automatic; Hoist with One Drum and One Load Line; Light Plants (six to eight)\*; Mechanical Heaters (six to eight)\*; Mud Jacks; Off Road Water Wagons; Oiler on Two Paving Mixers When Used in Tandem; Post Hole Digger, Mechanical; Robotic Controlled Equipment in This Classification; Road or Street Sweeper, Self-Propelled; Rollers (except bituminous concrete); Scissor Hoist; Sea-man Tiller; Straw Machine; Vibratory Compactor; Water Pumps (six to eight)\*; Well Drill Machines.

CLASS 3. Air Compressors (one to five)\*; Air Compressors, Track or Self-Propelled; Bulk Cement Batching Plants; Conveyors (one to five)\*; Concrete Mixers (Except Plant, Paver, or Tower); Firemen; Generators (one to five)\*; Greasers; Helper on Single Paving Mixer; Light Plants (one to five)\*; Mechanic Helpers; Mechanical Heaters (one to five)\*; Oilers; Power Form Graders; Power Sub-Graders; Pug Mills when used for other than Asphalt operation; Robotic Controlled Equipment in This Classification; Tractors without power attachments, regardless of size or type; Truck Crane Oiler and Driver (1 man); Vibratory Hammer (power source); Water Pumps (one to five)\*; Welding Machines (one 300 Amp. or over)\*; Welding Machines (one to five)\*.

CLASS 4. Lattice Boom Crawler Crane; Lattice Boom Truck Crane; Telescopic Truck-Mounted Crane; Tower Crane.

\*Combinations of one to eight of any Air Compressors, Conveyors, Welding Machines, Water Pumps, Light Plants or Generators shall be in batteries or within 400 feet and shall be paid as per the Classification Schedule contained in this Article.

Other Classifications of Work:

For definitions of classifications not otherwise set out, the Department generally has on file such definitions which are available. If a task to be performed is not subject to one of the classifications of pay set out, the Department will upon being contacted state which neighboring county has such a classification and provide such rate, such rate being deemed to exist by reference in this document. If no neighboring county rate applies to the task, the Department shall undertake a special determination, such special

determination being then deemed to have existed under this determination. If a project requires these, or any classification not listed, please contact IDOL at 618/993-7271 for wage rates or clarifications.

#### LANDSCAPING

Landscaping work falls under the existing classifications for laborer, operating engineer and truck driver. The work performed by landscape plantsman and landscape laborer is covered by the existing classification of laborer. The work performed by landscape operators (regardless of equipment used or its size) is covered by the classifications of operating engineer. The work performed by landscape truck drivers (regardless of size of truck driven) is covered by the classifications of truck driver.

# Champaign County Prevailing Wage for April 2007

Trade Name	RG	TYP	C	Base	FRMAN	*M-F>8	OSA	OSH	H/W	Pensn	Vac	Trng
=====	==	==	=	=====	=====	=====	==	==	=====	=====	=====	=====
ASBESTOS ABT-GEN		BLD		24.450	25.450	1.5	1.5	2.0	5.050	6.090	0.000	0.700
ASBESTOS ABT-MEC		BLD		20.190	0.000	1.5	1.5	2.0	5.000	3.400	0.000	0.000
BOILERMAKER		BLD		30.970	33.970	2.0	2.0	2.0	8.270	7.740	0.000	0.300
BRICK MASON		BLD		25.500	27.000	1.5	1.5	2.0	5.200	6.500	0.000	0.630
CARPENTER		BLD		27.790	29.790	1.5	1.5	2.0	6.500	4.600	0.000	0.320
CARPENTER		HWY		27.740	29.490	1.5	1.5	2.0	6.500	4.600	0.000	0.300
CEMENT MASON		BLD		25.830	27.080	1.5	1.5	2.0	5.200	7.000	0.000	0.300
CEMENT MASON		HWY		24.170	25.170	1.5	1.5	2.0	5.200	7.000	0.000	0.300
CERAMIC TILE FNSHER		BLD		25.500	0.000	1.5	1.5	2.0	5.200	5.600	0.000	0.000
ELECTRIC PWR EQMT OP		ALL		30.750	0.000	1.5	1.5	2.0	4.750	8.610	0.000	0.000
ELECTRIC PWR GRNDMAN		ALL		21.090	0.000	1.5	1.5	2.0	4.750	5.905	0.000	0.000
ELECTRIC PWR LINEMAN		ALL		34.160	36.350	1.5	1.5	2.0	4.750	9.560	0.000	0.000
ELECTRIC PWR TRK DRV		ALL		22.130	0.000	1.5	1.5	2.0	4.750	6.200	0.000	0.000
ELECTRICIAN		BLD		32.010	34.010	1.5	1.5	2.0	5.150	5.410	0.000	0.480
ELECTRONIC SYS TECH		BLD		24.870	26.370	1.5	1.5	2.0	5.150	3.150	0.000	0.250
ELEVATOR CONSTRUCTOR		BLD		34.190	38.460	2.0	2.0	2.0	8.275	6.060	2.050	0.000
FENCE ERECTOR		ALL		26.420	28.170	1.5	1.5	2.0	6.590	6.150	0.000	0.500
GLAZIER		BLD		27.130	28.130	1.5	2.0	2.0	5.430	4.000	0.000	0.280
HT/FROST INSULATOR		BLD		28.470	0.000	1.5	1.5	2.0	5.040	5.800	0.000	0.130
IRON WORKER		ALL		26.420	28.170	1.5	1.5	2.0	6.590	6.150	0.000	0.500
LABORER		BLD		22.950	23.950	1.5	1.5	2.0	5.050	6.090	0.000	0.600
LABORER		HWY		23.860	24.610	1.5	1.5	2.0	5.050	6.090	0.000	0.600
LATHER		BLD		27.790	29.790	1.5	1.5	2.0	6.500	4.600	0.000	0.320
MACHINIST		BLD		36.890	38.890	2.0	2.0	2.0	4.380	5.650	2.550	0.000
MARBLE FINISHERS		BLD		25.500	0.000	1.5	1.5	2.0	5.200	5.600	0.000	0.000
MARBLE MASON		BLD		27.000	0.000	1.5	1.5	2.0	5.200	5.600	0.000	0.000
MILLWRIGHT		BLD		26.000	28.000	1.5	1.5	2.0	6.500	6.850	0.000	0.320
MILLWRIGHT		HWY		19.410	20.660	1.5	1.5	2.0	2.800	3.000	0.000	0.000
OPERATING ENGINEER		ALL	1	28.650	0.000	1.5	1.5	2.0	5.200	6.750	0.000	0.650
OPERATING ENGINEER		ALL	2	18.600	0.000	1.5	1.5	2.0	5.200	6.750	0.000	0.650
PAINTER		ALL		28.450	29.800	1.5	1.5	2.0	5.200	3.300	0.000	0.320
PAINTER SIGNS		ALL		28.450	29.800	1.5	1.5	2.0	5.200	3.300	0.000	0.320
PILEDRIVER		BLD		28.290	30.290	1.5	1.5	2.0	6.500	4.600	0.000	0.320
PILEDRIVER		HWY		28.240	29.990	1.5	1.5	2.0	6.500	4.600	0.000	0.300
PIPEFITTER		BLD		33.100	35.600	1.5	1.5	2.0	6.450	5.760	0.000	0.620
PLASTERER		BLD		23.940	25.440	1.5	1.5	2.0	5.200	8.200	0.000	0.300
PLUMBER		BLD		33.100	35.600	1.5	1.5	2.0	6.450	5.760	0.000	0.620
ROOFER		BLD		25.460	26.460	1.5	1.5	2.0	6.350	5.150	0.000	0.200
SHEETMETAL WORKER		BLD		28.600	30.600	1.5	1.5	2.0	7.150	7.330	0.000	0.520
SPRINKLER FITTER		BLD		31.240	33.240	1.5	1.5	2.0	6.500	5.350	0.000	0.250
STONE MASON		BLD		25.500	27.000	1.5	1.5	2.0	5.200	6.500	0.000	0.630
TERRAZZO FINISHER		BLD		25.500	0.000	1.5	1.5	2.0	5.200	5.600	0.000	0.000
TERRAZZO MASON		BLD		27.000	0.000	1.5	1.5	2.0	5.200	5.600	0.000	0.000
TILE MASON		BLD		27.000	0.000	1.5	1.5	2.0	5.200	5.600	0.000	0.000
TRUCK DRIVER		ALL	1	25.787	0.000	1.5	1.5	2.0	7.250	3.317	0.000	0.000
TRUCK DRIVER		ALL	2	26.187	0.000	1.5	1.5	2.0	7.250	3.317	0.000	0.000
TRUCK DRIVER		ALL	3	26.387	0.000	1.5	1.5	2.0	7.250	3.317	0.000	0.000
TRUCK DRIVER		ALL	4	26.637	0.000	1.5	1.5	2.0	7.250	3.317	0.000	0.000
TRUCK DRIVER		ALL	5	27.387	0.000	1.5	1.5	2.0	7.250	3.317	0.000	0.000
TRUCK DRIVER		O&C	1	20.630	0.000	1.5	1.5	2.0	7.250	3.317	0.000	0.000
TRUCK DRIVER		O&C	2	20.950	0.000	1.5	1.5	2.0	7.250	3.317	0.000	0.000
TRUCK DRIVER		O&C	3	21.110	0.000	1.5	1.5	2.0	7.250	3.317	0.000	0.000
TRUCK DRIVER		O&C	4	21.310	0.000	1.5	1.5	2.0	7.250	3.317	0.000	0.000
TRUCK DRIVER		O&C	5	21.910	0.000	1.5	1.5	2.0	7.250	3.317	0.000	0.000
TUCKPOINTER		BLD		25.500	27.000	1.5	1.5	2.0	5.200	6.500	0.000	0.630

Legend:

M-F>8 (Overtime is required for any hour greater than 8 worked each day, Monday through Friday.)

OSA (Overtime is required for every hour worked on Saturday)

OSH (Overtime is required for every hour worked on Sunday and Holidays)

H/W (Health & Welfare Insurance)

Pensn (Pension)

Vac (Vacation)

Trng (Training)

## Explanations

### CHAMPAIGN COUNTY

The following list is considered as those days for which holiday rates of wages for work performed apply: New Years Day, Memorial/Decoration Day, Fourth of July, Labor Day, Veterans Day, Thanksgiving Day, Christmas Day. Generally, any of these holidays which fall on a Sunday is celebrated on the following Monday. This then makes work performed on that Monday payable at the appropriate overtime rate for holiday pay. Common practice in a given local may alter certain days of celebration such as the day after Thanksgiving for Veterans Day. If in doubt, please check with IDOL.

Oil and chip resealing (O&C) means the application of road oils and liquid asphalt to coat an existing road surface, followed by application of aggregate chips or gravel to coated surface, and subsequent rolling of material to seal the surface.

### EXPLANATION OF CLASSES

ASBESTOS - GENERAL - removal of asbestos material/mold and hazardous materials from any place in a building, including mechanical systems where those mechanical systems are to be removed. This includes the removal of asbestos materials/mold and hazardous materials from ductwork or pipes in a building when the building is to be demolished at the time or at some close future date.

ASBESTOS - MECHANICAL - removal of asbestos material from mechanical systems, such as pipes, ducts, and boilers, where the mechanical systems are to remain.

### CERAMIC TILE FINISHER, MARBLE FINISHER, TERRAZZO FINISHER

Assisting, helping or supporting the tile, marble and terrazzo mechanic by performing their historic and traditional work assignments required to complete the proper installation of the work covered by said crafts. The term "Ceramic" is used for naming the classification only and is in no way a limitation of the product handled. Ceramic takes into consideration most hard tiles.

### ELECTRONIC SYSTEMS TECHNICIAN

Installation, service and maintenance of low-voltage systems which

utilizes the transmission and/or transference of voice, sound, vision, or digital for commercial, education, security and entertainment purposes for the following: TV monitoring and surveillance, background/foreground music, intercom and telephone interconnect, field programming, inventory control systems, microwave transmission, multi-media, multiplex, radio page, school, intercom and sound burglar alarms and low voltage master clock systems.

Excluded from this classification are energy management systems, life safety systems, supervisory controls and data acquisition systems not intrinsic with the above listed systems, fire alarm systems, nurse call systems and raceways exceeding fifteen feet in length.

#### TRUCK DRIVER - BUILDING, HEAVY AND HIGHWAY CONSTRUCTION

Class 1. Drivers on 2 axle trucks hauling less than 9 ton. Air compressor and welding machines and brooms, including those pulled by separate units, truck driver helpers, warehouse employees, mechanic helpers, greasers and tiremen, pickup trucks when hauling materials, tools, or workers to and from and on-the-job site, and fork lifts up to 6,000 lb. capacity.

Class 2. Two or three axle trucks hauling more than 9 ton but hauling less than 16 ton. A-frame winch trucks, hydrolift trucks, vactor trucks or similar equipment when used for transportation purposes. Fork lifts over 6,000 lb. capacity, winch trucks, four axle combination units, and ticket writers.

Class 3. Two, three or four axle trucks hauling 16 ton or more. Drivers on water pulls, articulated dump trucks, mechanics and working forepersons, and dispatchers. Five axle or more combination units.

Class 4. Low Boy and Oil Distributors.

Class 5. Drivers who require special protective clothing while employed on hazardous waste work.

#### TRUCK DRIVER - OIL AND CHIP RESEALING ONLY.

This shall encompass laborers, workers and mechanics who drive contractor or subcontractor owned, leased, or hired pickup, dump, service, or oil distributor trucks. The work includes transporting materials and equipment (including but not limited to, oils, aggregate supplies, parts, machinery and tools) to or from the job site; distributing oil or liquid asphalt and aggregate; stock piling material when in connection with the actual oil and chip contract. The Truck Driver (Oil & Chip Resealing) wage classification does not include supplier delivered materials.

#### OPERATING ENGINEERS - BUILDING, HEAVY AND HIGHWAY CONSTRUCTION

Class 1. Power Cranes, Draglines, Derricks, Shovels, Gradalls, Mechanics, Tractor Highlift, Tournadozer, Concrete Mixers with Skip, Tournamixer, Two Drum Machine, One Drum Hoist with Tower or Boom, Cableways, Tower Machines, Motor Patrol, Boom Tractor, Boom or Winch Truck, Winch or Hydraulic Boom Truck, Truck Crane, Tournapull, Tractor Operating Scoops, Bulldozer, Push Tractor, Asphalt Planer, Finishing Machine on Asphalt, Large Rollers on Earth, Rollers on Asphalt Mix, Ross Carrier or similar Machine, Gravel Processing Machine, Asphalt Plant Engineer, Paver Operator, Dredging Equipment, or Dredge Engineer, or Dredge Operator, Central Mix Plant Engineer, CMI or similar type machine, Concrete Pump, Truck or Skid Mounted, Tower Crane, Engineer or Rock Crusher Plant, Concrete Plant Engineer,

Ditching Machine with dual attachment, Tractor Mounted Loaders, Cherry Picker, Hydro Crane, Standard or Dinkey Locomotives, Scoopmobiles, Euclid Loader, Soil Cement Machine, Back Filler, Elevating Machine, Power Blade, Drilling Machine, including Well Testing, Caissons, Shaft or any similar type drilling machines, Motor Driven Paint Machine, Pipe Cleaning Machine, Pipe Wrapping Machine, Pipe Bending Machine, Apsco Paver, Boring Machine, (Head Equipment Greaser), Barber-Greene Loaders, Formless Paver, (Well Point System), Concrete Spreader, Hydra Ax, Span Saw, Marine Scoops, Brush Mulcher, Brush Burner, Mesh Placer, Tree Mover, Helicopter Crew (3), Piledriver-Skid or Crawler, Stump Remover, Root Rake, Tug Boat Operator, Refrigerating Machine, Freezing Operator, Chair Cart-Self-Propelled, Hydra Seeder, Straw Blower, Power Sub Grader, Bull Float, Finishing Machine, Self-Propelled Pavement Breaker, Lull (or similar type Machine), Two Air Compressors, Compressors hooked in Manifold, Overhead Crane, Chip Spreader, Mud Cat, Sull-Air, Fork Lifts (except when used for landscaping work), Soil Stabilizer (Seaman Tiller, Bo Mag, Rago Gator, and similar types of equipment), Tube Float, Spray Machine, Curing Machine, Concrete or Asphalt Milling Machine, Snooper Truck-Operator, Backhoe, Farm Tractors (with attachments), 4 Point Lift System (Power Lift or similar type), Skid-Steer (Bob Cat or similar type), Wrecking Shears, Water Blaster.

Class 2. Concrete Mixers without Skips, Rock Crusher, Ditching Machine under 6', Curbing Machine, One Drum Machines without Tower or Boom, Air Tugger, Self-Propelled Concrete Saw, Machine Mounted Post Hole Digger, two to four Generators, Water Pumps or Welding Machines, within 400 feet, Air Compressor 600 cu. ft. and under, Rollers on Aggregate and Seal Coat Surfaces, Fork Lift (when used for landscaping work), Concrete and Blacktop Curb Machine, One Water Pump, Oilers, Air Valves or Steam Valves, One Welding Machine, Truck Jack, Mud Jack, Gunnite Machine, House Elevators when used for hoisting material, Engine Tenders, Fireman, Wagon Drill, Flex Plane, Conveyor, Siphons and Pulsometer, Switchman, Fireman on Paint Pots, Fireman on Asphalt Plants, Distributor Operator on Trucks, Tampers, Self-Propelled Power Broom, Striping Machine (motor driven), Form Tamper, Bulk Cement Plant, Equipment Greaser, Deck Hands, Truck Crane Oiler-Driver, Cement Blimps, Form Grader, Temporary Heat, Throttle Valve, Super Sucker (and similar type of equipment).

#### Other Classifications of Work:

For definitions of classifications not otherwise set out, the Department generally has on file such definitions which are available. If a task to be performed is not subject to one of the classifications of pay set out, the Department will upon being contacted state which neighboring county has such a classification and provide such rate, such rate being deemed to exist by reference in this document. If no neighboring county rate applies to the task, the Department shall undertake a special determination, such special determination being then deemed to have existed under this determination. If a project requires these, or any classification not listed, please contact IDOL at 618/993-7271 for wage rates or clarifications.

#### LANDSCAPING

Landscaping work falls under the existing classifications for laborer, operating engineer and truck driver. The work performed by landscape plantsman and landscape laborer is covered by the existing classification of laborer. The work performed by landscape operators (regardless of equipment used or its size) is covered by the



classifications of operating engineer. The work performed by landscape truck drivers (regardless of size of truck driven) is covered by the classifications of truck driver.

# Christian County Prevailing Wage for April 2007

Trade Name	RG	TYP	C	Base	FRMAN	*M-F>8	OSA	OSH	H/W	Pensn	Vac	Trng
=====	==	==	=	=====	=====	=====	==	==	=====	=====	=====	=====
ASBESTOS ABT-GEN		BLD		24.720	25.720	1.5	1.5	2.0	5.050	5.330	0.000	0.700
ASBESTOS ABT-MEC		BLD		25.290	26.290	1.5	1.5	2.0	4.450	2.500	0.000	0.250
BOILERMAKER		BLD		28.500	31.000	1.5	1.5	2.0	6.820	11.03	0.000	0.300
BRICK MASON		BLD		24.650	25.400	2.0	2.0	2.0	6.000	6.700	0.000	0.490
CARPENTER		BLD		25.910	27.910	1.5	1.5	2.0	6.500	6.480	0.000	0.320
CARPENTER		HWY		25.750	27.500	1.5	1.5	2.0	6.500	6.500	0.000	0.300
CEMENT MASON		BLD		22.800	23.800	1.5	1.5	2.0	5.200	8.080	0.000	0.150
CEMENT MASON		HWY		22.170	23.170	1.5	1.5	2.0	5.200	7.300	0.000	0.250
CERAMIC TILE FNSHER		BLD		23.300	0.000	1.5	1.5	2.0	6.000	6.700	0.000	0.000
ELECTRIC PWR EQMT OP		ALL		30.750	0.000	1.5	1.5	2.0	4.750	8.610	0.000	0.000
ELECTRIC PWR GRNDMAN		ALL		21.090	0.000	1.5	1.5	2.0	4.750	5.905	0.000	0.000
ELECTRIC PWR LINEMAN		ALL		34.160	36.350	1.5	1.5	2.0	4.750	9.560	0.000	0.000
ELECTRIC PWR TRK DRV		ALL		22.130	0.000	1.5	1.5	2.0	4.750	6.200	0.000	0.000
ELECTRICIAN		BLD		29.480	32.420	1.5	1.5	2.0	5.150	5.300	0.000	0.440
ELECTRONIC SYS TECH		BLD		24.370	25.870	1.5	1.5	2.0	5.150	3.650	0.000	0.250
ELEVATOR CONSTRUCTOR		BLD		34.190	38.460	2.0	2.0	2.0	8.275	6.060	2.050	0.000
GLAZIER		BLD		27.130	28.130	1.5	2.0	2.0	5.430	4.000	0.000	0.280
HT/FROST INSULATOR		BLD		30.440	31.440	1.5	1.5	2.0	4.850	8.360	0.000	0.450
IRON WORKER		BLD		25.400	27.150	1.5	1.5	2.0	5.860	7.900	0.000	0.300
IRON WORKER		HWY		25.400	26.900	1.5	1.5	2.0	5.860	7.900	0.000	0.300
LABORER		BLD		23.220	24.220	1.5	1.5	2.0	5.050	5.330	0.000	0.600
LABORER		HWY		24.170	24.920	1.5	1.5	2.0	5.050	5.330	0.000	0.600
LATHER		BLD		25.910	27.910	1.5	1.5	2.0	6.500	6.480	0.000	0.320
MACHINIST		BLD		36.890	38.890	2.0	2.0	2.0	4.380	5.650	2.550	0.000
MARBLE FINISHERS		BLD		23.300	0.000	1.5	1.5	2.0	6.000	6.700	0.000	0.000
MARBLE MASON		BLD		24.800	25.550	2.0	2.0	2.0	6.000	6.700	0.000	0.000
MILLWRIGHT		BLD		26.000	28.000	1.5	1.5	2.0	6.500	6.850	0.000	0.320
MILLWRIGHT		HWY		19.270	20.520	1.5	1.5	2.0	2.800	3.000	0.000	0.000
OPERATING ENGINEER		BLD	1	26.550	0.000	1.5	1.5	2.0	6.150	6.200	0.000	0.850
OPERATING ENGINEER		BLD	2	24.200	0.000	1.5	1.5	2.0	6.150	6.200	0.000	0.850
OPERATING ENGINEER		BLD	3	20.600	0.000	1.5	1.5	2.0	6.150	6.200	0.000	0.850
OPERATING ENGINEER		BLD	4	28.050	0.000	1.5	1.5	2.0	6.150	6.200	0.000	0.850
OPERATING ENGINEER		HWY	1	26.800	0.000	1.5	1.5	2.0	6.150	6.200	0.000	0.850
OPERATING ENGINEER		HWY	2	24.030	0.000	1.5	1.5	2.0	6.150	6.200	0.000	0.850
OPERATING ENGINEER		HWY	3	19.800	0.000	1.5	1.5	2.0	6.150	6.200	0.000	0.850
OPERATING ENGINEER		HWY	4	28.300	0.000	1.5	1.5	2.0	6.150	6.200	0.000	0.850
PAINTER		ALL		25.390	26.390	1.5	1.5	2.0	4.650	5.500	0.000	0.250
PAINTER OVER 30FT		ALL		26.390	27.390	1.5	1.5	2.0	4.650	5.500	0.000	0.250
PAINTER PWR EQMT		ALL		26.390	27.390	1.5	1.5	2.0	4.650	5.500	0.000	0.250
PILEDRIVER		BLD		26.410	28.410	1.5	1.5	2.0	6.500	6.480	0.000	0.320
PILEDRIVER		HWY		26.250	28.000	1.5	1.5	2.0	6.500	6.500	0.000	0.300
PIPEFITTER	E	BLD		32.480	34.980	1.5	1.5	2.0	6.450	4.800	0.000	0.670
PIPEFITTER	W	BLD		34.700	37.200	1.5	1.5	2.0	6.450	4.750	0.000	0.350
PLASTERER		BLD		25.000	26.500	1.5	1.5	2.0	4.830	8.050	0.000	0.500
PLUMBER	E	BLD		32.480	34.980	1.5	1.5	2.0	6.450	4.800	0.000	0.670
PLUMBER	W	BLD		34.700	37.200	1.5	1.5	2.0	6.450	4.750	0.000	0.350
ROOFER		BLD		24.310	26.740	1.5	1.5	2.0	4.650	5.250	0.000	0.100
SHEETMETAL WORKER		BLD		27.200	28.950	1.5	1.5	2.0	6.900	6.960	0.000	0.550
SPRINKLER FITTER		BLD		31.240	33.240	1.5	1.5	2.0	6.500	5.350	0.000	0.250
STONE MASON		BLD		24.650	25.400	2.0	2.0	2.0	6.000	6.700	0.000	0.490
TERRAZZO FINISHER		BLD		23.300	0.000	1.5	1.5	2.0	6.000	6.700	0.000	0.000
TERRAZZO MASON		BLD		24.800	25.550	2.0	2.0	2.0	6.000	6.700	0.000	0.000
TILE MASON		BLD		24.800	25.550	2.0	2.0	2.0	6.000	6.700	0.000	0.000
TRUCK DRIVER		ALL	1	25.930	0.000	1.5	1.5	2.0	7.250	3.425	0.000	0.000
TRUCK DRIVER		ALL	2	26.330	0.000	1.5	1.5	2.0	7.250	3.425	0.000	0.000
TRUCK DRIVER		ALL	3	26.530	0.000	1.5	1.5	2.0	7.250	3.425	0.000	0.000
TRUCK DRIVER		ALL	4	26.780	0.000	1.5	1.5	2.0	7.250	3.425	0.000	0.000
TRUCK DRIVER		ALL	5	27.530	0.000	1.5	1.5	2.0	7.250	3.425	0.000	0.000

TRUCK DRIVER	O&C 1	20.740	0.000	1.5	1.5	2.0	7.250	3.425	0.000	0.000
TRUCK DRIVER	O&C 2	21.060	0.000	1.5	1.5	2.0	7.250	3.425	0.000	0.000
TRUCK DRIVER	O&C 3	21.220	0.000	1.5	1.5	2.0	7.250	3.425	0.000	0.000
TRUCK DRIVER	O&C 4	21.420	0.000	1.5	1.5	2.0	7.250	3.425	0.000	0.000
TRUCK DRIVER	O&C 5	22.020	0.000	1.5	1.5	2.0	7.250	3.425	0.000	0.000
TUCKPOINTER	BLD	24.650	25.400	2.0	2.0	2.0	6.000	6.700	0.000	0.490

Legend:

M-F>8 (Overtime is required for any hour greater than 8 worked each day, Monday through Friday.)

OSA (Overtime is required for every hour worked on Saturday)

OSH (Overtime is required for every hour worked on Sunday and Holidays)

H/W (Health & Welfare Insurance)

Pensn (Pension)

Vac (Vacation)

Trng (Training)

## Explanations

### CHRISTIAN COUNTY

PLUMBERS & PIPEFITTERS (WEST) - That area lying west of a north/south line running from the western edge of Macon County to the town of Ohlman (Montgomery County).

The following list is considered as those days for which holiday rates of wages for work performed apply: New Years Day, Memorial/Decoration Day, Fourth of July, Labor Day, Veterans Day, Thanksgiving Day, Christmas Day. Generally, any of these holidays which fall on a Sunday is celebrated on the following Monday. This then makes work performed on that Monday payable at the appropriate overtime rate for holiday pay. Common practice in a given local may alter certain days of celebration such as the day after Thanksgiving for Veterans Day. If in doubt, please check with IDOL.

Oil and chip resealing (O&C) means the application of road oils and liquid asphalt to coat an existing road surface, followed by application of aggregate chips or gravel to coated surface, and subsequent rolling of material to seal the surface.

### EXPLANATION OF CLASSES

ASBESTOS - GENERAL - removal of asbestos material/mold and hazardous materials from any place in a building, including mechanical systems where those mechanical systems are to be removed. This includes the removal of asbestos materials/mold and hazardous materials from ductwork or pipes in a building when the building is to be demolished at the time or at some close future date.

ASBESTOS - MECHANICAL - removal of asbestos material from mechanical systems, such as pipes, ducts, and boilers, where the mechanical systems are to remain.

#### CERAMIC TILE FINISHER, MARBLE FINISHER, TERRAZZO FINISHER

Assisting, helping or supporting the tile, marble and terrazzo mechanic by performing their historic and traditional work assignments required to complete the proper installation of the work covered by said crafts. The term "Ceramic" is used for naming the classification only and is in no way a limitation of the product handled. Ceramic takes into consideration most hard tiles.

#### ELECTRONIC SYSTEMS TECHNICIAN

Installation, service and maintenance of low-voltage systems which utilizes the transmission and/or transference of voice, sound, vision, or digital for commercial, education, security and entertainment purposes for the following: TV monitoring and surveillance, background/foreground music, intercom and telephone interconnect, field programming, inventory control systems, microwave transmission, multi-media, multiplex, radio page, school, intercom and sound burglar alarms and low voltage master clock systems.

Excluded from this classification are energy management systems, life safety systems, supervisory controls and data acquisition systems not intrinsic with the above listed systems, fire alarm systems, nurse call systems and raceways exceeding fifteen feet in length.

#### TRUCK DRIVER - BUILDING, HEAVY AND HIGHWAY CONSTRUCTION

Class 1. Drivers on 2 axle trucks hauling less than 9 ton. Air compressor and welding machines and brooms, including those pulled by separate units, truck driver helpers, warehouse employees, mechanic helpers, greasers and tiremen, pickup trucks when hauling materials, tools, or workers to and from and on-the-job site, and fork lifts up to 6,000 lb. capacity.

Class 2. Two or three axle trucks hauling more than 9 ton but hauling less than 16 ton. A-frame winch trucks, hydrolift trucks, vector trucks or similar equipment when used for transportation purposes. Fork lifts over 6,000 lb. capacity, winch trucks, four axle combination units, and ticket writers.

Class 3. Two, three or four axle trucks hauling 16 ton or more. Drivers on water pulls, articulated dump trucks, mechanics and working forepersons, and dispatchers. Five axle or more combination units.

Class 4. Low Boy and Oil Distributors.

Class 5. Drivers who require special protective clothing while employed on hazardous waste work.

#### TRUCK DRIVER - OIL AND CHIP RESEALING ONLY.

This shall encompass laborers, workers and mechanics who drive contractor or subcontractor owned, leased, or hired pickup, dump, service, or oil distributor trucks. The work includes transporting materials and equipment (including but not limited to, oils, aggregate supplies, parts, machinery and tools) to or from the job site; distributing oil or liquid asphalt and aggregate; stock piling material when in connection with the actual oil and chip contract. The Truck Driver (Oil & Chip Resealing) wage classification does not include supplier delivered materials.

#### OPERATING ENGINEERS - BUILDING

CLASS 1. Asphalt Screed Man; Aspco Concrete Spreaders; Asphalt Pavers; Asphalt Plant Engineer; Asphalt Rollers on Bituminous Concrete; Athey Loaders; Backfillers, Crane Type; Backhoes; Barber Green Loaders; Bulldozers; Cableways; Cherry Pickers; Clam Shells; C.M.I. & similar type autograde formless paver, autograde placer & finisher; Concrete Breakers; Concrete Pumps; Derricks; Derrick Boats; Draglines; Earth Auger or Boring Machines; Elevating Graders; Engineers on Dredges; Gravel Processing Machines; Head Equipment Greaser; High Lifts or Fork Lifts; Hoists with two or more drums or two or more load lines; Locomotives, All; Mechanics; Motor Graders or Auto Patrols; Operators or Leverman on Dredges; Operators, Power Boat; Operators, Pug Mill (Asphalt Plants); Orange Peels; Overhead Cranes; Paving Mixers; Piledrivers; Pipe Wrapping and Painting Machines; Pushdozers, or Push Cats; Robotic Controlled Equipment in this Classification; Rock Crushers; Ross Carrier or Similar Machines; Rotomill; Scoops, Skimmer, two cu. yd. capacity and under; Scoops, All or Tournapull; Sheep-Foot Roller (Self Propelled); Shovels; Skid Steer; Skimmer Scoops; Temporary Concrete Plant Operators; Test Hole Drilling Machines; Tower Machines; Tower Mixers; Track Type End Loaders; Track Type Fork Lifts or High Lifts; Track Jacks and Tampers; Tractors, Sideboom; Trenching or Ditching Machine; Tunnelluggers; Vermeer Type Saws; Water Blaster Cutting Head; Wheel Type End Loaders; Winch Cat.

CLASS 2. Air Compressors (six to eight)\*; Asphalt Boosters and Heaters; Asphalt Distributors; Asphalt Plant Fireman; Oiler on Two Paving Mixers When Used in Tandem; Boom or Winch Trucks; Bull Floats or Flexplanes; Concrete Finishing Machine; Concrete Saws, Self-Propelled; Concrete Spreading Machines; Conveyors (six to eight)\*; Generators (six to eight)\*; Gravel or Stone Spreader, Power Operated; Hoist (with One Drum and One Load Line); Light Plants (six to eight)\*; Mechanical Heaters (six to eight)\*; Mud Jacks; Post Hole Digger, Mechanical; Pug Mills when used for other than Asphalt operation; Robotic Controlled Equipment in this Classification; Road or Street Sweeper, Self Propelled; Rollers (except bituminous concrete); Seaman Tiller; Straw Machine; Vibratory Compactor; Water Blaster, Power Unit; Welding Machines (six to eight)\*; Well Drill Machines.

CLASS 3. Air Compressors(one to five)\*; Air Compressors, Track or Self-Propelled; Automatic Hoist; Building Elevators; Bulk Cement Batching Plants; Conveyors (one to five)\*; Concrete Mixers (Except Plant, Paver, or Tower); Firemen; Generators (one to five)\*; Greasers; Helper on Single Paving Mixer; Hoist, Automatic; Light Plants (one to five)\*; Mechanic Helpers; Mechanical Heaters (one to five)\*; Oilers; Power Form Graders; Power Sub-Graders; Robotic Controlled Equipment in this Classification; Scissors Hoist; Tractors without power attachments regardless of size or type; Truck Crane Oiler and Driver (1 man); Vibratory Hammer (power source); Water Pumps (one to five)\*; Welding Machines (1/300 Amp. or over)\*; Welding machines (one to five)\*

CLASS 4. Lattice Boom Crawler Cranes; Lattice Boom Truck Cranes; Telescopic Truck-Mounted Cranes; Tower Cranes.

\* Combinations of one to eight of any Air Compressors, Conveyors, Welding Machines, Water Pumps, Light Plants, or Generators shall be in batteries or within 400 feet and shall be paid as per the Classification Schedule contained in this Article.

OPERATING ENGINEERS - HIGHWAY

CLASS 1. Asphalt Screed Man; Asphco Concrete Spreaders; Asphalt Pavers; Asphalt Plant Engineer; Asphalt Rollers on Bituminous Concrete; Athey Loaders; Backhoes; Barber Green Loaders; Bulldozers; Cableways; Carry Deck Pickers; Cherry Pickers (Rough Terrain); C.M.I. & similar type-autograde formless paver, autograde placer & finisher; Concrete Breakers; Concrete Plant Operators; Concrete Pumps; Derricks; Derrick Boats; Dewatering Systems; Earth Auger or Boring Machines; Elevating Graders; Engineers on Dredges; Gravel Processing Machines; Grout Pump; Head Equipment Greaser; High Lifts or Fork Lifts; Hoists with two or more drums or two or more load lines; Hydro Jet or Hydro Laser; Locomotives, All; Mechanics; Motor Graders or Auto Patrols; Multi-Point Power Lifting Equipment; Operators or Leverman on Dredges; Operators, Power Boat; Operators, Pug Mill (Asphalt Plants); Overhead Cranes; Paving Mixers; Piledrivers; Pipe Wrapping and Painting Machines; Push-dozers, or Push Cats; Robotic Controlled Equipment in this Classification; Rock Crushers; Ross Carrier or Similar Machines; Roto-Mill; Scoops, Skimmer, two cu. yd. capacity and under; Sheep-Foot Roller (Self Pro-pelled); Shovels; Skid Steer; Skimmer Scoops; Test Hole Drilling Machines; Tower Machines; Tower Mixers; Track Type End Loaders; Track Type Fork Lifts or High Lifts; Track Jacks and Tampers; Tractors, Side-boom; Trenching or Ditching Machine; Tunnelluggers; Vermeer-Type Saws; Wheel Type End Loaders; Winch Cat; Scoops, All or Tournapull.

CLASS 2. Air Compressors (six to eight)\*; Articulated Dumps; Asphalt Boosters and Heaters; Asphalt Distributors; Asphalt Plant Fireman; Boom or Winch Trucks; Building Elevators; Bull Floats or Flexplanes; Concrete Finishing Machine; Concrete Saws, Self-Propelled; Concrete Spreading Machines; Conveyors (six to eight)\*; Generators (six to eight)\*; Gravel or Stone Spreader, Power Operated; Hoist, Automatic; Hoist with One Drum and One Load Line; Light Plants (six to eight)\*; Mechanical Heaters (six to eight)\*; Mud Jacks; Off Road Water Wagons; Oiler on Two Paving Mixers When Used in Tandem; Post Hole Digger, Mechanical; Robotic Controlled Equipment in This Classification; Road or Street Sweeper, Self-Propelled; Rollers (except bituminous concrete); Scissor Hoist; Sea-man Tiller; Straw Machine; Vibratory Compactor; Water Pumps (six to eight)\*; Well Drill Machines.

CLASS 3. Air Compressors (one to five)\*; Air Compressors, Track or Self-Propelled; Bulk Cement Batching Plants; Conveyors (one to five)\*; Concrete Mixers (Except Plant, Paver, or Tower); Firemen; Generators (one to five)\*; Greasers; Helper on Single Paving Mixer; Light Plants (one to five)\*; Mechanic Helpers; Mechanical Heaters (one to five)\*; Oilers; Power Form Graders; Power Sub-Graders; Pug Mills when used for other than Asphalt operation; Robotic Controlled Equipment in This Classification; Tractors without power attachments, regardless of size or type; Truck Crane Oiler and Driver (1 man); Vibratory Hammer (power source); Water Pumps (one to five)\*; Welding Machines (one 300 Amp. or over)\*; Welding Machines (one to five)\*.

CLASS 4. Lattice Boom Crawler Crane; Lattice Boom Truck Crane; Telescopic Truck-Mounted Crane; Tower Crane.

\*Combinations of one to eight of any Air Compressors, Conveyors, Welding Machines, Water Pumps, Light Plants or Generators shall be in batteries or within 400 feet and shall be paid as per the Classification Schedule contained in this Article.

Other Classifications of Work:

For definitions of classifications not otherwise set out, the Department generally has on file such definitions which are available.

If a task to be performed is not subject to one of the classifications of pay set out, the Department will upon being contacted state which neighboring county has such a classification and provide such rate, such rate being deemed to exist by reference in this document. If no neighboring county rate applies to the task, the Department shall undertake a special determination, such special determination being then deemed to have existed under this determination. If a project requires these, or any classification not listed, please contact IDOL at 618/993-7271 for wage rates or clarifications.

#### LANDSCAPING

Landscaping work falls under the existing classifications for laborer, operating engineer and truck driver. The work performed by landscape plantsman and landscape laborer is covered by the existing classification of laborer. The work performed by landscape operators (regardless of equipment used or its size) is covered by the classifications of operating engineer. The work performed by landscape truck drivers (regardless of size of truck driven) is covered by the classifications of truck driver.

# Clark County Prevailing Wage for April 2007

Trade Name	RG	TYP	C	Base	FRMAN	*M-F>8	OSA	OSH	H/W	Pensn	Vac	Trng
ASBESTOS ABT-GEN		BLD		24.420	25.420	1.5	1.5	2.0	5.050	5.330	0.000	0.700
ASBESTOS ABT-MEC		BLD		20.190	0.000	1.5	1.5	2.0	5.000	3.400	0.000	0.000
BOILERMAKER		BLD		28.500	31.000	1.5	1.5	2.0	6.820	11.03	0.000	0.300
BRICK MASON		BLD		24.130	25.630	2.0	2.0	2.0	5.200	5.900	0.000	0.630
CARPENTER		BLD		25.590	27.590	1.5	1.5	2.0	6.500	6.800	0.000	0.320
CARPENTER		HWY		25.040	26.790	1.5	1.5	2.0	6.500	7.300	0.000	0.300
CEMENT MASON		BLD		25.830	27.080	1.5	1.5	2.0	5.200	7.000	0.000	0.300
CEMENT MASON		HWY		24.170	25.170	1.5	1.5	2.0	5.200	7.000	0.000	0.300
CERAMIC TILE FNSHER		BLD		25.500	0.000	1.5	1.5	2.0	5.200	5.600	0.000	0.000
COMM SYSTEMS TECH		BLD		23.350	25.700	1.5	1.5	2.0	5.150	4.310	0.000	0.000
ELECTRICIAN		BLD		29.090	31.130	1.5	1.5	2.0	5.150	5.530	0.000	0.290
ELEVATOR CONSTRUCTOR		BLD		34.190	38.460	2.0	2.0	2.0	8.275	6.060	2.050	0.000
GLAZIER		BLD		24.430	25.930	1.5	1.5	2.0	4.500	4.800	0.000	0.300
HT/FROST INSULATOR		BLD		28.470	0.000	1.5	1.5	2.0	5.040	5.800	0.000	0.130
IRON WORKER		ALL		24.450	25.750	1.5	1.5	2.0	6.000	8.000	0.000	0.390
LABORER		BLD		22.920	23.920	1.5	1.5	2.0	5.050	5.330	0.000	0.600
LABORER		HWY		24.220	24.970	1.5	1.5	2.0	5.050	5.330	0.000	0.600
LATHER		BLD		25.590	27.590	1.5	1.5	2.0	6.500	6.800	0.000	0.320
MACHINIST		BLD		36.890	38.890	2.0	2.0	2.0	4.380	5.650	2.550	0.000
MARBLE FINISHERS		BLD		25.500	0.000	1.5	1.5	2.0	5.200	5.600	0.000	0.000
MARBLE MASON		BLD		27.000	0.000	1.5	1.5	2.0	5.200	5.600	0.000	0.000
MILLWRIGHT		BLD		26.000	28.000	1.5	1.5	2.0	6.500	6.850	0.000	0.320
MILLWRIGHT		HWY		19.410	20.660	1.5	1.5	2.0	2.800	3.000	0.000	0.000
OPERATING ENGINEER		ALL	1	28.650	0.000	1.5	1.5	2.0	5.200	6.750	0.000	0.650
OPERATING ENGINEER		ALL	2	18.600	0.000	1.5	1.5	2.0	5.200	6.750	0.000	0.650
PAINTER		ALL		23.000	24.000	1.5	1.5	2.0	5.500	6.200	0.000	0.180
PILEDRIVER		BLD		26.090	28.090	1.5	1.5	2.0	6.500	6.800	0.000	0.320
PILEDRIVER		HWY		25.540	27.290	1.5	1.5	2.0	6.500	7.300	0.000	0.300
PIPEFITTER		ALL		28.850	31.010	1.5	1.5	2.0	5.450	4.750	0.000	0.510
PLASTERER		BLD		23.940	25.440	1.5	1.5	2.0	5.200	8.200	0.000	0.300
PLUMBER		ALL		28.850	31.010	1.5	1.5	2.0	5.450	4.750	0.000	0.510
ROOFER		BLD		25.460	26.460	1.5	1.5	2.0	6.350	5.150	0.000	0.200
SHEETMETAL WORKER		BLD		27.010	28.360	1.5	1.5	2.0	6.150	5.150	0.000	0.480
SPRINKLER FITTER		BLD		31.240	33.240	1.5	1.5	2.0	6.500	5.350	0.000	0.250
STONE MASON		BLD		24.130	25.630	2.0	2.0	2.0	5.200	5.900	0.000	0.630
TERRAZZO FINISHER		BLD		25.500	0.000	1.5	1.5	2.0	5.200	5.600	0.000	0.000
TERRAZZO MASON		BLD		27.000	0.000	1.5	1.5	2.0	5.200	5.600	0.000	0.000
TILE LAYER		BLD		25.590	27.590	1.5	1.5	2.0	6.500	6.800	0.000	0.320
TILE MASON		BLD		27.000	0.000	1.5	1.5	2.0	5.200	5.600	0.000	0.000
TRUCK DRIVER		ALL	1	25.010	0.000	1.5	1.5	2.0	6.500	2.225	0.000	0.000
TRUCK DRIVER		ALL	2	25.410	0.000	1.5	1.5	2.0	6.500	2.225	0.000	0.000
TRUCK DRIVER		ALL	3	25.610	0.000	1.5	1.5	2.0	6.500	2.225	0.000	0.000
TRUCK DRIVER		ALL	4	25.860	0.000	1.5	1.5	2.0	6.500	2.225	0.000	0.000
TRUCK DRIVER		ALL	5	26.610	0.000	1.5	1.5	2.0	6.500	2.225	0.000	0.000
TRUCK DRIVER		O&C	1	20.010	0.000	1.5	1.5	2.0	6.500	2.225	0.000	0.000
TRUCK DRIVER		O&C	2	20.330	0.000	1.5	1.5	2.0	6.500	2.225	0.000	0.000
TRUCK DRIVER		O&C	3	20.490	0.000	1.5	1.5	2.0	6.500	2.225	0.000	0.000
TRUCK DRIVER		O&C	4	20.690	0.000	1.5	1.5	2.0	6.500	2.225	0.000	0.000
TRUCK DRIVER		O&C	5	21.290	0.000	1.5	1.5	2.0	6.500	2.225	0.000	0.000
TUCKPOINTS		BLD		24.130	25.630	2.0	2.0	2.0	5.200	5.900	0.000	0.630

Legend:

M-F>8 (Overtime is required for any hour greater than 8 worked each day, Monday through Friday.)

OSA (Overtime is required for every hour worked on Saturday)



OSH (Overtime is required for every hour worked on Sunday and Holidays)

H/W (Health & Welfare Insurance)

Pensn (Pension)

Vac (Vacation)

Trng (Training)

## Explanations

### CLARK COUNTY

The following list is considered as those days for which holiday rates of wages for work performed apply: New Years Day, Memorial/Decoration Day, Fourth of July, Labor Day, Veterans Day, Thanksgiving Day, Christmas Day. Generally, any of these holidays which fall on a Sunday is celebrated on the following Monday. This then makes work performed on that Monday payable at the appropriate overtime rate for holiday pay. Common practice in a given local may alter certain days of celebration such as the day after Thanksgiving for Veterans Day. If in doubt, please check with IDOL.

Oil and chip resealing (O&C) means the application of road oils and liquid asphalt to coat an existing road surface, followed by application of aggregate chips or gravel to coated surface, and subsequent rolling of material to seal the surface.

### EXPLANATION OF CLASSES

ASBESTOS - GENERAL - removal of asbestos material/mold and hazardous materials from any place in a building, including mechanical systems where those mechanical systems are to be removed. This includes the removal of asbestos materials/mold and hazardous materials from ductwork or pipes in a building when the building is to be demolished at the time or at some close future date.

ASBESTOS - MECHANICAL - removal of asbestos material from mechanical systems, such as pipes, ducts, and boilers, where the mechanical systems are to remain.

### CERAMIC TILE FINISHER, MARBLE FINISHER, TERRAZZO FINISHER

Assisting, helping or supporting the tile, marble and terrazzo mechanic by performing their historic and traditional work assignments required to complete the proper installation of the work covered by said crafts. The term "Ceramic" is used for naming the classification only and is in no way a limitation of the product handled. Ceramic takes into consideration most hard tiles.

### COMMUNICATION SYSTEMS TECHNICIAN

Installation, operation, inspection, maintenance, repair, and service of radio, television, recording, voice sound and vision production and reproduction apparatus, equipment and appliances used for domestic, commercial, education, entertainment and private telephone systems.

### TRUCK DRIVER - BUILDING, HEAVY AND HIGHWAY CONSTRUCTION

Class 1. Drivers on 2 axle trucks hauling less than 9 ton. Air compressor and welding machines and brooms, including those pulled by

separate units, truck driver helpers, warehouse employees, mechanic helpers, greasers and tiremen, pickup trucks when hauling materials, tools, or workers to and from and on-the-job site, and fork lifts up to 6,000 lb. capacity.

Class 2. Two or three axle trucks hauling more than 9 ton but hauling less than 16 ton. A-frame winch trucks, hydrolift trucks, vactor trucks or similar equipment when used for transportation purposes. Fork lifts over 6,000 lb. capacity, winch trucks, four axle combination units, and ticket writers.

Class 3. Two, three or four axle trucks hauling 16 ton or more. Drivers on water pulls, articulated dump trucks, mechanics and working forepersons, and dispatchers. Five axle or more combination units.

Class 4. Low Boy and Oil Distributors.

Class 5. Drivers who require special protective clothing while employed on hazardous waste work.

TRUCK DRIVER - OIL AND CHIP RESEALING ONLY.

This shall encompass laborers, workers and mechanics who drive contractor or subcontractor owned, leased, or hired pickup, dump, service, or oil distributor trucks. The work includes transporting materials and equipment (including but not limited to, oils, aggregate supplies, parts, machinery and tools) to or from the job site; distributing oil or liquid asphalt and aggregate; stock piling material when in connection with the actual oil and chip contract. The Truck Driver (Oil & Chip Resealing) wage classification does not include supplier delivered materials.

OPERATING ENGINEERS - BUILDING, HEAVY AND HIGHWAY CONSTRUCTION

Class 1. Power Cranes, Draglines, Derricks, Shovels, Gradalls, Mechanics, Tractor Highlift, Tournadozer, Concrete Mixers with Skip, Tournamixer, Two Drum Machine, One Drum Hoist with Tower or Boom, Cableways, Tower Machines, Motor Patrol, Boom Tractor, Boom or Winch Truck, Winch or Hydraulic Boom Truck, Truck Crane, Tournapull, Tractor Operating Scoops, Bulldozer, Push Tractor, Asphalt Planer, Finishing Machine on Asphalt, Large Rollers on Earth, Rollers on Asphalt Mix, Ross Carrier or similar Machine, Gravel Processing Machine, Asphalt Plant Engineer, Paver Operator, Dredging Equipment, or Dredge Engineer, or Dredge Operator, Central Mix Plant Engineer, CMI or similar type machine, Concrete Pump, Truck or Skid Mounted, Tower Crane, Engineer or Rock Crusher Plant, Concrete Plant Engineer, Ditching Machine with dual attachment, Tractor Mounted Loaders, Cherry Picker, Hydro Crane, Standard or Dinkey Locomotives, Scoopmobiles, Euclid Loader, Soil Cement Machine, Back Filler, Elevating Machine, Power Blade, Drilling Machine, including Well Testing, Caissons, Shaft or any similar type drilling machines, Motor Driven Paint Machine, Pipe Cleaning Machine, Pipe Wrapping Machine, Pipe Bending Machine, Apsco Paver, Boring Machine, (Head Equipment Greaser), Barber-Greene Loaders, Formless Paver, (Well Point System), Concrete Spreader, Hydra Ax, Span Saw, Marine Scoops, Brush Mulcher, Brush Burner, Mesh Placer, Tree Mover, Helicopter Crew (3), Piledriver-Skid or Crawler, Stump Remover, Root Rake, Tug Boat Operator, Refrigerating Machine, Freezing Operator, Chair Cart-Self-Propelled, Hydra Seeder, Straw Blower, Power Sub Grader, Bull Float, Finishing Machine, Self-Propelled Pavement Breaker, Lull (or similar type Machine), Two Air Compressors, Compressors hooked in Manifold, Overhead Crane, Chip Spreader, Mud Cat, Sull-Air, Fork Lifts (except when used for landscaping work), Soil Stabilizer (Seaman

Tiller, Bo Mag, Rago Gator, and similar types of equipment), Tube Float, Spray Machine, Curing Machine, Concrete or Asphalt Milling Machine, Snooper Truck-Operator, Backhoe, Farm Tractors (with attachments), 4 Point Lift System (Power Lift or similar type), Skid-Steer (Bob Cat or similar type), Wrecking Shears, Water Blaster.

Class 2. Concrete Mixers without Skips, Rock Crusher, Ditching Machine under 6', Curbing Machine, One Drum Machines without Tower or Boom, Air Tugger, Self-Propelled Concrete Saw, Machine Mounted Post Hole Digger, two to four Generators, Water Pumps or Welding Machines, within 400 feet, Air Compressor 600 cu. ft. and under, Rollers on Aggregate and Seal Coat Surfaces, Fork Lift (when used for landscaping work), Concrete and Blacktop Curb Machine, One Water Pump, Oilers, Air Valves or Steam Valves, One Welding Machine, Truck Jack, Mud Jack, Gunnite Machine, House Elevators when used for hoisting material, Engine Tenders, Fireman, Wagon Drill, Flex Plane, Conveyor, Siphons and Pulsometer, Switchman, Fireman on Paint Pots, Fireman on Asphalt Plants, Distributor Operator on Trucks, Tampers, Self-Propelled Power Broom, Striping Machine (motor driven), Form Tamper, Bulk Cement Plant, Equipment Greaser, Deck Hands, Truck Crane Oiler-Driver, Cement Blimps, Form Grader, Temporary Heat, Throttle Valve, Super Sucker (and similar type of equipment).

#### Other Classifications of Work:

For definitions of classifications not otherwise set out, the Department generally has on file such definitions which are available. If a task to be performed is not subject to one of the classifications of pay set out, the Department will upon being contacted state which neighboring county has such a classification and provide such rate, such rate being deemed to exist by reference in this document. If no neighboring county rate applies to the task, the Department shall undertake a special determination, such special determination being then deemed to have existed under this determination. If a project requires these, or any classification not listed, please contact IDOL at 618/993-7271 for wage rates or clarifications.

#### LANDSCAPING

Landscaping work falls under the existing classifications for laborer, operating engineer and truck driver. The work performed by landscape plantsman and landscape laborer is covered by the existing classification of laborer. The work performed by landscape operators (regardless of equipment used or its size) is covered by the classifications of operating engineer. The work performed by landscape truck drivers (regardless of size of truck driven) is covered by the classifications of truck driver.

# Clay County Prevailing Wage for April 2007

Trade Name	RG	TYP	C	Base	FRMAN	*M-F>8	OSA	OSH	H/W	Pensn	Vac	Trng
ASBESTOS ABT-GEN		ALL		20.750	21.200	1.5	1.5	2.0	5.250	5.600	0.000	0.700
ASBESTOS ABT-MEC		BLD		20.800	0.000	2.0	2.0	2.0	5.000	3.400	0.000	0.000
BOILERMAKER		BLD		28.500	31.000	1.5	1.5	2.0	6.820	11.03	0.000	0.300
BRICK MASON		BLD		25.470	26.970	1.5	1.5	2.0	6.000	5.400	0.000	0.425
CARPENTER		BLD		27.780	29.280	1.5	1.5	2.0	5.050	3.750	0.000	0.350
CARPENTER		HWY		27.730	29.480	1.5	1.5	2.0	5.050	3.750	0.000	0.350
CEMENT MASON		BLD		23.500	24.500	1.5	1.5	2.0	5.200	3.550	0.000	0.100
CEMENT MASON		HWY		23.500	25.000	1.5	1.5	2.0	5.200	2.750	0.000	0.200
CERAMIC TILE FNSHER		BLD		24.990	0.000	1.5	1.5	2.0	6.000	5.400	0.000	0.425
ELECTRICIAN		ALL		32.910	35.160	1.5	1.5	2.0	5.150	6.580	0.000	0.490
ELECTRONIC SYS TECH		BLD		25.700	27.200	1.5	1.5	2.0	5.150	3.340	0.000	0.250
FLOOR LAYER		BLD		26.930	27.680	1.5	1.5	2.0	5.000	3.750	0.000	0.350
GLAZIER		BLD		22.930	0.000	1.5	1.5	2.0	4.320	3.800	0.000	0.300
HT/FROST INSULATOR		BLD		26.110	27.110	1.5	1.5	2.0	4.800	6.860	0.000	0.190
IRON WORKER		ALL		24.000	25.250	1.5	1.5	2.0	5.780	6.850	0.000	0.345
LABORER		BLD		20.750	21.200	1.5	1.5	2.0	5.250	5.600	0.000	0.600
LABORER		HWY		21.000	21.450	1.5	1.5	2.0	5.350	6.150	0.000	0.600
MACHINIST		BLD		36.890	38.890	2.0	2.0	2.0	4.380	5.650	2.550	0.000
MARBLE FINISHERS		BLD		24.990	0.000	1.5	1.5	2.0	6.000	5.400	0.000	0.425
MARBLE MASON		BLD		25.470	26.970	1.5	1.5	2.0	6.000	5.400	0.000	0.425
MILLWRIGHT		BLD		27.780	29.280	1.5	1.5	2.0	5.050	3.750	0.000	0.350
MILLWRIGHT		HWY		28.230	29.980	1.5	1.5	2.0	5.050	3.750	0.000	0.350
OPERATING ENGINEER		ALL	1	28.650	0.000	1.5	1.5	2.0	5.200	6.750	0.000	0.650
OPERATING ENGINEER		ALL	2	18.600	0.000	1.5	1.5	2.0	5.200	6.750	0.000	0.650
PAINTER		ALL		20.700	21.200	1.5	1.5	2.0	4.650	4.200	0.000	0.250
PAINTER OVER 30FT		ALL		23.800	24.300	1.5	1.5	2.0	4.650	4.200	0.000	0.250
PAINTER PWR EQMT		ALL		23.800	24.300	1.5	1.5	2.0	4.650	4.200	0.000	0.250
PILEDRIVER		BLD		27.780	29.280	1.5	1.5	2.0	5.050	3.750	0.000	0.350
PILEDRIVER		HWY		28.230	29.980	1.5	1.5	2.0	5.050	3.750	0.000	0.350
PIPEFITTER		BLD		29.500	31.500	1.5	1.5	2.0	5.000	4.850	0.000	0.800
PLASTERER		BLD		23.500	24.500	1.5	1.5	2.0	5.200	3.550	0.000	0.100
PLUMBER		BLD		29.500	31.500	1.5	1.5	2.0	5.000	4.850	0.000	0.800
ROOFER		BLD		22.350	24.850	1.5	1.5	2.0	6.000	5.550	0.000	0.550
SHEETMETAL WORKER		ALL		27.210	28.460	1.5	1.5	2.0	6.000	4.770	1.630	0.120
SPRINKLER FITTER		BLD		31.240	33.240	1.5	1.5	2.0	6.500	5.350	0.000	0.250
STONE MASON		BLD		25.470	26.970	1.5	1.5	2.0	6.000	5.400	0.000	0.425
TERRAZZO FINISHER		BLD		24.990	0.000	1.5	1.5	2.0	6.000	5.400	0.000	0.425
TERRAZZO MASON		BLD		25.470	26.970	1.5	1.5	2.0	6.000	5.400	0.000	0.425
TILE MASON		BLD		25.470	26.970	1.5	1.5	2.0	6.000	5.400	0.000	0.425
TRUCK DRIVER		ALL	1	25.930	0.000	1.5	1.5	2.0	7.250	3.425	0.000	0.000
TRUCK DRIVER		ALL	2	26.330	0.000	1.5	1.5	2.0	7.250	3.425	0.000	0.000
TRUCK DRIVER		ALL	3	26.530	0.000	1.5	1.5	2.0	7.250	3.425	0.000	0.000
TRUCK DRIVER		ALL	4	26.780	0.000	1.5	1.5	2.0	7.250	3.425	0.000	0.000
TRUCK DRIVER		ALL	5	27.530	0.000	1.5	1.5	2.0	7.250	3.425	0.000	0.000
TUCKPOINTER		BLD		25.470	26.970	1.5	1.5	2.0	6.000	5.400	0.000	0.425

Legend :

M-F>8 (Overtime is required for any hour greater than 8 worked each day, Monday through Friday.)

OSA (Overtime is required for every hour worked on Saturday)

OSH (Overtime is required for every hour worked on Sunday and Holidays)

H/W (Health & Welfare Insurance)

Pensn (Pension)

Vac (Vacation)

Trng (Training)

## Explanations

### CLAY COUNTY

The following list is considered as those days for which holiday rates of wages for work performed apply: New Years Day, Memorial/Decoration Day, Fourth of July, Labor Day, Veterans Day, Thanksgiving Day, Christmas Day. Generally, any of these holidays which fall on a Sunday is celebrated on the following Monday. This then makes work performed on that Monday payable at the appropriate overtime rate for holiday pay. Common practice in a given local may alter certain days of celebration such as the day after Thanksgiving for Veterans Day. If in doubt, please check with IDOL.

### EXPLANATION OF CLASSES

ASBESTOS - GENERAL - removal of asbestos material/mold and hazardous materials from any place in a building, including mechanical systems where those mechanical systems are to be removed. This includes the removal of asbestos materials/mold and hazardous materials from ductwork or pipes in a building when the building is to be demolished at the time or at some close future date.

ASBESTOS - MECHANICAL - removal of asbestos material from mechanical systems, such as pipes, ducts, and boilers, where the mechanical systems are to remain.

### CERAMIC TILE FINISHER, MARBLE FINISHER, TERRAZZO FINISHER

Assisting, helping or supporting the tile, marble and terrazzo mechanic by performing their historic and traditional work assignments required to complete the proper installation of the work covered by said crafts. The term "Ceramic" is used for naming the classification only, and is in no a limitation of the product handled. Ceramic takes into consideration most hard tiles.

### ELECTRONIC SYSTEMS TECHNICIAN

Installation, service and maintenance of low-voltage systems which utilizes the transmission and/or transference of voice, sound, vision, or digital for commercial, education, security and entertainment purposes for the following: TV monitoring and surveillance, background/foreground music, intercom and telephone interconnect, field programming, inventory control systems, microwave transmission, multi-media, multiplex, radio page, school, intercom and sound burglar alarms and low voltage master clock systems.

Excluded from this classification are energy management systems, life safety systems, supervisory controls and data acquisition systems not intrinsic with the above listed systems, fire alarm systems, nurse call systems and raceways exceeding fifteen feet in length.

### TRUCK DRIVER - BUILDING, HEAVY AND HIGHWAY CONSTRUCTION

Class 1. Drivers on 2 axle trucks hauling less than 9 ton. Air compressor and welding machines and brooms, including those pulled by separate units, truck driver helpers, warehouse employees, mechanic helpers, greasers and tiremen, pickup trucks when hauling materials, tools, or workers to and from and on-the-job site, and fork lifts up to 6,000 lb. capacity.

Class 2. Two or three axle trucks hauling more than 9 ton but hauling less than 16 ton. A-frame winch trucks, hydrolift trucks, vactor trucks or similar equipment when used for transportation purposes. Fork lifts over 6,000 lb. capacity, winch trucks, four axle combination units, and ticket writers.

Class 3. Two, three or four axle trucks hauling 16 ton or more. Drivers on water pulls, articulated dump trucks, mechanics and working forepersons, and dispatchers. Five axle or more combination units.

Class 4. Low Boy and Oil Distributors.

Class 5. Drivers who require special protective clothing while employed on hazardous waste work.

#### OPERATING ENGINEERS - BUILDING, HEAVY AND HIGHWAY CONSTRUCTION

Class 1. Power Cranes, Draglines, Derricks, Shovels, Gradalls, Mechanics, Tractor Highlift, Tournadozer, Concrete Mixers with Skip, Tournamixer, Two Drum Machine, One Drum Hoist with Tower or Boom, Cableways, Tower Machines, Motor Patrol, Boom Tractor, Boom or Winch Truck, Winch or Hydraulic Boom Truck, Truck Crane, Tournapull, Tractor Operating Scoops, Bulldozer, Push Tractor, Asphalt Planer, Finishing Machine on Asphalt, Large Rollers on Earth, Rollers on Asphalt Mix, Ross Carrier or similar Machine, Gravel Processing Machine, Asphalt Plant Engineer, Paver Operator, Dredging Equipment, or Dredge Engineer, or Dredge Operator, Central Mix Plant Engineer, CMI or similar type machine, Concrete Pump, Truck or Skid Mounted, Tower Crane, Engineer or Rock Crusher Plant, Concrete Plant Engineer, Ditching Machine with dual attachment, Tractor Mounted Loaders, Cherry Picker, Hydro Crane, Standard or Dinkey Locomotives, Scoopmobiles, Euclid Loader, Soil Cement Machine, Back Filler, Elevating Machine, Power Blade, Drilling Machine, including Well Testing, Caissons, Shaft or any similar type drilling machines, Motor Driven Paint Machine, Pipe Cleaning Machine, Pipe Wrapping Machine, Pipe Bending Machine, Apsco Paver, Boring Machine, (Head Equipment Greaser), Barber-Greene Loaders, Formless Paver, (Well Point System), Concrete Spreader, Hydra Ax, Span Saw, Marine Scoops, Brush Mulcher, Brush Burner, Mesh Placer, Tree Mover, Helicopter Crew (3), Piledriver-Skid or Crawler, Stump Remover, Root Rake, Tug Boat Operator, Refrigerating Machine, Freezing Operator, Chair Cart-Self-Propelled, Hydra Seeder, Straw Blower, Power Sub Grader, Bull Float, Finishing Machine, Self-Propelled Pavement Breaker, Lull (or similar type Machine), Two Air Compressors, Compressors hooked in Manifold, Overhead Crane, Chip Spreader, Mud Cat, Sull-Air, Fork Lifts (except when used for landscaping work), Soil Stabilizer (Seaman Tiller, Bo Mag, Rago Gator, and similar types of equipment), Tube Float, Spray Machine, Curing Machine, Concrete or Asphalt Milling Machine, Snooper Truck-Operator, Backhoe, Farm Tractors (with attachments), 4 Point Lift System (Power Lift or similar type), Skid-Steer (Bob Cat or similar type), Wrecking Shears, Water Blaster.

Class 2. Concrete Mixers without Skips, Rock Crusher, Ditching Machine under 6', Curbing Machine, One Drum Machines without Tower or Boom, Air Tugger, Self-Propelled Concrete Saw, Machine Mounted Post Hole Digger, two to four Generators, Water Pumps or Welding Machines, within 400 feet, Air Compressor 600 cu. ft. and under, Rollers on

Aggregate and Seal Coat Surfaces, Fork Lift (when used for landscaping work), Concrete and Blacktop Curb Machine, One Water Pump, Oilers, Air Valves or Steam Valves, One Welding Machine, Truck Jack, Mud Jack, Gunnite Machine, House Elevators when used for hoisting material, Engine Tenders, Fireman, Wagon Drill, Flex Plane, Conveyor, Siphons and Pulsometer, Switchman, Fireman on Paint Pots, Fireman on Asphalt Plants, Distributor Operator on Trucks, Tampers, Self-Propelled Power Broom, Striping Machine (motor driven), Form Tamper, Bulk Cement Plant, Equipment Greaser, Deck Hands, Truck Crane Oiler-Driver, Cement Blimps, Form Grader, Temporary Heat, Throttle Valve, Super Sucker (and similar type of equipment).

#### Other Classifications of Work:

For definitions of classifications not otherwise set out, the Department generally has on file such definitions which are available. If a task to be performed is not subject to one of the classifications of pay set out, the Department will upon being contacted state which neighboring county has such a classification and provide such rate, such rate being deemed to exist by reference in this document. If no neighboring county rate applies to the task, the Department shall undertake a special determination, such special determination being then deemed to have existed under this determination. If a project requires these, or any classification not listed, please contact IDOL at 618/993-7271 for wage rates or clarifications.

#### LANDSCAPING

Landscaping work falls under the existing classifications for laborer, operating engineer and truck driver. The work performed by landscape plantsman and landscape laborer is covered by the existing classification of laborer. The work performed by landscape operators (regardless of equipment used or its size) is covered by the classifications of operating engineer. The work performed by landscape truck drivers (regardless of size of truck driven) is covered by the classifications of truck driver.

# Clinton County Prevailing Wage for April 2007

Trade Name	RG	TYP	C	Base	FRMAN	*M-F>8	OSA	OSH	H/W	Pensn	Vac	Trng
=====	==	==	=	=====	=====	=====	==	==	=====	=====	=====	=====
ASBESTOS ABT-GEN		ALL		22.800	23.300	1.5	1.5	2.0	5.250	8.000	0.000	0.600
ASBESTOS ABT-MEC		BLD		25.290	26.290	1.5	1.5	2.0	4.450	2.500	0.000	0.250
BOILERMAKER		BLD		28.500	31.000	1.5	1.5	2.0	6.820	11.03	0.000	0.300
BRICK MASON		BLD		26.400	28.100	1.5	1.5	5.0	4.750	8.250	2.000	0.390
CARPENTER		ALL		30.480	31.980	1.5	1.5	2.0	5.050	3.750	0.000	0.350
CEMENT MASON		ALL		26.750	27.500	1.5	1.5	2.0	5.650	8.250	0.000	0.200
CERAMIC TILE FNSHER		BLD		22.610	0.000	1.5	1.5	2.0	5.000	4.300	0.000	0.400
ELECTRIC PWR EQMT OP		ALL		31.510	37.980	1.5	2.0	2.0	4.530	7.880	0.000	0.160
ELECTRIC PWR GRNDMAN		ALL		23.530	37.980	1.5	2.0	2.0	3.380	5.890	0.000	0.120
ELECTRIC PWR LINEMAN		ALL		36.220	37.980	1.5	2.0	2.0	5.210	9.060	0.000	0.180
ELECTRIC PWR TRK DRV		ALL		25.710	37.980	1.5	2.0	2.0	3.700	6.430	0.000	0.130
ELECTRICIAN	E	ALL		32.910	35.160	1.5	1.5	2.0	5.150	6.580	0.000	0.490
ELECTRICIAN	W	ALL		32.590	34.550	1.5	1.5	2.0	5.210	6.360	0.000	0.490
ELECTRONIC SYS TECH	E	BLD		25.700	27.200	1.5	1.5	2.0	5.150	3.340	0.000	0.250
ELECTRONIC SYS TECH	W	BLD		25.810	27.310	1.5	1.5	2.0	2.800	5.490	0.000	0.250
ELEVATOR CONSTRUCTOR		BLD		37.115	41.750	2.0	2.0	2.0	8.275	4.460	2.227	0.000
FLOOR LAYER		BLD		26.930	27.680	1.5	1.5	2.0	5.000	3.750	0.000	0.350
GLAZIER		BLD		29.480	0.000	2.0	2.0	2.0	8.550	6.920	2.360	0.160
HT/FROST INSULATOR		BLD		30.440	31.440	1.5	1.5	2.0	4.850	8.360	0.000	0.450
IRON WORKER		ALL		26.350	27.850	1.5	1.5	2.0	6.360	8.250	0.000	0.420
LABORER		ALL		22.300	22.800	1.5	1.5	2.0	5.250	8.000	0.000	0.600
MACHINIST		BLD		36.890	38.890	2.0	2.0	2.0	4.380	5.650	2.550	0.000
MARBLE FINISHERS		BLD		22.610	0.000	1.5	1.5	2.0	5.000	4.300	0.000	0.400
MILLWRIGHT		ALL		30.480	31.980	1.5	1.5	2.0	5.050	3.750	0.000	0.350
OPERATING ENGINEER		ALL	1	25.900	27.030	1.5	1.5	2.0	6.200	11.45	0.000	1.000
OPERATING ENGINEER		ALL	2	24.770	27.030	1.5	1.5	2.0	6.200	11.45	0.000	1.000
OPERATING ENGINEER		ALL	3	20.290	27.030	1.5	1.5	2.0	6.200	11.45	0.000	1.000
OPERATING ENGINEER		ALL	4	20.350	27.030	1.5	1.5	2.0	6.200	11.45	0.000	1.000
OPERATING ENGINEER		ALL	5	20.020	27.030	1.5	1.5	2.0	6.200	11.45	0.000	1.000
OPERATING ENGINEER		ALL	6	26.450	27.030	1.5	1.5	2.0	6.200	11.45	0.000	1.000
OPERATING ENGINEER		ALL	7	26.750	27.030	1.5	1.5	2.0	6.200	11.45	0.000	1.000
OPERATING ENGINEER		ALL	8	27.030	27.030	1.5	1.5	2.0	6.200	11.45	0.000	1.000
PAINTER		BLD		25.700	26.700	1.5	1.5	2.0	4.650	5.150	0.000	0.350
PAINTER		HWY		26.800	27.800	1.5	1.5	2.0	4.650	5.150	0.000	0.350
PAINTER OVER 30FT		BLD		26.700	27.700	1.5	1.5	2.0	4.650	5.150	0.000	0.350
PAINTER PWR EQMT		BLD		26.700	27.700	1.5	1.5	2.0	4.650	5.150	0.000	0.350
PAINTER PWR EQMT		HWY		27.800	28.800	1.5	1.5	2.0	4.650	5.150	0.000	0.350
PILEDRIVER		ALL		30.480	31.980	1.5	1.5	2.0	5.050	3.750	0.000	0.350
PIPEFITTER	E	BLD		29.500	31.500	1.5	1.5	2.0	5.000	4.850	0.000	0.800
PIPEFITTER	NW	BLD		30.000	32.000	1.5	1.5	2.0	5.940	7.000	0.000	0.350
PIPEFITTER	SW	BLD		31.000	33.500	1.5	1.5	2.0	5.800	3.950	0.000	0.475
PLASTERER		BLD		27.000	28.000	1.5	1.5	2.0	5.650	7.250	0.000	0.250
PLUMBER	E	BLD		29.500	31.500	1.5	1.5	2.0	5.000	4.850	0.000	0.800
PLUMBER	NW	BLD		30.450	32.950	1.5	1.5	2.0	4.950	5.450	0.000	0.300
PLUMBER	SW	BLD		31.000	33.500	1.5	1.5	2.0	5.800	3.950	0.000	0.475
ROOFER		BLD		26.250	28.250	1.5	1.5	2.0	6.100	5.950	0.000	0.200
SHEETMETAL WORKER		ALL		27.210	28.460	1.5	1.5	2.0	6.000	4.770	1.630	0.120
SPRINKLER FITTER		BLD		34.230	36.480	2.0	2.0	2.0	6.650	7.850	0.000	0.650
TERRAZZO FINISHER		BLD		31.240	0.000	1.5	1.5	2.0	0.000	0.000	0.000	0.000
TERRAZZO MASON		BLD		30.780	31.080	1.5	1.5	2.0	0.000	3.750	0.000	0.000
TRUCK DRIVER		ALL	1	25.930	0.000	1.5	1.5	2.0	7.250	3.425	0.000	0.000
TRUCK DRIVER		ALL	2	26.330	0.000	1.5	1.5	2.0	7.250	3.425	0.000	0.000
TRUCK DRIVER		ALL	3	26.530	0.000	1.5	1.5	2.0	7.250	3.425	0.000	0.000
TRUCK DRIVER		ALL	4	26.780	0.000	1.5	1.5	2.0	7.250	3.425	0.000	0.000
TRUCK DRIVER		ALL	5	27.530	0.000	1.5	1.5	2.0	7.250	3.425	0.000	0.000
TRUCK DRIVER		O&C	1	20.740	0.000	1.5	1.5	2.0	7.250	3.425	0.000	0.000
TRUCK DRIVER		O&C	2	21.060	0.000	1.5	1.5	2.0	7.250	3.425	0.000	0.000
TRUCK DRIVER		O&C	3	21.220	0.000	1.5	1.5	2.0	7.250	3.425	0.000	0.000



TRUCK DRIVER	O&C 4	21.420	0.000	1.5	1.5	2.0	7.250	3.425	0.000	0.000
TRUCK DRIVER	O&C 5	22.020	0.000	1.5	1.5	2.0	7.250	3.425	0.000	0.000

Legend:

M-F>8 (Overtime is required for any hour greater than 8 worked each day, Monday through Friday.)

OSA (Overtime is required for every hour worked on Saturday)

OSH (Overtime is required for every hour worked on Sunday and Holidays)

H/W (Health & Welfare Insurance)

Pensn (Pension)

Vac (Vacation)

Trng (Training)

## Explanations

### CLINTON COUNTY

ELECTRICIANS (WEST) - Townships of St. Rose, Wheatfield, Sugar Creek, Breese, Wade, Carlyle, Looking Glass, and German Town.

ELECTRONIC SYSTEMS TECHNICIAN (WEST) - Townships of St. Rose, Wheatfield, Sugar Creek, Breese, Wade, Carlyle, Looking Glass, and Germantown.

ELECTRONIC SYSTEMS TECHNICIAN (EAST) - Townships not included in WEST.

PLUMBERS & PIPEFITTERS (EAST) - That part of the county East of a North-South line 2.5 miles East of Rt. 127.

PLUMBERS & PIPEFITTERS (SOUTHWEST) - That part of the county South of New Route 50 and West of Route 127 inclusive.

The following list is considered as those days for which holiday rates of wages for work performed apply: New Years Day, Memorial/Decoration Day, Fourth of July, Labor Day, Veterans Day, Thanksgiving Day, Christmas Day. Generally, any of these holidays which fall on a Sunday is celebrated on the following Monday. This then makes work performed on that Monday payable at the appropriate overtime rate for holiday pay. Common practice in a given local may alter certain days of celebration such as the day after Thanksgiving for Veterans Day. If in doubt, please check with IDOL.

Oil and chip resealing (O&C) means the application of road oils and liquid asphalt to coat an existing road surface, followed by application of aggregate chips or gravel to coated surface, and subsequent rolling of material to seal the surface.

### EXPLANATION OF CLASSES

ASBESTOS - GENERAL - removal of asbestos material/mold and hazardous materials from any place in a building, including mechanical systems where those mechanical systems are to be removed. This includes the removal of asbestos materials/mold and hazardous materials from

ductwork or pipes in a building when the building is to be demolished at the time or at some close future date.

ASBESTOS - MECHANICAL - removal of asbestos material from mechanical systems, such as pipes, ducts, and boilers, where the mechanical systems are to remain.

#### CERAMIC TILE FINISHER AND MARBLE FINISHER

The handling, at the building site, of all sand, cement, tile, marble or stone and all other materials that may be used and installed by [a] tile layer or marble mason. In addition, the grouting, cleaning, sealing, and mixing on the job site, and all other work as required in assisting the setter. The term "Ceramic" is used for naming the classification only and is in no way a limitation of the product handled. Ceramic takes into consideration most hard tiles.

#### ELECTRONIC SYSTEMS TECHNICIAN

Installation, service and maintenance of low-voltage systems which utilizes the transmission and/or transference of voice, sound, vision, or digital for commercial, education, security and entertainment purposes for the following: TV monitoring and surveillance, background/foreground music, intercom and telephone interconnect, field programming, inventory control systems, microwave transmission, multi-media, multiplex, radio page, school, intercom and sound burglar alarms and low voltage master clock systems.

Excluded from this classification are energy management systems, life safety systems, supervisory controls and data acquisition systems not intrinsic with the above listed systems, fire alarm systems, nurse call systems and raceways exceeding fifteen feet in length.

#### TRUCK DRIVER - BUILDING, HEAVY AND HIGHWAY CONSTRUCTION

Class 1. Drivers on 2 axle trucks hauling less than 9 ton. Air compressor and welding machines and brooms, including those pulled by separate units, truck driver helpers, warehouse employees, mechanic helpers, greasers and tiremen, pickup trucks when hauling materials, tools, or workers to and from and on-the-job site, and fork lifts up to 6,000 lb. capacity.

Class 2. Two or three axle trucks hauling more than 9 ton but hauling less than 16 ton. A-frame winch trucks, hydrolift trucks, vector trucks or similar equipment when used for transportation purposes. Fork lifts over 6,000 lb. capacity, winch trucks, four axle combination units, and ticket writers.

Class 3. Two, three or four axle trucks hauling 16 ton or more. Drivers on water pulls, articulated dump trucks, mechanics and working forepersons, and dispatchers. Five axle or more combination units.

Class 4. Low Boy and Oil Distributors.

Class 5. Drivers who require special protective clothing while employed on hazardous waste work.

#### TRUCK DRIVER - OIL AND CHIP RESEALING ONLY.

This shall encompass laborers, workers and mechanics who drive contractor or subcontractor owned, leased, or hired pickup, dump, service, or oil distributor trucks. The work includes transporting materials and equipment (including but not limited to, oils, aggregate supplies, parts, machinery and tools) to or from the job site;

distributing oil or liquid asphalt and aggregate; stock piling material when in connection with the actual oil and chip contract. The Truck Driver (Oil & Chip Resealing) wage classification does not include supplier delivered materials.

#### OPERATING ENGINEERS

GROUP I. Cranes, Dragline, Shovels, Skimmer Scoops, Clamshells or Derrick Boats, Pile Drivers, Crane-Type Backhoes, Asphalt Plant Operators, Concrete Plant Operators, Dredges, Asphalt Spreading Machines, All Locomotives, Cable Ways, or Tower Machines, Hoists, Hydraulic Backhoes, Ditching Machines or Backfiller, Cherrypickers, Overhead Cranes, Roller, Steam or Gas, Concrete Pavers, Excavators, Concrete Breakers, Concrete Pumps, Bulk Cement Plants, Cement Pumps, Derrick-Type Drills, Boat Operators, Motor Graders or Pushcats, Scoops or Tournapulls, Bulldozers, Endloaders or Fork Lifts, Power Blade or Elevating Graders, Winch Cats, Boom or Winch Trucks or Boom Tractors, Pipe Wrapping or Painting Machines, Asphalt Plant Engineer, Journeyman Lubricating Engineer, Drills (other than Derrick Type), Mud Jacks, or Well Drilling Machines, Boring Machines or Track Jacks, Mixers, Conveyors (Two), Air Compressors (Two), Water Pumps regardless of size (Two), Welding Machines (Two), Siphons or Jets (Two), Winch Heads or Apparatuses (Two), Light Plants (Two), Waterblasters (two), All Tractors regardless of size (straight tractor only), Fireman on Stationary Boilers, Automatic Elevators, Form Grading Machines, Finishing Machines, Power Sub-Grader or Ribbon Machines, Longitudinal Floats, Distributor Operators on Trucks, Winch Heads or Apparatuses (One), Mobil Track air and heaters (two to five), Heavy Equipment Greaser, Relief Operator, Assistant Master Mechanic and Heavy Duty Mechanic, all Operators (except those listed below).

GROUP II. Assistant Operators.

GROUP III. Air Compressors (One), Water Pumps, regardless of Size (One), Waterblasters (one), Welding Machine (One), Mixers (One Bag), Conveyor (One), Siphon or Jet (One), Light Plant (One), Heater (One), Immobile Track Air (One), and Self Propelled Walk-Behind Rollers.

GROUP IV. Asphalt Spreader Oilers, Fireman on Whirlies and Heavy Equipment Oilers, Truck Cranes, Dredges, Monigans, Large Cranes - (Over 65-ton rated capacity) Concrete Plant Oiler, Blacktop Plant Oiler, and Creter Crane Oiler (when required).

GROUP V. Oiler.

GROUP VI. Master Mechanics, Operators on equipment with Booms, including jibs, 100 feet and over, and less than 150 feet long.

GROUP VII. Operators on equipment with Booms, including jibs, 150 feet and over, and less than 200 feet long.

GROUP VIII. Operators on Equipment with Booms, including jibs, 200 feet and over; Tower Cranes; Whirlie Cranes; and Operator Foreman.

#### TERRAZZO FINISHER

The handling of all materials used for Mosaic and Terrazzo work including preparing, mixing by hand, by mixing machine or transporting of pre-mixed materials and distributing with shovel, rake, hoe, or pail, all kinds of concrete foundations necessary for Mosaic and Terrazzo work, all cement terrazzo, magnesite terrazzo, Do-O-Tex terrazzo, epoxy matrix ter-razzo, exposed aggregate, rustic or rough washed for exterior or interior of buildings placed either by machine

or by hand, and any other kind of mixture of plastics composed of chips or granules when mixed with cement, rubber, neoprene, vinyl, magnesium chloride or any other resinous or chemical substances used for seamless flooring systems, and all other building materials, all similar materials and all precast terrazzo work on jobs, all scratch coat used for Mosaic and Terrazzo work and sub-bed, tar paper and wire mesh (2x2 etc.) or lath. The rubbing, grinding, cleaning and finishing of same either by hand or by machine or by terrazzo resurfacing equipment on new or existing floors. When necessary finishers shall be allowed to assist the mechanics to spread sand bed, lay tarpaper and wire mesh (2x2 etc.) or lath. The finishing of cement floors where additional aggregate of stone is added by spreading or sprinkling on top of the finished base, and troweled or rolled into the finish and then the surface is ground by grinding machines.

#### Other Classifications of Work:

For definitions of classifications not otherwise set out, the Department generally has on file such definitions which are available. If a task to be performed is not subject to one of the classifications of pay set out, the Department will upon being contacted state which neighboring county has such a classification and provide such rate, such rate being deemed to exist by reference in this document. If no neighboring county rate applies to the task, the Department shall undertake a special determination, such special determination being then deemed to have existed under this determination. If a project requires these, or any classification not listed, please contact IDOL at 618/993-7271 for wage rates or clarifications.

#### LANDSCAPING

Landscaping work falls under the existing classifications for laborer, operating engineer and truck driver. The work performed by landscape plantsman and landscape laborer is covered by the existing classification of laborer. The work performed by landscape operators (regardless of equipment used or its size) is covered by the classifications of operating engineer. The work performed by landscape truck drivers (regardless of size of truck driven) is covered by the classifications of truck driver.

# Coles County Prevailing Wage for April 2007

Trade Name	RG	TYP	C	Base	FRMAN	*M-F>8	OSA	OSH	H/W	Pensn	Vac	Trng
=====	==	==	=	=====	=====	=====	==	==	=====	=====	=====	=====
ASBESTOS ABT-GEN		BLD		24.420	25.420	1.5	1.5	2.0	5.050	5.330	0.000	0.700
ASBESTOS ABT-MEC		BLD		20.800	0.000	2.0	2.0	2.0	5.000	3.400	0.000	0.000
BOILERMAKER		BLD		28.500	31.000	1.5	1.5	2.0	6.820	11.03	0.000	0.300
BRICK MASON		BLD		25.500	27.000	1.5	1.5	2.0	5.200	6.500	0.000	0.630
CARPENTER		BLD		25.590	27.590	1.5	1.5	2.0	6.500	6.800	0.000	0.320
CARPENTER		HWY		25.040	26.790	1.5	1.5	2.0	6.500	7.300	0.000	0.300
CEMENT MASON		BLD		25.830	27.080	1.5	1.5	2.0	5.200	7.000	0.000	0.300
CEMENT MASON		HWY		24.170	25.170	1.5	1.5	2.0	5.200	7.000	0.000	0.300
CERAMIC TILE FNSHER		BLD		25.500	0.000	1.5	1.5	2.0	5.200	5.600	0.000	0.000
ELECTRIC PWR EQMT OP		ALL		30.750	0.000	1.5	1.5	2.0	4.750	8.610	0.000	0.000
ELECTRIC PWR GRNDMAN		ALL		21.090	0.000	1.5	1.5	2.0	4.750	5.905	0.000	0.000
ELECTRIC PWR LINEMAN		ALL		34.160	36.350	1.5	1.5	2.0	4.750	9.560	0.000	0.000
ELECTRIC PWR TRK DRV		ALL		22.130	0.000	1.5	1.5	2.0	4.750	6.200	0.000	0.000
ELECTRICIAN		BLD		29.480	32.420	1.5	1.5	2.0	5.150	5.300	0.000	0.440
ELECTRONIC SYS TECH		BLD		24.370	25.870	1.5	1.5	2.0	5.150	3.650	0.000	0.250
ELEVATOR CONSTRUCTOR		BLD		34.190	38.460	2.0	2.0	2.0	8.275	6.060	2.050	0.000
FENCE ERECTOR		ALL		24.450	25.750	1.5	1.5	2.0	6.000	8.000	0.000	0.390
GLAZIER		BLD		27.130	28.130	1.5	2.0	2.0	5.430	4.000	0.000	0.280
HT/FROST INSULATOR		BLD		26.110	27.110	1.5	1.5	2.0	4.800	6.860	0.000	0.190
IRON WORKER		ALL		24.450	25.750	1.5	1.5	2.0	6.000	8.000	0.000	0.390
LABORER		BLD		22.920	23.920	1.5	1.5	2.0	5.050	5.330	0.000	0.600
LABORER		HWY		24.220	24.970	1.5	1.5	2.0	5.050	5.330	0.000	0.600
LATHER		BLD		25.590	27.590	1.5	1.5	2.0	6.500	6.800	0.000	0.320
MACHINIST		BLD		36.890	38.890	2.0	2.0	2.0	4.380	5.650	2.550	0.000
MARBLE FINISHERS		BLD		25.500	0.000	1.5	1.5	2.0	5.200	5.600	0.000	0.000
MARBLE MASON		BLD		27.000	0.000	1.5	1.5	2.0	5.200	5.600	0.000	0.000
MILLWRIGHT		BLD		26.000	28.000	1.5	1.5	2.0	6.500	6.850	0.000	0.320
MILLWRIGHT		HWY		19.410	20.660	1.5	1.5	2.0	2.800	3.000	0.000	0.000
OPERATING ENGINEER		ALL	1	28.650	0.000	1.5	1.5	2.0	5.200	6.750	0.000	0.650
OPERATING ENGINEER		ALL	2	18.600	0.000	1.5	1.5	2.0	5.200	6.750	0.000	0.650
PAINTER		ALL		28.450	29.800	1.5	1.5	2.0	5.200	3.300	0.000	0.320
PAINTER SIGNS		ALL		28.450	29.800	1.5	1.5	2.0	5.200	3.300	0.000	0.320
PILEDRIVER		BLD		26.090	28.090	1.5	1.5	2.0	6.500	6.800	0.000	0.320
PILEDRIVER		HWY		25.540	27.290	1.5	1.5	2.0	6.500	7.300	0.000	0.300
PIPEFITTER		BLD		33.100	35.600	1.5	1.5	2.0	6.450	5.760	0.000	0.620
PLASTERER		BLD		23.940	25.440	1.5	1.5	2.0	5.200	8.200	0.000	0.300
PLUMBER		BLD		33.100	35.600	1.5	1.5	2.0	6.450	5.760	0.000	0.620
ROOFER		BLD		25.460	26.460	1.5	1.5	2.0	6.350	5.150	0.000	0.200
SHEETMETAL WORKER		BLD		28.600	30.600	1.5	1.5	2.0	7.150	7.330	0.000	0.520
SPRINKLER FITTER		BLD		31.240	33.240	1.5	1.5	2.0	6.500	5.350	0.000	0.250
STONE MASON		BLD		25.500	27.000	1.5	1.5	2.0	5.200	6.500	0.000	0.630
TERRAZZO FINISHER		BLD		25.500	0.000	1.5	1.5	2.0	5.200	5.600	0.000	0.000
TERRAZZO MASON		BLD		27.000	0.000	1.5	1.5	2.0	5.200	5.600	0.000	0.000
TILE LAYER		BLD		25.590	27.590	1.5	1.5	2.0	6.500	6.800	0.000	0.320
TILE MASON		BLD		27.000	0.000	1.5	1.5	2.0	5.200	5.600	0.000	0.000
TRUCK DRIVER		ALL	1	25.787	0.000	1.5	1.5	2.0	7.250	3.317	0.000	0.000
TRUCK DRIVER		ALL	2	26.187	0.000	1.5	1.5	2.0	7.250	3.317	0.000	0.000
TRUCK DRIVER		ALL	3	26.387	0.000	1.5	1.5	2.0	7.250	3.317	0.000	0.000
TRUCK DRIVER		ALL	4	26.637	0.000	1.5	1.5	2.0	7.250	3.317	0.000	0.000
TRUCK DRIVER		ALL	5	27.387	0.000	1.5	1.5	2.0	7.250	3.317	0.000	0.000
TRUCK DRIVER		O&C	1	20.630	0.000	1.5	1.5	2.0	7.250	3.317	0.000	0.000
TRUCK DRIVER		O&C	2	20.950	0.000	1.5	1.5	2.0	7.250	3.317	0.000	0.000
TRUCK DRIVER		O&C	3	21.110	0.000	1.5	1.5	2.0	7.250	3.317	0.000	0.000
TRUCK DRIVER		O&C	4	21.310	0.000	1.5	1.5	2.0	7.250	3.317	0.000	0.000
TRUCK DRIVER		O&C	5	21.910	0.000	1.5	1.5	2.0	7.250	3.317	0.000	0.000
TUCKPOINTER		BLD		25.500	27.000	1.5	1.5	2.0	5.200	6.500	0.000	0.630

Legend:

M-F>8 (Overtime is required for any hour greater than 8 worked each day, Monday through Friday.)

OSA (Overtime is required for every hour worked on Saturday)

OSH (Overtime is required for every hour worked on Sunday and Holidays)

H/W (Health & Welfare Insurance)

Pensn (Pension)

Vac (Vacation)

Trng (Training)

## Explanations

### COLES COUNTY

The following list is considered as those days for which holiday rates of wages for work performed apply: New Years Day, Memorial/Decoration Day, Fourth of July, Labor Day, Veterans Day, Thanksgiving Day, Christmas Day. Generally, any of these holidays which fall on a Sunday is celebrated on the following Monday. This then makes work performed on that Monday payable at the appropriate overtime rate for holiday pay. Common practice in a given local may alter certain days of celebration such as the day after Thanksgiving for Veterans Day. If in doubt, please check with IDOL.

Oil and chip resealing (O&C) means the application of road oils and liquid asphalt to coat an existing road surface, followed by application of aggregate chips or gravel to coated surface, and subsequent rolling of material to seal the surface.

### EXPLANATION OF CLASSES

ASBESTOS - GENERAL - removal of asbestos material/mold and hazardous materials from any place in a building, including mechanical systems where those mechanical systems are to be removed. This includes the removal of asbestos materials/mold and hazardous materials from ductwork or pipes in a building when the building is to be demolished at the time or at some close future date.

ASBESTOS - MECHANICAL - removal of asbestos material from mechanical systems, such as pipes, ducts, and boilers, where the mechanical systems are to remain.

### CERAMIC TILE FINISHER, MARBLE FINISHER, TERRAZZO FINISHER

Assisting, helping or supporting the tile, marble and terrazzo mechanic by performing their historic and traditional work assignments required to complete the proper installation of the work covered by said crafts. The term "Ceramic" is used for naming the classification only and is in no way a limitation of the product handled. Ceramic takes into consideration most hard tiles.

### ELECTRONIC SYSTEMS TECHNICIAN

Installation, service and maintenance of low-voltage systems which

utilizes the transmission and/or transference of voice, sound, vision, or digital for commercial, education, security and entertainment purposes for the following: TV monitoring and surveillance, background/foreground music, intercom and telephone interconnect, field programming, inventory control systems, microwave transmission, multi-media, multiplex, radio page, school, intercom and sound burglar alarms and low voltage master clock systems.

Excluded from this classification are energy management systems, life safety systems, supervisory controls and data acquisition systems not intrinsic with the above listed systems, fire alarm systems, nurse call systems and raceways exceeding fifteen feet in length.

#### TRUCK DRIVER - BUILDING, HEAVY AND HIGHWAY CONSTRUCTION

Class 1. Drivers on 2 axle trucks hauling less than 9 ton. Air compressor and welding machines and brooms, including those pulled by separate units, truck driver helpers, warehouse employees, mechanic helpers, greasers and tiremen, pickup trucks when hauling materials, tools, or workers to and from and on-the-job site, and fork lifts up to 6,000 lb. capacity.

Class 2. Two or three axle trucks hauling more than 9 ton but hauling less than 16 ton. A-frame winch trucks, hydrolift trucks, vactor trucks or similar equipment when used for transportation purposes. Fork lifts over 6,000 lb. capacity, winch trucks, four axle combination units, and ticket writers.

Class 3. Two, three or four axle trucks hauling 16 ton or more. Drivers on water pulls, articulated dump trucks, mechanics and working forepersons, and dispatchers. Five axle or more combination units.

Class 4. Low Boy and Oil Distributors.

Class 5. Drivers who require special protective clothing while employed on hazardous waste work.

#### TRUCK DRIVER - OIL AND CHIP RESEALING ONLY.

This shall encompass laborers, workers and mechanics who drive contractor or subcontractor owned, leased, or hired pickup, dump, service, or oil distributor trucks. The work includes transporting materials and equipment (including but not limited to, oils, aggregate supplies, parts, machinery and tools) to or from the job site; distributing oil or liquid asphalt and aggregate; stock piling material when in connection with the actual oil and chip contract. The Truck Driver (Oil & Chip Resealing) wage classification does not include supplier delivered materials.

#### OPERATING ENGINEERS - BUILDING, HEAVY AND HIGHWAY CONSTRUCTION

Class 1. Power Cranes, Draglines, Derricks, Shovels, Gradalls, Mechanics, Tractor Highlift, Tournadozer, Concrete Mixers with Skip, Tournamixer, Two Drum Machine, One Drum Hoist with Tower or Boom, Cableways, Tower Machines, Motor Patrol, Boom Tractor, Boom or Winch Truck, Winch or Hydraulic Boom Truck, Truck Crane, Tournapull, Tractor Operating Scoops, Bulldozer, Push Tractor, Asphalt Planer, Finishing Machine on Asphalt, Large Rollers on Earth, Rollers on Asphalt Mix, Ross Carrier or similar Machine, Gravel Processing Machine, Asphalt Plant Engineer, Paver Operator, Dredging Equipment, or Dredge Engineer, or Dredge Operator, Central Mix Plant Engineer, CMI or similar type machine, Concrete Pump, Truck or Skid Mounted, Tower Crane, Engineer or Rock Crusher Plant, Concrete Plant Engineer,

Ditching Machine with dual attachment, Tractor Mounted Loaders, Cherry Picker, Hydro Crane, Standard or Dinkey Locomotives, Scoopmobiles, Euclid Loader, Soil Cement Machine, Back Filler, Elevating Machine, Power Blade, Drilling Machine, including Well Testing, Caissons, Shaft or any similar type drilling machines, Motor Driven Paint Machine, Pipe Cleaning Machine, Pipe Wrapping Machine, Pipe Bending Machine, Apsco Paver, Boring Machine, (Head Equipment Greaser), Barber-Greene Loaders, Formless Paver, (Well Point System), Concrete Spreader, Hydra Ax, Span Saw, Marine Scoops, Brush Mulcher, Brush Burner, Mesh Placer, Tree Mover, Helicopter Crew (3), Piledriver-Skid or Crawler, Stump Remover, Root Rake, Tug Boat Operator, Refrigerating Machine, Freezing Operator, Chair Cart-Self-Propelled, Hydra Seeder, Straw Blower, Power Sub Grader, Bull Float, Finishing Machine, Self-Propelled Pavement Breaker, Lull (or similar type Machine), Two Air Compressors, Compressors hooked in Manifold, Overhead Crane, Chip Spreader, Mud Cat, Sull-Air, Fork Lifts (except when used for landscaping work), Soil Stabilizer (Seaman Tiller, Bo Mag, Rago Gator, and similar types of equipment), Tube Float, Spray Machine, Curing Machine, Concrete or Asphalt Milling Machine, Snooper Truck-Operator, Backhoe, Farm Tractors (with attachments), 4 Point Lift System (Power Lift or similar type), Skid-Steer (Bob Cat or similar type), Wrecking Shears, Water Blaster.

Class 2. Concrete Mixers without Skips, Rock Crusher, Ditching Machine under 6', Curbing Machine, One Drum Machines without Tower or Boom, Air Tugger, Self-Propelled Concrete Saw, Machine Mounted Post Hole Digger, two to four Generators, Water Pumps or Welding Machines, within 400 feet, Air Compressor 600 cu. ft. and under, Rollers on Aggregate and Seal Coat Surfaces, Fork Lift (when used for landscaping work), Concrete and Blacktop Curb Machine, One Water Pump, Oilers, Air Valves or Steam Valves, One Welding Machine, Truck Jack, Mud Jack, Gunnite Machine, House Elevators when used for hoisting material, Engine Tenders, Fireman, Wagon Drill, Flex Plane, Conveyor, Siphons and Pulsometer, Switchman, Fireman on Paint Pots, Fireman on Asphalt Plants, Distributor Operator on Trucks, Tampers, Self-Propelled Power Broom, Striping Machine (motor driven), Form Tamper, Bulk Cement Plant, Equipment Greaser, Deck Hands, Truck Crane Oiler-Driver, Cement Blimps, Form Grader, Temporary Heat, Throttle Valve, Super Sucker (and similar type of equipment).

#### Other Classifications of Work:

For definitions of classifications not otherwise set out, the Department generally has on file such definitions which are available. If a task to be performed is not subject to one of the classifications of pay set out, the Department will upon being contacted state which neighboring county has such a classification and provide such rate, such rate being deemed to exist by reference in this document. If no neighboring county rate applies to the task, the Department shall undertake a special determination, such special determination being then deemed to have existed under this determination. If a project requires these, or any classification not listed, please contact IDOL at 618/993-7271 for wage rates or clarifications.

#### LANDSCAPING

Landscaping work falls under the existing classifications for laborer, operating engineer and truck driver. The work performed by landscape plantsman and landscape laborer is covered by the existing classification of laborer. The work performed by landscape operators (regardless of equipment used or its size) is covered by the classifications of operating engineer. The work performed by



landscape truck drivers (regardless of size of truck driven) is covered by the classifications of truck driver.

# Cook County Prevailing Wage for April 2007

Trade Name	RG	TYP	C	Base	FRMAN	*M-F>8	OSA	OSH	H/W	Pensn	Vac	Trng
=====	==	==	=	=====	=====	=====	==	==	=====	=====	=====	=====
ASBESTOS ABT-GEN		ALL		31.550	32.300	1.5	1.5	2.0	7.460	4.840	0.000	0.170
ASBESTOS ABT-MEC		BLD		23.300	24.800	1.5	1.5	2.0	7.860	4.910	0.000	0.000
BOILERMAKER		BLD		38.540	42.000	2.0	2.0	2.0	6.720	7.440	0.000	0.300
BRICK MASON		BLD		34.850	38.340	1.5	1.5	2.0	7.050	7.870	0.000	0.380
CARPENTER		ALL		36.520	38.520	1.5	1.5	2.0	7.960	5.910	0.000	0.490
CEMENT MASON		ALL		38.200	40.200	2.0	1.5	2.0	6.790	5.620	0.000	0.170
CERAMIC TILE FNSHER		BLD		28.520	0.000	2.0	1.5	2.0	5.650	5.750	0.000	0.330
COMM. ELECT.		BLD		32.440	34.940	1.5	1.5	2.0	6.930	5.320	0.000	0.700
ELECTRIC PWR EQMT OP		ALL		36.050	42.000	1.5	1.5	2.0	7.870	9.730	0.000	0.270
ELECTRIC PWR GRNDMAN		ALL		28.120	42.000	1.5	1.5	2.0	6.140	7.600	0.000	0.210
ELECTRIC PWR LINEMAN		ALL		36.050	42.000	1.5	1.5	2.0	7.870	9.730	0.000	0.270
ELECTRICIAN		ALL		36.300	38.900	1.5	1.5	2.0	9.530	7.250	0.000	0.750
ELEVATOR CONSTRUCTOR		BLD		42.045	47.300	2.0	2.0	2.0	8.275	6.060	2.520	0.550
FENCE ERECTOR		ALL		27.140	28.640	1.5	1.5	2.0	7.500	7.590	0.000	0.250
GLAZIER		BLD		31.400	32.400	1.5	2.0	2.0	6.490	9.050	0.000	0.500
HT/FROST INSULATOR		BLD		33.300	35.050	1.5	1.5	2.0	7.860	8.610	0.000	0.310
IRON WORKER		ALL		38.250	40.250	2.0	2.0	2.0	9.470	11.27	0.000	0.300
LABORER		ALL		31.550	32.300	1.5	1.5	2.0	7.460	4.840	0.000	0.170
LATHER		BLD		36.520	38.520	1.5	1.5	2.0	7.960	5.910	0.000	0.490
MACHINIST		BLD		36.890	38.890	2.0	2.0	2.0	4.380	5.650	2.550	0.000
MARBLE FINISHERS		ALL		25.750	0.000	1.5	1.5	2.0	6.070	7.020	0.000	0.580
MARBLE MASON		BLD		34.850	38.340	1.5	1.5	2.0	7.050	7.870	0.000	0.490
MATERIAL TESTER 1		ALL		21.550	0.000	1.5	1.5	2.0	7.460	4.840	0.000	0.170
MATERIALS TESTER II		ALL		26.550	0.000	1.5	1.5	2.0	7.460	4.840	0.000	0.170
MILLWRIGHT		ALL		36.520	38.520	1.5	1.5	2.0	7.960	5.910	0.000	0.490
OPERATING ENGINEER		BLD	1	41.550	45.550	2.0	2.0	2.0	6.850	5.600	1.900	0.700
OPERATING ENGINEER		BLD	2	40.250	45.550	2.0	2.0	2.0	6.850	5.600	1.900	0.700
OPERATING ENGINEER		BLD	3	37.700	45.550	2.0	2.0	2.0	6.850	5.600	1.900	0.700
OPERATING ENGINEER		BLD	4	35.950	45.550	2.0	2.0	2.0	6.850	5.600	1.900	0.700
OPERATING ENGINEER		FLT	1	47.250	47.250	1.5	1.5	2.0	6.850	5.600	1.900	0.000
OPERATING ENGINEER		FLT	2	45.750	47.250	1.5	1.5	2.0	6.850	5.600	1.900	0.000
OPERATING ENGINEER		FLT	3	40.700	47.250	1.5	1.5	2.0	6.850	5.600	1.900	0.000
OPERATING ENGINEER		FLT	4	33.850	47.250	1.5	1.5	2.0	6.850	5.600	1.900	0.000
OPERATING ENGINEER		HWY	1	39.750	43.750	1.5	1.5	2.0	6.850	5.600	1.900	0.700
OPERATING ENGINEER		HWY	2	39.200	43.750	1.5	1.5	2.0	6.850	5.600	1.900	0.700
OPERATING ENGINEER		HWY	3	37.150	43.750	1.5	1.5	2.0	6.850	5.600	1.900	0.700
OPERATING ENGINEER		HWY	4	35.750	43.750	1.5	1.5	2.0	6.850	5.600	1.900	0.700
OPERATING ENGINEER		HWY	5	34.550	43.750	1.5	1.5	2.0	6.850	5.600	1.900	0.700
ORNAMNTL IRON WORKER		ALL		35.600	37.600	2.0	2.0	2.0	7.500	10.84	0.000	0.750
PAINTER		ALL		34.400	38.700	1.5	1.5	1.5	6.200	6.400	0.000	0.390
PAINTER SIGNS		BLD		28.970	32.520	1.5	1.5	1.5	2.600	2.310	0.000	0.000
PILEDRIVER		ALL		36.520	38.520	1.5	1.5	2.0	7.960	5.910	0.000	0.490
PIPEFITTER		BLD		37.600	39.600	1.5	1.5	2.0	8.660	6.900	0.000	0.940
PLASTERER		BLD		33.850	35.350	1.5	1.5	2.0	6.740	7.100	0.000	0.400
PLUMBER		BLD		39.700	41.700	1.5	1.5	2.0	8.170	4.560	0.000	0.940
ROOFER		BLD		33.650	35.650	1.5	1.5	2.0	6.460	3.310	0.000	0.330
SHEETMETAL WORKER		BLD		33.400	36.070	1.5	1.5	2.0	6.460	7.850	0.000	0.590
SIGN HANGER		BLD		25.340	26.190	1.5	1.5	2.0	4.180	2.250	0.000	0.000
SPRINKLER FITTER		BLD		38.500	40.500	1.5	1.5	2.0	8.250	6.100	0.000	0.500
STEEL ERECTOR		ALL		36.250	37.750	2.0	2.0	2.0	8.970	10.77	0.000	0.300
STONE MASON		BLD		33.250	36.580	1.5	1.5	2.0	6.450	7.020	0.000	0.440
TERRAZZO FINISHER		BLD		29.290	0.000	1.5	1.5	2.0	5.650	6.940	0.000	0.270
TERRAZZO MASON		BLD		33.650	36.650	1.5	1.5	2.0	5.650	8.610	0.000	0.300
TILE MASON		BLD		34.600	38.600	2.0	1.5	2.0	5.650	7.000	0.000	0.460
TRAFFIC SAFETY WRKR		HWY		22.800	24.400	1.5	1.5	2.0	3.078	1.875	0.000	0.000
TRUCK DRIVER	E	ALL	1	29.150	29.800	1.5	1.5	2.0	5.650	4.300	0.000	0.000
TRUCK DRIVER	E	ALL	2	29.400	29.800	1.5	1.5	2.0	5.650	4.300	0.000	0.000
TRUCK DRIVER	E	ALL	3	29.600	29.800	1.5	1.5	2.0	5.650	4.300	0.000	0.000

TRUCK DRIVER	E	ALL	4	29.800	29.800	1.5	1.5	2.0	5.650	4.300	0.000	0.000
TRUCK DRIVER	W	ALL	1	29.700	30.250	1.5	1.5	2.0	6.500	3.400	0.000	0.000
TRUCK DRIVER	W	ALL	2	29.850	30.250	1.5	1.5	2.0	6.500	3.400	0.000	0.000
TRUCK DRIVER	W	ALL	3	30.050	30.250	1.5	1.5	2.0	6.500	3.400	0.000	0.000
TRUCK DRIVER	W	ALL	4	30.250	30.250	1.5	1.5	2.0	6.500	3.400	0.000	0.000
TUCKPOINTER		BLD		34.500	35.500	1.5	1.5	2.0	4.710	6.340	0.000	0.400

Legend:

M-F>8 (Overtime is required for any hour greater than 8 worked each day, Monday through Friday.)

OSA (Overtime is required for every hour worked on Saturday)

OSH (Overtime is required for every hour worked on Sunday and Holidays)

H/W (Health & Welfare Insurance)

Pensn (Pension)

Vac (Vacation)

Trng (Training)

## Explanations

### COOK COUNTY

TRUCK DRIVERS (WEST) - That part of the county West of Barrington Road.

The following list is considered as those days for which holiday rates of wages for work performed apply: New Years Day, Memorial/Decoration Day, Fourth of July, Labor Day, Veterans Day, Thanksgiving Day, Christmas Day. Generally, any of these holidays which fall on a Sunday is celebrated on the following Monday. This then makes work performed on that Monday payable at the appropriate overtime rate for holiday pay. Common practice in a given local may alter certain days of celebration such as the day after Thanksgiving for Veterans Day. If in doubt, please check with IDOL.

### EXPLANATION OF CLASSES

ASBESTOS - GENERAL - removal of asbestos material/mold and hazardous materials from any place in a building, including mechanical systems where those mechanical systems are to be removed. This includes the removal of asbestos materials/mold and hazardous materials from ductwork or pipes in a building when the building is to be demolished at the time or at some close future date.

ASBESTOS - MECHANICAL - removal of asbestos material from mechanical systems, such as pipes, ducts, and boilers, where the mechanical systems are to remain.

### CERAMIC TILE FINISHER

The grouting, cleaning, and polishing of all classes of tile, whether for interior or exterior purposes, all burned, glazed or unglazed products; all composition materials, granite tiles, warning detectable tiles, cement tiles, epoxy composite materials, pavers, glass, mosaics, fiberglass, and all substitute materials, for tile made in

tile-like units; all mixtures in tile like form of cement, metals, and other materials that are for and intended for use as a finished floor surface, stair treads, promenade roofs, walks, walls, ceilings, swimming pools, and all other places where tile is to form a finished interior or exterior. The mixing of all setting mortars including but not limited to thin-set mortars, epoxies, wall mud, and any other sand and cement mixtures or adhesives when used in the preparation, installation, repair, or maintenance of tile and/or similar materials. The handling and unloading of all sand, cement, lime, tile, fixtures, equipment, adhesives, or any other materials to be used in the preparation, installation, repair, or maintenance of tile and/or similar materials. Ceramic Tile Finishers shall fill all joints and voids regardless of method on all tile work, particularly and especially after installation of said tile work. Application of any and all protective coverings to all types of tile installations including, but not be limited to, all soap compounds, paper products, tapes, and all polyethylene coverings, plywood, masonite, cardboard, and any new type of products that may be used to protect tile installations, Blastrac equipment, and all floor scarifying equipment used in preparing floors to receive tile. The clean up and removal of all waste and materials. All demolition of existing tile floors and walls to be re-tiled.

COMMUNICATIONS ELECTRICIAN - Installation, operation, inspection, maintenance, repair and service of radio, television, recording, voice sound vision production and reproduction, telephone and telephone interconnect, facsimile, data apparatus, coaxial, fibre optic and wireless equipment, appliances and systems used for the transmission and reception of signals of any nature, business, domestic, commercial, education, entertainment, and residential purposes, including but not limited to, communication and telephone, electronic and sound equipment, fibre optic and data communication systems, and the performance of any task directly related to such installation or service whether at new or existing sites, such tasks to include the placing of wire and cable and electrical power conduit or other raceway work within the equipment room and pulling wire and/or cable through conduit and the installation of any incidental conduit, such that the employees covered hereby can complete any job in full.

#### MARBLE FINISHER

Loading and unloading trucks, distribution of all materials (all stone, sand, etc.), stocking of floors with material, performing all rigging for heavy work, the handling of all material that may be needed for the installation of such materials, building of scaffolding, polishing if needed, patching, waxing of material if damaged, pointing up, caulking, grouting and cleaning of marble, holding water on diamond or Carborundum blade or saw for setters cutting, use of tub saw or any other saw needed for preparation of material, drilling of holes for wires that anchor material set by setters, mixing up of molding plaster for installation of material, mixing up thin set for the installation of material, mixing up of sand to cement for the installatin of material and such other work as may be required in helping a Marble Setter in the handling of all material in the erection or installation of interior marble, slate, travertine, art marble, serpentine, alberene stone, blue stone, granite and other stones (meaning as to stone any foreign or domestic materials as are specified and used in building interiors and experiors and customarily known as stone in the trade), carrara, sanionyx, vitrolite and similar opaque glass and the laying of all marble tile, terrazzo tile, slate tile and precast tile, steps, risers treads, base, or any other materials that may be used as substitutes for any of the aforementioned materials and which are used on interior

and exterior which were installed in a similar manner.

MATERIAL TESTER I: Hand coring and drilling for testing of materials; field inspection of uncured concrete and asphalt.

MATERIAL TESTER II: Field inspection of welds, structural steel, fireproofing, masonry, soil, facade, reinforcing steel, formwork, cured concrete, and concrete and asphalt batch plants; adjusting proportions of bituminous mixtures.

#### TERRAZZO FINISHER

The handling of sand, cement, marble chips, and all other materials that may be used by the Mosaic Terrazzo Mechanic, and the mixing, grinding, grouting, cleaning and sealing of all Marble, Mosaic, and Terrazzo work, floors, base, stairs, and wainscoting by hand or machine, and in addition, assisting and aiding Marble, Masonic, and Terrazzo Mechanics.

#### OPERATING ENGINEERS - BUILDING

Class 1. Mechanic; Asphalt Plant; Asphalt Spreader; Autograde; Backhoes with Caisson attachment; Batch Plant; Benoto; Boiler and Throttle Valve; Caisson Rigs; Central Redi-Mix Plant; Combination Back Hoe Front End-loader Machine; Compressor and Throttle Valve; Concrete Breaker (Truck Mounted); Concrete Conveyor; Concrete Paver; Concrete Placer; Concrete Placing Boom; Concrete Pump (Truck Mounted); Concrete Tower; Cranes, All; Cranes, Hammerhead; Cranes, (GCI and similar Type); Creter Crane; Crusher, Stone, etc.; Derricks, All; Derricks, Traveling; Formless Curb and Gutter Machine; Grader, Elevating; Grouting Machines; Highlift Shovels or Front Endloader 2-1/4 yd. and over; Hoists, Elevators, outside type rack and pinion and similar machines; Hoists, one, two and three Drum; Hoists, Two Tugger One Floor; Hydraulic Backhoes; Hydraulic Boom Trucks; Hydro Vac (and similar equipment); Locomotives, All; Motor Patrol; Pile Drivers and Skid Rig; Post Hole Digger; Pre-Stress Machine; Pump Cretes Dual Ram; Pump Cretes; Squeeze Cretes-screw Type Pumps; Raised and Blind Hole Drill; Roto Mill Grinder; Scoops - Tractor Drawn; Slip-form Paver; Straddle Buggies; Tournapull; Tractor with Boom and Side Boom; Trenching Machines.

Class 2. Boilers; Broom, All Power Propelled; Bulldozers; Concrete Mixer (Two Bag and Over); Conveyor, Portable; Forklift Trucks; Greaser Engineer; Highlift Shovels or Front Endloaders under 2-1/4 yd.; Hoists, Automatic; Hoists, inside Freight Elevators; Hoists, Sewer Dragging Machine; Hoists, Tugger Single Drum; Laser Screed; Rock Drill self-propelled; Rock Drill (truck mounted); Rollers, All; Steam Generators; Tractors, All; Tractor Drawn Vibratory Roller; Winch Trucks with "A" Frame.

Class 3. Air Compressor; Combination - Small Equipment Operator; Generators; Heaters, Mechanical; Hoists, Inside Elevators - (Rheostat Manual Controlled); Hydraulic Power Units (Pile Driving, Extracting, and Drilling); Pumps, over 3" (1 to 3 not to exceed a total of 300 ft.); Pumps, Well Points; Welding Machines (2 through 5); Winches, 4 small Electric Drill Winches; Bobcat (up to and including 3/4 cu. yd.).

Class 4. Bobcats and/or other Skid Steer Loaders; Oilers; and Brick Forklift.

#### OPERATING ENGINEERS - FLOATING

Class 1. Craft foreman (Master Mechanic), diver/wet tender, engineer (hydraulic dredge).

Class 2. Crane/backhoe operator, mechanic/welder, assistant engineer (hydraulic dredge), leverman (hydraulic dredge), and diver tender.

Class 3. Deck equipment operator (machineryman), maintenance of crane (over 50 ton capacity) or backhoe (96,000 pounds or more), tug/launch operator, loader, dozer and like equipment on barge, breakwater wall, slip/dock or scow, deck machinery, etc.

Class 4. Deck equipment operator machineryman/fireman), (4 equipment units or more) and crane maintenance 50 ton capacity and under or backhoe weighing 96,000 pounds or less, assistant tug operator.

#### OPERATING ENGINEERS - HEAVY AND HIGHWAY CONSTRUCTION

Class 1. Craft Foreman; Asphalt Plant; Asphalt Heater and Planer Combination; Asphalt Heater Scarfire; Asphalt Spreader; Autograder/GOMACO or other similar type machines; ABG Paver; Backhoes with Caisson attachment; Ballast Regulator; Belt Loader; Caisson Rigs; Car Dumper; Central Redi-Mix Plant; Combination Backhoe Front Endloader Machine, (1 cu. yd. Backhoe Bucket or over or with attachments); Concrete Breaker (Truck Mounted); Concrete Conveyor; Concrete Paver over 27E cu. ft.; Concrete Placer; Concrete Tube Float; Cranes, all attachments; Cranes, Hammerhead, Linden, Peco & Machines of a like nature; Crete Crane; Crusher, Stone, etc.; Derricks, All; Derrick Boats; Derricks, Traveling; Dowell machine with Air Compressor; Dredges; Field Mechanic-Welder; Formless Curb and Gutter Machine; Gradall and Machines of a like nature; Grader, Elevating; Grader, Motor Grader, Motor Patrol, Auto Patrol, Form Grader, Pull Grader, Subgrader; Guard Rail Post Driver Mounted; Hoists, One, Two and Three Drum; Hydraulic Backhoes; Backhoes with shear attachments; Mucking Machine; Pile Drivers and Skid Rig; Pre-Stress Machine; Pump Cretes Dual Ram; Rock Drill - Crawler or Skid Rig; Rock Drill - Truck Mounted; Roto Mill Grinder; Slip-Form Paver; Soil Test Drill Rig (Truck Mounted); Straddle Buggies; Hydraulic Telescoping Form (Tunnel); Tractor Drawn Belt Loader (with attached pusher - two engineers); Tractor with Boom; Tractaire with Attachments; Trenching Machine; Truck Mounted Concrete Pump with Boom; Raised or Blind Hole; Drills (Tunnel Shaft); Underground Boring and/or Mining Machines; Wheel Excavator; Widener (APSCO).

Class 2. Batch Plant; Bituminous Mixer; Boiler and Throttle Valve; Bulldozers; Car Loader Trailing Conveyors; Combination Backhoe Front Endloader Machine (less than 1 cu. yd. Backhoe Bucket or over or with attachments); Compressor and Throttle Valve; Compressor, Common Receiver (3); Concrete Breaker or Hydro Hammer; Concrete Grinding Machine; Concrete Mixer or Paver 7S Series to and including 27 cu. ft.; Concrete Spreader; Concrete Curing Machine, Burlap Machine, Belting Machine and Sealing Machine; Concrete Wheel Saw; Conveyor Muck Cars (Haglund or Similar Type); Drills, All; Finishing Machine - Concrete; Greaser Engineer; Highlift Shovels or Front Endloader; Hoist - Sewer Dragging Machine; Hydraulic Boom Trucks (All Attachments); Hydro-Blaster; All Locomotives, Dinky; Pump Cretes; Squeeze Cretes-Screw Type Pumps, Gypsum Bulker and Pump; Roller, Asphalt; Rotary Snow Plows; Rototiller, Seaman, etc., self-propelled; Scoops - Tractor Drawn; Self-Propelled Compactor; Spreader - Chip - Stone, etc.; Scraper; Scraper - Prime Mover in Tandem (Regardless of Size); Tank Car Heater; Tractors, Push, Pulling Sheeps Foot, Disc, Compactor, etc.; Tug Boats.

Class 3. Boilers; Brooms, All Power Propelled; Cement Supply Tender; Compressor, Common Receiver (2); Concrete Mixer (Two Bag and Over); Conveyor, Portable; Farm-Type Tractors Used for Mowing, Seeding, etc.; Fireman on Boilers; Forklift Trucks; Grouting Machine; Hoists, Automatic; Hoists, All Elevators; Hoists, Tugger Single Drum; Jeep Diggers; Pipe Jacking Machines; Post-Hole Digger; Power Saw, Concrete Power Driven; Pug Mills; Rollers, other than asphalt; Seed and Straw Blower; Steam Generators; Stump Machine; Winch Trucks with "A" Frame; Work Boats; Tamper - Form-Motor Driven.

Class 4. Air Compressor; Combination - Small Equipment Operator; Directional Boring Machine; Generators; Heaters, Mechanical; Hydraulic Power Unit (Pile Driving, Extracting, or Drilling); Hydro-Blaster; Light Plants, All (1 through 5); Pumps, over 3" (1 to 3 not to exceed a total of 300 ft.); Pumps, Well Points; Tractaire; Welding Machines (2 through 5); Winches, 4 Small Electric Drill Winches.

Class 5. Bobcats (all); Brick Forklifts, Oilers.

#### TRAFFIC SAFETY

Work associated with barricades, horses and drums used to reduce lane usage on highway work, the installation and removal of temporary lane markings, and the installation and removal of temporary road signs.

#### TRUCK DRIVER - BUILDING, HEAVY AND HIGHWAY CONSTRUCTION - EAST & WEST

Class 1. Two or three Axle Trucks. A-frame Truck when used for transportation purposes; Air Compressors and Welding Machines, including those pulled by cars, pick-up trucks and tractors; Ambulances; Batch Gate Lockers; Batch Hopperman; Car and Truck Washers; Carry-alls; Fork Lifts and Hoisters; Helpers; Mechanics Helpers and Greasers; Oil Distributors 2-man operation; Pavement Breakers; Pole Trailer, up to 40 feet; Power Mower Tractors; Self-propelled Chip Spreader; Skipman; Slurry Trucks, 2-man operation; Slurry Truck Conveyor Operation, 2 or 3 man; TEamsters Unskilled dumpman; and Truck Drivers hauling warning lights, barricades, and portable toilets on the job site.

Class 2. Four axle trucks; Dump Crets and Adgetors under 7 yards; Dumpsters, Track Trucks, Euclids, Hug Bottom Dump Turnapulls or Turnatrailers when pulling other than self-loading equipment or similar equipment under 16 cubic yards; Mixer Trucks under 7 yards; Ready-mix Plant Hopper Operator, and Winch Trucks, 2 Axles.

Class 3. Five axle trucks; Dump Crets and Adgetors 7 yards and over; Dumpsters, Track Trucks, Euclids, Hug Bottom Dump Turnatrailers or turnapulls when pulling other than self-loading equipment or similar equipment over 16 cubic yards; Explosives and/or Fission Material Trucks; Mixer Trucks 7 yards or over; Mobile Cranes while in transit; Oil Distributors, 1-man operation; Pole Trailer, over 40 feet; Pole and Expandable Trailers hauling material over 50 feet long; Slurry trucks, 1-man operation; Winch trucks, 3 axles or more; Mechanic--Truck Welder and Truck Painter.

Class 4. Six axle trucks; Dual-purpose vehicles, such as mounted crane trucks with hoist and accessories; Foreman; Master Mechanic; Self-loading equipment like P.B. and trucks with scoops on the front.

Other Classifications of Work:

For definitions of classifications not otherwise set out, the Department generally has on file such definitions which are available. If a task to be performed is not subject to one of the classifications of pay set out, the Department will upon being contacted state which neighboring county has such a classification and provide such rate, such rate being deemed to exist by reference in this document. If no neighboring county rate applies to the task, the Department shall undertake a special determination, such special determination being then deemed to have existed under this determination. If a project requires these, or any classification not listed, please contact IDOL at 618/993-7271 for wage rates or clarifications.

#### LANDSCAPING

Landscaping work falls under the existing classifications for laborer, operating engineer and truck driver. The work performed by landscape plantsman and landscape laborer is covered by the existing classification of laborer. The work performed by landscape operators (regardless of equipment used or its size) is covered by the classifications of operating engineer. The work performed by landscape truck drivers (regardless of size of truck driven) is covered by the classifications of truck driver.



# Crawford County Prevailing Wage for April 2007

Trade Name	RG	TYP	C	Base	FRMAN	*M-F>8	OSA	OSH	H/W	Pensn	Vac	Trng
ASBESTOS ABT-GEN		ALL		20.750	21.200	1.5	1.5	2.0	5.250	5.600	0.000	0.700
ASBESTOS ABT-MEC		BLD		20.800	0.000	2.0	2.0	2.0	5.000	3.400	0.000	0.000
BOILERMAKER		BLD		28.500	31.000	1.5	1.5	2.0	6.820	11.03	0.000	0.300
BRICK MASON		BLD		24.130	25.630	2.0	2.0	2.0	5.200	5.900	0.000	0.630
CARPENTER		BLD		25.590	27.590	1.5	1.5	2.0	6.500	6.800	0.000	0.320
CARPENTER		HWY		23.940	25.690	1.5	1.5	2.0	6.500	6.300	0.000	0.300
CEMENT MASON		BLD		25.830	27.080	1.5	1.5	2.0	5.200	7.000	0.000	0.300
CEMENT MASON		HWY		22.400	23.900	1.5	1.5	2.0	5.200	3.850	0.000	0.200
CERAMIC TILE FNSHER		BLD		25.500	0.000	1.5	1.5	2.0	5.200	5.600	0.000	0.000
COMM SYSTEMS TECH		BLD		23.350	25.700	1.5	1.5	2.0	5.150	4.310	0.000	0.000
ELECTRICIAN		BLD		29.090	31.130	1.5	1.5	2.0	5.150	5.530	0.000	0.290
ELEVATOR CONSTRUCTOR		BLD		34.190	38.460	2.0	2.0	2.0	8.275	6.060	2.050	0.000
GLAZIER		BLD		22.930	0.000	1.5	1.5	2.0	4.320	3.800	0.000	0.300
HT/FROST INSULATOR		BLD		26.110	27.110	1.5	1.5	2.0	4.800	6.860	0.000	0.190
IRON WORKER		ALL		24.450	25.750	1.5	1.5	2.0	6.000	8.000	0.000	0.390
LABORER		BLD		20.750	21.200	1.5	1.5	2.0	5.250	5.600	0.000	0.600
LABORER		HWY		21.000	21.450	1.5	1.5	2.0	5.350	6.150	0.000	0.600
LATHER		BLD		25.590	27.590	1.5	1.5	2.0	6.500	6.800	0.000	0.320
MACHINIST		BLD		36.890	38.890	2.0	2.0	2.0	4.380	5.650	2.550	0.000
MARBLE FINISHERS		BLD		25.500	0.000	1.5	1.5	2.0	5.200	5.600	0.000	0.000
MARBLE MASON		BLD		27.000	0.000	1.5	1.5	2.0	5.200	5.600	0.000	0.000
MILLWRIGHT		BLD		26.000	28.000	1.5	1.5	2.0	6.500	6.850	0.000	0.320
MILLWRIGHT		HWY		16.450	17.700	1.5	1.5	2.0	2.800	3.000	0.000	0.000
OPERATING ENGINEER		ALL	1	28.650	0.000	1.5	1.5	2.0	5.200	6.750	0.000	0.650
OPERATING ENGINEER		ALL	2	18.600	0.000	1.5	1.5	2.0	5.200	6.750	0.000	0.650
PAINTER		ALL		23.000	24.000	1.5	1.5	2.0	5.500	6.200	0.000	0.180
PILEDRIVER		BLD		26.090	28.090	1.5	1.5	2.0	6.500	6.800	0.000	0.320
PILEDRIVER		HWY		24.440	26.190	1.5	1.5	2.0	6.500	6.300	0.000	0.300
PIPEFITTER		ALL		28.850	31.010	1.5	1.5	2.0	5.450	4.750	0.000	0.510
PLASTERER		BLD		23.940	25.440	1.5	1.5	2.0	5.200	8.200	0.000	0.300
PLUMBER		ALL		28.850	31.010	1.5	1.5	2.0	5.450	4.750	0.000	0.510
ROOFER		BLD		22.100	24.100	1.5	1.5	2.0	3.950	3.500	0.000	0.200
SHEETMETAL WORKER		BLD		27.010	28.360	1.5	1.5	2.0	6.150	5.150	0.000	0.480
SPRINKLER FITTER		BLD		31.240	33.240	1.5	1.5	2.0	6.500	5.350	0.000	0.250
STONE MASON		BLD		24.130	25.630	2.0	2.0	2.0	5.200	5.900	0.000	0.630
TERRAZZO FINISHER		BLD		25.500	0.000	1.5	1.5	2.0	5.200	5.600	0.000	0.000
TERRAZZO MASON		BLD		30.780	31.080	1.5	1.5	2.0	0.000	3.750	0.000	0.070
TILE LAYER		BLD		25.590	27.590	1.5	1.5	2.0	6.500	6.800	0.000	0.320
TILE MASON		BLD		27.000	0.000	1.5	1.5	2.0	5.200	5.600	0.000	0.000
TRUCK DRIVER		ALL	1	25.010	0.000	1.5	1.5	2.0	6.500	2.225	0.000	0.000
TRUCK DRIVER		ALL	2	25.410	0.000	1.5	1.5	2.0	6.500	2.225	0.000	0.000
TRUCK DRIVER		ALL	3	25.610	0.000	1.5	1.5	2.0	6.500	2.225	0.000	0.000
TRUCK DRIVER		ALL	4	25.860	0.000	1.5	1.5	2.0	6.500	2.225	0.000	0.000
TRUCK DRIVER		ALL	5	26.610	0.000	1.5	1.5	2.0	6.500	2.225	0.000	0.000
TRUCK DRIVER		O&C	1	20.010	0.000	1.5	1.5	2.0	6.500	2.225	0.000	0.000
TRUCK DRIVER		O&C	2	20.330	0.000	1.5	1.5	2.0	6.500	2.225	0.000	0.000
TRUCK DRIVER		O&C	3	20.490	0.000	1.5	1.5	2.0	6.500	2.225	0.000	0.000
TRUCK DRIVER		O&C	4	20.690	0.000	1.5	1.5	2.0	6.500	2.225	0.000	0.000
TRUCK DRIVER		O&C	5	21.290	0.000	1.5	1.5	2.0	6.500	2.225	0.000	0.000
TUCKPOINTS		BLD		24.130	25.630	2.0	2.0	2.0	5.200	5.900	0.000	0.630

Legend:

M-F>8 (Overtime is required for any hour greater than 8 worked each day, Monday through Friday.)

OSA (Overtime is required for every hour worked on Saturday)

OSH (Overtime is required for every hour worked on Sunday and Holidays)

H/W (Health & Welfare Insurance)

Pensn (Pension)

Vac (Vacation)

Trng (Training)

## Explanations

### CRAWFORD COUNTY

The following list is considered as those days for which holiday rates of wages for work performed apply: New Years Day, Memorial/Decoration Day, Fourth of July, Labor Day, Veterans Day, Thanksgiving Day, Christmas Day. Generally, any of these holidays which fall on a Sunday is celebrated on the following Monday. This then makes work performed on that Monday payable at the appropriate overtime rate for holiday pay. Common practice in a given local may alter certain days of celebration such as the day after Thanksgiving for Veterans Day. If in doubt, please check with IDOL.

Oil and chip resealing (O&C) means the application of road oils and liquid asphalt to coat an existing road surface, followed by application of aggregate chips or gravel to coated surface, and subsequent rolling of material to seal the surface.

### EXPLANATION OF CLASSES

ASBESTOS - GENERAL - removal of asbestos material/mold and hazardous materials from any place in a building, including mechanical systems where those mechanical systems are to be removed. This includes the removal of asbestos materials/mold and hazardous materials from ductwork or pipes in a building when the building is to be demolished at the time or at some close future date.

ASBESTOS - MECHANICAL - removal of asbestos material from mechanical systems, such as pipes, ducts, and boilers, where the mechanical systems are to remain.

### CERAMIC TILE FINISHER, MARBLE FINISHER, TERRAZZO FINISHER

Assisting, helping or supporting the tile, marble and terrazzo mechanic by performing their historic and traditional work assignments required to complete the proper installation of the work covered by said crafts. The term "Ceramic" is used for naming the classification only and is in no way a limitation of the product handled. Ceramic takes into consideration most hard tiles.

### COMMUNICATION SYSTEMS TECHNICIAN

Installation, operation, inspection, maintenance, repair, and service of radio, television, recording, voice sound and vision production and reproduction apparatus, equipment and appliances used for domestic, commercial, education, entertainment and private telephone systems.

### TRUCK DRIVER - BUILDING, HEAVY AND HIGHWAY CONSTRUCTION

Class 1. Drivers on 2 axle trucks hauling less than 9 ton. Air compressor and welding machines and brooms, including those pulled by separate units, truck driver helpers, warehouse employees, mechanic

helpers, greasers and tiremen, pickup trucks when hauling materials, tools, or workers to and from and on-the-job site, and fork lifts up to 6,000 lb. capacity.

Class 2. Two or three axle trucks hauling more than 9 ton but hauling less than 16 ton. A-frame winch trucks, hydrolift trucks, vactor trucks or similar equipment when used for transportation purposes. Fork lifts over 6,000 lb. capacity, winch trucks, four axle combination units, and ticket writers.

Class 3. Two, three or four axle trucks hauling 16 ton or more. Drivers on water pulls, articulated dump trucks, mechanics and working forepersons, and dispatchers. Five axle or more combination units.

Class 4. Low Boy and Oil Distributors.

Class 5. Drivers who require special protective clothing while employed on hazardous waste work.

#### TRUCK DRIVER - OIL AND CHIP RESEALING ONLY.

This shall encompass laborers, workers and mechanics who drive contractor or subcontractor owned, leased, or hired pickup, dump, service, or oil distributor trucks. The work includes transporting materials and equipment (including but not limited to, oils, aggregate supplies, parts, machinery and tools) to or from the job site; distributing oil or liquid asphalt and aggregate; stock piling material when in connection with the actual oil and chip contract. The Truck Driver (Oil & Chip Resealing) wage classification does not include supplier delivered materials.

#### OPERATING ENGINEERS - BUILDING, HEAVY AND HIGHWAY CONSTRUCTION

Class 1. Power Cranes, Draglines, Derricks, Shovels, Gradalls, Mechanics, Tractor Highlift, Tournadozer, Concrete Mixers with Skip, Tournamixer, Two Drum Machine, One Drum Hoist with Tower or Boom, Cableways, Tower Machines, Motor Patrol, Boom Tractor, Boom or Winch Truck, Winch or Hydraulic Boom Truck, Truck Crane, Tournapull, Tractor Operating Scoops, Bulldozer, Push Tractor, Asphalt Planer, Finishing Machine on Asphalt, Large Rollers on Earth, Rollers on Asphalt Mix, Ross Carrier or similar Machine, Gravel Processing Machine, Asphalt Plant Engineer, Paver Operator, Dredging Equipment, or Dredge Engineer, or Dredge Operator, Central Mix Plant Engineer, CMI or similar type machine, Concrete Pump, Truck or Skid Mounted, Tower Crane, Engineer or Rock Crusher Plant, Concrete Plant Engineer, Ditching Machine with dual attachment, Tractor Mounted Loaders, Cherry Picker, Hydro Crane, Standard or Dinkey Locomotives, Scoopmobiles, Euclid Loader, Soil Cement Machine, Back Filler, Elevating Machine, Power Blade, Drilling Machine, including Well Testing, Caissons, Shaft or any similar type drilling machines, Motor Driven Paint Machine, Pipe Cleaning Machine, Pipe Wrapping Machine, Pipe Bending Machine, Apsco Paver, Boring Machine, (Head Equipment Greaser), Barber-Greene Loaders, Formless Paver, (Well Point System), Concrete Spreader, Hydra Ax, Span Saw, Marine Scoops, Brush Mulcher, Brush Burner, Mesh Placer, Tree Mover, Helicopter Crew (3), Piledriver-Skid or Crawler, Stump Remover, Root Rake, Tug Boat Operator, Refrigerating Machine, Freezing Operator, Chair Cart-Self-Propelled, Hydra Seeder, Straw Blower, Power Sub Grader, Bull Float, Finishing Machine, Self-Propelled Pavement Breaker, Lull (or similar type Machine), Two Air Compressors, Compressors hooked in Manifold, Overhead Crane, Chip Spreader, Mud Cat, Sull-Air, Fork Lifts (except when used for landscaping work), Soil Stabilizer (Seaman

Tiller, Bo Mag, Rago Gator, and similar types of equipment), Tube Float, Spray Machine, Curing Machine, Concrete or Asphalt Milling Machine, Snooper Truck-Operator, Backhoe, Farm Tractors (with attachments), 4 Point Lift System (Power Lift or similar type), Skid-Steer (Bob Cat or similar type), Wrecking Shears, Water Blaster.

Class 2. Concrete Mixers without Skips, Rock Crusher, Ditching Machine under 6', Curbing Machine, One Drum Machines without Tower or Boom, Air Tugger, Self-Propelled Concrete Saw, Machine Mounted Post Hole Digger, two to four Generators, Water Pumps or Welding Machines, within 400 feet, Air Compressor 600 cu. ft. and under, Rollers on Aggregate and Seal Coat Surfaces, Fork Lift (when used for landscaping work), Concrete and Blacktop Curb Machine, One Water Pump, Oilers, Air Valves or Steam Valves, One Welding Machine, Truck Jack, Mud Jack, Gunnite Machine, House Elevators when used for hoisting material, Engine Tenders, Fireman, Wagon Drill, Flex Plane, Conveyor, Siphons and Pulsometer, Switchman, Fireman on Paint Pots, Fireman on Asphalt Plants, Distributor Operator on Trucks, Tampers, Self-Propelled Power Broom, Striping Machine (motor driven), Form Tamper, Bulk Cement Plant, Equipment Greaser, Deck Hands, Truck Crane Oiler-Driver, Cement Blimps, Form Grader, Temporary Heat, Throttle Valve, Super Sucker (and similar type of equipment).

#### Other Classifications of Work:

For definitions of classifications not otherwise set out, the Department generally has on file such definitions which are available. If a task to be performed is not subject to one of the classifications of pay set out, the Department will upon being contacted state which neighboring county has such a classification and provide such rate, such rate being deemed to exist by reference in this document. If no neighboring county rate applies to the task, the Department shall undertake a special determination, such special determination being then deemed to have existed under this determination. If a project requires these, or any classification not listed, please contact IDOL at 618/993-7271 for wage rates or clarifications.

#### LANDSCAPING

Landscaping work falls under the existing classifications for laborer, operating engineer and truck driver. The work performed by landscape plantsman and landscape laborer is covered by the existing classification of laborer. The work performed by landscape operators (regardless of equipment used or its size) is covered by the classifications of operating engineer. The work performed by landscape truck drivers (regardless of size of truck driven) is covered by the classifications of truck driver.

# Cumberland County Prevailing Wage for April 2007

Trade Name	RG	TYP	C	Base	FRMAN	*M-F>8	OSA	OSH	H/W	Pensn	Vac	Trng
ASBESTOS ABT-GEN		BLD		24.420	25.420	1.5	1.5	2.0	5.050	5.330	0.000	0.700
ASBESTOS ABT-MEC		BLD		20.800	0.000	2.0	2.0	2.0	5.000	3.400	0.000	0.000
BOILERMAKER		BLD		28.500	31.000	1.5	1.5	2.0	6.820	11.03	0.000	0.300
BRICK MASON		BLD		24.130	25.630	2.0	2.0	2.0	5.200	5.900	0.000	0.630
CARPENTER		BLD		25.590	27.590	1.5	1.5	2.0	6.500	6.800	0.000	0.320
CARPENTER		HWY		25.040	26.790	1.5	1.5	2.0	6.500	7.300	0.000	0.300
CEMENT MASON		BLD		25.830	27.080	1.5	1.5	2.0	5.200	7.000	0.000	0.300
CEMENT MASON		HWY		24.170	25.170	1.5	1.5	2.0	5.200	7.000	0.000	0.300
CERAMIC TILE FNSHER		BLD		25.500	0.000	1.5	1.5	2.0	5.200	5.600	0.000	0.000
ELECTRICIAN		BLD		29.480	32.420	1.5	1.5	2.0	5.150	5.300	0.000	0.440
ELECTRONIC SYS TECH		BLD		24.370	25.870	1.5	1.5	2.0	5.150	3.650	0.000	0.250
ELEVATOR CONSTRUCTOR		BLD		34.190	38.460	2.0	2.0	2.0	8.275	6.060	2.050	0.000
GLAZIER		BLD		27.130	28.130	1.5	2.0	2.0	5.430	4.000	0.000	0.280
HT/FROST INSULATOR		BLD		26.110	27.110	1.5	1.5	2.0	4.800	6.860	0.000	0.190
IRON WORKER		ALL		24.450	25.750	1.5	1.5	2.0	6.000	8.000	0.000	0.390
LABORER		BLD		22.920	23.920	1.5	1.5	2.0	5.050	5.330	0.000	0.600
LABORER		HWY		24.220	24.970	1.5	1.5	2.0	5.050	5.330	0.000	0.600
LATHER		BLD		25.590	27.590	1.5	1.5	2.0	6.500	6.800	0.000	0.320
MACHINIST		BLD		36.890	38.890	2.0	2.0	2.0	4.380	5.650	2.550	0.000
MARBLE FINISHERS		BLD		25.500	0.000	1.5	1.5	2.0	5.200	5.600	0.000	0.000
MARBLE MASON		BLD		27.000	0.000	1.5	1.5	2.0	5.200	5.600	0.000	0.000
MILLWRIGHT		BLD		26.000	28.000	1.5	1.5	2.0	6.500	6.850	0.000	0.320
MILLWRIGHT		HWY		19.410	20.660	1.5	1.5	2.0	2.800	3.000	0.000	0.000
OPERATING ENGINEER		ALL	1	28.650	0.000	1.5	1.5	2.0	5.200	6.750	0.000	0.650
OPERATING ENGINEER		ALL	2	18.600	0.000	1.5	1.5	2.0	5.200	6.750	0.000	0.650
PAINTER		ALL		28.450	29.800	1.5	1.5	2.0	5.200	3.300	0.000	0.320
PAINTER SIGNS		ALL		28.450	29.800	1.5	1.5	2.0	5.200	3.300	0.000	0.320
PILEDRIVER		BLD		26.090	28.090	1.5	1.5	2.0	6.500	6.800	0.000	0.320
PILEDRIVER		HWY		25.540	27.290	1.5	1.5	2.0	6.500	7.300	0.000	0.300
PIPEFITTER		BLD		33.100	35.600	1.5	1.5	2.0	6.450	5.760	0.000	0.620
PLASTERER		BLD		23.940	25.440	1.5	1.5	2.0	5.200	8.200	0.000	0.300
PLUMBER		BLD		33.100	35.600	1.5	1.5	2.0	6.450	5.760	0.000	0.620
ROOFER		BLD		25.460	26.460	1.5	1.5	2.0	6.350	5.150	0.000	0.200
SHEETMETAL WORKER		BLD		28.600	30.600	1.5	1.5	2.0	7.150	7.330	0.000	0.520
SPRINKLER FITTER		BLD		31.240	33.240	1.5	1.5	2.0	6.500	5.350	0.000	0.250
STONE MASON		BLD		24.130	25.630	2.0	2.0	2.0	5.200	5.900	0.000	0.630
TERRAZZO FINISHER		BLD		25.500	0.000	1.5	1.5	2.0	5.200	5.600	0.000	0.000
TERRAZZO MASON		BLD		27.000	0.000	1.5	1.5	2.0	5.200	5.600	0.000	0.000
TILE LAYER		BLD		25.590	27.590	1.5	1.5	2.0	6.500	6.800	0.000	0.320
TILE MASON		BLD		27.000	0.000	1.5	1.5	2.0	5.200	5.600	0.000	0.000
TRUCK DRIVER		ALL	1	25.787	0.000	1.5	1.5	2.0	7.250	3.317	0.000	0.000
TRUCK DRIVER		ALL	2	26.187	0.000	1.5	1.5	2.0	7.250	3.317	0.000	0.000
TRUCK DRIVER		ALL	3	26.387	0.000	1.5	1.5	2.0	7.250	3.317	0.000	0.000
TRUCK DRIVER		ALL	4	26.637	0.000	1.5	1.5	2.0	7.250	3.317	0.000	0.000
TRUCK DRIVER		ALL	5	27.387	0.000	1.5	1.5	2.0	7.250	3.317	0.000	0.000
TRUCK DRIVER		O&C	1	20.630	0.000	1.5	1.5	2.0	7.250	3.317	0.000	0.000
TRUCK DRIVER		O&C	2	20.950	0.000	1.5	1.5	2.0	7.250	3.317	0.000	0.000
TRUCK DRIVER		O&C	3	21.110	0.000	1.5	1.5	2.0	7.250	3.317	0.000	0.000
TRUCK DRIVER		O&C	4	21.310	0.000	1.5	1.5	2.0	7.250	3.317	0.000	0.000
TRUCK DRIVER		O&C	5	21.910	0.000	1.5	1.5	2.0	7.250	3.317	0.000	0.000
TUCKPOINTER		BLD		24.130	25.630	2.0	2.0	2.0	5.200	5.900	0.000	0.630

Legend:

M-F>8 (Overtime is required for any hour greater than 8 worked each day, Monday through Friday.)

OSA (Overtime is required for every hour worked on Saturday)

OSH (Overtime is required for every hour worked on Sunday and Holidays)

H/W (Health & Welfare Insurance)

Pensn (Pension)

Vac (Vacation)

Trng (Training)

## Explanations

### CUMBERLAND COUNTY

The following list is considered as those days for which holiday rates of wages for work performed apply: New Years Day, Memorial/Decoration Day, Fourth of July, Labor Day, Veterans Day, Thanksgiving Day, Christmas Day. Generally, any of these holidays which fall on a Sunday is celebrated on the following Monday. This then makes work performed on that Monday payable at the appropriate overtime rate for holiday pay. Common practice in a given local may alter certain days of celebration such as the day after Thanksgiving for Veterans Day. If in doubt, please check with IDOL.

Oil and chip resealing (O&C) means the application of road oils and liquid asphalt to coat an existing road surface, followed by application of aggregate chips or gravel to coated surface, and subsequent rolling of material to seal the surface.

### EXPLANATION OF CLASSES

ASBESTOS - GENERAL - removal of asbestos material/mold and hazardous materials from any place in a building, including mechanical systems where those mechanical systems are to be removed. This includes the removal of asbestos materials/mold and hazardous materials from ductwork or pipes in a building when the building is to be demolished at the time or at some close future date.

ASBESTOS - MECHANICAL - removal of asbestos material from mechanical systems, such as pipes, ducts, and boilers, where the mechanical systems are to remain.

### CERAMIC TILE FINISHER, MARBLE FINISHER, TERRAZZO FINISHER

Assisting, helping or supporting the tile, marble and terrazzo mechanic by performing their historic and traditional work assignments required to complete the proper installation of the work covered by said crafts. The term "Ceramic" is used for naming the classification only and is in no way a limitation of the product handled. Ceramic takes into consideration most hard tiles.

### ELECTRONIC SYSTEMS TECHNICIAN

Installation, service and maintenance of low-voltage systems which utilizes the transmission and/or transference of voice, sound, vision, or digital for commercial, education, security and entertainment purposes for the following: TV monitoring and surveillance, background/foreground music, intercom and telephone interconnect, field programming, inventory control systems, microwave transmission,

multi-media, multiplex, radio page, school, intercom and sound burglar alarms and low voltage master clock systems.

Excluded from this classification are energy management systems, life safety systems, supervisory controls and data acquisition systems not intrinsic with the above listed systems, fire alarm systems, nurse call systems and raceways exceeding fifteen feet in length.

#### TRUCK DRIVER - BUILDING, HEAVY AND HIGHWAY CONSTRUCTION

Class 1. Drivers on 2 axle trucks hauling less than 9 ton. Air compressor and welding machines and brooms, including those pulled by separate units, truck driver helpers, warehouse employees, mechanic helpers, greasers and tiremen, pickup trucks when hauling materials, tools, or workers to and from and on-the-job site, and fork lifts up to 6,000 lb. capacity.

Class 2. Two or three axle trucks hauling more than 9 ton but hauling less than 16 ton. A-frame winch trucks, hydrolift trucks, vector trucks or similar equipment when used for transportation purposes. Fork lifts over 6,000 lb. capacity, winch trucks, four axle combination units, and ticket writers.

Class 3. Two, three or four axle trucks hauling 16 ton or more. Drivers on water pulls, articulated dump trucks, mechanics and working forepersons, and dispatchers. Five axle or more combination units.

Class 4. Low Boy and Oil Distributors.

Class 5. Drivers who require special protective clothing while employed on hazardous waste work.

#### TRUCK DRIVER - OIL AND CHIP RESEALING ONLY.

This shall encompass laborers, workers and mechanics who drive contractor or subcontractor owned, leased, or hired pickup, dump, service, or oil distributor trucks. The work includes transporting materials and equipment (including but not limited to, oils, aggregate supplies, parts, machinery and tools) to or from the job site; distributing oil or liquid asphalt and aggregate; stock piling material when in connection with the actual oil and chip contract. The Truck Driver (Oil & Chip Resealing) wage classification does not include supplier delivered materials.

#### OPERATING ENGINEERS - BUILDING, HEAVY AND HIGHWAY CONSTRUCTION

Class 1. Power Cranes, Draglines, Derricks, Shovels, Gradalls, Mechanics, Tractor Highlift, Tournadozer, Concrete Mixers with Skip, Tournamixer, Two Drum Machine, One Drum Hoist with Tower or Boom, Cableways, Tower Machines, Motor Patrol, Boom Tractor, Boom or Winch Truck, Winch or Hydraulic Boom Truck, Truck Crane, Tournapull, Tractor Operating Scoops, Bulldozer, Push Tractor, Asphalt Planer, Finishing Machine on Asphalt, Large Rollers on Earth, Rollers on Asphalt Mix, Ross Carrier or similar Machine, Gravel Processing Machine, Asphalt Plant Engineer, Paver Operator, Dredging Equipment, or Dredge Engineer, or Dredge Operator, Central Mix Plant Engineer, CMI or similar type machine, Concrete Pump, Truck or Skid Mounted, Tower Crane, Engineer or Rock Crusher Plant, Concrete Plant Engineer, Ditching Machine with dual attachment, Tractor Mounted Loaders, Cherry Picker, Hydro Crane, Standard or Dinkey Locomotives, Scoopmobiles, Euclid Loader, Soil Cement Machine, Back Filler, Elevating Machine, Power Blade, Drilling Machine, including Well Testing, Caissons, Shaft or any similar type drilling machines, Motor

Driven Paint Machine, Pipe Cleaning Machine, Pipe Wrapping Machine, Pipe Bending Machine, Apsco Paver, Boring Machine, (Head Equipment Greaser), Barber-Greene Loaders, Formless Paver, (Well Point System), Concrete Spreader, Hydra Ax, Span Saw, Marine Scoops, Brush Mulcher, Brush Burner, Mesh Placer, Tree Mover, Helicopter Crew (3), Piledriver-Skid or Crawler, Stump Remover, Root Rake, Tug Boat Operator, Refrigerating Machine, Freezing Operator, Chair Cart-Self-Propelled, Hydra Seeder, Straw Blower, Power Sub Grader, Bull Float, Finishing Machine, Self-Propelled Pavement Breaker, Lull (or similar type Machine), Two Air Compressors, Compressors hooked in Manifold, Overhead Crane, Chip Spreader, Mud Cat, Sull-Air, Fork Lifts (except when used for landscaping work), Soil Stabilizer (Seaman Tiller, Bo Mag, Rago Gator, and similar types of equipment), Tube Float, Spray Machine, Curing Machine, Concrete or Asphalt Milling Machine, Snooper Truck-Operator, Backhoe, Farm Tractors (with attachments), 4 Point Lift System (Power Lift or similar type), Skid-Steer (Bob Cat or similar type), Wrecking Shears, Water Blaster.

Class 2. Concrete Mixers without Skips, Rock Crusher, Ditching Machine under 6', Curbing Machine, One Drum Machines without Tower or Boom, Air Tugger, Self-Propelled Concrete Saw, Machine Mounted Post Hole Digger, two to four Generators, Water Pumps or Welding Machines, within 400 feet, Air Compressor 600 cu. ft. and under, Rollers on Aggregate and Seal Coat Surfaces, Fork Lift (when used for landscaping work), Concrete and Blacktop Curb Machine, One Water Pump, Oilers, Air Valves or Steam Valves, One Welding Machine, Truck Jack, Mud Jack, Gunnite Machine, House Elevators when used for hoisting material, Engine Tenders, Fireman, Wagon Drill, Flex Plane, Conveyor, Siphons and Pulsometer, Switchman, Fireman on Paint Pots, Fireman on Asphalt Plants, Distributor Operator on Trucks, Tampers, Self-Propelled Power Broom, Striping Machine (motor driven), Form Tamper, Bulk Cement Plant, Equipment Greaser, Deck Hands, Truck Crane Oiler-Driver, Cement Blimps, Form Grader, Temporary Heat, Throttle Valve, Super Sucker (and similar type of equipment).

#### Other Classifications of Work:

For definitions of classifications not otherwise set out, the Department generally has on file such definitions which are available. If a task to be performed is not subject to one of the classifications of pay set out, the Department will upon being contacted state which neighboring county has such a classification and provide such rate, such rate being deemed to exist by reference in this document. If no neighboring county rate applies to the task, the Department shall undertake a special determination, such special determination being then deemed to have existed under this determination. If a project requires these, or any classification not listed, please contact IDOL at 618/993-7271 for wage rates or clarifications.

#### LANDSCAPING

Landscaping work falls under the existing classifications for laborer, operating engineer and truck driver. The work performed by landscape plantsman and landscape laborer is covered by the existing classification of laborer. The work performed by landscape operators (regardless of equipment used or its size) is covered by the classifications of operating engineer. The work performed by landscape truck drivers (regardless of size of truck driven) is covered by the classifications of truck driver.



# De Kalb County Prevailing Wage for April 2007

Trade Name	RG	TYP	C	Base	FRMAN	*M-F>8	OSA	OSH	H/W	Pensn	Vac	Trng
=====	==	==	=	=====	=====	=====	==	==	=====	=====	=====	=====
ASBESTOS ABT-GEN		BLD		24.120	25.120	1.5	1.5	2.0	5.850	8.330	0.000	0.600
ASBESTOS ABT-MEC		BLD		23.300	24.800	1.5	1.5	2.0	7.860	4.910	0.000	0.000
BOILERMAKER		BLD		38.540	42.000	2.0	2.0	2.0	6.720	7.440	0.000	0.300
BRICK MASON		BLD		34.850	38.340	1.5	1.5	2.0	7.050	7.870	0.000	0.380
CARPENTER		BLD		31.350	34.490	1.5	1.5	2.0	6.100	6.600	0.000	0.600
CARPENTER		HWY		27.440	29.190	1.5	1.5	2.0	6.300	7.680	0.000	0.400
CEMENT MASON		ALL		35.300	37.300	2.0	1.5	2.0	6.400	8.910	0.000	0.100
CERAMIC TILE FNSHER		BLD		28.520	0.000	2.0	1.5	2.0	5.650	5.750	0.000	0.330
COMMUNICATION TECH		BLD		28.700	30.700	1.5	1.5	2.0	8.200	8.340	0.000	0.570
ELECTRIC PWR EQMT OP		ALL		27.920	35.880	1.5	1.5	2.0	4.750	7.820	0.000	0.210
ELECTRIC PWR GRNDMAN		ALL		21.640	35.880	1.5	1.5	2.0	4.750	6.060	0.000	0.160
ELECTRIC PWR LINEMAN		ALL		33.220	35.880	1.5	1.5	2.0	4.750	9.310	0.000	0.250
ELECTRIC PWR TRK DRV		ALL		22.340	35.880	1.5	1.5	2.0	4.750	6.260	0.000	0.170
ELECTRICIAN		BLD		33.570	36.930	1.5	1.5	2.0	8.200	11.15	0.000	0.670
ELEVATOR CONSTRUCTOR		BLD		38.620	43.450	2.0	2.0	2.0	8.275	6.060	2.320	0.000
FENCE ERECTOR	SE	ALL		34.100	35.810	2.0	2.0	2.0	7.690	13.11	0.000	0.230
GLAZIER		BLD		27.680	28.680	1.5	1.5	2.0	6.400	6.500	0.000	0.500
HT/FROST INSULATOR		BLD		33.300	35.050	1.5	1.5	2.0	7.860	8.610	0.000	0.310
IRON WORKER	NW	ALL		30.760	32.300	2.0	2.0	2.0	6.950	16.62	0.000	0.550
IRON WORKER	SE	ALL		34.100	35.810	2.0	2.0	2.0	7.690	13.11	0.000	0.230
LABORER		BLD		24.120	25.120	1.5	1.5	2.0	5.850	8.330	0.000	0.600
LABORER		HWY		23.270	24.020	1.5	1.5	2.0	5.850	8.330	0.000	0.600
LABORER, SKILLED		HWY		24.670	25.420	1.5	1.5	2.0	5.850	8.330	0.000	0.600
LATHER		BLD		31.350	34.490	1.5	1.5	2.0	6.100	6.600	0.000	0.600
MACHINIST		BLD		36.890	38.890	2.0	2.0	2.0	4.380	5.650	2.550	0.000
MARBLE MASON		BLD		34.850	38.340	1.5	1.5	2.0	7.050	7.870	0.000	0.490
MATERIAL TESTER 1		ALL		21.550	0.000	1.5	1.5	2.0	7.460	4.840	0.000	0.170
MATERIALS TESTER II		ALL		26.550	0.000	1.5	1.5	2.0	7.460	4.840	0.000	0.170
MILLWRIGHT		BLD		32.000	35.200	1.5	1.5	2.0	6.100	9.250	0.000	0.560
OPERATING ENGINEER		BLD	1	37.050	41.050	2.0	2.0	2.0	6.850	6.150	1.900	0.700
OPERATING ENGINEER		BLD	2	36.350	41.050	2.0	2.0	2.0	6.850	6.150	1.900	0.700
OPERATING ENGINEER		BLD	3	33.900	41.050	2.0	2.0	2.0	6.850	6.150	1.900	0.700
OPERATING ENGINEER		BLD	4	31.900	41.050	2.0	2.0	2.0	6.850	6.150	1.900	0.700
OPERATING ENGINEER		HWY	1	36.900	40.900	1.5	1.5	2.0	6.850	6.150	1.900	0.700
OPERATING ENGINEER		HWY	2	36.350	40.900	1.5	1.5	2.0	6.850	6.150	1.900	0.700
OPERATING ENGINEER		HWY	3	35.050	40.900	1.5	1.5	2.0	6.850	6.150	1.900	0.700
OPERATING ENGINEER		HWY	4	33.600	40.900	1.5	1.5	2.0	6.850	6.150	1.900	0.700
OPERATING ENGINEER		HWY	5	32.150	40.900	1.5	1.5	2.0	6.850	6.150	1.900	0.700
ORNAMNTL IRON WORKER	SE	ALL		34.100	35.810	2.0	2.0	2.0	7.690	13.11	0.000	0.230
PAINTER		ALL		34.380	35.380	1.5	1.5	1.5	5.650	5.750	0.000	0.350
PAINTER SIGNS		BLD		28.970	32.520	1.5	1.5	1.5	2.600	2.310	0.000	0.000
PILEDRIVER		BLD		31.850	35.040	1.5	1.5	2.0	6.100	6.600	0.000	0.600
PILEDRIVER		HWY		27.440	29.190	1.5	1.5	2.0	6.300	7.680	0.000	0.400
PIPEFITTER		BLD		36.010	38.010	1.5	1.5	2.0	8.450	8.690	0.000	0.950
PLASTERER		BLD		33.850	35.350	1.5	1.5	2.0	6.740	7.100	0.000	0.400
PLUMBER		BLD		36.010	38.010	1.5	1.5	2.0	8.450	8.690	0.000	0.950
ROOFER		BLD		33.650	35.650	1.5	1.5	2.0	6.460	3.310	0.000	0.330
SHEETMETAL WORKER		BLD		31.690	33.620	1.5	1.5	2.0	4.850	10.29	0.520	0.290
SPRINKLER FITTER		BLD		31.240	33.240	1.5	1.5	2.0	6.500	5.350	0.000	0.250
STEEL ERECTOR	SE	ALL		34.100	35.810	2.0	2.0	2.0	7.690	13.11	0.000	0.230
STONE MASON		BLD		33.250	36.580	1.5	1.5	2.0	6.450	7.020	0.000	0.440
TERRAZZO FINISHER		BLD		29.290	0.000	1.5	1.5	2.0	5.650	6.940	0.000	0.270
TERRAZZO MASON		BLD		33.650	36.650	1.5	1.5	2.0	5.650	8.610	0.000	0.300
TILE LAYER		BLD		31.350	34.490	1.5	1.5	2.0	6.100	6.600	0.000	0.600
TILE MASON		BLD		34.600	38.600	2.0	1.5	2.0	5.650	7.000	0.000	0.460
TRUCK DRIVER		ALL	1	29.700	30.250	1.5	1.5	2.0	6.500	3.400	0.000	0.000
TRUCK DRIVER		ALL	2	29.850	30.250	1.5	1.5	2.0	6.500	3.400	0.000	0.000
TRUCK DRIVER		ALL	3	30.050	30.250	1.5	1.5	2.0	6.500	3.400	0.000	0.000

TRUCK DRIVER	ALL	4	30.250	30.250	1.5	1.5	2.0	6.500	3.400	0.000	0.000
TUCKPOINTER	BLD		34.500	35.500	1.5	1.5	2.0	4.710	6.340	0.000	0.400

Legend:

M-F>8 (Overtime is required for any hour greater than 8 worked each day, Monday through Friday.)

OSA (Overtime is required for every hour worked on Saturday)

OSH (Overtime is required for every hour worked on Sunday and Holidays)

H/W (Health & Welfare Insurance)

Pensn (Pension)

Vac (Vacation)

Trng (Training)

## Explanations

### DEKALB COUNTY

IRONWORKERS (NORTHWEST) - That portion of the county from a point where the western county line intersects with Rt. 30, continuing eastward to Shabbona, north between Shabbona and Clare, and northeast between Clare and New Lebanon.

The following list is considered as those days for which holiday rates of wages for work performed apply: New Years Day, Memorial/Decoration Day, Fourth of July, Labor Day, Veterans Day, Thanksgiving Day, Christmas Day. Generally, any of these holidays which fall on a Sunday is celebrated on the following Monday. This then makes work performed on that Monday payable at the appropriate overtime rate for holiday pay. Common practice in a given local may alter certain days of celebration such as the day after Thanksgiving for Veterans Day. If in doubt, please check with IDOL.

### EXPLANATION OF CLASSES

ASBESTOS - GENERAL - removal of asbestos material/mold and hazardous materials from any place in a building, including mechanical systems where those mechanical systems are to be removed. This includes the removal of asbestos materials/mold and hazardous materials from ductwork or pipes in a building when the building is to be demolished at the time or at some close future date.

ASBESTOS - MECHANICAL - removal of asbestos material from mechanical systems, such as pipes, ducts, and boilers, where the mechanical systems are to remain.

### CERAMIC TILE FINISHER

The grouting, cleaning, and polishing of all classes of tile, whether for interior or exterior purposes, all burned, glazed or unglazed products; all composition materials, granite tiles, warning detectable tiles, cement tiles, epoxy composite materials, pavers, glass, mosaics, fiberglass, and all substitute materials, for tile made in tile-like units; all mixtures in tile like form of cement, metals, and

other materials that are for and intended for use as a finished floor surface, stair treads, promenade roofs, walks, walls, ceilings, swimming pools, and all other places where tile is to form a finished interior or exterior. The mixing of all setting mortars including but not limited to thin-set mortars, epoxies, wall mud, and any other sand and cement mixtures or adhesives when used in the preparation, installation, repair, or maintenance of tile and/or similar materials. The handling and unloading of all sand, cement, lime, tile, fixtures, equipment, adhesives, or any other materials to be used in the preparation, installation, repair, or maintenance of tile and/or similar materials. Ceramic Tile Finishers shall fill all joints and voids regardless of method on all tile work, particularly and especially after installation of said tile work. Application of any and all protective coverings to all types of tile installations including, but not be limited to, all soap compounds, paper products, tapes, and all polyethylene coverings, plywood, masonite, cardboard, and any new type of products that may be used to protect tile installations, Blastrac equipment, and all floor scarifying equipment used in preparing floors to receive tile. The clean up and removal of all waste and materials. All demolition of existing tile floors and walls to be re-tiled.

#### COMMUNICATIONS TECHNICIAN

Installing, manufacturing, assembling and maintaining sound and intercom, protection alarm (security), fire alarm, master antenna television, closed circuit television, low voltage control for computers and/or door monitoring, school communications systems, telephones and servicing of nurse and emergency calls, and the installation and maintenance of transmit and receive antennas, transmitters, receivers, and associated apparatus which operates in conjunction with above systems. All work associated with these system installations will be included EXCEPT the installation of protective metallic conduit in new construction projects (excluding less than ten-foot, runs strictly for protection of cable) and 120 volt AC (or higher) power wiring and associated hardware.

#### LABORER, SKILLED - HIGHWAY

Individuals engaged in the following types of work, irrespective of the site of the work: asbestos abatement worker, handling of any materials with any foreign matter harmful to skin or clothing, track laborer, cement handlers, chloride handlers, the unloading and loading with steel workers and re-bars, concrete workers wet, tunnel helpers in free air, batch dumpers, mason tenders, kettle and tar men, tank cleaners, plastic installers, scaffold workers, motorized buggies or motorized unit used for wet concrete or handling of building materials, laborers with de-watering systems, sewer workers plus depth, rod and chainmen with technical engineers, rod and chainmen with land surveyors, rod and chainmen with surveyors, vibrator operators, cement silica, clay, fly ash, lime and plasters, handlers (bulk or bag), cofferdam workers plus depth, on concrete paving, placing, cutting and tying of reinforcing, deck hand, dredge hand, and shore laborers, bankmen on floating plant, grade checker, power tools, front end man on chip spreaders, cession workers plus depth, gunnite nozzle men, lead man on sewer work, welders, cutters, burners and torchmen, chainsaw operators, jackhammer and drill operators, layout man and/or drainage tile layer, steel form setter - street and highway, air tamping hammermen, signal man on crane, concrete saw operator, screedman on asphalt pavers, laborers tending masons with hot material or where foreign materials are used, mortar mixer operators, multiple concrete duct - leadsman, lumen, asphalt raker, curb asphalt machine operator, ready mix scalemen (permanent, portable

or temporary plant), laborers handling masterplate or similar materials, laser beam operator, concrete burning machine operator, coring machine operator, plaster tender, underpinning and shoring of buildings, pump men, manhole and catch basin, dirt and stone tamper, hose men on concrete pumps, hazardous waste worker, lead base paint abatement worker, lining of pipe, refusing machine, assisting on direct boring machine, the work of laying watermain, fire hydrants, all mechanical joints to watermain work, sewer worker, and tapping water service and forced lift station mechanical worker.

MATERIAL TESTER I: Hand coring and drilling for testing of materials; field inspection of uncured concrete and asphalt.

MATERIAL TESTER II: Field inspection of welds, structural steel, fireproofing, masonry, soil, facade, reinforcing steel, formwork, cured concrete, and concrete and asphalt batch plants; adjusting proportions of bituminous mixtures.

#### TERRAZZO FINISHER

The handling of sand, cement, marble chips, and all other materials that may be used by the Mosaic Terrazzo Mechanic, and the mixing, grinding, grouting, cleaning and sealing of all Marble, Mosaic, and Terrazzo work, floors, base, stairs, and wainscoting by hand or machine, and in addition, assisting and aiding Marble, Masonic, and Terrazzo Mechanics.

#### TRUCK DRIVER - BUILDING, HEAVY AND HIGHWAY CONSTRUCTION

Class 1. Two or three Axle Trucks. A-frame Truck when used for transportation purposes; Air Compressors and Welding Machines, including those pulled by cars, pick-up trucks and tractors; Ambulances; Batch Gate Lockers; Batch Hopperman; Car and Truck Washers; Carry-alls; Fork Lifts and Hoisters; Helpers; Mechanics Helpers and Greasers; Oil Distributors 2-man operation; Pavement Breakers; Pole Trailer, up to 40 feet; Power Mower Tractors; Self-propelled Chip Spreader; Skipman; Slurry Trucks, 2-man operation; Slurry Truck Conveyor Operation, 2 or 3 man; TTeamsters Unskilled dumpman; and Truck Drivers hauling warning lights, barricades, and portable toilets on the job site.

Class 2. Four axle trucks; Dump Crets and Adgetors under 7 yards; Dumpsters, Track Trucks, Euclids, Hug Bottom Dump Turnapulls or Turnatrailers when pulling other than self-loading equipment or similar equipment under 16 cubic yards; Mixer Trucks under 7 yards; Ready-mix Plant Hopper Operator, and Winch Trucks, 2 Axles.

Class 3. Five axle trucks; Dump Crets and Adgetors 7 yards and over; Dumpsters, Track Trucks, Euclids, Hug Bottom Dump Turnatrailers or turnapulls when pulling other than self-loading equipment or similar equipment over 16 cubic yards; Explosives and/or Fission Material Trucks; Mixer Trucks 7 yards or over; Mobile Cranes while in transit; Oil Distributors, 1-man operation; Pole Trailer, over 40 feet; Pole and Expandable Trailers hauling material over 50 feet long; Slurry trucks, 1-man operation; Winch trucks, 3 axles or more; Mechanic--Truck Welder and Truck Painter.

Class 4. Six axle trucks; Dual-purpose vehicles, such as mounted crane trucks with hoist and accessories; Foreman; Master Mechanic; Self-loading equipment like P.B. and trucks with scoops on the front.

#### OPERATING ENGINEERS - BUILDING

Class 1. Assistant Craft Foreman; Craft Foreman; Mechanic; Asphalt

Plant; Asphalt Spreader; Autograde; Batch Plant; Benoto (requires Two Engineers); Boiler and Throttle Valve; Caisson Rigs; Central Redi-Mix Plant; Combination Back Hoe Front End-loader Machine; Compressor and Throttle Valve; Concrete Breaker (Truck Mounted); Concrete Conveyor; Concrete Paver; Concrete Placer; Concrete Pump (Truck Mounted); Concrete Tower, Cranes, All, Cranes, Hammerhead, Creter Crane; Crusher, Stone, etc.; Derricks, All; Derricks, Traveling; Formless Curb and Gutter Machine; Grader, Elevating; Grouting Machines; Highlift Shovels or Front Endloader 2-1/4 yd. and over; Hoists, Elevators, outside type rack and pinion and similar machines; Hoists, one, two and three Drum; Hoists, Two tigger One Floor; Hydraulic Backhoes; Hydraulic Boom Trucks; Locomotives, All; Motor Patrol; Pile Drivers and Skid Rig; Post Hole Digger; Pre-Stress Machine; Pump Cretes; Squeeze Cretes-screw Type Pumps; Gypsum Bulker and Pump; Raised and Blind Hole Drill; Rock Drill; Roto Mill Grinder; Scoops - Tractor Drawn; Slip-form Paver; Straddle Buggies; Tie Back Machine; Tractor with Book and Side Boom; Trenching Machines.

Class 2. Bobcat (over 3/4 cu. yd.); Boilers Brick Forklift; Broom, All Power Propelled; Bulldozers; Concrete Mixer (Two Bag and Over); Conveyor, Portable; Forklist Trucks; Greaser Engineer; Highlift Shovels or Front Endloaders under 2-1/4 yd.; Hoists, Automatic; Hoists, Sewer Dragging Machine; Hoists, Tigger Single Drum; Rollers, All; Steam Generators; Tractors, All; Tractor Drawn Vibratory Roller; Winch Trucks with "A" Frame.

Class 3. Air Compressor; Asphalt Spreader; Combination - Small Equipment Operator; Generators; Heaters, Mechanical; Hoists, Inside Elevators - (Rheostat Manual Controlled); Hydraulic Power Units (Pile Driving and Extracting); Pumps, over 3" (1 to 3 not to exceed a total of 300 ft.); Pumps, Well Points; Welding Machines (2 through 5); Winches, 4 small Electric Drill Winches; Bobcat (up to and including 3/4 cu. yd.).

Class 4. Hoists, Inside Elevators, Push Button with Automatic Doors; Oilers; Brick Forklift.

#### OPERATING ENGINEERS - HEAVY AND HIGHWAY CONSTRUCTION

Class 1. Craft Foreman; Asphalt Plant, Asphalt Heater and Planer Combination; Asphalt Heater Scarfire; Asphalt Silo Tender; Asphalt Spreader; Autograder; ABG Paver; Backhoes with Caisson attachment; Ballast Regulator, Belt Loader; Caisson Rigs; Car Dumper; Central Redi-Mix Plant; Backhoe w/shear attachments; Combination Backhoe Front Endloader Machine, (1 cu. yd. Backhoe Bucket or over or with attachments); Concrete Breaker (Truck Mounted); Concrete Conveyor; Concrete Paver over 27E cu. ft.; Concrete Placer; Concrete Tube Float; Cranes, all attachments; Cranes, Hammerhead, Linden, Peco & Machines of a like nature; Crete Crane; Crusher, Stone, etc.; Derricks, All; Derrick Boats; Derricks, Traveling; Directional Boring Machine over 12"; Dredges; Field Mechanic-Welder; Formless Curb and Gutter Machine; Gradall and Machines of a like nature; Grader, Elevating; Grader, Motor Grader, Motor Patrol, Auto Patrol, Form Grader, Pull Grader, Subgrader; Guard Rail Post Driver Mounted; Hoists, One, Two and Three Drum; Hydraulic Backhoes; Pile Drivers and Skid Rig; Pre-Stress Machine; Pump Cretes Dual Ram; Rock Drill - Crawler or Skid Rig; Rock Drill - Truck Mounted; Rock/Track Tamper; Roto Mill Grinder; Slip-Form Paver; Soil Test Drill Rig (Truck Mounted); Straddle Buggies; GCI Crane; Hydraulic Telescoping form (Tunnel); Tie Back Machine; Tractor Drawn Belt Loader; Tractor with Boom; Tractor-aire with Attachments; Traffic Barrier conveyor machine; Raised or Blind Hole; Trenching Machine; Truck Mounted Concrete Pump with Boom; Truck Mounted Concrete Conveyor; Underground Boring and/or Mining Machines; Wheel Excavator; Widener (APSCO).

Class 2. Batch Plant; Bituminous Mixer; Boiler and Throttle Valve; Bulldozers; Car Loader Trailing Conveyors; Combination Backhoe Front Endloader Machine (less than 1 cu. yd. Backhoe Bucket or over or with attachments); Compressor and Throttle Valve; Compressor, Common Receiver (3); Concrete Breaker or Hydro Hammer; Concrete Grinding Machine; Concrete Mixer or Paver 7S Series to and including 27 cu. ft.; Concrete Spreader; Concrete Curing Machine, Burlap Machine, Belting Machine and Sealing Machine; Conveyor Muck Cars (Haglund or Similar Type); Drills, all; Finishing Machine - Concrete; Greaser Engineer; Highlift Shovels or Front Endloader; Hoist - Sewer Dragging Machine; Hydraulic Boom Trucks (All Attachments); Hydro Blaster; Laser Screed; All Locomotives, Dinky; Pump Cretes; Squeeze Cretes-Screw Type Pumps, Gypsum Bulker and Pump; Roller, Asphalt; Rotary Snow Plows; Rototiller, Seaman, etc., self-propelled; Scoops - Tractor Drawn; Self-Propelled Compactor; Spreader - Chip - Stone, etc.; Scraper; Scraper - Prime Mover in Tandem (Regardless of Size); Tank Car Heater; Tractors, Push, Pulling Sheeps Foot, Disc, Compactor, etc. Tug Boats.

Class 3. Boilers; Brooms, All Power Propelled; Cement Supply Tender; Compressor, Common Receiver (2); Concrete Mixer (Two Bag and Over); Conveyor, Portable; Farm-Type Tractors Used for Mowing, Seeding, etc.; Fireman on Boilers; Forklift Trucks; Grouting Machine; Hoists, Automatic; Hoists, All Elevators; Hoists, Tugger Single Drum; Jeep Diggers, Low Boys; Pipe Jacking Machines; Post-Hole Digger; Power Saw, Concrete Power Driven; Pug Mills; Rollers, other than asphalt; Seed and Straw Blower; Steam Generators; Stump Machine; Winch Trucks with "A" Frame; Work Boats; Tamper - Form-Motor Driven.

Class 4. Air Compressor - Small and Large; Asphalt Spreader, Backend Man; Bobcat (Skid Steer) all; Combination - Small Equipment Operator; Directional Boring Machine up to 12"; Generators - Small 50kw and Under; Generators - Large over 50kw; Heaters, Mechanical; Hydraulic Power Unit (Pile Driving, Extracting, or Drilling); Hydro-Blaster; Light Plants, All (1 through 5); Pumps, over 3" (1 to 3 not to exceed a total of 300 ft.); Pumps, Well Points; Tract-aire; Welding Machines (2 through 5); Winches, 4 Small Electric Drill Winches.

Class 5. Oilers and Directional Boring Machine Locator.

#### Other Classifications of Work:

For definitions of classifications not otherwise set out, the Department generally has on file such definitions which are available. If a task to be performed is not subject to one of the classifications of pay set out, the Department will upon being contacted state which neighboring county has such a classification and provide such rate, such rate being deemed to exist by reference in this document. If no neighboring county rate applies to the task, the Department shall undertake a special determination, such special determination being then deemed to have existed under this determination. If a project requires these, or any classification not listed, please contact IDOL at 618/993-7271 for wage rates or clarifications.

#### LANDSCAPING

Landscaping work falls under the existing classifications for laborer, operating engineer and truck driver. The work performed by landscape plantsman and landscape laborer is covered by the existing classification of laborer. The work performed by landscape operators (regardless of equipment used or its size) is covered by the

classifications of operating engineer. The work performed by landscape truck drivers (regardless of size of truck driven) is covered by the classifications of truck driver.

# Dewitt County Prevailing Wage for April 2007

Trade Name	RG	TYP	C	Base	FRMAN	*M-F>8	OSA	OSH	H/W	Pensn	Vac	Trng
=====	==	==	=	=====	=====	=====	==	==	=====	=====	=====	=====
ASBESTOS ABT-GEN		BLD		24.450	25.450	1.5	1.5	2.0	5.050	6.090	0.000	0.700
ASBESTOS ABT-MEC		BLD		25.290	26.290	1.5	1.5	2.0	4.450	2.500	0.000	0.250
BOILERMAKER		BLD		30.970	33.970	2.0	2.0	2.0	8.270	7.740	0.000	0.300
BRICK MASON		BLD		26.510	28.010	1.5	1.5	2.0	5.500	6.750	0.000	0.380
CARPENTER		BLD		26.850	28.850	1.5	1.5	2.0	6.500	6.250	0.000	0.320
CARPENTER		HWY		27.960	29.960	1.5	1.5	2.0	6.500	6.500	0.000	0.320
CEMENT MASON	N	ALL		24.690	25.440	1.5	1.5	2.0	5.050	8.350	0.000	0.300
CEMENT MASON	S	BLD		24.270	25.020	1.5	1.5	2.0	6.500	6.890	0.000	0.300
CEMENT MASON	S	HWY		22.980	23.980	1.5	1.5	2.0	6.500	6.890	0.000	0.300
CERAMIC TILE FNSHER		BLD		24.910	0.000	1.5	1.5	2.0	5.500	6.350	0.000	0.380
ELECTRIC PWR EQMT OP		ALL		30.750	0.000	1.5	1.5	2.0	4.750	8.610	0.000	0.000
ELECTRIC PWR GRNDMAN		ALL		21.090	0.000	1.5	1.5	2.0	4.750	5.905	0.000	0.000
ELECTRIC PWR LINEMAN		ALL		34.160	36.350	1.5	1.5	2.0	4.750	9.560	0.000	0.000
ELECTRIC PWR TRK DRV		ALL		22.130	0.000	1.5	1.5	2.0	4.750	6.200	0.000	0.000
ELECTRICIAN		BLD		29.480	32.420	1.5	1.5	2.0	5.150	5.300	0.000	0.440
ELECTRONIC SYS TECH		BLD		24.290	25.790	1.5	1.5	2.0	5.150	3.730	0.000	0.250
ELEVATOR CONSTRUCTOR		BLD		34.190	38.460	2.0	2.0	2.0	8.275	6.060	2.050	0.000
FENCE ERECTOR		ALL		26.420	28.170	1.5	1.5	2.0	6.590	6.150	0.000	0.500
GLAZIER		BLD		27.130	28.130	1.5	2.0	2.0	5.430	4.000	0.000	0.280
HT/FROST INSULATOR		BLD		30.440	31.440	1.5	1.5	2.0	4.850	8.360	0.000	0.450
IRON WORKER	E	ALL		26.420	28.170	1.5	1.5	2.0	6.590	6.150	0.000	0.500
IRON WORKER	W	BLD		25.400	27.150	1.5	1.5	2.0	5.860	7.900	0.000	0.300
IRON WORKER	W	HWY		25.400	26.900	1.5	1.5	2.0	5.860	7.900	0.000	0.300
LABORER		BLD		22.950	23.950	1.5	1.5	2.0	5.050	6.090	0.000	0.600
LABORER		HWY		23.860	24.610	1.5	1.5	2.0	5.050	6.090	0.000	0.600
LATHER		BLD		26.850	28.850	1.5	1.5	2.0	6.500	6.250	0.000	0.320
MACHINIST		BLD		36.890	38.890	2.0	2.0	2.0	4.380	5.650	2.550	0.000
MARBLE FINISHERS		BLD		24.910	0.000	1.5	1.5	2.0	5.500	6.350	0.000	0.380
MARBLE MASON		BLD		26.520	27.770	1.5	1.5	2.0	5.500	6.350	0.000	0.380
MILLWRIGHT		BLD		26.680	28.680	1.5	1.5	2.0	6.500	6.850	0.000	0.320
MILLWRIGHT		HWY		17.100	18.350	1.5	1.5	2.0	1.450	1.500	0.000	0.000
OPERATING ENGINEER		BLD	1	26.550	0.000	1.5	1.5	2.0	6.150	6.200	0.000	0.850
OPERATING ENGINEER		BLD	2	24.200	0.000	1.5	1.5	2.0	6.150	6.200	0.000	0.850
OPERATING ENGINEER		BLD	3	20.600	0.000	1.5	1.5	2.0	6.150	6.200	0.000	0.850
OPERATING ENGINEER		BLD	4	28.050	0.000	1.5	1.5	2.0	6.150	6.200	0.000	0.850
OPERATING ENGINEER		HWY	1	26.800	0.000	1.5	1.5	2.0	6.150	6.200	0.000	0.850
OPERATING ENGINEER		HWY	2	24.030	0.000	1.5	1.5	2.0	6.150	6.200	0.000	0.850
OPERATING ENGINEER		HWY	3	19.800	0.000	1.5	1.5	2.0	6.150	6.200	0.000	0.850
OPERATING ENGINEER		HWY	4	28.300	0.000	1.5	1.5	2.0	6.150	6.200	0.000	0.850
OPERATING ENGINEER		O&C		21.440	0.000	1.5	1.5	2.0	6.150	6.200	0.000	0.850
PAINTER		ALL		24.380	25.380	1.5	1.5	2.0	5.050	5.950	0.000	0.400
PAINTER OVER 30FT		ALL		25.380	26.380	1.5	1.5	2.0	5.050	5.950	0.000	0.400
PAINTER PWR EQMT		ALL		25.130	26.130	1.5	1.5	2.0	5.050	5.950	0.000	0.400
PILEDRIVER		BLD		27.350	29.350	1.5	1.5	2.0	6.500	6.250	0.000	0.320
PILEDRIVER		HWY		28.960	30.960	1.5	1.5	2.0	6.500	6.500	0.000	0.320
PIPEFITTER		BLD		32.480	34.980	1.5	1.5	2.0	6.450	4.800	0.000	0.670
PLASTERER		BLD		25.920	27.920	1.5	1.5	2.0	4.700	9.300	0.000	0.400
PLUMBER		BLD		32.480	34.980	1.5	1.5	2.0	6.450	4.800	0.000	0.670
ROOFER		BLD		24.200	25.200	1.5	1.5	2.0	5.350	6.550	0.000	0.150
SHEETMETAL WORKER		BLD		27.200	28.950	1.5	1.5	2.0	6.900	6.960	0.000	0.550
SPRINKLER FITTER		BLD		31.240	33.240	1.5	1.5	2.0	6.500	5.350	0.000	0.250
TERRAZZO FINISHER		BLD		24.910	0.000	1.5	1.5	2.0	5.500	6.350	0.000	0.380
TERRAZZO MASON		BLD		26.520	27.770	1.5	1.5	2.0	5.500	6.350	0.000	0.380
TILE MASON		BLD		26.520	27.770	1.5	1.5	2.0	5.500	6.350	0.000	0.380
TRUCK DRIVER		O&C	1	20.630	0.000	1.5	1.5	2.0	7.250	3.317	0.000	0.000
TRUCK DRIVER		O&C	2	20.950	0.000	1.5	1.5	2.0	7.250	3.317	0.000	0.000
TRUCK DRIVER		O&C	3	21.110	0.000	1.5	1.5	2.0	7.250	3.317	0.000	0.000
TRUCK DRIVER		O&C	4	21.310	0.000	1.5	1.5	2.0	7.250	3.317	0.000	0.000



TRUCK DRIVER		O&C	5	21.910	0.000	1.5	1.5	2.0	7.250	3.317	0.000	0.000
TRUCK DRIVER	N	ALL	1	25.787	0.000	1.5	1.5	2.0	7.250	3.317	0.000	0.000
TRUCK DRIVER	N	ALL	2	26.187	0.000	1.5	1.5	2.0	7.250	3.317	0.000	0.000
TRUCK DRIVER	N	ALL	3	26.387	0.000	1.5	1.5	2.0	7.250	3.317	0.000	0.000
TRUCK DRIVER	N	ALL	4	26.637	0.000	1.5	1.5	2.0	7.250	3.317	0.000	0.000
TRUCK DRIVER	N	ALL	5	27.387	0.000	1.5	1.5	2.0	7.250	3.317	0.000	0.000
TRUCK DRIVER	S	ALL	1	25.930	0.000	1.5	1.5	2.0	7.250	3.425	0.000	0.000
TRUCK DRIVER	S	ALL	2	26.330	0.000	1.5	1.5	2.0	7.250	3.425	0.000	0.000
TRUCK DRIVER	S	ALL	3	26.530	0.000	1.5	1.5	2.0	7.250	3.425	0.000	0.000
TRUCK DRIVER	S	ALL	4	26.780	0.000	1.5	1.5	2.0	7.250	3.425	0.000	0.000
TRUCK DRIVER	S	ALL	5	27.530	0.000	1.5	1.5	2.0	7.250	3.425	0.000	0.000

Legend:

M-F>8 (Overtime is required for any hour greater than 8 worked each day, Monday through Friday.)

OSA (Overtime is required for every hour worked on Saturday)

OSH (Overtime is required for every hour worked on Sunday and Holidays)

H/W (Health & Welfare Insurance)

Pensn (Pension)

Vac (Vacation)

Trng (Training)

## Explanations

DEWITT COUNTY

IRONWORKERS (EAST) - That part of the county East including Clinton.

CEMENT MASON & PLASTERERS (SOUTH) - That part of the county South including Clinton.

TRUCK DRIVERS (NORTH) - That part of the county north of Route 10.

The following list is considered as those days for which holiday rates of wages for work performed apply: New Years Day, Memorial/Decoration Day, Fourth of July, Labor Day, Veterans Day, Thanksgiving Day, Christmas Day. Generally, any of these holidays which fall on a Sunday is celebrated on the following Monday. This then makes work performed on that Monday payable at the appropriate overtime rate for holiday pay. Common practice in a given local may alter certain days of celebration such as the day after Thanksgiving for Veterans Day. If in doubt, please check with IDOL.

Oil and chip resealing (O&C) means the application of road oils and liquid asphalt to coat an existing road surface, followed by application of aggregate chips or gravel to coated surface, and subsequent rolling of material to seal the surface.

EXPLANATION OF CLASSES

ASBESTOS - GENERAL - removal of asbestos material/mold and hazardous materials from any place in a building, including mechanical systems where those mechanical systems are to be removed. This includes the

removal of asbestos materials/mold and hazardous materials from ductwork or pipes in a building when the building is to be demolished at the time or at some close future date.

ASBESTOS - MECHANICAL - removal of asbestos material from mechanical systems, such as pipes, ducts, and boilers, where the mechanical systems are to remain.

#### CERAMIC TILE FINISHER, MARBLE FINISHER, TERRAZZO FINISHER

Assisting, helping or supporting the tile, marble and terrazzo mechanic by performing their historic and traditional work assignments required to complete the proper installation of the work covered by said crafts. The term "Ceramic" is used for naming the classification only and is in no way a limitation of the product handled. Ceramic takes into consideration most hard tiles.

#### ELECTRONIC SYSTEMS TECHNICIAN

Installation, service and maintenance of low-voltage systems which utilizes the transmission and/or transference of voice, sound, vision, or digital for commercial, education, security and entertainment purposes for the following: TV monitoring and surveillance, background/foreground music, intercom and telephone interconnect, field programming, inventory control systems, microwave transmission, multi-media, multiplex, radio page, school, intercom and sound burglar alarms and low voltage master clock systems.

Excluded from this classification are energy management systems, life safety systems, supervisory controls and data acquisition systems not intrinsic with the above listed systems, fire alarm systems, nurse call systems and raceways exceeding fifteen feet in length.

#### TRUCK DRIVER - BUILDING, HEAVY AND HIGHWAY CONSTRUCTION

Class 1. Drivers on 2 axle trucks hauling less than 9 ton. Air compressor and welding machines and brooms, including those pulled by separate units, truck driver helpers, warehouse employees, mechanic helpers, greasers and tiremen, pickup trucks when hauling materials, tools, or workers to and from and on-the-job site, and fork lifts up to 6,000 lb. capacity.

Class 2. Two or three axle trucks hauling more than 9 ton but hauling less than 16 ton. A-frame winch trucks, hydrolift trucks, vector trucks or similar equipment when used for transportation purposes. Fork lifts over 6,000 lb. capacity, winch trucks, four axle combination units, and ticket writers.

Class 3. Two, three or four axle trucks hauling 16 ton or more. Drivers on water pulls, articulated dump trucks, mechanics and working forepersons, and dispatchers. Five axle or more combination units.

Class 4. Low Boy and Oil Distributors.

Class 5. Drivers who require special protective clothing while employed on hazardous waste work.

#### TRUCK DRIVER - OIL AND CHIP RESEALING ONLY.

This shall encompass laborers, workers and mechanics who drive contractor or subcontractor owned, leased, or hired pickup, dump, service, or oil distributor trucks. The work includes transporting materials and equipment (including but not limited to, oils, aggregate supplies, parts, machinery and tools) to or from the job site;

distributing oil or liquid asphalt and aggregate; stock piling material when in connection with the actual oil and chip contract. The Truck Driver (Oil & Chip Resealing) wage classification does not include supplier delivered materials.

#### OPERATING ENGINEERS - BUILDING

CLASS 1. Asphalt Screed Man; Aspco Concrete Spreaders; Asphalt Pavers; Asphalt Plant Engineer; Asphalt Rollers on Bituminous Concrete; Athey Loaders; Backfillers, Crane Type; Backhoes; Barber Green Loaders; Bulldozers; Cableways; Cherry Pickers; Clam Shells; C.M.I. & similar type autograde formless paver, autograde placer & finisher; Concrete Breakers; Concrete Pumps; Derricks; Derrick Boats; Draglines; Earth Auger or Boring Machines; Elevating Graders; Engineers on Dredges; Gravel Processing Machines; Head Equipment Greaser; High Lifts or Fork Lifts; Hoists with two or more drums or two or more load lines; Locomotives, All; Mechanics; Motor Graders or Auto Patrols; Operators or Leverman on Dredges; Operators, Power Boat; Operators, Pug Mill (Asphalt Plants); Orange Peels; Overhead Cranes; Paving Mixers; Piledrivers; Pipe Wrapping and Painting Machines; Pushdozers, or Push Cats; Robotic Controlled Equipment in this Classification; Rock Crushers; Ross Carrier or Similar Machines; Rotomill; Scoops, Skimmer, two cu. yd. capacity and under; Scoops, All or Tournapull; Sheep-Foot Roller (Self Propelled); Shovels; Skid Steer; Skimmer Scoops; Temporary Concrete Plant Operators; Test Hole Drilling Machines; Tower Machines; Tower Mixers; Track Type End Loaders; Track Type Fork Lifts or High Lifts; Track Jacks and Tampers; Tractors, Sideboom; Trenching or Ditching Machine; Tunnelluggers; Vermeer Type Saws; Water Blaster Cutting Head; Wheel Type End Loaders; Winch Cat.

CLASS 2. Air Compressors (six to eight)\*; Asphalt Boosters and Heaters; Asphalt Distributors; Asphalt Plant Fireman; Oiler on Two Paving Mixers When Used in Tandem; Boom or Winch Trucks; Bull Floats or Flexplanes; Concrete Finishing Machine; Concrete Saws, Self-Propelled; Concrete Spreading Machines; Conveyors (six to eight)\*; Generators (six to eight)\*; Gravel or Stone Spreader, Power Operated; Hoist (with One Drum and One Load Line); Light Plants (six to eight)\*; Mechanical Heaters (six to eight)\*; Mud Jacks; Post Hole Digger, Mechanical; Pug Mills when used for other than Asphalt operation; Robotic Controlled Equipment in this Classification; Road or Street Sweeper, Self Propelled; Rollers (except bituminous concrete); Seaman Tiller; Straw Machine; Vibratory Compactor; Water Blaster, Power Unit; Welding Machines (six to eight)\*; Well Drill Machines.

CLASS 3. Air Compressors(one to five)\*; Air Compressors, Track or Self-Propelled; Automatic Hoist; Building Elevators; Bulk Cement Batching Plants; Conveyors (one to five)\*; Concrete Mixers (Except Plant, Paver, or Tower); Firemen; Generators (one to five)\*; Greasers; Helper on Single Paving Mixer; Hoist, Automatic; Light Plants (one to five)\*; Mechanic Helpers; Mechanical Heaters (one to five)\*; Oilers; Power Form Graders; Power Sub-Graders; Robotic Controlled Equipment in this Classification; Scissors Hoist; Tractors without power attachments regardless of size or type; Truck Crane Oiler and Driver (1 man); Vibratory Hammer (power source); Water Pumps (one to five)\*; Welding Machines (1/300 Amp. or over)\*; Welding machines (one to five)\*

CLASS 4. Lattice Boom Crawler Cranes; Lattice Boom Truck Cranes; Telescopic Truck-Mounted Cranes; Tower Cranes.

\* Combinations of one to eight of any Air Compressors, Conveyors,

Welding Machines, Water Pumps, Light Plants, or Generators shall be in batteries or within 400 feet and shall be paid as per the Classification Schedule contained in this Article.

#### OPERATING ENGINEERS - HIGHWAY

CLASS 1. Asphalt Screed Man; Asphco Concrete Spreaders; Asphalt Pavers; Asphalt Plant Engineer; Asphalt Rollers on Bituminous Concrete; Athey Loaders; Backhoes; Barber Green Loaders; Bulldozers; Cableways; Carry Deck Pickers; Cherry Pickers (Rough Terrain); C.M.I. & similar type-autograde formless paver, autograde placer & finisher; Concrete Breakers; Concrete Plant Operators; Concrete Pumps; Derricks; Derrick Boats; Dewatering Systems; Earth Auger or Boring Machines; Elevating Graders; Engineers on Dredges; Gravel Processing Machines; Grout Pump; Head Equipment Greaser; High Lifts or Fork Lifts; Hoists with two or more drums or two or more load lines; Hydro Jet or Hydro Laser; Locomotives, All; Mechanics; Motor Graders or Auto Patrols; Multi-Point Power Lifting Equipment; Operators or Leverman on Dredges; Operators, Power Boat; Operators, Pug Mill (Asphalt Plants); Overhead Cranes; Paving Mixers; Piledrivers; Pipe Wrapping and Painting Machines; Push-dozers, or Push Cats; Robotic Controlled Equipment in this Classification; Rock Crushers; Ross Carrier or Similar Machines; Roto-Mill; Scoops, Skimmer, two cu. yd. capacity and under; Sheep-Foot Roller (Self Pro-pelled); Shovels; Skid Steer; Skimmer Scoops; Test Hole Drilling Machines; Tower Machines; Tower Mixers; Track Type End Loaders; Track Type Fork Lifts or High Lifts; Track Jacks and Tampers; Tractors, Side-boom; Trenching or Ditching Machine; Tunnelluggers; Vermeer-Type Saws; Wheel Type End Loaders; Winch Cat; Scoops, All or Tournapull.

CLASS 2. Air Compressors (six to eight)\*; Articulated Dumps; Asphalt Boosters and Heaters; Asphalt Distributors; Asphalt Plant Fireman; Boom or Winch Trucks; Building Elevators; Bull Floats or Flexplanes; Concrete Finishing Machine; Concrete Saws, Self-Propelled; Concrete Spreading Machines; Conveyors (six to eight)\*; Generators (six to eight)\*; Gravel or Stone Spreader, Power Operated; Hoist, Automatic; Hoist with One Drum and One Load Line; Light Plants (six to eight)\*; Mechanical Heaters (six to eight)\*; Mud Jacks; Off Road Water Wagons; Oiler on Two Paving Mixers When Used in Tandem; Post Hole Digger, Mechanical; Robotic Controlled Equipment in This Classification; Road or Street Sweeper, Self-Propelled; Rollers (except bituminous concrete); Scissor Hoist; Sea-man Tiller; Straw Machine; Vibratory Compactor; Water Pumps (six to eight)\*; Well Drill Machines.

CLASS 3. Air Compressors (one to five)\*; Air Compressors, Track or Self-Propelled; Bulk Cement Batching Plants; Conveyors (one to five)\*; Concrete Mixers (Except Plant, Paver, or Tower); Firemen; Generators (one to five)\*; Greasers; Helper on Single Paving Mixer; Light Plants (one to five)\*; Mechanic Helpers; Mechanical Heaters (one to five)\*; Oilers; Power Form Graders; Power Sub-Graders; Pug Mills when used for other than Asphalt operation; Robotic Controlled Equipment in This Classification; Tractors without power attachments, regardless of size or type; Truck Crane Oiler and Driver (1 man); Vibratory Hammer (power source); Water Pumps (one to five)\*; Welding Machines (one 300 Amp. or over)\*; Welding Machines (one to five)\*.

CLASS 4. Lattice Boom Crawler Crane; Lattice Boom Truck Crane; Telescopic Truck-Mounted Crane; Tower Crane.

\*Combinations of one to eight of any Air Compressors, Conveyors, Welding Machines, Water Pumps, Light Plants or Generators shall be in batteries or within 400 feet and shall be paid as per the Classification Schedule contained in this Article.

OPERATING ENGINEER - OIL AND CHIP RESEALING ONLY.

This shall encompass the operation of all motorized heavy equipment used in oil and chip resealing, including but not limited to operating self-propelled chip spreaders, and all types of rollers (both hard and rubber tired); and other duties pertaining to the operation or maintenance of heavy equipment related to oil & chip resealing.

Other Classifications of Work:

For definitions of classifications not otherwise set out, the Department generally has on file such definitions which are available. If a task to be performed is not subject to one of the classifications of pay set out, the Department will upon being contacted state which neighboring county has such a classification and provide such rate, such rate being deemed to exist by reference in this document. If no neighboring county rate applies to the task, the Department shall undertake a special determination, such special determination being then deemed to have existed under this determination. If a project requires these, or any classification not listed, please contact IDOL at 618/993-7271 for wage rates or clarifications.

LANDSCAPING

Landscaping work falls under the existing classifications for laborer, operating engineer and truck driver. The work performed by landscape plantsman and landscape laborer is covered by the existing classification of laborer. The work performed by landscape operators (regardless of equipment used or its size) is covered by the classifications of operating engineer. The work performed by landscape truck drivers (regardless of size of truck driven) is covered by the classifications of truck driver.

# Douglas County Prevailing Wage for April 2007

Trade Name	RG	TYP	C	Base	FRMAN	*M-F>8	OSA	OSH	H/W	Pensn	Vac	Trng
=====	==	==	=	=====	=====	=====	==	==	=====	=====	=====	=====
ASBESTOS ABT-GEN		BLD		24.420	25.420	1.5	1.5	2.0	5.050	5.330	0.000	0.700
ASBESTOS ABT-MEC		BLD		20.190	0.000	1.5	1.5	2.0	5.000	3.400	0.000	0.000
BOILERMAKER		BLD		28.500	31.000	1.5	1.5	2.0	6.820	11.03	0.000	0.300
BRICK MASON		BLD		25.500	27.000	1.5	1.5	2.0	5.200	6.500	0.000	0.630
CARPENTER		HWY		27.740	29.490	1.5	1.5	2.0	6.500	4.600	0.000	0.300
CARPENTER	N	BLD		27.790	29.790	1.5	1.5	2.0	6.500	4.600	0.000	0.320
CARPENTER	S	BLD		25.590	27.590	1.5	1.5	2.0	6.500	6.800	0.000	0.320
CEMENT MASON		BLD		25.830	27.080	1.5	1.5	2.0	5.200	7.000	0.000	0.300
CEMENT MASON		HWY		24.170	25.170	1.5	1.5	2.0	5.200	7.000	0.000	0.300
CERAMIC TILE FNSHER		BLD		25.500	0.000	1.5	1.5	2.0	5.200	5.600	0.000	0.000
ELECTRIC PWR EQMT OP		ALL		30.750	0.000	1.5	1.5	2.0	4.750	8.610	0.000	0.000
ELECTRIC PWR GRNDMAN		ALL		21.090	0.000	1.5	1.5	2.0	4.750	5.905	0.000	0.000
ELECTRIC PWR LINEMAN		ALL		34.160	36.350	1.5	1.5	2.0	4.750	9.560	0.000	0.000
ELECTRIC PWR TRK DRV		ALL		22.130	0.000	1.5	1.5	2.0	4.750	6.200	0.000	0.000
ELECTRICIAN	N	BLD		32.010	34.010	1.5	1.5	2.0	5.150	5.410	0.000	0.480
ELECTRICIAN	S	BLD		29.480	32.420	1.5	1.5	2.0	5.150	5.300	0.000	0.440
ELECTRONIC SYS TECH		BLD		24.370	25.870	1.5	1.5	2.0	5.150	3.650	0.000	0.250
ELEVATOR CONSTRUCTOR		BLD		34.190	38.460	2.0	2.0	2.0	8.275	6.060	2.050	0.000
FENCE ERECTOR		ALL		26.420	28.170	1.5	1.5	2.0	6.590	6.150	0.000	0.500
GLAZIER		BLD		27.130	28.130	1.5	2.0	2.0	5.430	4.000	0.000	0.280
HT/FROST INSULATOR		BLD		28.470	0.000	1.5	1.5	2.0	5.040	5.800	0.000	0.130
IRON WORKER		ALL		26.420	28.170	1.5	1.5	2.0	6.590	6.150	0.000	0.500
LABORER		BLD		22.920	23.920	1.5	1.5	2.0	5.050	5.330	0.000	0.600
LABORER		HWY		24.220	24.970	1.5	1.5	2.0	5.050	5.330	0.000	0.600
LATHER	N	BLD		27.790	29.790	1.5	1.5	2.0	6.500	4.600	0.000	0.320
LATHER	S	BLD		25.590	27.590	1.5	1.5	2.0	6.500	6.800	0.000	0.320
MACHINIST		BLD		36.890	38.890	2.0	2.0	2.0	4.380	5.650	2.550	0.000
MARBLE FINISHERS		BLD		25.500	0.000	1.5	1.5	2.0	5.200	5.600	0.000	0.000
MARBLE MASON		BLD		27.000	0.000	1.5	1.5	2.0	5.200	5.600	0.000	0.000
MILLWRIGHT		BLD		26.000	28.000	1.5	1.5	2.0	6.500	6.850	0.000	0.320
MILLWRIGHT		HWY		19.410	20.660	1.5	1.5	2.0	2.800	3.000	0.000	0.000
OPERATING ENGINEER		ALL	1	28.650	0.000	1.5	1.5	2.0	5.200	6.750	0.000	0.650
OPERATING ENGINEER		ALL	2	18.600	0.000	1.5	1.5	2.0	5.200	6.750	0.000	0.650
PAINTER		ALL		28.450	29.800	1.5	1.5	2.0	5.200	3.300	0.000	0.320
PAINTER SIGNS		ALL		28.450	29.800	1.5	1.5	2.0	5.200	3.300	0.000	0.320
PILEDRIIVER		HWY		28.240	29.990	1.5	1.5	2.0	6.500	4.600	0.000	0.300
PILEDRIIVER	N	BLD		28.290	30.290	1.5	1.5	2.0	6.500	4.600	0.000	0.320
PILEDRIIVER	S	BLD		26.090	28.090	1.5	1.5	2.0	6.500	6.800	0.000	0.320
PIPEFITTER		ALL		28.850	31.010	1.5	1.5	2.0	5.450	4.750	0.000	0.510
PLASTERER		BLD		23.940	25.440	1.5	1.5	2.0	5.200	8.200	0.000	0.300
PLUMBER		ALL		28.850	31.010	1.5	1.5	2.0	5.450	4.750	0.000	0.510
ROOFER		BLD		25.460	26.460	1.5	1.5	2.0	6.350	5.150	0.000	0.200
SHEETMETAL WORKER		BLD		28.600	30.600	1.5	1.5	2.0	7.150	7.330	0.000	0.520
SPRINKLER FITTER		BLD		31.240	33.240	1.5	1.5	2.0	6.500	5.350	0.000	0.250
STONE MASON		BLD		25.500	27.000	1.5	1.5	2.0	5.200	6.500	0.000	0.630
TERRAZZO FINISHER		BLD		25.500	0.000	1.5	1.5	2.0	5.200	5.600	0.000	0.000
TERRAZZO MASON		BLD		27.000	0.000	1.5	1.5	2.0	5.200	5.600	0.000	0.000
TILE LAYER		BLD		25.590	27.590	1.5	1.5	2.0	6.500	6.800	0.000	0.320
TILE MASON		BLD		27.000	0.000	1.5	1.5	2.0	5.200	5.600	0.000	0.000
TRUCK DRIVER		ALL	1	25.787	0.000	1.5	1.5	2.0	7.250	3.317	0.000	0.000
TRUCK DRIVER		ALL	2	26.187	0.000	1.5	1.5	2.0	7.250	3.317	0.000	0.000
TRUCK DRIVER		ALL	3	26.387	0.000	1.5	1.5	2.0	7.250	3.317	0.000	0.000
TRUCK DRIVER		ALL	4	26.637	0.000	1.5	1.5	2.0	7.250	3.317	0.000	0.000
TRUCK DRIVER		ALL	5	27.387	0.000	1.5	1.5	2.0	7.250	3.317	0.000	0.000
TRUCK DRIVER		O&C	1	20.630	0.000	1.5	1.5	2.0	7.250	3.317	0.000	0.000
TRUCK DRIVER		O&C	2	20.950	0.000	1.5	1.5	2.0	7.250	3.317	0.000	0.000
TRUCK DRIVER		O&C	3	21.110	0.000	1.5	1.5	2.0	7.250	3.317	0.000	0.000
TRUCK DRIVER		O&C	4	21.310	0.000	1.5	1.5	2.0	7.250	3.317	0.000	0.000

TRUCK DRIVER	O&C 5	21.910	0.000	1.5	1.5	2.0	7.250	3.317	0.000	0.000
TUCKPOINTER	BLD	25.500	27.000	1.5	1.5	2.0	5.200	6.500	0.000	0.630

Legend:

M-F>8 (Overtime is required for any hour greater than 8 worked each day, Monday through Friday).

OSA (Overtime is required for every hour worked on Saturday)

OSH (Overtime is required for every hour worked on Sunday and Holidays)

H/W (Health & Welfare Insurance)

Pensn (Pension)

Vac (Vacation)

Trng (Training)

## Explanations

DOUGLAS COUNTY

CARPENTERS (SOUTH) - That part of the county South of Rt. 36 (Includes LATHERS & PILEDRIVERS).

ELECTRICIAN (NORTH) - Townships of Newman, Murdock, Camargo, and East of the central tracks including all of the Town of Tuscola.

The following list is considered as those days for which holiday rates of wages for work performed apply: New Years Day, Memorial/Decoration Day, Fourth of July, Labor Day, Veterans Day, Thanksgiving Day, Christmas Day. Generally, any of these holidays which fall on a Sunday is celebrated on the following Monday. This then makes work performed on that Monday payable at the appropriate overtime rate for holiday pay. Common practice in a given local may alter certain days of celebration such as the day after Thanksgiving for Veterans Day. If in doubt, please check with IDOL.

Oil and chip resealing (O&C) means the application of road oils and liquid asphalt to coat an existing road surface, followed by application of aggregate chips or gravel to coated surface, and subsequent rolling of material to seal the surface.

### EXPLANATION OF CLASSES

ASBESTOS - GENERAL - removal of asbestos material/mold and hazardous materials from any place in a building, including mechanical systems where those mechanical systems are to be removed. This includes the removal of asbestos materials/mold and hazardous materials from ductwork or pipes in a building when the building is to be demolished at the time or at some close future date.

ASBESTOS - MECHANICAL - removal of asbestos material from mechanical systems, such as pipes, ducts, and boilers, where the mechanical systems are to remain.

CERAMIC TILE FINISHER, MARBLE FINISHER, TERRAZZO FINISHER

Assisting, helping or supporting the tile, marble and terrazzo mechanic by performing their historic and traditional work assignments required to complete the proper installation of the work covered by said crafts. The term "Ceramic" is used for naming the classification only and is in no way a limitation of the product handled. Ceramic takes into consideration most hard tiles.

#### ELECTRONIC SYSTEMS TECHNICIAN

Installation, service and maintenance of low-voltage systems which utilizes the transmission and/or transference of voice, sound, vision, or digital for commercial, education, security and entertainment purposes for the following: TV monitoring and surveillance, background/foreground music, intercom and telephone interconnect, field programming, inventory control systems, microwave transmission, multi-media, multiplex, radio page, school, intercom and sound burglar alarms and low voltage master clock systems.

Excluded from this classification are energy management systems, life safety systems, supervisory controls and data acquisition systems not intrinsic with the above listed systems, fire alarm systems, nurse call systems and raceways exceeding fifteen feet in length.

#### TRUCK DRIVER - BUILDING, HEAVY AND HIGHWAY CONSTRUCTION

Class 1. Drivers on 2 axle trucks hauling less than 9 ton. Air compressor and welding machines and brooms, including those pulled by separate units, truck driver helpers, warehouse employees, mechanic helpers, greasers and tiremen, pickup trucks when hauling materials, tools, or workers to and from and on-the-job site, and fork lifts up to 6,000 lb. capacity.

Class 2. Two or three axle trucks hauling more than 9 ton but hauling less than 16 ton. A-frame winch trucks, hydrolift trucks, vector trucks or similar equipment when used for transportation purposes. Fork lifts over 6,000 lb. capacity, winch trucks, four axle combination units, and ticket writers.

Class 3. Two, three or four axle trucks hauling 16 ton or more. Drivers on water pulls, articulated dump trucks, mechanics and working forepersons, and dispatchers. Five axle or more combination units.

Class 4. Low Boy and Oil Distributors.

Class 5. Drivers who require special protective clothing while employed on hazardous waste work.

#### TRUCK DRIVER - OIL AND CHIP RESEALING ONLY.

This shall encompass laborers, workers and mechanics who drive contractor or subcontractor owned, leased, or hired pickup, dump, service, or oil distributor trucks. The work includes transporting materials and equipment (including but not limited to, oils, aggregate supplies, parts, machinery and tools) to or from the job site; distributing oil or liquid asphalt and aggregate; stock piling material when in connection with the actual oil and chip contract. The Truck Driver (Oil & Chip Resealing) wage classification does not include supplier delivered materials.

#### OPERATING ENGINEERS - BUILDING, HEAVY AND HIGHWAY CONSTRUCTION

Class 1. Power Cranes, Draglines, Derricks, Shovels, Gradalls, Mechanics, Tractor Highlift, Tournadozer, Concrete Mixers with Skip,



Tournamixer, Two Drum Machine, One Drum Hoist with Tower or Boom, Cableways, Tower Machines, Motor Patrol, Boom Tractor, Boom or Winch Truck, Winch or Hydraulic Boom Truck, Truck Crane, Tournapull, Tractor Operating Scoops, Bulldozer, Push Tractor, Asphalt Planer, Finishing Machine on Asphalt, Large Rollers on Earth, Rollers on Asphalt Mix, Ross Carrier or similar Machine, Gravel Processing Machine, Asphalt Plant Engineer, Paver Operator, Dredging Equipment, or Dredge Engineer, or Dredge Operator, Central Mix Plant Engineer, CMI or similar type machine, Concrete Pump, Truck or Skid Mounted, Tower Crane, Engineer or Rock Crusher Plant, Concrete Plant Engineer, Ditching Machine with dual attachment, Tractor Mounted Loaders, Cherry Picker, Hydro Crane, Standard or Dinkey Locomotives, Scoopmobiles, Euclid Loader, Soil Cement Machine, Back Filler, Elevating Machine, Power Blade, Drilling Machine, including Well Testing, Caissons, Shaft or any similar type drilling machines, Motor Driven Paint Machine, Pipe Cleaning Machine, Pipe Wrapping Machine, Pipe Bending Machine, Apsco Paver, Boring Machine, (Head Equipment Greaser), Barber-Greene Loaders, Formless Paver, (Well Point System), Concrete Spreader, Hydra Ax, Span Saw, Marine Scoops, Brush Mulcher, Brush Burner, Mesh Placer, Tree Mover, Helicopter Crew (3), Piledriver-Skid or Crawler, Stump Remover, Root Rake, Tug Boat Operator, Refrigerating Machine, Freezing Operator, Chair Cart-Self-Propelled, Hydra Seeder, Straw Blower, Power Sub Grader, Bull Float, Finishing Machine, Self-Propelled Pavement Breaker, Lull (or similar type Machine), Two Air Compressors, Compressors hooked in Manifold, Overhead Crane, Chip Spreader, Mud Cat, Sull-Air, Fork Lifts (except when used for landscaping work), Soil Stabilizer (Seaman Tiller, Bo Mag, Rago Gator, and similar types of equipment), Tube Float, Spray Machine, Curing Machine, Concrete or Asphalt Milling Machine, Snooper Truck-Operator, Backhoe, Farm Tractors (with attachments), 4 Point Lift System (Power Lift or similar type), Skid-Steer (Bob Cat or similar type), Wrecking Shears, Water Blaster.

Class 2. Concrete Mixers without Skips, Rock Crusher, Ditching Machine under 6', Curbing Machine, One Drum Machines without Tower or Boom, Air Tugger, Self-Propelled Concrete Saw, Machine Mounted Post Hole Digger, two to four Generators, Water Pumps or Welding Machines, within 400 feet, Air Compressor 600 cu. ft. and under, Rollers on Aggregate and Seal Coat Surfaces, Fork Lift (when used for landscaping work), Concrete and Blacktop Curb Machine, One Water Pump, Oilers, Air Valves or Steam Valves, One Welding Machine, Truck Jack, Mud Jack, Gunnite Machine, House Elevators when used for hoisting material, Engine Tenders, Fireman, Wagon Drill, Flex Plane, Conveyor, Siphons and Pulsometer, Switchman, Fireman on Paint Pots, Fireman on Asphalt Plants, Distributor Operator on Trucks, Tampers, Self-Propelled Power Broom, Striping Machine (motor driven), Form Tamper, Bulk Cement Plant, Equipment Greaser, Deck Hands, Truck Crane Oiler-Driver, Cement Blimps, Form Grader, Temporary Heat, Throttle Valve, Super Sucker (and similar type of equipment).

#### Other Classifications of Work:

For definitions of classifications not otherwise set out, the Department generally has on file such definitions which are available. If a task to be performed is not subject to one of the classifications of pay set out, the Department will upon being contacted state which neighboring county has such a classification and provide such rate, such rate being deemed to exist by reference in this document. If no neighboring county rate applies to the task, the Department shall undertake a special determination, such special determination being then deemed to have existed under this determination. If a project requires these, or any classification not listed, please contact IDOL at 618/993-7271 for wage rates or

clarifications.

#### LANDSCAPING

Landscaping work falls under the existing classifications for laborer, operating engineer and truck driver. The work performed by landscape plantsman and landscape laborer is covered by the existing classification of laborer. The work performed by landscape operators (regardless of equipment used or its size) is covered by the classifications of operating engineer. The work performed by landscape truck drivers (regardless of size of truck driven) is covered by the classifications of truck driver.

# Du Page County Prevailing Wage for April 2007

Trade Name	RG	TYP	C	Base	FRMAN	*M-F>8	OSA	OSH	H/W	Pensn	Vac	Trng
=====	==	==	=	=====	=====	=====	==	==	=====	=====	=====	=====
ASBESTOS ABT-GEN		ALL		31.550	32.300	1.5	1.5	2.0	7.460	4.840	0.000	0.170
ASBESTOS ABT-MEC		BLD		23.300	24.800	1.5	1.5	2.0	7.860	4.910	0.000	0.000
BOILERMAKER		BLD		38.540	42.000	2.0	2.0	2.0	6.720	7.440	0.000	0.300
BRICK MASON		BLD		34.850	38.340	1.5	1.5	2.0	7.050	7.870	0.000	0.380
CARPENTER		ALL		36.520	38.520	1.5	1.5	2.0	7.960	5.910	0.000	0.490
CEMENT MASON		ALL		33.650	35.650	2.0	1.5	2.0	6.550	10.45	0.000	0.180
CERAMIC TILE FNSHER		BLD		28.520	0.000	2.0	1.5	2.0	5.650	5.750	0.000	0.330
COMMUNICATION TECH		BLD		29.200	31.300	1.5	1.5	2.0	7.000	9.790	0.000	0.440
ELECTRIC PWR EQMT OP		ALL		27.920	35.880	1.5	1.5	2.0	4.750	7.820	0.000	0.210
ELECTRIC PWR GRNDMAN		ALL		21.640	35.880	1.5	1.5	2.0	4.750	6.060	0.000	0.160
ELECTRIC PWR LINEMAN		ALL		33.220	35.880	1.5	1.5	2.0	4.750	9.310	0.000	0.250
ELECTRIC PWR TRK DRV		ALL		22.340	35.880	1.5	1.5	2.0	4.750	6.260	0.000	0.170
ELECTRICIAN		BLD		32.750	36.030	1.5	1.5	2.0	8.300	12.15	3.600	0.490
ELEVATOR CONSTRUCTOR		BLD		42.045	47.300	2.0	2.0	2.0	8.275	6.060	2.520	0.550
FENCE ERECTOR	NE	ALL		27.140	28.640	1.5	1.5	2.0	7.500	7.590	0.000	0.250
FENCE ERECTOR	W	ALL		34.100	35.810	2.0	2.0	2.0	7.690	13.11	0.000	0.230
GLAZIER		BLD		31.400	32.400	1.5	2.0	2.0	6.490	9.050	0.000	0.500
HT/FROST INSULATOR		BLD		33.300	35.050	1.5	1.5	2.0	7.860	8.610	0.000	0.310
IRON WORKER	E	ALL		38.250	40.250	2.0	2.0	2.0	9.470	11.27	0.000	0.300
IRON WORKER	W	ALL		34.100	35.810	2.0	2.0	2.0	7.690	13.11	0.000	0.230
LABORER		ALL		31.550	32.300	1.5	1.5	2.0	7.460	4.840	0.000	0.170
LATHER		BLD		36.520	38.520	1.5	1.5	2.0	7.960	5.910	0.000	0.490
MACHINIST		BLD		36.890	38.890	2.0	2.0	2.0	4.380	5.650	2.550	0.000
MARBLE FINISHERS		ALL		25.750	0.000	1.5	1.5	2.0	6.070	7.020	0.000	0.580
MARBLE MASON		BLD		34.850	38.340	1.5	1.5	2.0	7.050	7.870	0.000	0.490
MATERIAL TESTER 1		ALL		21.550	0.000	1.5	1.5	2.0	7.460	4.840	0.000	0.170
MATERIALS TESTER II		ALL		26.550	0.000	1.5	1.5	2.0	7.460	4.840	0.000	0.170
MILLWRIGHT		ALL		36.520	38.520	1.5	1.5	2.0	7.960	5.910	0.000	0.490
OPERATING ENGINEER		BLD	1	41.550	45.550	2.0	2.0	2.0	6.850	5.600	1.900	0.700
OPERATING ENGINEER		BLD	2	40.250	45.550	2.0	2.0	2.0	6.850	5.600	1.900	0.700
OPERATING ENGINEER		BLD	3	37.700	45.550	2.0	2.0	2.0	6.850	5.600	1.900	0.700
OPERATING ENGINEER		BLD	4	35.950	45.550	2.0	2.0	2.0	6.850	5.600	1.900	0.700
OPERATING ENGINEER		HWY	1	39.750	43.750	1.5	1.5	2.0	6.850	5.600	1.900	0.700
OPERATING ENGINEER		HWY	2	39.200	43.750	1.5	1.5	2.0	6.850	5.600	1.900	0.700
OPERATING ENGINEER		HWY	3	37.150	43.750	1.5	1.5	2.0	6.850	5.600	1.900	0.700
OPERATING ENGINEER		HWY	4	35.750	43.750	1.5	1.5	2.0	6.850	5.600	1.900	0.700
OPERATING ENGINEER		HWY	5	34.550	43.750	1.5	1.5	2.0	6.850	5.600	1.900	0.700
ORNAMNTL IRON WORKER E	E	ALL		35.600	37.600	2.0	2.0	2.0	7.500	10.84	0.000	0.750
ORNAMNTL IRON WORKER W	W	ALL		34.100	35.810	2.0	2.0	2.0	7.690	13.11	0.000	0.230
PAINTER		ALL		34.380	35.380	1.5	1.5	1.5	5.650	5.750	0.000	0.350
PAINTER SIGNS		BLD		28.970	32.520	1.5	1.5	1.5	2.600	2.310	0.000	0.000
PILEDRIVER		ALL		36.520	38.520	1.5	1.5	2.0	7.960	5.910	0.000	0.490
PIPEFITTER		BLD		36.010	38.010	1.5	1.5	2.0	8.450	8.690	0.000	0.950
PLASTERER		BLD		32.000	33.500	1.5	1.5	2.0	6.450	6.770	0.000	0.570
PLUMBER		BLD		36.010	38.010	1.5	1.5	2.0	8.450	8.690	0.000	0.950
ROOFER		BLD		33.650	35.650	1.5	1.5	2.0	6.460	3.310	0.000	0.330
SHEETMETAL WORKER		BLD		36.510	38.510	1.5	1.5	2.0	6.890	8.020	0.000	0.640
SPRINKLER FITTER		BLD		38.500	40.500	1.5	1.5	2.0	8.250	6.100	0.000	0.500
STEEL ERECTOR	E	ALL		36.250	37.750	2.0	2.0	2.0	8.970	10.77	0.000	0.300
STEEL ERECTOR	W	ALL		34.100	35.810	2.0	2.0	2.0	7.690	13.11	0.000	0.230
STONE MASON		BLD		33.250	36.580	1.5	1.5	2.0	6.450	7.020	0.000	0.440
TERRAZZO FINISHER		BLD		29.290	0.000	1.5	1.5	2.0	5.650	6.940	0.000	0.270
TERRAZZO MASON		BLD		33.650	36.650	1.5	1.5	2.0	5.650	8.610	0.000	0.300
TILE MASON		BLD		34.600	38.600	2.0	1.5	2.0	5.650	7.000	0.000	0.460
TRAFFIC SAFETY WRKR		HWY		22.800	24.400	1.5	1.5	2.0	3.078	1.875	0.000	0.000
TRUCK DRIVER		ALL	1	29.700	30.250	1.5	1.5	2.0	6.500	3.450	0.000	0.000
TRUCK DRIVER		ALL	2	29.850	30.250	1.5	1.5	2.0	6.500	3.450	0.000	0.000
TRUCK DRIVER		ALL	3	30.050	30.250	1.5	1.5	2.0	6.500	3.450	0.000	0.000

TRUCK DRIVER	ALL	4	30.250	30.250	1.5	1.5	2.0	6.500	3.450	0.000	0.000
TUCKPOINTER	BLD		34.500	35.500	1.5	1.5	2.0	4.710	6.340	0.000	0.400

Legend:

M-F>8 (Overtime is required for any hour greater than 8 worked each day, Monday through Friday.)

OSA (Overtime is required for every hour worked on Saturday)

OSH (Overtime is required for every hour worked on Sunday and Holidays)

H/W (Health & Welfare Insurance)

Pensn (Pension)

Vac (Vacation)

Trng (Training)

## Explanations

DUPAGE COUNTY

IRON WORKERS AND FENCE ERECTOR (WEST) - West of Route 53.

The following list is considered as those days for which holiday rates of wages for work performed apply: New Years Day, Memorial/Decoration Day, Fourth of July, Labor Day, Veterans Day, Thanksgiving Day, Christmas Day. Generally, any of these holidays which fall on a Sunday is celebrated on the following Monday. This then makes work performed on that Monday payable at the appropriate overtime rate for holiday pay. Common practice in a given local may alter certain days of celebration such as the day after Thanksgiving for Veterans Day. If in doubt, please check with IDOL.

### EXPLANATION OF CLASSES

ASBESTOS - GENERAL - removal of asbestos material/mold and hazardous materials from any place in a building, including mechanical systems where those mechanical systems are to be removed. This includes the removal of asbestos materials/mold and hazardous materials from ductwork or pipes in a building when the building is to be demolished at the time or at some close future date.

ASBESTOS - MECHANICAL - removal of asbestos material from mechanical systems, such as pipes, ducts, and boilers, where the mechanical systems are to remain.

TRAFFIC SAFETY - work associated with barricades, horses and drums used to reduce lane usage on highway work, the installation and removal of temporary lane markings, and the installation and removal of temporary road signs.

### CERAMIC TILE FINISHER

The grouting, cleaning, and polishing of all classes of tile, whether for interior or exterior purposes, all burned, glazed or unglazed products; all composition materials, granite tiles, warning detectable tiles, cement tiles, epoxy composite materials, pavers, glass, mosaics, fiberglass, and all substitute materials, for tile made in

tile-like units; all mixtures in tile like form of cement, metals, and other materials that are for and intended for use as a finished floor surface, stair treads, promenade roofs, walks, walls, ceilings, swimming pools, and all other places where tile is to form a finished interior or exterior. The mixing of all setting mortars including but not limited to thin-set mortars, epoxies, wall mud, and any other sand and cement mixtures or adhesives when used in the preparation, installation, repair, or maintenance of tile and/or similar materials. The handling and unloading of all sand, cement, lime, tile, fixtures, equipment, adhesives, or any other materials to be used in the preparation, installation, repair, or maintenance of tile and/or similar materials. Ceramic Tile Finishers shall fill all joints and voids regardless of method on all tile work, particularly and especially after installation of said tile work. Application of any and all protective coverings to all types of tile installations including, but not be limited to, all soap compounds, paper products, tapes, and all polyethylene coverings, plywood, masonite, cardboard, and any new type of products that may be used to protect tile installations, Blastrac equipment, and all floor scarifying equipment used in preparing floors to receive tile. The clean up and removal of all waste and materials. All demolition of existing tile floors and walls to be re-tiled.

#### COMMUNICATIONS TECHNICIAN

Low voltage installation, maintenance and removal of telecommunication facilities (voice, sound, data and video) including telephone and data inside wire, interconnect, terminal equipment, central offices, PABX, fiber optic cable and equipment, micro waves, V-SAT, bypass, CATV, WAN (wide area networks), LAN (local area networks), and ISDN (integrated system digital network), pulling of wire in raceways, but not the installation of raceways.

#### MARBLE FINISHER

Loading and unloading trucks, distribution of all materials (all stone, sand, etc.), stocking of floors with material, performing all rigging for heavy work, the handling of all material that may be needed for the installation of such materials, building of scaffolding, polishing if needed, patching, waxing of material if damaged, pointing up, caulking, grouting and cleaning of marble, holding water on diamond or Carborundum blade or saw for setters cutting, use of tub saw or any other saw needed for preparation of material, drilling of holes for wires that anchor material set by setters, mixing up of molding plaster for installation of material, mixing up thin set for the installation of material, mixing up of sand to cement for the installation of material and such other work as may be required in helping a Marble Setter in the handling of all material in the erection or installation of interior marble, slate, travertine, art marble, serpentine, alberene stone, blue stone, granite and other stones (meaning as to stone any foreign or domestic materials as are specified and used in building interiors and exteriors and customarily known as stone in the trade), carrara, sanionyx, vitrolite and similar opaque glass and the laying of all marble tile, terrazzo tile, slate tile and precast tile, steps, risers treads, base, or any other materials that may be used as substitutes for any of the aforementioned materials and which are used on interior and exterior which sare installed in a similar manner.

MATERIAL TESTER I: Hand coring and drilling for testing of materials; field inspection of uncured concrete and asphalt.

MATERIAL TESTER II: Field inspection of welds, structural steel,

fireproofing, masonry, soil, facade, reinforcing steel, formwork, cured concrete, and concrete and asphalt batch plants; adjusting proportions of bituminous mixtures.

#### TRUCK DRIVER - BUILDING, HEAVY AND HIGHWAY CONSTRUCTION

Class 1. Two or three Axle Trucks. A-frame Truck when used for transportation purposes; Air Compressors and Welding Machines, including those pulled by cars, pick-up trucks and tractors; Ambulances; Batch Gate Lockers; Batch Hopperman; Car and Truck Washers; Carry-alls; Fork Lifts and Hoisters; Helpers; Mechanics Helpers and Greasers; Oil Distributors 2-man operation; Pavement Breakers; Pole Trailer, up to 40 feet; Power Mower Tractors; Self-propelled Chip Spreader; Skipman; Slurry Trucks, 2-man operation; Slurry Truck Conveyor Operation, 2 or 3 man; Teamsters Unskilled dumpman; and Truck Drivers hauling warning lights, barricades, and portable toilets on the job site.

Class 2. Four axle trucks; Dump Crets and Adgetors under 7 yards; Dumpsters, Track Trucks, Euclids, Hug Bottom Dump Turnapulls or Turnatrailers when pulling other than self-loading equipment or similar equipment under 16 cubic yards; Mixer Trucks under 7 yards; Ready-mix Plant Hopper Operator, and Winch Trucks, 2 Axles.

Class 3. Five axle trucks; Dump Crets and Adgetors 7 yards and over; Dumpsters, Track Trucks, Euclids, Hug Bottom Dump Turnatrailers or turnapulls when pulling other than self-loading equipment or similar equipment over 16 cubic yards; Explosives and/or Fission Material Trucks; Mixer Trucks 7 yards or over; Mobile Cranes while in transit; Oil Distributors, 1-man operation; Pole Trailer, over 40 feet; Pole and Expandable Trailers hauling material over 50 feet long; Slurry trucks, 1-man operation; Winch trucks, 3 axles or more; Mechanic--Truck Welder and Truck Painter.

Class 4. Six axle trucks; Dual-purpose vehicles, such as mounted crane trucks with hoist and accessories; Foreman; Master Mechanic; Self-loading equipment like P.B. and trucks with scoops on the front.

#### OPERATING ENGINEERS - BUILDING

Class 1. Mechanic; Asphalt Plant; Asphalt Spreader; Autograde; Backhoes with Caisson attachment; Batch Plant; Benoto; Boiler and Throttle Valve; Caisson Rigs; Central Redi-Mix Plant; Combination Back Hoe Front End-loader Machine; Compressor and Throttle Valve; Concrete Breaker (Truck Mounted); Concrete Conveyor; Concrete Paver; Concrete Placer; Concrete Placing Boom; Concrete Pump (Truck Mounted); Concrete Tower; Cranes, All; Cranes, Hammerhead; Cranes, (GCI and similar Type); Creter Crane; Crusher, Stone, etc.; Derricks, All; Derricks, Traveling; Formless Curb and Gutter Machine; Grader, Elevating; Grouting Machines; Highlift Shovels or Front Endloader 2-1/4 yd. and over; Hoists, Elevators, outside type rack and pinion and similar machines; Hoists, one, two and three Drum; Hoists, Two Tugger One Floor; Hydraulic Backhoes; Hydraulic Boom Trucks; Hydro Vac (and similar equipment); Locomotives, All; Motor Patrol; Pile Drivers and Skid Rig; Post Hole Digger; Pre-Stress Machine; Pump Cretes Dual Ram; Pump Cretes; Squeeze Cretes-screw Type Pumps; Raised and Blind Hole Drill; Roto Mill Grinder; Scoops - Tractor Drawn; Slip-form Paver; Straddle Buggies; Tournapull; Tractor with Boom and Side Boom; Trenching Machines.

Class 2. Boilers; Broom, All Power Propelled; Bulldozers; Concrete Mixer (Two Bag and Over); Conveyor, Portable; Fortlist Trucks; Greaser Engineer; Highlift Shovels or Front Endloaders under 2-1/4

yd.; Hoists, Automatic; Hoists, inside Freight Elevators; Hoists, Sewer Dragging Machine; Hoists, Tugger Single Drum; Laser Screed; Rock Drill (self-propelled); Rock Drill (truck mounted); Rollers, All; Steam Generators; Tractors, All; Tractor Drawn Vibratory Roller; Winch Trucks with "A" Frame.

Class 3. Air Compressor; Combination - Small Equipment Operator; Generators; Heaters, Mechanical; Hoists, Inside Elevators - (Rheostat Manual Controlled); Hydraulic Power Units (Pile Driving, Extracting, and Drilling); Pumps, over 3" (1 to 3 not to exceed a total of 300 ft.); Pumps, Well Points; Welding Machines (2 through 5); Winches, 4 small Electric Drill Winches; Bobcat (up to and including 3/4 cu. yd.).

Class 4. Bobcats and/or other Skid Steer Loaders; Oilers; and Brick Forklift.

#### OPERATING ENGINEERS - HEAVY AND HIGHWAY CONSTRUCTION

Class 1. Craft Foreman; Asphalt Plant; Asphalt Heater and Planer Combination; Asphalt Heater Scarfire; Asphalt Spreader; Autograder/GOMACO or other similar type machines; ABG Paver; Backhoes with Caisson attachment; Ballast Regulator; Belt Loader; Caisson Rigs; Car Dumper; Central Redi-Mix Plant; Combination Backhoe Front Endloader Machine, (1 cu. yd. Backhoe Bucket or over or with attachments); Concrete Breaker (Truck Mounted); Concrete Conveyor; Concrete Paver over 27E cu. ft.; Concrete Placer; Concrete Tube Float; Cranes, all attachments; Cranes, Hammerhead, Linden, Peco & Machines of a like nature; Crete Crane; Crusher, Stone, etc.; Derricks, All; Derrick Boats; Derricks, Traveling; Dowell machine with Air Compressor; Dredges; Field Mechanic-Welder; Formless Curb and Gutter Machine; Gradall and Machines of a like nature; Grader, Elevating; Grader, Motor Grader, Motor Patrol, Auto Patrol, Form Grader, Pull Grader, Subgrader; Guard Rail Post Driver Mounted; Hoists, One, Two and Three Drum; Hydraulic Backhoes; Backhoes with shear attachments; Mucking Machine; Pile Drivers and Skid Rig; Pre-Stress Machine; Pump Cretes Dual Ram; Rock Drill - Crawler or Skid Rig; Rock Drill - Truck Mounted; Roto Mill Grinder; Slip-Form Paver; Soil Test Drill Rig (Truck Mounted); Straddle Buggies; Hydraulic Telescoping Form (Tunnel); Tractor Drawn Belt Loader (with attached pusher - two engineers); Tractor with Boom; Tractaire with Attachments; Trenching Machine; Truck Mounted Concrete Pump with Boom; Raised or Blind Hole; Drills (Tunnel Shaft); Underground Boring and/or Mining Machines; Wheel Excavator; Widener (APSCO).

Class 2. Batch Plant; Bituminous Mixer; Boiler and Throttle Valve; Bulldozers; Car Loader Trailing Conveyors; Combination Backhoe Front Endloader Machine (less than 1 cu. yd. Backhoe Bucket or over or with attachments); Compressor and Throttle Valve; Compressor, Common Receiver (3); Concrete Breaker or Hydro Hammer; Concrete Grinding Machine; Concrete Mixer or Paver 7S Series to and including 27 cu. ft.; Concrete Spreader; Concrete Curing Machine, Burlap Machine, Belting Machine and Sealing Machine; Concrete Wheel Saw; Conveyor Muck Cars (Haglund or Similar Type); Drills, All; Finishing Machine - Concrete; Greaser Engineer; Highlift Shovels or Front Endloader; Hoist - Sewer Dragging Machine; Hydraulic Boom Trucks (All Attachments); Hydro-Blaster; All Locomotives, Dinky; Pump Cretes; Squeeze Cretes-Screw Type Pumps, Gypsum Bulker and Pump; Roller, Asphalt; Rotary Snow Plows; Rototiller, Seaman, etc., self-propelled; Scoops - Tractor Drawn; Self-Propelled Compactor; Spreader - Chip - Stone, etc.; Scraper; Scraper - Prime Mover in Tandem (Regardless of Size); Tank Car Heater; Tractors, Push, Pulling Sheeps Foot, Disc, Compactor, etc.; Tug Boats.

Class 3. Boilers; Brooms, All Power Propelled; Cement Supply Tender; Compressor, Common Receiver (2); Concrete Mixer (Two Bag and Over); Conveyor, Portable; Farm-Type Tractors Used for Mowing, Seeding, etc.; Fireman on Boilers; Forklift Trucks; Grouting Machine; Hoists, Automatic; Hoists, All Elevators; Hoists, Tugger Single Drum; Jeep Diggers; Pipe Jacking Machines; Post-Hole Digger; Power Saw, Concrete Power Driven; Pug Mills; Rollers, other than asphalt; Seed and Straw Blower; Steam Generators; Stump Machine; Winch Trucks with "A" Frame; Work Boats; Tamper - Form-Motor Driven.

Class 4. Air Compressor; Combination - Small Equipment Operator; Directional Boring Machine; Generators; Heaters, Mechanical; Hydraulic Power Unit (Pile Driving, Extracting, or Drilling); Hydro-Blaster; Light Plants, All (1 through 5); Pumps, over 3" (1 to 3 not to exceed a total of 300 ft.); Pumps, Well Points; Tractaire; Welding Machines (2 through 5); Winches, 4 Small Electric Drill Winches.

Class 5. Bobcats (all); Brick Forklifts, Oilers.

#### TERRAZZO FINISHER

The handling of sand, cement, marble chips, and all other materials that may be used by the Mosaic Terrazzo Mechanic, and the mixing, grinding, grouting, cleaning and sealing of all Marble, Mosaic, and Terrazzo work, floors, base, stairs, and wainscoting by hand or machine, and in addition, assisting and aiding Marble, Masonic, and Terrazzo Mechanics.

#### Other Classifications of Work:

For definitions of classifications not otherwise set out, the Department generally has on file such definitions which are available. If a task to be performed is not subject to one of the classifications of pay set out, the Department will upon being contacted state which neighboring county has such a classification and provide such rate, such rate being deemed to exist by reference in this document. If no neighboring county rate applies to the task, the Department shall undertake a special determination, such special determination being then deemed to have existed under this determination. If a project requires these, or any classification not listed, please contact IDOL at 618/993-7271 for wage rates or clarifications.

#### LANDSCAPING

Landscaping work falls under the existing classifications for laborer, operating engineer and truck driver. The work performed by landscape plantsman and landscape laborer is covered by the existing classification of laborer. The work performed by landscape operators (regardless of equipment used or its size) is covered by the classifications of operating engineer. The work performed by landscape truck drivers (regardless of size of truck driven) is covered by the classifications of truck driver.



# Edgar County Prevailing Wage for April 2007

Trade Name	RG	TYP	C	Base	FRMAN	*M-F>8	OSA	OSH	H/W	Pensn	Vac	Trng
=====	==	==	=	=====	=====	=====	==	==	=====	=====	=====	=====
ASBESTOS ABT-GEN		BLD		24.420	25.420	1.5	1.5	2.0	5.050	5.330	0.000	0.700
ASBESTOS ABT-MEC		BLD		20.190	0.000	1.5	1.5	2.0	5.000	3.400	0.000	0.000
BOILERMAKER		BLD		28.500	31.000	1.5	1.5	2.0	6.820	11.03	0.000	0.300
BRICK MASON		BLD		25.500	27.000	1.5	1.5	2.0	5.200	6.500	0.000	0.630
CARPENTER		BLD		27.790	29.790	1.5	1.5	2.0	6.500	4.600	0.000	0.320
CARPENTER		HWY		25.040	26.790	1.5	1.5	2.0	6.500	7.300	0.000	0.300
CEMENT MASON		BLD		25.830	27.080	1.5	1.5	2.0	5.200	7.000	0.000	0.300
CEMENT MASON		HWY		24.170	25.170	1.5	1.5	2.0	5.200	7.000	0.000	0.300
CERAMIC TILE FNSHER		BLD		25.500	0.000	1.5	1.5	2.0	5.200	5.600	0.000	0.000
COMM SYSTEMS TECH		BLD		23.350	25.700	1.5	1.5	2.0	5.150	4.310	0.000	0.000
ELECTRIC PWR EQMT OP		ALL		30.750	0.000	1.5	1.5	2.0	4.750	8.610	0.000	0.000
ELECTRIC PWR GRNDMAN		ALL		21.090	0.000	1.5	1.5	2.0	4.750	5.905	0.000	0.000
ELECTRIC PWR LINEMAN		ALL		34.160	36.350	1.5	1.5	2.0	4.750	9.560	0.000	0.000
ELECTRIC PWR TRK DRV		ALL		22.130	0.000	1.5	1.5	2.0	4.750	6.200	0.000	0.000
ELECTRICIAN		BLD		29.090	31.130	1.5	1.5	2.0	5.150	5.530	0.000	0.290
FENCE ERECTOR		ALL		24.450	25.750	1.5	1.5	2.0	6.000	8.000	0.000	0.390
GLAZIER		BLD		24.430	25.930	1.5	1.5	2.0	4.500	4.800	0.000	0.300
HT/FROST INSULATOR		BLD		28.470	0.000	1.5	1.5	2.0	5.040	5.800	0.000	0.130
IRON WORKER		ALL		24.450	25.750	1.5	1.5	2.0	6.000	8.000	0.000	0.390
LABORER		BLD		22.920	23.920	1.5	1.5	2.0	5.050	5.330	0.000	0.600
LABORER		HWY		24.220	24.970	1.5	1.5	2.0	5.050	5.330	0.000	0.600
LATHER		BLD		27.790	29.790	1.5	1.5	2.0	6.500	4.600	0.000	0.320
MACHINIST		BLD		36.890	38.890	2.0	2.0	2.0	4.380	5.650	2.550	0.000
MARBLE FINISHERS		BLD		25.500	0.000	1.5	1.5	2.0	5.200	5.600	0.000	0.000
MARBLE MASON		BLD		27.000	0.000	1.5	1.5	2.0	5.200	5.600	0.000	0.000
MILLWRIGHT		BLD		26.000	28.000	1.5	1.5	2.0	6.500	6.850	0.000	0.320
MILLWRIGHT		HWY		19.410	20.660	1.5	1.5	2.0	2.800	3.000	0.000	0.000
OPERATING ENGINEER		ALL	1	28.650	0.000	1.5	1.5	2.0	5.200	6.750	0.000	0.650
OPERATING ENGINEER		ALL	2	18.600	0.000	1.5	1.5	2.0	5.200	6.750	0.000	0.650
PAINTER		ALL		23.000	24.000	1.5	1.5	2.0	5.500	6.200	0.000	0.180
PILEDRIVER		BLD		28.290	30.290	1.5	1.5	2.0	6.500	4.600	0.000	0.320
PILEDRIVER		HWY		25.540	27.290	1.5	1.5	2.0	6.500	7.300	0.000	0.300
PIPEFITTER		ALL		28.850	31.010	1.5	1.5	2.0	5.450	4.750	0.000	0.510
PLASTERER		BLD		23.940	25.440	1.5	1.5	2.0	5.200	8.200	0.000	0.300
PLUMBER		ALL		28.850	31.010	1.5	1.5	2.0	5.450	4.750	0.000	0.510
ROOFER		BLD		25.460	26.460	1.5	1.5	2.0	6.350	5.150	0.000	0.200
SHEETMETAL WORKER		BLD		27.010	28.360	1.5	1.5	2.0	6.150	5.150	0.000	0.480
SPRINKLER FITTER		BLD		31.240	33.240	1.5	1.5	2.0	6.500	5.350	0.000	0.250
STONE MASON		BLD		25.500	27.000	1.5	1.5	2.0	5.200	6.500	0.000	0.630
TERRAZZO FINISHER		BLD		25.500	0.000	1.5	1.5	2.0	5.200	5.600	0.000	0.000
TERRAZZO MASON		BLD		27.000	0.000	1.5	1.5	2.0	5.200	5.600	0.000	0.000
TILE LAYER		BLD		27.790	29.790	1.5	1.5	2.0	6.500	4.600	0.000	0.320
TILE MASON		BLD		27.000	0.000	1.5	1.5	2.0	5.200	5.600	0.000	0.000
TRUCK DRIVER		ALL	1	25.010	0.000	1.5	1.5	2.0	6.500	2.225	0.000	0.000
TRUCK DRIVER		ALL	2	25.410	0.000	1.5	1.5	2.0	6.500	2.225	0.000	0.000
TRUCK DRIVER		ALL	3	25.610	0.000	1.5	1.5	2.0	6.500	2.225	0.000	0.000
TRUCK DRIVER		ALL	4	25.860	0.000	1.5	1.5	2.0	6.500	2.225	0.000	0.000
TRUCK DRIVER		ALL	5	26.610	0.000	1.5	1.5	2.0	6.500	2.225	0.000	0.000
TRUCK DRIVER		O&C	1	20.010	0.000	1.5	1.5	2.0	6.500	2.225	0.000	0.000
TRUCK DRIVER		O&C	2	20.330	0.000	1.5	1.5	2.0	6.500	2.225	0.000	0.000
TRUCK DRIVER		O&C	3	20.490	0.000	1.5	1.5	2.0	6.500	2.225	0.000	0.000
TRUCK DRIVER		O&C	4	20.690	0.000	1.5	1.5	2.0	6.500	2.225	0.000	0.000
TRUCK DRIVER		O&C	5	21.290	0.000	1.5	1.5	2.0	6.500	2.225	0.000	0.000
TUCKPOINTER		BLD		25.500	27.000	1.5	1.5	2.0	5.200	6.500	0.000	0.630

Legend :

M-F>8 (Overtime is required for any hour greater than 8 worked each day, Monday through Friday.)

OSA (Overtime is required for every hour worked on Saturday)

OSH (Overtime is required for every hour worked on Sunday and Holidays)

H/W (Health & Welfare Insurance)

Pensn (Pension)

Vac (Vacation)

Trng (Training)

## Explanations

### EDGAR COUNTY

The following list is considered as those days for which holiday rates of wages for work performed apply: New Years Day, Memorial/Decoration Day, Fourth of July, Labor Day, Veterans Day, Thanksgiving Day, Christmas Day. Generally, any of these holidays which fall on a Sunday is celebrated on the following Monday. This then makes work performed on that Monday payable at the appropriate overtime rate for holiday pay. Common practice in a given local may alter certain days of celebration such as the day after Thanksgiving for Veterans Day. If in doubt, please check with IDOL.

Oil and chip resealing (O&C) means the application of road oils and liquid asphalt to coat an existing road surface, followed by application of aggregate chips or gravel to coated surface, and subsequent rolling of material to seal the surface.

### EXPLANATION OF CLASSES

ASBESTOS - GENERAL - removal of asbestos material/mold and hazardous materials from any place in a building, including mechanical systems where those mechanical systems are to be removed. This includes the removal of asbestos materials/mold and hazardous materials from ductwork or pipes in a building when the building is to be demolished at the time or at some close future date.

ASBESTOS - MECHANICAL - removal of asbestos material from mechanical systems, such as pipes, ducts, and boilers, where the mechanical systems are to remain.

### CERAMIC TILE FINISHER, MARBLE FINISHER, TERRAZZO FINISHER

Assisting, helping or supporting the tile, marble and terrazzo mechanic by performing their historic and traditional work assignments required to complete the proper installation of the work covered by said crafts. The term "Ceramic" is used for naming the classification only and is in no way a limitation of the product handled. Ceramic takes into consideration most hard tiles.

### COMMUNICATIONS SYSTEM TECHNICIAN

Installation, operation, inspection, maintenance, repair, and service of radio, television, recording, voice sound and vision production and reproduction apparatus, equipment and appliances used for domestic, commercial, education, entertainment and private telephone systems.

TRUCK DRIVER - BUILDING, HEAVY AND HIGHWAY CONSTRUCTION

Class 1. Drivers on 2 axle trucks hauling less than 9 ton. Air compressor and welding machines and brooms, including those pulled by separate units, truck driver helpers, warehouse employees, mechanic helpers, greasers and tiremen, pickup trucks when hauling materials, tools, or workers to and from and on-the-job site, and fork lifts up to 6,000 lb. capacity.

Class 2. Two or three axle trucks hauling more than 9 ton but hauling less than 16 ton. A-frame winch trucks, hydrolift trucks, vector trucks or similar equipment when used for transportation purposes. Fork lifts over 6,000 lb. capacity, winch trucks, four axle combination units, and ticket writers.

Class 3. Two, three or four axle trucks hauling 16 ton or more. Drivers on water pulls, articulated dump trucks, mechanics and working forepersons, and dispatchers. Five axle or more combination units.

Class 4. Low Boy and Oil Distributors.

Class 5. Drivers who require special protective clothing while employed on hazardous waste work.

TRUCK DRIVER - OIL AND CHIP RESEALING ONLY.

This shall encompass laborers, workers and mechanics who drive contractor or subcontractor owned, leased, or hired pickup, dump, service, or oil distributor trucks. The work includes transporting materials and equipment (including but not limited to, oils, aggregate supplies, parts, machinery and tools) to or from the job site; distributing oil or liquid asphalt and aggregate; stock piling material when in connection with the actual oil and chip contract. The Truck Driver (Oil & Chip Resealing) wage classification does not include supplier delivered materials.

OPERATING ENGINEERS - BUILDING, HEAVY AND HIGHWAY CONSTRUCTION

Class 1. Power Cranes, Draglines, Derricks, Shovels, Gradalls, Mechanics, Tractor Highlift, Tournadozer, Concrete Mixers with Skip, Tournamixer, Two Drum Machine, One Drum Hoist with Tower or Boom, Cableways, Tower Machines, Motor Patrol, Boom Tractor, Boom or Winch Truck, Winch or Hydraulic Boom Truck, Truck Crane, Tournapull, Tractor Operating Scoops, Bulldozer, Push Tractor, Asphalt Planer, Finishing Machine on Asphalt, Large Rollers on Earth, Rollers on Asphalt Mix, Ross Carrier or similar Machine, Gravel Processing Machine, Asphalt Plant Engineer, Paver Operator, Dredging Equipment, or Dredge Engineer, or Dredge Operator, Central Mix Plant Engineer, CMI or similar type machine, Concrete Pump, Truck or Skid Mounted, Tower Crane, Engineer or Rock Crusher Plant, Concrete Plant Engineer, Ditching Machine with dual attachment, Tractor Mounted Loaders, Cherry Picker, Hydro Crane, Standard or Dinkey Locomotives, Scoopmobiles, Euclid Loader, Soil Cement Machine, Back Filler, Elevating Machine, Power Blade, Drilling Machine, including Well Testing, Caissons, Shaft or any similar type drilling machines, Motor Driven Paint Machine, Pipe Cleaning Machine, Pipe Wrapping Machine, Pipe Bending Machine, Apsco Paver, Boring Machine, (Head Equipment Greaser), Barber-Greene Loaders, Formless Paver, (Well Point System), Concrete Spreader, Hydra Ax, Span Saw, Marine Scoops, Brush Mulcher, Brush Burner, Mesh Placer, Tree Mover, Helicopter Crew (3), Piledriver-Skid or Crawler, Stump Remover, Root Rake, Tug Boat Operator, Refrigerating Machine, Freezing Operator, Chair Cart-Self-Propelled, Hydra Seeder, Straw Blower, Power Sub Grader, Bull

Float, Finishing Machine, Self-Propelled Pavement Breaker, Lull (or similar type Machine), Two Air Compressors, Compressors hooked in Manifold, Overhead Crane, Chip Spreader, Mud Cat, Sull-Air, Fork Lifts (except when used for landscaping work), Soil Stabilizer (Seaman Tiller, Bo Mag, Rago Gator, and similar types of equipment), Tube Float, Spray Machine, Curing Machine, Concrete or Asphalt Milling Machine, Snooper Truck-Operator, Backhoe, Farm Tractors (with attachments), 4 Point Lift System (Power Lift or similar type), Skid-Steer (Bob Cat or similar type), Wrecking Shears, Water Blaster.

Class 2. Concrete Mixers without Skips, Rock Crusher, Ditching Machine under 6', Curbing Machine, One Drum Machines without Tower or Boom, Air Tugger, Self-Propelled Concrete Saw, Machine Mounted Post Hole Digger, two to four Generators, Water Pumps or Welding Machines, within 400 feet, Air Compressor 600 cu. ft. and under, Rollers on Aggregate and Seal Coat Surfaces, Fork Lift (when used for landscaping work), Concrete and Blacktop Curb Machine, One Water Pump, Oilers, Air Valves or Steam Valves, One Welding Machine, Truck Jack, Mud Jack, Gunnite Machine, House Elevators when used for hoisting material, Engine Tenders, Fireman, Wagon Drill, Flex Plane, Conveyor, Siphons and Pulsometer, Switchman, Fireman on Paint Pots, Fireman on Asphalt Plants, Distributor Operator on Trucks, Tampers, Self-Propelled Power Broom, Striping Machine (motor driven), Form Tamper, Bulk Cement Plant, Equipment Greaser, Deck Hands, Truck Crane Oiler-Driver, Cement Blimps, Form Grader, Temporary Heat, Throttle Valve, Super Sucker (and similar type of equipment).

#### Other Classifications of Work:

For definitions of classifications not otherwise set out, the Department generally has on file such definitions which are available. If a task to be performed is not subject to one of the classifications of pay set out, the Department will upon being contacted state which neighboring county has such a classification and provide such rate, such rate being deemed to exist by reference in this document. If no neighboring county rate applies to the task, the Department shall undertake a special determination, such special determination being then deemed to have existed under this determination. If a project requires these, or any classification not listed, please contact IDOL at 618/993-7271 for wage rates or clarifications.

#### LANDSCAPING

Landscaping work falls under the existing classifications for laborer, operating engineer and truck driver. The work performed by landscape plantsman and landscape laborer is covered by the existing classification of laborer. The work performed by landscape operators (regardless of equipment used or its size) is covered by the classifications of operating engineer. The work performed by landscape truck drivers (regardless of size of truck driven) is covered by the classifications of truck driver.

# Edwards County Prevailing Wage for April 2007

Trade Name	RG	TYP	C	Base	FRMAN	*M-F>8	OSA	OSH	H/W	Pensn	Vac	Trng
ASBESTOS ABT-GEN		ALL		20.750	21.200	1.5	1.5	2.0	5.250	5.600	0.000	0.700
ASBESTOS ABT-MEC		BLD		20.800	0.000	2.0	2.0	2.0	5.000	3.400	0.000	0.000
BOILERMAKER		BLD		28.500	31.000	1.5	1.5	2.0	6.820	11.03	0.000	0.300
BRICK MASON		BLD		25.470	26.970	1.5	1.5	2.0	6.000	5.400	0.000	0.425
CARPENTER		BLD		27.780	29.280	1.5	1.5	2.0	5.050	3.750	0.000	0.350
CARPENTER		HWY		27.730	29.480	1.5	1.5	2.0	5.050	3.750	0.000	0.350
CEMENT MASON		BLD		23.500	24.500	1.5	1.5	2.0	5.200	3.550	0.000	0.100
CEMENT MASON		HWY		23.500	25.000	1.5	1.5	2.0	5.200	2.750	0.000	0.200
CERAMIC TILE FNSHER		BLD		24.990	0.000	1.5	1.5	2.0	6.000	5.400	0.000	0.425
ELECTRICIAN		ALL		32.910	35.160	1.5	1.5	2.0	5.150	6.580	0.000	0.490
ELECTRONIC SYS TECH		BLD		25.700	27.200	1.5	1.5	2.0	5.150	3.340	0.000	0.250
FLOOR LAYER		BLD		26.930	27.680	1.5	1.5	2.0	5.000	3.750	0.000	0.350
GLAZIER		BLD		22.930	0.000	1.5	1.5	2.0	4.320	3.800	0.000	0.300
HT/FROST INSULATOR		BLD		26.110	27.110	1.5	1.5	2.0	4.800	6.860	0.000	0.190
IRON WORKER		ALL		24.000	25.250	1.5	1.5	2.0	5.780	6.850	0.000	0.345
LABORER		BLD		20.750	21.200	1.5	1.5	2.0	5.250	5.600	0.000	0.600
LABORER		HWY		21.000	21.450	1.5	1.5	2.0	5.350	6.150	0.000	0.600
MACHINIST		BLD		36.890	38.890	2.0	2.0	2.0	4.380	5.650	2.550	0.000
MARBLE FINISHERS		BLD		24.990	0.000	1.5	1.5	2.0	6.000	5.400	0.000	0.425
MARBLE MASON		BLD		25.470	26.970	1.5	1.5	2.0	6.000	5.400	0.000	0.425
MILLWRIGHT		BLD		27.780	29.280	1.5	1.5	2.0	5.050	3.750	0.000	0.350
MILLWRIGHT		HWY		28.230	29.980	1.5	1.5	2.0	5.050	3.750	0.000	0.350
OPERATING ENGINEER		ALL	1	28.650	0.000	1.5	1.5	2.0	5.200	6.750	0.000	0.650
OPERATING ENGINEER		ALL	2	18.600	0.000	1.5	1.5	2.0	5.200	6.750	0.000	0.650
PAINTER		BLD		22.850	23.850	1.5	1.5	2.0	5.150	3.950	0.000	0.250
PAINTER		HWY		24.000	25.000	1.5	1.5	2.0	5.150	3.950	0.000	0.250
PAINTER OVER 30FT		BLD		23.600	24.600	1.5	1.5	2.0	5.150	3.950	0.000	0.250
PAINTER PWR EQMT		BLD		23.850	24.850	1.5	1.5	2.0	5.150	3.950	0.000	0.250
PAINTER PWR EQMT		HWY		25.000	26.000	1.5	1.5	2.0	5.150	3.950	0.000	0.250
PILEDRIVER		BLD		27.780	29.280	1.5	1.5	2.0	5.050	3.750	0.000	0.350
PILEDRIVER		HWY		28.230	29.980	1.5	1.5	2.0	5.050	3.750	0.000	0.350
PIPEFITTER		BLD		27.580	29.230	1.5	1.5	2.0	5.450	7.010	0.000	0.700
PLASTERER		BLD		23.500	24.500	1.5	1.5	2.0	5.200	3.550	0.000	0.100
PLUMBER		BLD		27.580	29.230	1.5	1.5	2.0	5.450	7.010	0.000	0.700
ROOFER		BLD		24.690	26.190	1.5	1.5	2.0	4.380	4.000	0.000	0.000
SHEETMETAL WORKER		ALL		27.210	28.460	1.5	1.5	2.0	6.000	4.770	1.630	0.120
SPRINKLER FITTER		BLD		31.240	33.240	1.5	1.5	2.0	6.500	5.350	0.000	0.250
STONE MASON		BLD		25.470	26.970	1.5	1.5	2.0	6.000	5.400	0.000	0.425
TERRAZZO FINISHER		BLD		24.990	0.000	1.5	1.5	2.0	6.000	5.400	0.000	0.425
TILE MASON		BLD		25.470	26.970	1.5	1.5	2.0	6.000	5.400	0.000	0.425
TRUCK DRIVER		ALL	1	25.010	0.000	1.5	1.5	2.0	6.500	2.225	0.000	0.000
TRUCK DRIVER		ALL	2	25.410	0.000	1.5	1.5	2.0	6.500	2.225	0.000	0.000
TRUCK DRIVER		ALL	3	25.610	0.000	1.5	1.5	2.0	6.500	2.225	0.000	0.000
TRUCK DRIVER		ALL	4	25.860	0.000	1.5	1.5	2.0	6.500	2.225	0.000	0.000
TRUCK DRIVER		ALL	5	26.610	0.000	1.5	1.5	2.0	6.500	2.225	0.000	0.000
TUCKPOINTS		BLD		25.470	26.970	1.5	1.5	2.0	6.000	5.400	0.000	0.425

Legend :

M-F>8 (Overtime is required for any hour greater than 8 worked each day, Monday through Friday.)

OSA (Overtime is required for every hour worked on Saturday)

OSH (Overtime is required for every hour worked on Sunday and Holidays)

H/W (Health & Welfare Insurance)

Pensn (Pension)

Vac (Vacation)

Trng (Training)

## Explanations

### EDWARDS COUNTY

The following list is considered as those days for which holiday rates of wages for work performed apply: New Years Day, Memorial/Decoration Day, Fourth of July, Labor Day, Veterans Day, Thanksgiving Day, Christmas Day. Generally, any of these holidays which fall on a Sunday is celebrated on the following Monday. This then makes work performed on that Monday payable at the appropriate overtime rate for holiday pay. Common practice in a given local may alter certain days of celebration such as the day after Thanksgiving for Veterans Day. If in doubt, please check with IDOL.

### EXPLANATION OF CLASSES

ASBESTOS - GENERAL - removal of asbestos material/mold and hazardous materials from any place in a building, including mechanical systems where those mechanical systems are to be removed. This includes the removal of asbestos materials/mold and hazardous materials from ductwork or pipes in a building when the building is to be demolished at the time or at some close future date.

ASBESTOS - MECHANICAL - removal of asbestos material from mechanical systems, such as pipes, ducts, and boilers, where the mechanical systems are to remain.

### CERAMIC TILE FINISHER, MARBLE FINISHER, TERRAZZO FINISHER

Assisting, helping or supporting the tile, marble and terrazzo mechanic by performing their historic and traditional work assignments required to complete the proper installation of the work covered by said crafts. The term "Ceramic" is used for naming the classification only, and is in no a limitation of the product handled. Ceramic takes into consideration most hard tiles.

### ELECTRONIC SYSTEMS TECHNICIAN

Installation, service and maintenance of low-voltage systems which utilizes the transmission and/or transference of voice, sound, vision, or digital for commercial, education, security and entertainment purposes for the following: TV monitoring and surveillance, background/foreground music, intercom and telephone interconnect, field programming, inventory control systems, microwave transmission, multi-media, multiplex, radio page, school, intercom and sound burglar alarms and low voltage master clock systems.

Excluded from this classification are energy management systems, life safety systems, supervisory controls and data acquisition systems not intrinsic with the above listed systems, fire alarm systems, nurse call systems and raceways exceeding fifteen feet in length.

### TRUCK DRIVER - BUILDING, HEAVY AND HIGHWAY CONSTRUCTION

Class 1. Drivers on 2 axle trucks hauling less than 9 ton. Air compressor and welding machines and brooms, including those pulled by separate units, truck driver helpers, warehouse employees, mechanic helpers, greasers and tiremen, pickup trucks when hauling materials, tools, or workers to and from and on-the-job site, and fork lifts up to 6,000 lb. capacity.

Class 2. Two or three axle trucks hauling more than 9 ton but hauling less than 16 ton. A-frame winch trucks, hydrolift trucks, vactor trucks or similar equipment when used for transportation purposes. Fork lifts over 6,000 lb. capacity, winch trucks, four axle combination units, and ticket writers.

Class 3. Two, three or four axle trucks hauling 16 ton or more. Drivers on water pulls, articulated dump trucks, mechanics and working forepersons, and dispatchers. Five axle or more combination units.

Class 4. Low Boy and Oil Distributors.

Class 5. Drivers who require special protective clothing while employed on hazardous waste work.

#### OPERATING ENGINEERS - BUILDING, HEAVY AND HIGHWAY CONSTRUCTION

Class 1. Power Cranes, Draglines, Derricks, Shovels, Gradalls, Mechanics, Tractor Highlift, Tournadozer, Concrete Mixers with Skip, Tournamixer, Two Drum Machine, One Drum Hoist with Tower or Boom, Cableways, Tower Machines, Motor Patrol, Boom Tractor, Boom or Winch Truck, Winch or Hydraulic Boom Truck, Truck Crane, Tournapull, Tractor Operating Scoops, Bulldozer, Push Tractor, Asphalt Planer, Finishing Machine on Asphalt, Large Rollers on Earth, Rollers on Asphalt Mix, Ross Carrier or similar Machine, Gravel Processing Machine, Asphalt Plant Engineer, Paver Operator, Dredging Equipment, or Dredge Engineer, or Dredge Operator, Central Mix Plant Engineer, CMI or similar type machine, Concrete Pump, Truck or Skid Mounted, Tower Crane, Engineer or Rock Crusher Plant, Concrete Plant Engineer, Ditching Machine with dual attachment, Tractor Mounted Loaders, Cherry Picker, Hydro Crane, Standard or Dinkey Locomotives, Scoopmobiles, Euclid Loader, Soil Cement Machine, Back Filler, Elevating Machine, Power Blade, Drilling Machine, including Well Testing, Caissons, Shaft or any similar type drilling machines, Motor Driven Paint Machine, Pipe Cleaning Machine, Pipe Wrapping Machine, Pipe Bending Machine, Apsco Paver, Boring Machine, (Head Equipment Greaser), Barber-Greene Loaders, Formless Paver, (Well Point System), Concrete Spreader, Hydra Ax, Span Saw, Marine Scoops, Brush Mulcher, Brush Burner, Mesh Placer, Tree Mover, Helicopter Crew (3), Piledriver-Skid or Crawler, Stump Remover, Root Rake, Tug Boat Operator, Refrigerating Machine, Freezing Operator, Chair Cart-Self-Propelled, Hydra Seeder, Straw Blower, Power Sub Grader, Bull Float, Finishing Machine, Self-Propelled Pavement Breaker, Lull (or similar type Machine), Two Air Compressors, Compressors hooked in Manifold, Overhead Crane, Chip Spreader, Mud Cat, Sull-Air, Fork Lifts (except when used for landscaping work), Soil Stabilizer (Seaman Tiller, Bo Mag, Rago Gator, and similar types of equipment), Tube Float, Spray Machine, Curing Machine, Concrete or Asphalt Milling Machine, Snooper Truck-Operator, Backhoe, Farm Tractors (with attachments), 4 Point Lift System (Power Lift or similar type), Skid-Steer (Bob Cat or similar type), Wrecking Shears, Water Blaster.

Class 2. Concrete Mixers without Skips, Rock Crusher, Ditching Machine under 6', Curbing Machine, One Drum Machines without Tower or Boom, Air Tugger, Self-Propelled Concrete Saw, Machine Mounted Post Hole Digger, two to four Generators, Water Pumps or Welding Machines,

within 400 feet, Air Compressor 600 cu. ft. and under, Rollers on Aggregate and Seal Coat Surfaces, Fork Lift (when used for landscaping work), Concrete and Blacktop Curb Machine, One Water Pump, Oilers, Air Valves or Steam Valves, One Welding Machine, Truck Jack, Mud Jack, Gunnite Machine, House Elevators when used for hoisting material, Engine Tenders, Fireman, Wagon Drill, Flex Plane, Conveyor, Siphons and Pulsometer, Switchman, Fireman on Paint Pots, Fireman on Asphalt Plants, Distributor Operator on Trucks, Tampers, Self-Propelled Power Broom, Striping Machine (motor driven), Form Tamper, Bulk Cement Plant, Equipment Greaser, Deck Hands, Truck Crane Oiler-Driver, Cement Blimps, Form Grader, Temporary Heat, Throttle Valve, Super Sucker (and similar type of equipment).

#### Other Classifications of Work:

For definitions of classifications not otherwise set out, the Department generally has on file such definitions which are available. If a task to be performed is not subject to one of the classifications of pay set out, the Department will upon being contacted state which neighboring county has such a classification and provide such rate, such rate being deemed to exist by reference in this document. If no neighboring county rate applies to the task, the Department shall undertake a special determination, such special determination being then deemed to have existed under this determination. If a project requires these, or any classification not listed, please contact IDOL at 618/993-7271 for wagherates or clarifications.

#### LANDSCAPING

Landscaping work falls under the existing classifications for laborer, operating engineer and truck driver. The work performed by landscape plantsman and landscape laborer is covered by the existing classification of laborer. The work performed by landscape operators (regardless of equipment used or its size) is covered by the classifications of operating engineer. The work performed by landscape truck drivers (regardless of size of truck driven) is covered by the classifications of truck driver.



# Effingham County Prevailing Wage for April 2007

Trade Name	RG	TYP	C	Base	FRMAN	*M-F>8	OSA	OSH	H/W	Pensn	Vac	Trng
=====	==	==	=	=====	=====	=====	==	==	=====	=====	=====	=====
ASBESTOS ABT-GEN		ALL		20.750	21.200	1.5	1.5	2.0	5.250	5.600	0.000	0.700
ASBESTOS ABT-MEC		BLD		20.800	0.000	2.0	2.0	2.0	5.000	3.400	0.000	0.000
BOILERMAKER		BLD		28.500	31.000	1.5	1.5	2.0	6.820	11.03	0.000	0.300
BRICK MASON		BLD		24.130	25.630	2.0	2.0	2.0	5.200	5.900	0.000	0.630
CARPENTER		BLD		25.590	27.590	1.5	1.5	2.0	6.500	6.800	0.000	0.320
CARPENTER		HWY		23.940	25.690	1.5	1.5	2.0	6.500	6.300	0.000	0.300
CEMENT MASON		BLD		25.830	27.080	1.5	1.5	2.0	5.200	7.000	0.000	0.300
CEMENT MASON		HWY		22.400	23.900	1.5	1.5	2.0	5.200	3.850	0.000	0.200
CERAMIC TILE FNSHER		BLD		25.500	0.000	1.5	1.5	2.0	5.200	5.600	0.000	0.000
ELECTRICIAN	N	BLD		29.480	32.420	1.5	1.5	2.0	5.150	5.300	0.000	0.440
ELECTRICIAN	S	ALL		32.910	35.160	1.5	1.5	2.0	5.150	6.580	0.000	0.490
ELECTRONIC SYS TECH	N	BLD		24.370	25.870	1.5	1.5	2.0	5.150	3.650	0.000	0.250
ELECTRONIC SYS TECH	S	BLD		25.700	27.200	1.5	1.5	2.0	5.150	3.340	0.000	0.250
ELEVATOR CONSTRUCTOR		BLD		34.190	38.460	2.0	2.0	2.0	8.275	6.060	2.050	0.000
GLAZIER		BLD		27.130	28.130	1.5	2.0	2.0	5.430	4.000	0.000	0.280
HT/FROST INSULATOR		BLD		26.110	27.110	1.5	1.5	2.0	4.800	6.860	0.000	0.190
IRON WORKER		ALL		24.450	25.750	1.5	1.5	2.0	6.000	8.000	0.000	0.390
LABORER		BLD		20.750	21.200	1.5	1.5	2.0	5.250	5.600	0.000	0.600
LABORER		HWY		21.000	21.450	1.5	1.5	2.0	5.350	6.150	0.000	0.600
LATHER		BLD		25.590	27.590	1.5	1.5	2.0	6.500	6.800	0.000	0.320
MACHINIST		BLD		36.890	38.890	2.0	2.0	2.0	4.380	5.650	2.550	0.000
MARBLE FINISHERS		BLD		25.500	0.000	1.5	1.5	2.0	5.200	5.600	0.000	0.000
MARBLE MASON		BLD		27.000	0.000	1.5	1.5	2.0	5.200	5.600	0.000	0.000
MILLWRIGHT		BLD		26.000	28.000	1.5	1.5	2.0	6.500	6.850	0.000	0.320
MILLWRIGHT		HWY		16.450	17.700	1.5	1.5	2.0	2.800	3.000	0.000	0.000
OPERATING ENGINEER		ALL	1	28.650	0.000	1.5	1.5	2.0	5.200	6.750	0.000	0.650
OPERATING ENGINEER		ALL	2	18.600	0.000	1.5	1.5	2.0	5.200	6.750	0.000	0.650
PAINTER		ALL		23.000	24.000	1.5	1.5	2.0	5.500	6.200	0.000	0.180
PILEDRIVER		BLD		26.090	28.090	1.5	1.5	2.0	6.500	6.800	0.000	0.320
PILEDRIVER		HWY		24.440	26.190	1.5	1.5	2.0	6.500	6.300	0.000	0.300
PIPEFITTER		BLD		33.100	35.600	1.5	1.5	2.0	6.450	5.760	0.000	0.620
PLASTERER		BLD		23.940	25.440	1.5	1.5	2.0	5.200	8.200	0.000	0.300
PLUMBER		BLD		33.100	35.600	1.5	1.5	2.0	6.450	5.760	0.000	0.620
ROOFER		BLD		22.350	24.850	1.5	1.5	2.0	6.000	5.550	0.000	0.550
SHEETMETAL WORKER		ALL		27.210	28.460	1.5	1.5	2.0	6.000	4.770	1.630	0.120
SPRINKLER FITTER		BLD		31.240	33.240	1.5	1.5	2.0	6.500	5.350	0.000	0.250
STONE MASON		BLD		24.130	25.630	2.0	2.0	2.0	5.200	5.900	0.000	0.630
TERRAZZO FINISHER		BLD		25.500	0.000	1.5	1.5	2.0	5.200	5.600	0.000	0.000
TERRAZZO MASON		BLD		27.000	0.000	1.5	1.5	2.0	5.200	5.600	0.000	0.000
TILE LAYER		BLD		25.590	27.590	1.5	1.5	2.0	6.500	6.800	0.000	0.320
TILE MASON		BLD		27.000	0.000	1.5	1.5	2.0	5.200	5.600	0.000	0.000
TRUCK DRIVER		ALL	1	25.787	0.000	1.5	1.5	2.0	7.250	3.317	0.000	0.000
TRUCK DRIVER		ALL	2	26.187	0.000	1.5	1.5	2.0	7.250	3.317	0.000	0.000
TRUCK DRIVER		ALL	3	26.387	0.000	1.5	1.5	2.0	7.250	3.317	0.000	0.000
TRUCK DRIVER		ALL	4	26.637	0.000	1.5	1.5	2.0	7.250	3.317	0.000	0.000
TRUCK DRIVER		ALL	5	27.387	0.000	1.5	1.5	2.0	7.250	3.317	0.000	0.000
TUCKPOINTS		BLD		24.130	25.630	2.0	2.0	2.0	5.200	5.900	0.000	0.630

Legend:

M-F>8 (Overtime is required for any hour greater than 8 worked each day, Monday through Friday.)

OSA (Overtime is required for every hour worked on Saturday)

OSH (Overtime is required for every hour worked on Sunday and Holidays)

H/W (Health & Welfare Insurance)

Pensn (Pension)

Vac (Vacation)

Trng (Training)

## Explanations

### EFFINGHAM COUNTY

ELECTRICIANS AND ELECTRONIC SYSTEMS TECHNICIAN (NORTH) - Townships of Banner, Bishop, Douglas, Liberty, Lucas, Moccasin, St. Francis, Summit and Teutopolis.

ELECTRICIANS AND ELECTRONIC SYSTEMS TECHNICIAN (SOUTH) - Those townships not included in NORTH.

The following list is considered as those days for which holiday rates of wages for work performed apply: New Years Day, Memorial/Decoration Day, Fourth of July, Labor Day, Veterans Day, Thanksgiving Day, Christmas Day. Generally, any of these holidays which fall on a Sunday is celebrated on the following Monday. This then makes work performed on that Monday payable at the appropriate overtime rate for holiday pay. Common practice in a given local may alter certain days of celebration such as the day after Thanksgiving for Veterans Day. If in doubt, please check with IDOL.

### EXPLANATION OF CLASSES

ASBESTOS - GENERAL - removal of asbestos material/mold and hazardous materials from any place in a building, including mechanical systems where those mechanical systems are to be removed. This includes the removal of asbestos materials/mold and hazardous materials from ductwork or pipes in a building when the building is to be demolished at the time or at some close future date.

ASBESTOS - MECHANICAL - removal of asbestos material from mechanical systems, such as pipes, ducts, and boilers, where the mechanical systems are to remain.

### CERAMIC TILE FINISHER, MARBLE FINISHER, TERRAZZO FINISHER

Assisting, helping or supporting the tile, marble and terrazzo mechanic by performing their historic and traditional work assignments required to complete the proper installation of the work covered by said crafts. The term "Ceramic" is used for naming the classification only and is in no way a limitation of the product handled. Ceramic takes into consideration most hard tiles.

### ELECTRONIC SYSTEMS TECHNICIAN

Installation, service and maintenance of low-voltage systems which utilizes the transmission and/or transference of voice, sound, vision, or digital for commercial, education, security and entertainment purposes for the following: TV monitoring and surveillance, background/foreground music, intercom and telephone interconnect, field programming, inventory control systems, microwave transmission, multi-media, multiplex, radio page, school, intercom and sound burglar alarms and low voltage master clock systems.

Excluded from this classification are energy management systems, life safety systems, supervisory controls and data acquisition systems not intrinsic with the above listed systems, fire alarm systems, nurse call systems and raceways exceeding fifteen feet in length.

#### TRUCK DRIVER - BUILDING, HEAVY AND HIGHWAY CONSTRUCTION

Class 1. Drivers on 2 axle trucks hauling less than 9 ton. Air compressor and welding machines and brooms, including those pulled by separate units, truck driver helpers, warehouse employees, mechanic helpers, greasers and tiremen, pickup trucks when hauling materials, tools, or workers to and from and on-the-job site, and fork lifts up to 6,000 lb. capacity.

Class 2. Two or three axle trucks hauling more than 9 ton but hauling less than 16 ton. A-frame winch trucks, hydrolift trucks, vector trucks or similar equipment when used for transportation purposes. Fork lifts over 6,000 lb. capacity, winch trucks, four axle combination units, and ticket writers.

Class 3. Two, three or four axle trucks hauling 16 ton or more. Drivers on water pulls, articulated dump trucks, mechanics and working forepersons, and dispatchers. Five axle or more combination units.

Class 4. Low Boy and Oil Distributors.

Class 5. Drivers who require special protective clothing while employed on hazardous waste work.

#### OPERATING ENGINEERS - BUILDING, HEAVY AND HIGHWAY CONSTRUCTION

Class 1. Power Cranes, Draglines, Derricks, Shovels, Gradalls, Mechanics, Tractor Highlift, Tournadozer, Concrete Mixers with Skip, Tournamixer, Two Drum Machine, One Drum Hoist with Tower or Boom, Cableways, Tower Machines, Motor Patrol, Boom Tractor, Boom or Winch Truck, Winch or Hydraulic Boom Truck, Truck Crane, Tournapull, Tractor Operating Scoops, Bulldozer, Push Tractor, Asphalt Planer, Finishing Machine on Asphalt, Large Rollers on Earth, Rollers on Asphalt Mix, Ross Carrier or similar Machine, Gravel Processing Machine, Asphalt Plant Engineer, Paver Operator, Dredging Equipment, or Dredge Engineer, or Dredge Operator, Central Mix Plant Engineer, CMI or similar type machine, Concrete Pump, Truck or Skid Mounted, Tower Crane, Engineer or Rock Crusher Plant, Concrete Plant Engineer, Ditching Machine with dual attachment, Tractor Mounted Loaders, Cherry Picker, Hydro Crane, Standard or Dinkey Locomotives, Scoopmobiles, Euclid Loader, Soil Cement Machine, Back Filler, Elevating Machine, Power Blade, Drilling Machine, including Well Testing, Caissons, Shaft or any similar type drilling machines, Motor Driven Paint Machine, Pipe Cleaning Machine, Pipe Wrapping Machine, Pipe Bending Machine, Apsco Paver, Boring Machine, (Head Equipment Greaser), Barber-Greene Loaders, Formless Paver, (Well Point System), Concrete Spreader, Hydra Ax, Span Saw, Marine Scoops, Brush Mulcher, Brush Burner, Mesh Placer, Tree Mover, Helicopter Crew (3), Piledriver-Skid or Crawler, Stump Remover, Root Rake, Tug Boat Operator, Refrigerating Machine, Freezing Operator, Chair Cart-Self-Propelled, Hydra Seeder, Straw Blower, Power Sub Grader, Bull Float, Finishing Machine, Self-Propelled Pavement Breaker, Lull (or similar type Machine), Two Air Compressors, Compressors hooked in Manifold, Overhead Crane, Chip Spreader, Mud Cat, Sull-Air, Fork Lifts (except when used for landscaping work), Soil Stabilizer (Seaman Tiller, Bo Mag, Rago Gator, and similar types of equipment), Tube Float, Spray Machine, Curing Machine, Concrete or Asphalt Milling Machine, Snooper Truck-Operator, Backhoe, Farm Tractors (with

attachments), 4 Point Lift System (Power Lift or similar type), Skid-Steer (Bob Cat or similar type), Wrecking Shears, Water Blaster.

Class 2. Concrete Mixers without Skips, Rock Crusher, Ditching Machine under 6', Curbing Machine, One Drum Machines without Tower or Boom, Air Tugger, Self-Propelled Concrete Saw, Machine Mounted Post Hole Digger, two to four Generators, Water Pumps or Welding Machines, within 400 feet, Air Compressor 600 cu. ft. and under, Rollers on Aggregate and Seal Coat Surfaces, Fork Lift (when used for landscaping work), Concrete and Blacktop Curb Machine, One Water Pump, Oilers, Air Valves or Steam Valves, One Welding Machine, Truck Jack, Mud Jack, Gunnite Machine, House Elevators when used for hoisting material, Engine Tenders, Fireman, Wagon Drill, Flex Plane, Conveyor, Siphons and Pulsometer, Switchman, Fireman on Paint Pots, Fireman on Asphalt Plants, Distributor Operator on Trucks, Tampers, Self-Propelled Power Broom, Striping Machine (motor driven), Form Tamper, Bulk Cement Plant, Equipment Greaser, Deck Hands, Truck Crane Oiler-Driver, Cement Blimps, Form Grader, Temporary Heat, Throttle Valve, Super Sucker (and similar type of equipment).

Other Classifications of Work:

For definitions of classifications not otherwise set out, the Department generally has on file such definitions which are available. If a task to be performed is not subject to one of the classifications of pay set out, the Department will upon being contacted state which neighboring county has such a classification and provide such rate, such rate being deemed to exist by reference in this document. If no neighboring county rate applies to the task, the Department shall undertake a special determination, such special determination being then deemed to have existed under this determination. If a project requires these, or any classification not listed, please contact IDOL at 618/993-7271 for wage rates or clarifications.

#### LANDSCAPING

Landscaping work falls under the existing classifications for laborer, operating engineer and truck driver. The work performed by landscape plantsman and landscape laborer is covered by the existing classification of laborer. The work performed by landscape operators (regardless of equipment used or its size) is covered by the classifications of operating engineer. The work performed by landscape truck drivers (regardless of size of truck driven) is covered by the classifications of truck driver.

# Fayette County Prevailing Wage for April 2007

Trade Name	RG	TYP	C	Base	FRMAN	*M-F>8	OSA	OSH	H/W	Pensn	Vac	Trng
=====	==	==	=	=====	=====	=====	==	==	=====	=====	=====	=====
ASBESTOS ABT-GEN		ALL		20.750	21.200	1.5	1.5	2.0	5.250	5.600	0.000	0.700
ASBESTOS ABT-MEC		BLD		25.290	26.290	1.5	1.5	2.0	4.450	2.500	0.000	0.250
BOILERMAKER		BLD		28.500	31.000	1.5	1.5	2.0	6.820	11.03	0.000	0.300
BRICK MASON		BLD		26.400	28.100	1.5	1.5	5.0	4.750	8.250	2.000	0.390
CARPENTER		BLD		27.780	29.280	1.5	1.5	2.0	5.050	3.750	0.000	0.350
CARPENTER		HWY		27.730	29.480	1.5	1.5	2.0	5.050	3.750	0.000	0.350
CEMENT MASON		BLD		23.500	24.500	1.5	1.5	2.0	5.200	3.550	0.000	0.100
CEMENT MASON		HWY		23.500	25.000	1.5	1.5	2.0	5.200	2.750	0.000	0.200
CERAMIC TILE FNSHER		BLD		22.610	0.000	1.5	1.5	2.0	5.000	4.300	0.000	0.400
ELECTRIC PWR EQMT OP		ALL		30.750	0.000	1.5	1.5	2.0	4.750	8.610	0.000	0.000
ELECTRIC PWR GRNDMAN		ALL		21.090	0.000	1.5	1.5	2.0	4.750	5.905	0.000	0.000
ELECTRIC PWR LINEMAN		ALL		34.160	36.350	1.5	1.5	2.0	4.750	9.560	0.000	0.000
ELECTRIC PWR TRK DRV		ALL		22.130	0.000	1.5	1.5	2.0	4.750	6.200	0.000	0.000
ELECTRICIAN	N	BLD		29.480	32.420	1.5	1.5	2.0	5.150	5.300	0.000	0.440
ELECTRICIAN	S	ALL		32.910	35.160	1.5	1.5	2.0	5.150	6.580	0.000	0.490
ELECTRONIC SYS TECH		BLD		25.700	27.200	1.5	1.5	2.0	5.150	3.340	0.000	0.250
ELEVATOR CONSTRUCTOR		BLD		34.190	38.460	2.0	2.0	2.0	8.275	6.060	2.050	0.000
FLOOR LAYER		BLD		26.930	27.680	1.5	1.5	2.0	5.000	3.750	0.000	0.350
GLAZIER		BLD		27.130	28.130	1.5	2.0	2.0	5.430	4.000	0.000	0.280
HT/FROST INSULATOR		BLD		30.440	31.440	1.5	1.5	2.0	4.850	8.360	0.000	0.450
IRON WORKER		ALL		26.350	27.850	1.5	1.5	2.0	6.360	8.250	0.000	0.420
LABORER		BLD		20.750	21.200	1.5	1.5	2.0	5.250	5.600	0.000	0.600
LABORER		HWY		21.000	21.450	1.5	1.5	2.0	5.350	6.150	0.000	0.600
MACHINIST		BLD		36.890	38.890	2.0	2.0	2.0	4.380	5.650	2.550	0.000
MARBLE FINISHERS		BLD		22.610	0.000	1.5	1.5	2.0	5.000	4.300	0.000	0.400
MARBLE MASON		BLD		26.400	28.100	1.5	1.5	5.0	4.750	8.250	2.000	0.390
MILLWRIGHT		BLD		27.780	29.280	1.5	1.5	2.0	5.050	3.750	0.000	0.350
MILLWRIGHT		HWY		28.230	29.980	1.5	1.5	2.0	5.050	3.750	0.000	0.350
OPERATING ENGINEER		ALL	1	25.900	27.030	1.5	1.5	2.0	6.200	11.45	0.000	1.000
OPERATING ENGINEER		ALL	2	24.770	27.030	1.5	1.5	2.0	6.200	11.45	0.000	1.000
OPERATING ENGINEER		ALL	3	20.290	27.030	1.5	1.5	2.0	6.200	11.45	0.000	1.000
OPERATING ENGINEER		ALL	4	20.350	27.030	1.5	1.5	2.0	6.200	11.45	0.000	1.000
OPERATING ENGINEER		ALL	5	20.020	27.030	1.5	1.5	2.0	6.200	11.45	0.000	1.000
OPERATING ENGINEER		ALL	6	26.450	27.030	1.5	1.5	2.0	6.200	11.45	0.000	1.000
OPERATING ENGINEER		ALL	7	26.750	27.030	1.5	1.5	2.0	6.200	11.45	0.000	1.000
OPERATING ENGINEER		ALL	8	27.030	27.030	1.5	1.5	2.0	6.200	11.45	0.000	1.000
PAINTER		BLD		25.700	26.700	1.5	1.5	2.0	4.650	5.150	0.000	0.350
PAINTER		HWY		26.800	27.800	1.5	1.5	2.0	4.650	5.150	0.000	0.350
PAINTER OVER 30FT		BLD		26.700	27.700	1.5	1.5	2.0	4.650	5.150	0.000	0.350
PAINTER PWR EQMT		BLD		26.700	27.700	1.5	1.5	2.0	4.650	5.150	0.000	0.350
PAINTER PWR EQMT		HWY		27.800	28.800	1.5	1.5	2.0	4.650	5.150	0.000	0.350
PILEDRIVER		BLD		27.780	29.280	1.5	1.5	2.0	5.050	3.750	0.000	0.350
PILEDRIVER		HWY		28.230	29.980	1.5	1.5	2.0	5.050	3.750	0.000	0.350
PIPEFITTER		BLD		29.500	31.500	1.5	1.5	2.0	5.000	4.850	0.000	0.800
PLASTERER		BLD		23.500	24.500	1.5	1.5	2.0	5.200	3.550	0.000	0.100
PLUMBER		BLD		29.500	31.500	1.5	1.5	2.0	5.000	4.850	0.000	0.800
ROOFER		BLD		22.350	24.850	1.5	1.5	2.0	6.000	5.550	0.000	0.550
SHEETMETAL WORKER		ALL		27.210	28.460	1.5	1.5	2.0	6.000	4.770	1.630	0.120
SPRINKLER FITTER		BLD		31.240	33.240	1.5	1.5	2.0	6.500	5.350	0.000	0.250
TERRAZZO FINISHER		BLD		31.240	0.000	1.5	1.5	2.0	0.000	0.000	0.000	0.000
TERRAZZO MASON		BLD		30.780	31.080	1.5	1.5	2.0	0.000	3.750	0.000	0.000
TRUCK DRIVER		ALL	1	25.930	0.000	1.5	1.5	2.0	7.250	3.425	0.000	0.000
TRUCK DRIVER		ALL	2	26.330	0.000	1.5	1.5	2.0	7.250	3.425	0.000	0.000
TRUCK DRIVER		ALL	3	26.530	0.000	1.5	1.5	2.0	7.250	3.425	0.000	0.000
TRUCK DRIVER		ALL	4	26.780	0.000	1.5	1.5	2.0	7.250	3.425	0.000	0.000
TRUCK DRIVER		ALL	5	27.530	0.000	1.5	1.5	2.0	7.250	3.425	0.000	0.000
TRUCK DRIVER		O&C	1	20.740	0.000	1.5	1.5	2.0	7.250	3.425	0.000	0.000
TRUCK DRIVER		O&C	2	21.060	0.000	1.5	1.5	2.0	7.250	3.425	0.000	0.000

TRUCK DRIVER	O&C 3	21.220	0.000	1.5	1.5	2.0	7.250	3.425	0.000	0.000
TRUCK DRIVER	O&C 4	21.420	0.000	1.5	1.5	2.0	7.250	3.425	0.000	0.000
TRUCK DRIVER	O&C 5	22.020	0.000	1.5	1.5	2.0	7.250	3.425	0.000	0.000

Legend:

M-F>8 (Overtime is required for any hour greater than 8 worked each day, Monday through Friday.)

OSA (Overtime is required for every hour worked on Saturday)

OSH (Overtime is required for every hour worked on Sunday and Holidays)

H/W (Health & Welfare Insurance)

Pensn (Pension)

Vac (Vacation)

Trng (Training)

## Explanations

### FAYETTE COUNTY

ELECTRICIANS (NORTH) - Townships of Bowling Green, Carson, Hurrican, Loudon, Ramsey, and South Hurricane.

GLAZIERS (SOUTHWEST) - That part of the county South and West of diagonal line running between the Bond, Montgomery, Fayette junction and North of Farina.

The following list is considered as those days for which holiday rates of wages for work performed apply: New Years Day, Memorial/Decoration Day, Fourth of July, Labor Day, Veterans Day, Thanksgiving Day, Christmas Day. Generally, any of these holidays which fall on a Sunday is celebrated on the following Monday. This then makes work performed on that Monday payable at the appropriate overtime rate for holiday pay. Common practice in a given local may alter certain days of celebration such as the day after Thanksgiving for Veterans Day. If in doubt, please check with IDOL.

Oil and chip resealing (O&C) means the application of road oils and liquid asphalt to coat an existing road surface, followed by application of aggregate chips or gravel to coated surface, and subsequent rolling of material to seal the surface.

### EXPLANATION OF CLASSES

ASBESTOS - GENERAL - removal of asbestos material/mold and hazardous materials from any place in a building, including mechanical systems where those mechanical systems are to be removed. This includes the removal of asbestos materials/mold and hazardous materials from ductwork or pipes in a building when the building is to be demolished at the time or at some close future date.

ASBESTOS - MECHANICAL - removal of asbestos material from mechanical systems, such as pipes, ducts, and boilers, where the mechanical systems are to remain.

## CERAMIC TILE FINISHER AND MARBLE FINISHER

The handling, at the building site, of all sand, cement, tile, marble or stone and all other materials that may be used and installed by [a] tile layer or marble mason. In addition, the grouting, cleaning, sealing, and mixing on the job site, and all other work as required in assisting the setter. The term "Ceramic" is used for naming the classification only and is in no way a limitation of the product handled. Ceramic takes into consideration most hard tiles.

## ELECTRONIC SYSTEMS TECHNICIAN

Installation, service and maintenance of low-voltage systems which utilizes the transmission and/or transference of voice, sound, vision, or digital for commercial, education, security and entertainment purposes for the following: TV monitoring and surveillance, background/foreground music, intercom and telephone interconnect, field programming, inventory control systems, microwave transmission, multi-media, multiplex, radio page, school, intercom and sound burglar alarms and low voltage master clock systems.

Excluded from this classification are energy management systems, life safety systems, supervisory controls and data acquisition systems not intrinsic with the above listed systems, fire alarm systems, nurse call systems and raceways exceeding fifteen feet in length.

## TRUCK DRIVER - BUILDING, HEAVY AND HIGHWAY CONSTRUCTION

Class 1. Drivers on 2 axle trucks hauling less than 9 ton. Air compressor and welding machines and brooms, including those pulled by separate units, truck driver helpers, warehouse employees, mechanic helpers, greasers and tiremen, pickup trucks when hauling materials, tools, or workers to and from and on-the-job site, and fork lifts up to 6,000 lb. capacity.

Class 2. Two or three axle trucks hauling more than 9 ton but hauling less than 16 ton. A-frame winch trucks, hydrolift trucks, vector trucks or similar equipment when used for transportation purposes. Fork lifts over 6,000 lb. capacity, winch trucks, four axle combination units, and ticket writers.

Class 3. Two, three or four axle trucks hauling 16 ton or more. Drivers on water pulls, articulated dump trucks, mechanics and working forepersons, and dispatchers. Five axle or more combination units.

Class 4. Low Boy and Oil Distributors.

Class 5. Drivers who require special protective clothing while employed on hazardous waste work.

## TRUCK DRIVER - OIL AND CHIP RESEALING ONLY.

This shall encompass laborers, workers and mechanics who drive contractor or subcontractor owned, leased, or hired pickup, dump, service, or oil distributor trucks. The work includes transporting materials and equipment (including but not limited to, oils, aggregate supplies, parts, machinery and tools) to or from the job site; distributing oil or liquid asphalt and aggregate; stock piling material when in connection with the actual oil and chip contract. The Truck Driver (Oil & Chip Resealing) wage classification does not include supplier delivered materials.

## OPERATING ENGINEERS

GROUP I. Cranes, Dragline, Shovels, Skimmer Scoops, Clamshells or

Derrick Boats, Pile Drivers, Crane-Type Backhoes, Asphalt Plant Operators, Concrete Plant Operators, Dredges, Asphalt Spreading Machines, All Locomotives, Cable Ways, or Tower Machines, Hoists, Hydraulic Backhoes, Ditching Machines or Backfiller, Cherrypickers, Overhead Cranes, Roller, Steam or Gas, Concrete Pavers, Excavators, Concrete Breakers, Concrete Pumps, Bulk Cement Plants, Cement Pumps, Derrick-Type Drills, Boat Operators, Motor Graders or Pushcats, Scoops or Tournapulls, Bulldozers, Endloaders or Fork Lifts, Power Blade or Elevating Graders, Winch Cats, Boom or Winch Trucks or Boom Tractors, Pipe Wrapping or Painting Machines, Asphalt Plant Engineer, Journeyman Lubricating Engineer, Drills (other than Derrick Type), Mud Jacks, or Well Drilling Machines, Boring Machines or Track Jacks, Mixers, Conveyors (Two), Air Compressors (Two), Water Pumps regardless of size (Two), Welding Machines (Two), Siphons or Jets (Two), Winch Heads or Apparatuses (Two), Light Plants (Two), Waterblasters (two), All Tractors regardless of size (straight tractor only), Fireman on Stationary Boilers, Automatic Elevators, Form Grading Machines, Finishing Machines, Power Sub-Grader or Ribbon Machines, Longitudinal Floats, Distributor Operators on Trucks, Winch Heads or Apparatuses (One), Mobil Track air and heaters (two to five), Heavy Equipment Greaser, Relief Operator, Assistant Master Mechanic and Heavy Duty Mechanic, all Operators (except those listed below).

GROUP II. Assistant Operators.

GROUP III. Air Compressors (One), Water Pumps, regardless of Size (One), Waterblasters (one), Welding Machine (One), Mixers (One Bag), Conveyor (One), Siphon or Jet (One), Light Plant (One), Heater (One), Immobile Track Air (One), and Self Propelled Walk-Behind Rollers.

GROUP IV. Asphalt Spreader Oilers, Fireman on Whirlies and Heavy Equipment Oilers, Truck Cranes, Dredges, Monigans, Large Cranes - (Over 65-ton rated capacity) Concrete Plant Oiler, Blacktop Plant Oiler, and Creter Crane Oiler (when required).

GROUP V. Oiler.

GROUP VI. Master Mechanics, Operators on equipment with Booms, including jibs, 100 feet and over, and less than 150 feet long.

GROUP VII. Operators on equipment with Booms, including jibs, 150 feet and over, and less than 200 feet long.

GROUP VIII. Operators on Equipment with Booms, including jibs, 200 feet and over; Tower Cranes; Whirlie Cranes; and Operator Foreman.

TERRAZZO FINISHER

The handling of all materials used for Mosaic and Terrazzo work including preparing, mixing by hand, by mixing machine or transporting of pre-mixed materials and distributing with shovel, rake, hoe, or pail, all kinds of concrete foundations necessary for Mosaic and Terrazzo work, all cement terrazzo, magnesite terrazzo, Do-O-Tex terrazzo, epoxy matrix ter-razzo, exposed aggregate, rustic or rough washed for exterior or interior of buildings placed either by machine or by hand, and any other kind of mixture of plastics composed of chips or granules when mixed with cement, rubber, neoprene, vinyl, magnesium chloride or any other resinous or chemical substances used for seamless flooring systems, and all other building materials, all similar materials and all precast terrazzo work on jobs, all scratch coat used for Mosaic and Terrazzo work and sub-bed, tar paper and wire mesh (2x2 etc.) or lath. The rubbing, grinding, cleaning and finishing of same either by hand or by machine or by terrazzo



resurfacing equipment on new or existing floors. When necessary finishers shall be allowed to assist the mechanics to spread sand bed, lay tarpaper and wire mesh (2x2 etc.) or lath. The finishing of cement floors where additional aggregate of stone is added by spreading or sprinkling on top of the finished base, and troweled or rolled into the finish and then the surface is ground by grinding machines.

#### Other Classifications of Work:

For definitions of classifications not otherwise set out, the Department generally has on file such definitions which are available. If a task to be performed is not subject to one of the classifications of pay set out, the Department will upon being contacted state which neighboring county has such a classification and provide such rate, such rate being deemed to exist by reference in this document. If no neighboring county rate applies to the task, the Department shall undertake a special determination, such special determination being then deemed to have existed under this determination. If a project requires these, or any classification not listed, please contact IDOL at 618/993-7271 for wage rates or clarifications.

#### LANDSCAPING

Landscaping work falls under the existing classifications for laborer, operating engineer and truck driver. The work performed by landscape plantsman and landscape laborer is covered by the existing classification of laborer. The work performed by landscape operators (regardless of equipment used or its size) is covered by the classifications of operating engineer. The work performed by landscape truck drivers (regardless of size of truck driven) is covered by the classifications of truck driver.

# Ford County Prevailing Wage for April 2007

Trade Name	RG	TYP	C	Base	FRMAN	*M-F>8	OSA	OSH	H/W	Pensn	Vac	Trng
=====	==	==	=	=====	=====	=====	==	==	=====	=====	=====	=====
ASBESTOS ABT-GEN		BLD		25.180	26.180	1.5	1.5	2.0	5.850	6.670	0.000	0.750
ASBESTOS ABT-GEN		HWY		25.790	26.790	1.5	1.5	2.0	5.850	6.670	0.000	0.750
ASBESTOS ABT-MEC		BLD		23.300	24.800	1.5	1.5	2.0	7.860	4.910	0.000	0.000
BOILERMAKER		BLD		30.970	33.970	2.0	2.0	2.0	8.270	7.740	0.000	0.300
BRICK MASON	N	BLD		31.850	33.850	1.5	1.5	2.0	5.500	8.000	0.000	0.430
BRICK MASON	S	BLD		25.500	27.000	1.5	1.5	2.0	5.200	6.500	0.000	0.630
CARPENTER		HWY		27.740	29.490	1.5	1.5	2.0	6.500	4.600	0.000	0.300
CARPENTER	N	BLD		26.850	28.850	1.5	1.5	2.0	6.500	6.250	0.000	0.320
CARPENTER	S	BLD		27.790	29.790	1.5	1.5	2.0	6.500	4.600	0.000	0.320
CEMENT MASON		BLD		25.830	27.080	1.5	1.5	2.0	5.200	7.000	0.000	0.300
CEMENT MASON		HWY		24.170	25.170	1.5	1.5	2.0	5.200	7.000	0.000	0.300
CERAMIC TILE FNSHER		BLD		25.500	0.000	1.5	1.5	2.0	5.200	5.600	0.000	0.000
COMMUNICATION TECH	N	BLD		29.110	30.610	1.5	1.5	2.0	8.270	8.670	0.000	0.290
ELECTRIC PWR EQMT OP		ALL		30.750	0.000	1.5	1.5	2.0	4.750	8.610	0.000	0.000
ELECTRIC PWR GRNDMAN		ALL		21.090	0.000	1.5	1.5	2.0	4.750	5.905	0.000	0.000
ELECTRIC PWR LINEMAN		ALL		34.160	36.350	1.5	1.5	2.0	4.750	9.560	0.000	0.000
ELECTRIC PWR TRK DRV		ALL		22.130	0.000	1.5	1.5	2.0	4.750	6.200	0.000	0.000
ELECTRICIAN	N	BLD		33.950	37.010	1.5	1.5	2.0	8.570	11.01	0.000	0.340
ELECTRICIAN	S	BLD		32.010	34.010	1.5	1.5	2.0	5.150	5.410	0.000	0.480
ELECTRONIC SYS TECH	S	BLD		24.870	26.370	1.5	1.5	2.0	5.150	3.150	0.000	0.250
ELEVATOR CONSTRUCTOR		BLD		34.190	38.460	2.0	2.0	2.0	8.275	6.060	2.050	0.000
FENCE ERECTOR		ALL		26.420	28.170	1.5	1.5	2.0	6.590	6.150	0.000	0.500
GLAZIER		BLD		26.320	27.070	1.5	1.5	2.0	5.650	5.750	0.000	0.350
HT/FROST INSULATOR		BLD		33.300	35.050	1.5	1.5	2.0	7.860	8.610	0.000	0.310
IRON WORKER	N	ALL		30.000	33.000	2.0	2.0	2.0	7.690	10.46	0.000	0.550
IRON WORKER	S	ALL		26.420	28.170	1.5	1.5	2.0	6.590	6.150	0.000	0.500
LABORER		BLD		24.180	25.180	1.5	1.5	2.0	5.850	6.670	0.000	0.600
LABORER		HWY		24.790	25.790	1.5	1.5	2.0	5.850	6.670	0.000	0.600
LABORER, SKILLED		BLD		24.480	25.480	1.5	1.5	2.0	5.850	6.670	0.000	0.600
LABORER, SKILLED		HWY		24.790	25.790	1.5	1.5	2.0	5.850	6.670	0.000	0.600
LATHER		BLD		26.850	28.850	1.5	1.5	2.0	6.500	6.250	0.000	0.320
MACHINIST		BLD		36.890	38.890	2.0	2.0	2.0	4.380	5.650	2.550	0.000
MARBLE FINISHERS		BLD		25.500	0.000	1.5	1.5	2.0	5.200	5.600	0.000	0.000
MARBLE MASON	N	BLD		31.850	33.850	1.5	1.5	2.0	5.500	8.000	0.000	0.430
MARBLE MASON	S	BLD		27.000	0.000	1.5	1.5	2.0	5.200	5.600	0.000	0.000
MILLWRIGHT		BLD		26.680	28.680	1.5	1.5	2.0	6.500	6.850	0.000	0.320
MILLWRIGHT		HWY		26.090	27.840	1.5	1.5	2.0	6.500	6.750	0.000	0.300
OPERATING ENGINEER		ALL	1	28.650	0.000	1.5	1.5	2.0	5.200	6.750	0.000	0.650
OPERATING ENGINEER		ALL	2	18.600	0.000	1.5	1.5	2.0	5.200	6.750	0.000	0.650
PAINTER		ALL		26.850	27.850	1.5	1.5	1.5	5.650	5.750	0.000	0.350
PAINTER SIGNS		BLD		28.970	32.520	1.5	1.5	1.5	2.600	2.310	0.000	0.000
PILEDRIVER		HWY		28.240	29.990	1.5	1.5	2.0	6.500	4.600	0.000	0.300
PILEDRIVER	N	BLD		27.350	29.350	1.5	1.5	2.0	6.500	6.250	0.000	0.320
PILEDRIVER	S	BLD		28.290	30.290	1.5	1.5	2.0	6.500	4.600	0.000	0.320
PIPEFITTER		BLD		33.100	35.600	1.5	1.5	2.0	6.450	5.760	0.000	0.620
PLASTERER		BLD		23.940	25.440	1.5	1.5	2.0	5.200	8.200	0.000	0.300
PLUMBER		BLD		33.100	35.600	1.5	1.5	2.0	6.450	5.760	0.000	0.620
ROOFER		BLD		33.650	35.650	1.5	1.5	2.0	6.460	3.310	0.000	0.330
SHEETMETAL WORKER		BLD		28.600	30.600	1.5	1.5	2.0	7.150	7.330	0.000	0.520
SPRINKLER FITTER		BLD		31.240	33.240	1.5	1.5	2.0	6.500	5.350	0.000	0.250
STONE MASON	S	BLD		25.500	27.000	1.5	1.5	2.0	5.200	6.500	0.000	0.630
TERRAZZO FINISHER		BLD		25.500	0.000	1.5	1.5	2.0	5.200	5.600	0.000	0.000
TERRAZZO MASON	S	BLD		27.000	0.000	1.5	1.5	2.0	5.200	5.600	0.000	0.000
TILE MASON	N	BLD		31.850	33.850	1.5	1.5	2.0	5.500	8.000	0.000	0.430
TILE MASON	S	BLD		27.000	0.000	1.5	1.5	2.0	5.200	5.600	0.000	0.000
TRUCK DRIVER		O&C	1	20.630	0.000	1.5	1.5	2.0	7.250	3.317	0.000	0.000
TRUCK DRIVER		O&C	2	20.950	0.000	1.5	1.5	2.0	7.250	3.317	0.000	0.000
TRUCK DRIVER		O&C	3	21.110	0.000	1.5	1.5	2.0	7.250	3.317	0.000	0.000

TRUCK DRIVER	O&C	4	21.310	0.000	1.5	1.5	2.0	7.250	3.317	0.000	0.000	
TRUCK DRIVER	O&C	5	21.910	0.000	1.5	1.5	2.0	7.250	3.317	0.000	0.000	
TRUCK DRIVER	N	ALL	1	32.040	32.590	1.5	1.5	2.0	5.830	3.680	0.000	0.000
TRUCK DRIVER	N	ALL	2	32.190	32.590	1.5	1.5	2.0	5.830	3.680	0.000	0.000
TRUCK DRIVER	N	ALL	3	32.390	32.590	1.5	1.5	2.0	5.830	3.680	0.000	0.000
TRUCK DRIVER	N	ALL	4	32.590	32.590	1.5	1.5	2.0	5.830	3.680	0.000	0.000
TRUCK DRIVER	S	ALL	1	25.787	0.000	1.5	1.5	2.0	7.250	3.317	0.000	0.000
TRUCK DRIVER	S	ALL	2	26.187	0.000	1.5	1.5	2.0	7.250	3.317	0.000	0.000
TRUCK DRIVER	S	ALL	3	26.387	0.000	1.5	1.5	2.0	7.250	3.317	0.000	0.000
TRUCK DRIVER	S	ALL	4	26.637	0.000	1.5	1.5	2.0	7.250	3.317	0.000	0.000
TRUCK DRIVER	S	ALL	5	27.387	0.000	1.5	1.5	2.0	7.250	3.317	0.000	0.000
TUCKPOINTER	N	BLD		31.850	33.850	1.5	1.5	2.0	5.500	8.000	0.000	0.430
TUCKPOINTER	S	BLD		25.500	27.000	1.5	1.5	2.0	5.200	6.500	0.000	0.630

Legend:

M-F>8 (Overtime is required for any hour greater than 8 worked each day, Monday through Friday.)

OSA (Overtime is required for every hour worked on Saturday)

OSH (Overtime is required for every hour worked on Sunday and Holidays)

H/W (Health & Welfare Insurance)

Pensn (Pension)

Vac (Vacation)

Trng (Training)

## Explanations

### FORD COUNTY

BRICKMASON, MARBLE, TERRAZZO, AND TILE MASON (SOUTH) - That part of the county South of Roberts.

CARPENTERS & PILEDRIVERS (SOUTH) - That part of the county South of an East-West line between the Southwest corner of Iroquois County to Rt. 54 North of Gibson City.

COMMUNICATIONS TECHNICIAN (NORTH) - Rogers, Mona, Pella, and Brenton Townships.

ELECTRICIAN (SOUTH) - Sullivant, Peach Orchard, Lyman, Wall, Dix, Drummer, Patton, and Button.

ELECTRONIC SYSTEMS TECHNICIAN (SOUTH) - All townships EXCEPT Rogers, Mona, Pella, and Brenton Townships.

IRONWORKERS (NORTH) - That part of the county North of an East-West line including Melvin and Sibley.

TRUCK DRIVERS (NORTH) - That part of the county in the "neck" area North of Roberts.

The following list is considered as those days for which holiday rates of wages for work performed apply: New Years Day, Memorial/Decoration

Day, Fourth of July, Labor Day, Veterans Day, Thanksgiving Day, Christmas Day. Generally, any of these holidays which fall on a Sunday is celebrated on the following Monday. This then makes work performed on that Monday payable at the appropriate overtime rate for holiday pay. Common practice in a given local may alter certain days of celebration such as the day after Thanksgiving for Veterans Day. If in doubt, please check with IDOL.

Oil and chip resealing (O&C) means the application of road oils and liquid asphalt to coat an existing road surface, followed by application of aggregate chips or gravel to coated surface, and subsequent rolling of material to seal the surface.

#### EXPLANATION OF CLASSES

ASBESTOS - GENERAL - removal of asbestos material/mold and hazardous materials from any place in a building, including mechanical systems where those mechanical systems are to be removed. This includes the removal of asbestos materials/mold and hazardous materials from ductwork or pipes in a building when the building is to be demolished at the time or at some close future date.

ASBESTOS - MECHANICAL - removal of asbestos material from mechanical systems, such as pipes, ducts, and boilers, where the mechanical systems are to remain.

#### COMMUNICATIONS TECHNICIAN - North

Installation, operation, inspection, maintenance, repair and service of radio, television, recording, voice, sound and vision production and reproduction, telephone and telephone interconnect, facsimile, equipment and appliances used for domestic, commercial, educational and entertainment purposes, pulling of wire through conduit but not the installation of conduit.

#### CERAMIC TILE FINISHER, MARBLE FINISHER, TERRAZZO FINISHER

Assisting, helping or supporting the tile, marble and terrazzo mechanic by performing their historic and traditional work assignments required to complete the proper installation of the work covered by said crafts. The term "Ceramic" is used for naming the classification only and is in no way a limitation of the product handled. Ceramic takes into consideration most hard tiles.

#### ELECTRONIC SYSTEMS TECHNICIAN - South

Installation, service and maintenance of low-voltage systems which utilizes the transmission and/or transference of voice, sound, vision, or digital for commercial, education, security and entertainment purposes for the following: TV monitoring and surveillance, background/foreground music, intercom and telephone interconnect, field programming, inventory control systems, microwave transmission, multi-media, multiplex, radio page, school, intercom and sound burglar alarms and low voltage master clock systems.

Excluded from this classification are energy management systems, life safety systems, supervisory controls and data acquisition systems not intrinsic with the above listed systems, fire alarm systems, nurse call systems and raceways exceeding fifteen feet in length.

#### LABORER, SKILLED - BUILDING

The skilled laborer building (BLD) classification shall encompass the following types of work, irrespective of the site of the work: caisson

workers plus depth, gunnite nozzle men, lead man on sewer work, welders, cutters, burners and torchmen, chain saw operators, paving breaker, jackhammer and drill operators, layout man and/or drainage tile layer, steel form setters - street and highway, air tamping hammerman, signal man on crane, concrete saw operator, screenman on asphalt pavers, front end man on chip spreader, laborers tending masons with hot materials or where foreign materials are used, multiple concrete duct-leadman, luteman, asphalt raker, curb asphalt machine operator, ready mix scalemen (permanent, portable or temporary plant), laborers handling masterplate or similar materials, laser beam operator, concrete burning machine operator, coring machine operator, plaster tenders, underpinning and shoring of buildings, material selector when working with fire-brick or castable material, fire watch, signaling of all power equipment, and tree topper or trimmer when in connection with construction.

#### LABORER, SKILLED - HIGHWAY

The skilled laborer heavy and highway (HWY) classification shall encompass the following types of work, irrespective of the site of the work: handling of materials treated with oil, creosote, asphalt and/or any foreign materials harmful to skin or clothing, track laborers, chloride handlers, the unloading and loading with steel workers and re-bars, concrete workers (wet), tunnel helpers in free air, batch dumpers, mason tenders, kettle and tar men, plastic installers, scaffold workers, motorized buggies or motorized unit used for wet concrete or handling of building materials, laborers with de-watering systems, sewer workers plus depth, rod and chainmen, vibrator operators, mortar mixer operators, cement silica, clay, fly ash, lime and plasters, handlers (bulk or bag), cofferdam workers plus depth, on concrete paving, placing, cutting and tying or reinforcing, deck hand, dredge hand shore laborers, bankmen on floating plant, asphalt workers with machine, and layers, grade checker, power tools, stripping of all concrete forms excluding paving forms, dumpmen and spotters, when necessary, caisson workers plus depth, gunnite nozzle men, welders, cutters, burners and torchmen, chain saw operators, paving breaker, jackhammer and drill operators, layout man and/or drainage tile layer, steel form setters - street and highway, air tamping hammerman, signal man on crane, concrete saw operator, screedman on asphalt pavers, front end man on chip spreader, multiple concrete duct, luteman, asphalt raker, curb asphalt machine operator, ready mix scalemen (portable or temporary plant), laser beam operator, concrete burning machine operator, and coring machine operator.

#### TRUCK DRIVER - BUILDING, HEAVY AND HIGHWAY CONSTRUCTION - SOUTH

Class 1. Drivers on 2 axle trucks hauling less than 9 ton. Air compressor and welding machines and brooms, including those pulled by separate units, truck driver helpers, warehouse employees, mechanic helpers, greasers and tiremen, pickup trucks when hauling materials, tools, or workers to and from and on-the-job site, and fork lifts up to 6,000 lb. capacity.

Class 2. Two or three axle trucks hauling more than 9 ton but hauling less than 16 ton. A-frame winch trucks, hydrolift trucks, vector trucks or similar equipment when used for transportation purposes. Fork lifts over 6,000 lb. capacity, winch trucks, four axle combination units, and ticket writers.

Class 3. Two, three or four axle trucks hauling 16 ton or more. Drivers on water pulls, articulated dump trucks, mechanics and working forepersons, and dispatchers. Five axle or more combination units.

Class 4. Low Boy and Oil Distributors.

Class 5. Drivers who require special protective clothing while employed on hazardous waste work.

TRUCK DRIVER - BUILDING, HEAVY AND HIGHWAY CONSTRUCTION - NORTH

Class 1. Two or three Axle Trucks. A-frame Truck when used for transportation purposes; Air Compressors and Welding Machines, including those pulled by cars, pick-up trucks and tractors; Ambulances; Batch Gate Lockers; Batch Hopperman; Car and Truck Washers; Carry-alls; Fork Lifts and Hoisters; Helpers; Mechanics Helpers and Greasers; Oil Distributors 2-man operation; Pavement Breakers; Pole Trailer, up to 40 feet; Power Mower Tractors; Self-propelled Chip Spreader; Skipman; Slurry Trucks, 2-man operation; Slurry Truck Conveyor Operation, 2 or 3 man; Teamsters Unskilled dumpman; and Truck Drivers hauling warning lights, barricades, and portable toilets on the job site.

Class 2. Four axle trucks; Dump Crets and Adgetors under 7 yards; Dumpsters, Track Trucks, Euclids, Hug Bottom Dump Turnapulls or Turnatrailers when pulling other than self-loading equipment or similar equipment under 16 cubic yards; Mixer Trucks under 7 yards; Ready-mix Plant Hopper Operator, and Winch Trucks, 2 Axles.

Class 3. Five axle trucks; Dump Crets and Adgetors 7 yards and over; Dumpsters, Track Trucks, Euclids, Hug Bottom Dump Turnatrailers or turnapulls when pulling other than self-loading equipment or similar equipment over 16 cubic yards; Explosives and/or Fission Material Trucks; Mixer Trucks 7 yards or over; Mobile Cranes while in transit; Oil Distributors, 1-man operation; Pole Trailer, over 40 feet; Pole and Expandable Trailers hauling material over 50 feet long; Slurry trucks, 1-man operation; Winch trucks, 3 axles or more; Mechanic--Truck Welder and Truck Painter.

Class 4. Six axle trucks; Dual-purpose vehicles, such as mounted crane trucks with hoist and accessories; Foreman; Master Mechanic; Self-loading equipment like P.B. and trucks with scoops on the front.

TRUCK DRIVER - OIL AND CHIP RESEALING ONLY.

This shall encompass laborers, workers and mechanics who drive contractor or subcontractor owned, leased, or hired pickup, dump, service, or oil distributor trucks. The work includes transporting materials and equipment (including but not limited to, oils, aggregate supplies, parts, machinery and tools) to or from the job site; distributing oil or liquid asphalt and aggregate; stock piling material when in connection with the actual oil and chip contract. The Truck Driver (Oil & Chip Resealing) wage classification does not include supplier delivered materials.

OPERATING ENGINEERS - BUILDING, HEAVY AND HIGHWAY CONSTRUCTION

Class 1. Power Cranes, Draglines, Derricks, Shovels, Gradalls, Mechanics, Tractor Highlift, Tournadozer, Concrete Mixers with Skip, Tournamixer, Two Drum Machine, One Drum Hoist with Tower or Boom, Cableways, Tower Machines, Motor Patrol, Boom Tractor, Boom or Winch Truck, Winch or Hydraulic Boom Truck, Truck Crane, Tournapull, Tractor Operating Scoops, Bulldozer, Push Tractor, Asphalt Planer, Finishing Machine on Asphalt, Large Rollers on Earth, Rollers on Asphalt Mix, Ross Carrier or similar Machine, Gravel Processing

Machine, Asphalt Plant Engineer, Paver Operator, Dredging Equipment, or Dredge Engineer, or Dredge Operator, Central Mix Plant Engineer, CMI or similar type machine, Concrete Pump, Truck or Skid Mounted, Tower Crane, Engineer or Rock Crusher Plant, Concrete Plant Engineer, Ditching Machine with dual attachment, Tractor Mounted Loaders, Cherry Picker, Hydro Crane, Standard or Dinkey Locomotives, Scoopmobiles, Euclid Loader, Soil Cement Machine, Back Filler, Elevating Machine, Power Blade, Drilling Machine, including Well Testing, Caissons, Shaft or any similar type drilling machines, Motor Driven Paint Machine, Pipe Cleaning Machine, Pipe Wrapping Machine, Pipe Bending Machine, Apsco Paver, Boring Machine, (Head Equipment Greaser), Barber-Greene Loaders, Formless Paver, (Well Point System), Concrete Spreader, Hydra Ax, Span Saw, Marine Scoops, Brush Mulcher, Brush Burner, Mesh Placer, Tree Mover, Helicopter Crew (3), Piledriver-Skid or Crawler, Stump Remover, Root Rake, Tug Boat Operator, Refrigerating Machine, Freezing Operator, Chair Cart-Self-Propelled, Hydra Seeder, Straw Blower, Power Sub Grader, Bull Float, Finishing Machine, Self-Propelled Pavement Breaker, Lull (or similar type Machine), Two Air Compressors, Compressors hooked in Manifold, Overhead Crane, Chip Spreader, Mud Cat, Sull-Air, Fork Lifts (except when used for landscaping work), Soil Stabilizer (Seaman Tiller, Bo Mag, Rago Gator, and similar types of equipment), Tube Float, Spray Machine, Curing Machine, Concrete or Asphalt Milling Machine, Snooper Truck-Operator, Backhoe, Farm Tractors (with attachments), 4 Point Lift System (Power Lift or similar type), Skid-Steer (Bob Cat or similar type), Wrecking Shears, Water Blaster.

Class 2. Concrete Mixers without Skips, Rock Crusher, Ditching Machine under 6', Curbing Machine, One Drum Machines without Tower or Boom, Air Tugger, Self-Propelled Concrete Saw, Machine Mounted Post Hole Digger, two to four Generators, Water Pumps or Welding Machines, within 400 feet, Air Compressor 600 cu. ft. and under, Rollers on Aggregate and Seal Coat Surfaces, Fork Lift (when used for landscaping work), Concrete and Blacktop Curb Machine, One Water Pump, Oilers, Air Valves or Steam Valves, One Welding Machine, Truck Jack, Mud Jack, Gunnite Machine, House Elevators when used for hoisting material, Engine Tenders, Fireman, Wagon Drill, Flex Plane, Conveyor, Siphons and Pulsometer, Switchman, Fireman on Paint Pots, Fireman on Asphalt Plants, Distributor Operator on Trucks, Tampers, Self-Propelled Power Broom, Striping Machine (motor driven), Form Tamper, Bulk Cement Plant, Equipment Greaser, Deck Hands, Truck Crane Oiler-Driver, Cement Blimps, Form Grader, Temporary Heat, Throttle Valve, Super Sucker (and similar type of equipment).

#### Other Classifications of Work:

For definitions of classifications not otherwise set out, the Department generally has on file such definitions which are available. If a task to be performed is not subject to one of the classifications of pay set out, the Department will upon being contacted state which neighboring county has such a classification and provide such rate, such rate being deemed to exist by reference in this document. If no neighboring county rate applies to the task, the Department shall undertake a special determination, such special determination being then deemed to have existed under this determination. If a project requires these, or any classification not listed, please contact IDOL at 618/993-7271 for wage rates or clarifications.

#### LANDSCAPING

Landscaping work falls under the existing classifications for laborer, operating engineer and truck driver. The work performed by

landscape plantsman and landscape laborer is covered by the existing classification of laborer. The work performed by landscape operators (regardless of equipment used or its size) is covered by the classifications of operating engineer. The work performed by landscape truck drivers (regardless of size of truck driven) is covered by the classifications of truck driver.



# Franklin County Prevailing Wage for April 2007

Trade Name	RG	TYP	C	Base	FRMAN	*M-F>8	OSA	OSH	H/W	Pensn	Vac	Trng
=====	==	==	=	=====	=====	=====	==	==	=====	=====	=====	=====
ASBESTOS ABT-GEN		ALL		20.750	21.200	1.5	1.5	2.0	5.250	5.600	0.000	0.700
ASBESTOS ABT-MEC		BLD		20.800	0.000	2.0	2.0	2.0	5.000	3.400	0.000	0.000
BOILERMAKER		BLD		28.500	31.000	1.5	1.5	2.0	6.820	11.03	0.000	0.300
BRICK MASON		BLD		25.470	26.970	1.5	1.5	2.0	6.000	5.400	0.000	0.425
CARPENTER		BLD		27.780	29.280	1.5	1.5	2.0	5.050	3.750	0.000	0.350
CARPENTER		HWY		27.730	29.230	1.5	1.5	2.0	5.050	3.750	0.000	0.350
CEMENT MASON		BLD		23.500	24.500	1.5	1.5	2.0	5.200	3.550	0.000	0.100
CEMENT MASON		HWY		23.750	24.750	1.5	1.5	2.0	5.300	3.700	0.000	0.300
CERAMIC TILE FNSHER		BLD		24.990	0.000	1.5	1.5	2.0	6.000	5.400	0.000	0.425
ELECTRICIAN		ALL		32.910	35.160	1.5	1.5	2.0	5.150	6.580	0.000	0.490
ELECTRONIC SYS TECH		BLD		25.700	27.200	1.5	1.5	2.0	5.150	3.340	0.000	0.250
FLOOR LAYER		BLD		26.930	27.680	1.5	1.5	2.0	5.000	3.750	0.000	0.350
GLAZIER		BLD		22.930	0.000	1.5	1.5	2.0	4.320	3.800	0.000	0.300
HT/FROST INSULATOR		BLD		26.110	27.110	1.5	1.5	2.0	4.800	6.860	0.000	0.190
IRON WORKER		ALL		24.000	25.250	1.5	1.5	2.0	5.780	6.850	0.000	0.345
LABORER		BLD		20.750	21.200	1.5	1.5	2.0	5.250	5.600	0.000	0.600
LABORER		HWY		21.000	21.450	1.5	1.5	2.0	5.350	6.150	0.000	0.600
LABORER		O&C		15.750	16.200	1.5	1.5	2.0	5.350	6.150	0.000	0.600
MACHINIST		BLD		36.890	38.890	2.0	2.0	2.0	4.380	5.650	2.550	0.000
MARBLE FINISHERS		BLD		24.990	0.000	1.5	1.5	2.0	6.000	5.400	0.000	0.425
MARBLE MASON		BLD		25.470	26.970	1.5	1.5	2.0	6.000	5.400	0.000	0.425
MILLWRIGHT		BLD		27.780	29.280	1.5	1.5	2.0	5.050	3.750	0.000	0.350
MILLWRIGHT		HWY		27.730	29.230	1.5	1.5	2.0	5.050	3.750	0.000	0.350
OE RIVER 1		RIV	1	26.900	0.000	1.5	1.5	2.0	5.650	6.100	0.000	1.100
OE RIVER 2		RIV	2	23.450	0.000	1.5	1.5	2.0	5.650	6.100	0.000	1.100
OPERATING ENGINEER		ALL	1	26.800	27.800	1.5	1.5	2.0	5.650	6.100	0.000	1.100
OPERATING ENGINEER		ALL	2	24.900	27.800	1.5	1.5	2.0	5.650	6.100	0.000	1.100
OPERATING ENGINEER		ALL	3	24.150	27.800	1.5	1.5	2.0	5.650	6.100	0.000	1.100
OPERATING ENGINEER		ALL	4	21.400	27.800	1.5	1.5	2.0	5.650	6.100	0.000	1.100
OPERATING ENGINEER		O&C	1	20.100	21.100	1.5	1.5	2.0	5.650	6.100	0.000	1.100
OPERATING ENGINEER		O&C	2	18.680	21.100	1.5	1.5	2.0	5.650	6.100	0.000	1.100
OPERATING ENGINEER		O&C	3	18.120	21.100	1.5	1.5	2.0	5.650	6.100	0.000	1.100
OPERATING ENGINEER		O&C	4	16.050	21.100	1.5	1.5	2.0	5.650	6.100	0.000	1.100
PAINTER		BLD		22.790	23.790	1.5	1.5	2.0	5.430	4.500	0.000	0.250
PAINTER		HWY		27.090	28.090	1.5	1.5	2.0	5.430	4.500	0.000	0.250
PAINTER OVER 30FT		BLD		23.790	24.790	1.5	1.5	2.0	5.430	4.500	0.000	0.250
PAINTER PWR EQMT		BLD		23.790	24.790	1.5	1.5	2.0	5.430	4.500	0.000	0.250
PAINTER PWR EQMT		HWY		28.090	29.090	1.5	1.5	2.0	5.430	4.500	0.000	0.250
PILEDRIVER		BLD		27.780	29.280	1.5	1.5	2.0	5.050	3.750	0.000	0.350
PILEDRIVER		HWY		27.730	29.230	1.5	1.5	2.0	5.050	3.750	0.000	0.350
PIPEFITTER		BLD		28.750	31.620	1.5	1.5	2.0	6.000	7.500	0.000	0.400
PLASTERER		BLD		23.500	24.500	1.5	1.5	2.0	5.200	3.550	0.000	0.100
PLUMBER		BLD		29.500	32.450	1.5	1.5	2.0	6.600	7.500	0.000	0.550
ROOFER		BLD		19.700	20.500	1.5	1.5	2.0	5.700	3.800	0.000	0.000
SHEETMETAL WORKER		ALL		27.210	28.460	1.5	1.5	2.0	6.000	4.770	1.630	0.120
SPRINKLER FITTER		BLD		31.240	33.240	1.5	1.5	2.0	6.500	5.350	0.000	0.250
STONE MASON		BLD		25.470	26.970	1.5	1.5	2.0	6.000	5.400	0.000	0.425
TERRAZZO FINISHER		BLD		24.990	0.000	1.5	1.5	2.0	6.000	5.400	0.000	0.425
TERRAZZO MASON		BLD		28.500	28.800	1.5	1.5	2.0	0.000	2.950	0.000	0.000
TRUCK DRIVER		ALL	1	24.990	0.000	1.5	1.5	2.0	7.250	4.200	0.000	0.000
TRUCK DRIVER		ALL	2	25.390	0.000	1.5	1.5	2.0	7.250	4.200	0.000	0.000
TRUCK DRIVER		ALL	3	25.590	0.000	1.5	1.5	2.0	7.250	4.200	0.000	0.000
TRUCK DRIVER		ALL	4	25.840	0.000	1.5	1.5	2.0	7.250	4.200	0.000	0.000
TRUCK DRIVER		ALL	5	26.590	0.000	1.5	1.5	2.0	7.250	4.200	0.000	0.000
TRUCK DRIVER		O&C	1	19.500	0.000	1.5	1.5	2.0	4.275	4.670	0.000	0.000
TRUCK DRIVER		O&C	2	15.900	0.000	1.5	1.5	2.0	4.275	4.670	0.000	0.000
TRUCK DRIVER		O&C	3	16.400	0.000	1.5	1.5	2.0	4.275	4.670	0.000	0.000
TUCK POINTER		BLD		25.470	26.970	1.5	1.5	2.0	6.000	5.400	0.000	0.425

Legend :

M-F>8 (Overtime is required for any hour greater than 8 worked each day, Monday through Friday.)

OSA (Overtime is required for every hour worked on Saturday)

OSH (Overtime is required for every hour worked on Sunday and Holidays)

H/W (Health & Welfare Insurance)

Pensn (Pension)

Vac (Vacation)

Trng (Training)

## Explanations

### FRANKLIN COUNTY

The following list is considered as those days for which holiday rates of wages for work performed apply: New Years Day, Memorial/Decoration Day, Fourth of July, Labor Day, Veterans Day, Thanksgiving Day, Christmas Day. Generally, any of these holidays which fall on a Sunday is celebrated on the following Monday. This then makes work performed on that Monday payable at the appropriate overtime rate for holiday pay. Common practice in a given local may alter certain days of celebration such as the day after Thanksgiving for Veterans Day. If in doubt, please check with IDOL.

Oil and Chip Resealing (O&C) means the application of road oils and liquid asphalt to coat an existing road surface, followed by application of aggregate chips or gravel to coated surface, and subsequent rolling of material to seal the surface.

### EXPLANATION OF CLASSES

ASBESTOS - GENERAL - removal of asbestos material/mold and hazardous materials from any place in a building, including mechanical systems where those mechanical systems are to be removed. This includes the removal of asbestos materials/mold and hazardous materials from ductwork or pipes in a building when the building is to be demolished at the time or at some close future date.

ASBESTOS - MECHANICAL - removal of asbestos material from mechanical systems, such as pipes, ducts, and boilers, where the mechanical systems are to remain.

### CERAMIC TILE FINISHER, MARBLE FINISHER, TERRAZZO FINISHER

Assisting, helping or supporting the tile, marble and terrazzo mechanic by performing their historic and traditional work assignments required to complete the proper installation of the work covered by said crafts. The term "Ceramic" is used for naming the classification only, and is in no a limitation of the product handled. Ceramic takes into consideration most hard tiles.

### LABORER - OIL AND CHIP RESEALING ONLY

Hook and unhook chip box from aggregate truck; distribute material within chip box; perform flagging work related to oil and chip resealing; hand spray oil fluids; handle traffic control, including setting-up and maintaining barricades, drums, cones, delineators, signs and other such items, as well as laying-out and applying or removing temporary roadway markings used to control traffic in job site related to oil and chip resealing; and perform clean-up related to oil and chip resealing.

#### ELECTRONIC SYSTEMS TECHNICIAN

Installation, service and maintenance of low-voltage systems which utilizes the transmission and/or transference of voice, sound, vision, or digital for commercial, education, security and entertainment purposes for the following: TV monitoring and surveillance, background/foreground music, intercom and telephone interconnect, field programming, inventory control systems, microwave transmission, multi-media, multiplex, radio page, school, intercom and sound burglar alarms and low voltage master clock systems.

Excluded from this classification are energy management systems, life safety systems, supervisory controls and data acquisition systems not intrinsic with the above listed systems, fire alarm systems, nurse call systems and raceways exceeding fifteen feet in length.

#### TRUCK DRIVER - BUILDING, HEAVY AND HIGHWAY CONSTRUCTION

Class 1. Drivers on 2 axle trucks hauling less than 9 ton. Air compressor and welding machines and brooms, including those pulled by separate units, truck driver helpers, warehouse employees, mechanic helpers, greasers and tiremen, pickup trucks when hauling materials, tools, or workers to and from and on-the-job site, and fork lifts up to 6,000 lb. capacity.

Class 2. Two or three axle trucks hauling more than 9 ton but hauling less than 16 ton. A-frame winch trucks, hydrolift trucks, vector trucks or similar equipment when used for transportation purposes. Fork lifts over 6,000 lb. capacity, winch trucks, four axle combination units, and ticket writers.

Class 3. Two, three or four axle trucks hauling 16 ton or more. Drivers on water pulls, articulated dump trucks, mechanics and working forepersons, and dispatchers. Five axle or more combination units.

Class 4. Low Boy and Oil Distributors.

Class 5. Drivers who require special protective clothing while employed on hazardous waste work.

#### TRUCK DRIVER - O & C - (Oil and Chip Resealing)

It involves driving of contractor or subcontractor owned, leased, or hired pickup, dump, service, or oil distributor trucks. Includes transporting materials and equipment (including, but not limited to oils, aggregate supplies, parts, machinery and tools) to or from the job site; distributing oil or liquid asphalt and aggregate; stock piling material; and maintaining trucks at job site related to oil and chip resealing.

Class 1. Distributors, liquid asphalt hauling and hauling of asphalt rubber-tired rollers.

Class 2. Stockpiling.

Class 3. Tandem hauling to job site.

OPERATING ENGINEERS - BUILDING, HEAVY AND HIGHWAY CONSTRUCTION

Class 1. APSCO or Equal Spreading Machine, Backhoe, Backfiller, Boom or Winch Cat, Bituminous Mixplane Machine, Blacksmith, Bituminous Surfacing Machine, Bull-Dozer, Crane, Shovel, Dragline, Truck Crane, Pile Driver, Concrete Breaker, Concrete or Pumpcrete Pumps, Dinky or Standard Locomotives, Well or Caisson Drills, Elevating Grader, Fork Lifts, Flexplane, Gradeall, Hi-Lift Hoists, Guy-Derricks, Hysters, Mechanic Motor Patrol, Mixers-21 cu. ft. or over, Push Cats, Pulls and Scrapers, Two Well Point Pumps, Pulverizer or Tiller, PugMill, Rubber-Tired Farm Type Tractor with Bulldozer/Blade/Auger or hi-lift over 1/2 yd., Jersey Spreader, Tract-Air used with Drill or Hi-Lift, Trenching or Ditching Machines, Wood Chipper w/Tractor, Self-Propelled Roller w/Blade, Equipment Greaser, Self-Propelled Bump Grinder on Concrete pavement, Boat Operator, Skid-Loaders, Tuggers, Lazer Screed, and Self-Propelled Chip Spreader (when others run conveyors).

Class 2. Any type tractor pulling any type roller or disc, Two Air Compressors (220 cu. ft. capacity or over), Two AirTract Drills, Air-Track Drill w/Compressor, Automatic Bins or Scales w/Compressor or Generator, Pipeline Boring Machine, Bulk Cement Plant w/Separate Compressor, Power Operated Bull Float, Hydra-Lift w/Single Motor, Straw Mulcher Blower w/Spout, Self-Propelled Roller/Compactor, Back-End man on Bituminous Surfacing Machine, oiler on milling machine.

Class 3. Air Compressor w/Valve driving piling, Boom or Winch Type Truck, Two Conveyors, Self-Propelled Concrete Saw, Form Grader, Truck Crane Oiler, Self-Propelled Vibrator, Rubber Tired Farm Type Tractor w/Blade/Bulldozer/Auger/hi-lift - 1/2 yd. or less, Elevator Operator, Man Lift (scissor lift) when lifting materials.

Class 4. Air-Track Drill (one), Belt Drag Machine, Power Broom, Mechanical Plasterer Applicator, Trac-Air, Air Compressor (220 cu. ft. or over) One, Air Compressor (under 220 cu. ft) four, Automatic Bin, Bulk Cement Plant w/Built-in Compressor running off same motor or electric motor, Fireman or Switchman, Self-Propelled Form Tamper, Light Plants (4), Welding Machines (4), Pumps (4), or Combination of four (4) Pumps, Light Plants, Welding Machines, Air-Compressors (under 220 cu. ft.), Mudjacks or Wood Chipper, Mixers - less than 21 cu. ft. Mortar Mixer w/Skip or Pump, Pipeline Tract Jack. One Operating Engineer may operate and maintain any combination of the following pieces of equipment, not to exceed four (4) which shall be within a reasonable distance, such combination may include any equipment in this classification: (Compressors, Light Plants, Generators, Welding Machines, Pumps or Conveyors), One Well- Point Pump, Two Motor Driven Heaters, One Air Compressor (under 220 cu. ft.), One Engine-Driven Conveyor, One Motor Driven Heater, One Light Plant, One Pump, One Welding Machine, One Ulmac or Equal Spreader, Oilers, and one Generator 10 kw or greater.

OPERATING ENGINEER - O & C (Oil and Chip Resealing ONLY.)

Includes the operation of all motorized heavy equipment used in oil and chip rsealing, including but not limited to operating self-propelled chip spreaders, and all types of rollers (both hard and rubber tired); and other duties pertaining to the operation or maintenance of heavy equipment related to oil and chip resealing.

Class 1. See Class 1 above for types of equipment operated.

Class 2. See Class 2 above for types of equipment operated.

Class 3. See Class 3 above for types of equipment operated.

Class 4. See Class 4 above for types of equipment operated.

OPERATING ENGINEER RIVER WORK 1 - operate the following machines when working on River Work and Levee Work on the Mississippi and Ohio Rivers, Lakes and Tributaries: Crane, Shovel, Drageline, Scrapers, Dredge, Derrick, Pile-Driver, Push Boat, all power boat operators, Mechanic, Engineman on Dredge, Leverman on Dredge, All Bituminous Spreader machines, Backhoe, Backfiller, Boom, or Winch Cat, Bituminous Mixplane Machine, Blacksmith, Bituminous Surfacing Machine, Bulldozer, Truck Cranes, Hydraulic Truck Mounted Boom/Crane, Concrete Finishing Machine, or Spreader Machine, Concrete Breaker, Concrete or Pumpcrete Machines, Concrete Plant Operator, All Off Road Material Hauling Equipment, Dinky or Standard Locomotives, Well Drill, Elevating Grader, Fork-Lifts, Flexplane, Gradeall, Hi-Lift, Power Handblade Tugger type Hoist, Hoist Two Drum (or over one), Gyderrick, Hyster, Motor Patrol, Mixers - 21 Cu. Ft. or over, Push Cat, Pulls, & Scrapers, Pumps-Two Well Points, Equipment Greaser, P & H Pulverizer or Pulverizer equal to Pugmill, Pugmill, Rubber-Tired farm type tractor w/Bulldozer/Blade/Auger or Hi-Lift over ½ yard, Skimmer Scoops, Seaman Tiller, Jersey Spreader, Tract-Air used with Drill or Hi-Lift, Trenching or Ditching Machine, Wood Chipper w/Tractor, self-propelled roller w/Blade, Concrete Pumps and Small Equipment Operators.

OPERATING ENGINEER RIVER 2 - when working on River Work and Levee Work on the Mississippi and Ohio Rivers, Lakes and Tributaries shall be employed as the Oiler or Fireman on Crane, Dragline, Shovel, Dredge, Truck Crane, Pile Driver, Gradeall, Dinky or Standard Locomotive, Guy Derrick, Trenching Machine or Ditching Machine 80 H.P. and over, All Terrain (cherry-picker) with over 40 ton Lifting Capacity, Deck Oiler and Deckhands.

#### Other Classifications of Work:

For definitions of classifications not otherwise set out, the Department generally has on file such definitions which are available. If a task to be performed is not subject to one of the classifications of pay set out, the Department will upon being contacted state which neighboring county has such a classification and provide such rate, such rate being deemed to exist by reference in this document. If no neighboring county rate applies to the task, the Department shall undertake a special determination, such special determination being then deemed to have existed under this determination. If a project requires these, or any classification not listed, please contact IDOL at 618/993-7271 for wage rates or clarifications.

#### LANDSCAPING

Landscaping work falls under the existing classifications for laborer, operating engineer and truck driver. The work performed by landscape plantsman and landscape laborer is covered by the existing classification of laborer. The work performed by landscape operators (regardless of equipment used or its size) is covered by the classifications of operating engineer. The work performed by landscape truck drivers (regardless of size of truck driven) is covered by the classifications of truck driver.

# Fulton County Prevailing Wage for April 2007

Trade Name	RG	TYP	C	Base	FRMAN	*M-F>8	OSA	OSH	H/W	Pensn	Vac	Trng
=====	==	===	=	=====	=====	=====	===	===	=====	=====	=====	=====
ASBESTOS ABT-GEN		BLD		23.290	24.040	1.5	1.5	2.0	5.300	7.030	0.000	0.600
ASBESTOS ABT-MEC		BLD		25.290	26.290	1.5	1.5	2.0	4.450	2.500	0.000	0.250
BOILERMAKER		BLD		30.970	33.970	2.0	2.0	2.0	8.270	7.740	0.000	0.300
BRICK MASON		BLD		27.020	28.520	1.5	1.5	2.0	5.500	6.350	0.000	0.390
CARPENTER		BLD		26.210	28.210	1.5	1.5	2.0	6.500	6.920	0.000	0.320
CARPENTER		HWY		27.090	29.090	1.5	1.5	2.0	6.500	6.920	0.000	0.320
CEMENT MASON	NW	ALL		24.230	24.730	1.5	1.5	2.0	5.050	4.500	0.000	0.300
CEMENT MASON	SE	BLD		23.120	24.870	1.5	1.5	2.0	5.290	10.00	0.000	0.500
CEMENT MASON	SE	HWY		24.140	25.140	1.5	1.5	2.0	5.290	10.00	0.000	0.500
CERAMIC TILE FNSHER		BLD		24.910	0.000	1.5	1.5	2.0	5.500	6.350	0.000	0.380
ELECTRIC PWR EQMT OP		ALL		30.750	0.000	1.5	1.5	2.0	4.750	8.610	0.000	0.000
ELECTRIC PWR GRNDMAN		ALL		21.090	0.000	1.5	1.5	2.0	4.750	5.905	0.000	0.000
ELECTRIC PWR LINEMAN		ALL		34.160	36.350	1.5	1.5	2.0	4.750	9.560	0.000	0.000
ELECTRIC PWR TRK DRV		ALL		22.130	0.000	1.5	1.5	2.0	4.750	6.200	0.000	0.000
ELECTRICIAN		BLD		29.860	31.860	1.5	1.5	2.0	5.150	8.060	0.000	0.250
ELECTRONIC SYS TECH		BLD		23.850	25.350	1.5	1.5	2.0	5.150	5.625	0.000	0.250
ELEVATOR CONSTRUCTOR		BLD		34.190	38.460	2.0	2.0	2.0	8.275	6.060	2.050	0.000
GLAZIER		BLD		26.320	27.070	1.5	1.5	2.0	5.650	5.750	0.000	0.350
HT/FROST INSULATOR		BLD		30.440	31.440	1.5	1.5	2.0	4.850	8.360	0.000	0.450
IRON WORKER		BLD		24.960	26.710	1.5	1.5	2.0	8.040	7.410	0.000	0.400
IRON WORKER		HWY		25.920	27.420	1.5	1.5	2.0	8.040	7.410	0.000	0.350
LABORER		BLD		23.290	24.040	1.5	1.5	2.0	5.300	7.030	0.000	0.600
LABORER		HWY		24.150	25.150	1.5	1.5	2.0	5.300	7.030	0.000	0.600
LATHER		BLD		26.210	28.210	1.5	1.5	2.0	6.500	6.920	0.000	0.320
MACHINERY MOVER		HWY		25.920	27.420	1.5	1.5	2.0	8.040	7.410	0.000	0.350
MACHINIST		BLD		36.890	38.890	2.0	2.0	2.0	4.380	5.650	2.550	0.000
MARBLE FINISHERS		BLD		24.910	0.000	1.5	1.5	2.0	5.500	6.350	0.000	0.380
MARBLE MASON		BLD		26.520	27.770	1.5	1.5	2.0	5.500	6.350	0.000	0.380
MILLWRIGHT		BLD		26.620	28.620	1.5	1.5	2.0	6.500	6.850	0.000	0.320
MILLWRIGHT		HWY		27.010	29.010	1.5	1.5	2.0	6.500	6.450	0.000	0.320
OPERATING ENGINEER		BLD 1		27.840	30.840	1.5	1.5	2.0	5.900	8.000	0.000	0.900
OPERATING ENGINEER		BLD 2		25.940	30.840	1.5	1.5	2.0	5.900	8.000	0.000	0.900
OPERATING ENGINEER		BLD 3		24.560	30.840	1.5	1.5	2.0	5.900	8.000	0.000	0.900
OPERATING ENGINEER		HWY 1		29.110	32.110	1.5	1.5	2.0	6.250	9.000	0.000	1.000
OPERATING ENGINEER		HWY 2		26.730	32.110	1.5	1.5	2.0	6.250	9.000	0.000	1.000
OPERATING ENGINEER		HWY 3		22.790	32.110	1.5	1.5	2.0	6.250	9.000	0.000	1.000
PAINTER		ALL		26.850	27.850	1.5	1.5	1.5	5.650	5.750	0.000	0.350
PILEDRIVER		BLD		26.710	28.710	1.5	1.5	2.0	6.500	6.920	0.000	0.320
PILEDRIVER		HWY		27.090	29.090	1.5	1.5	2.0	6.500	6.920	0.000	0.320
PIPEFITTER		BLD		31.630	35.110	1.5	1.5	2.0	6.450	7.680	0.000	0.420
PLASTERER		BLD		23.400	24.650	1.5	1.5	2.0	5.290	9.800	0.000	0.500
PLUMBER		BLD		28.390	30.950	1.5	1.5	2.0	6.450	8.990	0.000	0.800
ROOFER		BLD		24.200	25.200	1.5	1.5	2.0	5.350	6.550	0.000	0.150
SHEETMETAL WORKER		BLD		27.740	29.130	1.5	1.5	2.0	5.670	9.310	0.000	0.310
SIGN HANGER		HWY		25.920	27.420	1.5	1.5	2.0	8.040	7.410	0.000	0.350
SPRINKLER FITTER		BLD		31.240	33.240	1.5	1.5	2.0	6.500	5.350	0.000	0.250
STEEL ERECTOR		HWY		25.920	27.420	1.5	1.5	2.0	8.040	7.410	0.000	0.350
STONE MASON		BLD		27.020	28.520	1.5	1.5	2.0	5.500	6.350	0.000	0.390
TERRAZZO FINISHER		BLD		24.910	0.000	1.5	1.5	2.0	5.500	6.350	0.000	0.380
TERRAZZO MASON		BLD		26.520	27.770	1.5	1.5	2.0	5.500	6.350	0.000	0.380
TILE MASON		BLD		26.520	27.770	1.5	1.5	2.0	5.500	6.350	0.000	0.380
TRUCK DRIVER		ALL 1		25.787	0.000	1.5	1.5	2.0	7.250	3.317	0.000	0.000
TRUCK DRIVER		ALL 2		26.187	0.000	1.5	1.5	2.0	7.250	3.317	0.000	0.000
TRUCK DRIVER		ALL 3		26.387	0.000	1.5	1.5	2.0	7.250	3.317	0.000	0.000
TRUCK DRIVER		ALL 4		26.637	0.000	1.5	1.5	2.0	7.250	3.317	0.000	0.000
TRUCK DRIVER		ALL 5		27.387	0.000	1.5	1.5	2.0	7.250	3.317	0.000	0.000
TRUCK DRIVER		O&C 1		20.630	0.000	1.5	1.5	2.0	7.250	3.317	0.000	0.000
TRUCK DRIVER		O&C 2		20.950	0.000	1.5	1.5	2.0	7.250	3.317	0.000	0.000
TRUCK DRIVER		O&C 3		21.110	0.000	1.5	1.5	2.0	7.250	3.317	0.000	0.000

TRUCK DRIVER	O&C 4	21.310	0.000	1.5	1.5	2.0	7.250	3.317	0.000	0.000
TRUCK DRIVER	O&C 5	21.910	0.000	1.5	1.5	2.0	7.250	3.317	0.000	0.000
TUCKPOINTER	BLD	27.020	28.520	1.5	1.5	2.0	5.500	6.350	0.000	0.390

Legend:

M-F>8 (Overtime is required for any hour greater than 8 worked each day, Monday through Friday.)

OSA (Overtime is required for every hour worked on Saturday)

OSH (Overtime is required for every hour worked on Sunday and Holidays)

H/W (Health & Welfare Insurance)

Pensn (Pension)

Vac (Vacation)

Trng (Training)

## Explanations

FULTON COUNTY

CEMENT MASONS (NORTHWEST) - That part of the county West of a North-South line West of Farmington and Canton and North of an East-West line North of Cuba.

The following list is considered as those days for which holiday rates of wages for work performed apply: New Years Day, Memorial/Decoration Day, Fourth of July, Labor Day, Veterans Day, Thanksgiving Day, Christmas Day. Generally, any of these holidays which fall on a Sunday is celebrated on the following Monday. This then makes work performed on that Monday payable at the appropriate overtime rate for holiday pay. Common practice in a given local may alter certain days of celebration such as the day after Thanksgiving for Veterans Day. If in doubt, please check with IDOL.

Oil and chip resealing (O&C) means the application of road oils and liquid asphalt to coat an existing road surface, followed by application of aggregate chips or gravel to coated surface, and subsequent rolling of material to seal the surface.

### EXPLANATION OF CLASSES

ASBESTOS - GENERAL - removal of asbestos material/mold and hazardous materials from any place in a building, including mechanical systems where those mechanical systems are to be removed. This includes the removal of asbestos materials/mold and hazardous materials from ductwork or pipes in a building when the building is to be demolished at the time or at some close future date.

ASBESTOS - MECHANICAL - removal of asbestos material from mechanical systems, such as pipes, ducts, and boilers, where the mechanical systems are to remain.

CERAMIC TILE FINISHER, MARBLE FINISHER, TERRAZZO FINISHER

Assisting, helping or supporting the tile, marble and terrazzo

mechanic by performing their historic and traditional work assignments required to complete the proper installation of the work covered by said crafts. The term "Ceramic" is used for naming the classification only and is in no way a limitation of the product handled. Ceramic takes into consideration most hard tiles.

#### ELECTRONIC SYSTEMS TECHNICIAN

Installation, service and maintenance of low-voltage systems which utilizes the transmission and/or transference of voice, sound, vision, or digital for commercial, education, security and entertainment purposes for the following: TV monitoring and surveillance, background/foreground music, intercom and telephone interconnect, field programming, inventory control systems, microwave transmission, multi-media, multiplex, radio page, school, intercom and sound burglar alarms and low voltage master clock systems.

Excluded from this classification are energy management systems, life safety systems, supervisory controls and data acquisition systems not intrinsic with the above listed systems, fire alarm systems, nurse call systems and raceways exceeding fifteen feet in length.

#### TRUCK DRIVER - BUILDING, HEAVY AND HIGHWAY CONSTRUCTION

Class 1. Drivers on 2 axle trucks hauling less than 9 ton. Air compressor and welding machines and brooms, including those pulled by separate units, truck driver helpers, warehouse employees, mechanic helpers, greasers and tiremen, pickup trucks when hauling materials, tools, or workers to and from and on-the-job site, and fork lifts up to 6,000 lb. capacity.

Class 2. Two or three axle trucks hauling more than 9 ton but hauling less than 16 ton. A-frame winch trucks, hydrolift trucks, vector trucks or similar equipment when used for transportation purposes. Fork lifts over 6,000 lb. capacity, winch trucks, four axle combination units, and ticket writers.

Class 3. Two, three or four axle trucks hauling 16 ton or more. Drivers on water pulls, articulated dump trucks, mechanics and working forepersons, and dispatchers. Five axle or more combination units.

Class 4. Low Boy and Oil Distributors.

Class 5. Drivers who require special protective clothing while employed on hazardous waste work.

#### TRUCK DRIVER - OIL AND CHIP RESEALING ONLY.

This shall encompass laborers, workers and mechanics who drive contractor or subcontractor owned, leased, or hired pickup, dump, service, or oil distributor trucks. The work includes transporting materials and equipment (including but not limited to, oils, aggregate supplies, parts, machinery and tools) to or from the job site; distributing oil or liquid asphalt and aggregate; stock piling material when in connection with the actual oil and chip contract. The Truck Driver (Oil & Chip Resealing) wage classification does not include supplier delivered materials.

#### OPERATING ENGINEERS - BUILDING

Class 1. Cranes; Overhead Cranes; Gradall; All Cherry Pickers; Mechanics; Central Concrete Mixing Plant Operator; Road Pavers (27E - Dual Drum - Tri Batchers); Blacktop Plant Operators and Plant Engineers; 3 Drum Hoist; Derricks; Hydro Cranes; Shovels; Skimmer



Scoops; Koehring Scooper; Drag Lines; Backhoe; Derrick Boats; Pile Drivers and Skid Rigs; Clamshells; Locomotive Cranes; Dredge (all types) Motor Patrol; Power Blades - Dumore - Elevating and similar types; Tower Cranes (Crawler-Mobile) and Stationary; Crane-type Backfiller; Drott Yumbo and similar types considered as Cranes; Caisson Rigs; Dozer; Tournadozer; Work Boats; Ross Carrier; Helicopter; Tournapulls - all and similar types; Scoops (all sizes); Pushcats; Endloaders (all types); Asphalt Surfacing Machine; Slip Form Paver; Rock Crusher; Heavy Equipment Greaser; CMI, CMI Belt Placer, Auto Grade & 3 Track and similar types; Side Booms; Multiple Unit Earth Movers; Creter Crane; Trench Machine; Pump-crete-Belt Crete-Squeeze Cretes-Screw-type Pumps and Gypsum; Bulker & Pump - Operator will clean; Formless Finishing Machine; Flaherty Spreader or similar types; Screed Man on Laydown Machine; Wheel Tractors (industrial or Farm-type w/Dozer-Hoe-Endloader or other attachments); F.W.D. & Similar Types; Vermeer Concrete Saw.

Class 2. Dinkeys; Power Launches; PH One-pass Soil Cement Machine (and similar types); Pugmill with Pump; Backfillers; Euclid Loader; Forklifts; Jeeps w/Ditching Machine or other attachments; Tuneluger; Automatic Cement and Gravel Batching Plants; Mobile Drills (Soil Testing) and similar types; Gurries and Similar Types; (1) and (2) Drum Hoists (Buck Hoist and Similar Types); Chicago Boom; Boring Machine & Pipe Jacking Machine; Hydro Boom; Dewatering System; Straw Blower; Hydro Seeder; Assistant Heavy Equipment Greaser on Spread; Tractors (Track type) without Power Unit pulling Rollers; Rollers on Asphalt -- Brick Macadem; Concrete Breakers; Concrete Spreaders; Mule Pulling Rollers; Center Stripper; Cement Finishing Machines & CMI Texture & Reel Curing Machines; Cement Finishing Machine; Barber Green or similar loaders; Vibro Tamper (All similar types) Self-propelled; Winch or Boom Truck; Mechanical Bull Floats; Mixers over 3 Bag to 27E; Tractor pulling Power Blade or Elevating Grader; Porter Rex Rail; Clary Screed; Truck Type Hoptoe Oilers; Fireman; Spray Machine on Paving; Curb Machines; Truck Crane Oilers; Oil Distributor; Truck-Mounted Saws.

Class 3. Air Compressor; Power Subgrader; Straight Tractor; Trac Air without attachments; Herman Nelson Heater, Dravo, Warner, Silent Glo, and similar types; Roller: Five (5) Ton and under on Earth or Gravel; Form Grader; Crawler Crane & Skid Rig Oilers; Freight Elevators - permanently installed; Pump; Light Plant; Generator; Conveyor (1) or (2) - Operator will clean; Welding Machine; Mixer (3) Bag and Under (Standard Capacity with skip); Bulk Cement Plant; Oiler on Central Concrete Mixing Plant.

#### OPERATING ENGINEERS - HEAVY AND HIGHWAY CONSTRUCTION

Class 1. Cranes; Hydro Crane; Shovels; Crane Type Backfiller; Tower Cranes - Mobile & Crawler & Stationary; Derricks & Hoists (3 Drum); Draglines; Drott Yumbo & similar types considered as Cranes; Back Hoe; Derrick Boats; Pile Driver and Skid Rigs; Clam Shell; Locomotive - Cranes; Road Pavers - Single Drum - Dual Drum - Tri Batcher; Motor Patrols & Power Blades - Dumore - Elevating & Similar Types; Mechanics; Central Concrete Mixing Plant Operator; Asphalt Batch Plant Operators and Plant Engineers; Gradall; Caisson Rigs; Skimmer Scoop - Koehring Scooper; Dredges (all types); Hoptoe; All Cherry Pickers; Work Boat; Ross Carrier; Helicopter; Dozer; Tournadozer; Tournapulls - all and similar types; Multiple Unit Earth Movers; Scoops (all sizes); Pushcats; Endloaders (all types); Asphalt Surfacing Machine; Slip Form Paver; Rock Crusher; Heavy Equipment Greaser (top greaser on spread); CMI, Auto Grade, CMI Belt Placer & 3 Track and similar types; Side Booms; Starting Engineer on Pipeline; Asphalt Heater & Planer Combination (used to plane streets); Wheel Tractors (with dozer, hoe or endloader attachments); F.W.D. and Similar types; Blaw

Knox Spreader and Similar types; Trench Machines; Pump Crete - Belt Crete - Squeeze Crete - screw type pumps and gypsum (operator will clean); Formless Finishing Machines; Flaherty Spreader or similar types; Screed Man on Laydown Machine; Vermeer Concrete Saw.

Class 2. Bulker & Pump; Power Launches; Boring Machine & Pipe Jacking Machine; Dinkeys; P-H One Pass Soil Cement Machines and similar types; Wheel Tractors (Industry or farm type - other); Back Fillers; Euclid Loader; Fork Lifts; Jeep w/Ditching Machine or other attachments; Tunneluger; Automatic Cement & Gravel Batching Plants; Mobile Drills - Soil Testing and similar types; Pugmill with pump; All (1) and (2) Drum Hoists; Dewatering System; Straw Blower; Hydro-Seeder; Boring Machine; Hydro-Boom; Bump Grinders (self-propelled); Assistant Heavy Equipment Greaser; Apsco Spreader; Tractors (track-type) without Power Units Pulling Rollers on Asphalt - Brick or Macadam; Concrete Breakers; Concrete Spreaders; Cement Strippers; Cement Finishing Machines & CMI Texture & Reel Curing Machines; Vibro-Tampers (all similar types self-propelled); Mechanical Bull Floats; Self-propelled Concrete Saws; Mixers-over three (3) bags to 27E; Winch and Boom Trucks; Tractor Pulling Power Blade or Elevating Grader; Porter Rex Rail; Clary Screed; Mule Pulling Rollers; Pugmill without Pump; Barber Greene or similar Loaders; Track Type Tractor w/Power Unit attached (minimum); Fireman; Spray Machine on Paving; Curb Machines; Paved Ditch Machine; Power Broom; Self-Propelled Conveyors; Power Subgrader; Oil Distributor; Straight Tractor; Truck Crane Oiler; Truck Type Oilers; Directional boring machine; Horizontal directional drill.

Class 3. Straight framed articulating end dump vehicle and Truck mounted vac unit (separately powered); Trac Air Machine (without attachments); Herman Nelson Heater, Dravo Warner, Silent Glo & similar types; Rollers - five ton and under on earth and gravel; Form Graders; Pumps; Light Plant; Generator; Air Compressor (1) or (2); Conveyor; Welding Machine; Mixer - 3 bags and under; Bulk Cement Plant; Oilers.

Other Classifications of Work:

For definitions of classifications not otherwise set out, the Department generally has on file such definitions which are available. If a task to be performed is not subject to one of the classifications of pay set out, the Department will upon being contacted state which neighboring county has such a classification and provide such rate, such rate being deemed to exist by reference in this document. If no neighboring county rate applies to the task, the Department shall undertake a special determination, such special determination being then deemed to have existed under this determination. If a project requires these, or any classification not listed, please contact IDOL at 618/993-7271 for wage rates or clarifications.

#### LANDSCAPING

Landscaping work falls under the existing classifications for laborer, operating engineer and truck driver. The work performed by landscape plantsman and landscape laborer is covered by the existing classification of laborer. The work performed by landscape operators (regardless of equipment used or its size) is covered by the classifications of operating engineer. The work performed by landscape truck drivers (regardless of size of truck driven) is covered by the classifications of truck driver.

# Gallatin County Prevailing Wage for April 2007

Trade Name	RG	TYP	C	Base	FRMAN	*M-F>8	OSA	OSH	H/W	Pensn	Vac	Trng
=====	==	==	=	=====	=====	=====	==	==	=====	=====	=====	=====
ASBESTOS ABT-GEN		ALL		20.750	21.200	1.5	1.5	2.0	5.250	5.600	0.000	0.700
ASBESTOS ABT-MEC		BLD		20.800	0.000	2.0	2.0	2.0	5.000	3.400	0.000	0.000
BOILERMAKER		BLD		28.500	31.000	1.5	1.5	2.0	6.820	11.03	0.000	0.300
BRICK MASON		BLD		25.470	26.970	1.5	1.5	2.0	6.000	5.400	0.000	0.425
CARPENTER		BLD		27.780	29.280	1.5	1.5	2.0	5.050	3.750	0.000	0.350
CARPENTER		HWY		27.730	29.230	1.5	1.5	2.0	5.050	3.750	0.000	0.350
CEMENT MASON		BLD		23.500	24.500	1.5	1.5	2.0	5.200	3.550	0.000	0.100
CEMENT MASON		HWY		23.750	24.750	1.5	1.5	2.0	5.300	3.700	0.000	0.300
CERAMIC TILE FNSHER		BLD		24.990	0.000	1.5	1.5	2.0	6.000	5.400	0.000	0.425
ELECTRICIAN		ALL		32.910	35.160	1.5	1.5	2.0	5.150	6.580	0.000	0.490
ELECTRONIC SYS TECH		BLD		25.700	27.200	1.5	1.5	2.0	5.150	3.340	0.000	0.250
FLOOR LAYER		BLD		26.930	27.680	1.5	1.5	2.0	5.000	3.750	0.000	0.350
GLAZIER		BLD		22.930	0.000	1.5	1.5	2.0	4.320	3.800	0.000	0.300
HT/FROST INSULATOR		BLD		26.110	27.110	1.5	1.5	2.0	4.800	6.860	0.000	0.190
IRON WORKER		ALL		24.000	25.250	1.5	1.5	2.0	5.780	6.850	0.000	0.345
LABORER		BLD		20.750	21.200	1.5	1.5	2.0	5.250	5.600	0.000	0.600
LABORER		HWY		21.000	21.450	1.5	1.5	2.0	5.350	6.150	0.000	0.600
LABORER		O&C		15.750	16.200	1.5	1.5	2.0	5.350	6.150	0.000	0.600
MACHINIST		BLD		36.890	38.890	2.0	2.0	2.0	4.380	5.650	2.550	0.000
MARBLE FINISHERS		BLD		24.990	0.000	1.5	1.5	2.0	6.000	5.400	0.000	0.425
MARBLE MASON		BLD		25.470	26.970	1.5	1.5	2.0	6.000	5.400	0.000	0.425
MILLWRIGHT		BLD		27.780	29.280	1.5	1.5	2.0	5.050	3.750	0.000	0.350
MILLWRIGHT		HWY		27.730	29.230	1.5	1.5	2.0	5.050	3.750	0.000	0.350
OE RIVER 1		RIV	1	26.900	0.000	1.5	1.5	2.0	5.650	6.100	0.000	1.100
OE RIVER 2		RIV	2	23.450	0.000	1.5	1.5	2.0	5.650	6.100	0.000	1.100
OPERATING ENGINEER		ALL	1	26.800	27.800	1.5	1.5	2.0	5.650	6.100	0.000	1.100
OPERATING ENGINEER		ALL	2	24.900	27.800	1.5	1.5	2.0	5.650	6.100	0.000	1.100
OPERATING ENGINEER		ALL	3	24.150	27.800	1.5	1.5	2.0	5.650	6.100	0.000	1.100
OPERATING ENGINEER		ALL	4	21.400	27.800	1.5	1.5	2.0	5.650	6.100	0.000	1.100
OPERATING ENGINEER		O&C	1	20.100	21.100	1.5	1.5	2.0	5.650	6.100	0.000	1.100
OPERATING ENGINEER		O&C	2	18.680	21.100	1.5	1.5	2.0	5.650	6.100	0.000	1.100
OPERATING ENGINEER		O&C	3	18.120	21.100	1.5	1.5	2.0	5.650	6.100	0.000	1.100
OPERATING ENGINEER		O&C	4	16.050	21.100	1.5	1.5	2.0	5.650	6.100	0.000	1.100
PAINTER		BLD		22.790	23.790	1.5	1.5	2.0	5.430	4.500	0.000	0.250
PAINTER		HWY		27.090	28.090	1.5	1.5	2.0	5.430	4.500	0.000	0.250
PAINTER OVER 30FT		BLD		23.790	24.790	1.5	1.5	2.0	5.430	4.500	0.000	0.250
PAINTER PWR EQMT		BLD		23.790	24.790	1.5	1.5	2.0	5.430	4.500	0.000	0.250
PAINTER PWR EQMT		HWY		28.090	29.090	1.5	1.5	2.0	5.430	4.500	0.000	0.250
PILEDRIVER		BLD		27.780	29.280	1.5	1.5	2.0	5.050	3.750	0.000	0.350
PILEDRIVER		HWY		27.730	29.230	1.5	1.5	2.0	5.050	3.750	0.000	0.350
PIPEFITTER		BLD		28.750	31.620	1.5	1.5	2.0	6.000	7.500	0.000	0.400
PLASTERER		BLD		23.500	24.500	1.5	1.5	2.0	5.200	3.550	0.000	0.100
PLUMBER		BLD		29.500	32.450	1.5	1.5	2.0	6.600	7.500	0.000	0.550
ROOFER		BLD		24.690	26.190	1.5	1.5	2.0	4.380	4.000	0.000	0.000
SHEETMETAL WORKER		ALL		27.210	28.460	1.5	1.5	2.0	6.000	4.770	1.630	0.120
SPRINKLER FITTER		BLD		31.240	33.240	1.5	1.5	2.0	6.500	5.350	0.000	0.250
STONE MASON		BLD		25.470	26.970	1.5	1.5	2.0	6.000	5.400	0.000	0.425
TERRAZZO FINISHER		BLD		24.990	0.000	1.5	1.5	2.0	6.000	5.400	0.000	0.425
TRUCK DRIVER		ALL	1	24.990	0.000	1.5	1.5	2.0	7.250	4.200	0.000	0.000
TRUCK DRIVER		ALL	2	25.390	0.000	1.5	1.5	2.0	7.250	4.200	0.000	0.000
TRUCK DRIVER		ALL	3	25.590	0.000	1.5	1.5	2.0	7.250	4.200	0.000	0.000
TRUCK DRIVER		ALL	4	25.840	0.000	1.5	1.5	2.0	7.250	4.200	0.000	0.000
TRUCK DRIVER		ALL	5	26.590	0.000	1.5	1.5	2.0	7.250	4.200	0.000	0.000
TRUCK DRIVER		O&C	1	19.500	0.000	1.5	1.5	2.0	4.275	4.670	0.000	0.000
TRUCK DRIVER		O&C	2	15.900	0.000	1.5	1.5	2.0	4.275	4.670	0.000	0.000
TRUCK DRIVER		O&C	3	16.400	0.000	1.5	1.5	2.0	4.275	4.670	0.000	0.000
TUCKPOINTER		BLD		25.470	26.970	1.5	1.5	2.0	6.000	5.400	0.000	0.425

## Legend :

M-F>8 (Overtime is required for any hour greater than 8 worked each day, Monday through Friday.)

OSA (Overtime is required for every hour worked on Saturday)

OSH (Overtime is required for every hour worked on Sunday and Holidays)

H/W (Health & Welfare Insurance)

Pensn (Pension)

Vac (Vacation)

Trng (Training)

## Explanations

### GALLATIN COUNTY

The following list is considered as those days for which holiday rates of wages for work performed apply: New Years Day, Memorial/Decoration Day, Fourth of July, Labor Day, Veterans Day, Thanksgiving Day, Christmas Day. Generally, any of these holidays which fall on a Sunday is celebrated on the following Monday. This then makes work performed on that Monday payable at the appropriate overtime rate for holiday pay. Common practice in a given local may alter certain days of celebration such as the day after Thanksgiving for Veterans Day. If in doubt, please check with IDOL.

Oil and chip resealing (O&C) means the application of road oils and liquid asphalt to coat an existing road surface, followed by application of aggregate chips or gravel to coated surface, and subsequent rolling of material to seal the surface.

### EXPLANATION OF CLASSES

ASBESTOS - GENERAL - removal of asbestos material/mold and hazardous materials from any place in a building, including mechanical systems where those mechanical systems are to be removed. This includes the removal of asbestos materials/mold and hazardous materials from ductwork or pipes in a building when the building is to be demolished at the time or at some close future date.

ASBESTOS - MECHANICAL - removal of asbestos material from mechanical systems, such as pipes, ducts, and boilers, where the mechanical systems are to remain.

### LABORER - OIL AND CHIP RESEALING ONLY

Hook and unhook chip box from aggregate truck; distribute material within chip box; perform flagging work related to oil and chip resealing; hand spray oil fluids; handle traffic control, including setting-up and maintaining barricades, drums, cones, delineators, signs and other such items, as well as laying-out and applying or removing temporary roadway markings used to control traffic in job site related to oil and chip resealing; and perform clean-up related to oil and chip resealing.

## CERAMIC TILE FINISHER, MARBLE FINISHER, TERRAZZO FINISHER

Assisting, helping or supporting the tile, marble and terrazzo mechanic by performing their historic and traditional work assignments required to complete the proper installation of the work covered by said crafts. The term "Ceramic" is used for naming the classification only, and is in no a limitation of the product handled. Ceramic takes into consideration most hard tiles.

## ELECTRONIC SYSTEMS TECHNICIAN

Installation, service and maintenance of low-voltage systems which utilizes the transmission and/or transference of voice, sound, vision, or digital for commercial, education, security and entertainment purposes for the following: TV monitoring and surveillance, background/foreground music, intercom and telephone interconnect, field programming, inventory control systems, microwave transmission, multi-media, multiplex, radio page, school, intercom and sound burglar alarms and low voltage master clock systems.

Excluded from this classification are energy management systems, life safety systems, supervisory controls and data acquisition systems not intrinsic with the above listed systems, fire alarm systems, nurse call systems and raceways exceeding fifteen feet in length.

## TRUCK DRIVER - BUILDING, HEAVY AND HIGHWAY CONSTRUCTION

Class 1. Drivers on 2 axle trucks hauling less than 9 ton. Air compressor and welding machines and brooms, including those pulled by separate units, truck driver helpers, warehouse employees, mechanic helpers, greasers and tiremen, pickup trucks when hauling materials, tools, or workers to and from and on-the-job site, and fork lifts up to 6,000 lb. capacity.

Class 2. Two or three axle trucks hauling more than 9 ton but hauling less than 16 ton. A-frame winch trucks, hydrolift trucks, vector trucks or similar equipment when used for transportation purposes. Fork lifts over 6,000 lb. capacity, winch trucks, four axle combination units, and ticket writers.

Class 3. Two, three or four axle trucks hauling 16 ton or more. Drivers on water pulls, articulated dump trucks, mechanics and working forepersons, and dispatchers. Five axle or more combination units.

Class 4. Low Boy and Oil Distributors.

Class 5. Drivers who require special protective clothing while employed on hazardous waste work.

## TRUCK DRIVER - O & C (Oil and Chip Resealing ONLY)

It involves driving of contractor or subcontractor owned, leased, or hired pickup, dump, service, or oil distributor trucks. Includes transporting materials and equipment (including, but not limited to oils, aggregate supplies, parts, machinery and tools) to or from the job site; distributing oil or liquid asphalt and aggregate; stock piling material; and maintaining trucks at job site related to oil and chip resealing.

Class 1. Distributors, liquid asphalt hauling and hauling of asphalt rubber-tired rollers.

Class 2. Stockpiling.

Class 3. Tandem hauling to job site.

OPERATING ENGINEERS - BUILDING, HEAVY AND HIGHWAY CONSTRUCTION

Class 1. APSCO or Equal Spreading Machine, Backhoe, Backfiller, Boom or Winch Cat, Bituminous Mixplane Machine, Blacksmith, Bituminous Surfacing Machine, Bull-Dozer, Crane, Shovel, Dragline, Truck Crane, Pile Driver, Concrete Breaker, Concrete or Pumpcrete Pumps, Dinky or Standard Locomotives, Well or Caisson Drills, Elevating Grader, Fork Lifts, Flexplane, Gradeall, Hi-Lift Hoists, Guy-Derricks, Hysters, Mechanic Motor Patrol, Mixers-21 cu. ft. or over, Push Cats, Pulls and Scrapers, Two Well Point Pumps, Pulverizer or Tiller, PugMill, Rubber-Tired Farm Type Tractor with Bulldozer/Blade/Auger or hi-lift over 1/2 yd., Jersey Spreader, Tract-Air used with Drill or Hi-Lift, Trenching or Ditching Machines, Wood Chipper w/Tractor, Self-Propelled Roller w/Blade, Equipment Greaser, Self-Propelled Bump Grinder on Concrete pavement, Boat Operator, Skid-Loaders, Tuggers, Lazer Screed, and Self-Propelled Chip Spreader (when others run conveyors).

Class 2. Any type tractor pulling any type roller or disc, Two Air Compressors (220 cu. ft. capacity or over), Two AirTract Drills, Air-Track Drill w/Compressor, Automatic Bins or Scales w/Compressor or Generator, Pipeline Boring Machine, Bulk Cement Plant w/Separate Compressor, Power Operated Bull Float, Hydra-Lift w/Single Motor, Straw Mulcher Blower w/Spout, Self-Propelled Roller/Compactor, Back-End man on Bituminous Surfacing Machine, oiler on milling machine.

Class 3. Air Compressor w/Valve driving piling, Boom or Winch Type Truck, Two Conveyors, Self-Propelled Concrete Saw, Form Grader, Truck Crane Oiler, Self-Propelled Vibrator, Rubber Tired Farm Type Tractor w/Blade/Bulldozer/Auger/hi-lift - 1/2 yd. or less, Elevator Operator, Man Lift (scissor lift) when lifting materials.

Class 4. Air-Track Drill (one), Belt Drag Machine, Power Broom, Mechanical Plasterer Applicator, Trac-Air, Air Compressor (220 cu. ft. or over) One, Air Compressor (under 220 cu. ft) four, Automatic Bin, Bulk Cement Plant w/Built-in Compressor running off same motor or electric motor, Fireman or Switchman, Self-Propelled Form Tamper, Light Plants (4), Welding Machines (4), Pumps (4), or Combination of four (4) Pumps, Light Plants, Welding Machines, Air-Compressors (under 220 cu. ft.), Mudjacks or Wood Chipper, Mixers - less than 21 cu. ft. Mortar Mixer w/Skip or Pump, Pipeline Tract Jack. One Operating Engineer may operate and maintain any combination of the following pieces of equipment, not to exceed four (4) which shall be within a reasonable distance, such combination may include any equipment in this classification: (Compressors, Light Plants, Generators, Welding Machines, Pumps or Conveyors), One Well- Point Pump, Two Motor Driven Heaters, One Air Compressor (under 220 cu. ft.), One Engine-Driven Conveyor, One Motor Driven Heater, One Light Plant, One Pump, One Welding Machine, One Ulmac or Equal Spreader, Oilers, and one Generator 10 kw or greater.

OPERATING ENGINEER - O & C (Oil and Chip Resealing ONLY). Includes the operation of all motorized heavy equipment used in oil and chip rsealing, including but not limited to operating self-propelled chip spreaders, and all types of rollers (both hard and rubber tired); and other duties pertaining to the operation or maintenance of heavy equipment relatd to oil and chip resealing.

Class 1. See Class 1 above for types of equipment operated.

Class 2. See Class 2 above for types of equipment operated.

Class 3. See Class 3 above for types of equipment operated.

Class 4. See Class 4 above for types of equipment operated.

OPERATING ENGINEER RIVER WORK 1 - operate the following machines when working on River Work and Levee Work on the Mississippi and Ohio Rivers, Lakes and Tributaries: Crane, Shovel, Drageline, Scrapers, Dredge, Derrick, Pile-Driver, Push Boat, all power boat operators, Mechanic, Engineman on Dredge, Leverman on Dredge, All Bituminous Spreader machines, Backhoe, Backfiller, Boom, or Winch Cat, Bituminous Mixplane Machine, Blacksmith, Bituminous Surfacing Machine, Bulldozer, Truck Cranes, Hydraulic Truck Mounted Boom/Crane, Concrete Finishing Machine, or Spreader Machine, Concrete Breaker, Concrete or Pumpcrete Machines, Concrete Plant Operator, All Off Road Material Hauling Equipment, Dinky or Standard Locomotives, Well Drill, Elevating Grader, Fork-Lifts, Flexplane, Gradeall, Hi-Lift, Power Handblade Tugger type Hoist, Hoist Two Drum (or over one), Gyderrick, Hyster, Motor Patrol, Mixers - 21 Cu. Ft. or over, Push Cat, Pulls, & Scrapers, Pumps-Two Well Points, Equipment Greaser, P & H Pulverizer or Pulverizer equal to Pugmill, Pugmill, Rubber-Tired farm type tractor w/Bulldozer/Blade/Auger or Hi-Lift over ½ yard, Skimmer Scoops, Seaman Tiller, Jersey Spreader, Tract-Air used with Drill or Hi-Lift, Trenching or Ditching Machine, Wood Chipper w/Tractor, self-propelled roller w/Blade, Concrete Pumps and Small Equipment Operators.

OPERATING ENGINEER RIVER 2 - when working on River Work and Levee Work on the Mississippi and Ohio Rivers, Lakes and Tributaries shall be employed as the Oiler or Fireman on Crane, Dragline, Shovel, Dredge, Truck Crane, Pile Driver, Gradeall, Dinky or Standard Locomotive, Guy Derrick, Trenching Machine or Ditching Machine 80 H.P. and over, All Terrain (cherry-picker) with over 40 ton Lifting Capacity, Deck Oiler and Deckhands.

#### Other Classifications of Work:

For definitions of classifications not otherwise set out, the Department generally has on file such definitions which are available. If a task to be performed is not subject to one of the classifications of pay set out, the Department will upon being contacted state which neighboring county has such a classification and provide such rate, such rate being deemed to exist by reference in this document. If no neighboring county rate applies to the task, the Department shall undertake a special determination, such special determination being then deemed to have existed under this determination. If a project requires these, or any classification not listed, please contact IDOL at 217/782/1710 for wage rates or clarifications.

#### LANDSCAPING

Landscaping work falls under the existing classifications for laborer, operating engineer and truck driver. The work performed by landscape plantsman and landscape laborer is covered by the existing classification of laborer. The work performed by landscape operators (regardless of equipment used or its size) is covered by the classifications of operating engineer. The work performed by landscape truck drivers (regardless of size of truck driven) is covered by the classifications of truck driver.

# Greene County Prevailing Wage for April 2007

Trade Name	RG	TYP	C	Base	FRMAN	*M-F>8	OSA	OSH	H/W	Pensn	Vac	Trng
=====	==	===	=	=====	=====	=====	===	===	=====	=====	=====	=====
ASBESTOS ABT-GEN		ALL		24.250	24.750	1.5	1.5	2.0	5.050	6.750	0.000	0.600
ASBESTOS ABT-MEC		BLD		25.290	26.290	1.5	1.5	2.0	4.450	2.500	0.000	0.250
BOILERMAKER		BLD		28.500	31.000	1.5	1.5	2.0	6.820	11.03	0.000	0.300
BRICK MASON		BLD		24.370	25.370	1.5	1.5	2.0	6.000	5.400	0.000	0.490
CARPENTER		BLD		24.490	26.490	1.5	1.5	2.0	6.500	7.900	0.000	0.320
CARPENTER		HWY		24.250	26.000	1.5	1.5	2.0	6.500	7.800	0.000	0.300
CEMENT MASON		ALL		26.750	27.500	1.5	1.5	2.0	5.650	8.250	0.000	0.200
CERAMIC TILE FNSHER		BLD		23.020	0.000	1.5	1.5	2.0	6.000	5.400	0.000	0.000
ELECTRIC PWR EQMT OP		ALL		29.470	36.150	1.5	2.0	2.0	5.400	7.380	0.000	0.150
ELECTRIC PWR GRNDMAN		ALL		19.820	36.150	1.5	2.0	2.0	5.400	4.960	0.000	0.100
ELECTRIC PWR LINEMAN		ALL		34.120	36.150	1.5	2.0	2.0	5.400	8.530	0.000	0.170
ELECTRIC PWR TRK DRV		ALL		22.060	36.150	1.5	2.0	2.0	5.400	5.530	0.000	0.110
ELECTRICIAN		ALL		30.110	32.110	1.5	1.5	2.0	5.400	6.950	0.000	0.210
ELECTRONIC SYS TECH		BLD		24.240	25.740	1.5	1.5	2.0	5.650	4.730	0.000	0.250
ELEVATOR CONSTRUCTOR		BLD		37.115	41.750	2.0	2.0	2.0	8.275	4.460	2.227	0.000
GLAZIER		BLD		29.480	0.000	2.0	2.0	2.0	8.550	6.920	2.360	0.160
HT/FROST INSULATOR		BLD		30.440	31.440	1.5	1.5	2.0	4.850	8.360	0.000	0.450
IRON WORKER		BLD		25.400	27.150	1.5	1.5	2.0	5.860	7.900	0.000	0.300
IRON WORKER		HWY		25.400	26.900	1.5	1.5	2.0	5.860	7.900	0.000	0.300
LABORER		ALL		23.750	24.250	1.5	1.5	2.0	5.050	6.750	0.000	0.600
LATHER		BLD		24.490	26.490	1.5	1.5	2.0	6.500	7.900	0.000	0.320
MACHINIST		BLD		36.890	38.890	2.0	2.0	2.0	4.380	5.650	2.550	0.000
MARBLE FINISHERS		BLD		23.020	0.000	1.5	1.5	2.0	6.000	5.400	0.000	0.000
MARBLE MASON		BLD		24.520	25.270	1.5	1.5	2.0	6.000	5.400	0.000	0.000
MILLWRIGHT		BLD		26.000	28.000	1.5	1.5	2.0	6.500	6.850	0.000	0.320
MILLWRIGHT		HWY		18.720	19.970	1.5	1.5	2.0	1.600	2.000	0.000	0.000
OPERATING ENGINEER		ALL	1	25.900	27.030	1.5	1.5	2.0	6.200	11.45	0.000	1.000
OPERATING ENGINEER		ALL	2	24.770	27.030	1.5	1.5	2.0	6.200	11.45	0.000	1.000
OPERATING ENGINEER		ALL	3	20.290	27.030	1.5	1.5	2.0	6.200	11.45	0.000	1.000
OPERATING ENGINEER		ALL	4	20.350	27.030	1.5	1.5	2.0	6.200	11.45	0.000	1.000
OPERATING ENGINEER		ALL	5	20.020	27.030	1.5	1.5	2.0	6.200	11.45	0.000	1.000
OPERATING ENGINEER		ALL	6	26.450	27.030	1.5	1.5	2.0	6.200	11.45	0.000	1.000
OPERATING ENGINEER		ALL	7	26.750	27.030	1.5	1.5	2.0	6.200	11.45	0.000	1.000
OPERATING ENGINEER		ALL	8	27.030	27.030	1.5	1.5	2.0	6.200	11.45	0.000	1.000
PAINTER		BLD		25.700	26.700	1.5	1.5	2.0	4.650	5.150	0.000	0.350
PAINTER		HWY		26.800	27.800	1.5	1.5	2.0	4.650	5.150	0.000	0.350
PAINTER OVER 30FT		BLD		26.700	27.700	1.5	1.5	2.0	4.650	5.150	0.000	0.350
PAINTER PWR EQMT		BLD		26.700	27.700	1.5	1.5	2.0	4.650	5.150	0.000	0.350
PAINTER PWR EQMT		HWY		27.800	28.800	1.5	1.5	2.0	4.650	5.150	0.000	0.350
PILEDRIVER		BLD		24.990	26.990	1.5	1.5	2.0	6.500	7.900	0.000	0.320
PILEDRIVER		HWY		24.750	26.500	1.5	1.5	2.0	6.500	7.800	0.000	0.300
PIPEFITTER		BLD		30.600	32.100	2.0	2.0	2.0	5.350	6.100	0.000	0.130
PLASTERER		BLD		27.000	28.000	1.5	1.5	2.0	5.650	7.250	0.000	0.250
PLUMBER		BLD		30.600	32.100	2.0	2.0	2.0	5.350	6.100	0.000	0.130
ROOFER		BLD		26.250	28.250	1.5	1.5	2.0	6.100	5.950	0.000	0.200
SHEETMETAL WORKER		ALL		27.210	28.460	1.5	1.5	2.0	6.000	4.770	1.630	0.120
SPRINKLER FITTER		BLD		34.230	36.480	2.0	2.0	2.0	6.650	7.850	0.000	0.650
STONE MASON		BLD		24.370	25.370	1.5	1.5	2.0	6.000	5.400	0.000	0.490
TERRAZZO FINISHER		BLD		23.020	0.000	1.5	1.5	2.0	6.000	5.400	0.000	0.000
TERRAZZO MASON		BLD		24.520	25.270	1.5	1.5	2.0	6.000	5.400	0.000	0.000
TILE MASON		BLD		24.520	25.270	1.5	1.5	2.0	6.000	5.400	0.000	0.000
TRUCK DRIVER		ALL	1	25.930	0.000	1.5	1.5	2.0	7.250	3.425	0.000	0.000
TRUCK DRIVER		ALL	2	26.330	0.000	1.5	1.5	2.0	7.250	3.425	0.000	0.000
TRUCK DRIVER		ALL	3	26.530	0.000	1.5	1.5	2.0	7.250	3.425	0.000	0.000
TRUCK DRIVER		ALL	4	26.780	0.000	1.5	1.5	2.0	7.250	3.425	0.000	0.000
TRUCK DRIVER		ALL	5	27.530	0.000	1.5	1.5	2.0	7.250	3.425	0.000	0.000
TRUCK DRIVER		O&C	1	20.740	0.000	1.5	1.5	2.0	7.250	3.425	0.000	0.000
TRUCK DRIVER		O&C	2	21.060	0.000	1.5	1.5	2.0	7.250	3.425	0.000	0.000
TRUCK DRIVER		O&C	3	21.220	0.000	1.5	1.5	2.0	7.250	3.425	0.000	0.000



TRUCK DRIVER	O&C 4	21.420	0.000	1.5	1.5	2.0	7.250	3.425	0.000	0.000
TRUCK DRIVER	O&C 5	22.020	0.000	1.5	1.5	2.0	7.250	3.425	0.000	0.000
TUCKPOINTER	BLD	24.370	25.370	1.5	1.5	2.0	6.000	5.400	0.000	0.490

Legend:

M-F>8 (Overtime is required for any hour greater than 8 worked each day, Monday through Friday.)

OSA (Overtime is required for every hour worked on Saturday)

OSH (Overtime is required for every hour worked on Sunday and Holidays)

H/W (Health & Welfare Insurance)

Pensn (Pension)

Vac (Vacation)

Trng (Training)

## Explanations

GREENE COUNTY

The following list is considered as those days for which holiday rates of wages for work performed apply: New Years Day, Memorial/Decoration Day, Fourth of July, Labor Day, Veterans Day, Thanksgiving Day, Christmas Day. Generally, any of these holidays which fall on a Sunday is celebrated on the following Monday. This then makes work performed on that Monday payable at the appropriate overtime rate for holiday pay. Common practice in a given local may alter certain days of celebration such as the day after Thanksgiving for Veterans Day. If in doubt, please check with IDOL.

Oil and chip resealing (O&C) means the application of road oils and liquid asphalt to coat an existing road surface, followed by application of aggregate chips or gravel to coated surface, and subsequent rolling of material to seal the surface.

EXPLANATION OF CLASSES

ASBESTOS - GENERAL - removal of asbestos material/mold and hazardous materials from any place in a building, including mechanical systems where those mechanical systems are to be removed. This includes the removal of asbestos materials/mold and hazardous materials from ductwork or pipes in a building when the building is to be demolished at the time or at some close future date.

ASBESTOS - MECHANICAL - removal of asbestos material from mechanical systems, such as pipes, ducts, and boilers, where the mechanical systems are to remain.

CERAMIC TILE FINISHER, MARBLE FINISHER, TERRAZZO FINISHER

Assisting, helping or supporting the tile, marble and terrazzo mechanic by performing their historic and traditional work assignments required to complete the proper installation of the work covered by said crafts. The term "Ceramic" is used for naming the classification only and is in no way a limitation of the product handled. Ceramic

takes into consideration most hard tiles.

#### ELECTRONIC SYSTEMS TECHNICIAN

Installation, service and maintenance of low-voltage systems which utilizes the transmission and/or transference of voice, sound, vision, or digital for commercial, education, security and entertainment purposes for the following: TV monitoring and surveillance, background/foreground music, intercom and telephone interconnect, field programming, inventory control systems, microwave transmission, multi-media, multiplex, radio page, school, intercom and sound burglar alarms and low voltage master clock systems.

Excluded from this classification are energy management systems, life safety systems, supervisory controls and data acquisition systems not intrinsic with the above listed systems, fire alarm systems, nurse call systems and raceways exceeding fifteen feet in length.

#### TRUCK DRIVER - BUILDING, HEAVY AND HIGHWAY CONSTRUCTION

Class 1. Drivers on 2 axle trucks hauling less than 9 ton. Air compressor and welding machines and brooms, including those pulled by separate units, truck driver helpers, warehouse employees, mechanic helpers, greasers and tiremen, pickup trucks when hauling materials, tools, or workers to and from and on-the-job site, and fork lifts up to 6,000 lb. capacity.

Class 2. Two or three axle trucks hauling more than 9 ton but hauling less than 16 ton. A-frame winch trucks, hydrolift trucks, vactor trucks or similar equipment when used for transportation purposes. Fork lifts over 6,000 lb. capacity, winch trucks, four axle combination units, and ticket writers.

Class 3. Two, three or four axle trucks hauling 16 ton or more. Drivers on water pulls, articulated dump trucks, mechanics and working forepersons, and dispatchers. Five axle or more combination units.

Class 4. Low Boy and Oil Distributors.

Class 5. Drivers who require special protective clothing while employed on hazardous waste work.

#### TRUCK DRIVER - OIL AND CHIP RESEALING ONLY.

This shall encompass laborers, workers and mechanics who drive contractor or subcontractor owned, leased, or hired pickup, dump, service, or oil distributor trucks. The work includes transporting materials and equipment (including but not limited to, oils, aggregate supplies, parts, machinery and tools) to or from the job site; distributing oil or liquid asphalt and aggregate; stock piling material when in connection with the actual oil and chip contract. The Truck Driver (Oil & Chip Resealing) wage classification does not include supplier delivered materials.

#### OPERATING ENGINEERS

GROUP I. Cranes, Dragline, Shovels, Skimmer Scoops, Clamshells or Derrick Boats, Pile Drivers, Crane-Type Backhoes, Asphalt Plant Operators, Concrete Plant Operators, Dredges, Asphalt Spreading Machines, All Locomotives, Cable Ways, or Tower Machines, Hoists, Hydraulic Backhoes, Ditching Machines or Backfiller, Cherrypickers, Overhead Cranes, Roller, Steam or Gas, Concrete Pavers, Excavators, Concrete Breakers, Concrete Pumps, Bulk Cement Plants, Cement Pumps, Derrick-Type Drills, Boat Operators, Motor Graders or Pushcats, Scoops or Tournapulls, Bulldozers, Endloaders or Fork Lifts, Power Blade or

Elevating Graders, Winch Cats, Boom or Winch Trucks or Boom Tractors, Pipe Wrapping or Painting Machines, Asphalt Plant Engineer, Journeyman Lubricating Engineer, Drills (other than Derrick Type), Mud Jacks, or Well Drilling Machines, Boring Machines or Track Jacks, Mixers, Conveyors (Two), Air Compressors (Two), Water Pumps regardless of size (Two), Welding Machines (Two), Siphons or Jets (Two), Winch Heads or Apparatuses (Two), Light Plants (Two), Waterblasters (two), All Tractors regardless of size (straight tractor only), Fireman on Stationary Boilers, Automatic Elevators, Form Grading Machines, Finishing Machines, Power Sub-Grader or Ribbon Machines, Longitudinal Floats, Distributor Operators on Trucks, Winch Heads or Apparatuses (One), Mobil Track air and heaters (two to five), Heavy Equipment Greaser, Relief Operator, Assistant Master Mechanic and Heavy Duty Mechanic, all Operators (except those listed below).

GROUP II. Assistant Operators.

GROUP III. Air Compressors (One), Water Pumps, regardless of Size (One), Waterblasters (one), Welding Machine (One), Mixers (One Bag), Conveyor (One), Siphon or Jet (One), Light Plant (One), Heater (One), Immobile Track Air (One), and Self Propelled Walk-Behind Rollers.

GROUP IV. Asphalt Spreader Oilers, Fireman on Whirlies and Heavy Equipment Oilers, Truck Cranes, Dredges, Monigans, Large Cranes - (Over 65-ton rated capacity) Concrete Plant Oiler, Blacktop Plant Oiler, and Creter Crane Oiler (when required).

GROUP V. Oiler.

GROUP VI. Master Mechanics, Operators on equipment with Booms, including jibs, 100 feet and over, and less than 150 feet long.

GROUP VII. Operators on equipment with Booms, including jibs, 150 feet and over, and less than 200 feet long.

GROUP VIII. Operators on Equipment with Booms, including jibs, 200 feet and over; Tower Cranes; Whirlie Cranes; and Operator Foreman.

Other Classifications of Work:

For definitions of classifications not otherwise set out, the Department generally has on file such definitions which are available. If a task to be performed is not subject to one of the classifications of pay set out, the Department will upon being contacted state which neighboring county has such a classification and provide such rate, such rate being deemed to exist by reference in this document. If no neighboring county rate applies to the task, the Department shall undertake a special determination, such special determination being then deemed to have existed under this determination. If a project requires these, or any classification not listed, please contact IDOL at 618/993-7271 for wage rates or clarifications.

#### LANDSCAPING

Landscaping work falls under the existing classifications for laborer, operating engineer and truck driver. The work performed by landscape plantsman and landscape laborer is covered by the existing classification of laborer. The work performed by landscape operators (regardless of equipment used or its size) is covered by the classifications of operating engineer. The work performed by landscape truck drivers (regardless of size of truck driven) is covered by the classifications of truck driver.

# Grundy County Prevailing Wage for April 2007

Trade Name	RG	TYP	C	Base	FRMAN	*M-F>8	OSA	OSH	H/W	Pensn	Vac	Trng
=====	==	===	=	=====	=====	=====	===	===	=====	=====	=====	=====
ASBESTOS ABT-GEN		ALL		31.550	32.300	1.5	1.5	2.0	7.460	4.840	0.000	0.170
ASBESTOS ABT-MEC		BLD		23.300	24.800	1.5	1.5	2.0	7.860	4.910	0.000	0.000
BOILERMAKER		BLD		38.540	42.000	2.0	2.0	2.0	6.720	7.440	0.000	0.300
BRICK MASON		BLD		34.850	38.340	1.5	1.5	2.0	7.050	7.870	0.000	0.380
CARPENTER		ALL		35.320	38.850	1.5	1.5	2.0	6.760	5.320	0.000	0.490
CEMENT MASON		ALL		35.500	37.500	2.0	2.0	2.0	6.400	8.830	0.000	0.100
CERAMIC TILE FNSHER		BLD		28.520	0.000	2.0	1.5	2.0	5.650	5.750	0.000	0.330
COMMUNICATION TECH		BLD		30.110	31.610	1.5	1.5	2.0	8.270	8.700	0.000	0.300
ELECTRIC PWR EQMT OP		ALL		36.050	42.000	1.5	1.5	2.0	7.870	9.730	0.000	0.270
ELECTRIC PWR GRNDMAN		ALL		28.120	42.000	1.5	1.5	2.0	6.140	7.600	0.000	0.210
ELECTRIC PWR LINEMAN		ALL		36.050	42.000	1.5	1.5	2.0	7.870	9.730	0.000	0.270
ELECTRICIAN		BLD		35.500	38.700	1.5	1.5	2.0	8.570	11.06	0.000	0.360
ELEVATOR CONSTRUCTOR		BLD		34.190	38.460	2.0	2.0	2.0	8.275	6.060	2.050	0.000
GLAZIER		BLD		31.400	32.400	1.5	2.0	2.0	6.490	9.050	0.000	0.500
HT/FROST INSULATOR		BLD		33.300	35.050	1.5	1.5	2.0	7.860	8.610	0.000	0.310
IRON WORKER		ALL		32.000	33.000	2.0	2.0	2.0	8.040	13.92	0.000	0.550
LABORER		ALL		31.550	32.300	1.5	1.5	2.0	7.460	4.840	0.000	0.170
LATHER		ALL		35.320	38.850	1.5	1.5	2.0	6.760	5.320	0.000	0.490
MACHINIST		BLD		36.890	38.890	2.0	2.0	2.0	4.380	5.650	2.550	0.000
MARBLE FINISHERS		ALL		25.750	0.000	1.5	1.5	2.0	6.070	7.020	0.000	0.580
MARBLE MASON		BLD		34.850	38.340	1.5	1.5	2.0	7.050	7.870	0.000	0.490
MATERIAL TESTER 1		ALL		21.550	0.000	1.5	1.5	2.0	7.460	4.840	0.000	0.170
MATERIALS TESTER II		ALL		26.550	0.000	1.5	1.5	2.0	7.460	4.840	0.000	0.170
MILLWRIGHT		ALL		35.320	38.850	1.5	1.5	2.0	6.760	5.320	0.000	0.490
OPERATING ENGINEER		BLD	1	41.550	45.550	2.0	2.0	2.0	6.850	5.600	1.900	0.700
OPERATING ENGINEER		BLD	2	40.250	45.550	2.0	2.0	2.0	6.850	5.600	1.900	0.700
OPERATING ENGINEER		BLD	3	37.700	45.550	2.0	2.0	2.0	6.850	5.600	1.900	0.700
OPERATING ENGINEER		BLD	4	35.950	45.550	2.0	2.0	2.0	6.850	5.600	1.900	0.700
OPERATING ENGINEER		HWY	1	39.750	43.750	1.5	1.5	2.0	6.850	5.600	1.900	0.700
OPERATING ENGINEER		HWY	2	39.200	43.750	1.5	1.5	2.0	6.850	5.600	1.900	0.700
OPERATING ENGINEER		HWY	3	37.150	43.750	1.5	1.5	2.0	6.850	5.600	1.900	0.700
OPERATING ENGINEER		HWY	4	35.750	43.750	1.5	1.5	2.0	6.850	5.600	1.900	0.700
OPERATING ENGINEER		HWY	5	34.550	43.750	1.5	1.5	2.0	6.850	5.600	1.900	0.700
PAINTER		ALL		34.400	38.700	1.5	1.5	2.0	6.200	6.400	0.000	0.390
PAINTER SIGNS		BLD		28.970	32.520	1.5	1.5	1.5	2.600	2.310	0.000	0.000
PILEDRIVER		ALL		35.320	38.850	1.5	1.5	2.0	6.760	5.320	0.000	0.490
PIPEFITTER		BLD		37.600	39.600	1.5	1.5	2.0	8.660	6.900	0.000	0.940
PLASTERER		BLD		33.850	35.350	1.5	1.5	2.0	6.740	7.100	0.000	0.400
PLUMBER	E	BLD		37.500	39.500	1.5	1.5	2.0	7.050	8.500	0.000	0.760
PLUMBER	W	BLD		37.500	39.500	1.5	1.5	2.0	7.050	8.500	0.000	0.760
ROOFER		BLD		26.560	27.560	1.5	1.5	2.0	6.460	3.310	0.000	0.330
SHEETMETAL WORKER		BLD		36.510	38.510	1.5	1.5	2.0	6.890	8.020	0.000	0.640
SIGN HANGER		ALL		22.990	25.290	1.5	1.5	2.0	3.790	2.500	0.000	0.000
SPRINKLER FITTER		BLD		38.500	40.500	1.5	1.5	2.0	8.250	6.100	0.000	0.500
STONE MASON		BLD		33.250	36.580	1.5	1.5	2.0	6.450	7.020	0.000	0.440
TERRAZZO FINISHER		BLD		29.290	0.000	1.5	1.5	2.0	5.650	6.940	0.000	0.270
TERRAZZO MASON		BLD		33.650	36.650	1.5	1.5	2.0	5.650	8.610	0.000	0.300
TILE MASON		BLD		34.600	38.600	2.0	1.5	2.0	5.650	7.000	0.000	0.460
TRUCK DRIVER		ALL	1	33.040	33.590	1.5	1.5	2.0	5.500	3.875	0.000	0.000
TRUCK DRIVER		ALL	2	33.190	33.590	1.5	1.5	2.0	5.500	3.875	0.000	0.000
TRUCK DRIVER		ALL	3	33.390	33.590	1.5	1.5	2.0	5.500	3.875	0.000	0.000
TRUCK DRIVER		ALL	4	33.590	33.590	1.5	1.5	2.0	5.500	3.875	0.000	0.000
TUCKPOINTER		BLD		34.500	35.500	1.5	1.5	2.0	4.710	6.340	0.000	0.400

Legend:

M-F>8 (Overtime is required for any hour greater than 8 worked each day, Monday through Friday.)

OSA (Overtime is required for every hour worked on Saturday)

OSH (Overtime is required for every hour worked on Sunday and Holidays)

H/W (Health & Welfare Insurance)

Pensn (Pension)

Vac (Vacation)

Trng (Training)

## Explanations

### GRUNDY COUNTY

PLUMBERS & PIPEFITTERS (WEST) - That part of the county West of Rt. 47 excluding the City of Morris.

The following list is considered as those days for which holiday rates of wages for work performed apply: New Years Day, Memorial/Decoration Day, Fourth of July, Labor Day, Veterans Day, Thanksgiving Day, Christmas Day. Generally, any of these holidays which fall on a Sunday is celebrated on the following Monday. This then makes work performed on that Monday payable at the appropriate overtime rate for holiday pay. Common practice in a given local may alter certain days of celebration such as the day after Thanksgiving for Veterans Day. If in doubt, please check with IDOL.

### EXPLANATION OF CLASSES

ASBESTOS - GENERAL - removal of asbestos material/mold and hazardous materials from any place in a building, including mechanical systems where those mechanical systems are to be removed. This includes the removal of asbestos materials/mold and hazardous materials from ductwork or pipes in a building when the building is to be demolished at the time or at some close future date.

ASBESTOS - MECHANICAL - removal of asbestos material from mechanical systems, such as pipes, ducts, and boilers, where the mechanical systems are to remain.

### CERAMIC TILE FINISHER

The grouting, cleaning, and polishing of all classes of tile, whether for interior or exterior purposes, all burned, glazed or unglazed products; all composition materials, granite tiles, warning detectable tiles, cement tiles, epoxy composite materials, pavers, glass, mosaics, fiberglass, and all substitute materials, for tile made in tile-like units; all mixtures in tile like form of cement, metals, and other materials that are for and intended for use as a finished floor surface, stair treads, promenade roofs, walks, walls, ceilings, swimming pools, and all other places where tile is to form a finished interior or exterior. The mixing of all setting mortars including but not limited to thin-set mortars, epoxies, wall mud, and any other sand and cement mixtures or adhesives when used in the preparation, installation, repair, or maintenance of tile and/or similar materials. The handling and unloading of all sand, cement, lime, tile, fixtures, equipment, adhesives, or any other materials to be used in

the preparation, installation, repair, or maintenance of tile and/or similar materials. Ceramic Tile Finishers shall fill all joints and voids regardless of method on all tile work, particularly and especially after installation of said tile work. Application of any and all protective coverings to all types of tile installations including, but not be limited to, all soap compounds, paper products, tapes, and all polyethylene coverings, plywood, masonite, cardboard, and any new type of products that may be used to protect tile installations, Blastrac equipment, and all floor scarifying equipment used in preparing floors to receive tile. The clean up and removal of all waste and materials. All demolition of existing tile floors and walls to be re-tiled.

#### COMMUNICATIONS TECHNICIAN

Installation, operation, inspection, maintenance, repair and service of radio, television, recording, voice, sound and vision production and reproduction, telephone and telephone interconnect, facsimile, equipment and appliances used for domestic, commercial, educational and entertainment purposes, pulling of wire through conduit but not the installation of conduit.

#### MARBLE FINISHER

Loading and unloading trucks, distribution of all materials (all stone, sand, etc.), stocking of floors with material, performing all rigging for heavy work, the handling of all material that may be needed for the installation of such materials, building of scaffolding, polishing if needed, patching, waxing of material if damaged, pointing up, caulking, grouting and cleaning of marble, holding water on diamond or Carborundum blade or saw for setters cutting, use of tub saw or any other saw needed for preparation of material, drilling of holes for wires that anchor material set by setters, mixing up of molding plaster for installation of material, mixing up thin set for the installation of material, mixing up of sand to cement for the installation of material and such other work as may be required in helping a Marble Setter in the handling of all material in the erection or installation of interior marble, slate, travertine, art marble, serpentine, alberene stone, blue stone, granite and other stones (meaning as to stone any foreign or domestic materials as are specified and used in building interiors and exteriors and customarily known as stone in the trade), carrara, sanionyx, vitrolite and similar opaque glass and the laying of all marble tile, terrazzo tile, slate tile and precast tile, steps, risers treads, base, or any other materials that may be used as substitutes for any of the aforementioned materials and which are used on interior and exterior which are installed in a similar manner.

MATERIAL TESTER I: Hand coring and drilling for testing of materials; field inspection of uncured concrete and asphalt.

MATERIAL TESTER II: Field inspection of welds, structural steel, fireproofing, masonry, soil, facade, reinforcing steel, formwork, cured concrete, and concrete and asphalt batch plants; adjusting proportions of bituminous mixtures.

#### TRUCK DRIVER - BUILDING, HEAVY AND HIGHWAY CONSTRUCTION

Class 1. Two or three Axle Trucks. A-frame Truck when used for transportation purposes; Air Compressors and Welding Machines, including those pulled by cars, pick-up trucks and tractors; Ambulances; Batch Gate Lockers; Batch Hopperman; Car and Truck Washers; Carry-alls; Fork Lifts and Hoisters; Helpers; Mechanics Helpers and Greasers; Oil Distributors 2-man operation; Pavement

Breakers; Pole Trailer, up to 40 feet; Power Mower Tractors; Self-propelled Chip Spreader; Skipman; Slurry Trucks, 2-man operation; Slurry Truck Conveyor Operation, 2 or 3 man; Teamsters Unskilled dumpman; and Truck Drivers hauling warning lights, barricades, and portable toilets on the job site.

Class 2. Four axle trucks; Dump Crets and Adgetors under 7 yards; Dumpsters, Track Trucks, Euclids, Hug Bottom Dump Turnapulls or Turnatrailers when pulling other than self-loading equipment or similar equipment under 16 cubic yards; Mixer Trucks under 7 yards; Ready-mix Plant Hopper Operator, and Winch Trucks, 2 Axles.

Class 3. Five axle trucks; Dump Crets and Adgetors 7 yards and over; Dumpsters, Track Trucks, Euclids, Hug Bottom Dump Turnatrailers or turnapulls when pulling other than self-loading equipment or similar equipment over 16 cubic yards; Explosives and/or Fission Material Trucks; Mixer Trucks 7 yards or over; Mobile Cranes while in transit; Oil Distributors, 1-man operation; Pole Trailer, over 40 feet; Pole and Expandable Trailers hauling material over 50 feet long; Slurry trucks, 1-man operation; Winch trucks, 3 axles or more; Mechanic--Truck Welder and Truck Painter.

Class 4. Six axle trucks; Dual-purpose vehicles, such as mounted crane trucks with hoist and accessories; Foreman; Master Mechanic; Self-loading equipment like P.B. and trucks with scoops on the front.

#### OPERATING ENGINEERS - BUILDING

Class 1. Mechanic; Asphalt Plant; Asphalt Spreader; Autograde; Backhoes with Caisson attachment; Batch Plant; Benoto; Boiler and Throttle Valve; Caisson Rigs; Central Redi-Mix Plant; Combination Back Hoe Front End-loader Machine; Compressor and Throttle Valve; Concrete Breaker (Truck Mounted); Concrete Conveyor; Concrete Paver; Concrete Placer; Concrete Placing Boom; Concrete Pump (Truck Mounted); Concrete Tower; Cranes, All; Cranes, Hammerhead; Cranes, (GCI and similar Type); Creter Crane; Crusher, Stone, etc.; Derricks, All; Derricks, Traveling; Formless Curb and Gutter Machine; Grader, Elevating; Grouting Machines; Highlift Shovels or Front Endloader 2-1/4 yd. and over; Hoists, Elevators, outside type rack and pinion and similar machines; Hoists, one, two and three Drum; Hoists, Two Tugger One Floor; Hydraulic Backhoes; Hydraulic Boom Trucks; Hydro Vac (and similar equipment); Locomotives, All; Motor Patrol; Pile Drivers and Skid Rig; Post Hole Digger; Pre-Stress Machine; Pump Cretes Dual Ram; Pump Cretes; Squeeze Cretes-screw Type Pumps; Raised and Blind Hole Drill; Roto Mill Grinder; Scoops - Tractor Drawn; Slip-form Paver; Straddle Buggies; Tournapull; Tractor with Boom and Side Boom; Trenching Machines.

Class 2. Boilers; Broom, All Power Propelled; Bulldozers; Concrete Mixer (Two Bag and Over); Conveyor, Portable; Forklift Trucks; Greaser Engineer; Highlift Shovels or Front Endloaders under 2-1/4 yd.; Hoists, Automatic; Hoists, inside Freight Elevators; Hoists, Sewer Dragging Machine; Hoists, Tugger Single Drum; Laser Screed; Rock Drill (self-propelled); Rock Drill (truck mounted); Rollers, All; Steam Generators; Tractors, All; Tractor Drawn Vibratory Roller; Winch Trucks with "A" Frame.

Class 3. Air Compressor; Combination - Small Equipment Operator; Generators; Heaters, Mechanical; Hoists, Inside Elevators - (Rheostat Manual Controlled); Hydraulic Power Units (Pile Driving, Extracting, and Drilling); Pumps, over 3" (1 to 3 not to exceed a total of 300 ft.); Pumps, Well Points; Welding Machines (2 through 5); Winches, 4 small Electric Drill Winches; Bobcat (up to and including 3/4 cu.

yd.).

Class 4. Bobcats and/or other Skid Steer Loaders; Oilers; and Brick Forklift.

#### OPERATING ENGINEERS - HEAVY AND HIGHWAY CONSTRUCTION

Class 1. Craft Foreman; Asphalt Plant; Asphalt Heater and Planer Combination; Asphalt Heater Scarfire; Asphalt Spreader; Autograder/GOMACO or other similar type machines; ABG Paver; Backhoes with Caisson attachment; Ballast Regulator; Belt Loader; Caisson Rigs; Car Dumper; Central Redi-Mix Plant; Combination Backhoe Front Endloader Machine, (1 cu. yd. Backhoe Bucket or over or with attachments); Concrete Breaker (Truck Mounted); Concrete Conveyor; Concrete Paver over 27E cu. ft.; Concrete Placer; Concrete Tube Float; Cranes, all attachments; Cranes, Hammerhead, Linden, Peco & Machines of a like nature; Crete Crane; Crusher, Stone, etc.; Derricks, All; Derrick Boats; Derricks, Traveling; Dowell machine with Air Compressor; Dredges; Field Mechanic-Welder; Formless Curb and Gutter Machine; Gradall and Machines of a like nature; Grader, Elevating; Grader, Motor Grader, Motor Patrol, Auto Patrol, Form Grader, Pull Grader, Subgrader; Guard Rail Post Driver Mounted; Hoists, One, Two and Three Drum; Hydraulic Backhoes; Backhoes with shear attachments; Mucking Machine; Pile Drivers and Skid Rig; Pre-Stress Machine; Pump Cretes Dual Ram; Rock Drill - Crawler or Skid Rig; Rock Drill - Truck Mounted; Roto Mill Grinder; Slip-Form Paver; Soil Test Drill Rig (Truck Mounted); Straddle Buggies; Hydraulic Telescoping Form (Tunnel); Tractor Drawn Belt Loader (with attached pusher - two engineers); Tractor with Boom; Tractaire with Attachments; Trenching Machine; Truck Mounted Concrete Pump with Boom; Raised or Blind Hole; Drills (Tunnel Shaft); Underground Boring and/or Mining Machines; Wheel Excavator; Widener (APSCO).

Class 2. Batch Plant; Bituminous Mixer; Boiler and Throttle Valve; Bulldozers; Car Loader Trailing Conveyors; Combination Backhoe Front Endloader Machine (less than 1 cu. yd. Backhoe Bucket or over or with attachments); Compressor and Throttle Valve; Compressor, Common Receiver (3); Concrete Breaker or Hydro Hammer; Concrete Grinding Machine; Concrete Mixer or Paver 7S Series to and including 27 cu. ft.; Concrete Spreader; Concrete Curing Machine, Burlap Machine, Belting Machine and Sealing Machine; Concrete Wheel Saw; Conveyor Muck Cars (Haglund or Similar Type); Drills, All; Finishing Machine - Concrete; Greaser Engineer; Highlift Shovels or Front Endloader; Hoist - Sewer Dragging Machine; Hydraulic Boom Trucks (All Attachments); Hydro-Blaster; All Locomotives, Dinky; Pump Cretes; Squeeze Cretes-Screw Type Pumps, Gypsum Bulker and Pump; Roller, Asphalt; Rotary Snow Plows; Rototiller, Seaman, etc., self-propelled; Scoops - Tractor Drawn; Self-Propelled Compactor; Spreader - Chip - Stone, etc.; Scraper; Scraper - Prime Mover in Tandem (Regardless of Size); Tank Car Heater; Tractors, Push, Pulling Sheeps Foot, Disc, Compactor, etc.; Tug Boats.

Class 3. Boilers; Brooms, All Power Propelled; Cement Supply Tender; Compressor, Common Receiver (2); Concrete Mixer (Two Bag and Over); Conveyor, Portable; Farm-Type Tractors Used for Mowing, Seeding, etc.; Fireman on Boilers; Forklift Trucks; Grouting Machine; Hoists, Automatic; Hoists, All Elevators; Hoists, Tugger Single Drum; Jeep Diggers; Pipe Jacking Machines; Post-Hole Digger; Power Saw, Concrete Power Driven; Pug Mills; Rollers, other than asphalt; Seed and Straw Blower; Steam Generators; Stump Machine; Winch Trucks with "A" Frame; Work Boats; Tamper - Form-Motor Driven.

Class 4. Air Compressor; Combination - Small Equipment Operator;



Directional Boring Machine; Generators; Heaters, Mechanical; Hydraulic Power Unit (Pile Driving, Extracting, or Drilling); Hydro-Blaster; Light Plants, All (1 through 5); Pumps, over 3" (1 to 3 not to exceed a total of 300 ft.); Pumps, Well Points; Tractaire; Welding Machines (2 through 5); Winches, 4 Small Electric Drill Winches.

Class 5. Bobcats (all); Brick Forklifts; Oilers.

#### TERRAZZO FINISHER

The handling of sand, cement, marble chips, and all other materials that may be used by the Mosaic Terrazzo Mechanic, and the mixing, grinding, grouting, cleaning and sealing of all Marble, Mosaic, and Terrazzo work, floors, base, stairs, and wainscoting by hand or machine, and in addition, assisting and aiding Marble, Masonic, and Terrazzo Mechanics.

#### Other Classifications of Work:

For definitions of classifications not otherwise set out, the Department generally has on file such definitions which are available. If a task to be performed is not subject to one of the classifications of pay set out, the Department will upon being contacted state which neighboring county has such a classification and provide such rate, such rate being deemed to exist by reference in this document. If no neighboring county rate applies to the task, the Department shall undertake a special determination, such special determination being then deemed to have existed under this determination. If a project requires these, or any classification not listed, please contact IDOL at 618/993-7271 for wage rates or clarifications.

#### LANDSCAPING

Landscaping work falls under the existing classifications for laborer, operating engineer and truck driver. The work performed by landscape plantsman and landscape laborer is covered by the existing classification of laborer. The work performed by landscape operators (regardless of equipment used or its size) is covered by the classifications of operating engineer. The work performed by landscape truck drivers (regardless of size of truck driven) is covered by the classifications of truck driver.

# Hamilton County Prevailing Wage for April 2007

Trade Name	RG	TYP	C	Base	FRMAN	*M-F>8	OSA	OSH	H/W	Pensn	Vac	Trng
=====	==	==	=	=====	=====	=====	==	==	=====	=====	=====	=====
ASBESTOS ABT-GEN		ALL		20.750	21.200	1.5	1.5	2.0	5.250	5.600	0.000	0.700
ASBESTOS ABT-MEC		BLD		20.800	0.000	2.0	2.0	2.0	5.000	3.400	0.000	0.000
BOILERMAKER		BLD		28.500	31.000	1.5	1.5	2.0	6.820	11.03	0.000	0.300
BRICK MASON		BLD		25.470	26.970	1.5	1.5	2.0	6.000	5.400	0.000	0.425
CARPENTER		BLD		27.780	29.280	1.5	1.5	2.0	5.050	3.750	0.000	0.350
CARPENTER		HWY		27.730	29.480	1.5	1.5	2.0	5.050	3.750	0.000	0.350
CEMENT MASON		BLD		23.500	24.500	1.5	1.5	2.0	5.200	3.550	0.000	0.100
CEMENT MASON		HWY		23.500	25.000	1.5	1.5	2.0	5.200	2.750	0.000	0.200
CERAMIC TILE FNSHER		BLD		24.990	0.000	1.5	1.5	2.0	6.000	5.400	0.000	0.425
ELECTRICIAN		ALL		32.910	35.160	1.5	1.5	2.0	5.150	6.580	0.000	0.490
ELECTRONIC SYS TECH		BLD		25.700	27.200	1.5	1.5	2.0	5.150	3.340	0.000	0.250
FLOOR LAYER		BLD		26.930	27.680	1.5	1.5	2.0	5.000	3.750	0.000	0.350
GLAZIER		BLD		22.930	0.000	1.5	1.5	2.0	4.320	3.800	0.000	0.300
HT/FROST INSULATOR		BLD		26.110	27.110	1.5	1.5	2.0	4.800	6.860	0.000	0.190
IRON WORKER		ALL		24.000	25.250	1.5	1.5	2.0	5.780	6.850	0.000	0.345
LABORER		BLD		20.750	21.200	1.5	1.5	2.0	5.250	5.600	0.000	0.600
LABORER		HWY		21.000	21.450	1.5	1.5	2.0	5.350	6.150	0.000	0.600
LABORER		O&C		15.750	16.200	1.5	1.5	2.0	5.350	6.150	0.000	0.600
MACHINIST		BLD		36.890	38.890	2.0	2.0	2.0	4.380	5.650	2.550	0.000
MARBLE FINISHERS		BLD		24.990	0.000	1.5	1.5	2.0	6.000	5.400	0.000	0.425
MARBLE MASON		BLD		25.470	26.970	1.5	1.5	2.0	6.000	5.400	0.000	0.425
MILLWRIGHT		BLD		27.780	29.280	1.5	1.5	2.0	5.050	3.750	0.000	0.350
MILLWRIGHT		HWY		28.230	29.980	1.5	1.5	2.0	5.050	3.750	0.000	0.350
OE RIVER 1		RIV	1	26.900	0.000	1.5	1.5	2.0	5.650	6.100	0.000	1.100
OE RIVER 2		RIV	2	23.450	0.000	1.5	1.5	2.0	5.650	6.100	0.000	1.100
OPERATING ENGINEER		ALL	1	26.800	27.800	1.5	1.5	2.0	5.650	6.100	0.000	1.100
OPERATING ENGINEER		ALL	2	24.900	27.800	1.5	1.5	2.0	5.650	6.100	0.000	1.100
OPERATING ENGINEER		ALL	3	24.150	27.800	1.5	1.5	2.0	5.650	6.100	0.000	1.100
OPERATING ENGINEER		ALL	4	21.400	27.800	1.5	1.5	2.0	5.650	6.100	0.000	1.100
OPERATING ENGINEER		O&C	1	20.100	21.100	1.5	1.5	2.0	5.650	6.100	0.000	1.100
OPERATING ENGINEER		O&C	2	18.680	21.100	1.5	1.5	2.0	5.650	6.100	0.000	1.100
OPERATING ENGINEER		O&C	3	18.120	21.100	1.5	1.5	2.0	5.650	6.100	0.000	1.100
OPERATING ENGINEER		O&C	4	16.050	21.100	1.5	1.5	2.0	5.650	6.100	0.000	1.100
PAINTER		ALL		20.700	21.200	1.5	1.5	2.0	4.650	4.200	0.000	0.250
PAINTER OVER 30FT		ALL		23.800	24.300	1.5	1.5	2.0	4.650	4.200	0.000	0.250
PAINTER PWR EQMT		ALL		23.800	24.300	1.5	1.5	2.0	4.650	4.200	0.000	0.250
PILEDRIVER		BLD		27.780	29.280	1.5	1.5	2.0	5.050	3.750	0.000	0.350
PILEDRIVER		HWY		28.230	29.980	1.5	1.5	2.0	5.050	3.750	0.000	0.350
PIPEFITTER		BLD		28.750	31.620	1.5	1.5	2.0	6.000	7.500	0.000	0.400
PLASTERER		BLD		23.500	24.500	1.5	1.5	2.0	5.200	3.550	0.000	0.100
PLUMBER		BLD		29.500	32.450	1.5	1.5	2.0	6.600	7.500	0.000	0.550
ROOFER		BLD		19.700	20.500	1.5	1.5	2.0	5.700	3.800	0.000	0.000
SHEETMETAL WORKER		ALL		27.210	28.460	1.5	1.5	2.0	6.000	4.770	1.630	0.120
SPRINKLER FITTER		BLD		31.240	33.240	1.5	1.5	2.0	6.500	5.350	0.000	0.250
STONE MASON		BLD		25.470	26.970	1.5	1.5	2.0	6.000	5.400	0.000	0.425
TERRAZZO FINISHER		BLD		24.990	0.000	1.5	1.5	2.0	6.000	5.400	0.000	0.425
TERRAZZO MASON		BLD		28.500	28.800	1.5	1.5	2.0	0.000	2.950	0.000	0.000
TRUCK DRIVER		ALL	1	24.990	0.000	1.5	1.5	2.0	7.250	4.200	0.000	0.000
TRUCK DRIVER		ALL	2	25.390	0.000	1.5	1.5	2.0	7.250	4.200	0.000	0.000
TRUCK DRIVER		ALL	3	25.590	0.000	1.5	1.5	2.0	7.250	4.200	0.000	0.000
TRUCK DRIVER		ALL	4	25.840	0.000	1.5	1.5	2.0	7.250	4.200	0.000	0.000
TRUCK DRIVER		ALL	5	26.590	0.000	1.5	1.5	2.0	7.250	4.200	0.000	0.000
TRUCK DRIVER		O&C	1	19.500	0.000	1.5	1.5	2.0	4.275	4.670	0.000	0.000
TRUCK DRIVER		O&C	2	15.900	0.000	1.5	1.5	2.0	4.275	4.670	0.000	0.000
TRUCK DRIVER		O&C	3	16.400	0.000	1.5	1.5	2.0	4.275	4.670	0.000	0.000
TUCKPOINTER		BLD		25.470	26.970	1.5	1.5	2.0	6.000	5.400	0.000	0.425

Legend:

M-F>8 (Overtime is required for any hour greater than 8 worked each day, Monday through Friday.)

OSA (Overtime is required for every hour worked on Saturday)

OSH (Overtime is required for every hour worked on Sunday and Holidays)

H/W (Health & Welfare Insurance)

Pensn (Pension)

Vac (Vacation)

Trng (Training)

## Explanations

### HAMILTON COUNTY

The following list is considered as those days for which holiday rates of wages for work performed apply: New Years Day, Memorial/Decoration Day, Fourth of July, Labor Day, Veterans Day, Thanksgiving Day, Christmas Day. Generally, any of these holidays which fall on a Sunday is celebrated on the following Monday. This then makes work performed on that Monday payable at the appropriate overtime rate for holiday pay. Common practice in a given local may alter certain days of celebration such as the day after Thanksgiving for Veterans Day. If in doubt, please check with IDOL.

Oil and chip resealing (O&C) means the application of road oils and liquid asphalt to coat an existing road surface, followed by application of aggregate chips or gravel to coated surface, and subsequent rolling of material to seal the surface.

### EXPLANATION OF CLASSES

ASBESTOS - GENERAL - removal of asbestos material/mold and hazardous materials from any place in a building, including mechanical systems where those mechanical systems are to be removed. This includes the removal of asbestos materials/mold and hazardous materials from ductwork or pipes in a building when the building is to be demolished at the time or at some close future date.

ASBESTOS - MECHANICAL - removal of asbestos material from mechanical systems, such as pipes, ducts, and boilers, where the mechanical systems are to remain.

### CERAMIC TILE FINISHER, MARBLE FINISHER, TERRAZZO FINISHER

Assisting, helping or supporting the tile, marble and terrazzo mechanic by performing their historic and traditional work assignments required to complete the proper installation of the work covered by said crafts. The term "Ceramic" is used for naming the classification only, and is in no a limitation of the product handled. Ceramic takes into consideration most hard tiles.

### LABORER - OIL AND CHIP RESEALING ONLY

Hook and unhook chip box from aggregate truck; distribute material

within chip box; perform flagging work related to oil and chip resealing; hand spray oil fluids; handle traffic control, including setting-up and maintaining barricades, drums, cones, delineators, signs and other such items, as well as laying-out and applying or removing temporary roadway markings used to control traffic in job site related to oil and chip resealing; and perform clean-up related to oil and chip resealing.

#### ELECTRONIC SYSTEMS TECHNICIAN

Installation, service and maintenance of low-voltage systems which utilizes the transmission and/or transference of voice, sound, vision, or digital for commercial, education, security and entertainment purposes for the following: TV monitoring and surveillance, background/foreground music, intercom and telephone interconnect, field programming, inventory control systems, microwave transmission, multi-media, multiplex, radio page, school, intercom and sound burglar alarms and low voltage master clock systems.

Excluded from this classification are energy management systems, life safety systems, supervisory controls and data acquisition systems not intrinsic with the above listed systems, fire alarm systems, nurse call systems and raceways exceeding fifteen feet in length.

#### TRUCK DRIVER - BUILDING, HEAVY AND HIGHWAY CONSTRUCTION

Class 1. Drivers on 2 axle trucks hauling less than 9 ton. Air compressor and welding machines and brooms, including those pulled by separate units, truck driver helpers, warehouse employees, mechanic helpers, greasers and tiremen, pickup trucks when hauling materials, tools, or workers to and from and on-the-job site, and fork lifts up to 6,000 lb. capacity.

Class 2. Two or three axle trucks hauling more than 9 ton but hauling less than 16 ton. A-frame winch trucks, hydrolift trucks, vector trucks or similar equipment when used for transportation purposes. Fork lifts over 6,000 lb. capacity, winch trucks, four axle combination units, and ticket writers.

Class 3. Two, three or four axle trucks hauling 16 ton or more. Drivers on water pulls, articulated dump trucks, mechanics and working forepersons, and dispatchers. Five axle or more combination units.

Class 4. Low Boy and Oil Distributors.

Class 5. Drivers who require special protective clothing while employed on hazardous waste work.

#### TRUCK DRIVER - O & C (Oil and Chip Resealing ONLY)

It involves driving of contractor or subcontractor owned, leased, or hired pickup, dump, service, or oil distributor trucks. Includes transporting materials and equipment (including, but not limited to oils, aggregate supplies, parts, machinery and tools) to or from the job site; distributing oil or liquid asphalt and aggregate; stock piling material; and maintaining trucks at job site related to oil and chip resealing.

Class 1. Distributors, liquid asphalt hauling and hauling of asphalt rubber-tired rollers.

Class 2. Stockpiling.

Class 3. Tandem hauling to job site.

OPERATING ENGINEERS - BUILDING, HEAVY AND HIGHWAY CONSTRUCTION

Class 1. APSCO or Equal Spreading Machine, Backhoe, Backfiller, Boom or Winch Cat, Bituminous Mixplane Machine, Blacksmith, Bituminous Surfacing Machine, Bull-Dozer, Crane, Shovel, Dragline, Truck Crane, Pile Driver, Concrete Breaker, Concrete or Pumpcrete Pumps, Dinky or Standard Locomotives, Well or Caisson Drills, Elevating Grader, Fork Lifts, Flexplane, Gradeall, Hi-Lift Hoists, Guy-Derricks, Hysters, Mechanic Motor Patrol, Mixers-21 cu. ft. or over, Push Cats, Pulls and Scrapers, Two Well Point Pumps, Pulverizer or Tiller, PugMill, Rubber-Tired Farm Type Tractor with Bulldozer/Blade/Auger or hi-lift over 1/2 yd., Jersey Spreader, Tract-Air used with Drill or Hi-Lift, Trenching or Ditching Machines, Wood Chipper w/Tractor, Self-Propelled Roller w/Blade, Equipment Greaser, Self-Propelled Bump Grinder on Concrete pavement, Boat Operator, Skid-Loaders, Tuggers, Lazer Screed, and Self-Propelled Chip Spreader (when others run conveyors).

Class 2. Any type tractor pulling any type roller or disc, Two Air Compressors (220 cu. ft. capacity or over), Two AirTract Drills, Air-Track Drill w/Compressor, Automatic Bins or Scales w/Compressor or Generator, Pipeline Boring Machine, Bulk Cement Plant w/Separate Compressor, Power Operated Bull Float, Hydra-Lift w/Single Motor, Straw Mulcher Blower w/Spout, Self-Propelled Roller/Compactor, Back-End man on Bituminous Surfacing Machine, oiler on milling machine.

Class 3. Air Compressor w/Valve driving piling, Boom or Winch Type Truck, Two Conveyors, Self-Propelled Concrete Saw, Form Grader, Truck Crane Oiler, Self-Propelled Vibrator, Rubber Tired Farm Type Tractor w/Blade/Bulldozer/Auger/hi-lift - 1/2 yd. or less, Elevator Operator, Man Lift (scissor lift) when lifting materials.

Class 4. Air-Track Drill (one), Belt Drag Machine, Power Broom, Mechanical Plasterer Applicator, Trac-Air, Air Compressor (220 cu. ft. or over) One, Air Compressor (under 220 cu. ft) four, Automatic Bin, Bulk Cement Plant w/Built-in Compressor running off same motor or electric motor, Fireman or Switchman, Self-Propelled Form Tamper, Light Plants (4), Welding Machines (4), Pumps (4), or Combination of four (4) Pumps, Light Plants, Welding Machines, Air-Compressors (under 220 cu. ft.), Mudjacks or Wood Chipper, Mixers - less than 21 cu. ft. Mortar Mixer w/Skip or Pump, Pipeline Tract Jack. One Operating Engineer may operate and maintain any combination of the following pieces of equipment, not to exceed four (4) which shall be within a reasonable distance, such combination may include any equipment in this classification: (Compressors, Light Plants, Generators, Welding Machines, Pumps or Conveyors), One Well- Point Pump, Two Motor Driven Heaters, One Air Compressor (under 220 cu. ft.), One Engine-Driven Conveyor, One Motor Driven Heater, One Light Plant, One Pump, One Welding Machine, One Ulmac or Equal Spreader, Oilers, and one Generator 10 kw or greater.

OPERATING ENGINEER - O & C (Oil and Chip Resealing ONLY). Includes the operation of all motorized heavy equipment used in oil and chip rsealing, including but not limited to operating self-propelled chip spreaders, and all types of rollers (both hard and rubber tired); and other duties pertaining to the operation or maintenance of heavy equipment relatd to oil and chip resealing.

Class 1. See Class 1 above for types of equipment operated.

Class 2. See Class 2 above for types of equipment operated.

Class 3. See Class 3 above for types of equipment operated.

Class 4. See Class 4 above for types of equipment operated.

OPERATING ENGINEER RIVER WORK 1 - operate the following machines when working on River Work and Levee Work on the Mississippi and Ohio Rivers, Lakes and Tributaries: Crane, Shovel, Drageline, Scrapers, Dredge, Derrick, Pile-Driver, Push Boat, all power boat operators, Mechanic, Engineman on Dredge, Leverman on Dredge, All Bituminous Spreader machines, Backhoe, Backfiller, Boom, or Winch Cat, Bituminous Mixplane Machine, Blacksmith, Bituminous Surfacing Machine, Bulldozer, Truck Cranes, Hydraulic Truck Mounted Boom/Crane, Concrete Finishing Machine, or Spreader Machine, Concrete Breaker, Concrete or Pumpcrete Machines, Concrete Plant Operator, All Off Road Material Hauling Equipment, Dinky or Standard Locomotives, Well Drill, Elevating Grader, Fork-Lifts, Flexplane, Gradeall, Hi-Lift, Power Handblade Tugger type Hoist, Hoist Two Drum (or over one), Gyderrick, Hyster, Motor Patrol, Mixers - 21 Cu. Ft. or over, Push Cat, Pulls, & Scrapers, Pumps-Two Well Points, Equipment Greaser, P & H Pulverizer or Pulverizer equal to Pugmill, Pugmill, Rubber-Tired farm type tractor w/Bulldozer/Blade/Auger or Hi-Lift over ½ yard, Skimmer Scoops, Seaman Tiller, Jersey Spreader, Tract-Air used with Drill or Hi-Lift, Trenching or Ditching Machine, Wood Chipper w/Tractor, self-propelled roller w/Blade, Concrete Pumps and Small Equipment Operators.

OPERATING ENGINEER RIVER 2 - when working on River Work and Levee Work on the Mississippi and Ohio Rivers, Lakes and Tributaries shall be employed as the Oiler or Fireman on Crane, Dragline, Shovel, Dredge, Truck Crane, Pile Driver, Gradeall, Dinky or Standard Locomotive, Guy Derrick, Trenching Machine or Ditching Machine 80 H.P. and over, All Terrain (cherry-picker) with over 40 ton Lifting Capacity, Deck Oiler and Deckhands.

#### Other Classifications of Work:

For definitions of classifications not otherwise set out, the Department generally has on file such definitions which are available. If a task to be performed is not subject to one of the classifications of pay set out, the Department will upon being contacted state which neighboring county has such a classification and provide such rate, such rate being deemed to exist by reference in this document. If no neighboring county rate applies to the task, the Department shall undertake a special determination, such special determination being then deemed to have existed under this determination. If a project requires these, or any classification not listed, please contact IDOL at 618/993-7271 for wage rates or clarifications.

#### LANDSCAPING

Landscaping work falls under the existing classifications for laborer, operating engineer and truck driver. The work performed by landscape plantsman and landscape laborer is covered by the existing classification of laborer. The work performed by landscape operators (regardless of equipment used or its size) is covered by the classifications of operating engineer. The work performed by landscape truck drivers (regardless of size of truck driven) is covered by the classifications of truck driver.

# Hancock County Prevailing Wage for April 2007

Trade Name	RG	TYP	C	Base	FRMAN	*M-F>8	OSA	OSH	H/W	Pensn	Vac	Trng
=====	==	==	=	=====	=====	=====	==	==	=====	=====	=====	=====
ASBESTOS ABT-GEN		BLD		22.185	22.185	1.5	1.5	2.0	5.300	7.030	0.000	0.600
ASBESTOS ABT-GEN		HWY		21.240	21.990	1.5	1.5	2.0	5.300	7.030	0.000	0.600
ASBESTOS ABT-MEC		BLD		18.750	19.750	1.5	1.5	2.0	4.750	2.000	0.000	0.000
BOILERMAKER		BLD		30.970	33.970	2.0	2.0	2.0	8.270	7.740	0.000	0.300
BRICK MASON		BLD		24.370	25.370	1.5	1.5	2.0	6.000	5.400	0.000	0.490
CARPENTER		BLD		26.210	28.210	1.5	1.5	2.0	6.500	6.920	0.000	0.320
CARPENTER		HWY		25.350	27.100	1.5	1.5	2.0	6.500	6.920	0.000	0.300
CEMENT MASON		BLD		22.800	23.800	1.5	1.5	2.0	5.200	8.080	0.000	0.150
CEMENT MASON		HWY		24.600	25.600	1.5	1.5	2.0	5.200	4.870	0.000	0.250
CERAMIC TILE FNSHER		BLD		23.020	0.000	1.5	1.5	2.0	6.000	5.400	0.000	0.000
ELECTRIC PWR EQMT OP		ALL		30.750	0.000	1.5	1.5	2.0	4.750	8.610	0.000	0.000
ELECTRIC PWR GRNDMAN		ALL		21.090	0.000	1.5	1.5	2.0	4.750	5.905	0.000	0.000
ELECTRIC PWR LINEMAN		ALL		34.160	36.350	1.5	1.5	2.0	4.750	9.560	0.000	0.000
ELECTRIC PWR TRK DRV		ALL		22.130	0.000	1.5	1.5	2.0	4.750	6.200	0.000	0.000
ELECTRICIAN		BLD		25.290	27.290	1.5	1.5	2.0	5.150	6.460	0.000	0.250
ELECTRONIC SYS TECH		BLD		23.850	25.350	1.5	1.5	2.0	5.150	5.625	0.000	0.250
ELEVATOR CONSTRUCTOR		BLD		34.190	38.460	2.0	2.0	2.0	8.275	6.060	2.050	0.000
GLAZIER		BLD		26.320	27.070	1.5	1.5	1.5	5.650	5.750	0.000	0.350
HT/FROST INSULATOR		BLD		25.860	27.060	1.5	1.5	2.0	4.800	7.500	0.000	0.000
IRON WORKER		ALL		21.500	22.750	1.5	1.5	2.0	5.760	6.790	0.000	0.260
LABORER		BLD		22.185	22.185	1.5	1.5	2.0	5.300	7.030	0.000	0.600
LABORER		HWY		21.240	21.990	1.5	1.5	2.0	5.300	7.030	0.000	0.600
LATHER		BLD		26.210	28.210	1.5	1.5	2.0	6.500	6.920	0.000	0.320
MACHINIST		BLD		36.890	38.890	2.0	2.0	2.0	4.380	5.650	2.550	0.000
MARBLE FINISHERS		BLD		23.020	0.000	1.5	1.5	2.0	6.000	5.400	0.000	0.000
MARBLE MASON		BLD		24.520	25.270	1.5	1.5	2.0	6.000	5.400	0.000	0.000
MILLWRIGHT		BLD		26.620	28.620	1.5	1.5	2.0	6.500	6.850	0.000	0.320
MILLWRIGHT		HWY		19.290	20.540	1.5	1.5	2.0	2.800	3.000	0.000	0.000
OPERATING ENGINEER		BLD	1	27.840	30.840	1.5	1.5	2.0	5.900	8.000	0.000	0.900
OPERATING ENGINEER		BLD	2	25.940	30.840	1.5	1.5	2.0	5.900	8.000	0.000	0.900
OPERATING ENGINEER		BLD	3	24.560	30.840	1.5	1.5	2.0	5.900	8.000	0.000	0.900
OPERATING ENGINEER		HWY	1	29.110	32.110	1.5	1.5	2.0	6.250	9.000	0.000	1.000
OPERATING ENGINEER		HWY	2	26.730	32.110	1.5	1.5	2.0	6.250	9.000	0.000	1.000
OPERATING ENGINEER		HWY	3	22.790	32.110	1.5	1.5	2.0	6.250	9.000	0.000	1.000
PAINTER		ALL		26.850	27.850	1.5	1.5	1.5	5.650	5.750	0.000	0.350
PILEDRIIVER		BLD		26.710	28.710	1.5	1.5	2.0	6.500	6.920	0.000	0.320
PILEDRIIVER		HWY		25.850	27.600	1.5	1.5	2.0	6.500	6.920	0.000	0.300
PIPEFITTER	E	BLD		31.630	35.110	1.5	1.5	2.0	6.450	7.680	0.000	0.420
PIPEFITTER	W	ALL		30.520	33.570	1.5	1.5	2.0	4.800	7.960	0.000	0.530
PLASTERER		BLD		25.000	26.500	1.5	1.5	2.0	4.830	8.050	0.000	0.500
PLUMBER	E	BLD		28.390	30.950	1.5	1.5	2.0	6.450	8.990	0.000	0.800
PLUMBER	W	ALL		30.520	33.570	1.5	1.5	2.0	4.800	7.960	0.000	0.530
ROOFER		BLD		24.200	25.200	1.5	1.5	2.0	5.350	6.550	0.000	0.150
SHEETMETAL WORKER		BLD		24.150	25.710	1.5	1.5	2.0	6.040	7.000	0.000	0.380
SPRINKLER FITTER		BLD		31.240	33.240	1.5	1.5	2.0	6.500	5.350	0.000	0.250
STONE MASON		BLD		24.370	25.370	1.5	1.5	2.0	6.000	5.400	0.000	0.490
TERRAZZO FINISHER		BLD		23.020	0.000	1.5	1.5	2.0	6.000	5.400	0.000	0.000
TILE MASON		BLD		24.520	25.270	1.5	1.5	2.0	6.000	5.400	0.000	0.000
TRUCK DRIVER		ALL	1	25.787	0.000	1.5	1.5	2.0	7.250	3.317	0.000	0.000
TRUCK DRIVER		ALL	2	26.187	0.000	1.5	1.5	2.0	7.250	3.317	0.000	0.000
TRUCK DRIVER		ALL	3	26.387	0.000	1.5	1.5	2.0	7.250	3.317	0.000	0.000
TRUCK DRIVER		ALL	4	26.637	0.000	1.5	1.5	2.0	7.250	3.317	0.000	0.000
TRUCK DRIVER		ALL	5	27.387	0.000	1.5	1.5	2.0	7.250	3.317	0.000	0.000
TRUCK DRIVER		O&C	1	20.630	0.000	1.5	1.5	2.0	7.250	3.317	0.000	0.000
TRUCK DRIVER		O&C	2	20.950	0.000	1.5	1.5	2.0	7.250	3.317	0.000	0.000
TRUCK DRIVER		O&C	3	21.110	0.000	1.5	1.5	2.0	7.250	3.317	0.000	0.000
TRUCK DRIVER		O&C	4	21.310	0.000	1.5	1.5	2.0	7.250	3.317	0.000	0.000
TRUCK DRIVER		O&C	5	21.910	0.000	1.5	1.5	2.0	7.250	3.317	0.000	0.000

TUCKPOINTER                                    BLD    24.370 25.370 1.5    1.5 2.0 6.000 5.400 0.000 0.490

Legend:

M-F>8 (Overtime is required for any hour greater than 8 worked each day, Monday through Friday.

OSA (Overtime is required for every hour worked on Saturday)

OSH (Overtime is required for every hour worked on Sunday and Holidays)

H/W (Health & Welfare Insurance)

Pensn (Pension)

Vac (Vacation)

Trng (Training)

# Explanations

HANCOCK COUNTY

PLUMBERS & PIPEFITTERS (WEST) - That part of the county West of Rt. 94 excluding the City of Carthage by one mile.

The following list is considered as those days for which holiday rates of wages for work performed apply: New Years Day, Memorial/Decoration Day, Fourth of July, Labor Day, Veterans Day, Thanksgiving Day, Christmas Day. Generally, any of these holidays which fall on a Sunday is celebrated on the following Monday. This then makes work performed on that Monday payable at the appropriate overtime rate for holiday pay. Common practice in a given local may alter certain days of celebration such as the day after Thanksgiving for Veterans Day. If in doubt, please check with IDOL.

Oil and chip resealing (O&C) means the application of road oils and liquid asphalt to coat an existing road surface, followed by application of aggregate chips or gravel to coated surface, and subsequent rolling of material to seal the surface.

## EXPLANATION OF CLASSES

ASBESTOS - GENERAL - removal of asbestos material/mold and hazardous materials from any place in a building, including mechanical systems where those mechanical systems are to be removed. This includes the removal of asbestos materials/mold and hazardous materials from ductwork or pipes in a building when the building is to be demolished at the time or at some close future date.

ASBESTOS - MECHANICAL - removal of asbestos material from mechanical systems, such as pipes, ducts, and boilers, where the mechanical systems are to remain.

## CERAMIC TILE FINISHER, MARBLE FINISHER, TERRAZZO FINISHER

Assisting, helping or supporting the tile, marble and terrazzo mechanic by performing their historic and traditional work assignments required to complete the proper installation of the work covered by said crafts. The term "Ceramic" is used for naming the classification



only and is in no way a limitation of the product handled. Ceramic takes into consideration most hard tiles.

#### ELECTRONIC SYSTEMS TECHNICIAN

Installation, service and maintenance of low-voltage systems which utilizes the transmission and/or transference of voice, sound, vision, or digital for commercial, education, security and entertainment purposes for the following: TV monitoring and surveillance, background/foreground music, intercom and telephone interconnect, field programming, inventory control systems, microwave transmission, multi-media, multiplex, radio page, school, intercom and sound burglar alarms and low voltage master clock systems.

Excluded from this classification are energy management systems, life safety systems, supervisory controls and data acquisition systems not intrinsic with the above listed systems, fire alarm systems, nurse call systems and raceways exceeding fifteen feet in length.

#### TRUCK DRIVER - BUILDING, HEAVY AND HIGHWAY CONSTRUCTION

Class 1. Drivers on 2 axle trucks hauling less than 9 ton. Air compressor and welding machines and brooms, including those pulled by separate units, truck driver helpers, warehouse employees, mechanic helpers, greasers and tiremen, pickup trucks when hauling materials, tools, or workers to and from and on-the-job site, and fork lifts up to 6,000 lb. capacity.

Class 2. Two or three axle trucks hauling more than 9 ton but hauling less than 16 ton. A-frame winch trucks, hydrolift trucks, vector trucks or similar equipment when used for transportation purposes. Fork lifts over 6,000 lb. capacity, winch trucks, four axle combination units, and ticket writers.

Class 3. Two, three or four axle trucks hauling 16 ton or more. Drivers on water pulls, articulated dump trucks, mechanics and working forepersons, and dispatchers. Five axle or more combination units.

Class 4. Low Boy and Oil Distributors.

Class 5. Drivers who require special protective clothing while employed on hazardous waste work.

#### TRUCK DRIVER - OIL AND CHIP RESEALING ONLY.

This shall encompass laborers, workers and mechanics who drive contractor or subcontractor owned, leased, or hired pickup, dump, service, or oil distributor trucks. The work includes transporting materials and equipment (including but not limited to, oils, aggregate supplies, parts, machinery and tools) to or from the job site; distributing oil or liquid asphalt and aggregate; stock piling material when in connection with the actual oil and chip contract. The Truck Driver (Oil & Chip Resealing) wage classification does not include supplier delivered materials.

#### OPERATING ENGINEERS - BUILDING

Class 1. Cranes; Overhead Cranes; Gradall; All Cherry Pickers; Mechanics; Central Concrete Mixing Plant Operator; Road Pavers (27E - Dual Drum - Tri Batchers); Blacktop Plant Operators and Plant Engineers; 3 Drum Hoist; Derricks; Hydro Cranes; Shovels; Skimmer Scoops; Koehring Scooper; Drag Lines; Backhoe; Derrick Boats; Pile Drivers and Skid Rigs; Clamshells; Locomotive Cranes; Dredge (all

types) Motor Patrol; Power Blades - Dumore - Elevating and similar types; Tower Cranes (Crawler-Mobile) and Stationary; Crane-type Backfiller; Drott Yumbo and similar types considered as Cranes; Caisson Rigs; Dozer; Tournadozer; Work Boats; Ross Carrier; Helicopter; Tournapulls - all and similar types; Scoops (all sizes); Pushcats; Endloaders (all types); Asphalt Surfacing Machine; Slip Form Paver; Rock Crusher; Heavy Equipment Greaser; CMI, CMI Belt Placer, Auto Grade & 3 Track and similar types; Side Booms; Multiple Unit Earth Movers; Creter Crane; Trench Machine; Pump-crete-Belt Crete-Squeeze Cretes-Screw-type Pumps and Gypsum; Bulker & Pump - Operator will clean; Formless Finishing Machine; Flaherty Spreader or similar types; Screed Man on Laydown Machine; Wheel Tractors (industrial or Farm-type w/Dozer-Hoe-Endloader or other attachments); F.W.D. & Similar Types; Vermeer Concrete Saw.

Class 2. Dinkeys; Power Launches; PH One-pass Soil Cement Machine (and similar types); Pugmill with Pump; Backfillers; Euclid Loader; Forklifts; Jeeps w/Ditching Machine or other attachments; Tuneluger; Automatic Cement and Gravel Batching Plants; Mobile Drills (Soil Testing) and similar types; Gurries and Similar Types; (1) and (2) Drum Hoists (Buck Hoist and Similar Types); Chicago Boom; Boring Machine & Pipe Jacking Machine; Hydro Boom; Dewatering System; Straw Blower; Hydro Seeder; Assistant Heavy Equipment Greaser on Spread; Tractors (Track type) without Power Unit pulling Rollers; Rollers on Asphalt -- Brick Macadem; Concrete Breakers; Concrete Spreaders; Mule Pulling Rollers; Center Stripper; Cement Finishing Machines & CMI Texture & Reel Curing Machines; Cement Finishing Machine; Barber Green or similar loaders; Vibro Tamper (All similar types) Self-propelled; Winch or Boom Truck; Mechanical Bull Floats; Mixers over 3 Bag to 27E; Tractor pulling Power Blade or Elevating Grader; Porter Rex Rail; Clary Screed; Truck Type Hoptoe Oilers; Fireman; Spray Machine on Paving; Curb Machines; Truck Crane Oilers; Oil Distributor; Truck-Mounted Saws.

Class 3. Air Compressor; Power Subgrader; Straight Tractor; Trac Air without attachments; Herman Nelson Heater, Dravo, Warner, Silent Glo, and similar types; Roller: Five (5) Ton and under on Earth or Gravel; Form Grader; Crawler Crane & Skid Rig Oilers; Freight Elevators - permanently installed; Pump; Light Plant; Generator; Conveyor (1) or (2) - Operator will clean; Welding Machine; Mixer (3) Bag and Under (Standard Capacity with skip); Bulk Cement Plant; Oiler on Central Concrete Mixing Plant.

#### OPERATING ENGINEERS - HEAVY AND HIGHWAY CONSTRUCTION

Class 1. Cranes; Hydro Crane; Shovels; Crane Type Backfiller; Tower Cranes - Mobile & Crawler & Stationary; Derricks & Hoists (3 Drum); Draglines; Drott Yumbo & similar types considered as Cranes; Back Hoe; Derrick Boats; Pile Driver and Skid Rigs; Clam Shell; Locomotive - Cranes; Road Pavers - Single Drum - Dual Drum - Tri Batcher; Motor Patrols & Power Blades - Dumore - Elevating & Similar Types; Mechanics; Central Concrete Mixing Plant Operator; Asphalt Batch Plant Operators and Plant Engineers; Gradall; Caisson Rigs; Skimmer Scoop - Koering Scooper; Dredges (all types); Hoptoe; All Cherry Pickers; Work Boat; Ross Carrier; Helicopter; Dozer; Tournadozer; Tournapulls - all and similar types; Multiple Unit Earth Movers; Scoops (all sizes); Pushcats; Endloaders (all types); Asphalt Surfacing Machine; Slip Form Paver; Rock Crusher; Heavy Equipment Greaser (top greaser on spread); CMI, Auto Grade, CMI Belt Placer & 3 Track and similar types; Side Booms; Starting Engineer on Pipeline; Asphalt Heater & Planer Combination (used to plane streets); Wheel Tractors (with dozer, hoe or endloader attachments); F.W.D. and Similar types; Blaw Knox Spreader and Similar types; Trench Machines; Pump Crete - Belt

Crete - Squeeze Crete - screw type pumps and gypsum (operator will clean); Formless Finishing Machines; Flaherty Spreader or similar types; Screed Man on Laydown Machine; Vermeer Concrete Saw.

Class 2. Bulker & Pump; Power Launches; Boring Machine & Pipe Jacking Machine; Dinkeys; P-H One Pass Soil Cement Machines and similar types; Wheel Tractors (Industry or farm type - other); Back Fillers; Euclid Loader; Fork Lifts; Jeep w/Ditching Machine or other attachments; Tunneluger; Automatic Cement & Gravel Batching Plants; Mobile Drills - Soil Testing and similar types; Pugmill with pump; All (1) and (2) Drum Hoists; Dewatering System; Straw Blower; Hydro-Seeder; Boring Machine; Hydro-Boom; Bump Grinders (self-propelled); Assistant Heavy Equipment Greaser; Apsco Spreader; Tractors (track-type) without Power Units Pulling Rollers on Asphalt - Brick or Macadam; Concrete Breakers; Concrete Spreaders; Cement Strippers; Cement Finishing Machines & CMI Texture & Reel Curing Machines; Vibro-Tampers (all similar types self-propelled); Mechanical Bull Floats; Self-propelled Concrete Saws; Mixers-over three (3) bags to 27E; Winch and Boom Trucks; Tractor Pulling Power Blade or Elevating Grader; Porter Rex Rail; Clary Screed; Mule Pulling Rollers; Pugmill without Pump; Barber Greene or similar Loaders; Track Type Tractor w/Power Unit attached (minimum); Fireman; Spray Machine on Paving; Curb Machines; Paved Ditch Machine; Power Broom; Self-Propelled Conveyors; Power Subgrader; Oil Distributor; Straight Tractor; Truck Crane Oiler; Truck Type Oilers; Directional boring machine; Horizontal directional drill.

Class 3. Straight framed articulating end dump vehicles and Truck mounted vac unit (separately powered); Trac Air Machine (without attachments); Herman Nelson Heater, Dravo Warner, Silent Glo & similar types; Rollers - five ton and under on earth and gravel; Form Graders; Pumps; Light Plant; Generator; Air Compressor (1) or (2); Conveyor; Welding Machine; Mixer - 3 bags and under; Bulk Cement Plant; Oilers.

#### Other Classifications of Work:

For definitions of classifications not otherwise set out, the Department generally has on file such definitions which are available. If a task to be performed is not subject to one of the classifications of pay set out, the Department will upon being contacted state which neighboring county has such a classification and provide such rate, such rate being deemed to exist by reference in this document. If no neighboring county rate applies to the task, the Department shall undertake a special determination, such special determination being then deemed to have existed under this determination. If a project requires these, or any classification not listed, please contact IDOL at 618/993-7271 for wage rates or clarifications.

#### LANDSCAPING

Landscaping work falls under the existing classifications for laborer, operating engineer and truck driver. The work performed by landscape plantsman and landscape laborer is covered by the existing classification of laborer. The work performed by landscape operators (regardless of equipment used or its size) is covered by the classifications of operating engineer. The work performed by landscape truck drivers (regardless of size of truck driven) is covered by the classifications of truck driver.

# Hardin County Prevailing Wage for April 2007

Trade Name	RG	TYP	C	Base	FRMAN	*M-F>8	OSA	OSH	H/W	Pensn	Vac	Trng
=====	==	==	=	=====	=====	=====	==	==	=====	=====	=====	=====
ASBESTOS ABT-GEN		ALL		20.750	21.200	1.5	1.5	2.0	5.250	5.600	0.000	0.700
ASBESTOS ABT-MEC		BLD		20.800	0.000	2.0	2.0	2.0	5.000	3.400	0.000	0.000
BOILERMAKER		BLD		28.500	31.000	1.5	1.5	2.0	6.820	11.03	0.000	0.300
BRICK MASON		BLD		25.470	26.970	1.5	1.5	2.0	6.000	5.400	0.000	0.425
CARPENTER		BLD		27.780	29.280	1.5	1.5	2.0	5.050	3.750	0.000	0.350
CARPENTER		HWY		27.730	29.230	1.5	1.5	2.0	5.050	3.750	0.000	0.350
CEMENT MASON		BLD		23.500	24.500	1.5	1.5	2.0	5.200	3.550	0.000	0.100
CEMENT MASON		HWY		23.750	24.750	1.5	1.5	2.0	5.300	3.700	0.000	0.300
CERAMIC TILE FNSHER		BLD		24.990	0.000	1.5	1.5	2.0	6.000	5.400	0.000	0.425
ELECTRICIAN		ALL		31.470	33.720	1.5	1.5	2.0	5.150	5.660	0.000	0.470
ELECTRONIC SYS TECH		BLD		25.700	27.200	1.5	1.5	2.0	5.150	3.340	0.000	0.250
FLOOR LAYER		BLD		26.930	27.680	1.5	1.5	2.0	5.000	3.750	0.000	0.350
GLAZIER		BLD		22.930	0.000	1.5	1.5	2.0	4.320	3.800	0.000	0.300
HT/FROST INSULATOR		BLD		26.110	27.110	1.5	1.5	2.0	4.800	6.860	0.000	0.190
IRON WORKER		ALL		22.650	23.650	1.5	1.5	2.0	5.760	6.450	0.000	0.310
LABORER		BLD		20.750	21.200	1.5	1.5	2.0	5.250	5.600	0.000	0.600
LABORER		HWY		21.000	21.450	1.5	1.5	2.0	5.350	6.150	0.000	0.600
LABORER		O&C		15.750	16.200	1.5	1.5	2.0	5.350	6.150	0.000	0.600
MACHINIST		BLD		36.890	38.890	2.0	2.0	2.0	4.380	5.650	2.550	0.000
MARBLE FINISHERS		BLD		24.990	0.000	1.5	1.5	2.0	6.000	5.400	0.000	0.425
MARBLE MASON		BLD		25.470	26.970	1.5	1.5	2.0	6.000	5.400	0.000	0.425
MILLWRIGHT		BLD		27.780	29.280	1.5	1.5	2.0	5.050	3.750	0.000	0.350
MILLWRIGHT		HWY		27.730	29.230	1.5	1.5	2.0	5.050	3.750	0.000	0.350
OE RIVER 1		RIV	1	26.900	0.000	1.5	1.5	2.0	5.650	6.100	0.000	1.100
OE RIVER 2		RIV	2	23.450	0.000	1.5	1.5	2.0	5.650	6.100	0.000	1.100
OPERATING ENGINEER		ALL	1	26.800	27.800	1.5	1.5	2.0	5.650	6.100	0.000	1.100
OPERATING ENGINEER		ALL	2	24.900	27.800	1.5	1.5	2.0	5.650	6.100	0.000	1.100
OPERATING ENGINEER		ALL	3	24.150	27.800	1.5	1.5	2.0	5.650	6.100	0.000	1.100
OPERATING ENGINEER		ALL	4	21.400	27.800	1.5	1.5	2.0	5.650	6.100	0.000	1.100
OPERATING ENGINEER		O&C	1	20.100	21.100	1.5	1.5	2.0	5.650	6.100	0.000	1.100
OPERATING ENGINEER		O&C	2	18.680	21.100	1.5	1.5	2.0	5.650	6.100	0.000	1.100
OPERATING ENGINEER		O&C	3	18.120	21.100	1.5	1.5	2.0	5.650	6.100	0.000	1.100
OPERATING ENGINEER		O&C	4	16.050	21.100	1.5	1.5	2.0	5.650	6.100	0.000	1.100
PAINTER		BLD		22.790	23.790	1.5	1.5	2.0	5.430	4.500	0.000	0.250
PAINTER		HWY		27.090	28.090	1.5	1.5	2.0	5.430	4.500	0.000	0.250
PAINTER OVER 30FT		BLD		23.790	24.790	1.5	1.5	2.0	5.430	4.500	0.000	0.250
PAINTER PWR EQMT		BLD		23.790	24.790	1.5	1.5	2.0	5.430	4.500	0.000	0.250
PAINTER PWR EQMT		HWY		28.090	29.090	1.5	1.5	2.0	5.430	4.500	0.000	0.250
PILEDRIVER		BLD		27.780	29.280	1.5	1.5	2.0	5.050	3.750	0.000	0.350
PILEDRIVER		HWY		27.730	29.230	1.5	1.5	2.0	5.050	3.750	0.000	0.350
PIPEFITTER		BLD		31.300	34.430	1.5	2.0	2.0	6.450	5.030	0.000	0.620
PLASTERER		BLD		23.500	24.500	1.5	1.5	2.0	5.200	3.550	0.000	0.100
PLUMBER		BLD		31.300	34.430	1.5	2.0	2.0	6.450	5.030	0.000	0.620
ROOFER		BLD		24.690	26.190	1.5	1.5	2.0	4.380	4.000	0.000	0.000
SHEETMETAL WORKER		ALL		27.210	28.460	1.5	1.5	2.0	6.000	4.770	1.630	0.120
SPRINKLER FITTER		BLD		31.240	33.240	1.5	1.5	2.0	6.500	5.350	0.000	0.250
STONE MASON		BLD		25.470	26.970	1.5	1.5	2.0	6.000	5.400	0.000	0.425
TERRAZZO FINISHER		BLD		24.990	0.000	1.5	1.5	2.0	6.000	5.400	0.000	0.425
TRUCK DRIVER		ALL	1	24.990	0.000	1.5	1.5	2.0	7.250	4.200	0.000	0.000
TRUCK DRIVER		ALL	2	25.390	0.000	1.5	1.5	2.0	7.250	4.200	0.000	0.000
TRUCK DRIVER		ALL	3	25.590	0.000	1.5	1.5	2.0	7.250	4.200	0.000	0.000
TRUCK DRIVER		ALL	4	25.840	0.000	1.5	1.5	2.0	7.250	4.200	0.000	0.000
TRUCK DRIVER		ALL	5	26.590	0.000	1.5	1.5	2.0	7.250	4.200	0.000	0.000
TRUCK DRIVER		O&C	1	19.500	0.000	1.5	1.5	2.0	4.275	4.670	0.000	0.000
TRUCK DRIVER		O&C	2	15.900	0.000	1.5	1.5	2.0	4.275	4.670	0.000	0.000
TRUCK DRIVER		O&C	3	16.400	0.000	1.5	1.5	2.0	4.275	4.670	0.000	0.000
TUCKPOINTER		BLD		25.470	26.970	1.5	1.5	2.0	6.000	5.400	0.000	0.425

Legend :

M-F>8 (Overtime is required for any hour greater than 8 worked each day, Monday through Friday.)

OSA (Overtime is required for every hour worked on Saturday)

OSH (Overtime is required for every hour worked on Sunday and Holidays)

H/W (Health & Welfare Insurance)

Pensn (Pension)

Vac (Vacation)

Trng (Training)

## Explanations

### HARDIN COUNTY

The following list is considered as those days for which holiday rates of wages for work performed apply: New Years Day, Memorial/Decoration Day, Fourth of July, Labor Day, Veterans Day, Thanksgiving Day, Christmas Day. Generally, any of these holidays which fall on a Sunday is celebrated on the following Monday. This then makes work performed on that Monday payable at the appropriate overtime rate for holiday pay. Common practice in a given local may alter certain days of celebration such as the day after Thanksgiving for Veterans Day. If in doubt, please check with IDOL.

Oil and chip resealing (O&C) means the application of road oils and liquid asphalt to coat an existing road surface, followed by application of aggregate chips or gravel to coated surface, and subsequent rolling of material to seal the surface.

### EXPLANATION OF CLASSES

ASBESTOS - GENERAL - removal of asbestos material/mold and hazardous materials from any place in a building, including mechanical systems where those mechanical systems are to be removed. This includes the removal of asbestos materials/mold and hazardous materials from ductwork or pipes in a building when the building is to be demolished at the time or at some close future date.

ASBESTOS - MECHANICAL - removal of asbestos material from mechanical systems, such as pipes, ducts, and boilers, where the mechanical systems are to remain.

### LABORER - OIL AND CHIP RESEALING ONLY

Hook and unhook chip box from aggregate truck; distribute material within chip box; perform flagging work related to oil and chip resealing; hand spray oil fluids; handle traffic control, including setting-up and maintaining barricades, drums, cones, delineators, signs and other such items, as well as laying-out and applying or removing temporary roadway markings used to control traffic in job site related to oil and chip resealing; and perform clean-up related to oil and chip resealing.

CERAMIC TILE FINISHER, MARBLE FINISHER, TERRAZZO FINISHER

Assisting, helping or supporting the tile, marble and terrazzo mechanic by performing their historic and traditional work assignments required to complete the proper installation of the work covered by said crafts. The term "Ceramic" is used for naming the classification only, and is in no a limitation of the product handled. Ceramic takes into consideration most hard tiles.

ELECTRONIC SYSTEMS TECHNICIAN

Installation, service and maintenance of low-voltage systems which utilizes the transmission and/or transference of voice, sound, vision, or digital for commercial, education, security and entertainment purposes for the following: TV monitoring and surveillance, background/foreground music, intercom and telephone interconnect, field programming, inventory control systems, microwave transmission, multi-media, multiplex, radio page, school, intercom and sound burglar alarms and low voltage master clock systems.

Excluded from this classification are energy management systems, life safety systems, supervisory controls and data acquisition systems not intrinsic with the above listed systems, fire alarm systems, nurse call systems and raceways exceeding fifteen feet in length.

TRUCK DRIVER - BUILDING, HEAVY AND HIGHWAY CONSTRUCTION

Class 1. Drivers on 2 axle trucks hauling less than 9 ton. Air compressor and welding machines and brooms, including those pulled by separate units, truck driver helpers, warehouse employees, mechanic helpers, greasers and tiremen, pickup trucks when hauling materials, tools, or workers to and from and on-the-job site, and fork lifts up to 6,000 lb. capacity.

Class 2. Two or three axle trucks hauling more than 9 ton but hauling less than 16 ton. A-frame winch trucks, hydrolift trucks, vector trucks or similar equipment when used for transportation purposes. Fork lifts over 6,000 lb. capacity, winch trucks, four axle combination units, and ticket writers.

Class 3. Two, three or four axle trucks hauling 16 ton or more. Drivers on water pulls, articulated dump trucks, mechanics and working forepersons, and dispatchers. Five axle or more combination units.

Class 4. Low Boy and Oil Distributors.

Class 5. Drivers who require special protective clothing while employed on hazardous waste work.

TRUCK DRIVER - O & C (Oil and Chip Resealing ONLY)

It involves driving of contractor or subcontractor owned, leased, or hired pickup, dump, service, or oil distributor trucks. Includes transporting materials and equipment (including, but not limited to oils, aggregate supplies, parts, machinery and tools) to or from the job site; distributing oil or liquid asphalt and aggregate; stock piling material; and maintaining trucks at job site related to oil and chip resealing.

Class 1. Distributors, liquid asphalt hauling and hauling of asphalt rubber-tired rollers.

Class 2. Stockpiling.

Class 3. Tandem hauling to job site.

OPERATING ENGINEERS - BUILDING, HEAVY AND HIGHWAY CONSTRUCTION

Class 1. APSCO or Equal Spreading Machine, Backhoe, Backfiller, Boom or Winch Cat, Bituminous Mixplane Machine, Blacksmith, Bituminous Surfacing Machine, Bull-Dozer, Crane, Shovel, Dragline, Truck Crane, Pile Driver, Concrete Breaker, Concrete or Pumpcrete Pumps, Dinky or Standard Locomotives, Well or Caisson Drills, Elevating Grader, Fork Lifts, Flexplane, Gradeall, Hi-Lift Hoists, Guy-Derricks, Hysters, Mechanic Motor Patrol, Mixers-21 cu. ft. or over, Push Cats, Pulls and Scrapers, Two Well Point Pumps, Pulverizer or Tiller, PugMill, Rubber-Tired Farm Type Tractor with Bulldozer/Blade/Auger or hi-lift over 1/2 yd., Jersey Spreader, Tract-Air used with Drill or Hi-Lift, Trenching or Ditching Machines, Wood Chipper w/Tractor, Self-Propelled Roller w/Blade, Equipment Greaser, Self-Propelled Bump Grinder on Concrete pavement, Boat Operator, Skid-Loaders, Tuggers, Lazer Screed, and Self-Propelled Chip Spreader (when others run conveyors).

Class 2. Any type tractor pulling any type roller or disc, Two Air Compressors (220 cu. ft. capacity or over), Two AirTract Drills, Air-Track Drill w/Compressor, Automatic Bins or Scales w/Compressor or Generator, Pipeline Boring Machine, Bulk Cement Plant w/Separate Compressor, Power Operated Bull Float, Hydra-Lift w/Single Motor, Straw Mulcher Blower w/Spout, Self-Propelled Roller/Compactor, Back-End man on Bituminous Surfacing Machine, oiler on milling machine.

Class 3. Air Compressor w/Valve driving piling, Boom or Winch Type Truck, Two Conveyors, Self-Propelled Concrete Saw, Form Grader, Truck Crane Oiler, Self-Propelled Vibrator, Rubber Tired Farm Type Tractor w/Blade/Bulldozer/Auger/hi-lift - 1/2 yd. or less, Elevator Operator, Man Lift (scissor lift) when lifting materials.

Class 4. Air-Track Drill (one), Belt Drag Machine, Power Broom, Mechanical Plasterer Applicator, Trac-Air, Air Compressor (220 cu. ft. or over) One, Air Compressor (under 220 cu. ft) four, Automatic Bin, Bulk Cement Plant w/Built-in Compressor running off same motor or electric motor, Fireman or Switchman, Self-Propelled Form Tamper, Light Plants (4), Welding Machines (4), Pumps (4), or Combination of four (4) Pumps, Light Plants, Welding Machines, Air-Compressors (under 220 cu. ft.), Mudjacks or Wood Chipper, Mixers - less than 21 cu. ft. Mortar Mixer w/Skip or Pump, Pipeline Tract Jack. One Operating Engineer may operate and maintain any combination of the following pieces of equipment, not to exceed four (4) which shall be within a reasonable distance, such combination may include any equipment in this classification: (Compressors, Light Plants, Generators, Welding Machines, Pumps or Conveyors), One Well- Point Pump, Two Motor Driven Heaters, One Air Compressor (under 220 cu. ft.), One Engine-Driven Conveyor, One Motor Driven Heater, One Light Plant, One Pump, One Welding Machine, One Ulmac or Equal Spreader, Oilers, and one Generator 10 kw or greater.

OPERATING ENGINEER - O & C (Oil and Chip Resealing ONLY). Includes the operation of all motorized heavy equipment used in oil and chip rsealing, including but not limited to operating self-propelled chip spreaders, and all types of rollers (both hard and rubber tired); and other duties pertaining to the operation or maintenance of heavy equipment relatd to oil and chip resealing.

Class 1. See Class 1 above for types of equipment operated.

Class 2. See Class 2 above for types of equipment operated.

Class 3. See Class 3 above for types of equipment operated.

Class 4. See Class 4 above for types of equipment operated.

OPERATING ENGINEER RIVER WORK 1 - operate the following machines when working on River Work and Levee Work on the Mississippi and Ohio Rivers, Lakes and Tributaries: Crane, Shovel, Drageline, Scrapers, Dredge, Derrick, Pile-Driver, Push Boat, all power boat operators, Mechanic, Engineman on Dredge, Leverman on Dredge, All Bituminous Spreader machines, Backhoe, Backfiller, Boom, or Winch Cat, Bituminous Mixplane Machine, Blacksmith, Bituminous Surfacing Machine, Bulldozer, Truck Cranes, Hydraulic Truck Mounted Boom/Crane, Concrete Finishing Machine, or Spreader Machine, Concrete Breaker, Concrete or Pumpcrete Machines, Concrete Plant Operator, All Off Road Material Hauling Equipment, Dinky or Standard Locomotives, Well Drill, Elevating Grader, Fork-Lifts, Flexplane, Gradeall, Hi-Lift, Power Handblade Tugger type Hoist, Hoist Two Drum (or over one), Gyderrick, Hyster, Motor Patrol, Mixers - 21 Cu. Ft. or over, Push Cat, Pulls, & Scrapers, Pumps-Two Well Points, Equipment Greaser, P & H Pulverizer or Pulverizer equal to Pugmill, Pugmill, Rubber-Tired farm type tractor w/Bulldozer/Blade/Auger or Hi-Lift over ½ yard, Skimmer Scoops, Seaman Tiller, Jersey Spreader, Tract-Air used with Drill or Hi-Lift, Trenching or Ditching Machine, Wood Chipper w/Tractor, self-propelled roller w/Blade, Concrete Pumps and Small Equipment Operators.

OPERATING ENGINEER RIVER 2 - when working on River Work and Levee Work on the Mississippi and Ohio Rivers, Lakes and Tributaries shall be employed as the Oiler or Fireman on Crane, Dragline, Shovel, Dredge, Truck Crane, Pile Driver, Gradeall, Dinky or Standard Locomotive, Guy Derrick, Trenching Machine or Ditching Machine 80 H.P. and over, All Terrain (cherry-picker) with over 40 ton Lifting Capacity, Deck Oiler and Deckhands.

#### Other Classifications of Work:

For definitions of classifications not otherwise set out, the Department generally has on file such definitions which are available. If a task to be performed is not subject to one of the classifications of pay set out, the Department will upon being contacted state which neighboring county has such a classification and provide such rate, such rate being deemed to exist by reference in this document. If no neighboring county rate applies to the task, the Department shall undertake a special determination, such special determination being then deemed to have existed under this determination. If a project requires these, or any classification not listed, please contact IDOL at 618/993-7271 for wage rates or clarifications.

#### LANDSCAPING

Landscaping work falls under the existing classifications for laborer, operating engineer and truck driver. The work performed by landscape plantsman and landscape laborer is covered by the existing classification of laborer. The work performed by landscape operators (regardless of equipment used or its size) is covered by the classifications of operating engineer. The work performed by landscape truck drivers (regardless of size of truck driven) is covered by the classifications of truck driver.



# Henderson County Prevailing Wage for April 2007

Trade Name	RG	TYP	C	Base	FRMAN	*M-F>8	OSA	OSH	H/W	Pensn	Vac	Trng
=====	==	==	=	=====	=====	=====	==	==	=====	=====	=====	=====
ASBESTOS ABT-GEN		BLD		23.510	24.260	1.5	1.5	2.0	5.850	6.180	0.000	0.600
ASBESTOS ABT-GEN		HWY		22.940	23.440	1.5	1.5	2.0	5.850	5.850	0.000	0.700
ASBESTOS ABT-MEC		BLD		18.750	19.750	1.5	1.5	2.0	4.750	2.000	0.000	0.000
BOILERMAKER		BLD		30.970	33.970	2.0	2.0	2.0	8.270	7.740	0.000	0.300
BRICK MASON		BLD		27.020	28.520	1.5	1.5	2.0	5.500	6.350	0.000	0.390
CARPENTER		BLD		24.750	25.990	1.5	1.5	2.0	5.700	5.160	0.000	0.400
CARPENTER		HWY		25.540	27.290	1.5	1.5	2.0	5.860	6.260	0.000	0.400
CEMENT MASON		BLD		22.800	23.800	1.5	1.5	2.0	5.200	8.080	0.000	0.150
CEMENT MASON		HWY		23.060	24.060	1.5	1.5	2.0	5.300	5.800	0.000	0.500
CERAMIC TILE FNSHER		BLD		24.910	0.000	1.5	1.5	2.0	5.500	6.350	0.000	0.380
ELECTRIC PWR EQMT OP		ALL		30.750	0.000	1.5	1.5	2.0	4.750	8.610	0.000	0.000
ELECTRIC PWR GRNDMAN		ALL		21.090	0.000	1.5	1.5	2.0	4.750	5.905	0.000	0.000
ELECTRIC PWR LINEMAN		ALL		34.160	36.350	1.5	1.5	2.0	4.750	9.560	0.000	0.000
ELECTRIC PWR TRK DRV		ALL		22.130	0.000	1.5	1.5	2.0	4.750	6.200	0.000	0.000
ELECTRICIAN		BLD		27.040	29.040	1.5	1.5	2.0	5.150	7.460	0.000	0.250
ELECTRONIC SYS TECH		BLD		23.850	25.350	1.5	1.5	2.0	5.150	5.625	0.000	0.250
ELEVATOR CONSTRUCTOR		BLD		34.190	38.460	2.0	2.0	2.0	8.275	6.060	2.050	0.000
GLAZIER		BLD		20.580	21.810	1.5	1.5	2.0	4.750	3.900	0.000	0.200
HT/FROST INSULATOR		BLD		25.860	27.060	1.5	1.5	2.0	4.800	7.500	0.000	0.000
IRON WORKER		ALL		21.500	22.750	1.5	1.5	2.0	5.760	6.790	0.000	0.260
LABORER		BLD		22.510	23.260	1.5	1.5	2.0	5.850	6.180	0.000	0.600
LABORER		HWY		21.940	22.440	1.5	1.5	2.0	5.850	5.850	0.000	0.600
LABORER, SKILLED		BLD		22.510	23.260	1.5	1.5	2.0	5.850	6.180	0.000	0.600
LABORER, SKILLED		HWY		22.240	22.740	1.5	1.5	2.0	5.850	5.850	0.000	0.600
LATHER		BLD		24.750	25.990	1.5	1.5	2.0	5.700	5.160	0.000	0.400
MACHINIST		BLD		36.890	38.890	2.0	2.0	2.0	4.380	5.650	2.550	0.000
MARBLE FINISHERS		BLD		24.910	0.000	1.5	1.5	2.0	5.500	6.350	0.000	0.380
MARBLE MASON		BLD		26.520	27.770	1.5	1.5	2.0	5.500	6.350	0.000	0.380
MILLWRIGHT		BLD		25.000	26.700	1.5	1.5	2.0	5.550	7.730	0.000	0.560
MILLWRIGHT		HWY		19.330	20.580	1.5	1.5	2.0	1.550	2.000	0.000	0.000
OPERATING ENGINEER		BLD	1	27.840	30.840	1.5	1.5	2.0	5.900	8.000	0.000	0.900
OPERATING ENGINEER		BLD	2	25.940	30.840	1.5	1.5	2.0	5.900	8.000	0.000	0.900
OPERATING ENGINEER		BLD	3	24.560	30.840	1.5	1.5	2.0	5.900	8.000	0.000	0.900
OPERATING ENGINEER		HWY	1	29.110	32.110	1.5	1.5	2.0	6.250	9.000	0.000	1.000
OPERATING ENGINEER		HWY	2	26.730	32.110	1.5	1.5	2.0	6.250	9.000	0.000	1.000
OPERATING ENGINEER		HWY	3	22.790	32.110	1.5	1.5	2.0	6.250	9.000	0.000	1.000
PAINTER		ALL		23.470	24.470	1.5	1.5	1.5	4.650	4.850	0.000	0.600
PAINTER OVER 30FT		ALL		24.720	25.720	1.5	1.5	1.5	4.650	4.850	0.000	0.600
PAINTER PWR EQMT		ALL		23.970	24.970	1.5	1.5	1.5	4.650	4.850	0.000	0.600
PILEDRIVER		BLD		24.750	25.990	1.5	1.5	2.0	5.700	5.160	0.000	0.400
PILEDRIVER		HWY		25.540	27.290	1.5	1.5	2.0	5.860	6.260	0.000	0.400
PIPEFITTER		ALL		30.520	33.570	1.5	1.5	2.0	4.800	7.960	0.000	0.530
PLASTERER		BLD		25.900	27.450	1.5	1.5	2.0	4.000	4.400	0.000	0.100
PLUMBER		ALL		30.520	33.570	1.5	1.5	2.0	4.800	7.960	0.000	0.530
ROOFER		BLD		22.850	24.100	1.5	1.5	2.0	5.840	4.870	0.000	0.190
SHEETMETAL WORKER		BLD		24.150	25.710	1.5	1.5	2.0	6.040	7.000	0.000	0.380
SPRINKLER FITTER		BLD		31.240	33.240	1.5	1.5	2.0	6.500	5.350	0.000	0.250
STONE MASON		BLD		27.020	28.520	1.5	1.5	2.0	5.500	6.350	0.000	0.390
TERRAZZO FINISHER		BLD		24.910	0.000	1.5	1.5	2.0	5.500	6.350	0.000	0.380
TERRAZZO MASON		BLD		26.520	27.770	1.5	1.5	2.0	5.500	6.350	0.000	0.380
TILE LAYER		BLD		24.750	25.990	1.5	1.5	2.0	5.700	5.160	0.000	0.400
TILE MASON		BLD		26.520	27.770	1.5	1.5	2.0	5.500	6.350	0.000	0.380
TRUCK DRIVER		ALL	1	25.787	0.000	1.5	1.5	2.0	7.250	3.317	0.000	0.000
TRUCK DRIVER		ALL	2	26.187	0.000	1.5	1.5	2.0	7.250	3.317	0.000	0.000
TRUCK DRIVER		ALL	3	26.387	0.000	1.5	1.5	2.0	7.250	3.317	0.000	0.000
TRUCK DRIVER		ALL	4	26.637	0.000	1.5	1.5	2.0	7.250	3.317	0.000	0.000
TRUCK DRIVER		ALL	5	27.387	0.000	1.5	1.5	2.0	7.250	3.317	0.000	0.000
TRUCK DRIVER		O&C	1	20.630	0.000	1.5	1.5	2.0	7.250	3.317	0.000	0.000

TRUCK DRIVER	O&C 2	20.950	0.000	1.5	1.5	2.0	7.250	3.317	0.000	0.000
TRUCK DRIVER	O&C 3	21.110	0.000	1.5	1.5	2.0	7.250	3.317	0.000	0.000
TRUCK DRIVER	O&C 4	21.310	0.000	1.5	1.5	2.0	7.250	3.317	0.000	0.000
TRUCK DRIVER	O&C 5	21.910	0.000	1.5	1.5	2.0	7.250	3.317	0.000	0.000
TUCKPOINTER	BLD	27.020	28.520	1.5	1.5	2.0	5.500	6.350	0.000	0.390

Legend :

M-F>8 (Overtime is required for any hour greater than 8 worked each day, Monday through Friday.)

OSA (Overtime is required for every hour worked on Saturday)

OSH (Overtime is required for every hour worked on Sunday and Holidays)

H/W (Health & Welfare Insurance)

Pensn (Pension)

Vac (Vacation)

Trng (Training)

## Explanations

### HENDERSON COUNTY

The following list is considered as those days for which holiday rates of wages for work performed apply: New Years Day, Memorial/Decoration Day, Fourth of July, Labor Day, Veterans Day, Thanksgiving Day, Christmas Day. Generally, any of these holidays which fall on a Sunday is celebrated on the following Monday. This then makes work performed on that Monday payable at the appropriate overtime rate for holiday pay. Common practice in a given local may alter certain days of celebration such as the day after Thanksgiving for Veterans Day. If in doubt, please check with IDOL.

Oil and chip resealing (O&C) means the application of road oils and liquid asphalt to coat an existing road surface, followed by application of aggregate chips or gravel to coated surface, and subsequent rolling of material to seal the surface.

### EXPLANATION OF CLASSES

ASBESTOS - GENERAL - removal of asbestos material/mold and hazardous materials from any place in a building, including mechanical systems where those mechanical systems are to be removed. This includes the removal of asbestos materials/mold and hazardous materials from ductwork or pipes in a building when the building is to be demolished at the time or at some close future date.

ASBESTOS - MECHANICAL - removal of asbestos material from mechanical systems, such as pipes, ducts, and boilers, where the mechanical systems are to remain.

### CERAMIC TILE FINISHER, MARBLE FINISHER, TERRAZZO FINISHER

Assisting, helping or supporting the tile, marble and terrazzo mechanic by performing their historic and traditional work assignments required to complete the proper installation of the work covered by

said crafts. The term "Ceramic" is used for naming the classification only and is in no way a limitation of the product handled. Ceramic takes into consideration most hard tiles.

#### ELECTRONIC SYSTEMS TECHNICIAN

Installation, service and maintenance of low-voltage systems which utilizes the transmission and/or transference of voice, sound, vision, or digital for commercial, education, security and entertainment purposes for the following: TV monitoring and surveillance, background/foreground music, intercom and telephone interconnect, field programming, inventory control systems, microwave transmission, multi-media, multiplex, radio page, school, intercom and sound burglar alarms and low voltage master clock systems.

Excluded from this classification are energy management systems, life safety systems, supervisory controls and data acquisition systems not intrinsic with the above listed systems, fire alarm systems, nurse call systems and raceways exceeding fifteen feet in length.

#### LABORER, SKILLED - BUILDING

The skilled laborer building (BLD) classification shall encompass the following types of work, irrespective of the site of the work: tending of carpenters in unloading, handling, stockpiling and distribution operations, also other building crafts, mixing, handling, and conveying of all materials used by masons, plasterers and other building construction crafts, whether done by hand or by any process. The drying of plastering when done by salamander heat, and the cleaning and clearing of all debris. All work pertaining to and in preparation of asbestos abatement and removal. The building of scaffolding and staging for masons and plasterers. The excavations for buildings and all other construction, digging, of trenches, piers, foundations and holes, digging, lagging, sheeting, cribbing, bracing and propping of foundations, holes, caissons, cofferdams, and dikes, the setting of all guidelines for machine or hand excavation and subgrading. The mixing, handling, conveying, pouring, vibrating, gunniting and otherwise applying of concrete, whether by hand or other method of concrete for any walls, foundations, floors, or for other construction concrete sealant men. The wrecking, stripping, dismantling, and handling of concrete forms and false work, and the building of centers for fireproofing purposes. Boring machine, gas, electric or air in preparation for shoving pipe, telephone cable, and so forth, under highways, roads, streets and alleys. All hand and power operating cross cut saws when used for clearing. All work in compressed air construction. All work on acetylene burners in salvaging. The blocking and tamping of concrete. The laying of sewer tile and conduit, and pre-cast materials. The assembling and dismantling of all jacks and sectional scaffolding, including elevator construction and running of slip form jacks. The work of drill running and blasting, including wagon drills. The wrecking, stripping, dismantling, cleaning, moving and oiling of forms. The cutting off of concrete piles. The loading, unloading, handling and carrying to place of installation of all rods, (and materials for use in reinforcing) concrete and the hoisting of same and all signaling where hoist is used in this type of construction coming under the jurisdiction of the Laborers' Union. And, all other labor work not awarded to any other craft. Mortar mixers, kettlemen and carrier of hot stuff, tool crib men, watchmen (Laborer), firemen or salamander tenders, flagmen, deck hands, installation and maintenance of temporary gas-fired heating units, gravel box men, dumpmen and spotters, fencing Laborers, cleaning lumber, pit men, material checkers, dispatchers, unloading explosives, asphalt plant laborers,

writer of scale tickets, fireproofing laborers, janitors, asbestos abatement and removal laborers, handling of materials treated with oil, creosote, chloride, asphalt, and/or foreign material harmful to skin or clothing, Laborers with de-watering systems, gunnite nozzle men, laborers tending masons with hot material or where foreign materials are used, Laborers handling masterplate or similar materials, laser beam operator, concrete burning machine operator, material selector men working with firebrick or combustible material, dynamite men, track laborers, cement handlers, chloride handlers, the unloading and laborers with steel workers and re-bars, concrete workers (wet), luteman, asphalt raker, curb asphalt machine operator, ready mix scalemen, permanent, portable or temporary plant drilling machine operator, plaster tenders, underpinning and shoring of buildings, fire watch, signaling of all power equipment, to include trucks excavating equipment, etc., tree topper or trimmer when in connection to construction, tunnel helpers in free air, batch dumpers, kettle and tar men, tank cleaners, plastic installers, scaffold workers, motorized buggies or motorized unit used for wet concrete or handling of building materials, sewer workers, rod and chain men, vibrator operators, mortar mixer operator, cement silica, clay, fly ash, lime and plasters, handlers (bulk or bag), cofferdam workers, on concrete paving, placing, cutting and tying of reinforcing, deck hand, dredge hand and shore laborers, bankmen on floating plant, asphalt workers with machine & layers, grade checker, power tools, caisson workers, lead man on sewer work, welders, cutters, burners and torch men, chain saw operators, paving breaker, jackhammer and drill operator, layout man and/or drainage tile layer, steel form setters -- street and highway, air tamping hammerman, signal man on crane, concrete saw operator, screen man on asphalt pavers, front end man on chip spreader, multiple concrete duct -- lead man.

#### LABORER, SKILLED - HIGHWAY

The skilled laborer heavy and highway (HWY) classification shall encompass the following types of work, irrespective of the site of the work: handling of materials treated with oil, creosote, asphalt and/or any foreign materials harmful to skin or clothing, track laborers, chloride handlers, the unloading and loading with steel workers and re-bars, concrete workers (wet), tunnel helpers in free air, batch dumpers, mason tenders, kettle and tar men, plastic installers, scaffold workers, motorized buggies or motorized unit used for wet concrete or handling of building materials, laborers with de-watering systems, sewer workers plus depth, rod and chainmen, vibrator operators, mortar mixer operators, cement silica, clay, fly ash, lime and plasters, handlers (bulk or bag), cofferdam workers plus depth, on concrete paving, placing, cutting and tying or reinforcing, deck hand, dredge hand shore laborers, bankmen on floating plant, asphalt workers with machine, and layers, grade checker, power tools, stripping of all concrete forms excluding paving forms, dumpmen and spotters, when necessary, caisson workers plus depth, gunnite nozzle men, welders, cutters, burners and torchmen, chain saw operators, paving breaker, jackhammer and drill operators, layout man and/or drainage tile layer, steel form setters - street and highway, air tamping hammerman, signal man on crane, concrete saw operator, screedman on asphalt pavers, front end man on chip spreader, multiple concrete duct, luteman, asphalt raker, curb asphalt machine operator, ready mix scalemen (portable or temporary plant), laser beam operator, concrete burning machine operator, and coring machine operator.

#### TRUCK DRIVER - BUILDING, HEAVY AND HIGHWAY CONSTRUCTION

Class 1. Drivers on 2 axle trucks hauling less than 9 ton. Air compressor and welding machines and brooms, including those pulled by separate units, truck driver helpers, warehouse employees, mechanic

helpers, greasers and tiremen, pickup trucks when hauling materials, tools, or workers to and from and on-the-job site, and fork lifts up to 6,000 lb. capacity.

Class 2. Two or three axle trucks hauling more than 9 ton but hauling less than 16 ton. A-frame winch trucks, hydrolift trucks, vactor trucks or similar equipment when used for transportation purposes. Fork lifts over 6,000 lb. capacity, winch trucks, four axle combination units, and ticket writers.

Class 3. Two, three or four axle trucks hauling 16 ton or more. Drivers on water pulls, articulated dump trucks, mechanics and working forepersons, and dispatchers. Five axle or more combination units.

Class 4. Low Boy and Oil Distributors.

Class 5. Drivers who require special protective clothing while employed on hazardous waste work.

#### TRUCK DRIVER - OIL AND CHIP RESEALING ONLY.

This shall encompass laborers, workers and mechanics who drive contractor or subcontractor owned, leased, or hired pickup, dump, service, or oil distributor trucks. The work includes transporting materials and equipment (including but not limited to, oils, aggregate supplies, parts, machinery and tools) to or from the job site; distributing oil or liquid asphalt and aggregate; stock piling material when in connection with the actual oil and chip contract. The Truck Driver (Oil & Chip Resealing) wage classification does not include supplier delivered materials.

#### OPERATING ENGINEERS - BUILDING

Class 1. Cranes; Overhead Cranes; Gradall; All Cherry Pickers; Mechanics; Central Concrete Mixing Plant Operator; Road Pavers (27E - Dual Drum - Tri Batchers); Blacktop Plant Operators and Plant Engineers; 3 Drum Hoist; Derricks; Hydro Cranes; Shovels; Skimmer Scoops; Koehring Scooper; Drag Lines; Backhoe; Derrick Boats; Pile Drivers and Skid Rigs; Clamshells; Locomotive Cranes; Dredge (all types) Motor Patrol; Power Blades - Dumore - Elevating and similar types; Tower Cranes (Crawler-Mobile) and Stationary; Crane-type Backfiller; Drott Yumbo and similar types considered as Cranes; Caisson Rigs; Dozer; Tournadozer; Work Boats; Ross Carrier; Helicopter; Tournapulls - all and similar types; Scoops (all sizes); Pushcats; Endloaders (all types); Asphalt Surfacing Machine; Slip Form Paver; Rock Crusher; Heavy Equipment Greaser; CMI, CMI Belt Placer, Auto Grade & 3 Track and similar types; Side Booms; Multiple Unit Earth Movers; Creter Crane; Trench Machine; Pump-crete-Belt Crete-Squeeze Cretes-Screw-type Pumps and Gypsum; Bulker & Pump - Operator will clean; Formless Finishing Machine; Flaherty Spreader or similar types; Screed Man on Laydown Machine; Wheel Tractors (industrial or Farm-type w/Dozer-Hoe-Endloader or other attachments); F.W.D. & Similar Types; Vermeer Concrete Saw.

Class 2. Dinkeys; Power Launches; PH One-pass Soil Cement Machine (and similar types); Pugmill with Pump; Backfillers; Euclid Loader; Forklifts; Jeeps w/Ditching Machine or other attachments; Tuneluger; Automatic Cement and Gravel Batching Plants; Mobile Drills (Soil Testing) and similar types; Gurries and Similar Types; (1) and (2) Drum Hoists (Buck Hoist and Similar Types); Chicago Boom; Boring Machine & Pipe Jacking Machine; Hydro Boom; Dewatering System; Straw Blower; Hydro Seeder; Assistant Heavy Equipment Greaser on Spread;

Tractors (Track type) without Power Unit pulling Rollers; Rollers on Asphalt -- Brick Macadam; Concrete Breakers; Concrete Spreaders; Mule Pulling Rollers; Center Stripper; Cement Finishing Machines & CMI Texture & Reel Curing Machines; Cement Finishing Machine; Barber Green or similar loaders; Vibro Tamper (All similar types) Self-propelled; Winch or Boom Truck; Mechanical Bull Floats; Mixers over 3 Bag to 27E; Tractor pulling Power Blade or Elevating Grader; Porter Rex Rail; Clary Screed; Truck Type Hoptoe Oilers; Fireman; Spray Machine on Paving; Curb Machines; Truck Crane Oilers; Oil Distributor; Truck-Mounted Saws.

Class 3. Air Compressor; Power Subgrader; Straight Tractor; Trac Air without attachments; Herman Nelson Heater, Dravo, Warner, Silent Glo, and similar types; Roller: Five (5) Ton and under on Earth or Gravel; Form Grader; Crawler Crane & Skid Rig Oilers; Freight Elevators - permanently installed; Pump; Light Plant; Generator; Conveyor (1) or (2) - Operator will clean; Welding Machine; Mixer (3) Bag and Under (Standard Capacity with skip); Bulk Cement Plant; Oiler on Central Concrete Mixing Plant.

#### OPERATING ENGINEERS - HEAVY AND HIGHWAY CONSTRUCTION

Class 1. Cranes; Hydro Crane; Shovels; Crane Type Backfiller; Tower Cranes - Mobile & Crawler & Stationary; Derricks & Hoists (3 Drum); Draglines; Drott Yumbo & similar types considered as Cranes; Back Hoe; Derrick Boats; Pile Driver and Skid Rigs; Clam Shell; Locomotive - Cranes; Road Pavers - Single Drum - Dual Drum - Tri Batcher; Motor Patrols & Power Blades - Dumore - Elevating & Similar Types; Mechanics; Central Concrete Mixing Plant Operator; Asphalt Batch Plant Operators and Plant Engineers; Gradall; Caisson Rigs; Skimmer Scoop - Koering Scooper; Dredges (all types); Hoptoe; All Cherry Pickers; Work Boat; Ross Carrier; Helicopter; Dozer; Tournadozer; Tournapulls - all and similar types; Multiple Unit Earth Movers; Scoops (all sizes); Pushcats; Endloaders (all types); Asphalt Surfacing Machine; Slip Form Paver; Rock Crusher; Heavy Equipment Greaser (top greaser on spread); CMI, Auto Grade, CMI Belt Placer & 3 Track and similar types; Side Booms; Starting Engineer on Pipeline; Asphalt Heater & Planer Combination (used to plane streets); Wheel Tractors (with dozer, hoe or endloader attachments); F.W.D. and Similar types; Blaw Knox Spreader and Similar types; Trench Machines; Pump Crete - Belt Crete - Squeeze Crete - screw type pumps and gypsum (operator will clean); Formless Finishing Machines; Flaherty Spreader or similar types; Screed Man on Laydown Machine; Vermeer Concrete Saw.

Class 2. Bulker & Pump; Power Launches; Boring Machine & Pipe Jacking Machine; Dinkeys; P-H One Pass Soil Cement Machines and similar types; Wheel Tractors (Industry or farm type - other); Back Fillers; Euclid Loader; Fork Lifts; Jeep w/Ditching Machine or other attachments; Tunneluger; Automatic Cement & Gravel Batching Plants; Mobile Drills - Soil Testing and similar types; Pugmill with pump; All (1) and (2) Drum Hoists; Dewatering System; Straw Blower; Hydro-Seeder; Boring Machine; Hydro-Boom; Bump Grinders (self-propelled); Assistant Heavy Equipment Greaser; Apsco Spreader; Tractors (track-type) without Power Units Pulling Rollers on Asphalt - Brick or Macadam; Concrete Breakers; Concrete Spreaders; Cement Strippers; Cement Finishing Machines & CMI Texture & Reel Curing Machines; Vibro-Tampers (all similar types self-propelled); Mechanical Bull Floats; Self-propelled Concrete Saws; Mixers-over three (3) bags to 27E; Winch and Boom Trucks; Tractor Pulling Power Blade or Elevating Grader; Porter Rex Rail; Clary Screed; Mule Pulling Rollers; Pugmill without Pump; Barber Greene or similar Loaders; Track Type Tractor w/Power Unit attached (minimum); Fireman; Spray Machine on Paving; Curb Machines; Paved Ditch Machine; Power Broom;

Self-Propelled Conveyors; Power Subgrader; Oil Distributor; Straight Tractor; Truck Crane Oiler; Truck Type Oilers; Directional boring machine; Horizontal directional drill.

Class 3. Straight framed articulating end dump vehicle and Truck mounted vac unit (separately powered); Trac Air Machine (without attachments); Herman Nelson Heater, Dravo Warner, Silent Glo & similar types; Rollers - five ton and under on earth and gravel; Form Graders; Pumps; Light Plant; Generator; Air Compressor (1) or (2); Conveyor; Welding Machine; Mixer - 3 bags and under; Bulk Cement Plant; Oilers.

#### Other Classifications of Work:

For definitions of classifications not otherwise set out, the Department generally has on file such definitions which are available. If a task to be performed is not subject to one of the classifications of pay set out, the Department will upon being contacted state which neighboring county has such a classification and provide such rate, such rate being deemed to exist by reference in this document. If no neighboring county rate applies to the task, the Department shall undertake a special determination, such special determination being then deemed to have existed under this determination. If a project requires these, or any classification not listed, please contact IDOL at 618/993-7271 for wage rates or clarifications.

#### LANDSCAPING

Landscaping work falls under the existing classifications for laborer, operating engineer and truck driver. The work performed by landscape plantsman and landscape laborer is covered by the existing classification of laborer. The work performed by landscape operators (regardless of equipment used or its size) is covered by the classifications of operating engineer. The work performed by landscape truck drivers (regardless of size of truck driven) is covered by the classifications of truck driver.

# Henry County Prevailing Wage for April 2007

Trade Name	RG	TYP	C	Base	FRMAN	*M-F>8	OSA	OSH	H/W	Pensn	Vac	Trng
=====	==	==	=	=====	=====	=====	==	==	=====	=====	=====	=====
ASBESTOS ABT-GEN		BLD		23.510	24.260	1.5	1.5	2.0	5.850	6.180	0.000	0.600
ASBESTOS ABT-GEN		HWY		22.940	23.440	1.5	1.5	2.0	5.850	5.850	0.000	0.700
ASBESTOS ABT-MEC		BLD		18.750	19.750	1.5	1.5	2.0	4.750	2.000	0.000	0.000
BOILERMAKER		BLD		30.970	33.970	2.0	2.0	2.0	8.270	7.740	0.000	0.300
BRICK MASON		BLD		29.500	30.500	1.5	1.5	5.0	6.070	6.000	0.000	0.400
CARPENTER		BLD		24.750	25.990	1.5	1.5	2.0	5.700	5.160	0.000	0.400
CARPENTER		HWY		25.540	27.290	1.5	1.5	2.0	5.860	6.260	0.000	0.400
CEMENT MASON		ALL		30.000	31.000	2.0	2.0	2.0	5.500	7.390	0.000	0.100
CERAMIC TILE FNSHER		BLD		24.860	0.000	1.5	1.5	2.0	5.500	4.000	0.000	0.360
COMMUNICATION TECH	SE	BLD		29.110	30.610	1.5	1.5	2.0	8.270	8.670	0.000	0.290
ELECTRIC PWR EQMT OP		ALL		30.750	0.000	1.5	1.5	2.0	4.750	8.610	0.000	0.000
ELECTRIC PWR GRNDMAN		ALL		21.090	0.000	1.5	1.5	2.0	4.750	5.905	0.000	0.000
ELECTRIC PWR LINEMAN		ALL		34.160	36.350	1.5	1.5	2.0	4.750	9.560	0.000	0.000
ELECTRIC PWR TRK DRV		ALL		22.130	0.000	1.5	1.5	2.0	4.750	6.200	0.000	0.000
ELECTRICIAN	NW	BLD		27.770	29.770	1.5	1.5	2.0	5.500	7.660	0.000	0.310
ELECTRICIAN	SE	BLD		33.950	37.010	1.5	1.5	2.0	8.570	11.01	0.000	0.340
ELECTRONIC SYS TECH	NW	BLD		19.800	21.400	1.5	1.5	2.0	5.880	4.040	0.000	0.310
ELEVATOR CONSTRUCTOR		BLD		33.140	37.280	2.0	2.0	2.0	8.275	6.060	1.990	0.000
GLAZIER		BLD		23.220	24.610	1.5	1.5	2.0	4.750	3.900	0.000	0.200
HT/FROST INSULATOR		BLD		25.860	27.060	1.5	1.5	2.0	4.800	7.500	0.000	0.000
IRON WORKER		ALL		23.100	24.950	1.5	1.5	2.0	8.040	7.990	0.000	0.420
LABORER		BLD		22.510	23.260	1.5	1.5	2.0	5.850	6.180	0.000	0.600
LABORER		HWY		21.940	22.440	1.5	1.5	2.0	5.850	5.850	0.000	0.600
LABORER, SKILLED		BLD		22.510	23.260	1.5	1.5	2.0	5.850	6.180	0.000	0.600
LABORER, SKILLED		HWY		22.240	22.740	1.5	1.5	2.0	5.850	5.850	0.000	0.600
LATHER		BLD		24.750	25.990	1.5	1.5	2.0	5.700	5.160	0.000	0.400
MACHINIST		BLD		36.890	38.890	2.0	2.0	2.0	4.380	5.650	2.550	0.000
MARBLE FINISHERS		BLD		24.860	0.000	1.5	1.5	2.0	5.500	4.000	0.000	0.360
MARBLE MASON		BLD		28.140	28.390	1.5	1.5	2.0	5.500	5.220	0.000	0.380
MILLWRIGHT	N	BLD		29.820	32.800	1.5	1.5	2.0	4.300	8.730	0.000	0.560
MILLWRIGHT	S	BLD		25.000	26.700	1.5	1.5	2.0	5.550	7.730	0.000	0.560
OPERATING ENGINEER	E	BLD	1	27.840	30.840	1.5	1.5	2.0	5.900	8.000	0.000	0.900
OPERATING ENGINEER	E	BLD	2	25.940	30.840	1.5	1.5	2.0	5.900	8.000	0.000	0.900
OPERATING ENGINEER	E	BLD	3	24.560	30.840	1.5	1.5	2.0	5.900	8.000	0.000	0.900
OPERATING ENGINEER	E	HWY	1	29.110	32.110	1.5	1.5	2.0	6.250	9.000	0.000	1.000
OPERATING ENGINEER	E	HWY	2	26.730	32.110	1.5	1.5	2.0	6.250	9.000	0.000	1.000
OPERATING ENGINEER	E	HWY	3	22.790	32.110	1.5	1.5	2.0	6.250	9.000	0.000	1.000
OPERATING ENGINEER	W	BLD	1	26.150	0.000	1.5	1.5	2.0	6.850	5.800	1.500	0.550
OPERATING ENGINEER	W	BLD	2	23.500	0.000	1.5	1.5	2.0	6.850	5.800	1.500	0.550
OPERATING ENGINEER	W	BLD	3	22.450	0.000	1.5	1.5	2.0	6.850	5.800	1.500	0.550
OPERATING ENGINEER	W	HWY	1	26.150	27.150	1.5	1.5	2.0	6.850	5.800	1.500	0.550
OPERATING ENGINEER	W	HWY	2	24.550	27.150	1.5	1.5	2.0	6.850	5.800	1.500	0.550
OPERATING ENGINEER	W	HWY	3	23.400	27.150	1.5	1.5	2.0	6.850	5.800	1.500	0.550
PAINTER		ALL		23.470	24.470	1.5	1.5	1.5	4.650	4.850	0.000	0.600
PAINTER OVER 30FT		ALL		24.720	25.720	1.5	1.5	1.5	4.650	4.850	0.000	0.600
PAINTER PWR EQMT		ALL		23.970	24.970	1.5	1.5	1.5	4.650	4.850	0.000	0.600
PILEDRIVER		BLD		24.750	25.990	1.5	1.5	2.0	5.700	5.160	0.000	0.400
PILEDRIVER		HWY		25.540	27.290	1.5	1.5	2.0	5.860	6.260	0.000	0.400
PIPEFITTER		ALL		30.520	33.570	1.5	1.5	2.0	4.800	7.960	0.000	0.530
PLASTERER		BLD		28.690	29.690	1.5	1.5	2.0	5.150	7.050	0.000	0.050
PLUMBER		ALL		30.520	33.570	1.5	1.5	2.0	4.800	7.960	0.000	0.530
ROOFER		BLD		22.850	24.100	1.5	1.5	2.0	5.840	4.870	0.000	0.190
SHEETMETAL WORKER		BLD		27.300	29.000	1.5	1.5	2.0	6.040	7.300	0.000	0.380
SPRINKLER FITTER		BLD		31.240	33.240	1.5	1.5	2.0	6.500	5.350	0.000	0.250
STONE MASON		BLD		29.500	30.500	1.5	1.5	5.0	6.070	6.000	0.000	0.400
TERRAZZO FINISHER		BLD		24.860	0.000	1.5	1.5	2.0	5.500	4.000	0.000	0.360
TILE LAYER		BLD		24.750	25.990	1.5	1.5	2.0	5.700	5.160	0.000	0.400
TILE MASON		BLD		28.140	28.390	1.5	1.5	2.0	5.500	5.220	0.000	0.380



TRUCK DRIVER	ALL	1	25.930	0.000	1.5	1.5	2.0	7.250	3.425	0.000	0.000
TRUCK DRIVER	ALL	2	26.333	0.000	1.5	1.5	2.0	7.250	3.425	0.000	0.000
TRUCK DRIVER	ALL	3	26.530	0.000	1.5	1.5	2.0	7.250	3.425	0.000	0.000
TRUCK DRIVER	ALL	4	26.780	0.000	1.5	1.5	2.0	7.250	3.425	0.000	0.000
TRUCK DRIVER	ALL	5	27.530	0.000	1.5	1.5	2.0	7.250	3.425	0.000	0.000
TRUCK DRIVER	O&C	1	20.740	0.000	1.5	1.5	2.0	7.250	3.425	0.000	0.000
TRUCK DRIVER	O&C	2	21.060	0.000	1.5	1.5	2.0	7.250	3.425	0.000	0.000
TRUCK DRIVER	O&C	3	21.220	0.000	1.5	1.5	2.0	7.250	3.425	0.000	0.000
TRUCK DRIVER	O&C	4	21.420	0.000	1.5	1.5	2.0	7.250	3.425	0.000	0.000
TRUCK DRIVER	O&C	5	22.020	0.000	1.5	1.5	2.0	7.250	3.425	0.000	0.000
TUCKPOINTER	BLD		29.500	30.500	1.5	1.5	5.0	6.070	6.000	0.000	0.400

Legend:

M-F>8 (Overtime is required for any hour greater than 8 worked each day, Monday through Friday.)

OSA (Overtime is required for every hour worked on Saturday)

OSH (Overtime is required for every hour worked on Sunday and Holidays)

H/W (Health & Welfare Insurance)

Pensn (Pension)

Vac (Vacation)

Trng (Training)

## Explanations

HENRY COUNTY

COMMUNICATIONS TECHNICIAN (SE) - Townships of Annawan, Cambridge, Burns, Kewanee, Weller, Galva, and Wethersfield.

ELECTRICIANS AND ELECTRONIC SYSTEMS TECHNICIAN (NW) - That portion North and West of Annawan, Burns, Cambridge, and Weller Townships.

MILLWRIGHT (NORTH) - North of interstate 80.

OPERATING ENGINEERS (EAST) - The eastern half of the county divided by highway 82 excluding Geneseo.

The following list is considered as those days for which holiday rates of wages for work performed apply: New Years Day, Memorial/Decoration Day, Fourth of July, Labor Day, Veterans Day, Thanksgiving Day, Christmas Day. Generally, any of these holidays which fall on a Sunday is celebrated on the following Monday. This then makes work performed on that Monday payable at the appropriate overtime rate for holiday pay. Common practice in a given local may alter certain days of celebration such as the day after Thanksgiving for Veterans Day. If in doubt, please check with IDOL.

Oil and chip resealing (O&C) means the application of road oils and liquid asphalt to coat an existing road surface, followed by application of aggregate chips or gravel to coated surface, and subsequent rolling of material to seal the surface.

EXPLANATION OF CLASSES

ASBESTOS - GENERAL - removal of asbestos material/mold and hazardous materials from any place in a building, including mechanical systems where those mechanical systems are to be removed. This includes the removal of asbestos materials/mold and hazardous materials from ductwork or pipes in a building when the building is to be demolished at the time or at some close future date.

ASBESTOS - MECHANICAL - removal of asbestos material from mechanical systems, such as pipes, ducts, and boilers, where the mechanical systems are to remain.

#### CERAMIC TILE FINISHER, MARBLE FINISHER, TERRAZO FINISHER

Assisting, helping or supporting the tile, marble and terrazzo mechanic by performing their historic and traditional work assignments required to complete the proper installation of the work covered by said crafts. The term "Ceramic" is used for naming the classification only and is in no way a limitation of the product handled. Ceramic takes into consideration most hard tiles.

#### COMMUNICATIONS TECHNICIAN - Southeast

Installation, operation, inspection, maintenance, repair and service of radio, television, recording, voice, sound and vision production and reproduction, telephone and telephone interconnect, facsimile, equipment and appliances used for domestic, commercial, educational and entertainment purposes, pulling of wire through conduit but not the installation of conduit.

#### ELECTRONIC SYSTEMS TECHNICIAN - Northwest

Installing, assembling and maintaining sound and intercom, protection alarm (security), master antenna television, closed circuit television, computer hardware and software programming and installation to the network's outlet and input (EXCLUDING all cabling, power and cable termination work historically performed by wiremen), door monitoring and control, nurse and emergency call programming and installation to the system's outlet and input (EXCLUDING all cabling, power and cable termination work historically performed by wiremen), clock and timing; and the installation and maintenance of transmit and receive antennas, transmitters, receivers, and associated apparatus which operates in conjunction with the above systems. All work associated with these system installations will be included EXCEPT (1) installation of protective metallic conduit, excluding less than ten-foot runs strictly for protection of cable, and (2) 120 volt AC (or higher) power wiring and associated hardware.

#### LABORER, SKILLED - BUILDING

The skilled laborer building (BLD) classification shall encompass the following types of work, irrespective of the site of the work: tending of carpenters in unloading, handling, stockpiling and distribution operations, also other building crafts, mixing, handling, and conveying of all materials used by masons, plasterers and other building construction crafts, whether done by hand or by any process. The drying of plastering when done by salamander heat, and the cleaning and clearing of all debris. All work pertaining to and in preparation of asbestos abatement and removal. The building of scaffolding and staging for masons and plasterers. The excavations for buildings and all other construction, digging, of trenches, piers, foundations and holes, digging, lagging, sheeting, cribbing, bracing and propping of foundations, holes, caissons, cofferdams, and dikes, the setting of all guidelines for machine or hand excavation and

subgrading. The mixing, handling, conveying, pouring, vibrating, gunniting and otherwise applying of concrete, whether by hand or other method of concrete for any walls, foundations, floors, or for other construction concrete sealant men. The wrecking, stripping, dismantling, and handling of concrete forms and false work, and the building of centers for fireproofing purposes. Boring machine, gas, electric or air in preparation for shoving pipe, telephone cable, and so forth, under highways, roads, streets and alleys. All hand and power operating cross cut saws when used for clearing. All work in compressed air construction. All work on acetylene burners in salvaging. The blocking and tamping of concrete. The laying of sewer tile and conduit, and pre-cast materials. The assembling and dismantling of all jacks and sectional scaffolding, including elevator construction and running of slip form jacks. The work of drill running and blasting, including wagon drills. The wrecking, stripping, dismantling, cleaning, moving and oiling of forms. The cutting off of concrete piles. The loading, unloading, handling and carrying to place of installation of all rods, (and materials for use in reinforcing) concrete and the hoisting of same and all signaling where hoist is used in this type of construction coming under the jurisdiction of the Laborers' Union. And, all other labor work not awarded to any other craft. Mortar mixers, kettlemen and carrier of hot stuff, tool crib men, watchmen (Laborer), firemen or salamander tenders, flagmen, deck hands, installation and maintenance of temporary gas-fired heating units, gravel box men, dumpmen and spotters, fencing Laborers, cleaning lumber, pit men, material checkers, dispatchers, unloading explosives, asphalt plant laborers, writer of scale tickets, fireproofing laborers, janitors, asbestos abatement and removal laborers, handling of materials treated with oil, creosote, chloride, asphalt, and/or foreign material harmful to skin or clothing, Laborers with de-watering systems, gunnite nozzle men, laborers tending masons with hot material or where foreign materials are used, Laborers handling masterplate or similar materials, laser beam operator, concrete burning machine operator, material selector men working with firebrick or combustible material, dynamite men, track laborers, cement handlers, chloride handlers, the unloading and laborers with steel workers and re-bars, concrete workers (wet), luteman, asphalt raker, curb asphalt machine operator, ready mix scalemen, permanent, portable or temporary plant drilling machine operator, plaster tenders, underpinning and shoring of buildings, fire watch, signaling of all power equipment, to include trucks excavating equipment, etc., tree topper or trimmer when in connection to construction, tunnel helpers in free air, batch dumpers, kettle and tar men, tank cleaners, plastic installers, scaffold workers, motorized buggies or motorized unit used for wet concrete or handling of building materials, sewer workers, rod and chain men, vibrator operators, mortar mixer operator, cement silica, clay, fly ash, lime and plasters, handlers (bulk or bag), cofferdam workers, on concrete paving, placing, cutting and tying of reinforcing, deck hand, dredge hand and shore laborers, bankmen on floating plant, asphalt workers with machine & layers, grade checker, power tools, caisson workers, lead man on sewer work, welders, cutters, burners and torch men, chain saw operators, paving breaker, jackhammer and drill operator, layout man and/or drainage tile layer, steel form setters -- street and highway, air tamping hammerman, signal man on crane, concrete saw operator, screen man on asphalt pavers, front end man on chip spreader, multiple concrete duct -- lead man.

#### LABORER, SKILLED - HIGHWAY

The skilled laborer heavy and highway (HWY) classification shall encompass the following types of work, irrespective of the site of the work: handling of materials treated with oil, creosote, asphalt

and/or any foreign materials harmful to skin or clothing, track laborers, chloride handlers, the unloading and loading with steel workers and re-bars, concrete workers (wet), tunnel helpers in free air, batch dumpers, mason tenders, kettle and tar men, plastic installers, scaffold workers, motorized buggies or motorized unit used for wet concrete or handling of building materials, laborers with de-watering systems, sewer workers plus depth, rod and chainmen, vibrator operators, mortar mixer operators, cement silica, clay, fly ash, lime and plasters, handlers (bulk or bag), cofferdam workers plus depth, on concrete paving, placing, cutting and tying or reinforcing, deck hand, dredge hand shore laborers, bankmen on floating plant, asphalt workers with machine, and layers, grade checker, power tools, stripping of all concrete forms excluding paving forms, dumpmen and spotters, when necessary, caisson workers plus depth, gunnite nozzle men, welders, cutters, burners and torchmen, chain saw operators, paving breaker, jackhammer and drill operators, layout man and/or drainage tile layer, steel form setters - street and highway, air tamping hammerman, signal man on crane, concrete saw operator, screedman on asphalt pavers, front end man on chip spreader, multiple concrete duct, luteman, asphalt raker, curb asphalt machine operator, ready mix scalemen (portable or temporary plant), laser beam operator, concrete burning machine operator, and coring machine operator.

#### TRUCK DRIVER - BUILDING, HEAVY AND HIGHWAY CONSTRUCTION

Class 1. Drivers on 2 axle trucks hauling less than 9 ton. Air compressor and welding machines and brooms, including those pulled by separate units, truck driver helpers, warehouse employees, mechanic helpers, greasers and tiremen, pickup trucks when hauling materials, tools, or workers to and from and on-the-job site, and fork lifts up to 6,000 lb. capacity.

Class 2. Two or three axle trucks hauling more than 9 ton but hauling less than 16 ton. A-frame winch trucks, hydrolift trucks, vector trucks or similar equipment when used for transportation purposes. Fork lifts over 6,000 lb. capacity, winch trucks, four axle combination units, and ticket writers.

Class 3. Two, three or four axle trucks hauling 16 ton or more. Drivers on water pulls, articulated dump trucks, mechanics and working forepersons, and dispatchers. Five axle or more combination units.

Class 4. Low Boy and Oil Distributors.

Class 5. Drivers who require special protective clothing while employed on hazardous waste work.

#### TRUCK DRIVER - OIL AND CHIP RESEALING ONLY.

This shall encompass laborers, workers and mechanics who drive contractor or subcontractor owned, leased, or hired pickup, dump, service, or oil distributor trucks. The work includes transporting materials and equipment (including but not limited to, oils, aggregate supplies, parts, machinery and tools) to or from the job site; distributing oil or liquid asphalt and aggregate; stock piling material when in connection with the actual oil and chip contract. The Truck Driver (Oil & Chip Resealing) wage classification does not include supplier delivered materials.

#### OPERATING ENGINEERS - BUILDING - EAST

Class 1. Cranes; Overhead Cranes; Gradall; All Cherry Pickers; Mechanics; Central Concrete Mixing Plant Operator; Road Pavers (27E - Dual Drum - Tri Batchers); Blacktop Plant Operators and Plant

Engineers; 3 Drum Hoist; Derricks; Hydro Cranes; Shovels; Skimmer Scoops; Koehring Scooper; Drag Lines; Backhoe; Derrick Boats; Pile Drivers and Skid Rigs; Clamshells; Locomotive Cranes; Dredge (all types) Motor Patrol; Power Blades - Dumore - Elevating and similar types; Tower Cranes (Crawler-Mobile) and Stationary; Crane-type Backfiller; Drott Yumbo and similar types considered as Cranes; Caisson Rigs; Dozer; Tournadozer; Work Boats; Ross Carrier; Helicopter; Tournapulls - all and similar types; Scoops (all sizes); Pushcats; Endloaders (all types); Asphalt Surfacing Machine; Slip Form Paver; Rock Crusher; Heavy Equipment Greaser; CMI, CMI Belt Placer, Auto Grade & 3 Track and similar types; Side Booms; Multiple Unit Earth Movers; Creter Crane; Trench Machine; Pump-crete-Belt Crete-Squeeze Cretes-Screw-type Pumps and Gypsum; Bulker & Pump - Operator will clean; Formless Finishing Machine; Flaherty Spreader or similar types; Screed Man on Laydown Machine; Wheel Tractors (industrial or Farm-type w/Dozer-Hoe-Endloader or other attachments); F.W.D. & Similar Types; Vermeer Concrete Saw.

Class 2. Dinkeys; Power Launches; PH One-pass Soil Cement Machine (and similar types); Pugmill with Pump; Backfillers; Euclid Loader; Forklifts; Jeeps w/Ditching Machine or other attachments; Tuneluger; Automatic Cement and Gravel Batching Plants; Mobile Drills (Soil Testing) and similar types; Gurries and Similar Types; (1) and (2) Drum Hoists (Buck Hoist and Similar Types); Chicago Boom; Boring Machine & Pipe Jacking Machine; Hydro Boom; Dewatering System; Straw Blower; Hydro Seeder; Assistant Heavy Equipment Greaser on Spread; Tractors (Track type) without Power Unit pulling Rollers; Rollers on Asphalt -- Brick Macadem; Concrete Breakers; Concrete Spreaders; Mule Pulling Rollers; Center Stripper; Cement Finishing Machines & CMI Texture & Reel Curing Machines; Cement Finishing Machine; Barber Green or similar loaders; Vibro Tamper (All similar types) Self-propelled; Winch or Boom Truck; Mechanical Bull Floats; Mixers over 3 Bag to 27E; Tractor pulling Power Blade or Elevating Grader; Porter Rex Rail; Clary Screed; Truck Type Hoptoe Oilers; Fireman; Spray Machine on Paving; Curb Machines; Truck Crane Oilers; Oil Distributor; Truck-Mounted Saws.

Class 3. Air Compressor; Power Subgrader; Straight Tractor; Trac Air without attachments; Herman Nelson Heater, Dravo, Warner, Silent Glo, and similar types; Roller: Five (5) Ton and under on Earth or Gravel; Form Grader; Crawler Crane & Skid Rig Oilers; Freight Elevators - permanently installed; Pump; Light Plant; Generator; Conveyor (1) or (2) - Operator will clean; Welding Machine; Mixer (3) Bag and Under (Standard Capacity with skip); Bulk Cement Plant; Oiler on Central Concrete Mixing Plant.

#### OPERATING ENGINEERS - HEAVY AND HIGHWAY CONSTRUCTION - EAST

Class 1. Cranes; Hydro Crane; Shovels; Crane Type Backfiller; Tower Cranes - Mobile & Crawler & Stationary; Derricks & Hoists (3 Drum); Draglines; Drott Yumbo & similar types considered as Cranes; Back Hoe; Derrick Boats; Pile Driver and Skid Rigs; Clam Shell; Locomotive - Cranes; Road Pavers - Single Drum - Dual Drum - Tri Batcher; Motor Patrols & Power Blades - Dumore - Elevating & Similar Types; Mechanics; Central Concrete Mixing Plant Operator; Asphalt Batch Plant Operators and Plant Engineers; Gradall; Caisson Rigs; Skimmer Scoop - Koehring Scooper; Dredges (all types); Hoptoe; All Cherry Pickers; Work Boat; Ross Carrier; Helicopter; Dozer; Tournadozer; Tournapulls - all and similar types; Multiple Unit Earth Movers; Scoops (all sizes); Pushcats; Endloaders (all types); Asphalt Surfacing Machine; Slip Form Paver; Rock Crusher; Heavy Equipment Greaser (top greaser on spread); CMI, Auto Grade, CMI Belt Placer & 3 Track and similar types; Side Booms; Starting Engineer on Pipeline; Asphalt Heater &

Planer Combination (used to plane streets); Wheel Tractors (with dozer, hoe or endloader attachments); F.W.D. and Similar types; Blaw Knox Spreader and Similar types; Trench Machines; Pump Crete - Belt Crete - Squeeze Crete - screw type pumps and gypsum (operator will clean); Formless Finishing Machines; Flaherty Spreader or similar types; Screed Man on Laydown Machine; Vermeer Concrete Saw.

Class 2. Bulker & Pump; Power Launches; Boring Machine & Pipe Jacking Machine; Dinkeys; P-H One Pass Soil Cement Machines and similar types; Wheel Tractors (Industry or farm type - other); Back Fillers; Euclid Loader; Fork Lifts; Jeep w/Ditching Machine or other attachments; Tunneluger; Automatic Cement & Gravel Batching Plants; Mobile Drills - Soil Testing and similar types; Pugmill with pump; All (1) and (2) Drum Hoists; Dewatering System; Straw Blower; Hydro-Seeder; Boring Machine; Hydro-Boom; Bump Grinders (self-propelled); Assistant Heavy Equipment Greaser; Apsco Spreader; Tractors (track-type) without Power Units Pulling Rollers on Asphalt - Brick or Macadam; Concrete Breakers; Concrete Spreaders; Cement Strippers; Cement Finishing Machines & CMI Texture & Reel Curing Machines; Vibro-Tampers (all similar types self-propelled); Mechanical Bull Floats; Self-propelled Concrete Saws; Mixers-over three (3) bags to 27E; Winch and Boom Trucks; Tractor Pulling Power Blade or Elevating Grader; Porter Rex Rail; Clary Screed; Mule Pulling Rollers; Pugmill without Pump; Barber Greene or similar Loaders; Track Type Tractor w/Power Unit attached (minimum); Fireman; Spray Machine on Paving; Curb Machines; Paved Ditch Machine; Power Broom; Self-Propelled Conveyors; Power Subgrader; Oil Distributor; Straight Tractor; Truck Crane Oiler; Truck Type Oilers; Directional boring machine; Horizontal directional drill.

Class 3. Straight framed articulating end dump vehicles and Truck mounted vac unit (separately powered); Trac Air Machine (without attachments); Herman Nelson Heater, Dravo Warner, Silent Glo & similar types; Rollers - five ton and under on earth and gravel; Form Graders; Pumps; Light Plant; Generator; Air Compressor (1) or (2); Conveyor; Welding Machine; Mixer - 3 bags and under; Bulk Cement Plant; Oilers.

#### OPERATING ENGINEERS - BUILDING, HEAVY AND HIGHWAY CONSTRUCTION - WEST

Class 1. An engineer on Crane, Shovel, Clamshell, Dragline, Backhoe, Derrick, Tower Crane, Cable Way, Concrete Spreader (servicing two pavers), Asphalt Spreader, Asphalt Mixer, Plant Engineer, Dipper Dredge Operator, Dipper Dredge Craneman, Dual Purpose Truck (boom or winch), Leverman or Engineman (hydraulic dredge), Mechanic, Paving Mixer with tower attached, Pile Driver, Boom Tractor, Stationary, Portable or Floating Mixing Plant, Trenching Machine (over 40 H.P.), Building Hoist (two drums), Hot Paint Wrapping Machine, Cleaning and Priming Machine, Backfiller (throw bucket), Locomotive Engineer, Qualified Welder, Tow or Push Boat, Concrete Paver, Seaman Trav-L-Plant or similar machines, CMI Autograder or similar machines, Slip Form Paver, Caisson Augering Machine, Mucking Machine, Asphalt Heater-Planer Unit, Hydraulic Cranes, Mine Hoists. An engineer on Athey, Barber-Green, Euclid or Haiss Loader, Asphalt Pug Mill, Fireman and Drier, Concrete Pump, Concrete Spreader (servicing one paver) Bulldozer, Endloader, Log Chippers or similar machines, Elevating Grader, Group Equipment Greaser, LeTourneapul and similar machines, off-road haul units, DW-10 Hyster Winch and similar machines, Motor Patrol, Power Blade, Push Cat, Tractor Pulling elevating Grader or Power Blade, Tractor Operating Scoop or Scraper, Tractor with Power Attachment, Roller on Asphalt or Blacktop, Single Drum Hoist, Jaeger Mix and Place Machine, Pipe Bending Machine, Flexaplane or similar machines, Automatic Curbing Machines, Automatic Cement and Gravel

Batch Plants (one stop set-up), Seaman Pulvi-Mixer or similar machines, Blastholer Self-propelled Rotary Drill or similar machines, Work Boat, Combination Concrete Finishing Machine and Float, Self-propelled Sheep Foot Roller or Compactor (used in conjunction with a Grading Spread), Asphalt Spreader Screed Operator, Apsco spreader or similar machine, Slusher, Forklift (over 6000 lb. cap. or working at heights above 28 ft.) Concrete Conveyors, Chip Spreader, Underground Boring Machine (BUILDING ONLY), Straddle Carrier, Hydro-Hammer (BUILDING ONLY), Hydraulic Pumps or Power Units Driven by any power source (except manually), used to hoist or lift machinery or material.

Class 2. An engineer on Asphalt Booster, Fireman and Pump Operator at Asphalt Plant, Mud Jack, Underground Boring Machine (HIGHWAY ONLY), Concrete Finishing Machine, Form Grader with Roller on Earth, Mixers (3 bag to 16E), Power Operated Bull Float, Tractor without Power attachment, Dope Pot (agitating motor), Dope Chop Machine, Distributor (back end), Straddle Carrier, Portable Machine Fireman, Hydro-Hammer (HIGHWAY ONLY), Power Winch on Paving Work, Self-propelled Roller or Compactor (other than provided for above), Pump Operator (more than one well-point pump), Portable Crusher Operator, Trench Machine (under 40 H.P.), Power Subgrader (on forms) or similar machines, Forklift (6000 or less cap.) Gypsum Pump, Conveyor over 20 H.P., Fuller Kenyon Cement Pump or similar machines. An engineer on Air Compressor (400 c.f.m. or over HIGHWAY ONLY), Light Plant, Mixers (1 or 2 bag), Power Batching Machine (Cement Auger or Conveyor), Boiler (Engineer or Fireman), Water Pumps (HIGHWAY ONLY), Mechanical Broom, Automatic Cement and Gravel Batch Plants (two or three stop set-up), Small Rubber-tired Tractors (not including backhoes or endloaders), Self-propelled Curing Machine, Brush Chipper, Driver on Truck Crane or similar machines.

Class 3. Oiler, Mechanic's Helper, Mechanical Heater (other than steam boiler), Belt Machine, Small Outboard Motor Boats (Safety Boat and Life Boat), Engine Driven Welding Machine, and Small Tractors (used to unroll or roll wire mesh), Water pumps (BUILDING ONLY), Air Compressors (BUILDING ONLY), Permanent Automatic Elevators.

#### Other Classifications of Work:

For definitions of classifications not otherwise set out, the Department generally has on file such definitions which are available. If a task to be performed is not subject to one of the classifications of pay set out, the Department will upon being contacted state which neighboring county has such a classification and provide such rate, such rate being deemed to exist by reference in this document. If no neighboring county rate applies to the task, the Department shall undertake a special determination, such special determination being then deemed to have existed under this determination. If a project requires these, or any classification not listed, please contact IDOL at 618/993-7271 for wage rates or clarifications.

#### LANDSCAPING

Landscaping work falls under the existing classifications for laborer, operating engineer and truck driver. The work performed by landscape plantsman and landscape laborer is covered by the existing classification of laborer. The work performed by landscape operators (regardless of equipment used or its size) is covered by the classifications of operating engineer. The work performed by landscape truck drivers (regardless of size of truck driven) is covered by the classifications of truck driver.

# Iroquois County Prevailing Wage for April 2007

Trade Name	RG	TYP	C	Base	FRMAN	*M-F>8	OSA	OSH	H/W	Pensn	Vac	Trng
=====	==	===	=	=====	=====	=====	===	===	=====	=====	=====	=====
ASBESTOS ABT-GEN		BLD		25.180	26.180	1.5	1.5	2.0	5.850	6.670	0.000	0.750
ASBESTOS ABT-GEN		HWY		25.790	26.790	1.5	1.5	2.0	5.850	6.670	0.000	0.750
ASBESTOS ABT-MEC		BLD		23.300	24.800	1.5	1.5	2.0	7.860	4.910	0.000	0.000
BOILERMAKER		BLD		30.970	33.970	2.0	2.0	2.0	8.270	7.740	0.000	0.300
BRICK MASON		BLD		31.850	33.850	1.5	1.5	2.0	5.500	8.000	0.000	0.430
CARPENTER		BLD		30.900	32.400	1.5	1.5	2.0	5.860	7.950	0.000	0.490
CARPENTER		HWY		29.580	31.330	1.5	1.5	2.0	4.950	7.200	0.000	0.490
CEMENT MASON		BLD		31.850	33.850	1.5	1.5	2.0	5.500	8.000	0.000	0.430
CERAMIC TILE FNSHER		BLD		28.670	0.000	1.5	1.5	2.0	5.500	8.000	0.000	0.430
COMMUNICATION TECH		BLD		29.110	30.610	1.5	1.5	2.0	8.270	8.670	0.000	0.290
ELECTRICIAN	NE	BLD		33.950	37.010	1.5	1.5	2.0	8.570	11.01	0.000	0.340
ELECTRICIAN	SW	BLD		32.010	34.010	1.5	1.5	2.0	5.150	5.410	0.000	0.480
ELEVATOR CONSTRUCTOR		BLD		32.885	37.000	2.0	2.0	2.0	7.775	5.090	1.970	0.000
GLAZIER		BLD		26.320	27.070	1.5	1.5	2.0	5.650	5.750	0.000	0.350
HT/FROST INSULATOR		BLD		33.300	35.050	1.5	1.5	2.0	7.860	8.610	0.000	0.310
IRON WORKER		ALL		30.000	33.000	2.0	2.0	2.0	7.690	10.46	0.000	0.550
LABORER		BLD		23.280	24.280	1.5	1.5	2.0	5.700	5.500	0.000	0.600
LABORER		HWY		24.790	25.790	1.5	1.5	2.0	5.850	6.670	0.000	0.600
LABORER, SKILLED		BLD		24.480	25.480	1.5	1.5	2.0	5.850	6.670	0.000	0.600
LABORER, SKILLED		HWY		24.790	25.790	1.5	1.5	2.0	5.850	6.670	0.000	0.600
LATHER		BLD		30.900	32.400	1.5	1.5	2.0	5.860	7.950	0.000	0.490
MACHINIST		BLD		36.890	38.890	2.0	2.0	2.0	4.380	5.650	2.550	0.000
MARBLE FINISHERS		BLD		28.670	0.000	1.5	1.5	2.0	5.500	8.000	0.000	0.430
MARBLE MASON		BLD		31.850	33.850	1.5	1.5	2.0	5.500	8.000	0.000	0.430
MILLWRIGHT		BLD		30.900	32.400	1.5	1.5	2.0	5.860	7.950	0.000	0.490
OPERATING ENGINEER	ALL	1		28.650	0.000	1.5	1.5	2.0	5.200	6.750	0.000	0.650
OPERATING ENGINEER	ALL	2		18.600	0.000	1.5	1.5	2.0	5.200	6.750	0.000	0.650
PAINTER	ALL			26.850	27.850	1.5	1.5	1.5	5.650	5.750	0.000	0.350
PAINTER SIGNS	BLD			28.970	32.520	1.5	1.5	1.5	2.600	2.310	0.000	0.000
PILEDRIIVER	BLD			30.900	32.400	1.5	1.5	2.0	5.860	7.950	0.000	0.490
PIPEFITTER	BLD			36.060	38.060	1.5	1.5	2.0	7.050	8.500	0.000	0.760
PLASTERER	BLD			31.850	33.850	1.5	1.5	2.0	5.500	8.000	0.000	0.430
PLUMBER	BLD			36.060	38.060	1.5	1.5	2.0	7.050	8.500	0.000	0.760
ROOFER	BLD			33.650	35.650	1.5	1.5	2.0	6.460	3.310	0.000	0.330
SHEETMETAL WORKER	BLD			36.510	38.510	1.5	1.5	2.0	6.890	8.020	0.000	0.640
SIGN HANGER	BLD			30.900	32.400	1.5	1.5	2.0	5.860	7.950	0.000	0.490
SPRINKLER FITTER	BLD			31.240	33.240	1.5	1.5	2.0	6.500	5.350	0.000	0.250
TERRAZZO FINISHER	BLD			28.670	0.000	1.5	1.5	2.0	5.500	8.000	0.000	0.430
TERRAZZO MASON	BLD			31.850	33.850	1.5	1.5	2.0	5.500	8.000	0.000	0.430
TILE MASON	BLD			31.850	33.850	1.5	1.5	2.0	5.500	8.000	0.000	0.430
TRUCK DRIVER	NW	ALL	1	28.870	29.420	1.5	1.5	2.0	6.690	4.150	0.000	0.000
TRUCK DRIVER	NW	ALL	2	29.070	29.420	1.5	1.5	2.0	6.690	4.150	0.000	0.000
TRUCK DRIVER	NW	ALL	3	29.270	29.420	1.5	1.5	2.0	6.690	4.150	0.000	0.000
TRUCK DRIVER	NW	ALL	4	29.420	29.420	1.5	1.5	2.0	6.690	4.150	0.000	0.000
TRUCK DRIVER	SE	ALL	1	25.787	0.000	1.5	1.5	2.0	7.250	3.317	0.000	0.000
TRUCK DRIVER	SE	ALL	2	26.187	0.000	1.5	1.5	2.0	7.250	3.317	0.000	0.000
TRUCK DRIVER	SE	ALL	3	26.387	0.000	1.5	1.5	2.0	7.250	3.317	0.000	0.000
TRUCK DRIVER	SE	ALL	4	26.637	0.000	1.5	1.5	2.0	7.250	3.317	0.000	0.000
TRUCK DRIVER	SE	ALL	5	27.387	0.000	1.5	1.5	2.0	7.250	3.317	0.000	0.000
TUCKPOINTER	BLD			31.850	33.850	1.5	1.5	2.0	5.500	8.000	0.000	0.430

Legend:

M-F>8 (Overtime is required for any hour greater than 8 worked each day, Monday through Friday.)

OSA (Overtime is required for every hour worked on Saturday)



OSH (Overtime is required for every hour worked on Sunday and Holidays)

H/W (Health & Welfare Insurance)

Pensn (Pension)

Vac (Vacation)

Trng (Training)

## Explanations

### IROQUOIS COUNTY

ELECTRICIANS (SOUTHWEST) - Townships of Artesia, Loda and Pigeon Grove.

TRUCK DRIVER (SOUTHEAST) - Pigeon Grove, Fountain Creek, Lovejoy, Prairie Green, Milford and Stockland Townships.

The following list is considered as those days for which holiday rates of wages for work performed apply: New Years Day, Memorial/Decoration Day, Fourth of July, Labor Day, Veterans Day, Thanksgiving Day, Christmas Day. Generally, any of these holidays which fall on a Sunday is celebrated on the following Monday. This then makes work performed on that Monday payable at the appropriate overtime rate for holiday pay. Common practice in a given local may alter certain days of celebration such as the day after Thanksgiving for Veterans Day. If in doubt, please check with IDOL.

### EXPLANATION OF CLASSES

ASBESTOS - GENERAL - removal of asbestos material/mold and hazardous materials from any place in a building, including mechanical systems where those mechanical systems are to be removed. This includes the removal of asbestos materials/mold and hazardous materials from ductwork or pipes in a building when the building is to be demolished at the time or at some close future date.

ASBESTOS - MECHANICAL - removal of asbestos material from mechanical systems, such as pipes, ducts, and boilers, where the mechanical systems are to remain.

### CERAMIC TILE FINISHER, MARBLE FINISHER, AND TERRAZZO FINISHER

The laying, setting and finishing of all tile where used for floors, walls, ceilings, walks, promenade roofs, stair treads, stair risers, facings, hearths, fireplaces, and decorative inserts, together with any marble plinths, thresholds or window stools used in connection with any tile work; also to prepare and set all concrete, cement, brickwork, or other foundation or materials that may be required to properly set and complete such work; the setting or bedding of all tiling, stone, marble, composition, glass, mosaic, or other materials forming the facing, hearth or fireplace of a mantle, or the mantle complete, together with the setting of all cement, brickwork, or other material required in connection with the above work; also the slabbing and fabrication of tile mantels, counters and tile panels of every description and the erection and installation of same and the building, shaping, forming, construction, or repairing of all fireplace work, whether in connection with the mantle hearth facing or not, and the setting and preparing of all material, such as cement, plaster, mortar, brickwork, iron work or other materials necessary for

the proper and safe construction and completion of such work. The term "Ceramic" is used for naming the classification only and is in no way a limitation of the product handled. Ceramic takes into consideration most hard tiles.

#### COMMUNICATIONS TECHNICIAN

Installation, operation, inspection, maintenance, repair and service of radio, television, recording, voice, sound and vision production and reproduction, telephone and telephone interconnect, facsimile, equipment and appliances used for domestic, commercial, educational and entertainment purposes, pulling of wire through conduit but not the installation of conduit.

#### LABORER, SKILLED - BUILDING

The skilled laborer building (BLD) classification shall encompass the following types of work, irrespective of the site of the work: caisson workers plus depth, gunnite nozzle men, lead man on sewer work, welders, cutters, burners and torchmen, chain saw operators, paving breaker, jackhammer and drill operators, layout man and/or drainage tile layer, steel form setters - street and highway, air tamping hammerman, signal man on crane, concrete saw operator, screenman on asphalt pavers, front end man on chip spreader, laborers tending masons with hot materials or where foreign materials are used, multiple concrete duct-leadman, luteman, asphalt raker, curb asphalt machine operator, ready mix scalemen (permanent, portable or temporary plant), laborers handling masterplate or similar materials, laser beam operator, concrete burning machine operator, coring machine operator, plaster tenders, underpinning and shoring of buildings, material selector when working with fire-brick or castable material, fire watch, signaling of all power equipment, and tree topper or trimmer when in connection with construction.

#### LABORER, SKILLED - HIGHWAY

The skilled laborer heavy and highway (HWY) classification shall encompass the following types of work, irrespective of the site of the work: handling of materials treated with oil, creosote, asphalt and/or any foreign materials harmful to skin or clothing, track laborers, chloride handlers, the unloading and loading with steel workers and re-bars, concrete workers (wet), tunnel helpers in free air, batch dumpers, mason tenders, kettle and tar men, plastic installers, scaffold workers, motorized buggies or motorized unit used for wet concrete or handling of building materials, laborers with de-watering systems, sewer workers plus depth, rod and chainmen, vibrator operators, mortar mixer operators, cement silica, clay, fly ash, lime and plasters, handlers (bulk or bag), cofferdam workers plus depth, on concrete paving, placing, cutting and tying or reinforcing, deck hand, dredge hand shore laborers, bankmen on floating plant, asphalt workers with machine, and layers, grade checker, power tools, stripping of all concrete forms excluding paving forms, dumpmen and spotters, when necessary, caisson workers plus depth, gunnite nozzle men, welders, cutters, burners and torchmen, chain saw operators, paving breaker, jackhammer and drill operators, layout man and/or drainage tile layer, steel form setters - street and highway, air tamping hammerman, signal man on crane, concrete saw operator, screedman on asphalt pavers, front end man on chip spreader, multiple concrete duct, luteman, asphalt raker, curb asphalt machine operator, ready mix scalemen (portable or temporary plant), laser beam operator, concrete burning machine operator, and coring machine operator.

#### TRUCK DRIVER - BUILDING, HEAVY AND HIGHWAY CONSTRUCTION - SOUTHEAST

Class 1. Drivers on 2 axle trucks hauling less than 9 ton. Air compressor and welding machines and brooms, including those pulled by separate units, truck driver helpers, warehouse employees, mechanic helpers, greasers and tiremen, pickup trucks when hauling materials, tools, or workers to and from and on-the-job site, and fork lifts up to 6,000 lb. capacity.

Class 2. Two or three axle trucks hauling more than 9 ton but hauling less than 16 ton. A-frame winch trucks, hydrolift trucks, vactor trucks or similar equipment when used for transportation purposes. Fork lifts over 6,000 lb. capacity, winch trucks, four axle combination units, and ticket writers.

Class 3. Two, three or four axle trucks hauling 16 ton or more. Drivers on water pulls, articulated dump trucks, mechanics and working forepersons, and dispatchers. Five axle or more combination units.

Class 4. Low Boy and Oil Distributors.

Class 5. Drivers who require special protective clothing while employed on hazardous waste work.

#### TRUCK DRIVER - BUILDING, HEAVY AND HIGHWAY CONSTRUCTION - NORTHWEST

Class 1. Two or three Axle Trucks. A-frame Truck when used for transportation purposes; Air Compressors and Welding Machines, including those pulled by cars, pick-up trucks and tractors; Ambulances; Batch Gate Lockers; Batch Hopperman; Car and Truck Washers; Carry-alls; Fork Lifts and Hoisters; Helpers; Mechanics Helpers and Greasers; Oil Distributors 2-man operation; Pavement Breakers; Pole Trailer, up to 40 feet; Power Mower Tractors; Self-propelled Chip Shreader; Skipman; Slurry Trucks, 2-man operation; Slurry Truck Conveyor Operation, 2 or 3 man; Teamsters; Unskilled dumpman; and Truck Drivers hauling warning lights, barricades, and portable toilets on the job site.

Class 2. Four axle trucks; Dump Crets and Adgetors under 7 yards; Dumpsters, Track Trucks, Euclids, Hug Bottom Dump Turnapulls or Turnatrailers when pulling other than self-loading equipment or similar equipment under 16 cubic yards; Mixer Trucks under 7 yards; Ready-mix Plant Hopper Operator, and Winch Trucks, 2 Axles.

Class 3. Five axle trucks; Dump Crets and Adgetors 7 yards and over; Dumpsters, Track Trucks, Euclids, Hug Bottom Dump Turnatrailers or turnapulls when pulling other than self-loading equipment or similar equipment over 16 cubic yards; Explosives and/or Fission Material Trucks; Mixer Trucks 7 yards or over; Mobile Cranes while in transit; Oil Distributors, 1-man operation; Pole Trailer, over 40 feet; Pole and Expandable Trailers hauling material over 50 feet long; Slurry trucks, 1-man operation; Winch trucks, 3 axles or more; Mechanic--Truck Welder and Truck Painter.

Class 4. Six axle trucks; Dual-purpose vehicles, such as mounted crane trucks with hoist and accessories; Foreman; Master Mechanic; Self-loading equipment like P.B. and trucks with scoops on the front.

#### OPERATING ENGINEERS - BUILDING, HEAVY AND HIGHWAY CONSTRUCTION

Class 1. Power Cranes, Draglines, Derricks, Shovels, Gradalls, Mechanics, Tractor Highlift, Tournadozer, Concrete Mixers with Skip, Tournamixer, Two Drum Machine, One Drum Hoist with Tower or Boom,

Cableways, Tower Machines, Motor Patrol, Boom Tractor, Boom or Winch Truck, Winch or Hydraulic Boom Truck, Truck Crane, Tournapull, Tractor Operating Scoops, Bulldozer, Push Tractor, Asphalt Planer, Finishing Machine on Asphalt, Large Rollers on Earth, Rollers on Asphalt Mix, Ross Carrier or similar Machine, Gravel Processing Machine, Asphalt Plant Engineer, Paver Operator, Dredging Equipment, or Dredge Engineer, or Dredge Operator, Central Mix Plant Engineer, CMI or similar type machine, Concrete Pump, Truck or Skid Mounted, Tower Crane, Engineer or Rock Crusher Plant, Concrete Plant Engineer, Ditching Machine with dual attachment, Tractor Mounted Loaders, Cherry Picker, Hydro Crane, Standard or Dinkey Locomotives, Scoopmobiles, Euclid Loader, Soil Cement Machine, Back Filler, Elevating Machine, Power Blade, Drilling Machine, including Well Testing, Caissons, Shaft or any similar type drilling machines, Motor Driven Paint Machine, Pipe Cleaning Machine, Pipe Wrapping Machine, Pipe Bending Machine, Apsco Paver, Boring Machine, (Head Equipment Greaser), Barber-Greene Loaders, Formless Paver, (Well Point System), Concrete Spreader, Hydra Ax, Span Saw, Marine Scoops, Brush Mulcher, Brush Burner, Mesh Placer, Tree Mover, Helicopter Crew (3), Piledriver-Skid or Crawler, Stump Remover, Root Rake, Tug Boat Operator, Refrigerating Machine, Freezing Operator, Chair Cart-Self-Propelled, Hydra Seeder, Straw Blower, Power Sub Grader, Bull Float, Finishing Machine, Self-Propelled Pavement Breaker, Lull (or similar type Machine), Two Air Compressors, Compressors hooked in Manifold, Overhead Crane, Chip Spreader, Mud Cat, Sull-Air, Fork Lifts (except when used for landscaping work), Soil Stabilizer (Seaman Tiller, Bo Mag, Rago Gator, and similar types of equipment), Tube Float, Spray Machine, Curing Machine, Concrete or Asphalt Milling Machine, Snooper Truck-Operator, Backhoe, Farm Tractors (with attachments), 4 Point Lift System (Power Lift or similar type), Skid-Steer (Bob Cat or similar type), Wrecking Shears, Water Blaster.

Class 2. Concrete Mixers without Skips, Rock Crusher, Ditching Machine under 6', Curbing Machine, One Drum Machines without Tower or Boom, Air Tugger, Self-Propelled Concrete Saw, Machine Mounted Post Hole Digger, two to four Generators, Water Pumps or Welding Machines, within 400 feet, Air Compressor 600 cu. ft. and under, Rollers on Aggregate and Seal Coat Surfaces, Fork Lift (when used for landscaping work), Concrete and Blacktop Curb Machine, One Water Pump, Oilers, Air Valves or Steam Valves, One Welding Machine, Truck Jack, Mud Jack, Gunnite Machine, House Elevators when used for hoisting material, Engine Tenders, Fireman, Wagon Drill, Flex Plane, Conveyor, Siphons and Pulsometer, Switchman, Fireman on Paint Pots, Fireman on Asphalt Plants, Distributor Operator on Trucks, Tampers, Self-Propelled Power Broom, Striping Machine (motor driven), Form Tamper, Bulk Cement Plant, Equipment Greaser, Deck Hands, Truck Crane Oiler-Driver, Cement Blimps, Form Grader, Temporary Heat, Throttle Valve, Super Sucker (and similar type of equipment).

#### Other Classifications of Work:

For definitions of classifications not otherwise set out, the Department generally has on file such definitions which are available. If a task to be performed is not subject to one of the classifications of pay set out, the Department will upon being contacted state which neighboring county has such a classification and provide such rate, such rate being deemed to exist by reference in this document. If no neighboring county rate applies to the task, the Department shall undertake a special determination, such special determination being then deemed to have existed under this determination. If a project requires these, or any classification not listed, please contact IDOL at 618/993-7271 for wage rates or clarifications.

## LANDSCAPING

Landscaping work falls under the existing classifications for laborer, operating engineer and truck driver. The work performed by landscape plantsman and landscape laborer is covered by the existing classification of laborer. The work performed by landscape operators (regardless of equipment used or its size) is covered by the classifications of operating engineer. The work performed by landscape truck drivers (regardless of size of truck driven) is covered by the classifications of truck driver.

# Jackson County Prevailing Wage for April 2007

Trade Name	RG	TYP	C	Base	FRMAN	*M-F>8	OSA	OSH	H/W	Pensn	Vac	Trng
=====	==	==	=	=====	=====	=====	==	==	=====	=====	=====	=====
ASBESTOS ABT-GEN		ALL		20.750	21.200	1.5	1.5	2.0	5.250	5.600	0.000	0.700
ASBESTOS ABT-MEC		BLD		25.290	26.290	1.5	1.5	2.0	4.450	2.500	0.000	0.250
BOILERMAKER		BLD		28.500	31.000	1.5	1.5	2.0	6.820	11.03	0.000	0.300
BRICK MASON		BLD		25.470	26.970	1.5	1.5	2.0	6.000	5.400	0.000	0.425
CARPENTER		BLD		27.780	29.280	1.5	1.5	2.0	5.050	3.750	0.000	0.350
CARPENTER		HWY		27.730	29.230	1.5	1.5	2.0	5.050	3.750	0.000	0.350
CEMENT MASON		BLD		23.500	24.500	1.5	1.5	2.0	5.200	3.550	0.000	0.100
CEMENT MASON		HWY		23.750	24.750	1.5	1.5	2.0	5.300	3.700	0.000	0.300
CERAMIC TILE FNSHER		BLD		24.990	0.000	1.5	1.5	2.0	6.000	5.400	0.000	0.425
ELECTRICIAN		ALL		32.910	35.160	1.5	1.5	2.0	5.150	6.580	0.000	0.490
ELECTRONIC SYS TECH		BLD		25.700	27.200	1.5	1.5	2.0	5.150	3.340	0.000	0.250
FLOOR LAYER		BLD		26.930	27.680	1.5	1.5	2.0	5.000	3.750	0.000	0.350
GLAZIER		BLD		29.480	0.000	2.0	2.0	2.0	8.550	6.920	2.360	0.160
HT/FROST INSULATOR		BLD		30.440	31.440	1.5	1.5	2.0	4.850	8.360	0.000	0.450
IRON WORKER		ALL		22.650	23.650	1.5	1.5	2.0	5.760	6.450	0.000	0.310
LABORER		BLD		20.750	21.200	1.5	1.5	2.0	5.250	5.600	0.000	0.600
LABORER		HWY		21.000	21.450	1.5	1.5	2.0	5.350	6.150	0.000	0.600
LABORER		O&C		15.750	16.200	1.5	1.5	2.0	5.350	6.150	0.000	0.600
MACHINIST		BLD		36.890	38.890	2.0	2.0	2.0	4.380	5.650	2.550	0.000
MARBLE FINISHERS		BLD		24.990	0.000	1.5	1.5	2.0	6.000	5.400	0.000	0.425
MARBLE MASON		BLD		25.470	26.970	1.5	1.5	2.0	6.000	5.400	0.000	0.425
MILLWRIGHT		BLD		27.780	29.280	1.5	1.5	2.0	5.050	3.750	0.000	0.350
MILLWRIGHT		HWY		27.730	29.230	1.5	1.5	2.0	5.050	3.750	0.000	0.350
OE RIVER 1		RIV	1	26.900	0.000	1.5	1.5	2.0	5.650	6.100	0.000	1.100
OE RIVER 2		RIV	2	23.450	0.000	1.5	1.5	2.0	5.650	6.100	0.000	1.100
OPERATING ENGINEER		ALL	1	26.800	27.800	1.5	1.5	2.0	5.650	6.100	0.000	1.100
OPERATING ENGINEER		ALL	2	24.900	27.800	1.5	1.5	2.0	5.650	6.100	0.000	1.100
OPERATING ENGINEER		ALL	3	24.150	27.800	1.5	1.5	2.0	5.650	6.100	0.000	1.100
OPERATING ENGINEER		ALL	4	21.400	27.800	1.5	1.5	2.0	5.650	6.100	0.000	1.100
OPERATING ENGINEER		O&C	1	20.100	21.100	1.5	1.5	2.0	5.650	6.100	0.000	1.100
OPERATING ENGINEER		O&C	2	18.680	21.100	1.5	1.5	2.0	5.650	6.100	0.000	1.100
OPERATING ENGINEER		O&C	3	18.120	21.100	1.5	1.5	2.0	5.650	6.100	0.000	1.100
OPERATING ENGINEER		O&C	4	16.050	21.100	1.5	1.5	2.0	5.650	6.100	0.000	1.100
PAINTER		BLD		22.790	23.790	1.5	1.5	2.0	5.430	4.500	0.000	0.250
PAINTER		HWY		27.090	28.090	1.5	1.5	2.0	5.430	4.500	0.000	0.250
PAINTER OVER 30FT		BLD		23.790	24.790	1.5	1.5	2.0	5.430	4.500	0.000	0.250
PAINTER PWR EQMT		BLD		23.790	24.790	1.5	1.5	2.0	5.430	4.500	0.000	0.250
PAINTER PWR EQMT		HWY		28.090	29.090	1.5	1.5	2.0	5.430	4.500	0.000	0.250
PILEDRIVER		BLD		27.780	29.280	1.5	1.5	2.0	5.050	3.750	0.000	0.350
PILEDRIVER		HWY		27.730	29.230	1.5	1.5	2.0	5.050	3.750	0.000	0.350
PIPEFITTER		BLD		31.300	34.430	1.5	2.0	2.0	6.450	5.030	0.000	0.620
PLASTERER		BLD		23.500	24.500	1.5	1.5	2.0	5.200	3.550	0.000	0.100
PLUMBER		BLD		31.300	34.430	1.5	2.0	2.0	6.450	5.030	0.000	0.620
ROOFER		BLD		19.700	20.500	1.5	1.5	2.0	5.700	3.800	0.000	0.000
SHEETMETAL WORKER		ALL		27.210	28.460	1.5	1.5	2.0	6.000	4.770	1.630	0.120
SPRINKLER FITTER		BLD		31.240	33.240	1.5	1.5	2.0	6.500	5.350	0.000	0.250
STONE MASON		BLD		25.470	26.970	1.5	1.5	2.0	6.000	5.400	0.000	0.425
TERRAZZO FINISHER		BLD		24.990	0.000	1.5	1.5	2.0	6.000	5.400	0.000	0.425
TERRAZZO MASON		BLD		28.500	28.800	1.5	1.5	2.0	0.000	2.950	0.000	0.000
TRUCK DRIVER		ALL	1	24.990	0.000	1.5	1.5	2.0	7.250	4.200	0.000	0.000
TRUCK DRIVER		ALL	2	25.390	0.000	1.5	1.5	2.0	7.250	4.200	0.000	0.000
TRUCK DRIVER		ALL	3	25.590	0.000	1.5	1.5	2.0	7.250	4.200	0.000	0.000
TRUCK DRIVER		ALL	4	25.840	0.000	1.5	1.5	2.0	7.250	4.200	0.000	0.000
TRUCK DRIVER		ALL	5	26.590	0.000	1.5	1.5	2.0	7.250	4.200	0.000	0.000
TRUCK DRIVER		O&C	1	19.500	0.000	1.5	1.5	2.0	4.275	4.670	0.000	0.000
TRUCK DRIVER		O&C	2	15.900	0.000	1.5	1.5	2.0	4.275	4.670	0.000	0.000
TRUCK DRIVER		O&C	3	16.400	0.000	1.5	1.5	2.0	4.275	4.670	0.000	0.000
TUCK POINTER		BLD		25.470	26.970	1.5	1.5	2.0	6.000	5.400	0.000	0.425

Legend :

M-F>8 (Overtime is required for any hour greater than 8 worked each day, Monday through Friday.)

OSA (Overtime is required for every hour worked on Saturday)

OSH (Overtime is required for every hour worked on Sunday and Holidays)

H/W (Health & Welfare Insurance)

Pensn (Pension)

Vac (Vacation)

Trng (Training)

## Explanations

### JACKSON COUNTY

The following list is considered as those days for which holiday rates of wages for work performed apply: New Years Day, Memorial/Decoration Day, Fourth of July, Labor Day, Veterans Day, Thanksgiving Day, Christmas Day. Generally, any of these holidays which fall on a Sunday is celebrated on the following Monday. This then makes work performed on that Monday payable at the appropriate overtime rate for holiday pay. Common practice in a given local may alter certain days of celebration such as the day after Thanksgiving for Veterans Day. If in doubt, please check with IDOL.

Oil and chip resealing (O&C) means the application of road oils and liquid asphalt to coat an existing road surface, followed by application of aggregate chips or gravel to coated surface, and subsequent rolling of material to seal the surface.

### EXPLANATION OF CLASSES

ASBESTOS - GENERAL - removal of asbestos material/mold and hazardous materials from any place in a building, including mechanical systems where those mechanical systems are to be removed. This includes the removal of asbestos materials/mold and hazardous materials from ductwork or pipes in a building when the building is to be demolished at the time or at some close future date.

ASBESTOS - MECHANICAL - removal of asbestos material from mechanical systems, such as pipes, ducts, and boilers, where the mechanical systems are to remain.

### LABORER - OIL AND CHIP RESEALING

Hook and unhook chip box from aggregate truck; distribute material within chip box; perform flagging work related to oil and chip resealing; hand spray oil fluids; handle traffic control, including setting-up and maintaining barricades, drums, cones, delineators, signs and other such items, as well as laying-out and applying or removing temporary roadway markings used to control traffic in job site related to oil and chip resealing; and perform clean-up related

to oil and chip resealing.

#### CERAMIC TILE FINISHER, MARBLE FINISHER, TERRAZZO FINISHER

Assisting, helping or supporting the tile, marble and terrazzo mechanic by performing their historic and traditional work assignments required to complete the proper installation of the work covered by said crafts. The term "Ceramic" is used for naming the classification only, and is in no a limitation of the product handled. Ceramic takes into consideration most hard tiles.

#### ELECTRONIC SYSTEMS TECHNICIAN

Installation, service and maintenance of low-voltage systems which utilizes the transmission and/or transference of voice, sound, vision, or digital for commercial, education, security and entertainment purposes for the following: TV monitoring and surveillance, background/foreground music, intercom and telephone interconnect, field programming, inventory control systems, microwave transmission, multi-media, multiplex, radio page, school, intercom and sound burglar alarms and low voltage master clock systems.

Excluded from this classification are energy management systems, life safety systems, supervisory controls and data acquisition systems not intrinsic with the above listed systems, fire alarm systems, nurse call systems and raceways exceeding fifteen feet in length.

#### TRUCK DRIVER - BUILDING, HEAVY AND HIGHWAY CONSTRUCTION

Class 1. Drivers on 2 axle trucks hauling less than 9 ton. Air compressor and welding machines and brooms, including those pulled by separate units, truck driver helpers, warehouse employees, mechanic helpers, greasers and tiremen, pickup trucks when hauling materials, tools, or workers to and from and on-the-job site, and fork lifts up to 6,000 lb. capacity.

Class 2. Two or three axle trucks hauling more than 9 ton but hauling less than 16 ton. A-frame winch trucks, hydrolift trucks, vector trucks or similar equipment when used for transportation purposes. Fork lifts over 6,000 lb. capacity, winch trucks, four axle combination units, and ticket writers.

Class 3. Two, three or four axle trucks hauling 16 ton or more. Drivers on water pulls, articulated dump trucks, mechanics and working forepersons, and dispatchers. Five axle or more combination units.

Class 4. Low Boy and Oil Distributors.

Class 5. Drivers who require special protective clothing while employed on hazardous waste work.

#### TRUCK DRIVER - O & C (Oil and Chip Resealing ONLY)

It involves driving of contractor or subcontractor owned, leased, or hired pickup, dump, service, or oil distributor trucks. Includes transporting materials and equipment (including, but not limited to oils, aggregate supplies, parts, machinery and tools) to or from the job site; distributing oil or liquid asphalt and aggregate; stock piling material; and maintaining trucks at job site related to oil and chip resealing.

Class 1. Distributors, liquid asphalt hauling and hauling of asphalt rubber-tired rollers.



Class 2. Stockpiling.

Class 3. Tandem hauling to job site.

OPERATING ENGINEERS - BUILDING, HEAVY AND HIGHWAY CONSTRUCTION

Class 1. APSCO or Equal Spreading Machine, Backhoe, Backfiller, Boom or Winch Cat, Bituminous Mixplane Machine, Blacksmith, Bituminous Surfacing Machine, Bull-Dozer, Crane, Shovel, Dragline, Truck Crane, Pile Driver, Concrete Breaker, Concrete or Pumpcrete Pumps, Dinky or Standard Locomotives, Well or Caisson Drills, Elevating Grader, Fork Lifts, Flexplane, Gradeall, Hi-Lift Hoists, Guy-Derricks, Hysters, Mechanic Motor Patrol, Mixers-21 cu. ft. or over, Push Cats, Pulls and Scrapers, Two Well Point Pumps, Pulverizer or Tiller, PugMill, Rubber-Tired Farm Type Tractor with Bulldozer/Blade/Auger or hi-lift over 1/2 yd., Jersey Spreader, Tract-Air used with Drill or Hi-Lift, Trenching or Ditching Machines, Wood Chipper w/Tractor, Self-Propelled Roller w/Blade, Equipment Greaser, Self-Propelled Bump Grinder on Concrete pavement, Boat Operator, Skid-Loaders, Tuggers, Lazer Screed, and Self-Propelled Chip Spreader (when others run conveyors).

Class 2. Any type tractor pulling any type roller or disc, Two Air Compressors (220 cu. ft. capacity or over), Two Air Tract Drills, Air-Track Drill w/Compressor, Automatic Bins or Scales w/Compressor or Generator, Pipeline Boring Machine, Bulk Cement Plant w/Separate Compressor, Power Operated Bull Float, Hydra-Lift w/Single Motor, Straw Mulcher Blower w/Spout, Self-Propelled Roller/Compactor, Back-End man on Bituminous Surfacing Machine, oiler on milling machine.

Class 3. Air Compressor w/Valve driving piling, Boom or Winch Type Truck, Two Conveyors, Self-Propelled Concrete Saw, Form Grader, Truck Crane Oiler, Self-Propelled Vibrator, Rubber Tired Farm Type Tractor w/Blade/Bulldozer/Auger/hi-lift - 1/2 yd. or less, Elevator Operator, Man Lift (scissor lift) when lifting materials.

Class 4. Air-Track Drill (one), Belt Drag Machine, Power Broom, Mechanical Plasterer Applicator, Trac-Air, Air Compressor (220 cu. ft. or over) One, Air Compressor (under 220 cu. ft) four, Automatic Bin, Bulk Cement Plant w/Built-in Compressor running off same motor or electric motor, Fireman or Switchman, Self-Propelled Form Tamper, Light Plants (4), Welding Machines (4), Pumps (4), or Combination of four (4) Pumps, Light Plants, Welding Machines, Air-Compressors (under 220 cu. ft.), Mudjacks or Wood Chipper, Mixers - less than 21 cu. ft. Mortar Mixer w/Skip or Pump, Pipeline Tract Jack. One Operating Engineer may operate and maintain any combination of the following pieces of equipment, not to exceed four (4) which shall be within a reasonable distance, such combination may include any equipment in this classification: (Compressors, Light Plants, Generators, Welding Machines, Pumps or Conveyors), One Well- Point Pump, Two Motor Driven Heaters, One Air Compressor (under 220 cu. ft.), One Engine-Driven Conveyor, One Motor Driven Heater, One Light Plant, One Pump, One Welding Machine, One Ulmac or Equal Spreader, Oilers, and one Generator 10 kw or greater.

OPERATING ENGINEER - O & C (Oil and Chip Resealing ONLY). Includes the operation of all motorized heavy equipment used in oil and chip rsealing, including but not limited to operating self-propelled chip spreaders, and all types of rollers (both hard and rubber tired); and other duties pertaining to the operation or maintenance of heavy equipment relatd to oil and chip resealing.

Class 1. See Class 1 above for types of equipment operated.

Class 2. See Class 2 above for types of equipment operated.

Class 3. See Class 3 above for types of equipment operated.

Class 4. See Class 4 above for types of equipment operated.

OPERATING ENGINEER RIVER WORK 1 - operate the following machines when working on River Work and Levee Work on the Mississippi and Ohio Rivers, Lakes and Tributaries: Crane, Shovel, Drageline, Scrapers, Dredge, Derrick, Pile-Driver, Push Boat, all power boat operators, Mechanic, Engineman on Dredge, Leverman on Dredge, All Bituminous Spreader machines, Backhoe, Backfiller, Boom, or Winch Cat, Bituminous Mixplane Machine, Blacksmith, Bituminous Surfacing Machine, Bulldozer, Truck Cranes, Hydraulic Truck Mounted Boom/Crane, Concrete Finishing Machine, or Spreader Machine, Concrete Breaker, Concrete or Pumpcrete Machines, Concrete Plant Operator, All Off Road Material Hauling Equipment, Dinky or Standard Locomotives, Well Drill, Elevating Grader, Fork-Lifts, Flexplane, Gradeall, Hi-Lift, Power Handblade Tugger type Hoist, Hoist Two Drum (or over one), Gyderrick, Hyster, Motor Patrol, Mixers - 21 Cu. Ft. or over, Push Cat, Pulls, & Scrapers, Pumps-Two Well Points, Equipment Greaser, P & H Pulverizer or Pulverizer equal to Pugmill, Pugmill, Rubber-Tired farm type tractor w/Bulldozer/Blade/Auger or Hi-Lift over ½ yard, Skimmer Scoops, Seaman Tiller, Jersey Spreader, Tract-Air used with Drill or Hi-Lift, Trenching or Ditching Machine, Wood Chipper w/Tractor, self-propelled roller w/Blade, Concrete Pumps and Small Equipment Operators.

OPERATING ENGINEER RIVER 2 - when working on River Work and Levee Work on the Mississippi and Ohio Rivers, Lakes and Tributaries shall be employed as the Oiler or Fireman on Crane, Dragline, Shovel, Dredge, Truck Crane, Pile Driver, Gradeall, Dinky or Standard Locomotive, Guy Derrick, Trenching Machine or Ditching Machine 80 H.P. and over, All Terrain (cherry-picker) with over 40 ton Lifting Capacity, Deck Oiler and Deckhands.

Other Classifications of Work:

For definitions of classifications not otherwise set out, the Department generally has on file such definitions which are available. If a task to be performed is not subject to one of the classifications of pay set out, the Department will upon being contacted state which neighboring county has such a classification and provide such rate, such rate being deemed to exist by reference in this document. If no neighboring county rate applies to the task, the Department shall undertake a special determination, such special determination being then deemed to have existed under this determination. If a project requires these, or any classification not listed, please contact IDOL at 618/993-7271 for wage rates or clarifications.

#### LANDSCAPING

Landscaping work falls under the existing classifications for laborer, operating engineer and truck driver. The work performed by landscape plantsman and landscape laborer is covered by the existing classification of laborer. The work performed by landscape operators (regardless of equipment used or its size) is covered by the classifications of operating engineer. The work performed by landscape truck drivers (regardless of size of truck driven) is covered by the classifications of truck driver.

# Jasper County Prevailing Wage for April 2007

Trade Name	RG	TYP	C	Base	FRMAN	*M-F>8	OSA	OSH	H/W	Pensn	Vac	Trng
=====	==	===	=	=====	=====	=====	===	===	=====	=====	=====	=====
ASBESTOS ABT-GEN		ALL		20.750	21.200	1.5	1.5	2.0	5.250	5.600	0.000	0.700
ASBESTOS ABT-MEC		BLD		20.800	0.000	2.0	2.0	2.0	5.000	3.400	0.000	0.000
BOILERMAKER		BLD		28.500	31.000	1.5	1.5	2.0	6.820	11.03	0.000	0.300
BRICK MASON		BLD		24.130	25.630	2.0	2.0	2.0	5.200	5.900	0.000	0.630
CARPENTER		BLD		25.590	27.590	1.5	1.5	2.0	6.500	6.800	0.000	0.320
CARPENTER		HWY		23.940	25.690	1.5	1.5	2.0	6.500	6.300	0.000	0.300
CEMENT MASON		BLD		23.500	24.500	1.5	1.5	2.0	5.200	3.550	0.000	0.100
CEMENT MASON		HWY		23.500	25.000	1.5	1.5	2.0	5.200	2.750	0.000	0.200
CERAMIC TILE FNSHER		BLD		25.500	0.000	1.5	1.5	2.0	5.200	5.600	0.000	0.000
COMM SYSTEMS TECH		BLD		23.350	25.700	1.5	1.5	2.0	5.150	4.310	0.000	0.000
ELECTRICIAN		BLD		29.090	31.130	1.5	1.5	2.0	5.150	5.530	0.000	0.290
ELEVATOR CONSTRUCTOR		BLD		34.190	38.460	2.0	2.0	2.0	8.275	6.060	2.050	0.000
GLAZIER		BLD		22.930	0.000	1.5	1.5	2.0	4.320	3.800	0.000	0.300
HT/FROST INSULATOR		BLD		26.110	27.110	1.5	1.5	2.0	4.800	6.860	0.000	0.190
IRON WORKER		ALL		24.450	25.750	1.5	1.5	2.0	6.000	8.000	0.000	0.390
LABORER		BLD		20.750	21.200	1.5	1.5	2.0	5.250	5.600	0.000	0.600
LABORER		HWY		21.000	21.450	1.5	1.5	2.0	5.350	6.150	0.000	0.600
LATHER		BLD		25.590	27.590	1.5	1.5	2.0	6.500	6.800	0.000	0.320
MACHINIST		BLD		36.890	38.890	2.0	2.0	2.0	4.380	5.650	2.550	0.000
MARBLE FINISHERS		BLD		25.500	0.000	1.5	1.5	2.0	5.200	5.600	0.000	0.000
MARBLE MASON		BLD		27.000	0.000	1.5	1.5	2.0	5.200	5.600	0.000	0.000
MILLWRIGHT		BLD		26.000	28.000	1.5	1.5	2.0	6.500	6.850	0.000	0.320
MILLWRIGHT		HWY		16.450	17.700	1.5	1.5	2.0	2.800	3.000	0.000	0.000
OPERATING ENGINEER		ALL	1	28.650	0.000	1.5	1.5	2.0	5.200	6.750	0.000	0.650
OPERATING ENGINEER		ALL	2	18.600	0.000	1.5	1.5	2.0	5.200	6.750	0.000	0.650
PAINTER		ALL		23.000	24.000	1.5	1.5	2.0	5.500	6.200	0.000	0.180
PILEDRIIVER		BLD		26.090	28.090	1.5	1.5	2.0	6.500	6.800	0.000	0.320
PILEDRIIVER		HWY		24.440	26.190	1.5	1.5	2.0	6.500	6.300	0.000	0.300
PIPEFITTER		BLD		33.100	35.600	1.5	1.5	2.0	6.450	5.760	0.000	0.620
PLASTERER		BLD		23.500	24.500	1.5	1.5	2.0	5.200	3.550	0.000	0.100
PLUMBER		BLD		33.100	35.600	1.5	1.5	2.0	6.450	5.760	0.000	0.620
ROOFER		BLD		22.350	24.850	1.5	1.5	2.0	6.000	5.550	0.000	0.550
SHEETMETAL WORKER		ALL		27.210	28.460	1.5	1.5	2.0	6.000	4.770	1.630	0.120
SPRINKLER FITTER		BLD		31.240	33.240	1.5	1.5	2.0	6.500	5.350	0.000	0.250
STONE MASON		BLD		24.130	25.630	2.0	2.0	2.0	5.200	5.900	0.000	0.630
TERRAZZO FINISHER		BLD		25.500	0.000	1.5	1.5	2.0	5.200	5.600	0.000	0.000
TERRAZZO MASON		BLD		27.000	0.000	1.5	1.5	2.0	5.200	5.600	0.000	0.000
TILE LAYER		BLD		25.590	27.590	1.5	1.5	2.0	6.500	6.800	0.000	0.320
TILE MASON		BLD		27.000	0.000	1.5	1.5	2.0	5.200	5.600	0.000	0.000
TRUCK DRIVER		ALL	1	25.787	0.000	1.5	1.5	2.0	7.250	3.317	0.000	0.000
TRUCK DRIVER		ALL	2	26.187	0.000	1.5	1.5	2.0	7.250	3.317	0.000	0.000
TRUCK DRIVER		ALL	3	26.387	0.000	1.5	1.5	2.0	7.250	3.317	0.000	0.000
TRUCK DRIVER		ALL	4	26.637	0.000	1.5	1.5	2.0	7.250	3.317	0.000	0.000
TRUCK DRIVER		ALL	5	27.387	0.000	1.5	1.5	2.0	7.250	3.317	0.000	0.000
TRUCK DRIVER		O&C	1	20.630	0.000	1.5	1.5	2.0	7.250	3.317	0.000	0.000
TRUCK DRIVER		O&C	2	20.950	0.000	1.5	1.5	2.0	7.250	3.317	0.000	0.000
TRUCK DRIVER		O&C	3	21.110	0.000	1.5	1.5	2.0	7.250	3.317	0.000	0.000
TRUCK DRIVER		O&C	4	21.310	0.000	1.5	1.5	2.0	7.250	3.317	0.000	0.000
TRUCK DRIVER		O&C	5	21.910	0.000	1.5	1.5	2.0	7.250	3.317	0.000	0.000
TUCKPOINTER		BLD		24.130	25.630	2.0	2.0	2.0	5.200	5.900	0.000	0.630

Legend:

M-F>8 (Overtime is required for any hour greater than 8 worked each day, Monday through Friday.)

OSA (Overtime is required for every hour worked on Saturday)

OSH (Overtime is required for every hour worked on Sunday and Holidays)

H/W (Health & Welfare Insurance)

Pensn (Pension)

Vac (Vacation)

Trng (Training)

## Explanations

### JASPER COUNTY

The following list is considered as those days for which holiday rates of wages for work performed apply: New Years Day, Memorial/Decoration Day, Fourth of July, Labor Day, Veterans Day, Thanksgiving Day, Christmas Day. Generally, any of these holidays which fall on a Sunday is celebrated on the following Monday. This then makes work performed on that Monday payable at the appropriate overtime rate for holiday pay. Common practice in a given local may alter certain days of celebration such as the day after Thanksgiving for Veterans Day. If in doubt, please check with IDOL.

Oil and chip resealing (O&C) means the application of road oils and liquid asphalt to coat an existing road surface, followed by application of aggregate chips or gravel to coated surface, and subsequent rolling of material to seal the surface.

### EXPLANATION OF CLASSES

ASBESTOS - GENERAL - removal of asbestos material/mold and hazardous materials from any place in a building, including mechanical systems where those mechanical systems are to be removed. This includes the removal of asbestos materials/mold and hazardous materials from ductwork or pipes in a building when the building is to be demolished at the time or at some close future date.

ASBESTOS - MECHANICAL - removal of asbestos material from mechanical systems, such as pipes, ducts, and boilers, where the mechanical systems are to remain.

### CERAMIC TILE FINISHER, MARBLE FINISHER, TERRAZZO FINISHER

Assisting, helping or supporting the tile, marble and terrazzo mechanic by performing their historic and traditional work assignments required to complete the proper installation of the work covered by said crafts. The term "Ceramic" is used for naming the classification only and is in no way a limitation of the product handled. Ceramic takes into consideration most hard tiles.

### COMMUNICATION SYSTEMS TECHNICIAN

Installation, operation, inspection, maintenance, repair, and service of radio, television, recording, voice sound and vision production and reproduction apparatus, equipment and appliances used for domestic, commercial, education, entertainment and private telephone systems.

### TRUCK DRIVER - BUILDING, HEAVY AND HIGHWAY CONSTRUCTION

Class 1. Drivers on 2 axle trucks hauling less than 9 ton. Air compressor and welding machines and brooms, including those pulled by separate units, truck driver helpers, warehouse employees, mechanic helpers, greasers and tiremen, pickup trucks when hauling materials,

tools, or workers to and from and on-the-job site, and fork lifts up to 6,000 lb. capacity.

Class 2. Two or three axle trucks hauling more than 9 ton but hauling less than 16 ton. A-frame winch trucks, hydrolift trucks, vactor trucks or similar equipment when used for transportation purposes. Fork lifts over 6,000 lb. capacity, winch trucks, four axle combination units, and ticket writers.

Class 3. Two, three or four axle trucks hauling 16 ton or more. Drivers on water pulls, articulated dump trucks, mechanics and working forepersons, and dispatchers. Five axle or more combination units.

Class 4. Low Boy and Oil Distributors.

Class 5. Drivers who require special protective clothing while employed on hazardous waste work.

TRUCK DRIVER - OIL AND CHIP RESEALING ONLY.

This shall encompass laborers, workers and mechanics who drive contractor or subcontractor owned, leased, or hired pickup, dump, service, or oil distributor trucks. The work includes transporting materials and equipment (including but not limited to, oils, aggregate supplies, parts, machinery and tools) to or from the job site; distributing oil or liquid asphalt and aggregate; stock piling material when in connection with the actual oil and chip contract. The Truck Driver (Oil & Chip Resealing) wage classification does not include supplier delivered materials.

OPERATING ENGINEERS - BUILDING, HEAVY AND HIGHWAY CONSTRUCTION

Class 1. Power Cranes, Draglines, Derricks, Shovels, Gradalls, Mechanics, Tractor Highlift, Tournadozer, Concrete Mixers with Skip, Tournamixer, Two Drum Machine, One Drum Hoist with Tower or Boom, Cableways, Tower Machines, Motor Patrol, Boom Tractor, Boom or Winch Truck, Winch or Hydraulic Boom Truck, Truck Crane, Tournapull, Tractor Operating Scoops, Bulldozer, Push Tractor, Asphalt Planer, Finishing Machine on Asphalt, Large Rollers on Earth, Rollers on Asphalt Mix, Ross Carrier or similar Machine, Gravel Processing Machine, Asphalt Plant Engineer, Paver Operator, Dredging Equipment, or Dredge Engineer, or Dredge Operator, Central Mix Plant Engineer, CMI or similar type machine, Concrete Pump, Truck or Skid Mounted, Tower Crane, Engineer or Rock Crusher Plant, Concrete Plant Engineer, Ditching Machine with dual attachment, Tractor Mounted Loaders, Cherry Picker, Hydro Crane, Standard or Dinkey Locomotives, Scoopmobiles, Euclid Loader, Soil Cement Machine, Back Filler, Elevating Machine, Power Blade, Drilling Machine, including Well Testing, Caissons, Shaft or any similar type drilling machines, Motor Driven Paint Machine, Pipe Cleaning Machine, Pipe Wrapping Machine, Pipe Bending Machine, Apsco Paver, Boring Machine, (Head Equipment Greaser), Barber-Greene Loaders, Formless Paver, (Well Point System), Concrete Spreader, Hydra Ax, Span Saw, Marine Scoops, Brush Mulcher, Brush Burner, Mesh Placer, Tree Mover, Helicopter Crew (3), Piledriver-Skid or Crawler, Stump Remover, Root Rake, Tug Boat Operator, Refrigerating Machine, Freezing Operator, Chair Cart-Self-Propelled, Hydra Seeder, Straw Blower, Power Sub Grader, Bull Float, Finishing Machine, Self-Propelled Pavement Breaker, Lull (or similar type Machine), Two Air Compressors, Compressors hooked in Manifold, Overhead Crane, Chip Spreader, Mud Cat, Sull-Air, Fork Lifts (except when used for landscaping work), Soil Stabilizer (Seaman Tiller, Bo Mag, Rago Gator, and similar types of equipment), Tube Float, Spray Machine, Curing Machine, Concrete or Asphalt Milling

Machine, Snooper Truck-Operator, Backhoe, Farm Tractors (with attachments), 4 Point Lift System (Power Lift or similar type), Skid-Steer (Bob Cat or similar type), Wrecking Shears, Water Blaster.

Class 2. Concrete Mixers without Skips, Rock Crusher, Ditching Machine under 6', Curbing Machine, One Drum Machines without Tower or Boom, Air Tugger, Self-Propelled Concrete Saw, Machine Mounted Post Hole Digger, two to four Generators, Water Pumps or Welding Machines, within 400 feet, Air Compressor 600 cu. ft. and under, Rollers on Aggregate and Seal Coat Surfaces, Fork Lift (when used for landscaping work), Concrete and Blacktop Curb Machine, One Water Pump, Oilers, Air Valves or Steam Valves, One Welding Machine, Truck Jack, Mud Jack, Gunnite Machine, House Elevators when used for hoisting material, Engine Tenders, Fireman, Wagon Drill, Flex Plane, Conveyor, Siphons and Pulsometer, Switchman, Fireman on Paint Pots, Fireman on Asphalt Plants, Distributor Operator on Trucks, Tampers, Self-Propelled Power Broom, Striping Machine (motor driven), Form Tamper, Bulk Cement Plant, Equipment Greaser, Deck Hands, Truck Crane Oiler-Driver, Cement Blimps, Form Grader, Temporary Heat, Throttle Valve, Super Sucker (and similar type of equipment).

#### Other Classifications of Work:

For definitions of classifications not otherwise set out, the Department generally has on file such definitions which are available. If a task to be performed is not subject to one of the classifications of pay set out, the Department will upon being contacted state which neighboring county has such a classification and provide such rate, such rate being deemed to exist by reference in this document. If no neighboring county rate applies to the task, the Department shall undertake a special determination, such special determination being then deemed to have existed under this determination. If a project requires these, or any classification not listed, please contact IDOL at 618/993-7271 for wage rates or clarifications.

#### LANDSCAPING

Landscaping work falls under the existing classifications for laborer, operating engineer and truck driver. The work performed by landscape plantsman and landscape laborer is covered by the existing classification of laborer. The work performed by landscape operators (regardless of equipment used or its size) is covered by the classifications of operating engineer. The work performed by landscape truck drivers (regardless of size of truck driven) is covered by the classifications of truck driver.

# Jefferson County Prevailing Wage for April 2007

Trade Name	RG	TYP	C	Base	FRMAN	*M-F>8	OSA	OSH	H/W	Pensn	Vac	Trng
=====	==	==	=	=====	=====	=====	==	==	=====	=====	=====	=====
ASBESTOS ABT-GEN		ALL		20.750	21.200	1.5	1.5	2.0	5.250	5.600	0.000	0.700
ASBESTOS ABT-MEC		BLD		25.290	26.290	1.5	1.5	2.0	4.450	2.500	0.000	0.250
BOILERMAKER		BLD		28.500	31.000	1.5	1.5	2.0	6.820	11.03	0.000	0.300
BRICK MASON		BLD		25.470	26.970	1.5	1.5	2.0	6.000	5.400	0.000	0.425
CARPENTER		BLD		27.780	29.280	1.5	1.5	2.0	5.050	3.750	0.000	0.350
CARPENTER		HWY		27.730	29.480	1.5	1.5	2.0	5.050	3.750	0.000	0.350
CEMENT MASON		BLD		23.500	24.500	1.5	1.5	2.0	5.200	3.550	0.000	0.100
CEMENT MASON		HWY		23.500	25.000	1.5	1.5	2.0	5.200	2.750	0.000	0.200
CERAMIC TILE FNSHER		BLD		24.990	0.000	1.5	1.5	2.0	6.000	5.400	0.000	0.425
ELECTRICIAN		ALL		32.910	35.160	1.5	1.5	2.0	5.150	6.580	0.000	0.490
ELECTRONIC SYS TECH		BLD		25.700	27.200	1.5	1.5	2.0	5.150	3.340	0.000	0.250
FLOOR LAYER		BLD		26.930	27.680	1.5	1.5	2.0	5.000	3.750	0.000	0.350
GLAZIER		BLD		22.930	0.000	1.5	1.5	2.0	4.320	3.800	0.000	0.300
HT/FROST INSULATOR		BLD		30.440	31.440	1.5	1.5	2.0	4.850	8.360	0.000	0.450
IRON WORKER		ALL		26.350	27.850	1.5	1.5	2.0	6.360	8.250	0.000	0.420
LABORER		BLD		20.750	21.200	1.5	1.5	2.0	5.250	5.600	0.000	0.600
LABORER		HWY		21.000	21.450	1.5	1.5	2.0	5.350	6.150	0.000	0.600
MACHINIST		BLD		36.890	38.890	2.0	2.0	2.0	4.380	5.650	2.550	0.000
MARBLE FINISHERS		BLD		24.990	0.000	1.5	1.5	2.0	6.000	5.400	0.000	0.425
MARBLE MASON		BLD		25.470	26.970	1.5	1.5	2.0	6.000	5.400	0.000	0.425
MILLWRIGHT		BLD		27.780	29.280	1.5	1.5	2.0	5.050	3.750	0.000	0.350
MILLWRIGHT		HWY		28.230	29.980	1.5	1.5	2.0	5.050	3.750	0.000	0.350
OPERATING ENGINEER		ALL	1	25.900	27.030	1.5	1.5	2.0	6.200	11.45	0.000	1.000
OPERATING ENGINEER		ALL	2	24.770	27.030	1.5	1.5	2.0	6.200	11.45	0.000	1.000
OPERATING ENGINEER		ALL	3	20.290	27.030	1.5	1.5	2.0	6.200	11.45	0.000	1.000
OPERATING ENGINEER		ALL	4	20.350	27.030	1.5	1.5	2.0	6.200	11.45	0.000	1.000
OPERATING ENGINEER		ALL	5	20.020	27.030	1.5	1.5	2.0	6.200	11.45	0.000	1.000
OPERATING ENGINEER		ALL	6	26.450	27.030	1.5	1.5	2.0	6.200	11.45	0.000	1.000
OPERATING ENGINEER		ALL	7	26.750	27.030	1.5	1.5	2.0	6.200	11.45	0.000	1.000
OPERATING ENGINEER		ALL	8	27.030	27.030	1.5	1.5	2.0	6.200	11.45	0.000	1.000
PAINTER		ALL		20.700	21.200	1.5	1.5	2.0	4.650	4.200	0.000	0.250
PAINTER OVER 30FT		ALL		23.800	24.300	1.5	1.5	2.0	4.650	4.200	0.000	0.250
PAINTER PWR EQMT		ALL		23.800	24.300	1.5	1.5	2.0	4.650	4.200	0.000	0.250
PILEDRIVER		BLD		27.780	29.280	1.5	1.5	2.0	5.050	3.750	0.000	0.350
PILEDRIVER		HWY		28.230	29.980	1.5	1.5	2.0	5.050	3.750	0.000	0.350
PIPEFITTER		BLD		28.750	31.620	1.5	1.5	2.0	6.000	7.500	0.000	0.400
PLASTERER		BLD		23.500	24.500	1.5	1.5	2.0	5.200	3.550	0.000	0.100
PLUMBER		BLD		29.500	32.450	1.5	1.5	2.0	6.600	7.500	0.000	0.550
ROOFER		BLD		19.700	20.500	1.5	1.5	2.0	5.700	3.800	0.000	0.000
SHEETMETAL WORKER		ALL		27.210	28.460	1.5	1.5	2.0	6.000	4.770	1.630	0.120
SPRINKLER FITTER		BLD		31.240	33.240	1.5	1.5	2.0	6.500	5.350	0.000	0.250
STONE MASON		BLD		25.470	26.970	1.5	1.5	2.0	6.000	5.400	0.000	0.425
TERRAZZO FINISHER		BLD		24.990	0.000	1.5	1.5	2.0	6.000	5.400	0.000	0.425
TERRAZZO MASON		BLD		28.500	28.800	1.5	1.5	2.0	0.000	2.950	0.000	0.000
TRUCK DRIVER		ALL	1	25.930	0.000	1.5	1.5	2.0	7.250	3.425	0.000	0.000
TRUCK DRIVER		ALL	2	26.330	0.000	1.5	1.5	2.0	7.250	3.425	0.000	0.000
TRUCK DRIVER		ALL	3	26.530	0.000	1.5	1.5	2.0	7.250	3.425	0.000	0.000
TRUCK DRIVER		ALL	4	26.780	0.000	1.5	1.5	2.0	7.250	3.425	0.000	0.000
TRUCK DRIVER		ALL	5	27.530	0.000	1.5	1.5	2.0	7.250	3.425	0.000	0.000
TRUCK DRIVER		O&C	1	20.740	0.000	1.5	1.5	2.0	7.250	3.425	0.000	0.000
TRUCK DRIVER		O&C	2	21.060	0.000	1.5	1.5	2.0	7.250	3.425	0.000	0.000
TRUCK DRIVER		O&C	3	21.220	0.000	1.5	1.5	2.0	7.250	3.425	0.000	0.000
TRUCK DRIVER		O&C	4	21.420	0.000	1.5	1.5	2.0	7.250	3.425	0.000	0.000
TRUCK DRIVER		O&C	5	22.020	0.000	1.5	1.5	2.0	7.250	3.425	0.000	0.000
TUCKPOINTER		BLD		25.470	26.970	1.5	1.5	2.0	6.000	5.400	0.000	0.425

Legend:

M-F>8 (Overtime is required for any hour greater than 8 worked each day, Monday through Friday.)

OSA (Overtime is required for every hour worked on Saturday)

OSH (Overtime is required for every hour worked on Sunday and Holidays)

H/W (Health & Welfare Insurance)

Pensn (Pension)

Vac (Vacation)

Trng (Training)

## Explanations

### JEFFERSON COUNTY

The following list is considered as those days for which holiday rates of wages for work performed apply: New Years Day, Memorial/Decoration Day, Fourth of July, Labor Day, Veterans Day, Thanksgiving Day, Christmas Day. Generally, any of these holidays which fall on a Sunday is celebrated on the following Monday. This then makes work performed on that Monday payable at the appropriate overtime rate for holiday pay. Common practice in a given local may alter certain days of celebration such as the day after Thanksgiving for Veterans Day. If in doubt, please check with IDOL.

Oil and chip resealing (O&C) means the application of road oils and liquid asphalt to coat an existing road surface, followed by application of aggregate chips or gravel to coated surface, and subsequent rolling of material to seal the surface.

### EXPLANATION OF CLASSES

ASBESTOS - GENERAL - removal of asbestos material/mold and hazardous materials from any place in a building, including mechanical systems where those mechanical systems are to be removed. This includes the removal of asbestos materials/mold and hazardous materials from ductwork or pipes in a building when the building is to be demolished at the time or at some close future date.

ASBESTOS - MECHANICAL - removal of asbestos material from mechanical systems, such as pipes, ducts, and boilers, where the mechanical systems are to remain.

### CERAMIC TILE FINISHER, MARBLE FINISHER, TERRAZZO FINISHER

Assisting, helping or supporting the tile, marble and terrazzo mechanic by performing their historic and traditional work assignments required to complete the proper installation of the work covered by said crafts. The term "Ceramic" is used for naming the classification only, and is in no a limitation of the product handled. Ceramic takes into consideration most hard tiles.

### ELECTRONIC SYSTEMS TECHNICIAN

Installation, service and maintenance of low-voltage systems which



utilizes the transmission and/or transference of voice, sound, vision, or digital for commercial, education, security and entertainment purposes for the following: TV monitoring and surveillance, background/foreground music, intercom and telephone interconnect, field programming, inventory control systems, microwave transmission, multi-media, multiplex, radio page, school, intercom and sound burglar alarms and low voltage master clock systems.

Excluded from this classification are energy management systems, life safety systems, supervisory controls and data acquisition systems not intrinsic with the above listed systems, fire alarm systems, nurse call systems and raceways exceeding fifteen feet in length.

#### TRUCK DRIVER - BUILDING, HEAVY AND HIGHWAY CONSTRUCTION

Class 1. Drivers on 2 axle trucks hauling less than 9 ton. Air compressor and welding machines and brooms, including those pulled by separate units, truck driver helpers, warehouse employees, mechanic helpers, greasers and tiremen, pickup trucks when hauling materials, tools, or workers to and from and on-the-job site, and fork lifts up to 6,000 lb. capacity.

Class 2. Two or three axle trucks hauling more than 9 ton but hauling less than 16 ton. A-frame winch trucks, hydrolift trucks, vactor trucks or similar equipment when used for transportation purposes. Fork lifts over 6,000 lb. capacity, winch trucks, four axle combination units, and ticket writers.

Class 3. Two, three or four axle trucks hauling 16 ton or more. Drivers on water pulls, articulated dump trucks, mechanics and working forepersons, and dispatchers. Five axle or more combination units.

Class 4. Low Boy and Oil Distributors.

Class 5. Drivers who require special protective clothing while employed on hazardous waste work.

#### TRUCK DRIVER - OIL AND CHIP RESEALING ONLY.

This shall encompass laborers, workers and mechanics who drive contractor or subcontractor owned, leased, or hired pickup, dump, service, or oil distributor trucks. The work includes transporting materials and equipment (including but not limited to, oils, aggregate supplies, parts, machinery and tools) to or from the job site; distributing oil or liquid asphalt and aggregate; stock piling material when in connection with the actual oil and chip contract. The Truck Driver (Oil & Chip Resealing) wage classification does not include supplier delivered materials.

#### OPERATING ENGINEERS

GROUP I. Cranes, Dragline, Shovels, Skimmer Scoops, Clamshells or Derrick Boats, Pile Drivers, Crane-Type Backhoes, Asphalt Plant Operators, Concrete Plant Operators, Dredges, Asphalt Spreading Machines, All Locomotives, Cable Ways, or Tower Machines, Hoists, Hydraulic Backhoes, Ditching Machines or Backfiller, Cherrypickers, Overhead Cranes, Roller, Steam or Gas, Concrete Pavers, Excavators, Concrete Breakers, Concrete Pumps, Bulk Cement Plants, Cement Pumps, Derrick-Type Drills, Boat Operators, Motor Graders or Pushcats, Scoops or Tournapulls, Bulldozers, Endloaders or Fork Lifts, Power Blade or Elevating Graders, Winch Cats, Boom or Winch Trucks or Boom Tractors, Pipe Wrapping or Painting Machines, Asphalt Plant Engineer, Journeyman Lubricating Engineer, Drills (other than Derrick Type), Mud Jacks, or Well Drilling Machines, Boring Machines or Track Jacks, Mixers, Conveyors (Two), Air Compressors (Two), Water Pumps

regardless of size (Two), Welding Machines (Two), Siphons or Jets (Two), Winch Heads or Apparatuses (Two), Light Plants (Two), Waterblasters (two), All Tractors regardless of size (straight tractor only), Fireman on Stationary Boilers, Automatic Elevators, Form Grading Machines, Finishing Machines, Power Sub-Grader or Ribbon Machines, Longitudinal Floats, Distributor Operators on Trucks, Winch Heads or Apparatuses (One), Mobil Track air and heaters (two to five), Heavy Equipment Greaser, Relief Operator, Assistant Master Mechanic and Heavy Duty Mechanic, all Operators (except those listed below).

GROUP II. Assistant Operators.

GROUP III. Air Compressors (One), Water Pumps, regardless of Size (One), Waterblasters (one), Welding Machine (One), Mixers (One Bag), Conveyor (One), Siphon or Jet (One), Light Plant (One), Heater (One), Immobile Track Air (One), and Self Propelled Walk-Behind Rollers.

GROUP IV. Asphalt Spreader Oilers, Fireman on Whirlies and Heavy Equipment Oilers, Truck Cranes, Dredges, Monigans, Large Cranes - (Over 65-ton rated capacity) Concrete Plant Oiler, Blacktop Plant Oiler, and Creter Crane Oiler (when required).

GROUP V. Oiler.

GROUP VI. Master Mechanics, Operators on equipment with Booms, including jibs, 100 feet and over, and less than 150 feet long.

GROUP VII. Operators on equipment with Booms, including jibs, 150 feet and over, and less than 200 feet long.

GROUP VIII. Operators on Equipment with Booms, including jibs, 200 feet and over; Tower Cranes; Whirlie Cranes; and Operator Foreman.

Other Classifications of Work:

For definitions of classifications not otherwise set out, the Department generally has on file such definitions which are available. If a task to be performed is not subject to one of the classification of pay set out, the Department will upon being contacted state which neighboring county has such a classification and provide such rate, such rate being deemed to exist by reference in this document. If no neighboring county rate applies to the task, the Department shall undertake a special determination, such special determination being then deemed to have existed under this determination. If a project requires these, or any classification not listed, please contact IDOL at 618/993-7271 for wage rates or clarifications.

LANDSCAPING

Landscaping work falls under the existing classifications for laborer, operating engineer and truck driver. The work performed by landscape plantsman and landscape laborer is covered by the existing classification of laborer. The work performed by landscape operators (regardless of equipment used or its size) is covered by the classifications of operating engineer. The work performed by landscape truck drivers (regardless of size of truck driven) is covered by the classifications of truck driver.

# Jersey County Prevailing Wage for April 2007

Trade Name	RG	TYP	C	Base	FRMAN	*M-F>8	OSA	OSH	H/W	Pensn	Vac	Trng
=====	==	==	=	=====	=====	=====	==	==	=====	=====	=====	=====
ASBESTOS ABT-GEN		ALL		24.250	24.750	1.5	1.5	2.0	5.050	6.750	0.000	0.600
ASBESTOS ABT-MEC		BLD		25.290	26.290	1.5	1.5	2.0	4.450	2.500	0.000	0.250
BOILERMAKER		BLD		28.500	31.000	1.5	1.5	2.0	6.820	11.03	0.000	0.300
BRICK MASON		BLD		26.400	28.100	1.5	1.5	5.0	4.750	8.250	2.000	0.390
CARPENTER		ALL		30.480	31.980	1.5	1.5	2.0	5.050	3.750	0.000	0.350
CEMENT MASON		ALL		26.750	27.500	1.5	1.5	2.0	5.650	8.250	0.000	0.200
CERAMIC TILE FNSHER		BLD		22.610	0.000	1.5	1.5	2.0	5.000	4.300	0.000	0.400
ELECTRIC PWR EQMT OP		ALL		29.470	36.150	1.5	2.0	2.0	5.400	7.380	0.000	0.150
ELECTRIC PWR GRNDMAN		ALL		19.820	36.150	1.5	2.0	2.0	5.400	4.960	0.000	0.100
ELECTRIC PWR LINEMAN		ALL		34.120	36.150	1.5	2.0	2.0	5.400	8.530	0.000	0.170
ELECTRIC PWR TRK DRV		ALL		22.060	36.150	1.5	2.0	2.0	5.400	5.530	0.000	0.110
ELECTRICIAN		ALL		30.110	32.110	1.5	1.5	2.0	5.400	6.950	0.000	0.210
ELECTRONIC SYS TECH		BLD		24.240	25.740	1.5	1.5	2.0	5.650	4.730	0.000	0.250
ELEVATOR CONSTRUCTOR		BLD		37.115	41.750	2.0	2.0	2.0	8.275	4.460	2.227	0.000
FLOOR LAYER		BLD		26.930	27.680	1.5	1.5	2.0	5.000	3.750	0.000	0.350
GLAZIER		BLD		29.480	0.000	2.0	2.0	2.0	8.550	6.920	2.360	0.160
HT/FROST INSULATOR		BLD		30.440	31.440	1.5	1.5	2.0	4.850	8.360	0.000	0.450
IRON WORKER		ALL		26.350	27.850	1.5	1.5	2.0	6.360	8.250	0.000	0.420
LABORER		ALL		23.750	24.250	1.5	1.5	2.0	5.050	6.750	0.000	0.600
MACHINIST		BLD		36.890	38.890	2.0	2.0	2.0	4.380	5.650	2.550	0.000
MARBLE FINISHERS		BLD		22.610	0.000	1.5	1.5	2.0	5.000	4.300	0.000	0.400
MILLWRIGHT		ALL		30.480	31.980	1.5	1.5	2.0	5.050	3.750	0.000	0.350
OPERATING ENGINEER		ALL	1	25.900	27.030	1.5	1.5	2.0	6.200	11.45	0.000	1.000
OPERATING ENGINEER		ALL	2	24.770	27.030	1.5	1.5	2.0	6.200	11.45	0.000	1.000
OPERATING ENGINEER		ALL	3	20.290	27.030	1.5	1.5	2.0	6.200	11.45	0.000	1.000
OPERATING ENGINEER		ALL	4	20.350	27.030	1.5	1.5	2.0	6.200	11.45	0.000	1.000
OPERATING ENGINEER		ALL	5	20.020	27.030	1.5	1.5	2.0	6.200	11.45	0.000	1.000
OPERATING ENGINEER		ALL	6	26.450	27.030	1.5	1.5	2.0	6.200	11.45	0.000	1.000
OPERATING ENGINEER		ALL	7	26.750	27.030	1.5	1.5	2.0	6.200	11.45	0.000	1.000
OPERATING ENGINEER		ALL	8	27.030	27.030	1.5	1.5	2.0	6.200	11.45	0.000	1.000
PAINTER		BLD		25.700	26.700	1.5	1.5	2.0	4.650	5.150	0.000	0.350
PAINTER		HWY		26.800	27.800	1.5	1.5	2.0	4.650	5.150	0.000	0.350
PAINTER OVER 30FT		BLD		26.700	27.700	1.5	1.5	2.0	4.650	5.150	0.000	0.350
PAINTER PWR EQMT		BLD		26.700	27.700	1.5	1.5	2.0	4.650	5.150	0.000	0.350
PAINTER PWR EQMT		HWY		27.800	28.800	1.5	1.5	2.0	4.650	5.150	0.000	0.350
PILEDRIIVER		ALL		30.480	31.980	1.5	1.5	2.0	5.050	3.750	0.000	0.350
PIPEFITTER		BLD		30.600	32.100	2.0	2.0	2.0	5.350	6.100	0.000	0.130
PLASTERER		BLD		27.000	28.000	1.5	1.5	2.0	5.650	7.250	0.000	0.250
PLUMBER		BLD		30.600	32.100	2.0	2.0	2.0	5.350	6.100	0.000	0.130
ROOFER		BLD		26.250	28.250	1.5	1.5	2.0	6.100	5.950	0.000	0.200
SHEETMETAL WORKER		ALL		27.210	28.460	1.5	1.5	2.0	6.000	4.770	1.630	0.120
SPRINKLER FITTER		BLD		34.230	36.480	2.0	2.0	2.0	6.650	7.850	0.000	0.650
TERRAZZO FINISHER		BLD		31.240	0.000	1.5	1.5	2.0	0.000	0.000	0.000	0.000
TERRAZZO MASON		BLD		30.780	31.080	1.5	1.5	2.0	0.000	3.750	0.000	0.000
TRUCK DRIVER		ALL	1	25.930	0.000	1.5	1.5	2.0	7.250	3.425	0.000	0.000
TRUCK DRIVER		ALL	2	26.330	0.000	1.5	1.5	2.0	7.250	3.425	0.000	0.000
TRUCK DRIVER		ALL	3	26.530	0.000	1.5	1.5	2.0	7.250	3.425	0.000	0.000
TRUCK DRIVER		ALL	4	26.780	0.000	1.5	1.5	2.0	7.250	3.425	0.000	0.000
TRUCK DRIVER		ALL	5	27.530	0.000	1.5	1.5	2.0	7.250	3.425	0.000	0.000
TRUCK DRIVER		O&C	1	20.740	0.000	1.5	1.5	2.0	7.250	3.425	0.000	0.000
TRUCK DRIVER		O&C	2	21.060	0.000	1.5	1.5	2.0	7.250	3.425	0.000	0.000
TRUCK DRIVER		O&C	3	21.220	0.000	1.5	1.5	2.0	7.250	3.425	0.000	0.000
TRUCK DRIVER		O&C	4	21.420	0.000	1.5	1.5	2.0	7.250	3.425	0.000	0.000
TRUCK DRIVER		O&C	5	22.020	0.000	1.5	1.5	2.0	7.250	3.425	0.000	0.000

Legend :

M-F>8 (Overtime is required for any hour greater than 8 worked each day, Monday through Friday.)

OSA (Overtime is required for every hour worked on Saturday)

OSH (Overtime is required for every hour worked on Sunday and Holidays)

H/W (Health & Welfare Insurance)

Pensn (Pension)

Vac (Vacation)

Trng (Training)

## Explanations

### JERSEY COUNTY

The following list is considered as those days for which holiday rates of wages for work performed apply: New Years Day, Memorial/Decoration Day, Fourth of July, Labor Day, Veterans Day, Thanksgiving Day, Christmas Day. Generally, any of these holidays which fall on a Sunday is celebrated on the following Monday. This then makes work performed on that Monday payable at the appropriate overtime rate for holiday pay. Common practice in a given local may alter certain days of celebration such as the day after Thanksgiving for Veterans Day. If in doubt, please check with IDOL.

Oil and chip resealing (O&C) means the application of road oils and liquid asphalt to coat an existing road surface, followed by application of aggregate chips or gravel to coated surface, and subsequent rolling of material to seal the surface.

### EXPLANATION OF CLASSES

ASBESTOS - GENERAL - removal of asbestos material/mold and hazardous materials from any place in a building, including mechanical systems where those mechanical systems are to be removed. This includes the removal of asbestos materials/mold and hazardous materials from ductwork or pipes in a building when the building is to be demolished at the time or at some close future date.

ASBESTOS - MECHANICAL - removal of asbestos material from mechanical systems, such as pipes, ducts, and boilers, where the mechanical systems are to remain.

### CERAMIC TILE FINISHER AND MARBLE FINISHER

The handling, at the building site, of all sand, cement, tile, marble or stone and all other materials that may be used and installed by [a] tile layer or marble mason. In addition, the grouting, cleaning, sealing, and mixing on the job site, and all other work as required in assisting the setter. The term "Ceramic" is used for naming the classification only and is in no way a limitation of the product handled. Ceramic takes into consideration most hard tiles.

### ELECTRONIC SYSTEMS TECHNICIAN

Installation, service and maintenance of low-voltage systems which utilizes the transmission and/or transference of voice, sound, vision, or digital for commercial, education, security and entertainment purposes for the following: TV monitoring and surveillance,

background/foreground music, intercom and telephone interconnect, field programming, inventory control systems, microwave transmission, multi-media, multiplex, radio page, school, intercom and sound burglar alarms and low voltage master clock systems.

Excluded from this classification are energy management systems, life safety systems, supervisory controls and data acquisition systems not intrinsic with the above listed systems, fire alarm systems, nurse call systems and raceways exceeding fifteen feet in length.

#### TRUCK DRIVER - BUILDING, HEAVY AND HIGHWAY CONSTRUCTION

Class 1. Drivers on 2 axle trucks hauling less than 9 ton. Air compressor and welding machines and brooms, including those pulled by separate units, truck driver helpers, warehouse employees, mechanic helpers, greasers and tiremen, pickup trucks when hauling materials, tools, or workers to and from and on-the-job site, and fork lifts up to 6,000 lb. capacity.

Class 2. Two or three axle trucks hauling more than 9 ton but hauling less than 16 ton. A-frame winch trucks, hydrolift trucks, vector trucks or similar equipment when used for transportation purposes. Fork lifts over 6,000 lb. capacity, winch trucks, four axle combination units, and ticket writers.

Class 3. Two, three or four axle trucks hauling 16 ton or more. Drivers on water pulls, articulated dump trucks, mechanics and working forepersons, and dispatchers. Five axle or more combination units.

Class 4. Low Boy and Oil Distributors.

Class 5. Drivers who require special protective clothing while employed on hazardous waste work.

#### TRUCK DRIVER - OIL AND CHIP RESEALING ONLY.

This shall encompass laborers, workers and mechanics who drive contractor or subcontractor owned, leased, or hired pickup, dump, service, or oil distributor trucks. The work includes transporting materials and equipment (including but not limited to, oils, aggregate supplies, parts, machinery and tools) to or from the job site; distributing oil or liquid asphalt and aggregate; stock piling material when in connection with the actual oil and chip contract. The Truck Driver (Oil & Chip Resealing) wage classification does not include supplier delivered materials.

#### OPERATING ENGINEERS

GROUP I. Cranes, Dragline, Shovels, Skimmer Scoops, Clamshells or Derrick Boats, Pile Drivers, Crane-Type Backhoes, Asphalt Plant Operators, Concrete Plant Operators, Dredges, Asphalt Spreading Machines, All Locomotives, Cable Ways, or Tower Machines, Hoists, Hydraulic Backhoes, Ditching Machines or Backfiller, Cherrypickers, Overhead Cranes, Roller, Steam or Gas, Concrete Pavers, Excavators, Concrete Breakers, Concrete Pumps, Bulk Cement Plants, Cement Pumps, Derrick-Type Drills, Boat Operators, Motor Graders or Pushcats, Scoops or Tournapulls, Bulldozers, Endloaders or Fork Lifts, Power Blade or Elevating Graders, Winch Cats, Boom or Winch Trucks or Boom Tractors, Pipe Wrapping or Painting Machines, Asphalt Plant Engineer, Journeyman Lubricating Engineer, Drills (other than Derrick Type), Mud Jacks, or Well Drilling Machines, Boring Machines or Track Jacks, Mixers, Conveyors (Two), Air Compressors (Two), Water Pumps regardless of size (Two), Welding Machines (Two), Siphons or Jets (Two), Winch Heads or Apparatuses (Two), Light Plants (Two), Waterblasters (two), All Tractors regardless of size (straight

tractor only), Fireman on Stationary Boilers, Automatic Elevators, Form Grading Machines, Finishing Machines, Power Sub-Grader or Ribbon Machines, Longitudinal Floats, Distributor Operators on Trucks, Winch Heads or Apparatuses (One), Mobil Track air and heaters (two to five), Heavy Equipment Greaser, Relief Operator, Assistant Master Mechanic and Heavy Duty Mechanic, all Operators (except those listed below).

GROUP II. Assistant Operators.

GROUP III. Air Compressors (One), Water Pumps, regardless of Size (One), Waterblasters (one), Welding Machine (One), Mixers (One Bag), Conveyor (One), Siphon or Jet (One), Light Plant (One), Heater (One), Immobile Track Air (One), and Self Propelled Walk-Behind Rollers.

GROUP IV. Asphalt Spreader Oilers, Fireman on Whirlies and Heavy Equipment Oilers, Truck Cranes, Dredges, Monigans, Large Cranes - (Over 65-ton rated capacity) Concrete Plant Oiler, Blacktop Plant Oiler, and Creter Crane Oiler (when required).

GROUP V. Oiler.

GROUP VI. Master Mechanics, Operators on equipment with Booms, including jibs, 100 feet and over, and less than 150 feet long.

GROUP VII. Operators on equipment with Booms, including jibs, 150 feet and over, and less than 200 feet long.

GROUP VIII. Operators on Equipment with Booms, including jibs, 200 feet and over; Tower Cranes; Whirlie Cranes; and Operator Foreman.

#### TERRAZZO FINISHER

The handling of all materials used for Mosaic and Terrazzo work including preparing, mixing by hand, by mixing machine or transporting of pre-mixed materials and distributing with shovel, rake, hoe, or pail, all kinds of concrete foundations necessary for Mosaic and Terrazzo work, all cement terrazzo, magnesite terrazzo, Do-O-Tex terrazzo, epoxy matrix ter-razzo, exposed aggregate, rustic or rough washed for exterior or interior of buildings placed either by machine or by hand, and any other kind of mixture of plastics composed of chips or granules when mixed with cement, rubber, neoprene, vinyl, magnesium chloride or any other resinous or chemical substances used for seamless flooring systems, and all other building materials, all similar materials and all precast terrazzo work on jobs, all scratch coat used for Mosaic and Terrazzo work and sub-bed, tar paper and wire mesh (2x2 etc.) or lath. The rubbing, grinding, cleaning and finishing of same either by hand or by machine or by terrazzo resurfacing equipment on new or existing floors. When necessary finishers shall be allowed to assist the mechanics to spread sand bed, lay tarpaper and wire mesh (2x2 etc.) or lath. The finishing of cement floors where additional aggregate of stone is added by spreading or sprinkling on top of the finished base, and troweled or rolled into the finish and then the surface is ground by grinding machines.

#### Other Classifications of Work:

For definitions of classifications not otherwise set out, the Department generally has on file such definitions which are available. If a task to be performed is not subject to one of the classifications of pay set out, the Department will upon being contacted state which neighboring county has such a classification and

provide such rate, such rate being deemed to exist by reference in this document. If no neighboring county rate applies to the task, the Department shall undertake a special determination, such special determination being then deemed to have existed under this determination. If a project requires these, or any classification not listed, please contact IDOL at 618/993-7271 for wage rates or clarifications.

#### LANDSCAPING

Landscaping work falls under the existing classifications for laborer, operating engineer and truck driver. The work performed by landscape plantsman and landscape laborer is covered by the existing classification of laborer. The work performed by landscape operators (regardless of equipment used or its size) is covered by the classifications of operating engineer. The work performed by landscape truck drivers (regardless of size of truck driven) is covered by the classifications of truck driver.

# Jo Daviess County Prevailing Wage for April 2007

Trade Name	RG	TYP	C	Base	FRMAN	*M-F>8	OSA	OSH	H/W	Pensn	Vac	Trng
=====	==	==	=	=====	=====	=====	==	==	=====	=====	=====	=====
ASBESTOS ABT-GEN		BLD		23.760	24.760	1.5	1.5	2.0	5.850	8.730	0.000	0.600
ASBESTOS ABT-MEC		BLD		18.750	19.750	1.5	1.5	2.0	4.750	2.000	0.000	0.000
BOILERMAKER		BLD		30.970	33.970	2.0	2.0	2.0	8.270	7.740	0.000	0.300
BRICK MASON		BLD		30.000	32.500	1.5	1.5	2.0	5.500	8.680	0.000	0.420
CARPENTER		BLD		27.040	29.040	1.5	1.5	2.0	5.050	7.590	0.000	0.400
CARPENTER		HWY		27.440	29.190	1.5	1.5	2.0	6.300	7.680	0.000	0.400
CEMENT MASON		ALL		30.000	32.500	1.5	1.5	2.0	5.500	7.530	0.000	0.100
CERAMIC TILE FNSHER		BLD		24.860	0.000	1.5	1.5	2.0	5.500	4.000	0.000	0.360
COMMUNICATION TECH		BLD		28.700	30.700	1.5	1.5	2.0	8.200	8.340	0.000	0.570
ELECTRIC PWR EQMT OP		ALL		27.920	35.880	1.5	1.5	2.0	4.750	7.820	0.000	0.210
ELECTRIC PWR GRNDMAN		ALL		21.640	35.880	1.5	1.5	2.0	4.750	6.060	0.000	0.160
ELECTRIC PWR LINEMAN		ALL		33.220	35.880	1.5	1.5	2.0	4.750	9.310	0.000	0.250
ELECTRIC PWR TRK DRV		ALL		22.340	35.880	1.5	1.5	2.0	4.750	6.260	0.000	0.170
ELECTRICIAN	E	BLD		33.570	36.930	1.5	1.5	2.0	8.200	11.15	0.000	0.670
ELECTRICIAN	W	BLD		23.200	24.360	1.5	1.5	2.0	4.150	4.700	0.000	0.230
ELEVATOR CONSTRUCTOR		BLD		38.620	43.450	2.0	2.0	2.0	8.275	6.060	2.320	0.000
GLAZIER		BLD		20.580	21.810	1.5	1.5	2.0	4.750	3.900	0.000	0.200
HT/FROST INSULATOR		BLD		25.860	27.060	1.5	1.5	2.0	4.800	7.500	0.000	0.000
IRON WORKER	E	ALL		30.760	32.300	2.0	2.0	2.0	6.950	16.62	0.000	0.550
IRON WORKER	W	ALL		23.100	24.950	1.5	1.5	2.0	8.040	7.990	0.000	0.420
LABORER		BLD		23.760	24.760	1.5	1.5	2.0	5.850	8.730	0.000	0.600
LABORER		HWY		23.310	24.060	1.5	1.5	2.0	5.850	8.330	0.000	0.600
LABORER, SKILLED		HWY		24.710	25.460	1.5	1.5	2.0	5.850	8.330	0.000	0.600
LATHER		BLD		27.040	29.040	1.5	1.5	2.0	5.050	7.590	0.000	0.400
MACHINIST		BLD		36.890	38.890	2.0	2.0	2.0	4.380	5.650	2.550	0.000
MARBLE FINISHERS		BLD		24.860	0.000	1.5	1.5	2.0	5.500	4.000	0.000	0.360
MARBLE MASON		BLD		28.140	28.390	1.5	1.5	2.0	5.500	5.220	0.000	0.380
MILLWRIGHT		BLD		29.820	32.800	1.5	1.5	2.0	4.300	8.730	0.000	0.560
OPERATING ENGINEER		BLD	1	37.050	41.050	2.0	2.0	2.0	6.850	6.150	1.900	0.700
OPERATING ENGINEER		BLD	2	36.350	41.050	2.0	2.0	2.0	6.850	6.150	1.900	0.700
OPERATING ENGINEER		BLD	3	33.900	41.050	2.0	2.0	2.0	6.850	6.150	1.900	0.700
OPERATING ENGINEER		BLD	4	31.900	41.050	2.0	2.0	2.0	6.850	6.150	1.900	0.700
OPERATING ENGINEER		HWY	1	36.900	40.900	1.5	1.5	2.0	6.850	6.150	1.900	0.700
OPERATING ENGINEER		HWY	2	36.350	40.900	1.5	1.5	2.0	6.850	6.150	1.900	0.700
OPERATING ENGINEER		HWY	3	35.050	40.900	1.5	1.5	2.0	6.850	6.150	1.900	0.700
OPERATING ENGINEER		HWY	4	33.600	40.900	1.5	1.5	2.0	6.850	6.150	1.900	0.700
OPERATING ENGINEER		HWY	5	32.150	40.900	1.5	1.5	2.0	6.850	6.150	1.900	0.700
PAINTER		ALL		29.650	30.650	1.5	1.5	1.5	5.650	5.750	0.000	0.350
PILEDRIVER		BLD		29.040	31.040	1.5	1.5	2.0	5.050	7.590	0.000	0.400
PILEDRIVER		HWY		27.440	29.190	1.5	1.5	2.0	6.300	7.680	0.000	0.400
PIPEFITTER		BLD		33.700	36.060	1.5	1.5	2.0	6.430	7.130	0.000	0.630
PLASTERER		BLD		29.540	32.490	2.0	2.0	2.0	5.500	7.350	0.000	0.100
PLUMBER		BLD		33.700	36.060	1.5	1.5	2.0	6.430	7.130	0.000	0.630
ROOFER		BLD		33.650	35.650	1.5	1.5	2.0	6.460	3.310	0.000	0.330
SHEETMETAL WORKER		BLD		31.690	33.620	1.5	1.5	2.0	4.850	10.29	0.520	0.290
SPRINKLER FITTER		BLD		31.240	33.240	1.5	1.5	2.0	6.500	5.350	0.000	0.250
STONE MASON		BLD		30.000	32.500	1.5	1.5	2.0	5.500	8.680	0.000	0.420
TERRAZZO FINISHER		BLD		24.860	0.000	1.5	1.5	2.0	5.500	4.000	0.000	0.360
TERRAZZO MASON		BLD		28.140	28.390	1.5	1.5	2.0	5.500	5.220	0.000	0.380
TILE LAYER		BLD		27.040	29.040	1.5	1.5	2.0	5.050	7.590	0.000	0.400
TILE MASON		BLD		28.140	28.390	1.5	1.5	2.0	5.500	5.220	0.000	0.380
TRUCK DRIVER		O&C	1	20.630	0.000	1.5	1.5	2.0	7.250	3.317	0.000	0.000
TRUCK DRIVER		O&C	2	20.950	0.000	1.5	1.5	2.0	7.250	3.317	0.000	0.000
TRUCK DRIVER		O&C	3	21.110	0.000	1.5	1.5	2.0	7.250	3.317	0.000	0.000
TRUCK DRIVER		O&C	4	21.310	0.000	1.5	1.5	2.0	7.250	3.317	0.000	0.000
TRUCK DRIVER		O&C	5	21.910	0.000	1.5	1.5	2.0	7.250	3.317	0.000	0.000
TRUCK DRIVER	E	ALL	1	25.880	26.430	1.5	1.5	2.0	5.150	6.500	0.000	0.000
TRUCK DRIVER	E	ALL	2	26.030	26.430	1.5	1.5	2.0	5.150	6.500	0.000	0.000



TRUCK DRIVER	E	ALL	3	26.230	26.430	1.5	1.5	2.0	5.150	6.500	0.000	0.000
TRUCK DRIVER	E	ALL	4	26.430	26.430	1.5	1.5	2.0	5.150	6.500	0.000	0.000
TRUCK DRIVER	W	ALL	1	25.787	0.000	1.5	1.5	2.0	7.250	3.317	0.000	0.000
TRUCK DRIVER	W	ALL	2	26.187	0.000	1.5	1.5	2.0	7.250	3.317	0.000	0.000
TRUCK DRIVER	W	ALL	3	26.387	0.000	1.5	1.5	2.0	7.250	3.317	0.000	0.000
TRUCK DRIVER	W	ALL	4	26.637	0.000	1.5	1.5	2.0	7.250	3.317	0.000	0.000
TRUCK DRIVER	W	ALL	5	27.387	0.000	1.5	1.5	2.0	7.250	3.317	0.000	0.000
TUCKPOINTER		BLD		30.000	32.500	1.5	1.5	2.0	5.500	8.680	0.000	0.420

Legend:

M-F>8 (Overtime is required for any hour greater than 8 worked each day, Monday through Friday.)

OSA (Overtime is required for every hour worked on Saturday)

OSH (Overtime is required for every hour worked on Sunday and Holidays)

H/W (Health & Welfare Insurance)

Pensn (Pension)

Vac (Vacation)

Trng (Training)

## Explanations

### JO DAVIESS COUNTY

ELECTRICIANS (EAST) - Townships of Warren, Rush, Nora, Stockton, Wards Grove, Pleasant Valley and Berrenman.

IRONWORKERS (EAST) - That part of the county East of a North-South line from the North county line through Elizabeth, and East of a diagonal line from Elizabeth through Derinda Center to the South county line.

TRUCK DRIVERS (WEST) - That part of the county West of Rt. 78 including Stockton.

The following list is considered as those days for which holiday rates of wages for work performed apply: New Years Day, Memorial/Decoration Day, Fourth of July, Labor Day, Veterans Day, Thanksgiving Day, Christmas Day. Generally, any of these holidays which fall on a Sunday is celebrated on the following Monday. This then makes work performed on that Monday payable at the appropriate overtime rate for holiday pay. Common practice in a given local may alter certain days of celebration such as the day after Thanksgiving for Veterans Day. If in doubt, please check with IDOL.

Oil and chip resealing (O&C) means the application of road oils and liquid asphalt to coat an existing road surface, followed by application of aggregate chips or gravel to coated surface, and subsequent rolling of material to seal the surface.

### EXPLANATION OF CLASSES

ASBESTOS - GENERAL - removal of asbestos material/mold and hazardous materials from any place in a building, including mechanical systems

where those mechanical systems are to be removed. This includes the removal of asbestos materials/mold and hazardous materials from ductwork or pipes in a building when the building is to be demolished at the time or at some close future date.

ASBESTOS - MECHANICAL - removal of asbestos material from mechanical systems, such as pipes, ducts, and boilers, where the mechanical systems are to remain.

#### CERAMIC TILE FINISHER, MARBLE FINISHER, TERRAZZO FINISHER

Assisting, helping or supporting the tile, marble and terrazzo mechanic by performing their historic and traditional work assignments required to complete the proper installation of the work covered by said crafts. The term "Ceramic" is used for naming the classification only and is in no way a limitation of the product handled. Ceramic takes into consideration most hard tiles.

#### COMMUNICATIONS TECHNICIAN

Installing, manufacturing, assembling and maintaining sound and intercom, protection alarm (security), fire alarm, master antenna television, closed circuit television, low voltage control for computers and/or door monitoring, school communications systems, telephones and servicing of nurse and emergency calls, and the installation and maintenance of transmit and receive antennas, transmitters, receivers, and associated apparatus which operates in conjunction with above systems. All work associated with these system installations will be included EXCEPT the installation of protective metallic conduit in new construction projects (excluding less than ten-foot runs strictly for protection of cable) and 120 volt AC (or higher) power wiring and associated hardware.

#### LABORER, SKILLED - HIGHWAY

Individuals engaged in the following types of work, irrespective of the site of the work: asbestos abatement worker, handling of any materials with any foreign matter harmful to skin or clothing, track laborer, cement handlers, chloride handlers, the unloading and loading with steel workers and re-bars, concrete workers wet, tunnel helpers in free air, batch dumpers, mason tenders, kettle and tar men, tank cleaners, plastic installers, scaffold workers, motorized buggies or motorized unit used for wet concrete or handling of building materials, laborers with de-watering systems, sewer workers plus depth, rod and chainmen with technical engineers, rod and chainmen with land surveyors, rod and chainmen with surveyors, vibrator operators, cement silica, clay, fly ash, lime and plasters, handlers (bulk or bag), cofferdam workers plus depth, on concrete paving, placing, cutting and tying of reinforcing, deck hand, dredge hand, and shore laborers, bankmen on floating plant, grade checker, power tools, front end man on chip spreaders, cession workers plus depth, gunnite nozzle men, lead man on sewer work, welders, cutters, burners and torchmen, chainsaw operators, jackhammer and drill operators, layout man and/or drainage tile layer, steel form setter - street and highway, air tamping hammermen, signal man on crane, concrete saw operator, screedman on asphalt pavers, laborers tending masons with hot material or where foreign materials are used, mortar mixer operators, multiple concrete duct - leadsman, lumen, asphalt raker, curb asphalt machine operator, ready mix scalemen (permanent, portable or temporary plant), laborers handling masterplate or similar materials, laser beam operator, concrete burning machine operator, coring machine operator, plaster tender, underpinning and shoring of buildings, pump men, manhole and catch basin, dirt and stone tamper, hose men on concrete pumps, hazardous waste worker, lead base paint

abatement worker, lining of pipe, refusing machine, assisting on direct boring machine, the work of laying watermain, fire hydrants, all mechanical joints to watermain work, sewer worker, and tapping water service and forced lift station mechanical worker.

#### TRUCK DRIVER - BUILDING, HEAVY AND HIGHWAY CONSTRUCTION - WEST

Class 1. Drivers on 2 axle trucks hauling less than 9 ton. Air compressor and welding machines and brooms, including those pulled by separate units, truck driver helpers, warehouse employees, mechanic helpers, greasers and tiremen, pickup trucks when hauling materials, tools, or workers to and from an on-the-job site, and fork lifts up to 6,000 lb. capacity.

Class 2. Two or three axle trucks hauling more than 9 ton but hauling less than 16 ton. A-frame winch trucks, hydrolift trucks, vector trucks or similar equipment when used for transportation purposes. Fork lifts over 6,000 lb. capacity, winch trucks, four axle combination units, and ticket writers.

Class 3. Two, three or four axle trucks hauling 16 ton or more. Drivers on water pulls, articulated dump trucks, mechanics and working forepersons, and dispatchers. Five axle or more combination units.

Class 4. Low Boy and Oil Distributors.

Class 5. Drivers who require special protective clothing while employed on hazardous waste work.

#### TRUCK DRIVER - BUILDING, HEAVY AND HIGHWAY CONSTRUCTION - EAST

Class 1. Two or three Axle Trucks. A-frame Truck when used for transportation purposes; Air Compressors and Welding Machines, including those pulled by cars, pick-up trucks and tractors; Ambulances; Batch Gate Lockers; Batch Hopperman; Car and Truck Washers; Carry-alls; Fork Lifts and Hoisters; Helpers; Mechanics Helpers and Greasers; Oil Distributors 2-man operation; Pavement Breakers; Pole Trailer, up to 40 feet; Power Mower Tractors; Self-propelled Chip Spreader; Skipman; Slurry Trucks, 2-man operation; Slurry Truck Conveyor Operation, 2 or 3 man; Teamsters; Unskilled dumpman; and Truck Drivers hauling warning lights, barricades, and portable toilets on the job site.

Class 2. Four axle trucks; Dump Crets and Adgetors under 7 yards; Dumpsters, Track Trucks, Euclids, Hug Bottom Dump Turnapulls or Turnatrailers when pulling other than self-loading equipment or similar equipment under 16 cubic yards; Mixer Trucks under 7 yards; Ready-mix Plant Hopper Operator, and Winch Trucks, 2 Axles.

Class 3. Five axle trucks; Dump Crets and Adgetors 7 yards and over; Dumpsters, Track Trucks, Euclids, Hug Bottom Dump Turnatrailers or turnapulls when pulling other than self-loading equipment or similar equipment over 16 cubic yards; Explosives and/or Fission Material Trucks; Mixer Trucks 7 yards or over; Mobile Cranes while in transit; Oil Distributors, 1-man operation; Pole Trailer, over 40 feet; Pole and Expandable Trailers hauling material over 50 feet long; Slurry trucks, 1-man operation; Winch trucks, 3 axles or more; Mechanic--Truck Welder and Truck Painter.

Class 4. Six axle trucks; Dual-purpose vehicles, such as mounted crane trucks with hoist and accessories; Foreman; Master Mechanic;

Self-loading equipment like P.B. and trucks with scoops on the front.

TRUCK DRIVER - OIL AND CHIP RESEALING ONLY.

This shall encompass laborers, workers and mechanics who drive contractor or subcontractor owned, leased, or hired pickup, dump, service, or oil distributor trucks. The work includes transporting materials and equipment (including but not limited to, oils, aggregate supplies, parts, machinery and tools) to or from the job site; distributing oil or liquid asphalt and aggregate; stock piling material when in connection with the actual oil and chip contract. The Truck Driver (Oil & Chip Resealing) wage classification does not include supplier delivered materials.

OPERATING ENGINEERS - BUILDING

Class 1. Assistant Craft Foreman; Craft Foreman; Mechanic; Asphalt Plant; Asphalt Spreader; Autograde; Batch Plant; Benoto (requires Two Engineers); Boiler and Throttle Valve; Caisson Rigs; Central Redi-Mix Plant; Combination Back Hoe Front End-loader Machine; Compressor and Throttle Valve; Concrete Breaker (Truck Mounted); Concrete Conveyor; Concrete Paver; Concrete Placer; Concrete Pump (Truck Mounted); Concrete Tower, Cranes, All, Cranes, Hammerhead, Creter Crane; Crusher, Stone, etc.; Derricks, All; Derricks, Traveling; Formless Curb and Gutter Machine; Grader, Elevating; Grouting Machines; Highlift Shovels or Front Endloader 2-1/4 yd. and over; Hoists, Elevators, outside type rack and pinion and similar machines; Hoists, one, two and three Drum; Hoists, Two tigger One Floor; Hydraulic Backhoes; Hydraulic Boom Trucks; Locomotives, All; Motor Patrol; Pile Drivers and Skid Rig; Post Hole Digger; Pre-Stress Machine; Pump Cretes; Squeeze Cretes-screw Type Pumps; Gypsum Bulker and Pump; Raised and Blind Hole Drill; Rock Drill; Roto Mill Grinder; Scoops - Tractor Drawn; Slip-form Paver; Straddle Buggies; Tie Back Machine; Tractor with Book and Side Boom; Trenching Machines.

Class 2. Bobcat (over 3/4 cu. yd.); Boilers Brick Forklift; Broom, All Power Propelled; Bulldozers; Concrete Mixer (Two Bag and Over); Conveyor, Portable; Forklift Trucks; Greaser Engineer; Highlift Shovels or Front Endloaders under 2-1/4 yd.; Hoists, Automatic; Hoists, Sewer Dragging Machine; Hoists, Tigger Single Drum; Rollers, All; Steam Generators; Tractors, All; Tractor Drawn Vibratory Roller; Winch Trucks with "A" Frame.

Class 3. Air Compressor; Asphalt Spreader; Combination - Small Equipment Operator; Generators; Heaters, Mechanical; Hoists, Inside Elevators - (Rheostat Manual Controlled); Hydraulic Power Units (Pile Driving and Extracting); Pumps, over 3" (1 to 3 not to exceed a total of 300 ft.); Pumps, Well Points; Welding Machines (2 through 5); Winches, 4 small Electric Drill Winches; Bobcat (up to and including 3/4 cu. yd.).

Class 4. Hoists, Inside Elevators, Push Button with Automatic Doors; Oilers; Brick Forklift.

OPERATING ENGINEERS - HEAVY AND HIGHWAY CONSTRUCTION

Class 1. Craft Foreman; Asphalt Plant, Asphalt Heater and Planer Combination; Asphalt Heater Scarfire; Asphalt Silo Tender; Asphalt Spreader; Autograder; ABG Paver; Backhoes with Caisson attachment; Ballast Regulator, Belt Loader; Caisson Rigs; Car Dumper; Central Redi-Mix Plant; Backhoe w/shear attachments; Combination Backhoe Front Endloader Machine, (1 cu. yd. Backhoe Bucket or over or with attachments); Concrete Breaker (Truck Mounted); Concrete Conveyor;

Concrete Paver over 27E cu. ft.; Concrete Placer; Concrete Tube Float; Cranes, all attachments; Cranes, Hammerhead, Linden, Peco & Machines of a like nature; Crete Crane; Crusher, Stone, etc.; Derricks, All; Derrick Boats; Derricks, Traveling; Directional Boring Machine over 12"; Dredges; Field Mechanic-Welder; Formless Curb and Gutter Machine; Gradall and Machines of a like nature; Grader, Elevating; Grader, Motor Grader, Motor Patrol, Auto Patrol, Form Grader, Pull Grader, Subgrader; Guard Rail Post Driver Mounted; Hoists, One, Two and Three Drum; Hydraulic Backhoes; Pile Drivers and Skid Rig; Pre-Stress Machine; Pump Cretes Dual Ram; Rock Drill - Crawler or Skid Rig; Rock Drill - Truck Mounted; Rock/Track Tamper; Roto Mill Grinder; Slip-Form Paver; Soil Test Drill Rig (Truck Mounted); Straddle Buggies; GCI Crane; Hydraulic Telescoping form (Tunnel); Tie Back Machine; Tractor Drawn Belt Loader; Tractor with Boom; Tractor-aire with Attachments; Traffic Barrier conveyor machine; Raised or Blind Hole; Trenching Machine; Truck Mounted Concrete Pump with Boom; Truck Mounted Concrete Conveyor; Underground Boring and/or Mining Machines; Wheel Excavator; Widener (APSCO).

Class 2. Batch Plant; Bituminous Mixer; Boiler and Throttle Valve; Bulldozers; Car Loader Trailing Conveyors; Combination Backhoe Front Endloader Machine (less than 1 cu. yd. Backhoe Bucket or over or with attachments); Compressor and Throttle Valve; Compressor, Common Receiver (3); Concrete Breaker or Hydro Hammer; Concrete Grinding Machine; Concrete Mixer or Paver 7S Series to and including 27 cu. ft.; Concrete Spreader; Concrete Curing Machine, Burlap Machine, Belting Machine and Sealing Machine; Conveyor Muck Cars (Haglund or Similar Type); Drills, all; Finishing Machine - Concrete; Greaser Engineer; Highlift Shovels or Front Endloader; Hoist - Sewer Dragging Machine; Hydraulic Boom Trucks (All Attachments); Hydro Blaster; Laser Screed; All Locomotives, Dinky; Pump Cretes; Squeeze Cretes-Screw Type Pumps, Gypsum Bulker and Pump; Roller, Asphalt; Rotary Snow Plows; Rototiller, Seaman, etc., self-propelled; Scoops - Tractor Drawn; Self-Propelled Compactor; Spreader - Chip - Stone, etc.; Scraper; Scraper - Prime Mover in Tandem (Regardless of Size); Tank Car Heater; Tractors, Push, Pulling Sheeps Foot, Disc, Compactor, etc. Tug Boats.

Class 3. Boilers; Brooms, All Power Propelled; Cement Supply Tender; Compressor, Common Receiver (2); Concrete Mixer (Two Bag and Over); Conveyor, Portable; Farm-Type Tractors Used for Mowing, Seeding, etc.; Fireman on Boilers; Forklift Trucks; Grouting Machine; Hoists, Automatic; Hoists, All Elevators; Hoists, Tugger Single Drum; Jeep Diggers, Low Boys; Pipe Jacking Machines; Post-Hole Digger; Power Saw, Concrete Power Driven; Pug Mills; Rollers, other than asphalt; Seed and Straw Blower; Steam Generators; Stump Machine; Winch Trucks with "A" Frame; Work Boats; Tamper - Form-Motor Driven.

Class 4. Air Compressor - Small and Large; Asphalt Spreader, Backend Man; Bobcat (Skid Steer) all; Combination - Small Equipment Operator; Directional Boring Machine up to 12"; Generators - Small 50kw and Under; Generators - Large over 50kw; Heaters, Mechanical; Hydraulic Power Unit (Pile Driving, Extracting, or Drilling); Hydro-Blaster; Light Plants, All (1 through 5); Pumps, over 3" (1 to 3 not to exceed a total of 300 ft.); Pumps, Well Points; Tract-aire; Welding Machines (2 through 5); Winches, 4 Small Electric Drill Winches.

Class 5. Oilers and Directional Boring Machine Locator.

Other Classifications of Work:

For definitions of classifications not otherwise set out, the Department generally has on file such definitions which are

available. If a task to be performed is not subject to one of the classifications of pay set out, the Department will upon being contacted state which neighboring county has such a classification and provide such rate, such rate being deemed to exist by reference in this document. If no neighboring county rate applies to the task, the Department shall undertake a special determination, such special determination being then deemed to have existed under this determination. If a project requires these, or any classification not listed, please contact IDOL at 618/993-7271 for wage rates or clarifications.

#### LANDSCAPING

Landscaping work falls under the existing classifications for laborer, operating engineer and truck driver. The work performed by landscape plantsman and landscape laborer is covered by the existing classification of laborer. The work performed by landscape operators (regardless of equipment used or its size) is covered by the classifications of operating engineer. The work performed by landscape truck drivers (regardless of size of truck driven) is covered by the classifications of truck driver.

# Johnson County Prevailing Wage for April 2007

Trade Name	RG	TYP	C	Base	FRMAN	*M-F>8	OSA	OSH	H/W	Pensn	Vac	Trng
=====	==	==	=	=====	=====	=====	==	==	=====	=====	=====	=====
ASBESTOS ABT-GEN		ALL		20.750	21.200	1.5	1.5	2.0	5.250	5.600	0.000	0.700
ASBESTOS ABT-MEC		BLD		20.800	0.000	2.0	2.0	2.0	5.000	3.400	0.000	0.000
BOILERMAKER		BLD		28.500	31.000	1.5	1.5	2.0	6.820	11.03	0.000	0.300
BRICK MASON		BLD		25.470	26.970	1.5	1.5	2.0	6.000	5.400	0.000	0.425
CARPENTER		BLD		27.780	29.280	1.5	1.5	2.0	5.050	3.750	0.000	0.350
CARPENTER		HWY		27.730	29.230	1.5	1.5	2.0	5.050	3.750	0.000	0.350
CEMENT MASON		BLD		23.500	24.500	1.5	1.5	2.0	5.200	3.550	0.000	0.100
CEMENT MASON		HWY		23.750	24.750	1.5	1.5	2.0	5.300	3.700	0.000	0.300
CERAMIC TILE FNSHER		BLD		24.990	0.000	1.5	1.5	2.0	6.000	5.400	0.000	0.425
ELECTRICIAN		ALL		32.910	35.160	1.5	1.5	2.0	5.150	6.580	0.000	0.490
ELECTRONIC SYS TECH		BLD		25.700	27.200	1.5	1.5	2.0	5.150	3.340	0.000	0.250
FLOOR LAYER		BLD		26.930	27.680	1.5	1.5	2.0	5.000	3.750	0.000	0.350
GLAZIER		BLD		22.930	0.000	1.5	1.5	2.0	4.320	3.800	0.000	0.300
HT/FROST INSULATOR		BLD		26.110	27.110	1.5	1.5	2.0	4.800	6.860	0.000	0.190
IRON WORKER		ALL		22.650	23.650	1.5	1.5	2.0	5.760	6.450	0.000	0.310
LABORER		BLD		20.750	21.200	1.5	1.5	2.0	5.250	5.600	0.000	0.600
LABORER		HWY		21.000	21.450	1.5	1.5	2.0	5.350	6.150	0.000	0.600
LABORER		O&C		15.750	16.200	1.5	1.5	2.0	5.350	6.150	0.000	0.600
MACHINIST		BLD		36.890	38.890	2.0	2.0	2.0	4.380	5.650	2.550	0.000
MARBLE FINISHERS		BLD		24.990	0.000	1.5	1.5	2.0	6.000	5.400	0.000	0.425
MARBLE MASON		BLD		25.470	26.970	1.5	1.5	2.0	6.000	5.400	0.000	0.425
MILLWRIGHT		BLD		27.780	29.280	1.5	1.5	2.0	5.050	3.750	0.000	0.350
MILLWRIGHT		HWY		27.730	29.230	1.5	1.5	2.0	5.050	3.750	0.000	0.350
OE RIVER 1		RIV	1	26.900	0.000	1.5	1.5	2.0	5.650	6.100	0.000	1.100
OE RIVER 2		RIV	2	23.450	0.000	1.5	1.5	2.0	5.650	6.100	0.000	1.100
OPERATING ENGINEER		ALL	1	26.800	27.800	1.5	1.5	2.0	5.650	6.100	0.000	1.100
OPERATING ENGINEER		ALL	2	24.900	27.800	1.5	1.5	2.0	5.650	6.100	0.000	1.100
OPERATING ENGINEER		ALL	3	24.150	27.800	1.5	1.5	2.0	5.650	6.100	0.000	1.100
OPERATING ENGINEER		ALL	4	21.400	27.800	1.5	1.5	2.0	5.650	6.100	0.000	1.100
OPERATING ENGINEER		O&C	1	20.100	21.100	1.5	1.5	2.0	5.650	6.100	0.000	1.100
OPERATING ENGINEER		O&C	2	18.680	21.100	1.5	1.5	2.0	5.650	6.100	0.000	1.100
OPERATING ENGINEER		O&C	3	18.120	21.100	1.5	1.5	2.0	5.650	6.100	0.000	1.100
OPERATING ENGINEER		O&C	4	16.050	21.100	1.5	1.5	2.0	5.650	6.100	0.000	1.100
PAINTER		BLD		22.790	23.790	1.5	1.5	2.0	5.430	4.500	0.000	0.250
PAINTER		HWY		27.090	28.090	1.5	1.5	2.0	5.430	4.500	0.000	0.250
PAINTER OVER 30FT		BLD		23.790	24.790	1.5	1.5	2.0	5.430	4.500	0.000	0.250
PAINTER PWR EQMT		BLD		23.790	24.790	1.5	1.5	2.0	5.430	4.500	0.000	0.250
PAINTER PWR EQMT		HWY		28.090	29.090	1.5	1.5	2.0	5.430	4.500	0.000	0.250
PILEDRIVER		BLD		27.780	29.280	1.5	1.5	2.0	5.050	3.750	0.000	0.350
PILEDRIVER		HWY		27.730	29.230	1.5	1.5	2.0	5.050	3.750	0.000	0.350
PIPEFITTER		BLD		31.300	34.430	1.5	2.0	2.0	6.450	5.030	0.000	0.620
PLASTERER		BLD		23.500	24.500	1.5	1.5	2.0	5.200	3.550	0.000	0.100
PLUMBER		BLD		31.300	34.430	1.5	2.0	2.0	6.450	5.030	0.000	0.620
ROOFER		BLD		19.700	20.500	1.5	1.5	2.0	5.700	3.800	0.000	0.000
SHEETMETAL WORKER		ALL		27.210	28.460	1.5	1.5	2.0	6.000	4.770	1.630	0.120
SPRINKLER FITTER		BLD		31.240	33.240	1.5	1.5	2.0	6.500	5.350	0.000	0.250
STONE MASON		BLD		25.470	26.970	1.5	1.5	2.0	6.000	5.400	0.000	0.425
TERRAZZO FINISHER		BLD		24.990	0.000	1.5	1.5	2.0	6.000	5.400	0.000	0.425
TERRAZZO MASON		BLD		28.500	28.800	1.5	1.5	2.0	0.000	2.950	0.000	0.000
TRUCK DRIVER		ALL	1	24.990	0.000	1.5	1.5	2.0	7.250	4.200	0.000	0.000
TRUCK DRIVER		ALL	2	25.390	0.000	1.5	1.5	2.0	7.250	4.200	0.000	0.000
TRUCK DRIVER		ALL	3	25.590	0.000	1.5	1.5	2.0	7.250	4.200	0.000	0.000
TRUCK DRIVER		ALL	4	25.840	0.000	1.5	1.5	2.0	7.250	4.200	0.000	0.000
TRUCK DRIVER		ALL	5	26.590	0.000	1.5	1.5	2.0	7.250	4.200	0.000	0.000
TRUCK DRIVER		O&C	1	19.500	0.000	1.5	1.5	2.0	4.275	4.670	0.000	0.000
TRUCK DRIVER		O&C	2	15.900	0.000	1.5	1.5	2.0	4.275	4.670	0.000	0.000
TRUCK DRIVER		O&C	3	16.400	0.000	1.5	1.5	2.0	4.275	4.670	0.000	0.000
TUCK POINTER		BLD		25.470	26.970	1.5	1.5	2.0	6.000	5.400	0.000	0.425

Legend :

M-F>8 (Overtime is required for any hour greater than 8 worked each day, Monday through Friday.)

OSA (Overtime is required for every hour worked on Saturday)

OSH (Overtime is required for every hour worked on Sunday and Holidays)

H/W (Health & Welfare Insurance)

Pensn (Pension)

Vac (Vacation)

Trng (Training)

## Explanations

### JOHNSON COUNTY

The following list is considered as those days for which holiday rates of wages for work performed apply: New Years Day, Memorial/Decoration Day, Fourth of July, Labor Day, Veterans Day, Thanksgiving Day, Christmas Day. Generally, any of these holidays which fall on a Sunday is celebrated on the following Monday. This then makes work performed on that Monday payable at the appropriate overtime rate for holiday pay. Common practice in a given local may alter certain days of celebration such as the day after Thanksgiving for Veterans Day. If in doubt, please check with IDOL.

Oil and chip resealing (O&C) means the application of road oils and liquid asphalt to coat an existing road surface, followed by application of aggregate chips or gravel to coated surface, and subsequent rolling of material to seal the surface.

### EXPLANATION OF CLASSES

ASBESTOS - GENERAL - removal of asbestos material/mold and hazardous materials from any place in a building, including mechanical systems where those mechanical systems are to be removed. This includes the removal of asbestos materials/mold and hazardous materials from ductwork or pipes in a building when the building is to be demolished at the time or at some close future date.

ASBESTOS - MECHANICAL - removal of asbestos material from mechanical systems, such as pipes, ducts, and boilers, where the mechanical systems are to remain.

### LABORER - OIL AND CHIP RESEALING ONLY

Hook and unhook chip box from aggregate truck; distribute material within chip box; perform flagging work related to oil and chip resealing; hand spray oil fluids; handle traffic control, including setting-up and maintaining barricades, drums, cones, delineators, signs and other such items, as well as laying-out and applying or removing temporary roadway markings used to control traffic in job site related to oil and chip resealing; and perform clean-up related to oil and chip resealing.



CERAMIC TILE FINISHER, MARBLE FINISHER, TERRAZZO FINISHER

Assisting, helping or supporting the tile, marble and terrazzo mechanic by performing their historic and traditional work assignments required to complete the proper installation of the work covered by said crafts. The term "Ceramic" is used for naming the classification only, and is in no a limitation of the product handled. Ceramic takes into consideration most hard tiles.

ELECTRONIC SYSTEMS TECHNICIAN

Installation, service and maintenance of low-voltage systems which utilizes the transmission and/or transference of voice, sound, vision, or digital for commercial, education, security and entertainment purposes for the following: TV monitoring and surveillance, background/foreground music, intercom and telephone interconnect, field programming, inventory control systems, microwave transmission, multi-media, multiplex, radio page, school, intercom and sound burglar alarms and low voltage master clock systems.

Excluded from this classification are energy management systems, life safety systems, supervisory controls and data acquisition systems not intrinsic with the above listed systems, fire alarm systems, nurse call systems and raceways exceeding fifteen feet in length.

TRUCK DRIVER - BUILDING, HEAVY AND HIGHWAY CONSTRUCTION

Class 1. Drivers on 2 axle trucks hauling less than 9 ton. Air compressor and welding machines and brooms, including those pulled by separate units, truck driver helpers, warehouse employees, mechanic helpers, greasers and tiremen, pickup trucks when hauling materials, tools, or workers to and from and on-the-job site, and fork lifts up to 6,000 lb. capacity.

Class 2. Two or three axle trucks hauling more than 9 ton but hauling less than 16 ton. A-frame winch trucks, hydrolift trucks, vector trucks or similar equipment when used for transportation purposes. Fork lifts over 6,000 lb. capacity, winch trucks, four axle combination units, and ticket writers.

Class 3. Two, three or four axle trucks hauling 16 ton or more. Drivers on water pulls, articulated dump trucks, mechanics and working forepersons, and dispatchers. Five axle or more combination units.

Class 4. Low Boy and Oil Distributors.

Class 5. Drivers who require special protective clothing while employed on hazardous waste work.

TRUCK DRIVER - O & C (Oil and Chip Resealing ONLY)

It involves driving of contractor or subcontractor owned, leased, or hired pickup, dump, service, or oil distributor trucks. Includes transporting materials and equipment (including, but not limited to oils, aggregate supplies, parts, machinery and tools) to or from the job site; distributing oil or liquid asphalt and aggregate; stock piling material; and maintaining trucks at job site related to oil and chip resealing.

Class 1. Distributors, liquid asphalt hauling and hauling of asphalt rubber-tired rollers.

Class 2. Stockpiling.

Class 3. Tandem hauling to job site.

OPERATING ENGINEERS - BUILDING, HEAVY AND HIGHWAY CONSTRUCTION

Class 1. APSCO or Equal Spreading Machine, Backhoe, Backfiller, Boom or Winch Cat, Bituminous Mixplane Machine, Blacksmith, Bituminous Surfacing Machine, Bull-Dozer, Crane, Shovel, Dragline, Truck Crane, Pile Driver, Concrete Breaker, Concrete or Pumpcrete Pumps, Dinky or Standard Locomotives, Well or Caisson Drills, Elevating Grader, Fork Lifts, Flexplane, Gradeall, Hi-Lift Hoists, Guy-Derricks, Hysters, Mechanic Motor Patrol, Mixers-21 cu. ft. or over, Push Cats, Pulls and Scrapers, Two Well Point Pumps, Pulverizer or Tiller, PugMill, Rubber-Tired Farm Type Tractor with Bulldozer/Blade/Auger or hi-lift over 1/2 yd., Jersey Spreader, Tract-Air used with Drill or Hi-Lift, Trenching or Ditching Machines, Wood Chipper w/Tractor, Self-Propelled Roller w/Blade, Equipment Greaser, Self-Propelled Bump Grinder on Concrete pavement, Boat Operator, Skid-Loaders, Tuggers, Lazer Screed, and Self-Propelled Chip Spreader (when others run conveyors).

Class 2. Any type tractor pulling any type roller or disc, Two Air Compressors (220 cu. ft. capacity or over), Two AirTract Drills, Air-Track Drill w/Compressor, Automatic Bins or Scales w/Compressor or Generator, Pipeline Boring Machine, Bulk Cement Plant w/Separate Compressor, Power Operated Bull Float, Hydra-Lift w/Single Motor, Straw Mulcher Blower w/Spout, Self-Propelled Roller/Compactor, Back-End man on Bituminous Surfacing Machine, oiler on milling machine.

Class 3. Air Compressor w/Valve driving piling, Boom or Winch Type Truck, Two Conveyors, Self-Propelled Concrete Saw, Form Grader, Truck Crane Oiler, Self-Propelled Vibrator, Rubber Tired Farm Type Tractor w/Blade/Bulldozer/Auger/hi-lift - 1/2 yd. or less, Elevator Operator, Man Lift (scissor lift) when lifting materials.

Class 4. Air-Track Drill (one), Belt Drag Machine, Power Broom, Mechanical Plasterer Applicator, Trac-Air, Air Compressor (220 cu. ft. or over) One, Air Compressor (under 220 cu. ft) four, Automatic Bin, Bulk Cement Plant w/Built-in Compressor running off same motor or electric motor, Fireman or Switchman, Self-Propelled Form Tamper, Light Plants (4), Welding Machines (4), Pumps (4), or Combination of four (4) Pumps, Light Plants, Welding Machines, Air-Compressors (under 220 cu. ft.), Mudjacks or Wood Chipper, Mixers - less than 21 cu. ft. Mortar Mixer w/Skip or Pump, Pipeline Tract Jack. One Operating Engineer may operate and maintain any combination of the following pieces of equipment, not to exceed four (4) which shall be within a reasonable distance, such combination may include any equipment in this classification: (Compressors, Light Plants, Generators, Welding Machines, Pumps or Conveyors), One Well- Point Pump, Two Motor Driven Heaters, One Air Compressor (under 220 cu. ft.), One Engine-Driven Conveyor, One Motor Driven Heater, One Light Plant, One Pump, One Welding Machine, One Ulmac or Equal Spreader, Oilers, and one Generator 10 kw or greater.

OPERATING ENGINEER - O & C (Oil and Chip Resealing ONLY). Includes the operation of all motorized heavy equipment used in oil and chip rsealing, including but not limited to operating self-propelled chip spreaders, and all types of rollers (both hard and rubber tired); and other duties pertaining to the operation or maintenance of heavy equipment related to oil and chip resealing.

Class 1. See Class 1 above for types of equipment operated.

Class 2. See Class 2 above for types of equipment operated.

Class 3. See Class 3 above for types of equipment operated.

Class 4. See Class 4 above for types of equipment operated.

OPERATING ENGINEER RIVER WORK 1 - operate the following machines when working on River Work and Levee Work on the Mississippi and Ohio Rivers, Lakes and Tributaries: Crane, Shovel, Drageline, Scrapers, Dredge, Derrick, Pile-Driver, Push Boat, all power boat operators, Mechanic, Engineman on Dredge, Leverman on Dredge, All Bituminous Spreader machines, Backhoe, Backfiller, Boom, or Winch Cat, Bituminous Mixplane Machine, Blacksmith, Bituminous Surfacing Machine, Bulldozer, Truck Cranes, Hydraulic Truck Mounted Boom/Crane, Concrete Finishing Machine, or Spreader Machine, Concrete Breaker, Concrete or Pumpcrete Machines, Concrete Plant Operator, All Off Road Material Hauling Equipment, Dinky or Standard Locomotives, Well Drill, Elevating Grader, Fork-Lifts, Flexplane, Gradeall, Hi-Lift, Power Handblade Tugger type Hoist, Hoist Two Drum (or over one), Gyderrick, Hyster, Motor Patrol, Mixers - 21 Cu. Ft. or over, Push Cat, Pulls, & Scrapers, Pumps-Two Well Points, Equipment Greaser, P & H Pulverizer or Pulverizer equal to Pugmill, Pugmill, Rubber-Tired farm type tractor w/Bulldozer/Blade/Auger or Hi-Lift over ½ yard, Skimmer Scoops, Seaman Tiller, Jersey Spreader, Tract-Air used with Drill or Hi-Lift, Trenching or Ditching Machine, Wood Chipper w/Tractor, self-propelled roller w/Blade, Concrete Pumps and Small Equipment Operators.

OPERATING ENGINEER RIVER 2 - when working on River Work and Levee Work on the Mississippi and Ohio Rivers, Lakes and Tributaries shall be employed as the Oiler or Fireman on Crane, Dragline, Shovel, Dredge, Truck Crane, Pile Driver, Gradeall, Dinky or Standard Locomotive, Guy Derrick, Trenching Machine or Ditching Machine 80 H.P. and over, All Terrain (cherry-picker) with over 40 ton Lifting Capacity, Deck Oiler and Deckhands.

#### Other Classifications of Work:

For definitions of classifications not otherwise set out, the Department generally has on file such definitions which are available. If a task to be performed is not subject to one of the classifications of pay set out, the Department will upon being contacted state which neighboring county has such a classification and provide such rate, such rate being deemed to exist by reference in this document. If no neighboring county rate applies to the task, the Department shall undertake a special determination, such special determination being then deemed to have existed under this determination. If a project requires these, or any classification not listed, please contact IDOL at 618/993-7271 for wage rates or clarifications.

#### LANDSCAPING

Landscaping work falls under the existing classifications for laborer, operating engineer and truck driver. The work performed by landscape plantsman and landscape laborer is covered by the existing classification of laborer. The work performed by landscape operators (regardless of equipment used or its size) is covered by the classifications of operating engineer. The work performed by landscape truck drivers (regardless of size of truck driven) is covered by the classifications of truck driver.

# Kane County Prevailing Wage for April 2007

Trade Name	RG	TYP	C	Base	FRMAN	*M-F>8	OSA	OSH	H/W	Pensn	Vac	Trng
=====	==	==	=	=====	=====	=====	==	==	=====	=====	=====	=====
ASBESTOS ABT-GEN		ALL		31.550	32.300	1.5	1.5	2.0	7.460	4.840	0.000	0.170
ASBESTOS ABT-MEC		BLD		23.300	24.800	1.5	1.5	2.0	7.860	4.910	0.000	0.000
BOILERMAKER		BLD		38.540	42.000	2.0	2.0	2.0	6.720	7.440	0.000	0.300
BRICK MASON		BLD		34.850	38.340	1.5	1.5	2.0	7.050	7.870	0.000	0.380
CARPENTER		ALL		35.320	37.320	1.5	1.5	2.0	6.760	5.320	0.000	0.490
CEMENT MASON		ALL		35.300	37.300	2.0	1.5	2.0	6.400	8.910	0.000	0.100
CERAMIC TILE FNSHER		BLD		28.520	0.000	2.0	1.5	2.0	5.650	5.750	0.000	0.330
COMMUNICATION TECH	N	BLD		29.960	31.760	1.5	1.5	2.0	5.842	6.290	0.000	0.375
COMMUNICATION TECH	S	BLD		32.120	34.220	1.5	1.5	2.0	8.490	7.390	0.000	0.640
ELECTRIC PWR EQMT OP		ALL		27.920	35.880	1.5	1.5	2.0	4.750	7.820	0.000	0.210
ELECTRIC PWR GRNDMAN		ALL		21.640	35.880	1.5	1.5	2.0	4.750	6.060	0.000	0.160
ELECTRIC PWR LINEMAN		ALL		33.220	35.880	1.5	1.5	2.0	4.750	9.310	0.000	0.250
ELECTRIC PWR TRK DRV		ALL		22.340	35.880	1.5	1.5	2.0	4.750	6.260	0.000	0.170
ELECTRICIAN	N	ALL		38.910	42.800	1.5	1.5	2.0	9.140	8.940	0.000	0.480
ELECTRICIAN	S	BLD		38.570	42.430	1.5	1.5	2.0	8.490	9.650	0.000	0.770
ELEVATOR CONSTRUCTOR		BLD		42.045	47.300	2.0	2.0	2.0	8.275	6.060	2.520	0.550
FENCE ERECTOR		ALL		34.100	35.810	2.0	2.0	2.0	7.690	13.11	0.000	0.230
GLAZIER		BLD		31.400	32.400	1.5	2.0	2.0	6.490	9.050	0.000	0.500
HT/FROST INSULATOR		BLD		33.300	35.050	1.5	1.5	2.0	7.860	8.610	0.000	0.310
IRON WORKER		ALL		34.100	35.810	2.0	2.0	2.0	7.690	13.11	0.000	0.230
LABORER		ALL		31.550	32.300	1.5	1.5	2.0	7.200	5.100	0.000	0.170
LATHER		BLD		35.320	37.320	1.5	1.5	2.0	6.760	5.320	0.000	0.490
MACHINIST		BLD		36.890	38.890	2.0	2.0	2.0	4.380	5.650	2.550	0.000
MARBLE FINISHERS		ALL		25.750	0.000	1.5	1.5	2.0	6.070	7.020	0.000	0.580
MARBLE MASON		BLD		34.850	38.340	1.5	1.5	2.0	7.050	7.870	0.000	0.490
MATERIAL TESTER 1		ALL		21.550	0.000	1.5	1.5	2.0	7.460	4.840	0.000	0.170
MATERIALS TESTER II		ALL		26.550	0.000	1.5	1.5	2.0	7.460	4.840	0.000	0.170
MILLWRIGHT		ALL		35.320	37.320	1.5	1.5	2.0	6.760	5.320	0.000	0.490
OPERATING ENGINEER		BLD	1	41.550	45.550	2.0	2.0	2.0	6.850	5.600	1.900	0.700
OPERATING ENGINEER		BLD	2	40.250	45.550	2.0	2.0	2.0	6.850	5.600	1.900	0.700
OPERATING ENGINEER		BLD	3	37.700	45.550	2.0	2.0	2.0	6.850	5.600	1.900	0.700
OPERATING ENGINEER		BLD	4	35.950	45.550	2.0	2.0	2.0	6.850	5.600	1.900	0.700
OPERATING ENGINEER		HWY	1	39.750	43.750	1.5	1.5	2.0	6.850	5.600	1.900	0.700
OPERATING ENGINEER		HWY	2	39.200	43.750	1.5	1.5	2.0	6.850	5.600	1.900	0.700
OPERATING ENGINEER		HWY	3	37.150	43.750	1.5	1.5	2.0	6.850	5.600	1.900	0.700
OPERATING ENGINEER		HWY	4	35.750	43.750	1.5	1.5	2.0	6.850	5.600	1.900	0.700
OPERATING ENGINEER		HWY	5	34.550	43.750	1.5	1.5	2.0	6.850	5.600	1.900	0.700
ORNAMNTL IRON WORKER		ALL		34.100	35.810	2.0	2.0	2.0	7.690	13.11	0.000	0.230
PAINTER		ALL		34.380	35.380	1.5	1.5	1.5	5.650	5.750	0.000	0.350
PAINTER SIGNS		BLD		28.970	32.520	1.5	1.5	1.5	2.600	2.310	0.000	0.000
PILEDRIVER		ALL		35.320	37.320	1.5	1.5	2.0	6.760	5.320	0.000	0.490
PIPEFITTER		BLD		36.010	38.010	1.5	1.5	2.0	8.450	8.690	0.000	0.950
PLASTERER		BLD		33.850	35.350	1.5	1.5	2.0	6.740	7.100	0.000	0.400
PLUMBER		BLD		36.010	38.010	1.5	1.5	2.0	8.450	8.690	0.000	0.950
ROOFER		BLD		33.650	35.650	1.5	1.5	2.0	6.460	3.310	0.000	0.330
SHEETMETAL WORKER		BLD		36.510	38.510	1.5	1.5	2.0	6.890	8.020	0.000	0.640
SIGN HANGER		BLD		26.070	27.570	1.5	1.5	2.0	3.800	3.550	0.000	0.000
SPRINKLER FITTER		BLD		38.500	40.500	1.5	1.5	2.0	8.250	6.100	0.000	0.500
STEEL ERECTOR		ALL		34.100	35.810	2.0	2.0	2.0	7.690	13.11	0.000	0.230
STONE MASON		BLD		33.250	36.580	1.5	1.5	2.0	6.450	7.020	0.000	0.440
TERRAZZO FINISHER		BLD		29.290	0.000	1.5	1.5	2.0	5.650	6.940	0.000	0.270
TERRAZZO MASON		BLD		33.650	36.650	1.5	1.5	2.0	5.650	8.610	0.000	0.300
TILE MASON		BLD		34.600	38.600	2.0	1.5	2.0	5.650	7.000	0.000	0.460
TRAFFIC SAFETY WRKR		HWY		22.800	24.400	1.5	1.5	2.0	3.078	1.875	0.000	0.000
TRUCK DRIVER		ALL	1	29.700	30.250	1.5	1.5	2.0	6.500	3.450	0.000	0.000
TRUCK DRIVER		ALL	2	29.850	30.250	1.5	1.5	2.0	6.500	3.450	0.000	0.000
TRUCK DRIVER		ALL	3	30.050	30.250	1.5	1.5	2.0	6.500	3.450	0.000	0.000
TRUCK DRIVER		ALL	4	30.250	30.250	1.5	1.5	2.0	6.500	3.450	0.000	0.000



mosaics, fiberglass, and all substitute materials, for tile made in tile-like units; all mixtures in tile like form of cement, metals, and other materials that are for and intended for use as a finished floor surface, stair treads, promenade roofs, walks, walls, ceilings, swimming pools, and all other places where tile is to form a finished interior or exterior. The mixing of all setting mortars including but not limited to thin-set mortars, epoxies, wall mud, and any other sand and cement mixtures or adhesives when used in the preparation, installation, repair, or maintenance of tile and/or similar materials. The handling and unloading of all sand, cement, lime, tile, fixtures, equipment, adhesives, or any other materials to be used in the preparation, installation, repair, or maintenance of tile and/or similar materials. Ceramic Tile Finishers shall fill all joints and voids regardless of method on all tile work, particularly and especially after installation of said tile work. Application of any and all protective coverings to all types of tile installations including, but not be limited to, all soap compounds, paper products, tapes, and all polyethylene coverings, plywood, masonite, cardboard, and any new type of products that may be used to protect tile installations, Blastrac equipment, and all floor scarifying equipment used in preparing floors to receive tile. The clean up and removal of all waste and materials. All demolition of existing tile floors and walls to be re-tiled.

#### COMMUNICATIONS TECHNICIAN

Construction, installation, maintenance and removal of telecommunication facilities (voice, sound, data and video), telephone, security systems, fire alarm systems that are a component of a multiplex system and share a common cable, and data inside wire, interconnect, terminal equipment, central offices, PABX and equipment, micro waves, V-SAT, bypass, CATV, WAN (wide area network), LAN (local area networks), and ISDN (integrated system digital network), pulling of wire in raceways, but not the installation of raceways.

#### MARBLE FINISHER

Loading and unloading trucks, distribution of all materials (all stone, sand, etc.), stocking of floors with material, performing all rigging for heavy work, the handling of all material that may be needed for the installation of such materials, building of scaffolding, polishing if needed, patching, waxing of material if damaged, pointing up, caulking, grouting and cleaning of marble, holding water on diamond or Carborundum blade or saw for setters cutting, use of tub saw or any other saw needed for preparation of material, drilling of holes for wires that anchor material set by setters, mixing up of molding plaster for installation of material, mixing up thin set for the installation of material, mixing up of sand to cement for the installatin of material and such other work as may be required in helping a Marble Setter in the handling of all material in the erection or installation of interior marble, slate, travertine, art marble, serpentine, alberene stone, blue stone, granite and other stones (meaning as to stone any foreign or domestic materials as are specified and used in building interiors and experiors and customarily known as stone in the trade), carrara, sanionyx, vitrolite and similar opaque glass and the laying of all marble tile, terrazzo tile, slate tile and precast tile, steps, risers treads, base, or any other materials that may be used as substitutes for any of the aforementioned materials and which are used on interior and experior which sare installed in a similar manner.

MATERIAL TESTER I: Hand coring and drilling for testing of materials;

field inspection of uncured concrete and asphalt.

MATERIAL TESTER II: Field inspection of welds, structural steel, fireproofing, masonry, soil, facade, reinforcing steel, formwork, cured concrete, and concrete and asphalt batch plants; adjusting proportions of bituminous mixtures.

TRAFFIC SAFETY - work associated with barricades, horses and drums used to reduce lane usage on highway work, the installation and removal of temporary lane markings, and the installation and removal of temporary road signs.

#### TRUCK DRIVER - BUILDING, HEAVY AND HIGHWAY CONSTRUCTION

Class 1. Two or three Axle Trucks. A-frame Truck when used for transportation purposes; Air Compressors and Welding Machines, including those pulled by cars, pick-up trucks and tractors; Ambulances; Batch Gate Lockers; Batch Hopperman; Car and Truck Washers; Carry-alls; Fork Lifts and Hoisters; Helpers; Mechanics Helpers and Greasers; Oil Distributors 2-man operation; Pavement Breakers; Pole Trailer, up to 40 feet; Power Mower Tractors; Self-propelled Chip Spreader; Skipman; Slurry Trucks, 2-man operation; Slurry Truck Conveyor Operation, 2 or 3 man; Teamsters; Unskilled dumpman; and Truck Drivers hauling warning lights, barricades, and portable toilets on the job site.

Class 2. Four axle trucks; Dump Crets and Adgetors under 7 yards; Dumpsters, Track Trucks, Euclids, Hug Bottom Dump Turnapulls or Turnatrailers when pulling other than self-loading equipment or similar equipment under 16 cubic yards; Mixer Trucks under 7 yards; Ready-mix Plant Hopper Operator, and Winch Trucks, 2 Axles.

Class 3. Five axle trucks; Dump Crets and Adgetors 7 yards and over; Dumpsters, Track Trucks, Euclids, Hug Bottom Dump Turnatrailers or turnapulls when pulling other than self-loading equipment or similar equipment over 16 cubic yards; Explosives and/or Fission Material Trucks; Mixer Trucks 7 yards or over; Mobile Cranes while in transit; Oil Distributors, 1-man operation; Pole Trailer, over 40 feet; Pole and Expandable Trailers hauling material over 50 feet long; Slurry trucks, 1-man operation; Winch trucks, 3 axles or more; Mechanic--Truck Welder and Truck Painter.

Class 4. Six axle trucks; Dual-purpose vehicles, such as mounted crane trucks with hoist and accessories; Foreman; Master Mechanic; Self-loading equipment like P.B. and trucks with scoops on the front.

#### OPERATING ENGINEERS - BUILDING

Class 1. Mechanic; Asphalt Plant; Asphalt Spreader; Autograde; Backhoes with Caisson attachment; Batch Plant; Benoto; Boiler and Throttle Valve; Caisson Rigs; Central Redi-Mix Plant; Combination Back Hoe Front End-loader Machine; Compressor and Throttle Valve; Concrete Breaker (Truck Mounted); Concrete Conveyor; Concrete Paver; Concrete Placer; Concrete Placing Boom; Concrete Pump (Truck Mounted); Concrete Tower; Cranes, All; Cranes, Hammerhead; Cranes, (GCI and similar Type); Creter Crane; Crusher, Stone, etc.; Derricks, All; Derricks, Traveling; Formless Curb and Gutter Machine; Grader, Elevating; Grouting Machines; Highlift Shovels or Front Endloader 2-1/4 yd. and over; Hoists, Elevators, outside type rack and pinion and similar machines; Hoists, one, two and three Drum; Hoists, Two Tugger One Floor; Hydraulic Backhoes; Hydraulic Boom Trucks; Hydro Vac (and similar equipment); Locomotives, All; Motor Patrol; Pile Drivers and Skid Rig; Post Hole Digger; Pre-Stress Machine; Pump Cretes Dual Ram; Pump Cretes; Squeeze Cretes-screw Type Pumps; Raised and Blind

Hole Drill; Roto Mill Grinder; Scoops - Tractor Drawn; Slip-form Paver; Straddle Buggies; Tournapull; Tractor with Boom and Side Boom; Trenching Machines.

Class 2. Boilers; Broom, All Power Propelled; Bulldozers; Concrete Mixer (Two Bag and Over); Conveyor, Portable; Forklift Trucks; Greaser Engineer; Highlift Shovels or Front Endloaders under 2-1/4 yd.; Hoists, Automatic; Hoists, inside Freight Elevators; Hoists, Sewer Dragging Machine; Hoists, Tugger Single Drum; Laser Screed; Rock Drill (self-propelled); Rock Drill (truck mounted); Rollers, All; Steam Generators; Tractors, All; Tractor Drawn Vibratory Roller; Winch Trucks with "A" Frame.

Class 3. Air Compressor; Combination - Small Equipment Operator; Generators; Heaters, Mechanical; Hoists, Inside Elevators - (Rheostat Manual Controlled); Hydraulic Power Units (Pile Driving, Extracting, and Drilling); Pumps, over 3" (1 to 3 not to exceed a total of 300 ft.); Pumps, Well Points; Welding Machines (2 through 5); Winches, 4 small Electric Drill Winches; Bobcat (up to and including 3/4 cu. yd.).

Class 4. Bobcats and/or other Skid Steer Loaders; Oilers; and Brick Forklift.

#### OPERATING ENGINEERS - HEAVY AND HIGHWAY CONSTRUCTION

Class 1. Craft Foreman; Asphalt Plant; Asphalt Heater and Planer Combination; Asphalt Heater Scarfire; Asphalt Spreader; Autograder/GOMACO or other similar type machines; ABG Paver; Backhoes with Caisson attachment; Ballast Regulator; Belt Loader; Caisson Rigs; Car Dumper; Central Redi-Mix Plant; Combination Backhoe Front Endloader Machine, (1 cu. yd. Backhoe Bucket or over or with attachments); Concrete Breaker (Truck Mounted); Concrete Conveyor; Concrete Paver over 27E cu. ft.; Concrete Placer; Concrete Tube Float; Cranes, all attachments; Cranes, Hammerhead, Linden, Peco & Machines of a like nature; Crete Crane; Crusher, Stone, etc.; Derricks, All; Derrick Boats; Derricks, Traveling; Dowell machine with Air Compressor; Dredges; Field Mechanic-Welder; Formless Curb and Gutter Machine; Gradall and Machines of a like nature; Grader, Elevating; Grader, Motor Grader, Motor Patrol, Auto Patrol, Form Grader, Pull Grader, Subgrader; Guard Rail Post Driver Mounted; Hoists, One, Two and Three Drum; Hydraulic Backhoes; Backhoes with shear attachments; Mucking Machine; Pile Drivers and Skid Rig; Pre-Stress Machine; Pump Cretes Dual Ram; Rock Drill - Crawler or Skid Rig; Rock Drill - Truck Mounted; Roto Mill Grinder; Slip-Form Paver; Soil Test Drill Rig (Truck Mounted); Straddle Buggies; Hydraulic Telescoping Form (Tunnel); Tractor Drawn Belt Loader (with attached pusher - two engineers); Tractor with Boom; Tractaire with Attachments; Trenching Machine; Truck Mounted Concrete Pump with Boom; Raised or Blind Hole; Drills (Tunnel Shaft); Underground Boring and/or Mining Machines; Wheel Excavator; Widener (APSCO).

Class 2. Batch Plant; Bituminous Mixer; Boiler and Throttle Valve; Bulldozers; Car Loader Trailing Conveyors; Combination Backhoe Front Endloader Machine (less than 1 cu. yd. Backhoe Bucket or over or with attachments); Compressor and Throttle Valve; Compressor, Common Receiver (3); Concrete Breaker or Hydro Hammer; Concrete Grinding Machine; Concrete Mixer or Paver 7S Series to and including 27 cu. ft.; Concrete Spreader; Concrete Curing Machine, Burlap Machine, Belting Machine and Sealing Machine; Concrete Wheel Saw; Conveyor Muck Cars (Haglund or Similar Type); Drills, All; Finishing Machine - Concrete; Greaser Engineer; Highlift Shovels or Front Endloader; Hoist - Sewer Dragging Machine; Hydraulic Boom Trucks (All



Attachments); Hydro-Blaster; All Locomotives, Dinky; Pump Cretes; Squeeze Cretes-Screw Type Pumps, Gypsum Bulker and Pump; Roller, Asphalt; Rotary Snow Plows; Rototiller, Seaman, etc., self-propelled; Scoops - Tractor Drawn; Self-Propelled Compactor; Spreader - Chip - Stone, etc.; Scraper; Scraper - Prime Mover in Tandem (Regardless of Size); Tank Car Heater; Tractors, Push, Pulling Sheeps Foot, Disc, Compactor, etc.; Tug Boats.

Class 3. Boilers; Brooms, All Power Propelled; Cement Supply Tender; Compressor, Common Receiver (2); Concrete Mixer (Two Bag and Over); Conveyor, Portable; Farm-Type Tractors Used for Mowing, Seeding, etc.; Fireman on Boilers; Forklift Trucks; Grouting Machine; Hoists, Automatic; Hoists, All Elevators; Hoists, Tugger Single Drum; Jeep Diggers; Pipe Jacking Machines; Post-Hole Digger; Power Saw, Concrete Power Driven; Pug Mills; Rollers, other than asphalt; Seed and Straw Blower; Steam Generators; Stump Machine; Winch Trucks with "A" Frame; Work Boats; Tamper - Form-Motor Driven.

Class 4. Air Compressor; Combination - Small Equipment Operator; Directional Boring Machine; Generators; Heaters, Mechanical; Hydraulic Power Unit (Pile Driving, Extracting, or Drilling); Hydro-Blaster; Light Plants, All (1 through 5); Pumps, over 3" (1 to 3 not to exceed a total of 300 ft.); Pumps, Well Points; Tractaire; Welding Machines (2 through 5); Winches, 4 Small Electric Drill Winches.

Class 5. Bobcats (all); Brick Forklifts; Oilers.

#### TERRAZZO FINISHER

The handling of sand, cement, marble chips, and all other materials that may be used by the Mosaic Terrazzo Mechanic, and the mixing, grinding, grouting, cleaning and sealing of all Marble, Mosaic, and Terrazzo work, floors, base, stairs, and wainscoting by hand or machine, and in addition, assisting and aiding Marble, Masonic, and Terrazzo Mechanics.

#### Other Classifications of Work:

For definitions of classifications not otherwise set out, the Department generally has on file such definitions which are available. If a task to be performed is not subject to one of the classifications of pay set out, the Department will upon being contacted state which neighboring county has such a classification and provide such rate, such rate being deemed to exist by reference in this document. If no neighboring county rate applies to the task, the Department shall undertake a special determination, such special determination being then deemed to have existed under this determination. If a project requires these, or any classification not listed, please contact IDOL at 618/993-7271 for wage rates or clarifications.

#### LANDSCAPING

Landscaping work falls under the existing classifications for laborer, operating engineer and truck driver. The work performed by landscape plantsman and landscape laborer is covered by the existing classification of laborer. The work performed by landscape operators (regardless of equipment used or its size) is covered by the classifications of operating engineer. The work performed by landscape truck drivers (regardless of size of truck driven) is covered by the classifications of truck driver.

# Kankakee County Prevailing Wage for April 2007

Trade Name	RG	TYP	C	Base	FRMAN	*M-F>8	OSA	OSH	H/W	Pensn	Vac	Trng
=====	==	==	=	=====	=====	=====	==	==	=====	=====	=====	=====
ASBESTOS ABT-GEN		BLD		25.180	26.180	1.5	1.5	2.0	5.850	6.670	0.000	0.750
ASBESTOS ABT-GEN		HWY		25.790	26.790	1.5	1.5	2.0	5.850	6.670	0.000	0.750
ASBESTOS ABT-MEC		BLD		23.300	24.800	1.5	1.5	2.0	7.860	4.910	0.000	0.000
BOILERMAKER		BLD		38.540	42.000	2.0	2.0	2.0	6.720	7.440	0.000	0.300
BRICK MASON		BLD		31.850	33.850	1.5	1.5	2.0	5.500	8.000	0.000	0.430
CARPENTER		BLD		30.900	32.400	1.5	1.5	2.0	5.860	7.950	0.000	0.490
CARPENTER		HWY		29.580	31.330	1.5	1.5	2.0	4.950	7.200	0.000	0.490
CEMENT MASON		BLD		31.850	33.850	1.5	1.5	2.0	5.500	8.000	0.000	0.430
CERAMIC TILE FNSHER		BLD		28.670	0.000	1.5	1.5	2.0	5.500	8.000	0.000	0.430
COMMUNICATION TECH		BLD		29.110	30.610	1.5	1.5	2.0	8.270	8.670	0.000	0.290
ELECTRIC PWR EQMT OP		ALL		36.050	42.000	1.5	1.5	2.0	7.870	9.730	0.000	0.270
ELECTRIC PWR GRNDMAN		ALL		28.120	42.000	1.5	1.5	2.0	6.140	7.600	0.000	0.210
ELECTRIC PWR LINEMAN		ALL		36.050	42.000	1.5	1.5	2.0	7.870	9.730	0.000	0.270
ELECTRICIAN		BLD		35.100	38.260	1.5	1.5	2.0	8.570	11.04	0.000	0.350
ELEVATOR CONSTRUCTOR		BLD		34.190	38.460	2.0	2.0	2.0	8.275	6.060	2.050	0.000
GLAZIER		BLD		31.400	32.400	1.5	2.0	2.0	6.490	9.050	0.000	0.500
HT/FROST INSULATOR		BLD		33.300	35.050	1.5	1.5	2.0	7.860	8.610	0.000	0.310
IRON WORKER		ALL		30.000	33.000	2.0	2.0	2.0	7.690	10.46	0.000	0.550
LABORER		BLD		23.280	24.280	1.5	1.5	2.0	5.700	5.500	0.000	0.600
LABORER		HWY		24.790	25.790	1.5	1.5	2.0	5.850	6.670	0.000	0.600
LABORER, SKILLED		BLD		24.480	25.480	1.5	1.5	2.0	5.850	6.670	0.000	0.600
LABORER, SKILLED		HWY		24.790	25.790	1.5	1.5	2.0	5.850	6.670	0.000	0.600
LATHER		BLD		30.900	32.400	1.5	1.5	2.0	5.860	7.950	0.000	0.490
MACHINIST		BLD		36.890	38.890	2.0	2.0	2.0	4.380	5.650	2.550	0.000
MARBLE FINISHERS		BLD		28.670	0.000	1.5	1.5	2.0	5.500	8.000	0.000	0.430
MARBLE MASON		BLD		31.850	33.850	1.5	1.5	2.0	5.500	8.000	0.000	0.430
MATERIAL TESTER 1		ALL		21.550	0.000	1.5	1.5	2.0	7.460	4.840	0.000	0.170
MATERIALS TESTER II		ALL		26.550	0.000	1.5	1.5	2.0	7.460	4.840	0.000	0.170
MILLWRIGHT		BLD		30.900	32.400	1.5	1.5	2.0	5.860	7.950	0.000	0.490
OPERATING ENGINEER		BLD	1	41.550	45.550	2.0	2.0	2.0	6.850	5.600	1.900	0.700
OPERATING ENGINEER		BLD	2	40.250	45.550	2.0	2.0	2.0	6.850	5.600	1.900	0.700
OPERATING ENGINEER		BLD	3	37.700	45.550	2.0	2.0	2.0	6.850	5.600	1.900	0.700
OPERATING ENGINEER		BLD	4	35.950	45.550	2.0	2.0	2.0	6.850	5.600	1.900	0.700
OPERATING ENGINEER		HWY	1	39.750	43.750	1.5	1.5	2.0	6.850	5.600	1.900	0.700
OPERATING ENGINEER		HWY	2	39.200	43.750	1.5	1.5	2.0	6.850	5.600	1.900	0.700
OPERATING ENGINEER		HWY	3	37.150	43.750	1.5	1.5	2.0	6.850	5.600	1.900	0.700
OPERATING ENGINEER		HWY	4	35.750	43.750	1.5	1.5	2.0	6.850	5.600	1.900	0.700
OPERATING ENGINEER		HWY	5	34.550	43.750	1.5	1.5	2.0	6.850	5.600	1.900	0.700
PAINTER		ALL		26.850	27.850	1.5	1.5	1.5	5.650	5.750	0.000	0.350
PAINTER SIGNS		BLD		28.970	32.520	1.5	1.5	1.5	2.600	2.310	0.000	0.000
PILEDRIVER		BLD		30.900	32.400	1.5	1.5	2.0	5.860	7.950	0.000	0.490
PIPEFITTER		BLD		36.060	38.060	1.5	1.5	2.0	7.050	8.500	0.000	0.760
PLASTERER		BLD		31.850	33.850	1.5	1.5	2.0	5.500	8.000	0.000	0.430
PLUMBER		BLD		36.060	38.060	1.5	1.5	2.0	7.050	8.500	0.000	0.760
ROOFER		BLD		33.650	35.650	1.5	1.5	2.0	6.460	3.310	0.000	0.330
SHEETMETAL WORKER		BLD		36.510	38.510	1.5	1.5	2.0	6.890	8.020	0.000	0.640
SIGN HANGER		BLD		30.900	32.400	1.5	1.5	2.0	5.860	7.950	0.000	0.490
SPRINKLER FITTER		BLD		31.240	33.240	1.5	1.5	2.0	6.500	5.350	0.000	0.250
TERRAZZO FINISHER		BLD		28.670	0.000	1.5	1.5	2.0	5.500	8.000	0.000	0.430
TERRAZZO MASON		BLD		31.850	33.850	1.5	1.5	2.0	5.500	8.000	0.000	0.430
TILE MASON		BLD		31.850	33.850	1.5	1.5	2.0	5.500	8.000	0.000	0.430
TRUCK DRIVER		ALL	1	28.870	29.420	1.5	1.5	2.0	6.690	4.150	0.000	0.000
TRUCK DRIVER		ALL	2	29.070	29.420	1.5	1.5	2.0	6.690	4.150	0.000	0.000
TRUCK DRIVER		ALL	3	29.270	29.420	1.5	1.5	2.0	6.690	4.150	0.000	0.000
TRUCK DRIVER		ALL	4	29.420	29.420	1.5	1.5	2.0	6.690	4.150	0.000	0.000
TUCKPOINTER		BLD		31.850	33.850	1.5	1.5	2.0	5.500	8.000	0.000	0.430

Legend:

M-F>8 (Overtime is required for any hour greater than 8 worked each day, Monday through Friday.)

OSA (Overtime is required for every hour worked on Saturday)

OSH (Overtime is required for every hour worked on Sunday and Holidays)

H/W (Health & Welfare Insurance)

Pensn (Pension)

Vac (Vacation)

Trng (Training)

## Explanations

### KANKAKEE COUNTY

The following list is considered as those days for which holiday rates of wages for work performed apply: New Years Day, Memorial/Decoration Day, Fourth of July, Labor Day, Veterans Day, Thanksgiving Day, Christmas Day. Generally, any of these holidays which fall on a Sunday is celebrated on the following Monday. This then makes work performed on that Monday payable at the appropriate overtime rate for holiday pay. Common practice in a given local may alter certain days of celebration such as the day after Thanksgiving for Veterans Day. If in doubt, please check with IDOL.

### EXPLANATION OF CLASSES

ASBESTOS - GENERAL - removal of asbestos material/mold and hazardous materials from any place in a building, including mechanical systems where those mechanical systems are to be removed. This includes the removal of asbestos materials/mold and hazardous materials from ductwork or pipes in a building when the building is to be demolished at the time or at some close future date.

ASBESTOS - MECHANICAL - removal of asbestos material from mechanical systems, such as pipes, ducts, and boilers, where the mechanical systems are to remain.

### CERAMIC TILE FINISHER, MARBLE FINISHER, AND TERRAZZO FINISHER

The laying, setting and finishing of all tile where used for floors, walls, ceilings, walks, promenade roofs, stair treads, stair risers, facings, hearths, fireplaces, and decorative inserts, together with any marble plinths, thresholds or window stools used in connection with any tile work; also to prepare and set all concrete, cement, brickwork, or other foundation or materials that may be required to properly set and complete such work; the setting or bedding of all tiling, stone, marble, composition, glass, mosaic, or other materials forming the facing, hearth or fireplace of a mantle, or the mantle complete, together with the setting of all cement, brickwork, or other material required in connection with the above work; also the slabbing and fabrication of tile mantels, counters and tile panels of every description and the erection and installation of same and the building, shaping, forming, construction, or repairing of all

fireplace work, whether in connection with the mantle hearth facing or not, and the setting and preparing of all material, such as cement, plaster, mortar, brickwork, iron work or other materials necessary for the proper and safe construction and completion of such work. The term "Ceramic" is used for naming the classification only and is in no way a limitation of the product handled. Ceramic takes into consideration most hard tiles.

#### COMMUNICATIONS TECHNICIAN

Installing, manufacturing, assembling and maintaining sound and intercom, protection alarm (security), fire alarm, master antenna television, closed circuit television, low voltage control for computers and/or door monitoring, school communications systems, telephones and servicing of nurse and emergency calls, and the installation and maintenance of transmit and receive antennas, transmitters, receivers, and associated apparatus which operates in conjunction with above systems. All work associated with these system installations will be included EXCEPT the installation of protective metallic conduit in new construction projects (excluding less than ten-foot, runs strictly for protection of cable) and 120 volt AC (or higher) power wiring and associated hardware.

#### LABORER, SKILLED - BUILDING

The skilled laborer building (BLD) classification shall encompass the following types of work, irrespective of the site of the work: caisson workers plus depth, gunnite nozzle men, lead man on sewer work, welders, cutters, burners and torchmen, chain saw operators, paving breaker, jackhammer and drill operators, layout man and/or drainage tile layer, steel form setters - street and highway, air tamping hammerman, signal man on crane, concrete saw operator, screenman on asphalt pavers, front end man on chip spreader, laborers tending masons with hot materials or where foreign materials are used, multiple concrete duct-leadman, luteman, asphalt raker, curb asphalt machine operator, ready mix scalemen (permanent, portable or temporary plant), laborers handling masterplate or similar materials, laser beam operator, concrete burning machine operator, coring machine operator, plaster tenders, underpinning and shoring of buildings, material selector when working with fire-brick or castable material, fire watch, signaling of all power equipment, and tree topper or trimmer when in connection with construction.

#### LABORER, SKILLED - HIGHWAY

The skilled laborer heavy and highway (HWY) classification shall encompass the following types of work, irrespective of the site of the work: handling of materials treated with oil, creosote, asphalt and/or any foreign materials harmful to skin or clothing, track laborers, chloride handlers, the unloading and loading with steel workers and re-bars, concrete workers (wet), tunnel helpers in free air, batch dumpers, mason tenders, kettle and tar men, plastic installers, scaffold workers, motorized buggies or motorized unit used for wet concrete or handling of building materials, laborers with de-watering systems, sewer workers plus depth, rod and chainmen, vibrator operators, mortar mixer operators, cement silica, clay, fly ash, lime and plasters, handlers (bulk or bag), cofferdam workers plus depth, on concrete paving, placing, cutting and tying or reinforcing, deck hand, dredge hand shore laborers, bankmen on floating plant, asphalt workers with machine, and layers, grade checker, power tools, stripping of all concrete forms excluding paving forms, dumpmen and spotters, when necessary, caisson workers plus depth, gunnite nozzle men, welders, cutters, burners and torchmen, chain saw operators,

paving breaker, jackhammer and drill operators, layout man and/or drainage tile layer, steel form setters - street and highway, air tamping hammerman, signal man on crane, concrete saw operator, screedman on asphalt pavers, front end man on chip spreader, multiple concrete duct, luteman, asphalt raker, curb asphalt machine operator, ready mix scalemen (portable or temporary plant), laser beam operator, concrete burning machine operator, and coring machine operator.

MATERIAL TESTER I: Hand coring and drilling for testing of materials; field inspection of uncured concrete and asphalt.

MATERIAL TESTER II: Field inspection of welds, structural steel, fireproofing, masonry, soil, facade, reinforcing steel, formwork, cured concrete, and concrete and asphalt batch plants; adjusting proportions of bituminous mixtures.

#### TRUCK DRIVER - BUILDING, HEAVY AND HIGHWAY CONSTRUCTION

Class 1. Two or three Axle Trucks. A-frame Truck when used for transportation purposes; Air Compressors and Welding Machines, including those pulled by cars, pick-up trucks and tractors; Ambulances; Batch Gate Lockers; Batch Hopperman; Car and Truck Washers; Carry-alls; Fork Lifts and Hoisters; Helpers; Mechanics Helpers and Greasers; Oil Distributors 2-man operation; Pavement Breakers; Pole Trailer, up to 40 feet; Power Mower Tractors; Self-propelled Chip Spreader; Skipman; Slurry Trucks, 2-man operation; Slurry Truck Conveyor Operation, 2 or 3 man; Teamsters; Unskilled dumpman; and Truck Drivers hauling warning lights, barricades, and portable toilets on the job site.

Class 2. Four axle trucks; Dump Crets and Adgetors under 7 yards; Dumpsters, Track Trucks, Euclids, Hug Bottom Dump Turnapulls or Turnatrailers when pulling other than self-loading equipment or similar equipment under 16 cubic yards; Mixer Trucks under 7 yards; Ready-mix Plant Hopper Operator, and Winch Trucks, 2 Axles.

Class 3. Five axle trucks; Dump Crets and Adgetors 7 yards and over; Dumpsters, Track Trucks, Euclids, Hug Bottom Dump Turnatrailers or turnapulls when pulling other than self-loading equipment or similar equipment over 16 cubic yards; Explosives and/or Fission Material Trucks; Mixer Trucks 7 yards or over; Mobile Cranes while in transit; Oil Distributors, 1-man operation; Pole Trailer, over 40 feet; Pole and Expandable Trailers hauling material over 50 feet long; Slurry trucks, 1-man operation; Winch trucks, 3 axles or more; Mechanic--Truck Welder and Truck Painter.

Class 4. Six axle trucks; Dual-purpose vehicles, such as mounted crane trucks with hoist and accessories; Foreman; Master Mechanic; Self-loading equipment like P.B. and trucks with scoops on the front.

#### OPERATING ENGINEERS - BUILDING

Class 1. Assistant Craft Foreman; Craft Foreman; Mechanic; Asphalt Plant; Asphalt Spreader; Autograde; Batch Plant; Benoto (requires Two Engineers); Boiler and Throttle Valve; Caisson Rigs; Central Redi-Mix Plant; Combination Back Hoe Front End-loader Machine; Compressor and Throttle Valve; Concrete Breaker (Truck Mounted); Concrete Conveyor; Concrete Paver; Concrete Placer; Concrete Pump (Truck Mounted); Concrete Tower, Cranes, All, Cranes, Hammerhead, Creter Crane; Crusher, Stone, etc.; Derricks, All; Derricks, Traveling; Formless Curb and Gutter Machine; Grader, Elevating; Grouting Machines; Highlift Shovels or Front Endloader 2-1/4 yd. and over; Hoists, Elevators, outside type rack and pinion and similar machines; Hoists, one, two and three Drum; Hoists, Two tugging One Floor; Hydraulic

Backhoes; Hydraulic Boom Trucks; Locomotives, All; Motor Patrol; Pile Drivers and Skid Rig; Post Hole Digger; Pre-Stress Machine; Pump Cretes; Squeeze Cretes-screw Type Pumps; Gypsum Bulker and Pump; Raised and Blind Hole Drill; Rock Drill; Roto Mill Grinder; Scoops - Tractor Drawn; Slip-form Paver; Straddle Buggies; Tie Back Machine; Tractor with Book and Side Boom; Trenching Machines.

Class 2. Boilers; Broom, All Power Propelled; Bulldozers; Concrete Mixer (Two Bag and Over); Conveyor, Portable; Forklift Trucks; Greaser Engineer; Highlift Shovels or Front Endloaders under 2-1/4 yd.; Hoists, Automatic; Hoists, Sewer Dragging Machine; Hoists, Tugger Single Drum; Rollers, All; Steam Generators; Tractors, All; Tractor Drawn Vibratory Roller; Winch Trucks with "A" Frame.

Class 3. Air Compressor; Asphalt Spreader; Combination - Small Equipment Operator; Generators; Heaters, Mechanical; Hoists, Inside Elevators - (Rheostat Manual Controlled); Hydraulic Power Units (Pile Driving and Extracting); Pumps, over 3" (1 to 3 not to exceed a total of 300 ft.); Pumps, Well Points; Welding Machines (2 through 5); Winches, 4 small Electric Drill Winches; Bobcat (up to and including 3/4 cu. yd.).

Class 4. Hoists, Inside Elevators, Push Button with Automatic Doors; Oilers; Brick Forklift.

#### OPERATING ENGINEERS - HEAVY AND HIGHWAY CONSTRUCTION

Class 1. Craft Foreman; Asphalt Plant, Asphalt Heater and Planer Combination; Asphalt Heater Scarfire; Asphalt Silo Tender; Asphalt Spreader; Autograder; ABG Paver; Backhoes with Caisson attachment; Ballast Regulator, Belt Loader; Caisson Rigs; Car Dumper; Central Redi-Mix Plant; Backhoe w/shear attachments; Combination Backhoe Front Endloader Machine, (1 cu. yd. Backhoe Bucket or over or with attachments); Concrete Breaker (Truck Mounted); Concrete Conveyor; Concrete Paver over 27E cu. ft.; Concrete Placer; Concrete Tube Float; Cranes, all attachments; Cranes, Hammerhead, Linden, Peco & Machines of a like nature; Crete Crane; Crusher, Stone, etc.; Derricks, All; Derrick Boats; Derricks, Traveling; Directional Boring Machine over 12"; Dredges; Field Mechanic-Welder; Formless Curb and Gutter Machine; Gradall and Machines of a like nature; Grader, Elevating; Grader, Motor Grader, Motor Patrol, Auto Patrol, Form Grader, Pull Grader, Subgrader; Guard Rail Post Driver Mounted; Hoists, One, Two and Three Drum; Hydraulic Backhoes; Pile Drivers and Skid Rig; Pre-Stress Machine; Pump Cretes Dual Ram; Rock Drill - Crawler or Skid Rig; Rock Drill - Truck Mounted; Rock/Track Tamper; Roto Mill Grinder; Slip-Form Paver; Soil Test Drill Rig (Truck Mounted); Straddle Buggies; GCI Crane; Hydraulic Telescoping form (Tunnel); Tie Back Machine; Tractor Drawn Belt Loader; Tractor with Boom; Tractor-aire with Attachments; Traffic Barrier conveyor machine; Raised or Blind Hole; Trenching Machine; Truck Mounted Concrete Pump with Boom; Truck Mounted Concrete Conveyor; Underground Boring and/or Mining Machines; Wheel Excavator; Widener (APSCO).

Class 2. Batch Plant; Bituminous Mixer; Boiler and Throttle Valve; Bulldozers; Car Loader Trailing Conveyors; Combination Backhoe Front Endloader Machine (less than 1 cu. yd. Backhoe Bucket or over or with attachments); Compressor and Throttle Valve; Compressor, Common Receiver (3); Concrete Breaker or Hydro Hammer; Concrete Grinding Machine; Concrete Mixer or Paver 7S Series to and including 27 cu. ft.; Concrete Spreader; Concrete Curing Machine, Burlap Machine, Belting Machine and Sealing Machine; Conveyor Muck Cars (Haglund or Similar Type); Drills, all; Finishing Machine - Concrete; Greaser Engineer; Highlift Shovels or Front Endloader; Hoist - Sewer Dragging Machine; Hydraulic Boom Trucks (All Attachments); Hydro Blaster;

Laser Screed; All Locomotives, Dinky; Pump Cretes; Squeeze Cretes-Screw Type Pumps, Gypsum Bulker and Pump; Roller, Asphalt; Rotary Snow Plows; Rototiller, Seaman, etc., self-propelled; Scoops - Tractor Drawn; Self-Propelled Compactor; Spreader - Chip - Stone, etc.; Scraper; Scraper - Prime Mover in Tandem (Regardless of Size); Tank Car Heater; Tractors, Push, Pulling Sheeps Foot, Disc, Compactor, etc. Tug Boats.

Class 3. Boilers; Brooms, All Power Propelled; Cement Supply Tender; Compressor, Common Receiver (2); Concrete Mixer (Two Bag and Over); Conveyor, Portable; Farm-Type Tractors Used for Mowing, Seeding, etc.; Fireman on Boilers; Forklift Trucks; Grouting Machine; Hoists, Automatic; Hoists, All Elevators; Hoists, Tugger Single Drum; Jeep Diggers, Low Boys; Pipe Jacking Machines; Post-Hole Digger; Power Saw, Concrete Power Driven; Pug Mills; Rollers, other than asphalt; Seed and Straw Blower; Steam Generators; Stump Machine; Winch Trucks with "A" Frame; Work Boats; Tamper - Form-Motor Driven.

Class 4. Air Compressor - Small and Large; Asphalt Spreader, Backend Man; Bobcat (Skid Steer) all; Combination - Small Equipment Operator; Directional Boring Machine up to 12"; Generators - Small 50kw and Under; Generators - Large over 50kw; Heaters, Mechanical; Hydraulic Power Unit (Pile Driving, Extracting, or Drilling); Hydro-Blaster; Light Plants, All (1 through 5); Pumps, over 3" (1 to 3 not to exceed a total of 300 ft.); Pumps, Well Points; Tract-aire; Welding Machines (2 through 5); Winches, 4 Small Electric Drill Winches.

Class 5. Oilers and Directional Boring Machine Locator.  
Other Classifications of Work:

For definitions of classifications not otherwise set out, the Department generally has on file such definitions which are available. If a task to be performed is not subject to one of the classifications of pay set out, the Department will upon being contacted state which neighboring county has such a classification and provide such rate, such rate being deemed to exist by reference in this document. If no neighboring county rate applies to the task, the Department shall undertake a special determination, such special determination being then deemed to have existed under this determination. If a project requires these, or any classification not listed, please contact IDOL at 618/993-7271 for wage rates or clarifications.

#### LANDSCAPING

Landscaping work falls under the existing classifications for laborer, operating engineer and truck driver. The work performed by landscape plantsman and landscape laborer is covered by the existing classification of laborer. The work performed by landscape operators (regardless of equipment used or its size) is covered by the classifications of operating engineer. The work performed by landscape truck drivers (regardless of size of truck driven) is covered by the classifications of truck driver.

# Kendall County Prevailing Wage for April 2007

Trade Name	RG	TYP	C	Base	FRMAN	*M-F>8	OSA	OSH	H/W	Pensn	Vac	Trng
=====	==	==	=	=====	=====	=====	==	==	=====	=====	=====	=====
ASBESTOS ABT-GEN		ALL		31.550	32.300	1.5	1.5	2.0	7.460	4.840	0.000	0.170
ASBESTOS ABT-MEC		BLD		23.300	24.800	1.5	1.5	2.0	7.860	4.910	0.000	0.000
BOILERMAKER		BLD		38.540	42.000	2.0	2.0	2.0	6.720	7.440	0.000	0.300
BRICK MASON		BLD		34.850	38.340	1.5	1.5	2.0	7.050	7.870	0.000	0.380
CARPENTER		ALL		35.320	37.320	1.5	1.5	2.0	6.760	5.320	0.000	0.490
CEMENT MASON		ALL		35.300	37.300	2.0	1.5	2.0	6.400	8.910	0.000	0.100
CERAMIC TILE FNSHER		BLD		28.520	0.000	2.0	1.5	2.0	5.650	5.750	0.000	0.330
COMMUNICATION TECH		BLD		32.120	34.220	1.5	1.5	2.0	8.490	7.390	0.000	0.640
ELECTRIC PWR EQMT OP		ALL		27.920	35.880	1.5	1.5	2.0	4.750	7.820	0.000	0.210
ELECTRIC PWR GRNDMAN		ALL		21.640	35.880	1.5	1.5	2.0	4.750	6.060	0.000	0.160
ELECTRIC PWR LINEMAN		ALL		33.220	35.880	1.5	1.5	2.0	4.750	9.310	0.000	0.250
ELECTRIC PWR TRK DRV		ALL		22.340	35.880	1.5	1.5	2.0	4.750	6.260	0.000	0.170
ELECTRICIAN		BLD		38.570	42.430	1.5	1.5	2.0	8.490	9.650	0.000	0.770
ELEVATOR CONSTRUCTOR		BLD		42.045	47.300	2.0	2.0	2.0	8.275	6.060	2.520	0.550
FENCE ERECTOR		ALL		34.100	35.810	2.0	2.0	2.0	7.690	13.11	0.000	0.230
GLAZIER		BLD		31.400	32.400	1.5	2.0	2.0	6.490	9.050	0.000	0.500
HT/FROST INSULATOR		BLD		33.300	35.050	1.5	1.5	2.0	7.860	8.610	0.000	0.310
IRON WORKER		ALL		34.100	35.810	2.0	2.0	2.0	7.690	13.11	0.000	0.230
LABORER		ALL		31.550	32.300	1.5	1.5	2.0	7.200	5.100	0.000	0.170
LATHER		BLD		35.320	37.320	1.5	1.5	2.0	6.760	5.320	0.000	0.490
MACHINIST		BLD		36.890	38.890	2.0	2.0	2.0	4.380	5.650	2.550	0.000
MARBLE FINISHERS		ALL		25.750	0.000	1.5	1.5	2.0	6.070	7.020	0.000	0.580
MARBLE MASON		BLD		34.850	38.340	1.5	1.5	2.0	7.050	7.870	0.000	0.490
MATERIAL TESTER 1		ALL		21.550	0.000	1.5	1.5	2.0	7.460	4.840	0.000	0.170
MATERIALS TESTER II		ALL		26.550	0.000	1.5	1.5	2.0	7.460	4.840	0.000	0.170
MILLWRIGHT		ALL		35.320	37.320	1.5	1.5	2.0	6.760	5.320	0.000	0.490
OPERATING ENGINEER		BLD	1	41.550	45.550	2.0	2.0	2.0	6.850	5.600	1.900	0.700
OPERATING ENGINEER		BLD	2	40.250	45.550	2.0	2.0	2.0	6.850	5.600	1.900	0.700
OPERATING ENGINEER		BLD	3	37.700	45.550	2.0	2.0	2.0	6.850	5.600	1.900	0.700
OPERATING ENGINEER		BLD	4	35.950	45.550	2.0	2.0	2.0	6.850	5.600	1.900	0.700
OPERATING ENGINEER		HWY	1	39.750	43.750	1.5	1.5	2.0	6.850	5.600	1.900	0.700
OPERATING ENGINEER		HWY	2	39.200	43.750	1.5	1.5	2.0	6.850	5.600	1.900	0.700
OPERATING ENGINEER		HWY	3	37.150	43.750	1.5	1.5	2.0	6.850	5.600	1.900	0.700
OPERATING ENGINEER		HWY	4	35.750	43.750	1.5	1.5	2.0	6.850	5.600	1.900	0.700
OPERATING ENGINEER		HWY	5	34.550	43.750	1.5	1.5	2.0	6.850	5.600	1.900	0.700
ORNAMNTL IRON WORKER		ALL		34.100	35.810	2.0	2.0	2.0	7.690	13.11	0.000	0.230
PAINTER		ALL		34.380	35.380	1.5	1.5	1.5	5.650	5.750	0.000	0.350
PAINTER SIGNS		BLD		28.970	32.520	1.5	1.5	1.5	2.600	2.310	0.000	0.000
PILEDRIVER		ALL		35.320	37.320	1.5	1.5	2.0	6.760	5.320	0.000	0.490
PIPEFITTER		BLD		36.010	38.010	1.5	1.5	2.0	8.450	8.690	0.000	0.950
PLASTERER		BLD		33.850	35.350	1.5	1.5	2.0	6.740	7.100	0.000	0.400
PLUMBER		BLD		36.010	38.010	1.5	1.5	2.0	8.450	8.690	0.000	0.950
ROOFER		BLD		33.650	35.650	1.5	1.5	2.0	6.460	3.310	0.000	0.330
SHEETMETAL WORKER		BLD		36.510	38.510	1.5	1.5	2.0	6.890	8.020	0.000	0.640
SPRINKLER FITTER		BLD		38.500	40.500	1.5	1.5	2.0	8.250	6.100	0.000	0.500
STEEL ERECTOR		ALL		34.100	35.810	2.0	2.0	2.0	7.690	13.11	0.000	0.230
STONE MASON		BLD		33.250	36.580	1.5	1.5	2.0	6.450	7.020	0.000	0.440
TERRAZZO FINISHER		BLD		29.290	0.000	1.5	1.5	2.0	5.650	6.940	0.000	0.270
TERRAZZO MASON		BLD		33.650	36.650	1.5	1.5	2.0	5.650	8.610	0.000	0.300
TILE MASON		BLD		34.600	38.600	2.0	1.5	2.0	5.650	7.000	0.000	0.460
TRUCK DRIVER		ALL	1	32.040	32.590	1.5	1.5	2.0	5.830	3.680	0.000	0.000
TRUCK DRIVER		ALL	2	32.190	32.590	1.5	1.5	2.0	5.830	3.680	0.000	0.000
TRUCK DRIVER		ALL	3	32.390	32.590	1.5	1.5	2.0	5.830	3.680	0.000	0.000
TRUCK DRIVER		ALL	4	32.590	32.590	1.5	1.5	2.0	5.830	3.680	0.000	0.000
TUCKPOINTER		BLD		34.500	35.500	1.5	1.5	2.0	4.710	6.340	0.000	0.400

Legend:



M-F>8 (Overtime is required for any hour greater than 8 worked each day, Monday through Friday.)

OSA (Overtime is required for every hour worked on Saturday)

OSH (Overtime is required for every hour worked on Sunday and Holidays)

H/W (Health & Welfare Insurance)

Pensn (Pension)

Vac (Vacation)

Trng (Training)

## Explanations

### KENDALL COUNTY

The following list is considered as those days for which holiday rates of wages for work performed apply: New Years Day, Memorial/Decoration Day, Fourth of July, Labor Day, Veterans Day, Thanksgiving Day, Christmas Day. Generally, any of these holidays which fall on a Sunday is celebrated on the following Monday. This then makes work performed on that Monday payable at the appropriate overtime rate for holiday pay. Common practice in a given local may alter certain days of celebration such as the day after Thanksgiving for Veterans Day. If in doubt, please check with IDOL.

### EXPLANATION OF CLASSES

ASBESTOS - GENERAL - removal of asbestos material/mold and hazardous materials from any place in a building, including mechanical systems where those mechanical systems are to be removed. This includes the removal of asbestos materials/mold and hazardous materials from ductwork or pipes in a building when the building is to be demolished at the time or at some close future date.

ASBESTOS - MECHANICAL - removal of asbestos material from mechanical systems, such as pipes, ducts, and boilers, where the mechanical systems are to remain.

### CERAMIC TILE FINISHER

The grouting, cleaning, and polishing of all classes of tile, whether for interior or exterior purposes, all burned, glazed or unglazed products; all composition materials, granite tiles, warning detectable tiles, cement tiles, epoxy composite materials, pavers, glass, mosaics, fiberglass, and all substitute materials, for tile made in tile-like units; all mixtures in tile like form of cement, metals, and other materials that are for and intended for use as a finished floor surface, stair treads, promenade roofs, walks, walls, ceilings, swimming pools, and all other places where tile is to form a finished interior or exterior. The mixing of all setting mortars including but not limited to thin-set mortars, epoxies, wall mud, and any other sand and cement mixtures or adhesives when used in the preparation, installation, repair, or maintenance of tile and/or similar materials. The handling and unloading of all sand, cement, lime, tile, fixtures, equipment, adhesives, or any other materials to be used in the preparation, installation, repair, or maintenance of tile and/or

similar materials. Ceramic Tile Finishers shall fill all joints and voids regardless of method on all tile work, particularly and especially after installation of said tile work. Application of any and all protective coverings to all types of tile installations including, but not be limited to, all soap compounds, paper products, tapes, and all polyethylene coverings, plywood, masonite, cardboard, and any new type of products that may be used to protect tile installations, Blastrac equipment, and all floor scarifying equipment used in preparing floors to receive tile. The clean up and removal of all waste and materials. All demolition of existing tile floors and walls to be re-tiled.

#### COMMUNICATIONS TECHNICIAN

Construction, installation, maintenance and removal of telecommunication facilities (voice, sound, data and video), telephone, security, and data inside wire, interconnect, terminal equipment, central offices, PABX and equipment, micro waves, V-SAT, bypass, CATV, WAN (wide area network), LAN (local area networks), and ISDN (integrated system digital network), pulling of wire in raceways, but not the installation of raceways.

#### MARBLE FINISHER

Loading and unloading trucks, distribution of all materials (all stone, sand, etc.), stocking of floors with material, performing all rigging for heavy work, the handling of all material that may be needed for the installation of such materials, building of scaffolding, polishing if needed, patching, waxing of material if damaged, pointing up, caulking, grouting and cleaning of marble, holding water on diamond or Carborundum blade or saw for setters cutting, use of tub saw or any other saw needed for preparation of material, drilling of holes for wires that anchor material set by setters, mixing up of molding plaster for installation of material, mixing up thin set for the installation of material, mixing up of sand to cement for the installation of material and such other work as may be required in helping a Marble Setter in the handling of all material in the erection or installation of interior marble, slate, travertine, art marble, serpentine, alberene stone, blue stone, granite and other stones (meaning as to stone any foreign or domestic materials as are specified and used in building interiors and exteriors and customarily known as stone in the trade), carrara, sanionyx, vitrolite and similar opaque glass and the laying of all marble tile, terrazzo tile, slate tile and precast tile, steps, risers treads, base, or any other materials that may be used as substitutes for any of the aforementioned materials and which are used on interior and exterior which are installed in a similar manner.

MATERIAL TESTER I: Hand coring and drilling for testing of materials; field inspection of uncured concrete and asphalt.

MATERIAL TESTER II: Field inspection of welds, structural steel, fireproofing, masonry, soil, facade, reinforcing steel, formwork, cured concrete, and concrete and asphalt batch plants; adjusting proportions of bituminous mixtures.

#### TRUCK DRIVER - BUILDING, HEAVY AND HIGHWAY CONSTRUCTION

Class 1. Two or three Axle Trucks. A-frame Truck when used for transportation purposes; Air Compressors and Welding Machines, including those pulled by cars, pick-up trucks and tractors; Ambulances Batch Gate Lockers; Batch Hopperman; Car and Truck Washers; Carry-alls; Fork Lifts and Hoisters; Helpers; Mechanics Helpers and Greasers; Oil Distributors 2-man operation; Pavement Breakers; Pole Trailer, up to 40 feet; Power Mower Tractors; Self-propelled Chip

Spreader; Skipman; Slurry Trucks, 2-man operation; Slurry Truck Conveyor Operation, 2 or 3 man; Teamsters; Unskilled dumpman; and Truck Drivers hauling warning lights, barricades, and portable toilets on the job site.

Class 2. Four axle trucks; Dump Crets and Adgetors under 7 yards; Dumpsters, Track Trucks, Euclids, Hug Bottom Dump Turnapulls or Turnatrailers when pulling other than self-loading equipment or similar equipment under 16 cubic yards; Mixer Trucks under 7 yards; Ready-mix Plant Hopper Operator, and Winch Trucks, 2 Axles.

Class 3. Five axle trucks; Dump Crets and Adgetors 7 yards and over; Dumpsters, Track Trucks, Euclids, Hug Bottom Dump Turnatrailers or turnapulls when pulling other than self-loading equipment or similar equipment over 16 cubic yards; Explosives and/or Fission Material Trucks; Mixer Trucks 7 yards or over; Mobile Cranes while in transit; Oil Distributors, 1-man operation; Pole Trailer, over 40 feet; Pole and Expandable Trailers hauling material over 50 feet long; Slurry trucks, 1-man operation; Winch trucks, 3 axles or more; Mechanic--Truck Welder and Truck Painter.

Class 4. Six axle trucks; Dual-purpose vehicles, such as mounted crane trucks with hoist and accessories; Foreman; Master Mechanic; Self-loading equipment like P.B. and trucks with scoops on the front.

#### OPERATING ENGINEERS - BUILDING

Class 1. Mechanic; Asphalt Plant; Asphalt Spreader; Autograde; Backhoes with Caisson attachment; Batch Plant; Benoto; Boiler and Throttle Valve; Caisson Rigs; Central Redi-Mix Plant; Combination Back Hoe Front End-loader Machine; Compressor and Throttle Valve; Concrete Breaker (Truck Mounted); Concrete Conveyor; Concrete Paver; Concrete Placer; Concrete Placing Boom; Concrete Pump (Truck Mounted); Concrete Tower; Cranes, All; Cranes, Hammerhead; Cranes, (GCI and similar Type); Creter Crane; Crusher, Stone, etc.; Derricks, All; Derricks, Traveling; Formless Curb and Gutter Machine; Grader, Elevating; Grouting Machines; Highlift Shovels or Front Endloader 2-1/4 yd. and over; Hoists, Elevators, outside type rack and pinion and similar machines; Hoists, one, two and three Drum; Hoists, Two Tugger One Floor; Hydraulic Backhoes; Hydraulic Boom Trucks; Hydro Vac (and similar equipment); Locomotives, All; Motor Patrol; Pile Drivers and Skid Rig; Post Hole Digger; Pre-Stress Machine; Pump Cretes Dual Ram; Pump Cretes; Squeeze Cretes-screw Type Pumps; Raised and Blind Hole Drill; Roto Mill Grinder; Scoops - Tractor Drawn; Slip-form Paver; Straddle Buggies; Tournapull; Tractor with Boom and Side Boom; Trenching Machines.

Class 2. Boilers; Broom, All Power Propelled; Bulldozers; Concrete Mixer (Two Bag and Over); Conveyor, Portable; Forklift Trucks; Greaser Engineer; Highlift Shovels or Front Endloaders under 2-1/4 yd.; Hoists, Automatic; Hoists, inside Freight Elevators; Hoists, Sewer Dragging Machine; Hoists, Tugger Single Drum; Laser Screed; Rock Drill (self-propelled); Rock Drill (truck mounted); Rollers, All; Steam Generators; Tractors, All; Tractor Drawn Vibratory Roller; Winch Trucks with "A" Frame.

Class 3. Air Compressor; Combination - Small Equipment Operator; Generators; Heaters, Mechanical; Hoists, Inside Elevators - (Rheostat Manual Controlled); Hydraulic Power Units (Pile Driving, Extracting, and Drilling); Pumps, over 3" (1 to 3 not to exceed a total of 300 ft.); Pumps, Well Points; Welding Machines (2 through 5); Winches, 4 small Electric Drill Winches; Bobcat (up to and including 3/4 cu. yd.).

Class 4. Bobcats and/or other Skid Steer Loaders; Oilers; and Brick Forklift.

OPERATING ENGINEERS - HEAVY AND HIGHWAY CONSTRUCTION

Class 1. Craft Foreman; Asphalt Plant; Asphalt Heater and Planer Combination; Asphalt Heater Scarfire; Asphalt Spreader; Autograder/GOMACO or other similar type machines; ABG Paver; Backhoes with Caisson attachment; Ballast Regulator; Belt Loader; Caisson Rigs; Car Dumper; Central Redi-Mix Plant; Combination Backhoe Front Endloader Machine, (1 cu. yd. Backhoe Bucket or over or with attachments); Concrete Breaker (Truck Mounted); Concrete Conveyor; Concrete Paver over 27E cu. ft.; Concrete Placer; Concrete Tube Float; Cranes, all attachments; Cranes, Hammerhead, Linden, Peco & Machines of a like nature; Crete Crane; Crusher, Stone, etc.; Derricks, All; Derrick Boats; Derricks, Traveling; Dowell machine with Air Compressor; Dredges; Field Mechanic-Welder; Formless Curb and Gutter Machine; Gradall and Machines of a like nature; Grader, Elevating; Grader, Motor Grader, Motor Patrol, Auto Patrol, Form Grader, Pull Grader, Subgrader; Guard Rail Post Driver Mounted; Hoists, One, Two and Three Drum; Hydraulic Backhoes; Backhoes with shear attachments; Mucking Machine; Pile Drivers and Skid Rig; Pre-Stress Machine; Pump Cretes Dual Ram; Rock Drill - Crawler or Skid Rig; Rock Drill - Truck Mounted; Roto Mill Grinder; Slip-Form Paver; Soil Test Drill Rig (Truck Mounted); Straddle Buggies; Hydraulic Telescoping Form (Tunnel); Tractor Drawn Belt Loader (with attached pusher - two engineers); Tractor with Boom; Tractaire with Attachments; Trenching Machine; Truck Mounted Concrete Pump with Boom; Raised or Blind Hole; Drills (Tunnel Shaft); Underground Boring and/or Mining Machines; Wheel Excavator; Widener (APSCO).

Class 2. Batch Plant; Bituminous Mixer; Boiler and Throttle Valve; Bulldozers; Car Loader Trailing Conveyors; Combination Backhoe Front Endloader Machine (less than 1 cu. yd. Backhoe Bucket or over or with attachments); Compressor and Throttle Valve; Compressor, Common Receiver (3); Concrete Breaker or Hydro Hammer; Concrete Grinding Machine; Concrete Mixer or Paver 7S Series to and including 27 cu. ft.; Concrete Spreader; Concrete Curing Machine, Burlap Machine, Belting Machine and Sealing Machine; Concrete Wheel Saw; Conveyor Muck Cars (Haglund or Similar Type); Drills, All; Finishing Machine - Concrete; Greaser Engineer; Highlift Shovels or Front Endloader; Hoist - Sewer Dragging Machine; Hydraulic Boom Trucks (All Attachments); Hydro-Blaster; All Locomotives, Dinky; Pump Cretes; Squeeze Cretes-Screw Type Pumps, Gypsum Bulker and Pump; Roller, Asphalt; Rotary Snow Plows; Rototiller, Seaman, etc., self-propelled; Scoops - Tractor Drawn; Self-Propelled Compactor; Spreader - Chip - Stone, etc.; Scraper; Scraper - Prime Mover in Tandem (Regardless of Size); Tank Car Heater; Tractors, Push, Pulling Sheeps Foot, Disc, Compactor, etc.; Tug Boats.

Class 3. Boilers; Brooms, All Power Propelled; Cement Supply Tender; Compressor, Common Receiver (2); Concrete Mixer (Two Bag and Over); Conveyor, Portable; Farm-Type Tractors Used for Mowing, Seeding, etc.; Fireman on Boilers; Forklift Trucks; Grouting Machine; Hoists, Automatic; Hoists, All Elevators; Hoists, Tugger Single Drum; Jeep Diggers; Pipe Jacking Machines; Post-Hole Digger; Power Saw, Concrete Power Driven; Pug Mills; Rollers, other than asphalt; Seed and Straw Blower; Steam Generators; Stump Machine; Winch Trucks with "A" Frame; Work Boats; Tamper - Form-Motor Driven.

Class 4. Air Compressor; Combination - Small Equipment Operator; Directional Boring Machine; Generators; Heaters, Mechanical; Hydraulic Power Unit (Pile Driving, Extracting, or Drilling); Hydro-Blaster;

Light Plants, All (1 through 5); Pumps, over 3" (1 to 3 not to exceed a total of 300 ft.); Pumps, Well Points; Tractaire; Welding Machines (2 through 5); Winches, 4 Small Electric Drill Winches.

Class 5. Bobcats (all); Brick Forklifts, Oilers.

#### TERRAZZO FINISHER

The handling of sand, cement, marble chips, and all other materials that may be used by the Mosaic Terrazzo Mechanic, and the mixing, grinding, grouting, cleaning and sealing of all Marble, Mosaic, and Terrazzo work, floors, base, stairs, and wainscoting by hand or machine, and in addition, assisting and aiding Marble, Masonic, and Terrazzo Mechanics.

#### Other Classifications of Work:

For definitions of classifications not otherwise set out, the Department generally has on file such definitions which are available. If a task to be performed is not subject to one of the classifications of pay set out, the Department will upon being contacted state which neighboring county has such a classification and provide such rate, such rate being deemed to exist by reference in this document. If no neighboring county rate applies to the task, the Department shall undertake a special determination, such special determination being then deemed to have existed under this determination. If a project requires these, or any classification not listed, please contact IDOL at 618/993-7271 for wage rates or clarifications.

#### LANDSCAPING

Landscaping work falls under the existing classifications for laborer, operating engineer and truck driver. The work performed by landscape plantsman and landscape laborer is covered by the existing classification of laborer. The work performed by landscape operators (regardless of equipment used or its size) is covered by the classifications of operating engineer. The work performed by landscape truck drivers (regardless of size of truck driven) is covered by the classifications of truck driver.

# Knox County Prevailing Wage for April 2007

Trade Name	RG	TYP	C	Base	FRMAN	*M-F>8	OSA	OSH	H/W	Pensn	Vac	Trng
=====	==	==	=	=====	=====	=====	==	==	=====	=====	=====	=====
ASBESTOS ABT-GEN		BLD		23.510	24.260	1.5	1.5	2.0	5.850	6.180	0.000	0.600
ASBESTOS ABT-GEN		HWY		22.940	23.440	1.5	1.5	2.0	5.850	5.850	0.000	0.700
ASBESTOS ABT-MEC		BLD		18.750	19.750	1.5	1.5	2.0	4.750	2.000	0.000	0.000
BOILERMAKER		BLD		30.970	33.970	2.0	2.0	2.0	8.270	7.740	0.000	0.300
BRICK MASON		BLD		27.020	28.520	1.5	1.5	2.0	5.500	6.350	0.000	0.390
CARPENTER		BLD		26.020	28.020	1.5	1.5	2.0	6.500	7.150	0.000	0.320
CARPENTER		HWY		25.910	27.910	1.5	1.5	2.0	6.500	8.100	0.000	0.320
CEMENT MASON		ALL		24.230	24.730	1.5	1.5	2.0	5.050	4.500	0.000	0.300
CERAMIC TILE FNSHER		BLD		24.910	0.000	1.5	1.5	2.0	5.500	6.350	0.000	0.380
ELECTRIC PWR EQMT OP		ALL		30.750	0.000	1.5	1.5	2.0	4.750	8.610	0.000	0.000
ELECTRIC PWR GRNDMAN		ALL		21.090	0.000	1.5	1.5	2.0	4.750	5.905	0.000	0.000
ELECTRIC PWR LINEMAN		ALL		34.160	36.350	1.5	1.5	2.0	4.750	9.560	0.000	0.000
ELECTRIC PWR TRK DRV		ALL		22.130	0.000	1.5	1.5	2.0	4.750	6.200	0.000	0.000
ELECTRICIAN		BLD		27.040	29.040	1.5	1.5	2.0	5.150	7.460	0.000	0.250
ELECTRONIC SYS TECH		BLD		23.850	25.350	1.5	1.5	2.0	5.150	5.625	0.000	0.250
ELEVATOR CONSTRUCTOR		BLD		34.190	38.460	2.0	2.0	2.0	8.275	6.060	2.050	0.000
GLAZIER		BLD		26.320	27.070	1.5	1.5	2.0	5.650	5.750	0.000	0.350
HT/FROST INSULATOR		BLD		25.860	27.060	1.5	1.5	2.0	4.800	7.500	0.000	0.000
IRON WORKER	NW	ALL		23.100	24.950	1.5	1.5	2.0	8.040	7.990	0.000	0.420
IRON WORKER	SE	BLD		24.960	26.710	1.5	1.5	2.0	8.040	7.410	0.000	0.400
IRON WORKER	SE	HWY		25.920	27.420	1.5	1.5	2.0	8.040	7.410	0.000	0.350
IRON WORKER	SW	ALL		21.500	22.750	1.5	1.5	2.0	5.760	6.790	0.000	0.260
LABORER		BLD		22.510	23.260	1.5	1.5	2.0	5.850	6.180	0.000	0.600
LABORER		HWY		21.940	22.440	1.5	1.5	2.0	5.850	5.850	0.000	0.600
LABORER, SKILLED		BLD		22.510	23.260	1.5	1.5	2.0	5.850	6.180	0.000	0.600
LABORER, SKILLED		HWY		22.240	22.740	1.5	1.5	2.0	5.850	5.850	0.000	0.600
LATHER		BLD		26.020	28.020	1.5	1.5	2.0	6.500	7.150	0.000	0.320
MACHINERY MOVER	SE	HWY		25.920	27.420	1.5	1.5	2.0	8.040	7.410	0.000	0.350
MACHINIST		BLD		36.890	38.890	2.0	2.0	2.0	4.380	5.650	2.550	0.000
MARBLE FINISHERS		BLD		24.910	0.000	1.5	1.5	2.0	5.500	6.350	0.000	0.380
MARBLE MASON		BLD		26.520	27.770	1.5	1.5	2.0	5.500	6.350	0.000	0.380
MILLWRIGHT		BLD		26.620	28.620	1.5	1.5	2.0	6.500	6.850	0.000	0.320
MILLWRIGHT		HWY		27.010	29.010	1.5	1.5	2.0	6.500	6.450	0.000	0.320
OPERATING ENGINEER		BLD	1	27.840	30.840	1.5	1.5	2.0	5.900	8.000	0.000	0.900
OPERATING ENGINEER		BLD	2	25.940	30.840	1.5	1.5	2.0	5.900	8.000	0.000	0.900
OPERATING ENGINEER		BLD	3	24.560	30.840	1.5	1.5	2.0	5.900	8.000	0.000	0.900
OPERATING ENGINEER		HWY	1	29.110	32.110	1.5	1.5	2.0	6.250	9.000	0.000	1.000
OPERATING ENGINEER		HWY	2	26.730	32.110	1.5	1.5	2.0	6.250	9.000	0.000	1.000
OPERATING ENGINEER		HWY	3	22.790	32.110	1.5	1.5	2.0	6.250	9.000	0.000	1.000
PAINTER		ALL		23.470	24.470	1.5	1.5	1.5	4.650	4.850	0.000	0.600
PAINTER OVER 30FT		ALL		24.720	25.720	1.5	1.5	1.5	4.650	4.850	0.000	0.600
PAINTER PWR EQMT		ALL		23.970	24.970	1.5	1.5	1.5	4.650	4.850	0.000	0.600
PILEDRIVER		BLD		26.520	28.520	1.5	1.5	2.0	6.500	7.150	0.000	0.320
PILEDRIVER		HWY		26.910	28.910	1.5	1.5	2.0	6.500	8.100	0.000	0.320
PIPEFITTER		ALL		30.520	33.570	1.5	1.5	2.0	4.800	7.960	0.000	0.530
PLASTERER		BLD		23.400	24.650	1.5	1.5	2.0	5.290	9.800	0.000	0.500
PLUMBER		ALL		30.520	33.570	1.5	1.5	2.0	4.800	7.960	0.000	0.530
ROOFER		BLD		22.850	24.100	1.5	1.5	2.0	5.840	4.870	0.000	0.190
SHEETMETAL WORKER		BLD		27.300	29.000	1.5	1.5	2.0	6.040	7.300	0.000	0.380
SIGN HANGER	SE	HWY		25.920	27.420	1.5	1.5	2.0	8.040	7.410	0.000	0.350
SPRINKLER FITTER		BLD		31.240	33.240	1.5	1.5	2.0	6.500	5.350	0.000	0.250
STEEL ERECTOR	SE	HWY		25.920	27.420	1.5	1.5	2.0	8.040	7.410	0.000	0.350
STONE MASON		BLD		27.020	28.520	1.5	1.5	2.0	5.500	6.350	0.000	0.390
TERRAZZO FINISHER		BLD		24.910	0.000	1.5	1.5	2.0	5.500	6.350	0.000	0.380
TERRAZZO MASON		BLD		26.520	27.770	1.5	1.5	2.0	5.500	6.350	0.000	0.380
TILE MASON		BLD		26.520	27.770	1.5	1.5	2.0	5.500	6.350	0.000	0.380
TRUCK DRIVER		ALL	1	25.787	0.000	1.5	1.5	2.0	7.250	3.317	0.000	0.000
TRUCK DRIVER		ALL	2	26.187	0.000	1.5	1.5	2.0	7.250	3.317	0.000	0.000

TRUCK DRIVER	ALL	3	26.387	0.000	1.5	1.5	2.0	7.250	3.317	0.000	0.000
TRUCK DRIVER	ALL	4	26.637	0.000	1.5	1.5	2.0	7.250	3.317	0.000	0.000
TRUCK DRIVER	ALL	5	27.387	0.000	1.5	1.5	2.0	7.250	3.317	0.000	0.000
TRUCK DRIVER	O&C	1	20.630	0.000	1.5	1.5	2.0	7.250	3.317	0.000	0.000
TRUCK DRIVER	O&C	2	20.950	0.000	1.5	1.5	2.0	7.250	3.317	0.000	0.000
TRUCK DRIVER	O&C	3	21.110	0.000	1.5	1.5	2.0	7.250	3.317	0.000	0.000
TRUCK DRIVER	O&C	4	21.310	0.000	1.5	1.5	2.0	7.250	3.317	0.000	0.000
TRUCK DRIVER	O&C	5	21.910	0.000	1.5	1.5	2.0	7.250	3.317	0.000	0.000
TUCKPOINTER	BLD		27.020	28.520	1.5	1.5	2.0	5.500	6.350	0.000	0.390

Legend:

M-F>8 (Overtime is required for any hour greater than 8 worked each day, Monday through Friday.)

OSA (Overtime is required for every hour worked on Saturday)

OSH (Overtime is required for every hour worked on Sunday and Holidays)

H/W (Health & Welfare Insurance)

Pensn (Pension)

Vac (Vacation)

Trng (Training)

## Explanations

### KNOX COUNTY

IRONWORKERS (SOUTHWEST) - That part of the county West of Rt. 41.

IRONWORKERS (SOUTHEAST) - That part of the county South and East of a line from Tolona (Stark County) North of Victoria to (but excluding) Galesburg looping East and South of the city to Rt. 41 South to the county line.

The following list is considered as those days for which holiday rates of wages for work performed apply: New Years Day, Memorial/Decoration Day, Fourth of July, Labor Day, Veterans Day, Thanksgiving Day, Christmas Day. Generally, any of these holidays which fall on a Sunday is celebrated on the following Monday. This then makes work performed on that Monday payable at the appropriate overtime rate for holiday pay. Common practice in a given local may alter certain days of celebration such as the day after Thanksgiving for Veterans Day. If in doubt, please check with IDOL.

Oil and chip resealing (O&C) means the application of road oils and liquid asphalt to coat an existing road surface, followed by application of aggregate chips or gravel to coated surface, and subsequent rolling of material to seal the surface.

### EXPLANATION OF CLASSES

ASBESTOS - GENERAL - removal of asbestos material/mold and hazardous materials from any place in a building, including mechanical systems where those mechanical systems are to be removed. This includes the removal of asbestos materials/mold and hazardous materials from

ductwork or pipes in a building when the building is to be demolished at the time or at some close future date.

ASBESTOS - MECHANICAL - removal of asbestos material from mechanical systems, such as pipes, ducts, and boilers, where the mechanical systems are to remain.

#### CERAMIC TILE FINISHER, MARBLE FINISHER, TERRAZZO FINISHER

Assisting, helping or supporting the tile, marble and terrazzo mechanic by performing their historic and traditional work assignments required to complete the proper installation of the work covered by said crafts. The term "Ceramic" is used for naming the classification only and is in no way a limitation of the product handled. Ceramic takes into consideration most hard tiles.

#### ELECTRONIC SYSTEMS TECHNICIAN

Installation, service and maintenance of low-voltage systems which utilizes the transmission and/or transference of voice, sound, vision, or digital for commercial, education, security and entertainment purposes for the following: TV monitoring and surveillance, background/foreground music, intercom and telephone interconnect, field programming, inventory control systems, microwave transmission, multi-media, multiplex, radio page, school, intercom and sound burglar alarms and low voltage master clock systems.

Excluded from this classification are energy management systems, life safety systems, supervisory controls and data acquisition systems not intrinsic with the above listed systems, fire alarm systems, nurse call systems and raceways exceeding fifteen feet in length.

#### LABORER, SKILLED - BUILDING

The skilled laborer building (BLD) classification shall encompass the following types of work, irrespective of the site of the work: tending of carpenters in unloading, handling, stockpiling and distribution operations, also other building crafts, mixing, handling, and conveying of all materials used by masons, plasterers and other building construction crafts, whether done by hand or by any process. The drying of plastering when done by salamander heat, and the cleaning and clearing of all debris. All work pertaining to and in preparation of asbestos abatement and removal. The building of scaffolding and staging for masons and plasterers. The excavations for buildings and all other construction, digging, of trenches, piers, foundations and holes, digging, lagging, sheeting, cribbing, bracing and propping of foundations, holes, caissons, cofferdams, and dikes, the setting of all guidelines for machine or hand excavation and subgrading. The mixing, handling, conveying, pouring, vibrating, gunniting and otherwise applying of concrete, whether by hand or other method of concrete for any walls, foundations, floors, or for other construction concrete sealant men. The wrecking, stripping, dismantling, and handling of concrete forms and false work, and the building of centers for fireproofing purposes. Boring machine, gas, electric or air in preparation for shoving pipe, telephone cable, and so forth, under highways, roads, streets and alleys. All hand and power operating cross cut saws when used for clearing. All work in compressed air construction. All work on acetylene burners in salvaging. The blocking and tamping of concrete. The laying of sewer tile and conduit, and pre-cast materials. The assembling and dismantling of all jacks and sectional scaffolding, including elevator construction and running of slip form jacks. The work of drill running and blasting, including wagon drills. The wrecking,



stripping, dismantling, cleaning, moving and oiling of forms. The cutting off of concrete piles. The loading, unloading, handling and carrying to place of installation of all rods, (and materials for use in reinforcing) concrete and the hoisting of same and all signaling where hoist is used in this type of construction coming under the jurisdiction of the Laborers' Union. And, all other labor work not awarded to any other craft. Mortar mixers, kettlemen and carrier of hot stuff, tool crib men, watchmen (Laborer), firemen or salamander tenders, flagmen, deck hands, installation and maintenance of temporary gas-fired heating units, gravel box men, dumpmen and spotters, fencing Laborers, cleaning lumber, pit men, material checkers, dispatchers, unloading explosives, asphalt plant laborers, writer of scale tickets, fireproofing laborers, janitors, asbestos abatement and removal laborers, handling of materials treated with oil, creosote, chloride, asphalt, and/or foreign material harmful to skin or clothing, Laborers with de-watering systems, gunnite nozzle men, laborers tending masons with hot material or where foreign materials are used, Laborers handling masterplate or similar materials, laser beam operator, concrete burning machine operator, material selector men working with firebrick or combustible material, dynamite men, track laborers, cement handlers, chloride handlers, the unloading and laborers with steel workers and re-bars, concrete workers (wet), luteman, asphalt raker, curb asphalt machine operator, ready mix scalemen, permanent, portable or temporary plant drilling machine operator, plaster tenders, underpinning and shoring of buildings, fire watch, signaling of all power equipment, to include trucks excavating equipment, etc., tree topper or trimmer when in connection to construction, tunnel helpers in free air, batch dumpers, kettle and tar men, tank cleaners, plastic installers, scaffold workers, motorized buggies or motorized unit used for wet concrete or handling of building materials, sewer workers, rod and chain men, vibrator operators, mortar mixer operator, cement silica, clay, fly ash, lime and plasters, handlers (bulk or bag), cofferdam workers, on concrete paving, placing, cutting and tying of reinforcing, deck hand, dredge hand and shore laborers, bankmen on floating plant, asphalt workers with machine & layers, grade checker, power tools, caisson workers, lead man on sewer work, welders, cutters, burners and torch men, chain saw operators, paving breaker, jackhammer and drill operator, layout man and/or drainage tile layer, steel form setters -- street and highway, air tamping hammerman, signal man on crane, concrete saw operator, screen man on asphalt pavers, front end man on chip spreader, multiple concrete duct -- lead man.

#### LABORER, SKILLED - HIGHWAY

The skilled laborer heavy and highway (HWY) classification shall encompass the following types of work, irrespective of the site of the work: handling of materials treated with oil, creosote, asphalt and/or any foreign materials harmful to skin or clothing, track laborers, chloride handlers, the unloading and loading with steel workers and re-bars, concrete workers (wet), tunnel helpers in free air, batch dumpers, mason tenders, kettle and tar men, plastic installers, scaffold workers, motorized buggies or motorized unit used for wet concrete or handling of building materials, laborers with de-watering systems, sewer workers plus depth, rod and chainmen, vibrator operators, mortar mixer operators, cement silica, clay, fly ash, lime and plasters, handlers (bulk or bag), cofferdam workers plus depth, on concrete paving, placing, cutting and tying or reinforcing, deck hand, dredge hand shore laborers, bankmen on floating plant, asphalt workers with machine, and layers, grade checker, power tools, stripping of all concrete forms excluding paving forms, dumpmen and spotters, when necessary, caisson workers plus depth, gunnite nozzle men, welders, cutters, burners and torchmen, chain saw operators,

paving breaker, jackhammer and drill operators, layout man and/or drainage tile layer, steel form setters - street and highway, air tamping hammerman, signal man on crane, concrete saw operator, screedman on asphalt pavers, front end man on chip spreader, multiple concrete duct, luteman, asphalt raker, curb asphalt machine operator, ready mix scalemen (portable or temporary plant), laser beam operator, concrete burning machine operator, and coring machine operator.

#### TRUCK DRIVER - BUILDING, HEAVY AND HIGHWAY CONSTRUCTION

Class 1. Drivers on 2 axle trucks hauling less than 9 ton. Air compressor and welding machines and brooms, including those pulled by separate units, truck driver helpers, warehouse employees, mechanic helpers, greasers and tiremen, pickup trucks when hauling materials, tools, or workers to and from and on-the-job site, and fork lifts up to 6,000 lb. capacity.

Class 2. Two or three axle trucks hauling more than 9 ton but hauling less than 16 ton. A-frame winch trucks, hydrolift trucks, vactor trucks or similar equipment when used for transportation purposes. Fork lifts over 6,000 lb. capacity, winch trucks, four axle combination units, and ticket writers.

Class 3. Two, three or four axle trucks hauling 16 ton or more. Drivers on water pulls, articulated dump trucks, mechanics and working forepersons, and dispatchers. Five axle or more combination units.

Class 4. Low Boy and Oil Distributors.

Class 5. Drivers who require special protective clothing while employed on hazardous waste work.

#### TRUCK DRIVER - OIL AND CHIP RESEALING ONLY.

This shall encompass laborers, workers and mechanics who drive contractor or subcontractor owned, leased, or hired pickup, dump, service, or oil distributor trucks. The work includes transporting materials and equipment (including but not limited to, oils, aggregate supplies, parts, machinery and tools) to or from the job site; distributing oil or liquid asphalt and aggregate; stock piling material when in connection with the actual oil and chip contract. The Truck Driver (Oil & Chip Resealing) wage classification does not include supplier delivered materials.

#### OPERATING ENGINEERS - BUILDING

Class 1. Cranes; Overhead Cranes; Gradall; All Cherry Pickers; Mechanics; Central Concrete Mixing Plant Operator; Road Pavers (27E - Dual Drum - Tri Batchers); Blacktop Plant Operators and Plant Engineers; 3 Drum Hoist; Derricks; Hydro Cranes; Shovels; Skimmer Scoops; Koehring Scooper; Drag Lines; Backhoe; Derrick Boats; Pile Drivers and Skid Rigs; Clamshells; Locomotive Cranes; Dredge (all types) Motor Patrol; Power Blades - Dumore - Elevating and similar types; Tower Cranes (Crawler-Mobile) and Stationary; Crane-type Backfiller; Drott Yumbo and similar types considered as Cranes; Caisson Rigs; Dozer; Tournadozer; Work Boats; Ross Carrier; Helicopter; Tournapulls - all and similar types; Scoops (all sizes); Pushcats; Endloaders (all types); Asphalt Surfacing Machine; Slip Form Paver; Rock Crusher; Heavy Equipment Greaser; CMI, CMI Belt Placer, Auto Grade & 3 Track and similar types; Side Booms; Multiple Unit Earth Movers; Creter Crane; Trench Machine; Pump-crete-Belt Crete-Squeeze Cretes-Screw-type Pumps and Gypsum; Bulker & Pump - Operator will clean; Formless Finishing Machine; Flaherty Spreader or

similar types; Screed Man on Laydown Machine; Wheel Tractors (industrial or Farm-type w/Dozer-Hoe-Endloader or other attachments); F.W.D. & Similar Types; Vermeer Concrete Saw.

Class 2. Dinkeys; Power Launches; PH One-pass Soil Cement Machine (and similar types); Pugmill with Pump; Backfillers; Euclid Loader; Forklifts; Jeeps w/Ditching Machine or other attachments; Tunneluger; Automatic Cement and Gravel Batching Plants; Mobile Drills (Soil Testing) and similar types; Gurries and Similar Types; (1) and (2) Drum Hoists (Buck Hoist and Similar Types); Chicago Boom; Boring Machine & Pipe Jacking Machine; Hydro Boom; Dewatering System; Straw Blower; Hydro Seeder; Assistant Heavy Equipment Greaser on Spread; Tractors (Track type) without Power Unit pulling Rollers; Rollers on Asphalt -- Brick Macadem; Concrete Breakers; Concrete Spreaders; Mule Pulling Rollers; Center Stripper; Cement Finishing Machines & CMI Texture & Reel Curing Machines; Cement Finishing Machine; Barber Green or similar loaders; Vibro Tamper (All similar types) Self-propelled; Winch or Boom Truck; Mechanical Bull Floats; Mixers over 3 Bag to 27E; Tractor pulling Power Blade or Elevating Grader; Porter Rex Rail; Clary Screed; Truck Type Hoptoe Oilers; Fireman; Spray Machine on Paving; Curb Machines; Truck Crane Oilers; Oil Distributor; Truck-Mounted Saws.

Class 3. Air Compressor; Power Subgrader; Straight Tractor; Trac Air without attachments; Herman Nelson Heater, Dravo, Warner, Silent Glo, and similar types; Roller: Five (5) Ton and under on Earth or Gravel; Form Grader; Crawler Crane & Skid Rig Oilers; Freight Elevators - permanently installed; Pump; Light Plant; Generator; Conveyor (1) or (2) - Operator will clean; Welding Machine; Mixer (3) Bag and Under (Standard Capacity with skip); Bulk Cement Plant; Oiler on Central Concrete Mixing Plant.

#### OPERATING ENGINEERS - HEAVY AND HIGHWAY CONSTRUCTION

Class 1. Cranes; Hydro Crane; Shovels; Crane Type Backfiller; Tower Cranes - Mobile & Crawler & Stationary; Derricks & Hoists (3 Drum); Draglines; Drott Yumbo & similar types considered as Cranes; Back Hoe; Derrick Boats; Pile Driver and Skid Rigs; Clam Shell; Locomotive - Cranes; Road Pavers - Single Drum - Dual Drum - Tri Batcher; Motor Patrols & Power Blades - Dumore - Elevating & Similar Types; Mechanics; Central Concrete Mixing Plant Operator; Asphalt Batch Plant Operators and Plant Engineers; Gradall; Caisson Rigs; Skimmer Scoop - Koering Scooper; Dredges (all types); Hoptoe; All Cherry Pickers; Work Boat; Ross Carrier; Helicopter; Dozer; Tournadozer; Tournapulls - all and similar types; Multiple Unit Earth Movers; Scoops (all sizes); Pushcats; Endloaders (all types); Asphalt Surfacing Machine; Slip Form Paver; Rock Crusher; Heavy Equipment Greaser (top greaser on spread); CMI, Auto Grade, CMI Belt Placer & 3 Track and similar types; Side Booms; Starting Engineer on Pipeline; Asphalt Heater & Planer Combination (used to plane streets); Wheel Tractors (with dozer, hoe or endloader attachments); F.W.D. and Similar types; Blaw Knox Spreader and Similar types; Trench Machines; Pump Crete - Belt Crete - Squeeze Crete - screw type pumps and gypsum (operator will clean); Formless Finishing Machines; Flaherty Spreader or similar types; Screed Man on Laydown Machine; Vermeer Concrete Saw.

Class 2. Bulker & Pump; Power Launches; Boring Machine & Pipe Jacking Machine; Dinkeys; P-H One Pass Soil Cement Machines and similar types; Wheel Tractors (Industry or farm type - other); Back Fillers; Euclid Loader; Fork Lifts; Jeep w/Ditching Machine or other attachments; Tunneluger; Automatic Cement & Gravel Batching Plants; Mobile Drills - Soil Testing and similar types; Pugmill with pump; All (1) and (2) Drum Hoists; Dewatering System; Straw Blower;

Hydro-Seeder; Boring Machine; Hydro-Boom; Bump Grinders (self-propelled); Assistant Heavy Equipment Greaser; Apsco Spreader; Tractors (track-type) without Power Units Pulling Rollers on Asphalt - Brick or Macadam; Concrete Breakers; Concrete Spreaders; Cement Strippers; Cement Finishing Machines & CMI Texture & Reel Curing Machines; Vibro-Tampers (all similar types self-propelled); Mechanical Bull Floats; Self-propelled Concrete Saws; Mixers-over three (3) bags to 27E; Winch and Boom Trucks; Tractor Pulling Power Blade or Elevating Grader; Porter Rex Rail; Clary Screed; Mule Pulling Rollers; Pugmill without Pump; Barber Greene or similar Loaders; Track Type Tractor w/Power Unit attached (minimum); Fireman; Spray Machine on Paving; Curb Machines; Paved Ditch Machine; Power Broom; Self-Propelled Conveyors; Power Subgrader; Oil Distributor; Straight Tractor; Truck Crane Oiler; Truck Type Oilers; Directional boring machine; Horizontal directional drill.

Class 3. Straight framed articulating end dump vehicles and Truck mounted vac unit (separately powered); Trac Air Machine (without attachments); Herman Nelson Heater, Dravo Warner, Silent Glo & similar types; Rollers - five ton and under on earth and gravel; Form Graders; Pumps; Light Plant; Generator; Air Compressor (1) or (2); Conveyor; Welding Machine; Mixer - 3 bags and under; Bulk Cement Plant; Oilers.

#### Other Classifications of Work:

For definitions of classifications not otherwise set out, the Department generally has on file such definitions which are available. If a task to be performed is not subject to one of the classifications of pay set out, the Department will upon being contacted state which neighboring county has such a classification and provide such rate, such rate being deemed to exist by reference in this document. If no neighboring county rate applies to the task, the Department shall undertake a special determination, such special determination being then deemed to have existed under this determination. If a project requires these, or any classification not listed, please contact IDOL at 618/993-7271 for wage rates or clarifications.

#### LANDSCAPING

Landscaping work falls under the existing classifications for laborer, operating engineer and truck driver. The work performed by landscape plantsman and landscape laborer is covered by the existing classification of laborer. The work performed by landscape operators (regardless of equipment used or its size) is covered by the classifications of operating engineer. The work performed by landscape truck drivers (regardless of size of truck driven) is covered by the classifications of truck driver.

# Lake County Prevailing Wage for April 2007

Trade Name	RG	TYP	C	Base	FRMAN	*M-F>8	OSA	OSH	H/W	Pensn	Vac	Trng
=====	==	==	=	=====	=====	=====	==	==	=====	=====	=====	=====
ASBESTOS ABT-GEN		ALL		31.550	32.300	1.5	1.5	2.0	7.460	4.840	0.000	0.170
ASBESTOS ABT-MEC		BLD		23.300	24.800	1.5	1.5	2.0	7.860	4.910	0.000	0.000
BOILERMAKER		BLD		38.540	42.000	2.0	2.0	2.0	6.720	7.440	0.000	0.300
BRICK MASON		BLD		34.850	38.340	1.5	1.5	2.0	7.050	7.870	0.000	0.380
CARPENTER		ALL		36.520	38.520	1.5	1.5	2.0	7.960	5.910	0.000	0.490
CEMENT MASON		ALL		33.490	34.490	2.0	1.5	2.0	6.830	8.800	0.000	0.100
CERAMIC TILE FNSHER		BLD		28.520	0.000	2.0	1.5	2.0	5.650	5.750	0.000	0.330
COMMUNICATION TECH		BLD		29.390	31.490	1.5	1.5	2.0	7.990	7.350	1.470	0.430
ELECTRIC PWR EQMT OP		ALL		27.920	35.880	1.5	1.5	2.0	4.750	7.820	0.000	0.210
ELECTRIC PWR GRNDMAN		ALL		21.640	35.880	1.5	1.5	2.0	4.750	6.060	0.000	0.160
ELECTRIC PWR LINEMAN		ALL		33.220	35.880	1.5	1.5	2.0	4.750	9.310	0.000	0.250
ELECTRIC PWR TRK DRV		ALL		22.340	35.880	1.5	1.5	2.0	4.750	6.260	0.000	0.170
ELECTRICIAN		BLD		34.020	37.420	1.5	1.5	2.0	8.510	9.520	1.700	0.480
ELEVATOR CONSTRUCTOR		BLD		42.045	47.300	2.0	2.0	2.0	8.275	6.060	2.520	0.550
FENCE ERECTOR		ALL		27.140	28.640	1.5	1.5	2.0	7.500	7.590	0.000	0.250
GLAZIER		BLD		31.400	32.400	1.5	2.0	2.0	6.490	9.050	0.000	0.500
HT/FROST INSULATOR		BLD		33.300	35.050	1.5	1.5	2.0	7.860	8.610	0.000	0.310
IRON WORKER		ALL		38.250	40.250	2.0	2.0	2.0	9.470	11.27	0.000	0.300
LABORER		ALL		31.550	32.300	1.5	1.5	2.0	7.460	4.840	0.000	0.170
LATHER		BLD		36.520	38.520	1.5	1.5	2.0	7.960	5.910	0.000	0.490
MACHINIST		BLD		36.890	38.890	2.0	2.0	2.0	4.380	5.650	2.550	0.000
MARBLE FINISHERS		ALL		25.750	0.000	1.5	1.5	2.0	6.070	7.020	0.000	0.580
MARBLE MASON		BLD		34.850	38.340	1.5	1.5	2.0	7.050	7.870	0.000	0.490
MATERIAL TESTER 1		ALL		21.550	0.000	1.5	1.5	2.0	7.460	4.840	0.000	0.170
MATERIALS TESTER II		ALL		26.550	0.000	1.5	1.5	2.0	7.460	4.840	0.000	0.170
MILLWRIGHT		ALL		36.520	38.520	1.5	1.5	2.0	7.960	5.910	0.000	0.490
OPERATING ENGINEER		BLD	1	41.550	45.550	2.0	2.0	2.0	6.850	5.600	1.900	0.700
OPERATING ENGINEER		BLD	2	40.250	45.550	2.0	2.0	2.0	6.850	5.600	1.900	0.700
OPERATING ENGINEER		BLD	3	37.700	45.550	2.0	2.0	2.0	6.850	5.600	1.900	0.700
OPERATING ENGINEER		BLD	4	35.950	45.550	2.0	2.0	2.0	6.850	5.600	1.900	0.700
OPERATING ENGINEER		FLT	1	47.250	47.250	1.5	1.5	2.0	6.850	5.600	1.900	0.000
OPERATING ENGINEER		FLT	2	45.750	47.250	1.5	1.5	2.0	6.850	5.600	1.900	0.000
OPERATING ENGINEER		FLT	3	40.700	47.250	1.5	1.5	2.0	6.850	5.600	1.900	0.000
OPERATING ENGINEER		FLT	4	33.850	47.250	1.5	1.5	2.0	6.850	5.600	1.900	0.000
OPERATING ENGINEER		HWY	1	39.750	43.750	1.5	1.5	2.0	6.850	5.600	1.900	0.700
OPERATING ENGINEER		HWY	2	39.200	43.750	1.5	1.5	2.0	6.850	5.600	1.900	0.700
OPERATING ENGINEER		HWY	3	37.150	43.750	1.5	1.5	2.0	6.850	5.600	1.900	0.700
OPERATING ENGINEER		HWY	4	35.750	43.750	1.5	1.5	2.0	6.850	5.600	1.900	0.700
OPERATING ENGINEER		HWY	5	34.550	43.750	1.5	1.5	2.0	6.850	5.600	1.900	0.700
ORNAMNTL IRON WORKER		ALL		35.600	37.600	2.0	2.0	2.0	7.500	10.84	0.000	0.750
PAINTER		ALL		34.400	38.700	1.5	1.5	1.5	6.200	6.400	0.000	0.390
PAINTER SIGNS		BLD		28.970	32.520	1.5	1.5	1.5	2.600	2.310	0.000	0.000
PILEDRIVER		ALL		36.520	38.520	1.5	1.5	2.0	7.960	5.910	0.000	0.490
PIPEFITTER		BLD		37.600	39.600	1.5	1.5	2.0	8.660	6.900	0.000	0.940
PLASTERER		BLD		31.700	32.700	1.5	1.5	2.0	6.130	8.590	0.000	0.050
PLUMBER		BLD		37.500	39.500	1.5	1.5	2.0	8.040	6.850	0.000	0.400
ROOFER		BLD		33.650	35.650	1.5	1.5	2.0	6.460	3.310	0.000	0.330
SHEETMETAL WORKER		BLD		33.400	36.070	1.5	1.5	2.0	6.460	7.850	0.000	0.590
SIGN HANGER		BLD		25.340	26.190	1.5	1.5	2.0	4.180	2.250	0.000	0.000
SPRINKLER FITTER		BLD		38.500	40.500	1.5	1.5	2.0	8.250	6.100	0.000	0.500
STEEL ERECTOR		ALL		36.250	37.750	2.0	2.0	2.0	8.970	10.77	0.000	0.300
STONE MASON		BLD		33.250	36.580	1.5	1.5	2.0	6.450	7.020	0.000	0.440
TERRAZZO FINISHER		BLD		29.290	0.000	1.5	1.5	2.0	5.650	6.940	0.000	0.270
TERRAZZO MASON		BLD		33.650	36.650	1.5	1.5	2.0	5.650	8.610	0.000	0.300
TILE MASON		BLD		34.600	38.600	2.0	1.5	2.0	5.650	7.000	0.000	0.460
TRAFFIC SAFETY WRKR		HWY		22.800	24.400	1.5	1.5	2.0	3.078	1.875	0.000	0.000
TRUCK DRIVER		ALL	1	29.400	29.950	1.5	1.5	2.0	5.200	5.000	0.000	0.000
TRUCK DRIVER		ALL	2	29.550	29.950	1.5	1.5	2.0	5.200	5.000	0.000	0.000

TRUCK DRIVER	ALL	3	29.750	29.950	1.5	1.5	2.0	5.200	5.000	0.000	0.000
TRUCK DRIVER	ALL	4	29.950	29.950	1.5	1.5	2.0	5.200	5.000	0.000	0.000
TUCKPOINTER	BLD		34.500	35.500	1.5	1.5	2.0	4.710	6.340	0.000	0.400

Legend:

M-F>8 (Overtime is required for any hour greater than 8 worked each day, Monday through Friday.)

OSA (Overtime is required for every hour worked on Saturday)

OSH (Overtime is required for every hour worked on Sunday and Holidays)

H/W (Health & Welfare Insurance)

Pensn (Pension)

Vac (Vacation)

Trng (Training)

## Explanations

LAKE COUNTY

The following list is considered as those days for which holiday rates of wages for work performed apply: New Years Day, Memorial/Decoration Day, Fourth of July, Day, Veterans Day, Thanksgiving Day, Christmas Day. Generally, any of these holidays which fall on a Sunday is celebrated on the following Monday. This then makes work performed on that Monday payable at the appropriate overtime rate for holiday pay. Common practice in a given local may alter certain days of celebration such as the day after Thanksgiving for Veterans Day. If in doubt, please check with IDOL.

### EXPLANATION OF CLASSES

ASBESTOS - GENERAL - removal of asbestos material/mold and hazardous materials from any place in a building, including mechanical systems where those mechanical systems are to be removed. This includes the removal of asbestos materials/mold and hazardous materials from ductwork or pipes in a building when the building is to be demolished at the time or at some close future date.

ASBESTOS - MECHANICAL - removal of asbestos material from mechanical systems, such as pipes, ducts, and boilers, where the mechanical systems are to remain.

### CERAMIC TILE FINISHER

The grouting, cleaning, and polishing of all classes of tile, whether for interior or exterior purposes, all burned, glazed or unglazed products; all composition materials, granite tiles, warning detectable tiles, cement tiles, epoxy composite materials, pavers, glass, mosaics, fiberglass, and all substitute materials, for tile made in tile-like units; all mixtures in tile like form of cement, metals, and other materials that are for and intended for use as a finished floor surface, stair treads, promenade roofs, walks, walls, ceilings, swimming pools, and all other places where tile is to form a finished

interior or exterior. The mixing of all setting mortars including but not limited to thin-set mortars, epoxies, wall mud, and any other sand and cement mixtures or adhesives when used in the preparation, installation, repair, or maintenance of tile and/or similar materials. The handling and unloading of all sand, cement, lime, tile, fixtures, equipment, adhesives, or any other materials to be used in the preparation, installation, repair, or maintenance of tile and/or similar materials. Ceramic Tile Finishers shall fill all joints and voids regardless of method on all tile work, particularly and especially after installation of said tile work. Application of any and all protective coverings to all types of tile installations including, but not be limited to, all soap compounds, paper products, tapes, and all polyethylene coverings, plywood, masonite, cardboard, and any new type of products that may be used to protect tile installations, Blastrac equipment, and all floor scarifying equipment used in preparing floors to receive tile. The clean up and removal of all waste and materials. All demolition of existing tile floors and walls to be re-tiled.

#### COMMUNICATION TECHNICIAN

Low voltage construction, installation, maintenance and removal of telecommunication facilities (voice, sound, data and video) including outside plant, telephone, security systems and data inside wire, interconnect, terminal equipment, central offices, PABX, fiber optic cable and equipment, micro waves, V-SAT, bypass, CATV, WAN (wide area network), LAN (local area networks), and ISDN (integrated system digital network), pulling of wire in raceways, but not the installation of raceways.

#### MARBLE FINISHER

Loading and unloading trucks, distribution of all materials (all stone, sand, etc.), stocking of floors with material, performing all rigging for heavy work, the handling of all material that may be needed for the installation of such materials, building of scaffolding, polishing if needed, patching, waxing of material if damaged, pointing up, caulking, grouting and cleaning of marble, holding water on diamond or Carborundum blade or saw for setters cutting, use of tub saw or any other saw needed for preparation of material, drilling of holes for wires that anchor material set by setters, mixing up of molding plaster for installation of material, mixing up thin set for the installation of material, mixing up of sand to cement for the installation of material and such other work as may be required in helping a Marble Setter in the handling of all material in the erection or installation of interior marble, slate, travertine, art marble, serpentine, alberene stone, blue stone, granite and other stones (meaning as to stone any foreign or domestic materials as are specified and used in building interiors and exteriors and customarily known as stone in the trade), carrara, sanionyx, vitrolite and similar opaque glass and the laying of all marble tile, terrazzo tile, slate tile and precast tile, steps, risers treads, base, or any other materials that may be used as substitutes for any of the aforementioned materials and which are used on interior and exterior which are installed in a similar manner.

MATERIAL TESTER I: Hand coring and drilling for testing of materials; field inspection of uncured concrete and asphalt.

MATERIAL TESTER II: Field inspection of welds, structural steel, fireproofing, masonry, soil, facade, reinforcing steel, formwork, cured concrete, and concrete and asphalt batch plants; adjusting proportions of bituminous mixtures.

TRAFFIC SAFETY - work associated with barricades, horses and drums used to reduce lane usage on highway work, the installation and removal of temporary lane markings, and the installation and removal of temporary road signs.

#### TRUCK DRIVER - BUILDING, HEAVY AND HIGHWAY CONSTRUCTION

Class 1. Two or three Axle Trucks. A-frame Truck when used for transportation purposes; Air Compressors and Welding Machines, including those pulled by cars, pick-up trucks and tractors; Ambulances; Batch Gate Lockers; Batch Hopperman; Car and Truck Washers; Carry-alls; Fork Lifts and Hoisters; Helpers; Mechanics Helpers and Greasers; Oil Distributors 2-man operation; Pavement Breakers; Pole Trailer, up to 40 feet; Power Mower Tractors; Self-propelled Chip Spreader; Skipman; Slurry Trucks, 2-man operation; Slurry Truck Conveyor Operation, 2 or 3 man; Teamsters; Unskilled dumpman; and Truck Drivers hauling warning lights, barricades, and portable toilets on the job site.

Class 2. Four axle trucks; Dump Crets and Adgetors under 7 yards; Dumpsters, Track Trucks, Euclids, Hug Bottom Dump Turnapulls or Turnatrailers when pulling other than self-loading equipment or similar equipment under 16 cubic yards; Mixer Trucks under 7 yards; Ready-mix Plant Hopper Operator, and Winch Trucks, 2 Axles.

Class 3. Five axle trucks; Dump Crets and Adgetors 7 yards and over; Dumpsters, Track Trucks, Euclids, Hug Bottom Dump Turnatrailers or turnapulls when pulling other than self-loading equipment or similar equipment over 16 cubic yards; Explosives and/or Fission Material Trucks; Mixer Trucks 7 yards or over; Mobile Cranes while in transit; Oil Distributors, 1-man operation; Pole Trailer, over 40 feet; Pole and Expandable Trailers hauling material over 50 feet long; Slurry trucks, 1-man operation; Winch trucks, 3 axles or more; Mechanic--Truck Welder and Truck Painter.

Class 4. Six axle trucks; Dual-purpose vehicles, such as mounted crane trucks with hoist and accessories; Foreman; Master Mechanic; Self-loading equipment like P.B. and trucks with scoops on the front.

#### OPERATING ENGINEERS - BUILDING

Class 1. Mechanic; Asphalt Plant; Asphalt Spreader; Autograde; Backhoes with Caisson attachment; Batch Plant; Benoto; Boiler and Throttle Valve; Caisson Rigs; Central Redi-Mix Plant; Combination Back Hoe Front End-loader Machine; Compressor and Throttle Valve; Concrete Breaker (Truck Mounted); Concrete Conveyor; Concrete Paver; Concrete Placer; Concrete Placing Boom; Concrete Pump (Truck Mounted); Concrete Tower; Cranes, All; Cranes, Hammerhead; Cranes, (GCI and similar Type); Creter Crane; Crusher, Stone, etc.; Derricks, All; Derricks, Traveling; Formless Curb and Gutter Machine; Grader, Elevating; Grouting Machines; Highlift Shovels or Front Endloader 2-1/4 yd. and over; Hoists, Elevators, outside type rack and pinion and similar machines; Hoists, one, two and three Drum; Hoists, Two Tugger One Floor; Hydraulic Backhoes; Hydraulic Boom Trucks; Hydro Vac (and similar equipment); Locomotives, All; Motor Patrol; Pile Drivers and Skid Rig; Post Hole Digger; Pre-Stress Machine; Pump Cretes Dual Ram; Pump Cretes; Squeeze Cretes-screw Type Pumps; Raised and Blind Hole Drill; Roto Mill Grinder; Scoops - Tractor Drawn; Slip-form Paver; Straddle Buggies; Tournapull; Tractor with Boom and Side Boom; Trenching Machines.

Class 2. Boilers; Broom, All Power Propelled; Bulldozers; Concrete Mixer (Two Bag and Over); Conveyor, Portable; Forklift Trucks; Greaser Engineer; Highlift Shovels or Front Endloaders under 2-1/4



yd.; Hoists, Automatic; Hoists, inside Freight Elevators; Hoists, Sewer Dragging Machine; Hoists, Tugger Single Drum; Laser Screed; Rock Drill (self-propelled); Rock Drill (truck mounted); Rollers, All; Steam Generators; Tractors, All; Tractor Drawn Vibratory Roller; Winch Trucks with "A" Frame.

Class 3. Air Compressor; Combination - Small Equipment Operator; Generators; Heaters, Mechanical; Hoists, Inside Elevators - (Rheostat Manual Controlled); Hydraulic Power Units (Pile Driving, Extracting, and Drilling); Pumps, over 3" (1 to 3 not to exceed a total of 300 ft.); Pumps, Well Points; Welding Machines (2 through 5); Winches, 4 small Electric Drill Winches; Bobcat (up to and including 3/4 cu. yd.).

Class 4. Bobcats and/or other Skid Steer Loaders; Oilers; and Brick Forklift.

#### OPERATING ENGINEERS - FLOATING

Class 1. Craft foreman (Master Mechanic), diver/wet tender, engineer (hydraulic dredge).

Class 2. Crane/backhoe operator, mechanic/welder, assistant engineer (hydraulic dredge), leverman (hydraulic dredge), and diver tender.

Class 3. Deck equipment operator (machineryman), maintenance of crane (over 50 ton capacity) or backhoe (96,000 pounds or more), tug/launch operator, loader, dozer and like equipment on barge, breakwater wall, slip/dock or scow, deck machinery, etc.

Class 4. Deck equipment operator (machineryman/fireman), (4 equipment units or more) and crane maintenance 50 ton capacity and under or backhoe weighing 96,000 pounds or less, assistant tug operator.

#### OPERATING ENGINEERS - HEAVY AND HIGHWAY CONSTRUCTION

Class 1. Craft Foreman; Asphalt Plant; Asphalt Heater and Planer Combination; Asphalt Heater Scarfire; Asphalt Spreader; Autograder/GOMACO or other similar type machines; ABG Paver; Backhoes with Caisson attachment; Ballast Regulator; Belt Loader; Caisson Rigs; Car Dumper; Central Redi-Mix Plant; Combination Backhoe Front Endloader Machine, (1 cu. yd. Backhoe Bucket or over or with attachments); Concrete Breaker (Truck Mounted); Concrete Conveyor; Concrete Paver over 27E cu. ft.; Concrete Placer; Concrete Tube Float; Cranes, all attachments; Cranes, Hammerhead, Linden, Peco & Machines of a like nature; Crete Crane; Crusher, Stone, etc.; Derricks, All; Derrick Boats; Derricks, Traveling; Dowell machine with Air Compressor; Dredges; Field Mechanic-Welder; Formless Curb and Gutter Machine; Gradall and Machines of a like nature; Grader, Elevating; Grader, Motor Grader, Motor Patrol, Auto Patrol, Form Grader, Pull Grader, Subgrader; Guard Rail Post Driver Mounted; Hoists, One, Two and Three Drum; Hydraulic Backhoes; Backhoes with shear attachments; Mucking Machine; Pile Drivers and Skid Rig; Pre-Stress Machine; Pump Cretes Dual Ram; Rock Drill - Crawler or Skid Rig; Rock Drill - Truck Mounted; Roto Mill Grinder; Slip-Form Paver; Soil Test Drill Rig (Truck Mounted); Straddle Buggies; Hydraulic Telescoping Form (Tunnel); Tractor Drawn Belt Loader (with attached pusher - two engineers); Tractor with Boom; Tractaire with Attachments; Trenching Machine; Truck Mounted Concrete Pump with Boom; Raised or Blind Hole; Drills (Tunnel Shaft); Underground Boring and/or Mining Machines; Wheel Excavator; Widener (APSCO).

Class 2. Batch Plant; Bituminous Mixer; Boiler and Throttle Valve; Bulldozers; Car Loader Trailing Conveyors; Combination Backhoe Front Endloader Machine (less than 1 cu. yd. Backhoe Bucket or over or with

attachments); Compressor and Throttle Valve; Compressor, Common Receiver (3); Concrete Breaker or Hydro Hammer; Concrete Grinding Machine; Concrete Mixer or Paver 7S Series to and including 27 cu. ft.; Concrete Spreader; Concrete Curing Machine, Burlap Machine, Belting Machine and Sealing Machine; Concrete Wheel Saw; Conveyor Muck Cars (Haglund or Similar Type); Drills, All; Finishing Machine - Concrete; Greaser Engineer; Highlift Shovels or Front Endloader; Hoist - Sewer Dragging Machine; Hydraulic Boom Trucks (All Attachments); Hydro-Blaster; All Locomotives, Dinky; Pump Cretes; Squeeze Cretes-Screw Type Pumps, Gypsum Bulker and Pump; Roller, Asphalt; Rotary Snow Plows; Rototiller, Seaman, etc., self-propelled; Scoops - Tractor Drawn; Self-Propelled Compactor; Spreader - Chip - Stone, etc.; Scraper; Scraper - Prime Mover in Tandem (Regardless of Size); Tank Car Heater; Tractors, Push, Pulling Sheeps Foot, Disc, Compactor, etc.; Tug Boats.

Class 3. Boilers; Brooms, All Power Propelled; Cement Supply Tender; Compressor, Common Receiver (2); Concrete Mixer (Two Bag and Over); Conveyor, Portable; Farm-Type Tractors Used for Mowing, Seeding, etc.; Fireman on Boilers; Forklift Trucks; Grouting Machine; Hoists, Automatic; Hoists, All Elevators; Hoists, Tugger Single Drum; Jeep Diggers; Pipe Jacking Machines; Post-Hole Digger; Power Saw, Concrete Power Driven; Pug Mills; Rollers, other than asphalt; Seed and Straw Blower; Steam Generators; Stump Machine; Winch Trucks with "A" Frame; Work Boats; Tamper - Form-Motor Driven.

Class 4. Air Compressor; Combination - Small Equipment Operator; Directional Boring Machine; Generators; Heaters, Mechanical; Hydraulic Power Unit (Pile Driving, Extracting, or Drilling); Hydro-Blaster; Light Plants, All (1 through 5); Pumps, over 3" (1 to 3 not to exceed a total of 300 ft.); Pumps, Well Points; Tractaire; Welding Machines (2 through 5); Winches, 4 Small Electric Drill Winches.

Class 5. Bobcats (all); Brick Forklifts; Oilers.

#### TERRAZZO FINISHER

The handling of sand, cement, marble chips, and all other materials that may be used by the Mosaic Terrazzo Mechanic, and the mixing, grinding, grouting, cleaning and sealing of all Marble, Mosaic, and Terrazzo work, floors, base, stairs, and wainscoting by hand or machine, and in addition, assisting and aiding Marble, Masonic, and Terrazzo Mechanics.

#### Other Classifications of Work:

For definitions of classifications not otherwise set out, the Department generally has on file such definitions which are available. If a task to be performed is not subject to one of the classifications of pay set out, the Department will upon being contacted state which neighboring county has such a classification and provide such rate, such rate being deemed to exist by reference in this document. If no neighboring county rate applies to the task, the Department shall undertake a special determination, such special determination being then deemed to have existed under this determination. If a project requires these, or any classification not listed, please contact IDOL at 618/993-7271 for wage rates or clarifications.

#### LANDSCAPING

Landscaping work falls under the existing classifications for laborer, operating engineer and truck driver. The work performed by landscape

plantsman and landscape laborer is covered by the existing classification of laborer. The work performed by landscape operators (regardless of equipment used or its size) is covered by the classifications of operating engineer. The work performed by landscape truck drivers (regardless of size of truck driven) is covered by the classifications of truck driver.

# La Salle County Prevailing Wage for April 2007

Trade Name	RG	TYP	C	Base	FRMAN	*M-F>8	OSA	OSH	H/W	Pensn	Vac	Trng
=====	==	==	=	=====	=====	=====	==	==	=====	=====	=====	=====
ASBESTOS ABT-GEN		ALL		25.460	26.460	1.5	1.5	2.0	5.850	4.500	0.000	0.600
ASBESTOS ABT-MEC		BLD		23.300	24.800	1.5	1.5	2.0	7.860	4.910	0.000	0.000
BOILERMAKER		BLD		30.970	33.970	2.0	2.0	2.0	8.270	7.740	0.000	0.300
BRICK MASON		BLD		29.500	30.500	1.5	1.5	5.0	6.070	6.000	0.000	0.400
CARPENTER		BLD		27.220	28.720	1.5	1.5	2.0	5.810	8.170	0.000	0.570
CARPENTER		HWY		26.480	28.230	1.5	1.5	2.0	5.810	7.670	0.000	0.500
CEMENT MASON		ALL		30.000	31.000	2.0	2.0	2.0	5.500	5.390	0.000	0.100
CERAMIC TILE FNSHER		BLD		24.860	0.000	1.5	1.5	2.0	5.500	4.000	0.000	0.360
COMMUNICATION TECH		BLD		29.110	30.610	1.5	1.5	2.0	8.270	8.670	0.000	0.290
ELECTRIC PWR EQMT OP		ALL		30.750	0.000	1.5	1.5	2.0	4.750	8.610	0.000	0.000
ELECTRIC PWR GRNDMAN		ALL		21.090	0.000	1.5	1.5	2.0	4.750	5.905	0.000	0.000
ELECTRIC PWR LINEMAN		ALL		34.160	36.350	1.5	1.5	2.0	4.750	9.560	0.000	0.000
ELECTRIC PWR TRK DRV		ALL		22.130	0.000	1.5	1.5	2.0	4.750	6.200	0.000	0.000
ELECTRICIAN	N	BLD		35.100	38.260	1.5	1.5	2.0	8.570	11.04	0.000	0.350
ELECTRICIAN	S	BLD		32.010	34.010	1.5	1.5	2.0	5.150	5.410	0.000	0.480
ELEVATOR CONSTRUCTOR		BLD		34.190	38.460	2.0	2.0	2.0	8.275	6.060	2.050	0.000
GLAZIER		BLD		26.320	27.070	1.5	1.5	2.0	5.650	5.750	0.000	0.350
HT/FROST INSULATOR		BLD		33.300	35.050	1.5	1.5	2.0	7.860	8.610	0.000	0.310
IRON WORKER		ALL		28.000	29.000	2.0	2.0	2.0	8.040	11.85	0.000	0.550
LABORER		ALL		24.460	25.460	1.5	1.5	2.0	5.850	4.500	0.000	0.600
LABORER, SKILLED		BLD		24.860	25.860	1.5	1.5	2.0	5.850	4.500	0.000	0.600
LABORER, SKILLED		HWY		24.860	25.860	1.5	1.5	2.0	5.850	4.500	0.000	0.600
LATHER		BLD		27.220	28.720	1.5	1.5	2.0	5.810	8.170	0.000	0.570
MACHINIST		BLD		36.890	38.890	2.0	2.0	2.0	4.380	5.650	2.550	0.000
MARBLE FINISHERS		BLD		24.860	0.000	1.5	1.5	2.0	5.500	4.000	0.000	0.360
MARBLE MASON		BLD		28.140	28.390	1.5	1.5	2.0	5.500	5.220	0.000	0.380
MILLWRIGHT		HWY		17.100	18.350	1.5	1.5	2.0	1.450	1.500	0.000	0.000
MILLWRIGHT	E	BLD		32.000	35.200	1.5	1.5	2.0	6.100	9.250	0.000	0.560
MILLWRIGHT	W	BLD		32.000	35.200	1.5	1.5	2.0	6.100	9.250	0.000	0.560
OPERATING ENGINEER		BLD	1	39.750	43.750	2.0	2.0	2.0	6.850	5.600	1.900	0.700
OPERATING ENGINEER		BLD	2	38.450	43.750	2.0	2.0	2.0	6.850	5.600	1.900	0.700
OPERATING ENGINEER		BLD	3	35.900	43.750	2.0	2.0	2.0	6.850	5.600	1.900	0.700
OPERATING ENGINEER		BLD	4	34.150	43.750	2.0	2.0	2.0	6.850	5.600	1.900	0.700
OPERATING ENGINEER		HWY	1	39.750	43.750	1.5	1.5	2.0	6.850	5.600	1.900	0.700
OPERATING ENGINEER		HWY	2	39.200	43.750	1.5	1.5	2.0	6.850	5.600	1.900	0.700
OPERATING ENGINEER		HWY	3	37.150	43.750	1.5	1.5	2.0	6.850	5.600	1.900	0.700
OPERATING ENGINEER		HWY	4	35.750	43.750	1.5	1.5	2.0	6.850	5.600	1.900	0.700
OPERATING ENGINEER		HWY	5	34.550	43.750	1.5	1.5	2.0	6.850	5.600	1.900	0.700
PAINTER		ALL		26.850	27.850	1.5	1.5	1.5	5.650	5.750	0.000	0.350
PAINTER SIGNS		BLD		28.970	32.520	1.5	1.5	1.5	2.600	2.310	0.000	0.000
PILEDRIVER		BLD		27.470	28.970	1.5	1.5	2.0	5.810	8.170	0.000	0.570
PILEDRIVER		HWY		26.480	28.230	1.5	1.5	2.0	5.810	7.670	0.000	0.500
PIPEFITTER		BLD		37.600	39.600	1.5	1.5	2.0	8.660	6.900	0.000	0.940
PLASTERER	N	BLD		30.000	31.000	2.0	2.0	2.0	5.500	5.390	0.000	0.100
PLASTERER	S	BLD		33.850	35.350	1.5	1.5	2.0	6.740	7.100	0.000	0.400
PLUMBER		BLD		37.500	39.500	1.5	1.5	2.0	7.050	8.500	0.000	0.760
ROOFER		BLD		26.560	27.560	1.5	1.5	2.0	6.460	3.310	0.000	0.330
SHEETMETAL WORKER		BLD		29.890	31.140	1.5	1.5	2.0	5.770	6.730	0.000	0.200
SPRINKLER FITTER		BLD		31.240	33.240	1.5	1.5	2.0	6.500	5.350	0.000	0.250
STONE MASON		BLD		29.500	30.500	1.5	1.5	5.0	6.070	6.000	0.000	0.400
TERRAZZO FINISHER		BLD		24.860	0.000	1.5	1.5	2.0	5.500	4.000	0.000	0.360
TILE LAYER		BLD		27.220	28.720	1.5	1.5	2.0	5.810	8.170	0.000	0.570
TILE MASON		BLD		28.140	28.390	1.5	1.5	2.0	5.500	5.220	0.000	0.380
TRUCK DRIVER		ALL	1	25.787	0.000	1.5	1.5	2.0	7.250	3.317	0.000	0.000
TRUCK DRIVER		ALL	2	26.187	0.000	1.5	1.5	2.0	7.250	3.317	0.000	0.000
TRUCK DRIVER		ALL	3	26.387	0.000	1.5	1.5	2.0	7.250	3.317	0.000	0.000
TRUCK DRIVER		ALL	4	26.637	0.000	1.5	1.5	2.0	7.250	3.317	0.000	0.000
TRUCK DRIVER		ALL	5	27.387	0.000	1.5	1.5	2.0	7.250	3.317	0.000	0.000

TRUCK DRIVER	O&C 1	20.630	0.000	1.5	1.5	2.0	7.250	3.317	0.000	0.000
TRUCK DRIVER	O&C 2	20.950	0.000	1.5	1.5	2.0	7.250	3.317	0.000	0.000
TRUCK DRIVER	O&C 3	21.110	0.000	1.5	1.5	2.0	7.250	3.317	0.000	0.000
TRUCK DRIVER	O&C 4	21.310	0.000	1.5	1.5	2.0	7.250	3.317	0.000	0.000
TRUCK DRIVER	O&C 5	21.910	0.000	1.5	1.5	2.0	7.250	3.317	0.000	0.000
TUCKPOINTER	BLD	29.500	30.500	1.5	1.5	5.0	6.070	6.000	0.000	0.400

Legend:

M-F>8 (Overtime is required for any hour greater than 8 worked each day, Monday through Friday.)

OSA (Overtime is required for every hour worked on Saturday)

OSH (Overtime is required for every hour worked on Sunday and Holidays)

H/W (Health & Welfare Insurance)

Pensn (Pension)

Vac (Vacation)

Trng (Training)

## Explanations

### LASALLE COUNTY

ELECTRICIANS (NORTH) - Townships of Mendota, Meriden, Earl, Adams, Troy Grove, Ophir, Northville, Freedom, Serena, Mission, Dimmick, Waltham, Wallace, Dayton, Rutland, Miller, Manlius, Peru, LaSalle, Utica, Ottawa, South Ottawa, Eden, Vermilion, Deer Park, Farm Ridge.

MILLWRIGHTS (EAST) - The Eastern 1/3 of the county (approx.).

The following list is considered as those days for which holiday rates of wages for work performed apply: New Years Day, Memorial/Decoration Day, Fourth of July, Labor Day, Veterans Day, Thanksgiving Day, Christmas Day. Generally, any of these holidays which fall on a Sunday is celebrated on the following Monday. This then makes work performed on that Monday payable at the appropriate overtime rate for holiday pay. Common practice in a given local may alter certain days of celebration such as the day after Thanksgiving for Veterans Day. If in doubt, please check with IDOL.

Oil and chip resealing (O&C) means the application of road oils and liquid asphalt to coat an existing road surface, followed by application of aggregate chips or gravel to coated surface, and subsequent rolling of material to seal the surface.

### EXPLANATION OF CLASSES

ASBESTOS - GENERAL - removal of asbestos material/mold and hazardous materials from any place in a building, including mechanical systems where those mechanical systems are to be removed. This includes the removal of asbestos materials/mold and hazardous materials from ductwork or pipes in a building when the building is to be demolished at the time or at some close future date.

ASBESTOS - MECHANICAL - removal of asbestos material from mechanical systems, such as pipes, ducts, and boilers, where the mechanical

systems are to remain.

#### CERAMIC TILE FINISHER, MARBLE FINISHER, TERRAZO FINISHER

Assisting, helping or supporting the tile, marble and terrazzo mechanic by performing their historic and traditional work assignments required to complete the proper installation of the work covered by said crafts. The term "Ceramic" is used for naming the classification only and is in no way a limitation of the product handled. Ceramic takes into consideration most hard tiles.

#### COMMUNICATIONS TECHNICIAN

Installation, operation, inspection, maintenance, repair and service of radio, television, recording, voice, sound and vision production and reproduction, telephone and telephone interconnect, facsimile, equipment and appliances used for domestic, commercial, educational and entertainment purposes, pulling of wire through conduit but not the installation of conduit.

#### LABORER, SKILLED - BUILDING AND HIGHWAY

The skilled laborer building (BLD) and heavy & highway (HWY) classification shall encompass the following types of work, irrespective of the site of the work: flagging, caisson worker plus depth, gunnite nozzle men, lead man on sewer work, welders, cutter burners and torchmen, chain saw operator, paving breaker, jackhammer and drill operators, layout man and/or drainage tile layer, steel form setter - street and highway, air tamping hammerman, signal man on crane, concrete saw operator, concrete saw operator walk behind, screenman on asphalt pavers, front end man on chip spreader, laborers tending masons with hot material or where foreign materials are used, multiple concrete duct - leadman, luteman, asphalt raker, curb asphalt machine operator, ready mix scalemen (permanent, portable or temporary plant), laborers handling masterplate or similar materials, laser beam operator, coring machine operator, plaster tenders, underpinning and shoring of buildings, material selector when working with fire-brick or castable material, fire watch, signaling of all power equipment, tree topper or trimmer when in connection with construction, and diver tender.

#### TRUCK DRIVER - BUILDING, HEAVY AND HIGHWAY CONSTRUCTION

Class 1. Drivers on 2 axle trucks hauling less than 9 ton. Air compressor and welding machines and brooms, including those pulled by separate units, truck driver helpers, warehouse employees, mechanic helpers, greasers and tiremen, pickup trucks when hauling materials, tools, or workers to and from and on-the-job site, and fork lifts up to 6,000 lb. capacity.

Class 2. Two or three axle trucks hauling more than 9 ton but hauling less than 16 ton. A-frame winch trucks, hydrolift trucks, vector trucks or similar equipment when used for transportation purposes. Fork lifts over 6,000 lb. capacity, winch trucks, four axle combination units, and ticket writers.

Class 3. Two, three or four axle trucks hauling 16 ton or more. Drivers on water pulls, articulated dump trucks, mechanics and working forepersons, and dispatchers. Five axle or more combination units.

Class 4. Low Boy and Oil Distributors.

Class 5. Drivers who require special protective clothing while employed on hazardous waste work.

TRUCK DRIVER - OIL AND CHIP RESEALING ONLY.

This shall encompass laborers, workers and mechanics who drive contractor or subcontractor owned, leased, or hired pickup, dump, service, or oil distributor trucks. The work includes transporting materials and equipment (including but not limited to, oils, aggregate supplies, parts, machinery and tools) to or from the job site; distributing oil or liquid asphalt and aggregate; stock piling material when in connectin with the actual oil and chip contract. The Truck Driver (Oil & Chip Resealing) wage classification does not include supplier delivered materials.

OPERATING ENGINEERS - BUILDING

Class 1. Assistant Craft Foreman; Craft Foreman; Mechanic; Asphalt Plant; Asphalt Spreader; Autograde; Backhoes w/Caisson attachment; Batch Plant; Benoto; Boiler and Throttle Valve; Caisson Rigs; Central Redi-Mix Plant; Combination Back Hoe Front End-loader Machine; Compressor and Throttle Valve; Concrete Breaker (Truck Mounted); Concrete Conveyor; Concrete Paver; Concrete Placer; Concrete Pump (Truck Mounted); Concrete Tower; Cranes, All; Cranes, Hammerhead; Creter Crane; Crusher, Stone, etc.; Derricks, All; Derricks, Traveling; Formless Curb and Gutter Machine; Grader, Elevating; Grouting Machines; Highlift Shovels or Front Endloader 2-1/4 yd. and over; Hoists, Elevators, outside type rack and pinion and similar machines; Hoists, one, two and three Drum; Hoists, Two tigger One Floor; Hydraulic Backhoes; Hydraulic Boom Trucks; Hydro Vac (and similar equipment.); Locomotives, All; Motor Patrol; Pile Drivers and Skid Rig; Post Hole Digger; Pre-Stress Machine; Pump Cretes; Squeeze Cretes-screw Type Pumps; Gypsum Bulker and Pump; Roto Mill Grinder; Scoops - Tractor Drawn; Slip-form Paver; Straddle Buggies; Tournapull; Tractor with Boom and Side Boom; Trenching Machines.

Class 2. Boilers; Broom, All Power Propelled; Bulldozers; Concrete Mixer (Two Bag and Over); Conveyor, Portable; Forklift Trucks; Greaser Engineer; Highlift Shovels or Front Endloaders under 2-1/4 yd.; Hoists, Automatic; Hoists, inside Freight Elevators; Hoists, Sewer Dragging Machine; Hoists, Tigger Single Drum; Laser Screed; Rock Drill (self-propelled); Rock Drill (Truck mounted); Rollers, All; Steam Generators; Tractors, All; Tractor Drawn Vibratory Roller; Winch Trucks with "A" Frame.

Class 3. Air Compressors; Combination - Small Equipment Operator; Generators; Heaters, Mechanical; Hoists, Inside Elevators - (Rheostat Manual Controlled); Hoists, Inside Elevators; Hydraulic Power Units (Pile Driving and Extracting); Vibratory Roller; Lowboys; Pumps, over 3" (1 to 3 not to exceed a total of 300 ft.); Pumps, Well Points; Welding Machines (2 through 5); Winches, 4 small Electric Drill Winches.

Class 4. Bobcat/Skid Steer Loader; Brick Forklift; Hoists, Inside Elevators push button with automatic doors; Oilers.

OPERATING ENGINEERS - HEAVY AND HIGHWAY CONSTRUCTION

Class 1. Craft Foreman; Asphalt Plant; Asphalt Heater and Planer Combination; Asphalt Heater Scarfire; Asphalt Spreader; Autograder; ABC Paver; Backhoes with Caisson Attachment; Belt Loader; Caisson Rigs; Car Dumper; Central Redi-Mix Plant; Combination Backhoe Front Endloader Machine, (1 cu. yd. Backhoe Bucket or over or with attachments); Concrete Breaker (Truck Mounted); Concrete Conveyor;

Concrete Paver over 27E cu. ft.; Concrete Placer; Concrete Tube Float; Cranes, all attachments; Cranes, Hammerhead, Linden, Peco & Machines of a like nature; Creter Crane; Crusher, Stone, etc.; Derricks, All; Derrick Boats; Derricks, Traveling; Dowell Machine; Dredges; Field Mechanic-Welder; Formless Curb and Gutter Machine; Gradall and Machines of a like nature; Grader, Elevating; Grader, Motor Grader, Motor Patrol, Auto Patrol, Form Grader, Pull Grader, Subgrader; Guard Rail Post Driver Truck Mounted; Hoists, One, Two and Three Drum; Hydraulic Backhoes; Mucking Machine; Pile Drivers and Skid Rig; Pre-Stress Machine; Pump Cretes Dual Ram; Rock/Track Tamper; Rock Drill - Truck Mounted; Roto Mill Grinder; Slip-Form Paver; Soil Test Drill Rig (Truck Mounted); Straddle Buggies; Hydraulic Telescoping form (Tunnel); Tractor Drawn Belt Loader with attached pusher; Tractor with Boom; Tractaire with Attachments; Trenching Machine; Truck Mounted Concrete Pump with Boom; Raised or Blind Hole; Drills (Tunnel Shaft); Underground Boring and/or Mining Machines; Wheel Excavator; Widener (APSCO).

Class 2. Batch Plant; Bituminous Mixer; Boiler and Throttle Valve; Bulldozers; Car Loader Trailing Conveyors; Combination Backhoe Front Endloader Machine (less than 1 cu. yd. Backhoe Bucket or over or with attachments); Compressor and Throttle Valve; Compressor, Common Receiver (3); Concrete Breaker or Hydro Hammer; Concrete Grinding Machine; Concrete Mixer or Paver 7S Series to and including 27 cu. ft.; Concrete Spreader; Concrete Curing Machine, Burlap Machine, Belting Machine and Sealing Machine; Concrete Wheel Saw; Conveyor Muck Cars (Haglund or Similar Type); Drills, All; Finishing Machine - Concrete; Greaser Engineer; Highlift Shovels or Front Endloader; Hoist - Sewer Dragging Machine; Hydraulic Boom Trucks (All Attachments); Hydro-Blaster; Locomotives, Dinky; Laser Screed; Pump Cretes; Squeeze Cretes-Screw Type Pumps, Gypsum Bulker and Pump; Rock Drill - Crawler or Skid Rig; Rock Drill - Truck Mounted; Roller, Asphalt; Rotary Snow Plows; Rototiller, Seaman, etc., self-propelled; Scoops - Tractor Drawn; Self-Propelled Compactor; Spreader - Chip - Stone, etc.; Scraper; Scraper - Prime Mover in Tandem; Tank Car Heater; Tractors, Push, Pulling Sheeps Foot, Disc, Compactor, etc. Tug Boats.

Class 3. Boilers; Brooms, All Power Propelled; Cement Supply Tender; Compressor, Common Receiver (2); Concrete Mixer (Two Bag and Over); Conveyor, Portable; Farm-Type Tractors Used for Mowing, Seeding, etc.; Fireman on Boilers; Forklift Trucks; Grouting Machine; Hoists, Automatic; Hoists, All Elevators; Hoists, Tugger Single Drum; Jeep Diggers; Pipe Jacking Machines; Post-Hole Digger; Power Saw, Concrete Power Driven; Pug Mills; Rollers, other than asphalt; Seed and Straw Blower; Steam Generators; Stump Machine; Winch Trucks with "A" Frame; Work Boats; Tamper - Form-Motor Driven.

Class 4. Air Compressor; Combination - Small Equipment Operator; Directional Boring Machine; Generators; Heaters, Mechanical; Hydraulic Power Unit (Pile Driving, Extracting, or Drilling); Hydro-Blaster; Light Plants, All (1 through 5); Pumps, over 3" (1 to 3 not to exceed a total of 300 ft.); Pumps; Tractaire; Welding Machines (2 through 5); Winches.

Class 5. Bobcats (All); Brick Forklifts; Oilers. Other Classifications of Work:

For definitions of classifications not otherwise set out, the Department generally has on file such definitions which are available. If a task to be performed is not subject to one of the classifications of pay set out, the Department will upon being contacted state which neighboring county has such a classification and



provide such rate, such rate being deemed to exist by reference in this document. If no neighboring county rate applies to the task, the Department shall undertake a special determination, such special determination being then deemed to have existed under this determination. If a project requires these, or any classification not listed, please contact IDOL at 618/993-7271 for wage rates or clarifications.

#### LANDSCAPING

Landscaping work falls under the existing classifications for laborer, operating engineer and truck driver. The work performed by landscape plantsman and landscape laborer is covered by the existing classification of laborer. The work performed by landscape operators (regardless of equipment used or its size) is covered by the classifications of operating engineer. The work performed by landscape truck drivers (regardless of size of truck driven) is covered by the classifications of truck driver.

# Lawrence County Prevailing Wage for April 2007

Trade Name	RG	TYP	C	Base	FRMAN	*M-F>8	OSA	OSH	H/W	Pensn	Vac	Trng
ASBESTOS ABT-GEN		ALL		20.750	21.200	1.5	1.5	2.0	5.250	5.600	0.000	0.700
ASBESTOS ABT-MEC		BLD		20.800	0.000	2.0	2.0	2.0	5.000	3.400	0.000	0.000
BOILERMAKER		BLD		28.500	31.000	1.5	1.5	2.0	6.820	11.03	0.000	0.300
BRICK MASON		BLD		25.470	26.970	1.5	1.5	2.0	6.000	5.400	0.000	0.425
CARPENTER		BLD		27.780	29.280	1.5	1.5	2.0	5.050	3.750	0.000	0.350
CARPENTER		HWY		27.730	29.480	1.5	1.5	2.0	5.050	3.750	0.000	0.350
CEMENT MASON		BLD		25.830	27.080	1.5	1.5	2.0	5.200	7.000	0.000	0.300
CEMENT MASON		HWY		22.400	23.900	1.5	1.5	2.0	5.200	3.850	0.000	0.200
CERAMIC TILE FNSHER		BLD		24.990	0.000	1.5	1.5	2.0	6.000	5.400	0.000	0.425
COMM SYSTEMS TECH		BLD		23.350	25.700	1.5	1.5	2.0	5.150	4.310	0.000	0.000
ELECTRICIAN		BLD		29.090	31.130	1.5	1.5	2.0	5.150	5.530	0.000	0.290
FLOOR LAYER		BLD		26.930	27.680	1.5	1.5	2.0	5.000	3.750	0.000	0.350
GLAZIER		BLD		22.930	0.000	1.5	1.5	2.0	4.320	3.800	0.000	0.300
HT/FROST INSULATOR		BLD		26.110	27.110	1.5	1.5	2.0	4.800	6.860	0.000	0.190
IRON WORKER		ALL		24.000	25.250	1.5	1.5	2.0	5.780	6.850	0.000	0.345
LABORER		BLD		20.750	21.200	1.5	1.5	2.0	5.250	5.600	0.000	0.600
LABORER		HWY		21.000	21.450	1.5	1.5	2.0	5.350	6.150	0.000	0.600
MACHINIST		BLD		36.890	38.890	2.0	2.0	2.0	4.380	5.650	2.550	0.000
MARBLE FINISHERS		BLD		24.990	0.000	1.5	1.5	2.0	6.000	5.400	0.000	0.425
MARBLE MASON		BLD		25.470	26.970	1.5	1.5	2.0	6.000	5.400	0.000	0.425
MILLWRIGHT		BLD		27.780	29.280	1.5	1.5	2.0	5.050	3.750	0.000	0.350
MILLWRIGHT		HWY		28.230	29.980	1.5	1.5	2.0	5.050	3.750	0.000	0.350
OPERATING ENGINEER		ALL	1	28.650	0.000	1.5	1.5	2.0	5.200	6.750	0.000	0.650
OPERATING ENGINEER		ALL	2	18.600	0.000	1.5	1.5	2.0	5.200	6.750	0.000	0.650
PAINTER		ALL		23.000	24.000	1.5	1.5	2.0	5.500	6.200	0.000	0.180
PILEDRIVER		BLD		27.780	29.280	1.5	1.5	2.0	5.050	3.750	0.000	0.350
PILEDRIVER		HWY		28.230	29.980	1.5	1.5	2.0	5.050	3.750	0.000	0.350
PIPEFITTER		BLD		27.580	29.230	1.5	1.5	2.0	5.450	7.010	0.000	0.700
PLASTERER		BLD		23.940	25.440	1.5	1.5	2.0	5.200	8.200	0.000	0.300
PLUMBER		BLD		27.580	29.230	1.5	1.5	2.0	5.450	7.010	0.000	0.700
ROOFER		BLD		22.100	24.100	1.5	1.5	2.0	3.950	3.500	0.000	0.200
SHEETMETAL WORKER		BLD		27.010	28.360	1.5	1.5	2.0	6.150	5.150	0.000	0.480
SPRINKLER FITTER		BLD		31.240	33.240	1.5	1.5	2.0	6.500	5.350	0.000	0.250
STONE MASON		BLD		25.470	26.970	1.5	1.5	2.0	6.000	5.400	0.000	0.425
TERRAZZO FINISHER		BLD		24.990	0.000	1.5	1.5	2.0	6.000	5.400	0.000	0.425
TILE MASON		BLD		25.470	26.970	1.5	1.5	2.0	6.000	5.400	0.000	0.425
TRUCK DRIVER		ALL	1	25.010	0.000	1.5	1.5	2.0	6.500	2.225	0.000	0.000
TRUCK DRIVER		ALL	2	25.410	0.000	1.5	1.5	2.0	6.500	2.225	0.000	0.000
TRUCK DRIVER		ALL	3	25.610	0.000	1.5	1.5	2.0	6.500	2.225	0.000	0.000
TRUCK DRIVER		ALL	4	25.860	0.000	1.5	1.5	2.0	6.500	2.225	0.000	0.000
TRUCK DRIVER		ALL	5	26.610	0.000	1.5	1.5	2.0	6.500	2.225	0.000	0.000
TUCKPOINTER		BLD		25.470	26.970	1.5	1.5	2.0	6.000	5.400	0.000	0.425

Legend :

M-F>8 (Overtime is required for any hour greater than 8 worked each day, Monday through Friday.)

OSA (Overtime is required for every hour worked on Saturday)

OSH (Overtime is required for every hour worked on Sunday and Holidays)

H/W (Health & Welfare Insurance)

Pensn (Pension)

Vac (Vacation)

Trng (Training)

## Explanations

### LAWRENCE COUNTY

The following list is considered as those days for which holiday rates of wages for work performed apply: New Years Day, Memorial/Decoration Day, Fourth of July, Labor Day, Veterans Day, Thanksgiving Day, Christmas Day. Generally, any of these holidays which fall on a Sunday is celebrated on the following Monday. This then makes work performed on that Monday payable at the appropriate overtime rate for holiday pay. Common practice in a given local may alter certain days of celebration such as the day after Thanksgiving for Veterans Day. If in doubt, please check with IDOL.

### EXPLANATION OF CLASSES

ASBESTOS - GENERAL - removal of asbestos material/mold and hazardous materials from any place in a building, including mechanical systems where those mechanical systems are to be removed. This includes the removal of asbestos materials/mold and hazardous materials from ductwork or pipes in a building when the building is to be demolished at the time or at some close future date.

ASBESTOS - MECHANICAL - removal of asbestos material from mechanical systems, such as pipes, ducts, and boilers, where the mechanical systems are to remain.

### CERAMIC TILE FINISHER, MARBLE FINISHER, TERRAZZO FINISHER

Assisting, helping or supporting the tile, marble and terrazzo mechanic by performing their historic and traditional work assignments required to complete the proper installation of the work covered by said crafts. The term "Ceramic" is used for naming the classification only, and is in no a limitation of the product handled. Ceramic takes into consideration most hard tiles.

### COMMUNICATION SYSTEMS TECHNICIAN

Installation, operation, inspection, maintenance, repair, and service of radio, television, recording, voice sound and vision production and reproduction apparatus, equipment and appliances used for domestic, commercial, education, entertainment and private telephone systems.

### TRUCK DRIVER - BUILDING, HEAVY AND HIGHWAY CONSTRUCTION

Class 1. Drivers on 2 axle trucks hauling less than 9 ton. Air compressor and welding machines and brooms, including those pulled by separate units, truck driver helpers, warehouse employees, mechanic helpers, greasers and tiremen, pickup trucks when hauling materials, tools, or workers to and from and on-the-job site, and fork lifts up to 6,000 lb. capacity.

Class 2. Two or three axle trucks hauling more than 9 ton but hauling less than 16 ton. A-frame winch trucks, hydrolift trucks, vector trucks or similar equipment when used for transportation purposes. Fork lifts over 6,000 lb. capacity, winch trucks, four axle combination units, and ticket writers.

Class 3. Two, three or four axle trucks hauling 16 ton or more. Drivers on water pulls, articulated dump trucks, mechanics and working forepersons, and dispatchers. Five axle or more combination units.

Class 4. Low Boy and Oil Distributors.

Class 5. Drivers who require special protective clothing while employed on hazardous waste work.

#### OPERATING ENGINEERS - BUILDING, HEAVY AND HIGHWAY CONSTRUCTION

Class 1. Power Cranes, Draglines, Derricks, Shovels, Gradalls, Mechanics, Tractor Highlift, Tournadozer, Concrete Mixers with Skip, Tournamixer, Two Drum Machine, One Drum Hoist with Tower or Boom, Cableways, Tower Machines, Motor Patrol, Boom Tractor, Boom or Winch Truck, Winch or Hydraulic Boom Truck, Truck Crane, Tournapull, Tractor Operating Scoops, Bulldozer, Push Tractor, Asphalt Planer, Finishing Machine on Asphalt, Large Rollers on Earth, Rollers on Asphalt Mix, Ross Carrier or similar Machine, Gravel Processing Machine, Asphalt Plant Engineer, Paver Operator, Dredging Equipment, or Dredge Engineer, or Dredge Operator, Central Mix Plant Engineer, CMI or similar type machine, Concrete Pump, Truck or Skid Mounted, Tower Crane, Engineer or Rock Crusher Plant, Concrete Plant Engineer, Ditching Machine with dual attachment, Tractor Mounted Loaders, Cherry Picker, Hydro Crane, Standard or Dinkey Locomotives, Scoopmobiles, Euclid Loader, Soil Cement Machine, Back Filler, Elevating Machine, Power Blade, Drilling Machine, including Well Testing, Caissons, Shaft or any similar type drilling machines, Motor Driven Paint Machine, Pipe Cleaning Machine, Pipe Wrapping Machine, Pipe Bending Machine, Apsco Paver, Boring Machine, (Head Equipment Greaser), Barber-Greene Loaders, Formless Paver, (Well Point System), Concrete Spreader, Hydra Ax, Span Saw, Marine Scoops, Brush Mulcher, Brush Burner, Mesh Placer, Tree Mover, Helicopter Crew (3), Piledriver-Skid or Crawler, Stump Remover, Root Rake, Tug Boat Operator, Refrigerating Machine, Freezing Operator, Chair Cart-Self-Propelled, Hydra Seeder, Straw Blower, Power Sub Grader, Bull Float, Finishing Machine, Self-Propelled Pavement Breaker, Lull (or similar type Machine), Two Air Compressors, Compressors hooked in Manifold, Overhead Crane, Chip Spreader, Mud Cat, Sull-Air, Fork Lifts (except when used for landscaping work), Soil Stabilizer (Seaman Tiller, Bo Mag, Rago Gator, and similar types of equipment), Tube Float, Spray Machine, Curing Machine, Concrete or Asphalt Milling Machine, Snooper Truck-Operator, Backhoe, Farm Tractors (with attachments), 4 Point Lift System (Power Lift or similar type), Skid-Steer (Bob Cat or similar type), Wrecking Shears, Water Blaster.

Class 2. Concrete Mixers without Skips, Rock Crusher, Ditching Machine under 6', Curbing Machine, One Drum Machines without Tower or Boom, Air Tugger, Self-Propelled Concrete Saw, Machine Mounted Post Hole Digger, two to four Generators, Water Pumps or Welding Machines, within 400 feet, Air Compressor 600 cu. ft. and under, Rollers on Aggregate and Seal Coat Surfaces, Fork Lift (when used for landscaping work), Concrete and Blacktop Curb Machine, One Water Pump, Oilers, Air Valves or Steam Valves, One Welding Machine, Truck Jack, Mud Jack, Gunnite Machine, House Elevators when used for hoisting material, Engine Tenders, Fireman, Wagon Drill, Flex Plane, Conveyor, Siphons and Pulsometer, Switchman, Fireman on Paint Pots, Fireman on Asphalt Plants, Distributor Operator on Trucks, Tampers, Self-Propelled Power Broom, Striping Machine (motor driven), Form Tamper, Bulk Cement Plant, Equipment Greaser, Deck Hands, Truck Crane Oiler-Driver, Cement Blimps, Form Grader, Temporary Heat, Throttle Valve, Super Sucker (and similar type of equipment).

#### Other Classifications of Work:

For definitions of classifications not otherwise set out, the Department generally has on file such definitions which are available. If a task to be performed is not subject to one of the classifications of pay set out, the Department will upon being contacted state which neighboring county has such a classification and provide such rate, such rate being deemed to exist by reference in this document. If no neighboring county rate applies to the task, the Department shall undertake a special determination, such special determination being then deemed to have existed under this determination. If a project requires these, or any classification not listed, please contact IDOL at 618/993-7271 for wage rates or clarifications.

#### LANDSCAPING

Landscaping work falls under the existing classifications for laborer, operating engineer and truck driver. The work performed by landscape plantsman and landscape laborer is covered by the existing classification of laborer. The work performed by landscape operators (regardless of equipment used or its size) is covered by the classifications of operating engineer. The work performed by landscape truck drivers (regardless of size of truck driven) is covered by the classifications of truck driver.

# Lee County Prevailing Wage for April 2007

Trade Name	RG	TYP	C	Base	FRMAN	*M-F>8	OSA	OSH	H/W	Pensn	Vac	Trng
=====	==	==	=	=====	=====	=====	==	==	=====	=====	=====	=====
ASBESTOS ABT-GEN		BLD		23.760	24.760	1.5	1.5	2.0	5.850	8.730	0.000	0.600
ASBESTOS ABT-MEC		BLD		23.300	24.800	1.5	1.5	2.0	7.860	4.910	0.000	0.000
BOILERMAKER		BLD		30.970	33.970	2.0	2.0	2.0	8.270	7.740	0.000	0.300
BRICK MASON		BLD		30.000	32.500	1.5	1.5	2.0	5.500	8.680	0.000	0.420
CARPENTER		BLD		27.040	30.010	1.5	1.5	2.0	6.100	8.220	0.000	0.600
CARPENTER		HWY		27.440	29.190	1.5	1.5	2.0	6.300	7.680	0.000	0.400
CEMENT MASON		ALL		30.000	32.500	1.5	1.5	2.0	5.500	7.530	0.000	0.100
CERAMIC TILE FNSHER		BLD		24.860	0.000	1.5	1.5	2.0	5.500	4.000	0.000	0.360
COMMUNICATION TECH		BLD		28.700	30.700	1.5	1.5	2.0	8.200	8.340	0.000	0.570
ELECTRIC PWR EQMT OP		ALL		27.920	35.880	1.5	1.5	2.0	4.750	7.820	0.000	0.210
ELECTRIC PWR GRNDMAN		ALL		21.640	35.880	1.5	1.5	2.0	4.750	6.060	0.000	0.160
ELECTRIC PWR LINEMAN		ALL		33.220	35.880	1.5	1.5	2.0	4.750	9.310	0.000	0.250
ELECTRIC PWR TRK DRV		ALL		22.340	35.880	1.5	1.5	2.0	4.750	6.260	0.000	0.170
ELECTRICIAN		BLD		33.570	36.930	1.5	1.5	2.0	8.200	11.15	0.000	0.670
ELEVATOR CONSTRUCTOR		BLD		38.620	43.450	2.0	2.0	2.0	8.275	6.060	2.320	0.000
GLAZIER		BLD		27.180	28.180	1.5	1.5	2.0	5.150	5.250	0.000	0.300
HT/FROST INSULATOR		BLD		33.300	35.050	1.5	1.5	2.0	7.860	8.610	0.000	0.310
IRON WORKER	N	ALL		30.760	32.300	2.0	2.0	2.0	6.950	16.62	0.000	0.550
IRON WORKER	S	ALL		28.000	29.000	2.0	2.0	2.0	8.040	11.85	0.000	0.550
LABORER		BLD		23.760	24.760	1.5	1.5	2.0	5.850	8.730	0.000	0.600
LABORER		HWY		23.310	24.060	1.5	1.5	2.0	5.850	8.330	0.000	0.600
LABORER, SKILLED		HWY		24.710	25.460	1.5	1.5	2.0	5.850	8.330	0.000	0.600
LATHER		BLD		27.040	30.010	1.5	1.5	2.0	6.100	8.220	0.000	0.600
MACHINIST		BLD		36.890	38.890	2.0	2.0	2.0	4.380	5.650	2.550	0.000
MARBLE FINISHERS		BLD		24.860	0.000	1.5	1.5	2.0	5.500	4.000	0.000	0.360
MARBLE MASON		BLD		28.140	28.390	1.5	1.5	2.0	5.500	5.220	0.000	0.380
MATERIAL TESTER 1		ALL		21.550	0.000	1.5	1.5	2.0	7.460	4.840	0.000	0.170
MATERIALS TESTER II		ALL		26.550	0.000	1.5	1.5	2.0	7.460	4.840	0.000	0.170
MILLWRIGHT		BLD		32.000	35.200	1.5	1.5	2.0	6.100	9.250	0.000	0.560
OPERATING ENGINEER		BLD	1	37.050	41.050	2.0	2.0	2.0	6.850	6.150	1.900	0.700
OPERATING ENGINEER		BLD	2	36.350	41.050	2.0	2.0	2.0	6.850	6.150	1.900	0.700
OPERATING ENGINEER		BLD	3	33.900	41.050	2.0	2.0	2.0	6.850	6.150	1.900	0.700
OPERATING ENGINEER		BLD	4	31.900	41.050	2.0	2.0	2.0	6.850	6.150	1.900	0.700
OPERATING ENGINEER		HWY	1	36.900	40.900	1.5	1.5	2.0	6.850	6.150	1.900	0.700
OPERATING ENGINEER		HWY	2	36.350	40.900	1.5	1.5	2.0	6.850	6.150	1.900	0.700
OPERATING ENGINEER		HWY	3	35.050	40.900	1.5	1.5	2.0	6.850	6.150	1.900	0.700
OPERATING ENGINEER		HWY	4	33.600	40.900	1.5	1.5	2.0	6.850	6.150	1.900	0.700
OPERATING ENGINEER		HWY	5	32.150	40.900	1.5	1.5	2.0	6.850	6.150	1.900	0.700
PAINTER		ALL		29.650	30.650	1.5	1.5	1.5	5.650	5.750	0.000	0.350
PILEDRIVER		BLD		28.040	31.120	1.5	1.5	2.0	6.100	8.220	0.000	0.600
PILEDRIVER		HWY		27.440	29.190	1.5	1.5	2.0	6.300	7.680	0.000	0.400
PIPEFITTER		ALL		30.520	33.570	1.5	1.5	2.0	4.800	7.960	0.000	0.530
PLASTERER		BLD		29.540	32.490	2.0	2.0	2.0	5.500	7.350	0.000	0.100
PLUMBER		ALL		30.520	33.570	1.5	1.5	2.0	4.800	7.960	0.000	0.530
ROOFER		BLD		33.650	35.650	1.5	1.5	2.0	6.460	3.310	0.000	0.330
SHEETMETAL WORKER		BLD		31.690	33.620	1.5	1.5	2.0	4.850	10.29	0.520	0.290
SPRINKLER FITTER		BLD		31.240	33.240	1.5	1.5	2.0	6.500	5.350	0.000	0.250
STONE MASON		BLD		30.000	32.500	1.5	1.5	2.0	5.500	8.680	0.000	0.420
TERRAZZO FINISHER		BLD		24.860	0.000	1.5	1.5	2.0	5.500	4.000	0.000	0.360
TERRAZZO MASON		BLD		28.140	28.390	1.5	1.5	2.0	5.500	5.220	0.000	0.380
TILE LAYER		BLD		27.040	30.010	1.5	1.5	2.0	6.100	8.220	0.000	0.600
TILE MASON		BLD		28.140	28.390	1.5	1.5	2.0	5.500	5.220	0.000	0.380
TRUCK DRIVER		O&C	1	20.630	0.000	1.5	1.5	2.0	7.250	3.317	0.000	0.000
TRUCK DRIVER		O&C	2	20.950	0.000	1.5	1.5	2.0	7.250	3.317	0.000	0.000
TRUCK DRIVER		O&C	3	21.110	0.000	1.5	1.5	2.0	7.250	3.317	0.000	0.000
TRUCK DRIVER		O&C	4	21.310	0.000	1.5	1.5	2.0	7.250	3.317	0.000	0.000
TRUCK DRIVER		O&C	5	21.910	0.000	1.5	1.5	2.0	7.250	3.317	0.000	0.000
TRUCK DRIVER	E	ALL	1	29.700	30.250	1.5	1.5	2.0	6.500	3.400	0.000	0.000

TRUCK DRIVER	E	ALL	2	29.850	30.250	1.5	1.5	2.0	6.500	3.400	0.000	0.000
TRUCK DRIVER	E	ALL	3	30.050	30.250	1.5	1.5	2.0	6.500	3.400	0.000	0.000
TRUCK DRIVER	E	ALL	4	30.250	30.250	1.5	1.5	2.0	6.500	3.400	0.000	0.000
TRUCK DRIVER	W	ALL	1	25.787	0.000	1.5	1.5	2.0	7.250	3.317	0.000	0.000
TRUCK DRIVER	W	ALL	2	26.187	0.000	1.5	1.5	2.0	7.250	3.317	0.000	0.000
TRUCK DRIVER	W	ALL	3	26.387	0.000	1.5	1.5	2.0	7.250	3.317	0.000	0.000
TRUCK DRIVER	W	ALL	4	26.637	0.000	1.5	1.5	2.0	7.250	3.317	0.000	0.000
TRUCK DRIVER	W	ALL	5	27.387	0.000	1.5	1.5	2.0	7.250	3.317	0.000	0.000
TUCKPOINTER		BLD		30.000	32.500	1.5	1.5	2.0	5.500	8.680	0.000	0.420

Legend:

M-F>8 (Overtime is required for any hour greater than 8 worked each day, Monday through Friday.)

OSA (Overtime is required for every hour worked on Saturday)

OSH (Overtime is required for every hour worked on Sunday and Holidays)

H/W (Health & Welfare Insurance)

Pensn (Pension)

Vac (Vacation)

Trng (Training)

## Explanations

### LEE COUNTY

IRONWORKERS (SOUTH) - That part of the county South of Route 30.

TRUCK DRIVERS (EAST) - That part of the county East of U.S. 251 and North of Route 30.

The following list is considered as those days for which holiday rates of wages for work performed apply: New Years Day, Memorial/Decoration Day, Fourth of July, Labor Day, Veterans Day, Thanksgiving Day, Christmas Day. Generally, any of these holidays which fall on a Sunday is celebrated on the following Monday. This then makes work performed on that Monday payable at the appropriate overtime rate for holiday pay. Common practice in a given local may alter certain days of celebration such as the day after Thanksgiving for Veterans Day. If in doubt, please check with IDOL.

Oil and chip resealing (O&C) means the application of road oils and liquid asphalt to coat an existing road surface, followed by application of aggregate chips or gravel to coated surface, and subsequent rolling of material to seal the surface.

### EXPLANATION OF CLASSES

ASBESTOS - GENERAL - removal of asbestos material/mold and hazardous materials from any place in a building, including mechanical systems where those mechanical systems are to be removed. This includes the removal of asbestos materials/mold and hazardous materials from ductwork or pipes in a building when the building is to be demolished at the time or at some close future date.

ASBESTOS - MECHANICAL - removal of asbestos material from mechanical

systems, such as pipes, ducts, and boilers, where the mechanical systems are to remain.

#### CERAMIC TILE FINISHER, MARBLE FINISHER, TERRAZZO FINISHER

Assisting, helping or supporting the tile, marble and terrazzo mechanic by performing their historic and traditional work assignments required to complete the proper installation of the work covered by said crafts. The term "Ceramic" is used for naming the classification only and is in no way a limitation of the product handled. Ceramic takes into consideration most hard tiles.

#### COMMUNICATIONS TECHNICIAN

Installing, manufacturing, assembling and maintaining sound and intercom, protection alarm (security), fire alarm, master antenna television, closed circuit television, low voltage control for computers and/or door monitoring, school communications systems, telephones and servicing of nurse and emergency calls, and the installation and maintenance of transmit and receive antennas, transmitters, receivers, and associated apparatus which operates in conjunction with above systems. All work associated with these system installations will be included EXCEPT the installation of protective metallic conduit in new construction projects (excluding less than ten-foot runs strictly for protection of cable) and 120 volt AC (or higher) power wiring and associated hardware.

#### LABORER, SKILLED - HIGHWAY

Individuals engaged in the following types of work, irrespective of the site of the work: asbestos abatement worker, handling of any materials with any foreign matter harmful to skin or clothing, track laborer, cement handlers, chloride handlers, the unloading and loading with steel workers and re-bars, concrete workers wet, tunnel helpers in free air, batch dumpers, mason tenders, kettle and tar men, tank cleaners, plastic installers, scaffold workers, motorized buggies or motorized unit used for wet concrete or handling of building materials, laborers with de-watering systems, sewer workers plus depth, rod and chainmen with technical engineers, rod and chainmen with land surveyors, rod and chainmen with surveyors, vibrator operators, cement silica, clay, fly ash, lime and plasters, handlers (bulk or bag), cofferdam workers plus depth, on concrete paving, placing, cutting and tying of reinforcing, deck hand, dredge hand, and shore laborers, bankmen on floating plant, grade checker, power tools, front end man on chip spreaders, cession workers plus depth, gunnite nozzle men, lead man on sewer work, welders, cutters, burners and torchmen, chainsaw operators, jackhammer and drill operators, layout man and/or drainage tile layer, steel form setter - street and highway, air tamping hammermen, signal man on crane, concrete saw operator, screedman on asphalt pavers, laborers tending masons with hot material or where foreign materials are used, mortar mixer operators, multiple concrete duct - leadsman, lumen, asphalt raker, curb asphalt machine operator, ready mix scalemen (permanent, portable or temporary plant), laborers handling masterplate or similar materials, laser beam operator, concrete burning machine operator, coring machine operator, plaster tender, underpinning and shoring of buildings, pump men, manhole and catch basin, dirt and stone tamper, hose men on concrete pumps, hazardous waste worker, lead base paint abatement worker, lining of pipe, refusing machine, assisting on direct boring machine, the work of laying watermain, fire hydrants, all mechanical joints to watermain work, sewer worker, and tapping water service and forced lift station mechanical worker.



MATERIAL TESTER I: Hand coring and drilling for testing of materials; field inspection of uncured concrete and asphalt.

MATERIAL TESTER II: Field inspection of welds, structural steel, fireproofing, masonry, soil, facade, reinforcing steel, formwork, cured concrete, and concrete and asphalt batch plants; adjusting proportions of bituminous mixtures.

TRUCK DRIVER - BUILDING, HEAVY AND HIGHWAY CONSTRUCTION - WEST

Class 1. Drivers on 2 axle trucks hauling less than 9 ton. Air compressor and welding machines and brooms, including those pulled by separate units, truck driver helpers, warehouse employees, mechanic helpers, greasers and tiremen, pickup trucks when hauling materials, tools, or workers to and from and on-the-job site, and fork lifts up to 6,000 lb. capacity.

Class 2. Two or three axle trucks hauling more than 9 ton but hauling less than 16 ton. A-frame winch trucks, hydrolift trucks, vector trucks or similar equipment when used for transportation purposes. Fork lifts over 6,000 lb. capacity, winch trucks, four axle combination units, and ticket writers.

Class 3. Two, three or four axle trucks hauling 16 ton or more. Drivers on water pulls, articulated dump trucks, mechanics and working forepersons, and dispatchers. Five axle or more combination units.

Class 4. Low Boy and Oil Distributors.

Class 5. Drivers who require special protective clothing while employed on hazardous waste work.

TRUCK DRIVER - BUILDING, HEAVY AND HIGHWAY CONSTRUCTION - EAST

Class 1. Two or three Axle Trucks. A-frame Truck when used for transportation purposes; Air Compressors and Welding Machines, including those pulled by cars, pick-up trucks and tractors; Ambulances; Batch Gate Lockers; Batch Hopperman; Car and Truck Washers; Carry-alls; Fork Lifts and Hoisters; Helpers; Mechanics Helpers and Greasers; Oil Distributors 2-man operation; Pavement Breakers; Pole Trailer, up to 40 feet; Power Mower Tractors; Self-propelled Chip Spreader; Skipman; Slurry Trucks, 2-man operation; Slurry Truck Conveyor Operation, 2 or 3 man; Teamsters; Unskilled dumpman; and Truck Drivers hauling warning lights, barricades, and portable toilets on the job site.

Class 2. Four axle trucks; Dump Crets and Adgetors under 7 yards; Dumpsters, Track Trucks, Euclids, Hug Bottom Dump Turnapulls or Turnatrailers when pulling other than self-loading equipment or similar equipment under 16 cubic yards; Mixer Trucks under 7 yards; Ready-mix Plant Hopper Operator, and Winch Trucks, 2 Axles.

Class 3. Five axle trucks; Dump Crets and Adgetors 7 yards and over; Dumpsters, Track Trucks, Euclids, Hug Bottom Dump Turnatrailers or turnapulls when pulling other than self-loading equipment or similar equipment over 16 cubic yards; Explosives and/or Fission Material Trucks; Mixer Trucks 7 yards or over; Mobile Cranes while in transit; Oil Distributors, 1-man operation; Pole Trailer, over 40 feet; Pole and Expandable Trailers hauling material over 50 feet long; Slurry trucks, 1-man operation; Winch trucks, 3 axles or more; Mechanic--Truck Welder and Truck Painter.

Class 4. Six axle trucks; Dual-purpose vehicles, such as mounted

crane trucks with hoist and accessories; Foreman; Master Mechanic; Self-loading equipment like P.B. and trucks with scoops on the front.

#### TRUCK DRIVER - OIL AND CHIP RESEALING ONLY.

This shall encompass laborers, workers and mechanics who drive contractor or subcontractor owned, leased, or hired pickup, dump, service, or oil distributor trucks. The work includes transporting materials and equipment (including but not limited to, oils, aggregate supplies, parts, machinery and tools) to or from the job site; distributing oil or liquid asphalt and aggregate; stock piling material when in connection with the actual oil and chip contract. The Truck Driver (Oil & Chip Resealing) wage classification does not include supplier delivered materials.

#### OPERATING ENGINEERS - BUILDING

Class 1. Assistant Craft Foreman; Craft Foreman; Mechanic; Asphalt Plant; Asphalt Spreader; Autograde; Batch Plant; Benoto (requires Two Engineers); Boiler and Throttle Valve; Caisson Rigs; Central Redi-Mix Plant; Combination Back Hoe Front End-loader Machine; Compressor and Throttle Valve; Concrete Breaker (Truck Mounted); Concrete Conveyor; Concrete Paver; Concrete Placer; Concrete Pump (Truck Mounted); Concrete Tower, Cranes, All, Cranes, Hammerhead, Creter Crane; Crusher, Stone, etc.; Derricks, All; Derricks, Traveling; Formless Curb and Gutter Machine; Grader, Elevating; Grouting Machines; Highlift Shovels or Front Endloader 2-1/4 yd. and over; Hoists, Elevators, outside type rack and pinion and similar machines; Hoists, one, two and three Drum; Hoists, Two tigger One Floor; Hydraulic Backhoes; Hydraulic Boom Trucks; Locomotives, All; Motor Patrol; Pile Drivers and Skid Rig; Post Hole Digger; Pre-Stress Machine; Pump Cretes; Squeeze Cretes-screw Type Pumps; Gypsum Bulker and Pump; Raised and Blind Hole Drill; Rock Drill; Roto Mill Grinder; Scoops - Tractor Drawn; Slip-form Paver; Straddle Buggies; Tie Back Machine; Tractor with Book and Side Boom; Trenching Machines.

Class 2. Bobcat (over 3/4 cu. yd.); Boilers Brick Forklift; Broom, All Power Propelled; Bulldozers; Concrete Mixer (Two Bag and Over); Conveyor, Portable; Forklift Trucks; Greaser Engineer; Highlift Shovels or Front Endloaders under 2-1/4 yd.; Hoists, Automatic; Hoists, Sewer Dragging Machine; Hoists, Tigger Single Drum; Rollers, All; Steam Generators; Tractors, All; Tractor Drawn Vibratory Roller; Winch Trucks with "A" Frame.

Class 3. Air Compressor; Asphalt Spreader; Combination - Small Equipment Operator; Generators; Heaters, Mechanical; Hoists, Inside Elevators - (Rheostat Manual Controlled); Hydraulic Power Units (Pile Driving and Extracting); Pumps, over 3" (1 to 3 not to exceed a total of 300 ft.); Pumps, Well Points; Welding Machines (2 through 5); Winches, 4 small Electric Drill Winches; Bobcat (up to and including 3/4 cu. yd.).

Class 4. Hoists, Inside Elevators, Push Button with Automatic Doors; Oilers; Brick Forklift.

#### OPERATING ENGINEERS - HEAVY AND HIGHWAY CONSTRUCTION

Class 1. Craft Foreman; Asphalt Plant, Asphalt Heater and Planer Combination; Asphalt Heater Scarfire; Asphalt Silo Tender; Asphalt Spreader; Autograder; ABG Paver; Backhoes with Caisson attachment; Ballast Regulator, Belt Loader; Caisson Rigs; Car Dumper; Central Redi-Mix Plant; Backhoe w/shear attachments; Combination Backhoe Front Endloader Machine, (1 cu. yd. Backhoe Bucket or over or with

attachments); Concrete Breaker (Truck Mounted); Concrete Conveyor; Concrete Paver over 27E cu. ft.; Concrete Placer; Concrete Tube Float; Cranes, all attachments; Cranes, Hammerhead, Linden, Peco & Machines of a like nature; Crete Crane; Crusher, Stone, etc.; Derricks, All; Derrick Boats; Derricks, Traveling; Directional Boring Machine over 12"; Dredges; Field Mechanic-Welder; Formless Curb and Gutter Machine; Gradall and Machines of a like nature; Grader, Elevating; Grader, Motor Grader, Motor Patrol, Auto Patrol, Form Grader, Pull Grader, Subgrader; Guard Rail Post Driver Mounted; Hoists, One, Two and Three Drum; Hydraulic Backhoes; Pile Drivers and Skid Rig; Pre-Stress Machine; Pump Cretes Dual Ram; Rock Drill - Crawler or Skid Rig; Rock Drill - Truck Mounted; Rock/Track Tamper; Roto Mill Grinder; Slip-Form Paver; Soil Test Drill Rig (Truck Mounted); Straddle Buggies; GCI Crane; Hydraulic Telescoping form (Tunnel); Tie Back Machine; Tractor Drawn Belt Loader; Tractor with Boom; Tractor-aire with Attachments; Traffic Barrier conveyor machine; Raised or Blind Hole; Trenching Machine; Truck Mounted Concrete Pump with Boom; Truck Mounted Concrete Conveyor; Underground Boring and/or Mining Machines; Wheel Excavator; Widener (APSCO).

Class 2. Batch Plant; Bituminous Mixer; Boiler and Throttle Valve; Bulldozers; Car Loader Trailing Conveyors; Combination Backhoe Front Endloader Machine (less than 1 cu. yd. Backhoe Bucket or over or with attachments); Compressor and Throttle Valve; Compressor, Common Receiver (3); Concrete Breaker or Hydro Hammer; Concrete Grinding Machine; Concrete Mixer or Paver 7S Series to and including 27 cu. ft.; Concrete Spreader; Concrete Curing Machine, Burlap Machine, Belting Machine and Sealing Machine; Conveyor Muck Cars (Haglund or Similar Type); Drills, all; Finishing Machine - Concrete; Greaser Engineer; Highlift Shovels or Front Endloader; Hoist - Sewer Dragging Machine; Hydraulic Boom Trucks (All Attachments); Hydro Blaster; Laser Screed; All Locomotives, Dinky; Pump Cretes; Squeeze Cretes-Screw Type Pumps, Gypsum Bulker and Pump; Roller, Asphalt; Rotary Snow Plows; Rototiller, Seaman, etc., self-propelled; Scoops - Tractor Drawn; Self-Propelled Compactor; Spreader - Chip - Stone, etc.; Scraper; Scraper - Prime Mover in Tandem (Regardless of Size); Tank Car Heater; Tractors, Push, Pulling Sheeps Foot, Disc, Compactor, etc. Tug Boats.

Class 3. Boilers; Brooms, All Power Propelled; Cement Supply Tender; Compressor, Common Receiver (2); Concrete Mixer (Two Bag and Over); Conveyor, Portable; Farm-Type Tractors Used for Mowing, Seeding, etc.; Fireman on Boilers; Forklift Trucks; Grouting Machine; Hoists, Automatic; Hoists, All Elevators; Hoists, Tugger Single Drum; Jeep Diggers, Low Boys; Pipe Jacking Machines; Post-Hole Digger; Power Saw, Concrete Power Driven; Pug Mills; Rollers, other than asphalt; Seed and Straw Blower; Steam Generators; Stump Machine; Winch Trucks with "A" Frame; Work Boats; Tamper - Form-Motor Driven.

Class 4. Air Compressor - Small and Large; Asphalt Spreader, Backend Man; Bobcat (Skid Steer) all; Combination - Small Equipment Operator; Directional Boring Machine up to 12"; Generators - Small 50kw and Under; Generators - Large over 50kw; Heaters, Mechanical; Hydraulic Power Unit (Pile Driving, Extracting, or Drilling); Hydro-Blaster; Light Plants, All (1 through 5); Pumps, over 3" (1 to 3 not to exceed a total of 300 ft.); Pumps, Well Points; Tract-aire; Welding Machines (2 through 5); Winches, 4 Small Electric Drill Winches.

Class 5. Oilers and Directional Boring Machine Locator.  
Other Classifications of Work:

For definitions of classifications not otherwise set out, the Department generally has on file such definitions which are

available. If a task to be performed is not subject to one of the classifications of pay set out, the Department will upon being contacted state which neighboring county has such a classification and provide such rate, such rate being deemed to exist by reference in this document. If no neighboring county rate applies to the task, the Department shall undertake a special determination, such special determination being then deemed to have existed under this determination. If a project requires these, or any classification not listed, please contact IDOL at 618/993-7271 for wage rates or clarifications.

#### LANDSCAPING

Landscaping work falls under the existing classifications for laborer, operating engineer and truck driver. The work performed by landscape plantsman and landscape laborer is covered by the existing classification of laborer. The work performed by landscape operators (regardless of equipment used or its size) is covered by the classifications of operating engineer. The work performed by landscape truck drivers (regardless of size of truck driven) is covered by the classifications of truck driver.

# Livingston County Prevailing Wage for April 2007

Trade Name	RG	TYP	C	Base	FRMAN	*M-F>8	OSA	OSH	H/W	Pensn	Vac	Trng
=====	==	==	=	=====	=====	=====	==	==	=====	=====	=====	=====
ASBESTOS ABT-GEN		BLD		25.090	25.840	1.5	1.5	2.0	5.850	5.250	0.000	0.600
ASBESTOS ABT-GEN		HWY		25.870	26.420	1.5	1.5	2.0	5.850	5.250	0.000	0.700
ASBESTOS ABT-MEC		BLD		23.300	24.800	1.5	1.5	2.0	7.860	4.910	0.000	0.000
BOILERMAKER		BLD		30.970	33.970	2.0	2.0	2.0	8.270	7.740	0.000	0.300
BRICK MASON		BLD		29.500	30.500	1.5	1.5	5.0	6.070	6.000	0.000	0.400
CARPENTER		BLD		26.850	28.850	1.5	1.5	2.0	6.500	6.250	0.000	0.320
CARPENTER		HWY		27.960	29.960	1.5	1.5	2.0	6.500	6.500	0.000	0.320
CEMENT MASON	N	ALL		30.000	31.000	1.5	1.5	2.0	5.500	7.390	0.000	0.100
CEMENT MASON	S	ALL		24.690	25.440	1.5	1.5	2.0	5.050	8.350	0.000	0.300
CERAMIC TILE FNSHER		BLD		24.860	0.000	1.5	1.5	2.0	5.500	4.000	0.000	0.360
ELECTRIC PWR EQMT OP		ALL		30.750	0.000	1.5	1.5	2.0	4.750	8.610	0.000	0.000
ELECTRIC PWR GRNDMAN		ALL		21.090	0.000	1.5	1.5	2.0	4.750	5.905	0.000	0.000
ELECTRIC PWR LINEMAN		ALL		34.160	36.350	1.5	1.5	2.0	4.750	9.560	0.000	0.000
ELECTRIC PWR TRK DRV		ALL		22.130	0.000	1.5	1.5	2.0	4.750	6.200	0.000	0.000
ELECTRICIAN		BLD		32.010	34.010	1.5	1.5	2.0	5.150	5.410	0.000	0.480
ELECTRONIC SYS TECH		BLD		24.870	26.370	1.5	1.5	2.0	5.150	3.150	0.000	0.250
ELEVATOR CONSTRUCTOR		BLD		34.190	38.460	2.0	2.0	2.0	8.275	6.060	2.050	0.000
GLAZIER		BLD		26.320	27.070	1.5	1.5	2.0	5.650	5.750	0.000	0.350
HT/FROST INSULATOR		BLD		33.300	35.050	1.5	1.5	2.0	7.860	8.610	0.000	0.310
IRON WORKER	E	ALL		30.000	33.000	2.0	2.0	2.0	7.690	10.46	0.000	0.550
IRON WORKER	W	ALL		28.000	29.000	2.0	2.0	2.0	8.040	11.85	0.000	0.550
LABORER		BLD		24.090	24.840	1.5	1.5	2.0	5.850	5.250	0.000	0.600
LABORER		HWY		24.870	25.420	1.5	1.5	2.0	5.850	5.250	0.000	0.600
LABORER, SKILLED		BLD		24.090	24.840	1.5	1.5	2.0	5.850	5.250	0.000	0.600
LABORER, SKILLED		HWY		24.870	25.420	1.5	1.5	2.0	5.850	5.250	0.000	0.600
LATHER		BLD		26.850	28.850	1.5	1.5	2.0	6.500	6.250	0.000	0.320
MACHINIST		BLD		36.890	38.890	2.0	2.0	2.0	4.380	5.650	2.550	0.000
MARBLE FINISHERS		BLD		24.860	0.000	1.5	1.5	2.0	5.500	4.000	0.000	0.360
MARBLE MASON		BLD		28.140	28.390	1.5	1.5	2.0	5.500	5.220	0.000	0.380
MILLWRIGHT		BLD		26.680	28.680	1.5	1.5	2.0	6.500	6.850	0.000	0.320
MILLWRIGHT		HWY		27.460	29.460	1.5	1.5	2.0	6.500	6.450	0.000	0.320
OPERATING ENGINEER		BLD	1	39.750	43.750	2.0	2.0	2.0	6.850	5.600	1.900	0.700
OPERATING ENGINEER		BLD	2	38.450	43.750	2.0	2.0	2.0	6.850	5.600	1.900	0.700
OPERATING ENGINEER		BLD	3	35.900	43.750	2.0	2.0	2.0	6.850	5.600	1.900	0.700
OPERATING ENGINEER		BLD	4	34.150	43.750	2.0	2.0	2.0	6.850	5.600	1.900	0.700
OPERATING ENGINEER		HWY	1	39.750	43.750	1.5	1.5	2.0	6.850	5.600	1.900	0.700
OPERATING ENGINEER		HWY	2	39.200	43.750	1.5	1.5	2.0	6.850	5.600	1.900	0.700
OPERATING ENGINEER		HWY	3	37.150	43.750	1.5	1.5	2.0	6.850	5.600	1.900	0.700
OPERATING ENGINEER		HWY	4	35.750	43.750	1.5	1.5	2.0	6.850	5.600	1.900	0.700
OPERATING ENGINEER		HWY	5	34.550	43.750	1.5	1.5	2.0	6.850	5.600	1.900	0.700
PAINTER		ALL		26.850	27.850	1.5	1.5	1.5	5.650	5.750	0.000	0.350
PAINTER SIGNS		BLD		28.970	32.520	1.5	1.5	1.5	2.600	2.310	0.000	0.000
PILEDRIVER		BLD		27.350	29.350	1.5	1.5	2.0	6.500	6.250	0.000	0.320
PILEDRIVER		HWY		28.960	30.960	1.5	1.5	2.0	6.500	6.500	0.000	0.320
PIPEFITTER	N	BLD		37.600	39.600	1.5	1.5	2.0	8.660	6.900	0.000	0.940
PIPEFITTER	S	BLD		34.100	36.830	1.5	1.5	2.0	6.450	6.400	0.000	1.150
PLASTERER	N	BLD		33.850	35.350	1.5	1.5	2.0	6.740	7.100	0.000	0.400
PLASTERER	S	BLD		25.920	27.920	1.5	1.5	2.0	4.700	9.300	0.000	0.400
PLUMBER	N	BLD		37.500	39.500	1.5	1.5	2.0	7.050	8.500	0.000	0.760
PLUMBER	S	BLD		34.100	36.830	1.5	1.5	2.0	6.450	6.400	0.000	1.150
ROOFER		BLD		33.650	35.650	1.5	1.5	2.0	6.460	3.310	0.000	0.330
SHEETMETAL WORKER		BLD		36.510	38.510	1.5	1.5	2.0	6.890	8.020	0.000	0.640
SPRINKLER FITTER		BLD		31.240	33.240	1.5	1.5	2.0	6.500	5.350	0.000	0.250
STONE MASON		BLD		29.500	30.500	1.5	1.5	5.0	6.070	6.000	0.000	0.400
TERRAZZO FINISHER		BLD		24.860	0.000	1.5	1.5	2.0	5.500	4.000	0.000	0.360
TILE MASON		BLD		28.140	28.390	1.5	1.5	2.0	5.500	5.220	0.000	0.380
TRUCK DRIVER	NW	ALL	1	25.787	0.000	1.5	1.5	2.0	7.250	3.317	0.000	0.000
TRUCK DRIVER	NW	ALL	2	26.187	0.000	1.5	1.5	2.0	7.250	3.317	0.000	0.000

TRUCK DRIVER	NW ALL	3	26.387	0.000	1.5	1.5	2.0	7.250	3.317	0.000	0.000
TRUCK DRIVER	NW ALL	4	26.637	0.000	1.5	1.5	2.0	7.250	3.317	0.000	0.000
TRUCK DRIVER	NW ALL	5	27.387	0.000	1.5	1.5	2.0	7.250	3.317	0.000	0.000
TRUCK DRIVER	SE ALL	1	32.040	32.590	1.5	1.5	2.0	5.830	3.680	0.000	0.000
TRUCK DRIVER	SE ALL	2	32.190	32.590	1.5	1.5	2.0	5.830	3.680	0.000	0.000
TRUCK DRIVER	SE ALL	3	32.390	32.590	1.5	1.5	2.0	5.830	3.680	0.000	0.000
TRUCK DRIVER	SE ALL	4	32.590	32.590	1.5	1.5	2.0	5.830	3.680	0.000	0.000
TUCKPOINTER	BLD		29.500	30.500	1.5	1.5	5.0	6.070	6.000	0.000	0.400

Legend:

M-F>8 (Overtime is required for any hour greater than 8 worked each day, Monday through Friday.)

OSA (Overtime is required for every hour worked on Saturday)

OSH (Overtime is required for every hour worked on Sunday and Holidays)

H/W (Health & Welfare Insurance)

Pensn (Pension)

Vac (Vacation)

Trng (Training)

## Explanations

### LIVINGSTON COUNTY

CEMENT MASONS & PLASTERER - N That part of the county north of Illinois Route 116 and including all of the City of Pontiac.

IRONWORKERS - E East of I-55 from the northern boundary through Cayuga then East of a North-South line to a point East of Weston.

PLUMBERS & PIPEFITTERS - S That part of the county South of Rt. 116 including the City of Pontiac.

TRUCK DRIVERS - NW Townships of Reading, New Town, Sunbury, Nevada, Long Point and Amity.

The following list is considered as those days for which holiday rates of wages for work performed apply: New Years Day, Memorial/Decoration Day, Fourth of July, Labor Day, Veterans Day, Thanksgiving Day, Christmas Day. Generally, any of these holidays which fall on a Sunday is celebrated on the following Monday. This then makes work performed on that Monday payable at the appropriate overtime rate for holiday pay. Common practice in a given local may alter certain days of celebration such as the day after Thanksgiving for Veterans Day. If in doubt, please check with IDOL.

### EXPLANATION OF CLASSES

ASBESTOS - GENERAL - removal of asbestos material/mold and hazardous materials from any place in a building, including mechanical systems where those mechanical systems are to be removed. This includes the removal of asbestos materials/mold and hazardous materials from ductwork or pipes in a building when the building is to be demolished at the time or at some close future date.

ASBESTOS - MECHANICAL - removal of asbestos material from mechanical systems, such as pipes, ducts, and boilers, where the mechanical systems are to remain.

CERAMIC TILE FINISHER, MARBLE FINISHER, TERRAZO FINISHER

Assisting, helping or supporting the tile, marble and terrazzo mechanic by performing their historic and traditional work assignments required to complete the proper installation of the work covered by said crafts. The term "Ceramic" is used for naming the classification only and is in no way a limitation of the product handled. Ceramic takes into consideration most hard tiles.

ELECTRONIC SYSTEMS TECHNICIAN

Installation, service and maintenance of low-voltage systems which utilizes the transmission and/or transference of voice, sound, vision, or digital for commercial, education, security and entertainment purposes for the following: TV monitoring and surveillance, background/foreground music, intercom and telephone interconnect, field programming, inventory control systems, microwave transmission, multi-media, multiplex, radio page, school, intercom and sound burglar alarms and low voltage master clock systems.

Excluded from this classification are energy management systems, life safety systems, supervisory controls and data acquisition systems not intrinsic with the above listed systems, fire alarm systems, nurse call systems and raceways exceeding fifteen feet in length.

LABORER, SKILLED - BUILDING

The skilled laborer building (BLD) classification shall encompass the following types of work, irrespective of the site of the work: tending of carpenters in unloading, handling, stockpiling and distribution operations, also other building crafts, mixing, handling, and conveying of all materials used by masons, plasterers and other building construction crafts, whether done by hand or by any process. The drying of plastering when done by salamander heat, and the cleaning and clearing of all debris. All work pertaining to and in preparation of asbestos abatement and removal. The building of scaffolding and staging for masons and plasterers. The excavations for buildings and all other construction, digging, of trenches, piers, foundations and holes, digging, lagging, sheeting, cribbing, bracing and propping of foundations, holes, caissons, cofferdams, and dikes, the setting of all guidelines for machine or hand excavation and subgrading. The mixing, handling, conveying, pouring, vibrating, gunniting and otherwise applying of concrete, whether by hand or other method of concrete for any walls, foundations, floors, or for other construction concrete sealant men. The wrecking, stripping, dismantling, and handling of concrete forms and false work, and the building of centers for fireproofing purposes. Boring machine, gas, electric or air in preparation for shoving pipe, telephone cable, and so forth, under highways, roads, streets and alleys. All hand and power operating cross cut saws when used for clearing. All work in compressed air construction. All work on acetylene burners in salvaging. The blocking and tamping of concrete. The laying of sewer tile and conduit, and pre-cast materials. The assembling and dismantling of all jacks and sectional scaffolding, including elevator construction and running of slip form jacks. The work of drill running and blasting, including wagon drills. The wrecking, stripping, dismantling, cleaning, moving and oiling of forms. The cutting off of concrete piles. The loading, unloading, handling and

carrying to place of installation of all rods, (and materials for use in reinforcing) concrete and the hoisting of same and all signaling where hoist is used in this type of construction coming under the jurisdiction of the Laborers' Union. And, all other labor work not awarded to any other craft. Mortar mixers, kettlemen and carrier of hot stuff, tool crib men, watchmen (Laborer), firemen or salamander tenders, flagmen, deck hands, installation and maintenance of temporary gas-fired heating units, gravel box men, dumpmen and spotters, fencing Laborers, cleaning lumber, pit men, material checkers, dispatchers, unloading explosives, asphalt plant laborers, writer of scale tickets, fireproofing laborers, janitors, asbestos abatement and removal laborers, handling of materials treated with oil, creosote, chloride, asphalt, and/or foreign material harmful to skin or clothing, Laborers with de-watering systems, gunnite nozzle men, laborers tending masons with hot material or where foreign materials are used, Laborers handling masterplate or similar materials, laser beam operator, concrete burning machine operator, material selector men working with firebrick or combustible material, dynamite men, track laborers, cement handlers, chloride handlers, the unloading and laborers with steel workers and re-bars, concrete workers (wet), luteman, asphalt raker, curb asphalt machine operator, ready mix scalemen, permanent, portable or temporary plant drilling machine operator, plaster tenders, underpinning and shoring of buildings, fire watch, signaling of all power equipment, to include trucks excavating equipment, etc., tree topper or trimmer when in connection to construction, tunnel helpers in free air, batch dumpers, kettle and tar men, tank cleaners, plastic installers, scaffold workers, motorized buggies or motorized unit used for wet concrete or handling of building materials, sewer workers, rod and chain men, vibrator operators, mortar mixer operator, cement silica, clay, fly ash, lime and plasters, handlers (bulk or bag), cofferdam workers, on concrete paving, placing, cutting and tying of reinforcing, deck hand, dredge hand and shore laborers, bankmen on floating plant, asphalt workers with machine & layers, grade checker, power tools, caisson workers, lead man on sewer work, welders, cutters, burners and torch men, chain saw operators, paving breaker, jackhammer and drill operator, layout man and/or drainage tile layer, steel form setters -- street and highway, air tamping hammerman, signal man on crane, concrete saw operator, screen man on asphalt pavers, front end man on chip spreader, multiple concrete duct -- lead man.

#### LABORER, SKILLED - HIGHWAY

The skilled laborer heavy and highway (HWY) classification shall encompass the following types of work, irrespective of the site of the work: handling of materials treated with oil, creosote, asphalt and/or any foreign materials harmful to skin or clothing, track laborers, chloride handlers, the unloading and loading with steel workers and re-bars, concrete workers (wet), tunnel helpers in free air, batch dumpers, mason tenders, kettle and tar men, plastic installers, scaffold workers, motorized buggies or motorized unit used for wet concrete or handling of building materials, laborers with de-watering systems, sewer workers plus depth, rod and chainmen, vibrator operators, mortar mixer operators, cement silica, clay, fly ash, lime and plasters, handlers (bulk or bag), cofferdam workers plus depth, on concrete paving, placing, cutting and tying or reinforcing, deck hand, dredge hand shore laborers, bankmen on floating plant, asphalt workers with machine, and layers, grade checker, power tools, stripping of all concrete forms excluding paving forms, dumpmen and spotters, when necessary, caisson workers plus depth, gunnite nozzle men, welders, cutters, burners and torchmen, chain saw operators, paving breaker, jackhammer and drill operators, layout man and/or drainage tile layer, steel form setters - street and highway, air



tamping hammerman, signal man on crane, concrete saw operator, screedman on asphalt pavers, front end man on chip spreader, multiple concrete duct, luteman, asphalt raker, curb asphalt machine operator, ready mix scalemen (portable or temporary plant), laser beam operator, concrete burning machine operator, and coring machine operator.

TRUCK DRIVER - BUILDING, HEAVY AND HIGHWAY CONSTRUCTION - NORTHWEST

Class 1. Drivers on 2 axle trucks hauling less than 9 ton. Air compressor and welding machines and brooms, including those pulled by separate units, truck driver helpers, warehouse employees, mechanic helpers, greasers and tiremen, pickup trucks when hauling materials, tools, or workers to and from and on-the-job site, and fork lifts up to 6,000 lb. capacity.

Class 2. Two or three axle trucks hauling more than 9 ton but hauling less than 16 ton. A-frame winch trucks, hydrolift trucks, vector trucks or similar equipment when used for transportation purposes. Fork lifts over 6,000 lb. capacity, winch trucks, four axle combination units, and ticket writers.

Class 3. Two, three or four axle trucks hauling 16 ton or more. Drivers on water pulls, articulated dump trucks, mechanics and working forepersons, and dispatchers. Five axle or more combination units.

Class 4. Low Boy and Oil Distributors.

Class 5. Drivers who require special protective clothing while employed on hazardous waste work.

TRUCK DRIVER - BUILDING, HEAVY AND HIGHWAY CONSTRUCTION - SOUTHEAST

Class 1. Two or three Axle Trucks. A-frame Truck when used for transportation purposes; Air Compressors and Welding Machines, including those pulled by cars, pick-up trucks and tractors; Ambulances; Batch Gate Lockers; Batch Hopperman; Car and Truck Washers; Carry-alls; Fork Lifts and Hoisters; Helpers; Mechanics Helpers and Greasers; Oil Distributors 2-man operation; Pavement Breakers; Pole Trailer, up to 40 feet; Power Mower Tractors; Self-propelled Chip Spreader; Skipman; Slurry Trucks, 2-man operation; Slurry Truck Conveyor Operation, 2 or 3 man; Teamsters; Unskilled dumpman; and Truck Drivers hauling warning lights, barricades, and portable toilets on the job site.

Class 2. Four axle trucks; Dump Crets and Adgetors under 7 yards; Dumpsters, Track Trucks, Euclids, Hug Bottom Dump Turnapulls or Turnatrailers when pulling other than self-loading equipment or similar equipment under 16 cubic yards; Mixer Trucks under 7 yards; Ready-mix Plant Hopper Operator, and Winch Trucks, 2 Axles.

Class 3. Five axle trucks; Dump Crets and Adgetors 7 yards and over; Dumpsters, Track Trucks, Euclids, Hug Bottom Dump Turnatrailers or turnapulls when pulling other than self-loading equipment or similar equipment over 16 cubic yards; Explosives and/or Fission Material Trucks; Mixer Trucks 7 yards or over; Mobile Cranes while in transit; Oil Distributors, 1-man operation; Pole Trailer, over 40 feet; Pole and Expandable Trailers hauling material over 50 feet long; Slurry trucks, 1-man operation; Winch trucks, 3 axles or more; Mechanic--Truck Welder and Truck Painter.

Class 4. Six axle trucks; Dual-purpose vehicles, such as mounted crane trucks with hoist and accessories; Foreman; Master Mechanic; Self-loading equipment like P.B. and trucks with scoops on the front.

## OPERATING ENGINEERS - BUILDING

Class 1. Assistant Craft Foreman; Craft Foreman; Mechanic; Asphalt Plant; Asphalt Spreader; Autograde; Backhoes w/Caisson attachment; Batch Plant; Benoto; Boiler and Throttle Valve; Caisson Rigs; Central Redi-Mix Plant; Combination Back Hoe Front End-loader Machine; Compressor and Throttle Valve; Concrete Breaker (Truck Mounted); Concrete Conveyor; Concrete Paver; Concrete Placer; Concrete Pump (Truck Mounted); Concrete Tower; Cranes, All; Cranes, Hammerhead; Creter Crane; Crusher, Stone, etc.; Derricks, All; Derricks, Traveling; Formless Curb and Gutter Machine; Grader, Elevating; Grouting Machines; Highlift Shovels or Front Endloader 2-1/4 yd. and over; Hoists, Elevators, outside type rack and pinion and similar machines; Hoists, one, two and three Drum; Hoists, Two tigger One Floor; Hydraulic Backhoes; Hydraulic Boom Trucks; Hydro Vac (and similar equipment.); Locomotives, All; Motor Patrol; Pile Drivers and Skid Rig; Post Hole Digger; Pre-Stress Machine; Pump Cretes; Squeeze Cretes-screw Type Pumps; Gypsum Bulker and Pump; Roto Mill Grinder; Scoops - Tractor Drawn; Slip-form Paver; Straddle Buggies; Tournapull; Tractor with Boom and Side Boom; Trenching Machines.

Class 2. Boilers; Broom, All Power Propelled; Bulldozers; Concrete Mixer (Two Bag and Over); Conveyor, Portable; Forklist Trucks; Greaser Engineer; Highlift Shovels or Front Endloaders under 2-1/4 yd.; Hoists, Automatic; Hoists, inside Freight Elevators; Hoists, Sewer Dragging Machine; Hoists, Tigger Single Drum; Laser Screed; Rock Drill (self-propelled); Rock Drill (Truck mounted); Rollers, All; Steam Generators; Tractors, All; Tractor Drawn Vibratory Roller; Winch Trucks with "A" Frame.

Class 3. Air Compressors; Combination - Small Equipment Operator; Generators; Heaters, Mechanical; Hoists, Inside Elevators - (Rheostat Manual Controlled); Hoists, Inside Elevators; Hydraulic Power Units (Pile Driving and Extracting); Vibratory Roller; Lowboys; Pumps, over 3" (1 to 3 not to exceed a total of 300 ft.); Pumps, Well Points; Welding Machines (2 through 5); Winches, 4 small Electric Drill Winches.

Class 4. Bobcat/Skid Steer Loader; Brick Forklift; Hoists, Inside Elevators push button with automatic doors; Oilers.

## OPERATING ENGINEERS - HEAVY AND HIGHWAY CONSTRUCTION

Class 1. Craft Foreman; Asphalt Plant; Asphalt Heater and Planer Combination; Asphalt Heater Scarfire; Asphalt Spreader; Autograder; ABC Paver; Backhoes with Caisson Attachment; Belt Loader; Caisson Rigs; Car Dumper; Central Redi-Mix Plant; Combination Backhoe Front Endloader Machine, (1 cu. yd. Backhoe Bucket or over or with attachments); Concrete Breaker (Truck Mounted); Concrete Conveyor; Concrete Paver over 27E cu. ft.; Concrete Placer; Concrete Tube Float; Cranes, all attachments; Cranes, Hammerhead, Linden, Peco & Machines of a like nature; Creter Crane; Crusher, Stone, etc.; Derricks, All; Derrick Boats; Derricks, Traveling; Dowell Machine; Dredges; Field Mechanic-Welder; Formless Curb and Gutter Machine; Gradall and Machines of a like nature; Grader, Elevating; Grader, Motor Grader, Motor Patrol, Auto Patrol, Form Grader, Pull Grader, Subgrader; Guard Rail Post Driver Truck Mounted; Hoists, One, Two and Three Drum; Hydraulic Backhoes; Mucking Machine; Pile Drivers and Skid Rig; Pre-Stress Machine; Pump Cretes Dual Ram; Rock/Track Tamper; Rock Drill - Truck Mounted; Roto Mill Grinder; Slip-Form Paver; Soil Test Drill Rig (Truck Mounted); Straddle Buggies; Hydraulic Telescoping form (Tunnel); Tractor Drawn Belt Loader with attached pusher; Tractor with Boom; Tractaire with Attachments; Trenching Machine; Truck Mounted Concrete Pump with Boom; Raised or Blind Hole; Drills

(Tunnel Shaft); Underground Boring and/or Mining Machines; Wheel Excavator; Widener (APSCO).

Class 2. Batch Plant; Bituminous Mixer; Boiler and Throttle Valve; Bulldozers; Car Loader Trailing Conveyors; Combination Backhoe Front Endloader Machine (less than 1 cu. yd. Backhoe Bucket or over or with attachments); Compressor and Throttle Valve; Compressor, Common Receiver (3); Concrete Breaker or Hydro Hammer; Concrete Grinding Machine; Concrete Mixer or Paver 7S Series to and including 27 cu. ft.; Concrete Spreader; Concrete Curing Machine, Burlap Machine, Belting Machine and Sealing Machine; Concrete Wheel Saw; Conveyor Muck Cars (Haglund or Similar Type); Drills, All; Finishing Machine - Concrete; Greaser Engineer; Highlift Shovels or Front Endloader; Hoist - Sewer Dragging Machine; Hydraulic Boom Trucks (All Attachments); Hydro-Blaster; Locomotives, Dinky; Laser Screed; Pump Cretes; Squeeze Cretes-Screw Type Pumps, Gypsum Bulker and Pump; Rock Drill - Crawler or Skid Rig; Rock Drill - Truck Mounted; Roller, Asphalt; Rotary Snow Plows; Rototiller, Seaman, etc., self-propelled; Scoops - Tractor Drawn; Self-Propelled Compactor; Spreader - Chip - Stone, etc.; Scraper; Scraper - Prime Mover in Tandem; Tank Car Heater; Tractors, Push, Pulling Sheeps Foot, Disc, Compactor, etc. Tug Boats.

Class 3. Boilers; Brooms, All Power Propelled; Cement Supply Tender; Compressor, Common Receiver (2); Concrete Mixer (Two Bag and Over); Conveyor, Portable; Farm-Type Tractors Used for Mowing, Seeding, etc.; Fireman on Boilers; Forklift Trucks; Grouting Machine; Hoists, Automatic; Hoists, All Elevators; Hoists, Tugger Single Drum; Jeep Diggers; Pipe Jacking Machines; Post-Hole Digger; Power Saw, Concrete Power Driven; Pug Mills; Rollers, other than asphalt; Seed and Straw Blower; Steam Generators; Stump Machine; Winch Trucks with "A" Frame; Work Boats; Tamper - Form-Motor Driven.

Class 4. Air Compressor; Combination - Small Equipment Operator; Directional Boring Machine; Generators; Heaters, Mechanical; Hydraulic Power Unit (Pile Driving, Extracting, or Drilling); Hydro-Blaster; Light Plants, All (1 through 5); Pumps, over 3" (1 to 3 not to exceed a total of 300 ft.); Pumps; Tractaire; Welding Machines (2 through 5); Winches.

Class 5. Bobcats (All); Brick Forklifts; Oilers.

Other Classifications of Work:

For definitions of classifications not otherwise set out, the Department generally has on file such definitions which are available. If a task to be performed is not subject to one of the classifications of pay set out, the Department will upon being contacted state which neighboring county has such a classification and provide such rate, such rate being deemed to exist by reference in this document. If no neighboring county rate applies to the task, the Department shall undertake a special determination, such special determination being then deemed to have existed under this determination. If a project requires these, or any classification not listed, please contact IDOL at 618/993-7271 for wage rates or clarifications.

#### LANDSCAPING

Landscaping work falls under the existing classifications for laborer, operating engineer and truck driver. The work performed by landscape plantsman and landscape laborer is covered by the existing classification of laborer. The work performed by landscape operators

(regardless of equipment used or its size) is covered by the classifications of operating engineer. The work performed by landscape truck drivers (regardless of size of truck driven) is covered by the classifications of truck driver.

# Logan County Prevailing Wage for April 2007

Trade Name	RG	TYP	C	Base	FRMAN	*M-F>8	OSA	OSH	H/W	Pensn	Vac	Trng
=====	==	==	=	=====	=====	=====	==	==	=====	=====	=====	=====
ASBESTOS ABT-GEN		BLD		25.390	26.390	1.5	1.5	2.0	5.050	5.330	0.000	0.700
ASBESTOS ABT-MEC		BLD		25.290	26.290	1.5	1.5	2.0	4.450	2.500	0.000	0.250
BOILERMAKER		BLD		30.970	33.970	2.0	2.0	2.0	8.270	7.740	0.000	0.300
BRICK MASON		BLD		24.650	25.400	2.0	2.0	2.0	6.000	6.700	0.000	0.490
CARPENTER		BLD		26.210	28.210	1.5	1.5	2.0	6.500	6.920	0.000	0.320
CARPENTER		HWY		25.350	27.100	1.5	1.5	2.0	6.500	6.920	0.000	0.300
CEMENT MASON		BLD		24.370	25.370	2.0	2.0	2.0	6.000	5.400	0.000	0.490
CEMENT MASON		HWY		24.020	25.020	1.5	1.5	2.0	6.000	4.900	0.000	0.000
CERAMIC TILE FNSHER		BLD		23.300	0.000	1.5	1.5	2.0	6.000	6.700	0.000	0.000
ELECTRIC PWR EQMT OP		ALL		30.750	0.000	1.5	1.5	2.0	4.750	8.610	0.000	0.000
ELECTRIC PWR GRNDMAN		ALL		21.090	0.000	1.5	1.5	2.0	4.750	5.905	0.000	0.000
ELECTRIC PWR LINEMAN		ALL		34.160	36.350	1.5	1.5	2.0	4.750	9.560	0.000	0.000
ELECTRIC PWR TRK DRV		ALL		22.130	0.000	1.5	1.5	2.0	4.750	6.200	0.000	0.000
ELECTRICIAN		BLD		31.220	33.220	1.5	1.5	2.0	5.150	5.340	0.000	0.300
ELECTRONIC SYS TECH		BLD		24.830	26.330	1.5	1.5	2.0	5.150	3.190	0.000	0.250
ELEVATOR CONSTRUCTOR		BLD		34.190	38.460	2.0	2.0	2.0	8.275	6.060	2.050	0.000
GLAZIER		BLD		27.130	28.130	1.5	2.0	2.0	5.430	4.000	0.000	0.280
HT/FROST INSULATOR		BLD		30.440	31.440	1.5	1.5	2.0	4.850	8.360	0.000	0.450
IRON WORKER		BLD		25.400	27.150	1.5	1.5	2.0	5.860	7.900	0.000	0.300
IRON WORKER		HWY		25.400	26.900	1.5	1.5	2.0	5.860	7.900	0.000	0.300
LABORER		BLD		23.890	24.890	1.5	1.5	2.0	5.050	5.330	0.000	0.600
LABORER		HWY		24.870	25.620	1.5	1.5	2.0	5.050	5.330	0.000	0.600
LATHER		BLD		26.210	28.210	1.5	1.5	2.0	6.500	6.920	0.000	0.320
MACHINIST		BLD		36.890	38.890	2.0	2.0	2.0	4.380	5.650	2.550	0.000
MARBLE FINISHERS		BLD		23.300	0.000	1.5	1.5	2.0	6.000	6.700	0.000	0.000
MARBLE MASON		BLD		24.800	25.550	2.0	2.0	2.0	6.000	6.700	0.000	0.000
MILLWRIGHT		BLD		26.620	28.620	1.5	1.5	2.0	6.500	6.850	0.000	0.320
MILLWRIGHT		HWY		19.290	20.540	1.5	1.5	2.0	2.800	3.000	0.000	0.000
OPERATING ENGINEER		BLD	1	26.550	0.000	1.5	1.5	2.0	6.150	6.200	0.000	0.850
OPERATING ENGINEER		BLD	2	24.200	0.000	1.5	1.5	2.0	6.150	6.200	0.000	0.850
OPERATING ENGINEER		BLD	3	20.600	0.000	1.5	1.5	2.0	6.150	6.200	0.000	0.850
OPERATING ENGINEER		BLD	4	28.050	0.000	1.5	1.5	2.0	6.150	6.200	0.000	0.850
OPERATING ENGINEER		HWY	1	26.800	0.000	1.5	1.5	2.0	6.150	6.200	0.000	0.850
OPERATING ENGINEER		HWY	2	24.030	0.000	1.5	1.5	2.0	6.150	6.200	0.000	0.850
OPERATING ENGINEER		HWY	3	19.800	0.000	1.5	1.5	2.0	6.150	6.200	0.000	0.850
OPERATING ENGINEER		HWY	4	28.300	0.000	1.5	1.5	2.0	6.150	6.200	0.000	0.850
PAINTER		ALL		25.390	26.390	1.5	1.5	2.0	4.650	5.500	0.000	0.250
PAINTER OVER 30FT		ALL		26.390	27.390	1.5	1.5	2.0	4.650	5.500	0.000	0.250
PAINTER PWR EQMT		ALL		26.390	27.390	1.5	1.5	2.0	4.650	5.500	0.000	0.250
PILEDRIVER		BLD		26.710	28.710	1.5	1.5	2.0	6.500	6.920	0.000	0.320
PILEDRIVER		HWY		25.850	27.600	1.5	1.5	2.0	6.500	6.920	0.000	0.300
PIPEFITTER		BLD		34.700	37.200	1.5	1.5	2.0	6.450	4.750	0.000	0.350
PLASTERER		BLD		24.370	25.370	2.0	2.0	2.0	6.000	5.400	0.000	0.490
PLUMBER		BLD		34.700	37.200	1.5	1.5	2.0	6.450	4.750	0.000	0.350
ROOFER		BLD		24.310	26.740	1.5	1.5	2.0	4.650	5.250	0.000	0.100
SHEETMETAL WORKER		BLD		27.820	29.570	1.5	1.5	2.0	7.150	7.880	0.000	0.350
SPRINKLER FITTER		BLD		31.240	33.240	1.5	1.5	2.0	6.500	5.350	0.000	0.250
STONE MASON		BLD		24.650	25.400	2.0	2.0	2.0	6.000	6.700	0.000	0.490
TERRAZZO FINISHER		BLD		23.300	0.000	1.5	1.5	2.0	6.000	6.700	0.000	0.000
TERRAZZO MASON		BLD		24.800	25.550	2.0	2.0	2.0	6.000	6.700	0.000	0.000
TILE MASON		BLD		24.800	25.550	2.0	2.0	2.0	6.000	6.700	0.000	0.000
TRUCK DRIVER		ALL	1	25.930	0.000	1.5	1.5	2.0	7.250	3.425	0.000	0.000
TRUCK DRIVER		ALL	2	26.330	0.000	1.5	1.5	2.0	7.250	3.425	0.000	0.000
TRUCK DRIVER		ALL	3	26.530	0.000	1.5	1.5	2.0	7.250	3.425	0.000	0.000
TRUCK DRIVER		ALL	4	26.780	0.000	1.5	1.5	2.0	7.250	3.425	0.000	0.000
TRUCK DRIVER		ALL	5	27.530	0.000	1.5	1.5	2.0	7.250	3.425	0.000	0.000
TRUCK DRIVER		O&C	1	20.740	0.000	1.5	1.5	2.0	7.250	3.425	0.000	0.000
TRUCK DRIVER		O&C	2	21.060	0.000	1.5	1.5	2.0	7.250	3.425	0.000	0.000

TRUCK DRIVER	O&C 3	21.220	0.000	1.5	1.5	2.0	7.250	3.425	0.000	0.000
TRUCK DRIVER	O&C 4	21.420	0.000	1.5	1.5	2.0	7.250	3.425	0.000	0.000
TRUCK DRIVER	O&C 5	22.020	0.000	1.5	1.5	2.0	7.250	3.425	0.000	0.000
TUCK POINTER	BLD	24.650	25.400	2.0	2.0	2.0	6.000	6.700	0.000	0.490

Legend:

M-F>8 (Overtime is required for any hour greater than 8 worked each day, Monday through Friday.)

OSA (Overtime is required for every hour worked on Saturday)

OSH (Overtime is required for every hour worked on Sunday and Holidays)

H/W (Health & Welfare Insurance)

Pensn (Pension)

Vac (Vacation)

Trng (Training)

## Explanations

### LOGAN COUNTY

The following list is considered as those days for which holiday rates of wages for work performed apply: New Years Day, Memorial/Decoration Day, Fourth of July, Labor Day, Veterans Day, Thanksgiving Day, Christmas Day. Generally, any of these holidays which fall on a Sunday is celebrated on the following Monday. This then makes work performed on that Monday payable at the appropriate overtime rate for holiday pay. Common practice in a given local may alter certain days of celebration such as the day after Thanksgiving for Veterans Day. If in doubt, please check with IDOL.

Oil and chip resealing (O&C) means the application of road oils and liquid asphalt to coat an existing road surface, followed by application of aggregate chips or gravel to coated surface, and subsequent rolling of material to seal the surface.

### EXPLANATION OF CLASSES

ASBESTOS - GENERAL - removal of asbestos material/mold and hazardous materials from any place in a building, including mechanical systems where those mechanical systems are to be removed. This includes the removal of asbestos materials/mold and hazardous materials from ductwork or pipes in a building when the building is to be demolished at the time or at some close future date.

ASBESTOS - MECHANICAL - removal of asbestos material from mechanical systems, such as pipes, ducts, and boilers, where the mechanical systems are to remain.

### CERAMIC TILE FINISHER, MARBLE FINISHER, TERRAZZO FINISHER

Assisting, helping or supporting the tile, marble and terrazzo mechanic by performing their historic and traditional work assignments required to complete the proper installation of the work covered by said crafts. The term "Ceramic" is used for naming the classification

only and is in no way a limitation of the product handled. Ceramic takes into consideration most hard tiles.

#### ELECTRONIC SYSTEMS TECHNICIAN

Installation, service and maintenance of low-voltage systems which utilizes the transmission and/or transference of voice, sound, vision, or digital for commercial, education, security and entertainment purposes for the following: TV monitoring and surveillance, background/foreground music, intercom and telephone interconnect, field programming, inventory control systems, microwave transmission, multi-media, multiplex, radio page, school, intercom and sound burglar alarms and low voltage master clock systems.

Excluded from this classification are energy management systems, life safety systems, supervisory controls and data acquisition systems not intrinsic with the above listed systems, fire alarm systems, nurse call systems and raceways exceeding fifteen feet in length.

#### TRUCK DRIVER - BUILDING, HEAVY AND HIGHWAY CONSTRUCTION

Class 1. Drivers on 2 axle trucks hauling less than 9 ton. Air compressor and welding machines and brooms, including those pulled by separate units, truck driver helpers, warehouse employees, mechanic helpers, greasers and tiremen, pickup trucks when hauling materials, tools, or workers to and from and on-the-job site, and fork lifts up to 6,000 lb. capacity.

Class 2. Two or three axle trucks hauling more than 9 ton but hauling less than 16 ton. A-frame winch trucks, hydrolift trucks, vector trucks or similar equipment when used for transportation purposes. Fork lifts over 6,000 lb. capacity, winch trucks, four axle combination units, and ticket writers.

Class 3. Two, three or four axle trucks hauling 16 ton or more. Drivers on water pulls, articulated dump trucks, mechanics and working forepersons, and dispatchers. Five axle or more combination units.

Class 4. Low Boy and Oil Distributors.

Class 5. Drivers who require special protective clothing while employed on hazardous waste work.

#### TRUCK DRIVER - OIL AND CHIP RESEALING ONLY.

This shall encompass laborers, workers and mechanics who drive contractor or subcontractor owned, leased, or hired pickup, dump, service, or oil distributor trucks. The work includes transporting materials and equipment (including but not limited to, oils, aggregate supplies, parts, machinery and tools) to or from the job site; distributing oil or liquid asphalt and aggregate; stock piling material when in connection with the actual oil and chip contract. The Truck Driver (Oil & Chip Resealing) wage classification does not include supplier delivered materials.

#### OPERATING ENGINEERS - BUILDING

CLASS 1. Asphalt Screed Man; Aspco Concrete Spreaders; Asphalt Pavers; Asphalt Plant Engineer; Asphalt Rollers on Bituminous Concrete; Athey Loaders; Backfillers, Crane Type; Backhoes; Barber Green Loaders; Bulldozers; Cableways; Cherry Pickers; Clam Shells; C.M.I. & similar type autograde formless paver, autograde placer & finisher; Concrete Breakers; Concrete Pumps; Derricks; Derrick Boats; Draglines; Earth Auger or Boring Machines; Elevating Graders;

Engineers on Dredges; Gravel Processing Machines; Head Equipment Greaser; High Lifts or Fork Lifts; Hoists with two or more drums or two or more load lines; Locomotives, All; Mechanics; Motor Graders or Auto Patrols; Operators or Leverman on Dredges; Operators, Power Boat; Operators, Pug Mill (Asphalt Plants); Orange Peels; Overhead Cranes; Paving Mixers; Piledrivers; Pipe Wrapping and Painting Machines; Pushdozers, or Push Cats; Robotic Controlled Equipment in this Classification; Rock Crushers; Ross Carrier or Similar Machines; Rotomill; Scoops, Skimmer, two cu. yd. capacity and under; Scoops, All or Tournapull; Sheep-Foot Roller (Self Propelled); Shovels; Skid Steer; Skimmer Scoops; Temporary Concrete Plant Operators; Test Hole Drilling Machines; Tower Machines; Tower Mixers; Track Type End Loaders; Track Type Fork Lifts or High Lifts; Track Jacks and Tampers; Tractors, Sideboom; Trenching or Ditching Machine; Tunnelluggers; Vermeer Type Saws; Water Blaster Cutting Head; Wheel Type End Loaders; Winch Cat.

CLASS 2. Air Compressors (six to eight)\*; Asphalt Boosters and Heaters; Asphalt Distributors; Asphalt Plant Fireman; Oiler on Two Paving Mixers When Used in Tandem; Boom or Winch Trucks; Bull Floats or Flexplanes; Concrete Finishing Machine; Concrete Saws, Self-Propelled; Concrete Spreading Machines; Conveyors (six to eight)\*; Generators (six to eight)\*; Gravel or Stone Spreader, Power Operated; Hoist (with One Drum and One Load Line); Light Plants (six to eight)\*; Mechanical Heaters (six to eight)\*; Mud Jacks; Post Hole Digger, Mechanical; Pug Mills when used for other than Asphalt operation; Robotic Controlled Equipment in this Classification; Road or Street Sweeper, Self Propelled; Rollers (except bituminous concrete); Seaman Tiller; Straw Machine; Vibratory Compactor; Water Blaster, Power Unit; Welding Machines (six to eight)\*; Well Drill Machines.

CLASS 3. Air Compressors(one to five)\*; Air Compressors, Track or Self-Propelled; Automatic Hoist; Building Elevators; Bulk Cement Batching Plants; Conveyors (one to five)\*; Concrete Mixers (Except Plant, Paver, or Tower); Firemen; Generators (one to five)\*; Greasers; Helper on Single Paving Mixer; Hoist, Automatic; Light Plants (one to five)\*; Mechanic Helpers; Mechanical Heaters (one to five)\*; Oilers; Power Form Graders; Power Sub-Graders; Robotic Controlled Equipment in this Classification; Scissors Hoist; Tractors without power attachments regardless of size or type; Truck Crane Oiler and Driver (1 man); Vibratory Hammer (power source); Water Pumps (one to five)\*; Welding Machines (1/300 Amp. or over)\*; Welding machines (one to five)\*

CLASS 4. Lattice Boom Crawler Cranes; Lattice Boom Truck Cranes; Telescopic Truck-Mounted Cranes; Tower Cranes.

\* Combinations of one to eight of any Air Compressors, Conveyors, Welding Machines, Water Pumps, Light Plants, or Generators shall be in batteries or within 400 feet and shall be paid as per the Classification Schedule contained in this Article.

#### OPERATING ENGINEERS - HIGHWAY

CLASS 1. Asphalt Screed Man; Asphco Concrete Spreaders; Asphalt Pavers; Asphalt Plant Engineer; Asphalt Rollers on Bituminous Concrete; Athey Loaders; Backhoes; Barber Green Loaders; Bulldozers; Cableways; Carry Deck Pickers; Cherry Pickers (Rough Terrain); C.M.I. & similar type-autograde formless paver, autograde placer & finisher; Concrete Breakers; Concrete Plant Operators; Concrete Pumps; Derricks; Derrick Boats; Dewatering Systems; Earth Auger or Boring Machines;



Elevating Graders; Engineers on Dredges; Gravel Processing Machines; Grout Pump; Head Equipment Greaser; High Lifts or Fork Lifts; Hoists with two or more drums or two or more load lines; Hydro Jet or Hydro Laser; Locomotives, All; Mechanics; Motor Graders or Auto Patrols; Multi-Point Power Lifting Equipment; Operators or Leverman on Dredges; Operators, Power Boat; Operators, Pug Mill (Asphalt Plants); Overhead Cranes; Paving Mixers; Piledrivers; Pipe Wrapping and Painting Machines; Push-dozers, or Push Cats; Robotic Controlled Equipment in this Classification; Rock Crushers; Ross Carrier or Similar Machines; Roto-Mill; Scoops, Skimmer, two cu. yd. capacity and under; Sheep-Foot Roller (Self Propelled); Shovels; Skid Steer; Skimmer Scoops; Test Hole Drilling Machines; Tower Machines; Tower Mixers; Track Type End Loaders; Track Type Fork Lifts or High Lifts; Track Jacks and Tampers; Tractors, Side-boom; Trenching or Ditching Machine; Tunnelluggers; Vermeer-Type Saws; Wheel Type End Loaders; Winch Cat; Scoops, All or Tournapull.

CLASS 2. Air Compressors (six to eight)\*; Articulated Dumps; Asphalt Boosters and Heaters; Asphalt Distributors; Asphalt Plant Fireman; Boom or Winch Trucks; Building Elevators; Bull Floats or Flexplanes; Concrete Finishing Machine; Concrete Saws, Self-Propelled; Concrete Spreading Machines; Conveyors (six to eight)\*; Generators (six to eight)\*; Gravel or Stone Spreader, Power Operated; Hoist, Automatic; Hoist with One Drum and One Load Line; Light Plants (six to eight)\*; Mechanical Heaters (six to eight)\*; Mud Jacks; Off Road Water Wagons; Oiler on Two Paving Mixers When Used in Tandem; Post Hole Digger, Mechanical; Robotic Controlled Equipment in This Classification; Road or Street Sweeper, Self-Propelled; Rollers (except bituminous concrete); Scissor Hoist; Sea-man Tiller; Straw Machine; Vibratory Compactor; Water Pumps (six to eight)\*; Well Drill Machines.

CLASS 3. Air Compressors (one to five)\*; Air Compressors, Track or Self-Propelled; Bulk Cement Batching Plants; Conveyors (one to five)\*; Concrete Mixers (Except Plant, Paver, or Tower); Firemen; Generators (one to five)\*; Greasers; Helper on Single Paving Mixer; Light Plants (one to five)\*; Mechanic Helpers; Mechanical Heaters (one to five)\*; Oilers; Power Form Graders; Power Sub-Graders; Pug Mills when used for other than Asphalt operation; Robotic Controlled Equipment in This Classification; Tractors without power attachments, regardless of size or type; Truck Crane Oiler and Driver (1 man); Vibratory Hammer (power source); Water Pumps (one to five)\*; Welding Machines (one 300 Amp. or over)\*; Welding Machines (one to five)\*.

CLASS 4. Lattice Boom Crawler Crane; Lattice Boom Truck Crane; Telescopic Truck-Mounted Crane; Tower Crane.

\*Combinations of one to eight of any Air Compressors, Conveyors, Welding Machines, Water Pumps, Light Plants or Generators shall be in batteries or within 400 feet and shall be paid as per the Classification Schedule contained in this Article.

#### Other Classifications of Work:

For definitions of classifications not otherwise set out, the Department generally has on file such definitions which are available. If a task to be performed is not subject to one of the classifications of pay set out, the Department will upon being contacted state which neighboring county has such a classification and provide such rate, such rate being deemed to exist by reference in this document. If no neighboring county rate applies to the task, the Department shall undertake a special determination, such special determination being then deemed to have existed under this

determination. If a project requires these, or any classification not listed, please contact IDOL at 618/993-7271 for wage rates or clarifications.

#### LANDSCAPING

Landscaping work falls under the existing classifications for laborer, operating engineer and truck driver. The work performed by landscape plantsman and landscape laborer is covered by the existing classification of laborer. The work performed by landscape operators (regardless of equipment used or its size) is covered by the classifications of operating engineer. The work performed by landscape truck drivers (regardless of size of truck driven) is covered by the classifications of truck driver.

# Macon County Prevailing Wage for April 2007

Trade Name	RG	TYP	C	Base	FRMAN	*M-F>8	OSA	OSH	H/W	Pensn	Vac	Trng
=====	==	==	=	=====	=====	=====	==	==	=====	=====	=====	=====
ASBESTOS ABT-GEN		BLD		24.720	25.720	1.5	1.5	2.0	5.050	5.330	0.000	0.700
ASBESTOS ABT-MEC		BLD		25.290	26.290	1.5	1.5	2.0	4.450	2.500	0.000	0.250
BOILERMAKER		BLD		28.500	31.000	1.5	1.5	2.0	6.820	11.03	0.000	0.300
BRICK MASON		BLD		24.950	26.450	1.5	1.5	2.0	6.000	6.400	0.000	0.490
CARPENTER		BLD		25.250	27.250	1.5	1.5	2.0	6.500	7.140	0.000	0.320
CARPENTER		HWY		25.200	26.950	1.5	1.5	2.0	6.500	7.140	0.000	0.300
CEMENT MASON		BLD		24.270	25.020	1.5	1.5	2.0	6.500	6.890	0.000	0.300
CEMENT MASON		HWY		22.980	23.980	1.5	1.5	2.0	6.500	6.890	0.000	0.300
CERAMIC TILE FNSHER		BLD		23.600	0.000	1.5	1.5	2.0	6.000	6.400	0.000	0.000
ELECTRIC PWR EQMT OP		ALL		30.750	0.000	1.5	1.5	2.0	4.750	8.610	0.000	0.000
ELECTRIC PWR GRNDMAN		ALL		21.090	0.000	1.5	1.5	2.0	4.750	5.905	0.000	0.000
ELECTRIC PWR LINEMAN		ALL		34.160	36.350	1.5	1.5	2.0	4.750	9.560	0.000	0.000
ELECTRIC PWR TRK DRV		ALL		22.130	0.000	1.5	1.5	2.0	4.750	6.200	0.000	0.000
ELECTRICIAN		BLD		29.480	32.420	1.5	1.5	2.0	5.150	5.300	0.000	0.440
ELECTRONIC SYS TECH		BLD		24.370	25.870	1.5	1.5	2.0	5.150	3.650	0.000	0.250
ELEVATOR CONSTRUCTOR		BLD		34.190	38.460	2.0	2.0	2.0	8.275	6.060	2.050	0.000
GLAZIER		BLD		27.130	28.130	1.5	2.0	2.0	5.430	4.000	0.000	0.280
HT/FROST INSULATOR		BLD		30.440	31.440	1.5	1.5	2.0	4.850	8.360	0.000	0.450
IRON WORKER	E	ALL		26.420	28.170	1.5	1.5	2.0	6.590	6.150	0.000	0.500
IRON WORKER	W	BLD		25.400	27.150	1.5	1.5	2.0	5.860	7.900	0.000	0.300
IRON WORKER	W	HWY		25.400	26.900	1.5	1.5	2.0	5.860	7.900	0.000	0.300
LABORER		BLD		23.220	24.220	1.5	1.5	2.0	5.050	5.330	0.000	0.600
LABORER		HWY		24.220	24.970	1.5	1.5	2.0	5.050	5.330	0.000	0.600
LATHER		BLD		25.250	27.250	1.5	1.5	2.0	6.500	7.140	0.000	0.320
MACHINIST		BLD		36.890	38.890	2.0	2.0	2.0	4.380	5.650	2.550	0.000
MARBLE FINISHERS		BLD		23.600	0.000	1.5	1.5	2.0	6.000	6.400	0.000	0.000
MARBLE MASON		BLD		25.100	26.350	1.5	1.5	2.0	6.000	6.400	0.000	0.000
MILLWRIGHT		BLD		26.000	28.000	1.5	1.5	2.0	6.500	6.850	0.000	0.320
MILLWRIGHT		HWY		19.410	20.660	1.5	1.5	2.0	2.800	3.000	0.000	0.000
OPERATING ENGINEER		BLD	1	26.550	0.000	1.5	1.5	2.0	6.150	6.200	0.000	0.850
OPERATING ENGINEER		BLD	2	24.200	0.000	1.5	1.5	2.0	6.150	6.200	0.000	0.850
OPERATING ENGINEER		BLD	3	20.600	0.000	1.5	1.5	2.0	6.150	6.200	0.000	0.850
OPERATING ENGINEER		BLD	4	28.050	0.000	1.5	1.5	2.0	6.150	6.200	0.000	0.850
OPERATING ENGINEER		HWY	1	26.800	0.000	1.5	1.5	2.0	6.150	6.200	0.000	0.850
OPERATING ENGINEER		HWY	2	24.030	0.000	1.5	1.5	2.0	6.150	6.200	0.000	0.850
OPERATING ENGINEER		HWY	3	19.800	0.000	1.5	1.5	2.0	6.150	6.200	0.000	0.850
OPERATING ENGINEER		HWY	4	28.300	0.000	1.5	1.5	2.0	6.150	6.200	0.000	0.850
OPERATING ENGINEER		O&C		21.440	0.000	1.5	1.5	2.0	6.150	6.200	0.000	0.850
PAINTER		ALL		24.380	25.380	1.5	1.5	2.0	5.050	5.950	0.000	0.400
PAINTER OVER 30FT		ALL		25.380	26.380	1.5	1.5	2.0	5.050	5.950	0.000	0.400
PAINTER PWR EQMT		ALL		25.130	26.130	1.5	1.5	2.0	5.050	5.950	0.000	0.400
PILEDRIVER		BLD		25.750	27.750	1.5	1.5	2.0	6.500	7.140	0.000	0.320
PILEDRIVER		HWY		25.700	27.450	1.5	1.5	2.0	6.500	7.140	0.000	0.300
PIPEFITTER		BLD		32.480	34.980	1.5	1.5	2.0	6.450	4.800	0.000	0.670
PLASTERER		BLD		25.920	27.920	1.5	1.5	2.0	4.700	9.300	0.000	0.400
PLUMBER		BLD		32.480	34.980	1.5	1.5	2.0	6.450	4.800	0.000	0.670
ROOFER		BLD		22.350	24.850	1.5	1.5	2.0	6.000	5.550	0.000	0.550
SHEETMETAL WORKER		BLD		27.100	28.850	1.5	1.5	2.0	6.900	6.380	0.000	0.550
SPRINKLER FITTER		BLD		31.240	33.240	1.5	1.5	2.0	6.500	5.350	0.000	0.250
STONE MASON		BLD		24.950	26.450	1.5	1.5	2.0	6.000	6.400	0.000	0.490
TERRAZZO FINISHER		BLD		23.600	0.000	1.5	1.5	2.0	6.000	6.400	0.000	0.000
TERRAZZO MASON		BLD		25.100	26.350	1.5	1.5	2.0	6.000	6.400	0.000	0.000
TILE MASON		BLD		25.100	26.350	1.5	1.5	2.0	6.000	6.400	0.000	0.000
TRUCK DRIVER		ALL	1	25.930	0.000	1.5	1.5	2.0	7.250	3.425	0.000	0.000
TRUCK DRIVER		ALL	2	26.330	0.000	1.5	1.5	2.0	7.250	3.425	0.000	0.000
TRUCK DRIVER		ALL	3	26.530	0.000	1.5	1.5	2.0	7.250	3.425	0.000	0.000
TRUCK DRIVER		ALL	4	26.780	0.000	1.5	1.5	2.0	7.250	3.425	0.000	0.000
TRUCK DRIVER		ALL	5	27.530	0.000	1.5	1.5	2.0	7.250	3.425	0.000	0.000

TRUCK DRIVER	O&C 1	20.740	0.000	1.5	1.5	2.0	7.250	3.425	0.000	0.000
TRUCK DRIVER	O&C 2	21.060	0.000	1.5	1.5	2.0	7.250	3.425	0.000	0.000
TRUCK DRIVER	O&C 3	21.220	0.000	1.5	1.5	2.0	7.250	3.425	0.000	0.000
TRUCK DRIVER	O&C 4	21.420	0.000	1.5	1.5	2.0	7.250	3.425	0.000	0.000
TRUCK DRIVER	O&C 5	22.020	0.000	1.5	1.5	2.0	7.250	3.425	0.000	0.000
TUCKPOINTER	BLD	24.950	26.450	1.5	1.5	2.0	6.000	6.400	0.000	0.490

Legend:

M-F>8 (Overtime is required for any hour greater than 8 worked each day, Monday through Friday.)

OSA (Overtime is required for every hour worked on Saturday)

OSH (Overtime is required for every hour worked on Sunday and Holidays)

H/W (Health & Welfare Insurance)

Pensn (Pension)

Vac (Vacation)

Trng (Training)

## Explanations

### MACON COUNTY

IRON WORKERS (WEST) - West of a straight line just east of Route 51 to the southeast corner where Shelby, Macon and Moultrie counties meet.

The following list is considered as those days for which holiday rates of wages for work performed apply: New Years Day, Memorial/Decoration Day, Fourth of July, Labor Day, Veterans Day, Thanksgiving Day, Christmas Day. Generally, any of these holidays which fall on a Sunday is celebrated on the following Monday. This then makes work performed on that Monday payable at the appropriate overtime rate for holiday pay. Common practice in a given local may alter certain days of celebration such as the day after Thanksgiving for Veterans Day. If in doubt, please check with IDOL.

Oil and chip resealing (O&C) means the application of road oils and liquid asphalt to coat an existing road surface, followed by application of aggregate chips or gravel to coated surface, and subsequent rolling of material to seal the surface.

### EXPLANATION OF CLASSES

ASBESTOS - GENERAL - removal of asbestos material/mold and hazardous materials from any place in a building, including mechanical systems where those mechanical systems are to be removed. This includes the removal of asbestos materials/mold and hazardous materials from ductwork or pipes in a building when the building is to be demolished at the time or at some close future date.

ASBESTOS - MECHANICAL - removal of asbestos material from mechanical systems, such as pipes, ducts, and boilers, where the mechanical systems are to remain.

CERAMIC TILE FINISHER, MARBLE FINISHER, TERRAZZO FINISHER

Assisting, helping or supporting the tile, marble and terrazzo mechanic by performing their historic and traditional work assignments required to complete the proper installation of the work covered by said crafts. The term "Ceramic" is used for naming the classification only and is in no way a limitation of the product handled. Ceramic takes into consideration most hard tiles.

#### ELECTRONIC SYSTEMS TECHNICIAN

Installation, service and maintenance of low-voltage systems which utilizes the transmission and/or transference of voice, sound, vision, or digital for commercial, education, security and entertainment purposes for the following: TV monitoring and surveillance, background/foreground music, intercom and telephone interconnect, field programming, inventory control systems, microwave transmission, multi-media, multiplex, radio page, school, intercom and sound burglar alarms and low voltage master clock systems.

Excluded from this classification are energy management systems, life safety systems, supervisory controls and data acquisition systems not intrinsic with the above listed systems, fire alarm systems, nurse call systems and raceways exceeding fifteen feet in length.

#### TRUCK DRIVER - BUILDING, HEAVY AND HIGHWAY CONSTRUCTION

Class 1. Drivers on 2 axle trucks hauling less than 9 ton. Air compressor and welding machines and brooms, including those pulled by separate units, truck driver helpers, warehouse employees, mechanic helpers, greasers and tiremen, pickup trucks when hauling materials, tools, or workers to and from and on-the-job site, and fork lifts up to 6,000 lb. capacity.

Class 2. Two or three axle trucks hauling more than 9 ton but hauling less than 16 ton. A-frame winch trucks, hydrolift trucks, vector trucks or similar equipment when used for transportation purposes. Fork lifts over 6,000 lb. capacity, winch trucks, four axle combination units, and ticket writers.

Class 3. Two, three or four axle trucks hauling 16 ton or more. Drivers on water pulls, articulated dump trucks, mechanics and working forepersons, and dispatchers. Five axle or more combination units.

Class 4. Low Boy and Oil Distributors.

Class 5. Drivers who require special protective clothing while employed on hazardous waste work.

#### TRUCK DRIVER - OIL AND CHIP RESEALING ONLY.

This shall encompass laborers, workers and mechanics who drive contractor or subcontractor owned, leased, or hired pickup, dump, service, or oil distributor trucks. The work includes transporting materials and equipment (including but not limited to, oils, aggregate supplies, parts, machinery and tools) to or from the job site; distributing oil or liquid asphalt and aggregate; stock piling material when in connection with the actual oil and chip contract. The Truck Driver (Oil & Chip Resealing) wage classification does not include supplier delivered materials.

#### OPERATING ENGINEERS - BUILDING

CLASS 1. Asphalt Screed Man; Aspco Concrete Spreaders; Asphalt Pavers; Asphalt Plant Engineer; Asphalt Rollers on Bituminous Concrete; Athey Loaders; Backfillers, Crane Type; Backhoes; Barber

Green Loaders; Bulldozers; Cableways; Cherry Pickers; Clam Shells; C.M.I. & similar type autograde formless paver, autograde placer & finisher; Concrete Breakers; Concrete Pumps; Derricks; Derrick Boats; Draglines; Earth Auger or Boring Machines; Elevating Graders; Engineers on Dredges; Gravel Processing Machines; Head Equipment Greaser; High Lifts or Fork Lifts; Hoists with two or more drums or two or more load lines; Locomotives, All; Mechanics; Motor Graders or Auto Patrols; Operators or Leverman on Dredges; Operators, Power Boat; Operators, Pug Mill (Asphalt Plants); Orange Peels; Overhead Cranes; Paving Mixers; Piledrivers; Pipe Wrapping and Painting Machines; Pushdozers, or Push Cats; Robotic Controlled Equipment in this Classification; Rock Crushers; Ross Carrier or Similar Machines; Rotomill; Scoops, Skimmer, two cu. yd. capacity and under; Scoops, All or Tournapull; Sheep-Foot Roller (Self Propelled); Shovels; Skid Steer; Skimmer Scoops; Temporary Concrete Plant Operators; Test Hole Drilling Machines; Tower Machines; Tower Mixers; Track Type End Loaders; Track Type Fork Lifts or High Lifts; Track Jacks and Tampers; Tractors, Sideboom; Trenching or Ditching Machine; Tunnelluggers; Vermeer Type Saws; Water Blaster Cutting Head; Wheel Type End Loaders; Winch Cat.

CLASS 2. Air Compressors (six to eight)\*; Asphalt Boosters and Heaters; Asphalt Distributors; Asphalt Plant Fireman; Oiler on Two Paving Mixers When Used in Tandem; Boom or Winch Trucks; Bull Floats or Flexplanes; Concrete Finishing Machine; Concrete Saws, Self-Propelled; Concrete Spreading Machines; Conveyors (six to eight)\*; Generators (six to eight)\*; Gravel or Stone Spreader, Power Operated; Hoist (with One Drum and One Load Line); Light Plants (six to eight)\*; Mechanical Heaters (six to eight)\*; Mud Jacks; Post Hole Digger, Mechanical; Pug Mills when used for other than Asphalt operation; Robotic Controlled Equipment in this Classification; Road or Street Sweeper, Self Propelled; Rollers (except bituminous concrete); Seaman Tiller; Straw Machine; Vibratory Compactor; Water Blaster, Power Unit; Welding Machines (six to eight)\*; Well Drill Machines.

CLASS 3. Air Compressors(one to five)\*; Air Compressors, Track or Self-Propelled; Automatic Hoist; Building Elevators; Bulk Cement Batching Plants; Conveyors (one to five)\*; Concrete Mixers (Except Plant, Paver, or Tower); Firemen; Generators (one to five)\*; Greasers; Helper on Single Paving Mixer; Hoist, Automatic; Light Plants (one to five)\*; Mechanic Helpers; Mechanical Heaters (one to five)\*; Oilers; Power Form Graders; Power Sub-Graders; Robotic Controlled Equipment in this Classification; Scissors Hoist; Tractors without power attachments regardless of size or type; Truck Crane Oiler and Driver (1 man); Vibratory Hammer (power source); Water Pumps (one to five)\*; Welding Machines (1/300 Amp. or over)\*; Welding machines (one to five)\*

CLASS 4. Lattice Boom Crawler Cranes; Lattice Boom Truck Cranes; Telescopic Truck-Mounted Cranes; Tower Cranes.

\* Combinations of one to eight of any Air Compressors, Conveyors, Welding Machines, Water Pumps, Light Plants, or Generators shall be in batteries or within 400 feet and shall be paid as per the Classification Schedule contained in this Article.

#### OPERATING ENGINEERS - HIGHWAY

CLASS 1. Asphalt Screed Man; Asphco Concrete Spreaders; Asphalt Pavers; Asphalt Plant Engineer; Asphalt Rollers on Bituminous Concrete; Athey Loaders; Backhoes; Barber Green Loaders; Bulldozers;

Cableways; Carry Deck Pickers; Cherry Pickers (Rough Terrain); C.M.I. & similar type-autograde formless paver, autograde placer & finisher; Concrete Breakers; Concrete Plant Operators; Concrete Pumps; Derricks; Derrick Boats; Dewatering Systems; Earth Auger or Boring Machines; Elevating Graders; Engineers on Dredges; Gravel Processing Machines; Grout Pump; Head Equipment Greaser; High Lifts or Fork Lifts; Hoists with two or more drums or two or more load lines; Hydro Jet or Hydro Laser; Locomotives, All; Mechanics; Motor Graders or Auto Patrols; Multi-Point Power Lifting Equipment; Operators or Leverman on Dredges; Operators, Power Boat; Operators, Pug Mill (Asphalt Plants); Overhead Cranes; Paving Mixers; Piledrivers; Pipe Wrapping and Painting Machines; Push-dozers, or Push Cats; Robotic Controlled Equipment in this Classification; Rock Crushers; Ross Carrier or Similar Machines; Roto-Mill; Scoops, Skimmer, two cu. yd. capacity and under; Sheep-Foot Roller (Self Pro-pelled); Shovels; Skid Steer; Skimmer Scoops; Test Hole Drilling Machines; Tower Machines; Tower Mixers; Track Type End Loaders; Track Type Fork Lifts or High Lifts; Track Jacks and Tampers; Tractors, Side-boom; Trenching or Ditching Machine; Tunnelluggers; Vermeer-Type Saws; Wheel Type End Loaders; Winch Cat; Scoops, All or Tournapull.

CLASS 2. Air Compressors (six to eight)\*; Articulated Dumps; Asphalt Boosters and Heaters; Asphalt Distributors; Asphalt Plant Fireman; Boom or Winch Trucks; Building Elevators; Bull Floats or Flexplanes; Concrete Finishing Machine; Concrete Saws, Self-Propelled; Concrete Spreading Machines; Conveyors (six to eight)\*; Generators (six to eight)\*; Gravel or Stone Spreader, Power Operated; Hoist, Automatic; Hoist with One Drum and One Load Line; Light Plants (six to eight)\*; Mechanical Heaters (six to eight)\*; Mud Jacks; Off Road Water Wagons; Oiler on Two Paving Mixers When Used in Tandem; Post Hole Digger, Mechanical; Robotic Controlled Equipment in This Classification; Road or Street Sweeper, Self-Propelled; Rollers (except bituminous concrete); Scissor Hoist; Sea-man Tiller; Straw Machine; Vibratory Compactor; Water Pumps (six to eight)\*; Well Drill Machines.

CLASS 3. Air Compressors (one to five)\*; Air Compressors, Track or Self-Propelled; Bulk Cement Batching Plants; Conveyors (one to five)\*; Concrete Mixers (Except Plant, Paver, or Tower); Firemen; Generators (one to five)\*; Greasers; Helper on Single Paving Mixer; Light Plants (one to five)\*; Mechanic Helpers; Mechanical Heaters (one to five)\*; Oilers; Power Form Graders; Power Sub-Graders; Pug Mills when used for other than Asphalt operation; Robotic Controlled Equipment in This Classification; Tractors without power attachments, regardless of size or type; Truck Crane Oiler and Driver (1 man); Vibratory Hammer (power source); Water Pumps (oneto five)\*; Welding Machines (one 300 Amp. or over)\*; Welding Machines (one to five)\*.

CLASS 4. Lattice Boom Crawler Crane; Lattice Boom Truck Crane; Telescopic Truck-Mounted Crane; Tower Crane.

\*Combinations of one to eight of any Air Compressors, Conveyors, Welding Machines, Water Pumps, Light Plants or Generators shall be in batteries or within 400 feet and shall be paid as per the Classification Schedule contained in this Article.

OPERATING ENGINEER - OIL AND CHIP RESEALING ONLY.

This shall encompass the operation of all motorized heavy equipment used in oil and chip resealing, including but not limited to operating self-propelled chip spreaders, and all types of rollers (both hard and rubber tired); and other duties pertaining to the operation or maintenance of heavy equipment related to oil & chip resealing.

Other Classifications of Work:

For definitions of classifications not otherwise set out, the Department generally has on file such definitions which are available. If a task to be performed is not subject to one of the classifications of pay set out, the Department will upon being contacted state which neighboring county has such a classification and provide such rate, such rate being deemed to exist by reference in this document. If no neighboring county rate applies to the task, the Department shall undertake a special determination, such special determination being then deemed to have existed under this determination. If a project requires these, or any classification not listed, please contact IDOL at 618/993-7271 for wage rates or clarifications.

LANDSCAPING

Landscaping work falls under the existing classifications for laborer, operating engineer and truck driver. The work performed by landscape plantsman and landscape laborer is covered by the existing classification of laborer. The work performed by landscape operators (regardless of equipment used or its size) is covered by the classifications of operating engineer. The work performed by landscape truck drivers (regardless of size of truck driven) is covered by the classifications of truck driver.



# Macoupin County Prevailing Wage for April 2007

Trade Name	RG	TYP	C	Base	FRMAN	*M-F>8	OSA	OSH	H/W	Pensn	Vac	Trng
=====	==	==	=	=====	=====	=====	==	==	=====	=====	=====	=====
ASBESTOS ABT-GEN		ALL		25.000	25.500	1.5	1.5	2.0	5.050	6.000	0.000	0.600
ASBESTOS ABT-MEC		BLD		25.290	26.290	1.5	1.5	2.0	4.450	2.500	0.000	0.250
BOILERMAKER		BLD		28.500	31.000	1.5	1.5	2.0	6.820	11.03	0.000	0.300
BRICK MASON	N	BLD		24.370	25.370	1.5	1.5	2.0	6.000	5.400	0.000	0.490
BRICK MASON	S	BLD		26.400	28.100	1.5	1.5	5.0	4.750	8.250	2.000	0.390
CARPENTER	N	BLD		25.910	27.910	1.5	1.5	2.0	6.500	6.480	0.000	0.320
CARPENTER	N	HWY		25.750	27.500	1.5	1.5	2.0	6.500	6.500	0.000	0.300
CARPENTER	S	BLD		24.520	26.520	1.5	1.5	2.0	6.500	7.870	0.000	0.320
CARPENTER	S	HWY		25.050	26.800	1.5	1.5	2.0	6.500	7.200	0.000	0.300
CEMENT MASON		ALL		26.750	27.500	1.5	1.5	2.0	5.650	8.250	0.000	0.200
CERAMIC TILE FNSHER		BLD		22.610	0.000	1.5	1.5	2.0	5.000	4.300	0.000	0.400
ELECTRIC PWR EQMT OP	N	ALL		30.750	0.000	1.5	1.5	2.0	4.750	8.610	0.000	0.000
ELECTRIC PWR EQMT OP	S	ALL		31.510	37.980	1.5	2.0	2.0	4.530	7.880	0.000	0.160
ELECTRIC PWR GRNDMAN	N	ALL		21.090	0.000	1.5	1.5	2.0	4.750	5.905	0.000	0.000
ELECTRIC PWR GRNDMAN	S	ALL		23.530	37.980	1.5	2.0	2.0	3.380	5.890	0.000	0.120
ELECTRIC PWR LINEMAN	N	ALL		34.160	36.350	1.5	1.5	2.0	4.750	9.560	0.000	0.000
ELECTRIC PWR LINEMAN	S	ALL		36.220	37.980	1.5	2.0	2.0	5.210	9.060	0.000	0.180
ELECTRIC PWR TRK DRV	N	ALL		22.130	0.000	1.5	1.5	2.0	4.750	6.200	0.000	0.000
ELECTRIC PWR TRK DRV	S	ALL		25.710	37.980	1.5	2.0	2.0	3.700	6.430	0.000	0.130
ELECTRICIAN	N	BLD		31.220	33.220	1.5	1.5	2.0	5.150	5.340	0.000	0.300
ELECTRICIAN	S	ALL		32.590	34.550	1.5	1.5	2.0	5.210	6.360	0.000	0.490
ELECTRONIC SYS TECH	N	BLD		25.810	27.310	1.5	1.5	2.0	2.800	5.490	0.000	0.250
ELECTRONIC SYS TECH	S	BLD		24.240	25.740	1.5	1.5	2.0	5.650	4.730	0.000	0.250
ELEVATOR CONSTRUCTOR		BLD		37.115	41.750	2.0	2.0	2.0	8.275	4.460	2.227	0.000
GLAZIER	N	BLD		27.130	28.130	1.5	2.0	2.0	5.430	4.000	0.000	0.280
GLAZIER	S	BLD		29.480	0.000	2.0	2.0	2.0	8.550	6.920	2.360	0.160
HT/FROST INSULATOR		BLD		30.440	31.440	1.5	1.5	2.0	4.850	8.360	0.000	0.450
IRON WORKER	N	BLD		25.400	27.150	1.5	1.5	2.0	5.860	7.900	0.000	0.300
IRON WORKER	N	HWY		25.400	26.900	1.5	1.5	2.0	5.860	7.900	0.000	0.300
IRON WORKER	S	ALL		26.350	27.850	1.5	1.5	2.0	6.360	8.250	0.000	0.420
LABORER		ALL		24.500	25.000	1.5	1.5	2.0	5.050	6.000	0.000	0.600
LATHER		BLD		25.910	27.910	1.5	1.5	2.0	6.500	6.480	0.000	0.320
MACHINIST		BLD		36.890	38.890	2.0	2.0	2.0	4.380	5.650	2.550	0.000
MARBLE FINISHERS		BLD		22.610	0.000	1.5	1.5	2.0	5.000	4.300	0.000	0.400
MARBLE MASON		BLD		24.520	25.270	1.5	1.5	2.0	6.000	5.400	0.000	0.000
MILLWRIGHT		BLD		26.000	28.000	1.5	1.5	2.0	6.500	6.850	0.000	0.320
MILLWRIGHT		HWY		19.270	20.520	1.5	1.5	2.0	2.800	3.000	0.000	0.000
OPERATING ENGINEER		ALL	1	25.900	27.030	1.5	1.5	2.0	6.200	11.45	0.000	1.000
OPERATING ENGINEER		ALL	2	24.770	27.030	1.5	1.5	2.0	6.200	11.45	0.000	1.000
OPERATING ENGINEER		ALL	3	20.290	27.030	1.5	1.5	2.0	6.200	11.45	0.000	1.000
OPERATING ENGINEER		ALL	4	20.350	27.030	1.5	1.5	2.0	6.200	11.45	0.000	1.000
OPERATING ENGINEER		ALL	5	20.020	27.030	1.5	1.5	2.0	6.200	11.45	0.000	1.000
OPERATING ENGINEER		ALL	6	26.450	27.030	1.5	1.5	2.0	6.200	11.45	0.000	1.000
OPERATING ENGINEER		ALL	7	26.750	27.030	1.5	1.5	2.0	6.200	11.45	0.000	1.000
OPERATING ENGINEER		ALL	8	27.030	27.030	1.5	1.5	2.0	6.200	11.45	0.000	1.000
PAINTER		BLD		25.700	26.700	1.5	1.5	2.0	4.650	5.150	0.000	0.350
PAINTER		HWY		26.800	27.800	1.5	1.5	2.0	4.650	5.150	0.000	0.350
PAINTER OVER 30FT		BLD		26.700	27.700	1.5	1.5	2.0	4.650	5.150	0.000	0.350
PAINTER PWR EQMT		BLD		26.700	27.700	1.5	1.5	2.0	4.650	5.150	0.000	0.350
PAINTER PWR EQMT		HWY		27.800	28.800	1.5	1.5	2.0	4.650	5.150	0.000	0.350
PILEDRIIVER	N	BLD		26.410	28.410	1.5	1.5	2.0	6.500	6.480	0.000	0.320
PILEDRIIVER	N	HWY		26.250	28.000	1.5	1.5	2.0	6.500	6.500	0.000	0.300
PILEDRIIVER	S	BLD		25.020	27.020	1.5	1.5	2.0	6.500	7.870	0.000	0.320
PILEDRIIVER	S	HWY		25.550	27.300	1.5	1.5	2.0	6.500	7.200	0.000	0.300
PIPEFITTER	N	BLD		34.700	37.200	1.5	1.5	2.0	6.450	4.750	0.000	0.350
PIPEFITTER	S	BLD		30.600	32.100	2.0	2.0	2.0	5.350	6.100	0.000	0.130
PLASTERER		BLD		27.000	28.000	1.5	1.5	2.0	5.650	7.250	0.000	0.250
PLUMBER	N	BLD		34.700	37.200	1.5	1.5	2.0	6.450	4.750	0.000	0.350

PLUMBER	S	BLD	30.600	32.100	2.0	2.0	2.0	5.350	6.100	0.000	0.130
ROOFER		BLD	24.310	26.740	1.5	1.5	2.0	4.650	5.250	0.000	0.100
SHEETMETAL WORKER		ALL	27.210	28.460	1.5	1.5	2.0	6.000	4.770	1.630	0.120
SPRINKLER FITTER		BLD	34.230	36.480	2.0	2.0	2.0	6.650	7.850	0.000	0.650
STONE MASON		BLD	24.370	25.370	1.5	1.5	2.0	6.000	5.400	0.000	0.490
TERRAZZO FINISHER		BLD	31.240	0.000	1.5	1.5	2.0	0.000	0.000	0.000	0.000
TERRAZZO MASON		BLD	30.780	31.080	1.5	1.5	2.0	0.000	3.750	0.000	0.000
TILE MASON		BLD	29.050	29.350	1.5	1.5	2.0	0.000	3.750	0.000	0.000
TRUCK DRIVER		ALL 1	25.930	0.000	1.5	1.5	2.0	7.250	3.425	0.000	0.000
TRUCK DRIVER		ALL 2	26.330	0.000	1.5	1.5	2.0	7.250	3.425	0.000	0.000
TRUCK DRIVER		ALL 3	26.530	0.000	1.5	1.5	2.0	7.250	3.425	0.000	0.000
TRUCK DRIVER		ALL 4	26.780	0.000	1.5	1.5	2.0	7.250	3.425	0.000	0.000
TRUCK DRIVER		ALL 5	27.530	0.000	1.5	1.5	2.0	7.250	3.425	0.000	0.000
TRUCK DRIVER		O&C 1	20.740	0.000	1.5	1.5	2.0	7.250	3.425	0.000	0.000
TRUCK DRIVER		O&C 2	21.060	0.000	1.5	1.5	2.0	7.250	3.425	0.000	0.000
TRUCK DRIVER		O&C 3	21.220	0.000	1.5	1.5	2.0	7.250	3.425	0.000	0.000
TRUCK DRIVER		O&C 4	21.420	0.000	1.5	1.5	2.0	7.250	3.425	0.000	0.000
TRUCK DRIVER		O&C 5	22.020	0.000	1.5	1.5	2.0	7.250	3.425	0.000	0.000
TUCKPOINTER	N	BLD	24.370	25.370	1.5	1.5	2.0	6.000	5.400	0.000	0.490

Legend:

M-F>8 (Overtime is required for any hour greater than 8 worked each day, Monday through Friday.)

OSA (Overtime is required for every hour worked on Saturday)

OSH (Overtime is required for every hour worked on Sunday and Holidays)

H/W (Health & Welfare Insurance)

Pensn (Pension)

Vac (Vacation)

Trng (Training)

## Explanations

MACOUPIN COUNTY

BRICKLAYERS (SOUTH) - Approximately the Southern 1/3 of the county including Hornsby (approx.).

CARPENTERS & PILEDRIVERS (NORTH) - North of Route 108.

ELECTRICIAN (NORTH) - Townships of Scottsville, North Palmyra, North Otter, Virden, Girard, Barr, South Palmyra, South Otter and Nilwood.

ELECTRICIAN (SOUTH) - Townships of Western Mound, Bird, Carlinville, Shaws Point, Chesterfield, Polk, Brushy Mound, Honey Point, Shipman, Hillyard, Gillespie, Cahokia, Bunker Hill, Dorchester, Mount Olive and Staunton.

GLAZIER (SOUTH) - South of Highway 108.

IRONWORKERS (SOUTH) - That part of the county South of a diagonal line between Rockbridge (Greene County) and Litchfield (Montgomery County).

PLUMBERS AND PIPEFITTERS (NORTH) - That part of the county North of Route 108.

The following list is considered as those days for which holiday rates of wages for work performed apply: New Years Day, Memorial/Decoration Day, Fourth of July, Labor Day, Veterans Day, Thanksgiving Day, Christmas Day. Generally, any of these holidays which fall on a Sunday is celebrated on the following Monday. This then makes work performed on that Monday payable at the appropriate overtime rate for holiday pay. Common practice in a given local may alter certain days of celebration such as the day after Thanksgiving for Veterans Day. If in doubt, please check with IDOL.

Oil and chip resealing (O&C) means the application of road oils and liquid asphalt to coat an existing road surface, followed by application of aggregate chips or gravel to coated surface, and subsequent rolling of material to seal the surface.

#### EXPLANATION OF CLASSES

ASBESTOS - GENERAL - removal of asbestos material/mold and hazardous materials from any place in a building, including mechanical systems where those mechanical systems are to be removed. This includes the removal of asbestos materials/mold and hazardous materials from ductwork or pipes in a building when the building is to be demolished at the time or at some close future date.

ASBESTOS - MECHANICAL - removal of asbestos material from mechanical systems, such as pipes, ducts, and boilers, where the mechanical systems are to remain.

#### CERAMIC TILE FINISHER AND MARBLE FINISHER

The handling, at the building site, of all sand, cement, tile, marble or stone and all other materials that may be used and installed by [a] tile layer or marble mason. In addition, the grouting, cleaning, sealing, and mixing on the job site, and all other work as required in assisting the setter. The term "Ceramic" is used for naming the classification only and is in no way a limitation of the product handled. Ceramic takes into consideration most hard tiles.

#### ELECTRONIC SYSTEMS TECHNICIAN

Installation, service and maintenance of low-voltage systems which utilizes the transmission and/or transference of voice, sound, vision, or digital for commercial, education, security and entertainment purposes for the following: TV monitoring and surveillance, background/foreground music, intercom and telephone interconnect, field programming, inventory control systems, microwave transmission, multi-media, multiplex, radio page, school, intercom and sound burglar alarms and low voltage master clock systems.

Excluded from this classification are energy management systems, life safety systems, supervisory controls and data acquisition systems not intrinsic with the above listed systems, fire alarm systems, nurse call systems and raceways exceeding fifteen feet in length.

#### TRUCK DRIVER - BUILDING, HEAVY AND HIGHWAY CONSTRUCTION

Class 1. Drivers on 2 axle trucks hauling less than 9 ton. Air compressor and welding machines and brooms, including those pulled by separate units, truck driver helpers, warehouse employees, mechanic helpers, greasers and tiremen, pickup trucks when hauling materials, tools, or workers to and from and on-the-job site, and fork lifts up

to 6,000 lb. capacity.

Class 2. Two or three axle trucks hauling more than 9 ton but hauling less than 16 ton. A-frame winch trucks, hydrolift trucks, vactor trucks or similar equipment when used for transportation purposes. Fork lifts over 6,000 lb. capacity, winch trucks, four axle combination units, and ticket writers.

Class 3. Two, three or four axle trucks hauling 16 ton or more. Drivers on water pulls, articulated dump trucks, mechanics and working forepersons, and dispatchers. Five axle or more combination units.

Class 4. Low Boy and Oil Distributors.

Class 5. Drivers who require special protective clothing while employed on hazardous waste work.

TRUCK DRIVER - OIL AND CHIP RESEALING ONLY.

This shall encompass laborers, workers and mechanics who drive contractor or subcontractor owned, leased, or hired pickup, dump, service, or oil distributor trucks. The work includes transporting materials and equipment (including but not limited to, oils, aggregate supplies, parts, machinery and tools) to or from the job site; distributing oil or liquid asphalt and aggregate; stock piling material when in connection with the actual oil and chip contract. The Truck Driver (Oil & Chip Resealing) wage classification does not include supplier delivered materials.

OPERATING ENGINEERS

GROUP I. Cranes, Dragline, Shovels, Skimmer Scoops, Clamshells or Derrick Boats, Pile Drivers, Crane-Type Backhoes, Asphalt Plant Operators, Concrete Plant Operators, Dredges, Asphalt Spreading Machines, All Locomotives, Cable Ways, or Tower Machines, Hoists, Hydraulic Backhoes, Ditching Machines or Backfiller, Cherrypickers, Overhead Cranes, Roller, Steam or Gas, Concrete Pavers, Excavators, Concrete Breakers, Concrete Pumps, Bulk Cement Plants, Cement Pumps, Derrick-Type Drills, Boat Operators, Motor Graders or Pushcats, Scoops or Tournapulls, Bulldozers, Endloaders or Fork Lifts, Power Blade or Elevating Graders, Winch Cats, Boom or Winch Trucks or Boom Tractors, Pipe Wrapping or Painting Machines, Asphalt Plant Engineer, Journeyman Lubricating Engineer, Drills (other than Derrick Type), Mud Jacks, or Well Drilling Machines, Boring Machines or Track Jacks, Mixers, Conveyors (Two), Air Compressors (Two), Water Pumps regardless of size (Two), Welding Machines (Two), Siphons or Jets (Two), Winch Heads or Apparatuses (Two), Light Plants (Two), Waterblasters (two), All Tractors regardless of size (straight tractor only), Fireman on Stationary Boilers, Automatic Elevators, Form Grading Machines, Finishing Machines, Power Sub-Grader or Ribbon Machines, Longitudinal Floats, Distributor Operators on Trucks, Winch Heads or Apparatuses (One), Mobil Track air and heaters (two to five), Heavy Equipment Greaser, Relief Operator, Assistant Master Mechanic and Heavy Duty Mechanic, all Operators (except those listed below).

GROUP II. Assistant Operators.

GROUP III. Air Compressors (One), Water Pumps, regardless of Size (One), Waterblasters (one), Welding Machine (One), Mixers (One Bag), Conveyor (One), Siphon or Jet (One), Light Plant (One), Heater (One), Immobile Track Air (One), and Self Propelled Walk-Behind Rollers.

GROUP IV. Asphalt Spreader Oilers, Fireman on Whirlies and Heavy Equipment Oilers, Truck Cranes, Dredges, Monigans, Large Cranes - (Over 65-ton rated capacity) Concrete Plant Oiler, Blacktop Plant Oiler, and Creter Crane Oiler (when required).

GROUP V. Oiler.

GROUP VI. Master Mechanics, Operators on equipment with Booms, including jibs, 100 feet and over, and less than 150 feet long.

GROUP VII. Operators on equipment with Booms, including jibs, 150 feet and over, and less than 200 feet long.

GROUP VIII. Operators on Equipment with Booms, including jibs, 200 feet and over; Tower Cranes; Whirlie Cranes; and Operator Foreman.

#### TERRAZZO FINISHER

The handling of all materials used for Mosaic and Terrazzo work including preparing, mixing by hand, by mixing machine or transporting of pre-mixed materials and distributing with shovel, rake, hoe, or pail, all kinds of concrete foundations necessary for Mosaic and Terrazzo work, all cement terrazzo, magnesite terrazzo, Do-O-Tex terrazzo, epoxy matrix ter-razzo, exposed aggregate, rustic or rough washed for exterior or interior of buildings placed either by machine or by hand, and any other kind of mixture of plastics composed of chips or granules when mixed with cement, rubber, neoprene, vinyl, magnesium chloride or any other resinous or chemical substances used for seamless flooring systems, and all other building materials, all similar materials and all precast terrazzo work on jobs, all scratch coat used for Mosaic and Terrazzo work and sub-bed, tar paper and wire mesh (2x2 etc.) or lath. The rubbing, grinding, cleaning and finishing of same either by hand or by machine or by terrazzo resurfacing equipment on new or existing floors. When necessary finishers shall be allowed to assist the mechanics to spread sand bed, lay tarpaper and wire mesh (2x2 etc.) or lath. The finishing of cement floors where additional aggregate of stone is added by spreading or sprinkling on top of the finished base, and troweled or rolled into the finish and then the surface is ground by grinding machines.

#### Other Classifications of Work:

For definitions of classifications not otherwise set out, the Department generally has on file such definitions which are available. If a task to be performed is not subject to one of the classifications of pay set out, the Department will upon being contacted state which neighboring county has such a classification and provide such rate, such rate being deemed to exist by reference in this document. If no neighboring county rate applies to the task, the Department shall undertake a special determination, such special determination being then deemed to have existed under this determination. If a project requires these, or any classification not listed, please contact IDOL at 618/993-7271 for wage rates or clarifications.

#### LANDSCAPING

Landscaping work falls under the existing classifications for laborer, operating engineer and truck driver. The work performed by landscape plantsman and landscape laborer is covered by the existing classification of laborer. The work performed by landscape operators

(regardless of equipment used or its size) is covered by the classifications of operating engineer. The work performed by landscape truck drivers (regardless of size of truck driven) is covered by the classifications of truck driver.

# Madison County Prevailing Wage for April 2007

Trade Name	RG	TYP	C	Base	FRMAN	*M-F>8	OSA	OSH	H/W	Pensn	Vac	Trng
ASBESTOS ABT-GEN	NW	ALL		24.250	24.750	1.5	1.5	2.0	5.050	6.750	0.000	0.600
ASBESTOS ABT-GEN	SE	ALL		24.750	25.250	1.5	1.5	2.0	5.250	6.350	0.000	0.600
ASBESTOS ABT-MEC		BLD		25.290	26.290	1.5	1.5	2.0	4.450	2.500	0.000	0.250
BOILERMAKER		BLD		28.500	31.000	1.5	1.5	2.0	6.820	11.03	0.000	0.300
BRICK MASON		BLD		26.400	28.100	1.5	1.5	5.0	4.750	8.250	2.000	0.390
CARPENTER		ALL		30.480	31.980	1.5	1.5	2.0	5.050	3.750	0.000	0.350
CEMENT MASON		ALL		26.750	27.500	1.5	1.5	2.0	5.650	8.250	0.000	0.200
CERAMIC TILE FNSHER		BLD		22.610	0.000	1.5	1.5	2.0	5.000	4.300	0.000	0.400
ELECTRIC PWR EQMT OP	NW	ALL		29.470	36.150	1.5	2.0	2.0	5.400	7.380	0.000	0.150
ELECTRIC PWR EQMT OP	SE	ALL		31.510	37.980	1.5	2.0	2.0	4.530	7.880	0.000	0.160
ELECTRIC PWR GRNDMAN	NW	ALL		19.820	36.150	1.5	2.0	2.0	5.400	4.960	0.000	0.100
ELECTRIC PWR GRNDMAN	SE	ALL		23.530	37.980	1.5	2.0	2.0	3.380	5.890	0.000	0.120
ELECTRIC PWR LINEMAN	NW	ALL		34.120	36.150	1.5	2.0	2.0	5.400	8.530	0.000	0.170
ELECTRIC PWR LINEMAN	SE	ALL		36.220	37.980	1.5	2.0	2.0	5.210	9.060	0.000	0.180
ELECTRIC PWR TRK DRV	NW	ALL		22.060	36.150	1.5	2.0	2.0	5.400	5.530	0.000	0.110
ELECTRIC PWR TRK DRV	SE	ALL		25.710	37.980	1.5	2.0	2.0	3.700	6.430	0.000	0.130
ELECTRICIAN	NW	ALL		30.110	32.110	1.5	1.5	2.0	5.400	6.950	0.000	0.210
ELECTRICIAN	SE	ALL		32.590	34.550	1.5	1.5	2.0	5.210	6.360	0.000	0.490
ELECTRONIC SYS TECH	NW	BLD		24.240	25.740	1.5	1.5	2.0	5.650	4.730	0.000	0.250
ELECTRONIC SYS TECH	SE	BLD		25.810	27.310	1.5	1.5	2.0	2.800	5.490	0.000	0.250
ELEVATOR CONSTRUCTOR		BLD		37.115	41.750	2.0	2.0	2.0	8.275	4.460	2.227	0.000
FLOOR LAYER		BLD		26.930	27.680	1.5	1.5	2.0	5.000	3.750	0.000	0.350
GLAZIER		BLD		29.480	0.000	2.0	2.0	2.0	8.550	6.920	2.360	0.160
HT/FROST INSULATOR		BLD		30.440	31.440	1.5	1.5	2.0	4.850	8.360	0.000	0.450
IRON WORKER		ALL		26.350	27.850	1.5	1.5	2.0	6.360	8.250	0.000	0.420
LABORER	NW	ALL		23.750	24.250	1.5	1.5	2.0	5.050	6.750	0.000	0.600
LABORER	SE	ALL		24.250	24.750	1.5	1.5	2.0	5.250	6.350	0.000	0.600
MACHINIST		BLD		36.890	38.890	2.0	2.0	2.0	4.380	5.650	2.550	0.000
MARBLE FINISHERS		BLD		22.610	0.000	1.5	1.5	2.0	5.000	4.300	0.000	0.400
MARBLE MASON		BLD		26.400	28.100	1.5	1.5	5.0	4.750	8.250	2.000	0.390
MILLWRIGHT		ALL		30.480	31.980	1.5	1.5	2.0	5.050	3.750	0.000	0.350
OPERATING ENGINEER		ALL	1	25.900	27.030	1.5	1.5	2.0	6.200	11.45	0.000	1.000
OPERATING ENGINEER		ALL	2	24.770	27.030	1.5	1.5	2.0	6.200	11.45	0.000	1.000
OPERATING ENGINEER		ALL	3	20.290	27.030	1.5	1.5	2.0	6.200	11.45	0.000	1.000
OPERATING ENGINEER		ALL	4	20.350	27.030	1.5	1.5	2.0	6.200	11.45	0.000	1.000
OPERATING ENGINEER		ALL	5	20.020	27.030	1.5	1.5	2.0	6.200	11.45	0.000	1.000
OPERATING ENGINEER		ALL	6	26.450	27.030	1.5	1.5	2.0	6.200	11.45	0.000	1.000
OPERATING ENGINEER		ALL	7	26.750	27.030	1.5	1.5	2.0	6.200	11.45	0.000	1.000
OPERATING ENGINEER		ALL	8	27.030	27.030	1.5	1.5	2.0	6.200	11.45	0.000	1.000
PAINTER		BLD		25.700	26.700	1.5	1.5	2.0	4.650	5.150	0.000	0.350
PAINTER		HWY		26.800	27.800	1.5	1.5	2.0	4.650	5.150	0.000	0.350
PAINTER OVER 30FT		BLD		26.700	27.700	1.5	1.5	2.0	4.650	5.150	0.000	0.350
PAINTER PWR EQMT		BLD		26.700	27.700	1.5	1.5	2.0	4.650	5.150	0.000	0.350
PAINTER PWR EQMT		HWY		27.800	28.800	1.5	1.5	2.0	4.650	5.150	0.000	0.350
PILEDRIVER		ALL		30.480	31.980	1.5	1.5	2.0	5.050	3.750	0.000	0.350
PIPEFITTER	N	BLD		30.600	32.100	2.0	2.0	2.0	5.350	6.100	0.000	0.130
PIPEFITTER	S	BLD		30.000	32.000	1.5	1.5	2.0	5.940	7.000	0.000	0.350
PLASTERER		BLD		27.000	28.000	1.5	1.5	2.0	5.650	7.250	0.000	0.250
PLUMBER	N	BLD		30.600	32.100	2.0	2.0	2.0	5.350	6.100	0.000	0.130
PLUMBER	S	BLD		30.450	32.950	1.5	1.5	2.0	4.950	5.450	0.000	0.300
ROOFER		BLD		26.250	28.250	1.5	1.5	2.0	6.100	5.950	0.000	0.200
SHEETMETAL WORKER		ALL		27.210	28.460	1.5	1.5	2.0	6.000	4.770	1.630	0.120
SPRINKLER FITTER		BLD		34.230	36.480	2.0	2.0	2.0	6.650	7.850	0.000	0.650
TERRAZZO FINISHER		BLD		31.240	0.000	1.5	1.5	2.0	0.000	0.000	0.000	0.000
TERRAZZO MASON		BLD		30.780	31.080	1.5	1.5	2.0	0.000	3.750	0.000	0.000
TRUCK DRIVER		ALL	1	25.930	0.000	1.5	1.5	2.0	7.250	3.425	0.000	0.000
TRUCK DRIVER		ALL	2	26.330	0.000	1.5	1.5	2.0	7.250	3.425	0.000	0.000
TRUCK DRIVER		ALL	3	26.530	0.000	1.5	1.5	2.0	7.250	3.425	0.000	0.000

TRUCK DRIVER	ALL	4	26.780	0.000	1.5	1.5	2.0	7.250	3.425	0.000	0.000
TRUCK DRIVER	ALL	5	27.530	0.000	1.5	1.5	2.0	7.250	3.425	0.000	0.000
TRUCK DRIVER	O&C	1	20.740	0.000	1.5	1.5	2.0	7.250	3.425	0.000	0.000
TRUCK DRIVER	O&C	2	21.060	0.000	1.5	1.5	2.0	7.250	3.425	0.000	0.000
TRUCK DRIVER	O&C	3	21.220	0.000	1.5	1.5	2.0	7.250	3.425	0.000	0.000
TRUCK DRIVER	O&C	4	21.420	0.000	1.5	1.5	2.0	7.250	3.425	0.000	0.000
TRUCK DRIVER	O&C	5	22.020	0.000	1.5	1.5	2.0	7.250	3.425	0.000	0.000

Legend :

M-F>8 (Overtime is required for any hour greater than 8 worked each day, Monday through Friday.)

OSA (Overtime is required for every hour worked on Saturday)

OSH (Overtime is required for every hour worked on Sunday and Holidays)

H/W (Health & Welfare Insurance)

Pensn (Pension)

Vac (Vacation)

Trng (Training)

## Explanations

### MADISON COUNTY

ELECTRICIANS AND ELECTRIC SYSTEMS TECHNICIAN (NORTHWEST) - Townships of Godfrey, Foster and Wood River, and the western one mile of Moro, Ft. Russell and Edwardsville, south to the north side of Hwy. 66 and west to the Mississippi River. This includes SIU-Edwardsville Dental Facility and Alton Mental Health Hospital.

ELECTRICIANS AND ELECTRIC SYSTEMS TECHNICIAN (SOUTHEAST) - Remainder of county not covered by ELECTRICIANS AND ELECTRIC SYSTEMS TECHNICIAN (NW) including SIU-Edwardsville Main Campus.

LABORERS (NORTHWEST) - That area northwest of a diagonal line running from the Mississippi River at the intersection of the waterway known as Wood River at Maple Island, northeast through the highway intersection of Illinois Routes 3 and 143 and following the boundary of Alton/East Alton, then preceding northeast to the county line at a point approximately one mile west of Illinois Route 159.

PLUMBERS AND PIPEFITTERS (SOUTH) - That part of the county South of a line between Mitchell and Highland including the town of Glen Carbon.

The following list is considered as those days for which holiday rates of wages for work performed apply: New Years Day, Memorial/Decoration Day, Fourth of July, Labor Day, Veterans Day, Thanksgiving Day, Christmas Day. Generally, any of these holidays which fall on a Sunday is celebrated on the following Monday. This then makes work performed on that Monday payable at the appropriate overtime rate for holiday pay. Common practice in a given local may alter certain days of celebration such as the day after Thanksgiving for Veterans Day. If in doubt, please check with IDOL.



Oil and chip resealing (O&C) means the application of road oils and liquid asphalt to coat an existing road surface, followed by application of aggregate chips or gravel to coated surface, and subsequent rolling of material to seal the surface.

#### EXPLANATION OF CLASSES

ASBESTOS - GENERAL - removal of asbestos material/mold and hazardous materials from any place in a building, including mechanical systems where those mechanical systems are to be removed. This includes the removal of asbestos materials/mold and hazardous materials from ductwork or pipes in a building when the building is to be demolished at the time or at some close future date.

ASBESTOS - MECHANICAL - removal of asbestos material from mechanical systems, such as pipes, ducts, and boilers, where the mechanical systems are to remain.

#### CERAMIC TILE FINISHER AND MARBLE FINISHER

The handling, at the building site, of all sand, cement, tile, marble or stone and all other materials that may be used and installed by [a] tile layer or marble mason. In addition, the grouting, cleaning, sealing, and mixing on the job site, and all other work as required in assisting the setter. The term "Ceramic" is used for naming the classification only and is in no way a limitation of the product handled. Ceramic takes into consideration most hard tiles.

#### ELECTRONIC SYSTEMS TECHNICIAN

Installation, service and maintenance of low-voltage systems which utilizes the transmission and/or transference of voice, sound, vision, or digital for commercial, education, security and entertainment purposes for the following: TV monitoring and surveillance, background/foreground music, intercom and telephone interconnect, field programming, inventory control systems, microwave transmission, multi-media, multiplex, radio page, school, intercom and sound burglar alarms and low voltage master clock systems.

Excluded from this classification are energy management systems, life safety systems, supervisory controls and data acquisition systems not intrinsic with the above listed systems, fire alarm systems, nurse call systems and raceways exceeding fifteen feet in length.

#### TRUCK DRIVER - BUILDING, HEAVY AND HIGHWAY CONSTRUCTION

Class 1. Drivers on 2 axle trucks hauling less than 9 ton. Air compressor and welding machines and brooms, including those pulled by separate units, truck driver helpers, warehouse employees, mechanic helpers, greasers and tiremen, pickup trucks when hauling materials, tools, or workers to and from and on-the-job site, and fork lifts up to 6,000 lb. capacity.

Class 2. Two or three axle trucks hauling more than 9 ton but hauling less than 16 ton. A-frame winch trucks, hydrolift trucks, vector trucks or similar equipment when used for transportation purposes. Fork lifts over 6,000 lb. capacity, winch trucks, four axle combination units, and ticket writers.

Class 3. Two, three or four axle trucks hauling 16 ton or more. Drivers on water pulls, articulated dump trucks, mechanics and working forepersons, and dispatchers. Five axle or more combination units.

Class 4. Low Boy and Oil Distributors.

Class 5. Drivers who require special protective clothing while employed on hazardous waste work.

TRUCK DRIVER - OIL AND CHIP RESEALING ONLY.

This shall encompass laborers, workers and mechanics who drive contractor or subcontractor owned, leased, or hired pickup, dump, service, or oil distributor trucks. The work includes transporting materials and equipment (including but not limited to, oils, aggregate supplies, parts, machinery and tools) to or from the job site; distributing oil or liquid asphalt and aggregate; stock piling material when in connection with the actual oil and chip contract. The Truck Driver (Oil & Chip Resealing) wage classification does not include supplier delivered materials.

OPERATING ENGINEERS

GROUP I. Cranes, Dragline, Shovels, Skimmer Scoops, Clamshells or Derrick Boats, Pile Drivers, Crane-Type Backhoes, Asphalt Plant Operators, Concrete Plant Operators, Dredges, Asphalt Spreading Machines, All Locomotives, Cable Ways, or Tower Machines, Hoists, Hydraulic Backhoes, Ditching Machines or Backfiller, Cherrypickers, Overhead Cranes, Roller, Steam or Gas, Concrete Pavers, Excavators, Concrete Breakers, Concrete Pumps, Bulk Cement Plants, Cement Pumps, Derrick-Type Drills, Boat Operators, Motor Graders or Pushcats, Scoops or Tournapulls, Bulldozers, Endloaders or Fork Lifts, Power Blade or Elevating Graders, Winch Cats, Boom or Winch Trucks or Boom Tractors, Pipe Wrapping or Painting Machines, Asphalt Plant Engineer, Journeyman Lubricating Engineer, Drills (other than Derrick Type), Mud Jacks, or Well Drilling Machines, Boring Machines or Track Jacks, Mixers, Conveyors (Two), Air Compressors (Two), Water Pumps regardless of size (Two), Welding Machines (Two), Siphons or Jets (Two), Winch Heads or Apparatuses (Two), Light Plants (Two), Waterblasters (two), All Tractors regardless of size (straight tractor only), Fireman on Stationary Boilers, Automatic Elevators, Form Grading Machines, Finishing Machines, Power Sub-Grader or Ribbon Machines, Longitudinal Floats, Distributor Operators on Trucks, Winch Heads or Apparatuses (One), Mobil Track air and heaters (two to five), Heavy Equipment Greaser, Relief Operator, Assistant Master Mechanic and Heavy Duty Mechanic, all Operators (except those listed below).

GROUP II. Assistant Operators.

GROUP III. Air Compressors (One), Water Pumps, regardless of Size (One), Waterblasters (one), Welding Machine (One), Mixers (One Bag), Conveyor (One), Siphon or Jet (One), Light Plant (One), Heater (One), Immobile Track Air (One), and Self Propelled Walk-Behind Rollers.

GROUP IV. Asphalt Spreader Oilers, Fireman on Whirlies and Heavy Equipment Oilers, Truck Cranes, Dredges, Monigans, Large Cranes - (Over 65-ton rated capacity) Concrete Plant Oiler, Blacktop Plant Oiler, and Creter Crane Oiler (when required).

GROUP V. Oiler.

GROUP VI. Master Mechanics, Operators on equipment with Booms, including jibs, 100 feet and over, and less than 150 feet long.

GROUP VII. Operators on equipment with Booms, including jibs, 150 feet and over, and less than 200 feet long.

GROUP VIII. Operators on Equipment with Booms, including jibs, 200 feet and over; Tower Cranes; Whirlie Cranes; and Operator Foreman.

#### TERRAZZO FINISHER

The handling of all materials used for Mosaic and Terrazzo work including preparing, mixing by hand, by mixing machine or transporting of pre-mixed materials and distributing with shovel, rake, hoe, or pail, all kinds of concrete foundations necessary for Mosaic and Terrazzo work, all cement terrazzo, magnesite terrazzo, Do-O-Tex terrazzo, epoxy matrix ter-razzo, exposed aggregate, rustic or rough washed for exterior or interior of buildings placed either by machine or by hand, and any other kind of mixture of plastics composed of chips or granules when mixed with cement, rubber, neoprene, vinyl, magnesium chloride or any other resinous or chemical substances used for seamless flooring systems, and all other building materials, all similar materials and all precast terrazzo work on jobs, all scratch coat used for Mosaic and Terrazzo work and sub-bed, tar paper and wire mesh (2x2 etc.) or lath. The rubbing, grinding, cleaning and finishing of same either by hand or by machine or by terrazzo resurfacing equipment on new or existing floors. When necessary finishers shall be allowed to assist the mechanics to spread sand bed, lay tarpaper and wire mesh (2x2 etc.) or lath. The finishing of cement floors where additional aggregate of stone is added by spreading or sprinkling on top of the finished base, and troweled or rolled into the finish and then the surface is ground by grinding machines.

#### Other Classifications of Work:

For definitions of classifications not otherwise set out, the Department generally has on file such definitions which are available. If a task to be performed is not subject to one of the classifications of pay set out, the Department will upon being contacted state which neighboring county has such a classification and provide such rate, such rate being deemed to exist by reference in this document. If no neighboring county rate applies to the task, the Department shall undertake a special determination, such special determination being then deemed to have existed under this determination. If a project requires these, or any classification not listed, please contact IDOL at 618/993-7271 for wage rates or clarifications.

#### LANDSCAPING

Landscaping work falls under the existing classifications for laborer, operating engineer and truck driver. The work performed by landscape plantsman and landscape laborer is covered by the existing classification of laborer. The work performed by landscape operators (regardless of equipment used or its size) is covered by the classifications of operating engineer. The work performed by landscape truck drivers (regardless of size of truck driven) is covered by the classifications of truck driver.

# Marion County Prevailing Wage for April 2007

Trade Name	RG	TYP	C	Base	FRMAN	*M-F>8	OSA	OSH	H/W	Pensn	Vac	Trng
=====	==	==	=	=====	=====	=====	==	==	=====	=====	=====	=====
ASBESTOS ABT-GEN		ALL		20.750	21.200	1.5	1.5	2.0	5.250	5.600	0.000	0.700
ASBESTOS ABT-MEC		BLD		25.290	26.290	1.5	1.5	2.0	4.450	2.500	0.000	0.250
BOILERMAKER		BLD		28.500	31.000	1.5	1.5	2.0	6.820	11.03	0.000	0.300
BRICK MASON		BLD		26.400	28.100	1.5	1.5	5.0	4.750	8.250	2.000	0.390
CARPENTER		BLD		27.780	29.280	1.5	1.5	2.0	5.050	3.750	0.000	0.350
CARPENTER		HWY		27.730	29.480	1.5	1.5	2.0	5.050	3.750	0.000	0.350
CEMENT MASON		BLD		23.500	24.500	1.5	1.5	2.0	5.200	3.550	0.000	0.100
CEMENT MASON		HWY		23.500	25.000	1.5	1.5	2.0	5.200	2.750	0.000	0.200
CERAMIC TILE FNSHER		BLD		22.610	0.000	1.5	1.5	2.0	5.000	4.300	0.000	0.400
ELECTRICIAN		ALL		32.910	35.160	1.5	1.5	2.0	5.150	6.580	0.000	0.490
ELECTRONIC SYS TECH		BLD		25.700	27.200	1.5	1.5	2.0	5.150	3.340	0.000	0.250
FLOOR LAYER		BLD		26.930	27.680	1.5	1.5	2.0	5.000	3.750	0.000	0.350
GLAZIER		BLD		29.480	0.000	2.0	2.0	2.0	8.550	6.920	2.360	0.160
HT/FROST INSULATOR		BLD		30.440	31.440	1.5	1.5	2.0	4.850	8.360	0.000	0.450
IRON WORKER		ALL		26.350	27.850	1.5	1.5	2.0	6.360	8.250	0.000	0.420
LABORER		BLD		20.750	21.200	1.5	1.5	2.0	5.250	5.600	0.000	0.600
LABORER		HWY		21.000	21.450	1.5	1.5	2.0	5.350	6.150	0.000	0.600
MACHINIST		BLD		36.890	38.890	2.0	2.0	2.0	4.380	5.650	2.550	0.000
MARBLE FINISHERS		BLD		22.610	0.000	1.5	1.5	2.0	5.000	4.300	0.000	0.400
MARBLE MASON		BLD		26.400	28.100	1.5	1.5	5.0	4.750	8.250	2.000	0.390
MILLWRIGHT		BLD		27.780	29.280	1.5	1.5	2.0	5.050	3.750	0.000	0.350
MILLWRIGHT		HWY		28.230	29.980	1.5	1.5	2.0	5.050	3.750	0.000	0.350
OPERATING ENGINEER		ALL	1	25.900	27.030	1.5	1.5	2.0	6.200	11.45	0.000	1.000
OPERATING ENGINEER		ALL	2	24.770	27.030	1.5	1.5	2.0	6.200	11.45	0.000	1.000
OPERATING ENGINEER		ALL	3	20.290	27.030	1.5	1.5	2.0	6.200	11.45	0.000	1.000
OPERATING ENGINEER		ALL	4	20.350	27.030	1.5	1.5	2.0	6.200	11.45	0.000	1.000
OPERATING ENGINEER		ALL	5	20.020	27.030	1.5	1.5	2.0	6.200	11.45	0.000	1.000
OPERATING ENGINEER		ALL	6	26.450	27.030	1.5	1.5	2.0	6.200	11.45	0.000	1.000
OPERATING ENGINEER		ALL	7	26.750	27.030	1.5	1.5	2.0	6.200	11.45	0.000	1.000
OPERATING ENGINEER		ALL	8	27.030	27.030	1.5	1.5	2.0	6.200	11.45	0.000	1.000
PAINTER		ALL		20.700	21.200	1.5	1.5	2.0	4.650	4.200	0.000	0.250
PAINTER OVER 30FT		ALL		23.800	24.300	1.5	1.5	2.0	4.650	4.200	0.000	0.250
PAINTER PWR EQMT		ALL		23.800	24.300	1.5	1.5	2.0	4.650	4.200	0.000	0.250
PILEDRIVER		BLD		27.780	29.280	1.5	1.5	2.0	5.050	3.750	0.000	0.350
PILEDRIVER		HWY		28.230	29.980	1.5	1.5	2.0	5.050	3.750	0.000	0.350
PIPEFITTER		BLD		29.500	31.500	1.5	1.5	2.0	5.000	4.850	0.000	0.800
PLASTERER		BLD		23.500	24.500	1.5	1.5	2.0	5.200	3.550	0.000	0.100
PLUMBER		BLD		29.500	31.500	1.5	1.5	2.0	5.000	4.850	0.000	0.800
ROOFER		BLD		19.700	20.500	1.5	1.5	2.0	5.700	3.800	0.000	0.000
SHEETMETAL WORKER		ALL		27.210	28.460	1.5	1.5	2.0	6.000	4.770	1.630	0.120
SPRINKLER FITTER		BLD		31.240	33.240	1.5	1.5	2.0	6.500	5.350	0.000	0.250
TERRAZZO FINISHER		BLD		31.240	0.000	1.5	1.5	2.0	0.000	0.000	0.000	0.000
TERRAZZO MASON		BLD		30.780	31.080	1.5	1.5	2.0	0.000	3.750	0.000	0.000
TRUCK DRIVER		ALL	1	25.930	0.000	1.5	1.5	2.0	7.250	3.425	0.000	0.000
TRUCK DRIVER		ALL	2	26.330	0.000	1.5	1.5	2.0	7.250	3.425	0.000	0.000
TRUCK DRIVER		ALL	3	26.530	0.000	1.5	1.5	2.0	7.250	3.425	0.000	0.000
TRUCK DRIVER		ALL	4	26.780	0.000	1.5	1.5	2.0	7.250	3.425	0.000	0.000
TRUCK DRIVER		ALL	5	27.530	0.000	1.5	1.5	2.0	7.250	3.425	0.000	0.000
TRUCK DRIVER		O&C	1	20.740	0.000	1.5	1.5	2.0	7.250	3.425	0.000	0.000
TRUCK DRIVER		O&C	2	21.060	0.000	1.5	1.5	2.0	7.250	3.425	0.000	0.000
TRUCK DRIVER		O&C	3	21.220	0.000	1.5	1.5	2.0	7.250	3.425	0.000	0.000
TRUCK DRIVER		O&C	4	21.420	0.000	1.5	1.5	2.0	7.250	3.425	0.000	0.000
TRUCK DRIVER		O&C	5	22.020	0.000	1.5	1.5	2.0	7.250	3.425	0.000	0.000

Legend:

M-F>8 (Overtime is required for any hour greater than 8 worked each day, Monday through Friday.)

OSA (Overtime is required for every hour worked on Saturday)

OSH (Overtime is required for every hour worked on Sunday and Holidays)

H/W (Health & Welfare Insurance)

Pensn (Pension)

Vac (Vacation)

Trng (Training)

## Explanations

### MARION COUNTY

The following list is considered as those days for which holiday rates of wages for work performed apply: New Years Day, Memorial/Decoration Day, Fourth of July, Labor Day, Veterans Day, Thanksgiving Day, Christmas Day. Generally, any of these holidays which fall on a Sunday is celebrated on the following Monday. This then makes work performed on that Monday payable at the appropriate overtime rate for holiday pay. Common practice in a given local may alter certain days of celebration such as the day after Thanksgiving for Veterans Day. If in doubt, please check with IDOL.

Oil and chip resealing (O&C) means the application of road oils and liquid asphalt to coat an existing road surface, followed by application of aggregate chips or gravel to coated surface, and subsequent rolling of material to seal the surface.

### EXPLANATION OF CLASSES

ASBESTOS - GENERAL - removal of asbestos material/mold and hazardous materials from any place in a building, including mechanical systems where those mechanical systems are to be removed. This includes the removal of asbestos materials/mold and hazardous materials from ductwork or pipes in a building when the building is to be demolished at the time or at some close future date.

ASBESTOS - MECHANICAL - removal of asbestos material from mechanical systems, such as pipes, ducts, and boilers, where the mechanical systems are to remain.

### CERAMIC TILE FINISHER AND MARBLE FINISHER

The handling, at the building site, of all sand, cement, tile, marble or stone and all other materials that may be used and installed by [a] tile layer or marble mason. In addition, the grouting, cleaning, sealing, and mixing on the job site, and all other work as required in assisting the setter. The term "Ceramic" is used for naming the classification only and is in no way a limitation of the product handled. Ceramic takes into consideration most hard tiles.

### ELECTRONIC SYSTEMS TECHNICIAN

Installation, service and maintenance of low-voltage systems which utilizes the transmission and/or transference of voice, sound, vision, or digital for commercial, education, security and entertainment

purposes for the following: TV monitoring and surveillance, background/foreground music, intercom and telephone interconnect, field programming, inventory control systems, microwave transmission, multi-media, multiplex, radio page, school, intercom and sound burglar alarms and low voltage master clock systems.

Excluded from this classification are energy management systems, life safety systems, supervisory controls and data acquisition systems not intrinsic with the above listed systems, fire alarm systems, nurse call systems and raceways exceeding fifteen feet in length.

#### TRUCK DRIVER - BUILDING, HEAVY AND HIGHWAY CONSTRUCTION

Class 1. Drivers on 2 axle trucks hauling less than 9 ton. Air compressor and welding machines and brooms, including those pulled by separate units, truck driver helpers, warehouse employees, mechanic helpers, greasers and tiremen, pickup trucks when hauling materials, tools, or workers to and from and on-the-job site, and fork lifts up to 6,000 lb. capacity.

Class 2. Two or three axle trucks hauling more than 9 ton but hauling less than 16 ton. A-frame winch trucks, hydrolift trucks, vector trucks or similar equipment when used for transportation purposes. Fork lifts over 6,000 lb. capacity, winch trucks, four axle combination units, and ticket writers.

Class 3. Two, three or four axle trucks hauling 16 ton or more. Drivers on water pulls, articulated dump trucks, mechanics and working forepersons, and dispatchers. Five axle or more combination units.

Class 4. Low Boy and Oil Distributors.

Class 5. Drivers who require special protective clothing while employed on hazardous waste work.

#### TRUCK DRIVER - OIL AND CHIP RESEALING ONLY.

This shall encompass laborers, workers and mechanics who drive contractor or subcontractor owned, leased, or hired pickup, dump, service, or oil distributor trucks. The work includes transporting materials and equipment (including but not limited to, oils, aggregate supplies, parts, machinery and tools) to or from the job site; distributing oil or liquid asphalt and aggregate; stock piling material when in connection with the actual oil and chip contract. The Truck Driver (Oil & Chip Resealing) wage classification does not include supplier delivered materials.

#### OPERATING ENGINEERS

GROUP I. Cranes, Dragline, Shovels, Skimmer Scoops, Clamshells or Derrick Boats, Pile Drivers, Crane-Type Backhoes, Asphalt Plant Operators, Concrete Plant Operators, Dredges, Asphalt Spreading Machines, All Locomotives, Cable Ways, or Tower Machines, Hoists, Hydraulic Backhoes, Ditching Machines or Backfiller, Cherrypickers, Overhead Cranes, Roller, Steam or Gas, Concrete Pavers, Excavators, Concrete Breakers, Concrete Pumps, Bulk Cement Plants, Cement Pumps, Derrick-Type Drills, Boat Operators, Motor Graders or Pushcats, Scoops or Tournapulls, Bulldozers, Endloaders or Fork Lifts, Power Blade or Elevating Graders, Winch Cats, Boom or Winch Trucks or Boom Tractors, Pipe Wrapping or Painting Machines, Asphalt Plant Engineer, Journeyman Lubricating Engineer, Drills (other than Derrick Type), Mud Jacks, or Well Drilling Machines, Boring Machines or Track Jacks, Mixers, Conveyors (Two), Air Compressors (Two), Water Pumps regardless of size (Two), Welding Machines (Two), Siphons or Jets

(Two), Winch Heads or Apparatuses (Two), Light Plants (Two), Waterblasters (two), All Tractors regardless of size (straight tractor only), Fireman on Stationary Boilers, Automatic Elevators, Form Grading Machines, Finishing Machines, Power Sub-Grader or Ribbon Machines, Longitudinal Floats, Distributor Operators on Trucks, Winch Heads or Apparatuses (One), Mobil Track air and heaters (two to five), Heavy Equipment Greaser, Relief Operator, Assistant Master Mechanic and Heavy Duty Mechanic, all Operators (except those listed below).

GROUP II. Assistant Operators.

GROUP III. Air Compressors (One), Water Pumps, regardless of Size (One), Waterblasters (one), Welding Machine (One), Mixers (One Bag), Conveyor (One), Siphon or Jet (One), Light Plant (One), Heater (One), Immobile Track Air (One), and Self Propelled Walk-Behind Rollers.

GROUP IV. Asphalt Spreader Oilers, Fireman on Whirlies and Heavy Equipment Oilers, Truck Cranes, Dredges, Monigans, Large Cranes - (Over 65-ton rated capacity) Concrete Plant Oiler, Blacktop Plant Oiler, and Creter Crane Oiler (when required).

GROUP V. Oiler.

GROUP VI. Master Mechanics, Operators on equipment with Booms, including jibs, 100 feet and over, and less than 150 feet long.

GROUP VII. Operators on equipment with Booms, including jibs, 150 feet and over, and less than 200 feet long.

GROUP VIII. Operators on Equipment with Booms, including jibs, 200 feet and over; Tower Cranes; Whirlie Cranes; and Operator Foreman.

#### TERRAZZO FINISHER

The handling of all materials used for Mosaic and Terrazzo work including preparing, mixing by hand, by mixing machine or transporting of pre-mixed materials and distributing with shovel, rake, hoe, or pail, all kinds of concrete foundations necessary for Mosaic and Terrazzo work, all cement terrazzo, magnesite terrazzo, Do-O-Tex terrazzo, epoxy matrix ter-razzo, exposed aggregate, rustic or rough washed for exterior or interior of buildings placed either by machine or by hand, and any other kind of mixture of plastics composed of chips or granules when mixed with cement, rubber, neoprene, vinyl, magnesium chloride or any other resinous or chemical substances used for seamless flooring systems, and all other building materials, all similar materials and all precast terrazzo work on jobs, all scratch coat used for Mosaic and Terrazzo work and sub-bed, tar paper and wire mesh (2x2 etc.) or lath. The rubbing, grinding, cleaning and finishing of same either by hand or by machine or by terrazzo resurfacing equipment on new or existing floors. When necessary finishers shall be allowed to assist the mechanics to spread sand bed, lay tarpaper and wire mesh (2x2 etc.) or lath. The finishing of cement floors where additional aggregate of stone is added by spreading or sprinkling on top of the finished base, and troweled or rolled into the finish and then the surface is ground by grinding machines.

Other Classifications of Work:

For definitions of classifications not otherwise set out, the Department generally has on file such definitions which are available.

If a task to be performed is not subject to one of the classifications of pay set out, the Department will upon being contacted state which neighboring county has such a classification and provide such rate, such rate being deemed to exist by reference in this document. If no neighboring county rate applies to the task, the Department shall undertake a special determination, such special determination being then deemed to have existed under this determination. If a project requires these, or any classification not listed, please contact IDOL at 618/993-7271 for wage rates or clarifications.

#### LANDSCAPING

Landscaping work falls under the existing classifications for laborer, operating engineer and truck driver. The work performed by landscape plantsman and landscape laborer is covered by the existing classification of laborer. The work performed by landscape operators (regardless of equipment used or its size) is covered by the classifications of operating engineer. The work performed by landscape truck drivers (regardless of size of truck driven) is covered by the classifications of truck driver.



# Marshall County Prevailing Wage for April 2007

Trade Name	RG	TYP	C	Base	FRMAN	*M-F>8	OSA	OSH	H/W	Pensn	Vac	Trng
=====	==	==	=	=====	=====	=====	==	==	=====	=====	=====	=====
ASBESTOS ABT-GEN		BLD		25.090	25.840	1.5	1.5	2.0	5.850	5.250	0.000	0.600
ASBESTOS ABT-GEN		HWY		25.870	26.420	1.5	1.5	2.0	5.850	5.250	0.000	0.700
ASBESTOS ABT-MEC		BLD		23.300	24.800	1.5	1.5	2.0	7.860	4.910	0.000	0.000
BOILERMAKER		BLD		30.970	33.970	2.0	2.0	2.0	8.270	7.740	0.000	0.300
BRICK MASON		BLD		27.020	28.520	1.5	1.5	2.0	5.500	6.350	0.000	0.390
CARPENTER		BLD		27.220	28.720	1.5	1.5	2.0	5.810	8.170	0.000	0.570
CARPENTER		HWY		26.480	28.230	1.5	1.5	2.0	5.810	7.670	0.000	0.500
CEMENT MASON	E	ALL		30.000	31.000	1.5	1.5	2.0	5.500	7.390	0.000	0.100
CEMENT MASON	W	BLD		23.120	24.870	1.5	1.5	2.0	5.290	10.00	0.000	0.500
CEMENT MASON	W	HWY		24.140	25.140	1.5	1.5	2.0	5.290	10.00	0.000	0.500
CERAMIC TILE FNSHER		BLD		24.910	0.000	1.5	1.5	2.0	5.500	6.350	0.000	0.380
ELECTRIC PWR EQMT OP		ALL		30.750	0.000	1.5	1.5	2.0	4.750	8.610	0.000	0.000
ELECTRIC PWR GRNDMAN		ALL		21.090	0.000	1.5	1.5	2.0	4.750	5.905	0.000	0.000
ELECTRIC PWR LINEMAN		ALL		34.160	36.350	1.5	1.5	2.0	4.750	9.560	0.000	0.000
ELECTRIC PWR TRK DRV		ALL		22.130	0.000	1.5	1.5	2.0	4.750	6.200	0.000	0.000
ELECTRICIAN	E	BLD		32.010	34.010	1.5	1.5	2.0	5.150	5.410	0.000	0.480
ELECTRICIAN	W	BLD		29.860	31.860	1.5	1.5	2.0	5.150	8.060	0.000	0.250
ELECTRONIC SYS TECH		BLD		23.850	25.350	1.5	1.5	2.0	5.150	5.625	0.000	0.250
ELEVATOR CONSTRUCTOR		BLD		34.190	38.460	2.0	2.0	2.0	8.275	6.060	2.050	0.000
GLAZIER		BLD		26.320	27.070	1.5	1.5	2.0	5.650	5.750	0.000	0.350
HT/FROST INSULATOR		BLD		34.750	36.500	1.5	1.5	2.0	8.260	9.110	0.000	0.310
IRON WORKER	NE	ALL		28.000	29.000	2.0	2.0	2.0	8.040	11.85	0.000	0.550
IRON WORKER	SW	BLD		24.960	26.710	1.5	1.5	2.0	8.040	7.410	0.000	0.400
IRON WORKER	SW	HWY		25.920	27.420	1.5	1.5	2.0	8.040	7.410	0.000	0.350
LABORER		BLD		24.090	24.840	1.5	1.5	2.0	5.850	5.250	0.000	0.600
LABORER		HWY		24.870	25.420	1.5	1.5	2.0	5.850	5.250	0.000	0.600
LABORER, SKILLED		BLD		24.090	24.840	1.5	1.5	2.0	5.850	5.250	0.000	0.600
LABORER, SKILLED		HWY		24.870	25.420	1.5	1.5	2.0	5.850	5.250	0.000	0.600
LATHER		BLD		27.220	28.720	1.5	1.5	2.0	5.810	8.170	0.000	0.570
MACHINERY MOVER	SW	HWY		25.920	27.420	1.5	1.5	2.0	8.040	7.410	0.000	0.350
MACHINIST		BLD		36.890	38.890	2.0	2.0	2.0	4.380	5.650	2.550	0.000
MARBLE FINISHERS		BLD		24.910	0.000	1.5	1.5	2.0	5.500	6.350	0.000	0.380
MARBLE MASON		BLD		26.520	27.770	1.5	1.5	2.0	5.500	6.350	0.000	0.380
MILLWRIGHT		BLD		32.000	35.200	1.5	1.5	2.0	6.100	9.250	0.000	0.560
MILLWRIGHT		HWY		17.100	18.350	1.5	1.5	2.0	1.450	1.500	0.000	0.000
OPERATING ENGINEER		BLD	1	27.840	30.840	1.5	1.5	2.0	5.900	8.000	0.000	0.900
OPERATING ENGINEER		BLD	2	25.940	30.840	1.5	1.5	2.0	5.900	8.000	0.000	0.900
OPERATING ENGINEER		BLD	3	24.560	30.840	1.5	1.5	2.0	5.900	8.000	0.000	0.900
OPERATING ENGINEER		HWY	1	29.110	32.110	1.5	1.5	2.0	6.250	9.000	0.000	1.000
OPERATING ENGINEER		HWY	2	26.730	32.110	1.5	1.5	2.0	6.250	9.000	0.000	1.000
OPERATING ENGINEER		HWY	3	22.790	32.110	1.5	1.5	2.0	6.250	9.000	0.000	1.000
PAINTER		ALL		26.850	27.850	1.5	1.5	1.5	5.650	5.750	0.000	0.350
PAINTER SIGNS		BLD		28.970	32.520	1.5	1.5	1.5	2.600	2.310	0.000	0.000
PILEDRIVER		BLD		27.470	28.970	1.5	1.5	2.0	5.810	8.170	0.000	0.570
PILEDRIVER		HWY		26.480	28.230	1.5	1.5	2.0	5.810	7.670	0.000	0.500
PIPEFITTER	N	BLD		37.600	39.600	1.5	1.5	2.0	8.660	6.900	0.000	0.940
PIPEFITTER	S	BLD		31.630	35.110	1.5	1.5	2.0	6.450	7.680	0.000	0.420
PLASTERER		BLD		23.400	24.650	1.5	1.5	2.0	5.290	9.800	0.000	0.500
PLUMBER	N	BLD		37.500	39.500	1.5	1.5	2.0	7.050	8.500	0.000	0.760
PLUMBER	S	BLD		28.390	30.950	1.5	1.5	2.0	6.450	8.990	0.000	0.800
ROOFER		BLD		24.200	25.200	1.5	1.5	2.0	5.350	6.550	0.000	0.150
SHEETMETAL WORKER		BLD		29.890	31.140	1.5	1.5	2.0	5.770	6.730	0.000	0.200
SIGN HANGER	SW	HWY		25.920	27.420	1.5	1.5	2.0	8.040	7.410	0.000	0.350
SPRINKLER FITTER		BLD		31.240	33.240	1.5	1.5	2.0	6.500	5.350	0.000	0.250
STEEL ERECTOR	SW	HWY		25.920	27.420	1.5	1.5	2.0	8.040	7.410	0.000	0.350
STONE MASON		BLD		27.020	28.520	1.5	1.5	2.0	5.500	6.350	0.000	0.390
TERRAZZO FINISHER		BLD		24.910	0.000	1.5	1.5	2.0	5.500	6.350	0.000	0.380
TERRAZZO MASON		BLD		26.520	27.770	1.5	1.5	2.0	5.500	6.350	0.000	0.380

TILE LAYER	BLD	27.220	28.720	1.5	1.5	2.0	5.810	8.170	0.000	0.570
TILE MASON	BLD	26.520	27.770	1.5	1.5	2.0	5.500	6.350	0.000	0.380
TRUCK DRIVER	ALL 1	25.787	0.000	1.5	1.5	2.0	7.250	3.317	0.000	0.000
TRUCK DRIVER	ALL 2	26.187	0.000	1.5	1.5	2.0	7.250	3.317	0.000	0.000
TRUCK DRIVER	ALL 3	26.387	0.000	1.5	1.5	2.0	7.250	3.317	0.000	0.000
TRUCK DRIVER	ALL 4	26.637	0.000	1.5	1.5	2.0	7.250	3.317	0.000	0.000
TRUCK DRIVER	ALL 5	27.387	0.000	1.5	1.5	2.0	7.250	3.317	0.000	0.000
TRUCK DRIVER	O&C 1	20.630	0.000	1.5	1.5	2.0	7.250	3.317	0.000	0.000
TRUCK DRIVER	O&C 2	20.950	0.000	1.5	1.5	2.0	7.250	3.317	0.000	0.000
TRUCK DRIVER	O&C 3	21.110	0.000	1.5	1.5	2.0	7.250	3.317	0.000	0.000
TRUCK DRIVER	O&C 4	21.310	0.000	1.5	1.5	2.0	7.250	3.317	0.000	0.000
TRUCK DRIVER	O&C 5	21.910	0.000	1.5	1.5	2.0	7.250	3.317	0.000	0.000
TUCKPOINTER	BLD	27.020	28.520	1.5	1.5	2.0	5.500	6.350	0.000	0.390

Legend:

M-F>8 (Overtime is required for any hour greater than 8 worked each day, Monday through Friday.)

OSA (Overtime is required for every hour worked on Saturday)

OSH (Overtime is required for every hour worked on Sunday and Holidays)

H/W (Health & Welfare Insurance)

Pensn (Pension)

Vac (Vacation)

Trng (Training)

## Explanations

### MARSHALL COUNTY

CEMENT MASON (EAST) - The part east of a line which runs south from the point where Marshall, Putnam and LaSalle Counties meet to Route 166 just south and west of Benson, Illinois (in Woodford County).

ELECTRICIANS (EAST) - Townships of Roberts, Evans, Bill Plain, and Bennington.

IRONWORKERS (SOUTHWEST) - That part of the county Southwest of a diagonal line through Toluca, Varba and Bradford (Stark County).

PLUMBERS & PIPEFITTERS (NORTH) - That part of the county North of Route 17.

The following list is considered as those days for which holiday rates of wages for work performed apply: New Years Day, Memorial/Decoration Day, Fourth of July, Labor Day, Veterans Day, Thanksgiving Day, Christmas Day. Generally, any of these holidays which fall on a Sunday is celebrated on the following Monday. This then makes work performed on that Monday payable at the appropriate overtime rate for holiday pay. Common practice in a given local may alter certain days of celebration such as the day after Thanksgiving for Veterans Day. If in doubt, please check with IDOL.

Oil and chip resealing (O&C) means the application of road oils and liquid asphalt to coat an existing road surface, followed by

application of aggregate chips or gravel to coated surface, and subsequent rolling of material to seal the surface.

#### EXPLANATION OF CLASSES

ASBESTOS - GENERAL - removal of asbestos material/mold and hazardous materials from any place in a building, including mechanical systems where those mechanical systems are to be removed. This includes the removal of asbestos materials/mold and hazardous materials from ductwork or pipes in a building when the building is to be demolished at the time or at some close future date.

ASBESTOS - MECHANICAL - removal of asbestos material from mechanical systems, such as pipes, ducts, and boilers, where the mechanical systems are to remain.

#### CERAMIC TILE FINISHER, MARBLE FINISHER, TERRAZZO FINISHER

Assisting, helping or supporting the tile, marble and terrazzo mechanic by performing their historic and traditional work assignments required to complete the proper installation of the work covered by said crafts. The term "Ceramic" is used for naming the classification only and is in no way a limitation of the product handled. Ceramic takes into consideration most hard tiles.

#### ELECTRONIC SYSTEMS TECHNICIAN

Installation, service and maintenance of low-voltage systems which utilizes the transmission and/or transference of voice, sound, vision, or digital for commercial, education, security and entertainment purposes for the following: TV monitoring and surveillance, background/foreground music, intercom and telephone interconnect, field programming, inventory control systems, microwave transmission, multi-media, multiplex, radio page, school, intercom and sound burglar alarms and low voltage master clock systems.

Excluded from this classification are energy management systems, life safety systems, supervisory controls and data acquisition systems not intrinsic with the above listed systems, fire alarm systems, nurse call systems and raceways exceeding fifteen feet in length.

#### LABORER, SKILLED - BUILDING

The skilled laborer building (BLD) classification shall encompass the following types of work, irrespective of the site of the work: tending of carpenters in unloading, handling, stockpiling and distribution operations, also other building crafts, mixing, handling, and conveying of all materials used by masons, plasterers and other building construction crafts, whether done by hand or by any process. The drying of plastering when done by salamander heat, and the cleaning and clearing of all debris. All work pertaining to and in preparation of asbestos abatement and removal. The building of scaffolding and staging for masons and plasterers. The excavations for buildings and all other construction, digging, of trenches, piers, foundations and holes, dig-ging, lagging, sheeting, cribbing, bracing and propping of foundations, holes, caissons, cofferdams, and dikes, the setting of all guidelines for machine or hand excavation and subgrading. The mixing, handling, conveying, pouring, vibrating, gunniting and otherwise applying of concrete, whether by hand or other method of concrete for any walls, foundations, floors, or for other construction concrete sealant men. The wrecking, stripping, dismantling, and handling of concrete forms and false work, and the building of centers for fireproofing purposes. Boring machine, gas,

electric or air in preparation for shoving pipe, telephone cable, and so forth, under highways, roads, streets and alleys. All hand and power operating cross cut saws when used for clearing. All work in compressed air construction. All work on acetylene burners in salvaging. The blocking and tamping of concrete. The laying of sewer tile and conduit, and pre-cast materials. The assembling and dismantling of all jacks and sectional scaffolding, including elevator construction and running of slip form jacks. The work of drill running and blasting, including wagon drills. The wrecking, stripping, dismantling, cleaning, moving and oiling of forms. The cutting off of concrete piles. The loading, unloading, handling and carrying to place of installation of all rods, (and materials for use in reinforcing) concrete and the hoisting of same and all signaling where hoist is used in this type of construction coming under the jurisdiction of the Laborers' Union. And, all other labor work not awarded to any other craft. Mortar mixers, kettlemen and carrier of hot stuff, tool crib men, watchmen (Laborer), firemen or salamander tenders, flagmen, deck hands, installation and maintenance of temporary gas-fired heating units, gravel box men, dumpmen and spotters, fencing Laborers, cleaning lumber, pit men, material checkers, dispatchers, unloading explosives, asphalt plant laborers, writer of scale tickets, fireproofing laborers, janitors, asbestos abatement and removal laborers, handling of materials treated with oil, creosote, chloride, asphalt, and/or foreign material harmful to skin or clothing, Laborers with de-watering systems, gunnite nozzle men, laborers tending masons with hot material or where foreign materials are used, Laborers handling masterplate or similar materials, laser beam operator, concrete burning machine operator, material selector men working with firebrick or combustible material, dynamite men, track laborers, cement handlers, chloride handlers, the unloading and laborers with steel workers and re-bars, concrete workers (wet), luteman, asphalt raker, curb asphalt machine operator, ready mix scalemen, permanent, portable or temporary plant drilling machine operator, plaster tenders, underpinning and shoring of buildings, fire watch, signaling of all power equipment, to include trucks excavating equipment, etc., tree topper or trimmer when in connection to construction, tunnel helpers in free air, batch dumpers, kettle and tar men, tank cleaners, plastic installers, scaffold workers, motorized buggies or motorized unit used for wet concrete or handling of building materials, sewer workers, rod and chain men, vibrator operators, mortar mixer operator, cement silica, clay, fly ash, lime and plasters, handlers (bulk or bag), cofferdam workers, on concrete paving, placing, cutting and tying of reinforcing, deck hand, dredge hand and shore laborers, bankmen on floating plant, asphalt workers with machine & layers, grade checker, power tools, caisson workers, lead man on sewer work, welders, cutters, burners and torch men, chain saw operators, paving breaker, jackhammer and drill operator, layout man and/or drainage tile layer, steel form setters -- street and highway, air tamping hammerman, signal man on crane, concrete saw operator, screen man on asphalt pavers, front end man on chip spreader, multiple concrete duct -- lead man.

#### LABORER, SKILLED - HIGHWAY

The skilled laborer heavy and highway (HWY) classification shall encompass the following types of work, irrespective of the site of the work: handling of materials treated with oil, creosote, asphalt and/or any foreign materials harmful to skin or clothing, track laborers, chloride handlers, the unloading and loading with steel workers and re-bars, concrete workers (wet), tunnel helpers in free air, batch dumpers, mason tenders, kettle and tar men, plastic installers, scaffold workers, motorized buggies or motorized unit used for wet concrete or handling of building materials, laborers with

de-watering systems, sewer workers plus depth, rod and chainmen, vibrator operators, mortar mixer operators, cement silica, clay, fly ash, lime and plasters, handlers (bulk or bag), cofferdam workers plus depth, on concrete paving, placing, cutting and tying or reinforcing, deck hand, dredge hand shore laborers, bankmen on floating plant, asphalt workers with machine, and layers, grade checker, power tools, stripping of all concrete forms excluding paving forms, dumpmen and spotters, when necessary, caisson workers plus depth, gunnite nozzle men, welders, cutters, burners and torchmen, chain saw operators, paving breaker, jackhammer and drill operators, layout man and/or drainage tile layer, steel form setters - street and highway, air tamping hammerman, signal man on crane, concrete saw operator, screedman on asphalt pavers, front end man on chip spreader, multiple concrete duct, luteman, asphalt raker, curb asphalt machine operator, ready mix scalemen (portable or temporary plant), laser beam operator, concrete burning machine operator, and coring machine operator.

#### TRUCK DRIVER - OIL AND CHIP RESEALING ONLY.

This shall encompass laborers, workers and mechanics who drive contractor or subcontractor owned, leased, or hired pickup, dump, service, or oil distributor trucks. The work includes transporting materials and equipment (including but not limited to, oils, aggregate supplies, parts, machinery and tools) to or from the job site; distributing oil or liquid asphalt and aggregate; stock piling material when in connection with the actual oil and chip contract. The Truck Driver (Oil & Chip Resealing) wage classification does not include supplier delivered materials.

#### TRUCK DRIVER - BUILDING, HEAVY AND HIGHWAY CONSTRUCTION

Class 1. Drivers on 2 axle trucks hauling less than 9 ton. Air compressor and welding machines and brooms, including those pulled by separate units, truck driver helpers, warehouse employees, mechanic helpers, greasers and tiremen, pickup trucks when hauling materials, tools, or workers to and from and on-the-job site, and fork lifts up to 6,000 lb. capacity.

Class 2. Two or three axle trucks hauling more than 9 ton but hauling less than 16 ton. A-frame winch trucks, hydrolift trucks, vactor trucks or similar equipment when used for transportation purposes. Fork lifts over 6,000 lb. capacity, winch trucks, four axle combination units, and ticket writers.

Class 3. Two, three or four axle trucks hauling 16 ton or more. Drivers on water pulls, articulated dump trucks, mechanics and working forepersons, and dispatchers. Five axle or more combination units.

Class 4. Low Boy and Oil Distributors.

Class 5. Drivers who require special protective clothing while employed on hazardous waste work.

#### OPERATING ENGINEERS - BUILDING

Class 1. Cranes; Overhead Cranes; GRADALL All Cherry Pickers; Mechanics; Central Concrete Mixing Plant Operator; Road Pavers (27E - Dual Drum - Tri Batchers); Blacktop Plant Operators and Plant Engineers; 3 Drum Hoist; Derricks; Hydro Cranes; Shovels; Skimmer Scoops; Koehring SCOOPER Drag Lines; Backhoe; Derrick Boats; Pile Drivers and Skid Rigs; Clamshells; Locomotive Cranes; Dredge (all types) Motor Patrol; Power Blades - Dumore - Elevating and similar types; Tower Cranes (Crawler-Mobile) and Stationary; Crane-type

Backfiller; Drott Yumbo and similar types considered as Cranes; Caisson Rigs; Dozer; Tournadozer; Work Boats; Ross Carrier; Helicopter; Tournapulls - all and similar types; Scoops (all sizes); Pushcats; Endloaders (all types); Asphalt Surfacing Machine; Slip Form Paver; Rock Crusher; Heavy Equipment Greaser; CMI, CMI Belt Placer, Auto Grade & 3 Track and similar types; Side Booms; Multiple Unit Earth Movers; Creter Crane; Trench Machine; Pump-crete-Belt Crete-Squeeze Cretes-Screw-type Pumps and Gypsum; Bulker & Pump - Operator will clean; Formless Finishing Machine; Flaherty Spreader or similar types; Screed Man on Laydown Machine; Wheel Tractors (industrial or Farm-type w/Dozer-Hoe-Endloader or other attachments); F.W.D. & Similar Types; Vermeer Concrete Saw.

Class 2. Dinkeys; Power Launches; PH One-pass Soil Cement Machine (and similar types); Pugmill with Pump; Backfillers; Euclid Loader; Forklifts; Jeeps w/Ditching Machine or other attachments; Tuneluger; Automatic Cement and Gravel Batching Plants; Mobile Drills (Soil Testing) and similar types; Gurries and Similar Types; (1) and (2) Drum Hoists (Buck Hoist and Similar Types); Chicago Boom; Boring Machine & Pipe Jacking Machine; Hydro Boom; Dewatering System; Straw Blower; Hydro Seeder; Assistant Heavy Equipment Greaser on Spread; Tractors (Track type) without Power Unit pulling Rollers; Rollers on Asphalt -- Brick Macadem; Concrete Breakers; Concrete Spreaders; Mule Pulling Rollers; Center Stripper; Cement Finishing Machines & CMI Texture & Reel Curing Machines; Cement Finishing Machine; Barber Green or similar loaders; Vibro Tamper (All similar types) Self-propelled; Winch or Boom Truck; Mechanical Bull Floats; Mixers over 3 Bag to 27E; Tractor pulling Power Blade or Elevating Grader; Porter Rex Rail; Clary Screed; Truck Type Hoptoe Oilers; Fireman; Spray Machine on Paving; Curb Machines; Truck Crane Oilers; Oil Distributor; Truck-Mounted Saws.

Class 3. Air Compressor; Power Subgrader; Straight Tractor; Trac Air without attachments; Herman Nelson Heater, Dravo, Warner, Silent Glo, and similar types; Roller: Five (5) Ton and under on Earth or Gravel; Form Grader; Crawler Crane & Skid Rig Oilers; Freight Elevators - permanently installed; Pump; Light Plant; Generator; Conveyor (1) or (2) - Operator will clean; Welding Machine; Mixer (3) Bag and Under (Standard Capacity with skip); Bulk Cement Plant; Oiler on Central Concrete Mixing Plant.

#### OPERATING ENGINEERS - HEAVY AND HIGHWAY CONSTRUCTION

Class 1. Cranes; Hydro Crane; Shovels; Crane Type Backfiller; Tower Cranes - Mobile & Crawler & Stationary; Derricks & Hoists (3 Drum); Draglines; Drott Yumbo & similar types considered as Cranes; Back Hoe; Derrick Boats; Pile Driver and Skid Rigs; Clam Shell; Locomotive - Cranes; Road Pavers - Single Drum - Dual Drum - Tri Batcher; Motor Patrols & Power Blades - Dumore - Elevating & Similar Types; Mechanics; Central Concrete Mixing Plant Operator; Asphalt Batch Plant Operators and Plant Engineers; Gradall; Caisson Rigs; Skimmer Scoop - Koering Scooper; Dredges (all types); Hoptoe; All Cherry Pickers; Work Boat; Ross Carrier; Helicopter; Dozer; Tournadozer; Tournapulls - all and similar types; Multiple Unit Earth Movers; Scoops (all sizes); Pushcats; Endloaders (all types); Asphalt Surfacing Machine; Slip Form Paver; Rock Crusher; Heavy Equipment Greaser (top greaser on spread); CMI, Auto Grade, CMI Belt Placer & 3 Track and similar types; Side Booms; Starting Engineer on Pipeline; Asphalt Heater & Planer Combination (used to plane streets); Wheel Tractors (with dozer, hoe or endloader attachments); F.W.D. and Similar types; Blaw Knox Spreader and Similar types; Trench Machines; Pump Crete - Belt Crete - Squeeze Crete - screw type pumps and gypsum (operator will clean); Formless Finishing Machines; Flaherty Spreader or similar

types; Screed Man on Laydown Machine; Vermeer Concrete Saw.

Class 2. Bulker & Pump; Power Launches; Boring Machine & Pipe Jacking Machine; Dinkeys; P-H One Pass Soil Cement Machines and similar types; Wheel Tractors (Industry or farm type - other); Back Fillers; Euclid Loader; Fork Lifts; Jeep w/Ditching Machine or other attachments; Tunneluger; Automatic Cement & Gravel Batching Plants; Mobile Drills - Soil Testing and similar types; Pugmill with pump; All (1) and (2) Drum Hoists; Dewatering System; Straw Blower; Hydro-Seeder; Boring Machine; Hydro-Boom; Bump Grinders (self-propelled); Assistant Heavy Equipment Greaser; Apsco Spreader; Tractors (track-type) without Power Units Pulling Rollers on Asphalt - Brick or Macadam; Concrete Breakers; Concrete Spreaders; Cement Strippers; Cement Finishing Machines & CMI Texture & Reel Curing Machines; Vibro-Tampers (all similar types self-propelled); Mechanical Bull Floats; Self-propelled Concrete Saws; Mixers-over three (3) bags to 27E; Winch and Boom Trucks; Tractor Pulling Power Blade or Elevating Grader; Porter Rex Rail; Clary Screed; Mule Pulling Rollers; Pugmill without Pump; Barber Greene or similar Loaders; Track Type Tractor w/Power Unit attached (minimum); Fireman; Spray Machine on Paving; Curb Machines; Paved Ditch Machine; Power Broom; Self-Propelled Conveyors; Power Subgrader; Oil Distributor; Straight Tractor; Truck Crane Oiler; Truck Type Oilers; Directional boring machine; Horizontal directional drill.

Class 3. Straight framed articulating end dump vehicles and Truck mounted vac unit (separately powered); Trac Air Machine (without attachments); Herman Nelson Heater, Dravo Warner, Silent Glo & similar types; Rollers - five ton and under on earth and gravel; Form Graders; Pumps; Light Plant; Generator; Air Compressor (1) or (2); Conveyor; Welding Machine; Mixer - 3 bags and under; Bulk Cement Plant; Oilers.

#### Other Classifications of Work:

For definitions of classifications not otherwise set out, the Department generally has on file such definitions which are available. If a task to be performed is not subject to one of the classifications of pay set out, the Department will upon being contacted state which neighboring county has such a classification and provide such rate, such rate being deemed to exist by reference in this document. If no neighboring county rate applies to the task, the Department shall undertake a special determination, such special determination being then deemed to have existed under this determination. If a project requires these, or any classification not listed, please contact IDOL at 618/993-7271 for wage rates or clarifications.

#### LANDSCAPING

Landscaping work falls under the existing classifications for laborer, operating engineer and truck driver. The work performed by landscape plantsman and landscape laborer is covered by the existing classification of laborer. The work performed by landscape operators (regardless of equipment used or its size) is covered by the classifications of operating engineer. The work performed by landscape truck drivers (regardless of size of truck driven) is covered by the classifications of truck driver.

# Mason County Prevailing Wage for April 2007

Trade Name	RG	TYP	C	Base	FRMAN	*M-F>8	OSA	OSH	H/W	Pensn	Vac	Trng
=====	==	==	=	=====	=====	=====	=====	=====	=====	=====	=====	=====
ASBESTOS ABT-GEN		BLD		22.260	23.260	1.5	1.5	2.0	5.300	6.030	0.000	0.600
ASBESTOS ABT-MEC		BLD		25.290	26.290	1.5	1.5	2.0	4.450	2.500	0.000	0.250
BOILERMAKER		BLD		30.970	33.970	2.0	2.0	2.0	8.270	7.740	0.000	0.300
BRICK MASON		BLD		24.650	25.400	2.0	2.0	2.0	6.000	6.700	0.000	0.490
CARPENTER		BLD		26.210	28.210	1.5	1.5	2.0	6.500	6.920	0.000	0.320
CARPENTER		HWY		25.350	27.100	1.5	1.5	2.0	6.500	6.920	0.000	0.300
CEMENT MASON		BLD		23.120	24.870	1.5	1.5	2.0	5.290	10.00	0.000	0.500
CEMENT MASON		HWY		24.140	25.140	1.5	1.5	2.0	5.290	10.00	0.000	0.500
CERAMIC TILE FNSHER		BLD		23.300	0.000	1.5	1.5	2.0	6.000	6.700	0.000	0.000
ELECTRIC PWR EQMT OP		ALL		30.750	0.000	1.5	1.5	2.0	4.750	8.610	0.000	0.000
ELECTRIC PWR GRNDMAN		ALL		21.090	0.000	1.5	1.5	2.0	4.750	5.905	0.000	0.000
ELECTRIC PWR LINEMAN		ALL		34.160	36.350	1.5	1.5	2.0	4.750	9.560	0.000	0.000
ELECTRIC PWR TRK DRV		ALL		22.130	0.000	1.5	1.5	2.0	4.750	6.200	0.000	0.000
ELECTRICIAN	N	BLD		29.860	31.860	1.5	1.5	2.0	5.150	8.060	0.000	0.250
ELECTRICIAN	S	BLD		31.220	33.220	1.5	1.5	2.0	5.150	5.340	0.000	0.300
ELECTRONIC SYS TECH		BLD		23.850	25.350	1.5	1.5	2.0	5.150	5.625	0.000	0.250
ELEVATOR CONSTRUCTOR		BLD		34.190	38.460	2.0	2.0	2.0	8.275	6.060	2.050	0.000
GLAZIER		BLD		27.130	28.130	1.5	2.0	2.0	5.430	4.000	0.000	0.280
HT/FROST INSULATOR		BLD		30.440	31.440	1.5	1.5	2.0	4.850	8.360	0.000	0.450
IRON WORKER	N	BLD		24.960	26.710	1.5	1.5	2.0	8.040	7.410	0.000	0.400
IRON WORKER	N	HWY		25.920	27.420	1.5	1.5	2.0	8.040	7.410	0.000	0.350
IRON WORKER	S	BLD		25.400	27.150	1.5	1.5	2.0	5.860	7.900	0.000	0.300
IRON WORKER	S	HWY		25.400	26.900	1.5	1.5	2.0	5.860	7.900	0.000	0.300
LABORER		BLD		20.760	21.760	1.5	1.5	2.0	5.300	6.030	0.000	0.600
LABORER		HWY		21.680	22.430	1.5	1.5	2.0	5.300	6.030	0.000	0.600
LATHER		BLD		26.210	28.210	1.5	1.5	2.0	6.500	6.920	0.000	0.320
MACHINERY MOVER	N	HWY		25.920	27.420	1.5	1.5	2.0	8.040	7.410	0.000	0.350
MACHINIST		BLD		36.890	38.890	2.0	2.0	2.0	4.380	5.650	2.550	0.000
MARBLE FINISHERS		BLD		23.300	0.000	1.5	1.5	2.0	6.000	6.700	0.000	0.000
MARBLE MASON		BLD		24.800	25.550	2.0	2.0	2.0	6.000	6.700	0.000	0.000
MILLWRIGHT		BLD		26.620	28.620	1.5	1.5	2.0	6.500	6.850	0.000	0.320
MILLWRIGHT		HWY		19.290	20.540	1.5	1.5	2.0	2.800	3.000	0.000	0.000
OPERATING ENGINEER		BLD	1	27.840	30.840	1.5	1.5	2.0	5.900	8.000	0.000	0.900
OPERATING ENGINEER		BLD	2	25.940	30.840	1.5	1.5	2.0	5.900	8.000	0.000	0.900
OPERATING ENGINEER		BLD	3	24.560	30.840	1.5	1.5	2.0	5.900	8.000	0.000	0.900
OPERATING ENGINEER		HWY	1	29.110	32.110	1.5	1.5	2.0	6.250	9.000	0.000	1.000
OPERATING ENGINEER		HWY	2	26.730	32.110	1.5	1.5	2.0	6.250	9.000	0.000	1.000
OPERATING ENGINEER		HWY	3	22.790	32.110	1.5	1.5	2.0	6.250	9.000	0.000	1.000
PAINTER		ALL		26.850	27.850	1.5	1.5	1.5	5.650	5.750	0.000	0.350
PILEDRIVER		BLD		26.710	28.710	1.5	1.5	2.0	6.500	6.920	0.000	0.320
PILEDRIVER		HWY		25.850	27.600	1.5	1.5	2.0	6.500	6.920	0.000	0.300
PIPEFITTER	N	BLD		31.630	35.110	1.5	1.5	2.0	6.450	7.680	0.000	0.420
PIPEFITTER	S	BLD		34.700	37.200	1.5	1.5	2.0	6.450	4.750	0.000	0.350
PLASTERER		BLD		23.400	24.650	1.5	1.5	2.0	5.290	9.800	0.000	0.500
PLUMBER	N	BLD		28.390	30.950	1.5	1.5	2.0	6.450	8.990	0.000	0.800
PLUMBER	S	BLD		34.700	37.200	1.5	1.5	2.0	6.450	4.750	0.000	0.350
ROOFER		BLD		24.310	26.740	1.5	1.5	2.0	4.650	5.250	0.000	0.100
SHEETMETAL WORKER		BLD		27.820	29.570	1.5	1.5	2.0	7.150	7.880	0.000	0.350
SIGN HANGER	N	HWY		25.920	27.420	1.5	1.5	2.0	8.040	7.410	0.000	0.350
SPRINKLER FITTER		BLD		31.240	33.240	1.5	1.5	2.0	6.500	5.350	0.000	0.250
STEEL ERECTOR	N	HWY		25.920	27.420	1.5	1.5	2.0	8.040	7.410	0.000	0.350
STONE MASON		BLD		24.650	25.400	2.0	2.0	2.0	6.000	6.700	0.000	0.490
TERRAZZO FINISHER		BLD		23.300	0.000	1.5	1.5	2.0	6.000	6.700	0.000	0.000
TERRAZZO MASON		BLD		24.800	25.550	2.0	2.0	2.0	6.000	6.700	0.000	0.000
TILE MASON		BLD		24.800	25.550	2.0	2.0	2.0	6.000	6.700	0.000	0.000
TRUCK DRIVER		ALL	1	25.787	0.000	1.5	1.5	2.0	7.250	3.317	0.000	0.000
TRUCK DRIVER		ALL	2	26.187	0.000	1.5	1.5	2.0	7.250	3.317	0.000	0.000
TRUCK DRIVER		ALL	3	26.387	0.000	1.5	1.5	2.0	7.250	3.317	0.000	0.000



TRUCK DRIVER	ALL	4	26.637	0.000	1.5	1.5	2.0	7.250	3.317	0.000	0.000
TRUCK DRIVER	ALL	5	27.387	0.000	1.5	1.5	2.0	7.250	3.317	0.000	0.000
TRUCK DRIVER	O&C	1	20.630	0.000	1.5	1.5	2.0	7.250	3.317	0.000	0.000
TRUCK DRIVER	O&C	2	20.950	0.000	1.5	1.5	2.0	7.250	3.317	0.000	0.000
TRUCK DRIVER	O&C	3	21.110	0.000	1.5	1.5	2.0	7.250	3.317	0.000	0.000
TRUCK DRIVER	O&C	4	21.310	0.000	1.5	1.5	2.0	7.250	3.317	0.000	0.000
TRUCK DRIVER	O&C	5	21.910	0.000	1.5	1.5	2.0	7.250	3.317	0.000	0.000
TUCKPOINTER	BLD		24.650	25.400	2.0	2.0	2.0	6.000	6.700	0.000	0.490

Legend:

M-F>8 (Overtime is required for any hour greater than 8 worked each day, Monday through Friday.)

OSA (Overtime is required for every hour worked on Saturday)

OSH (Overtime is required for every hour worked on Sunday and Holidays)

H/W (Health & Welfare Insurance)

Pensn (Pension)

Vac (Vacation)

Trng (Training)

## Explanations

### MASON COUNTY

ELECTRICIAN (SOUTH) - Townships of Lynchburg, Bath, Kilbourne, Crane Creek, Salt Creek and Mason.

IRONWORKERS (NORTH) - That part of the county North including the towns of Easton and Teheran.

PLUMBERS & PIPEFITTERS (SOUTH) - That part of the county South of Rt. 136 including the City of Havana.

The following list is considered as those days for which holiday rates of wages for work performed apply: New Years Day, Memorial/Decoration Day, Fourth of July, Labor Day, Veterans Day, Thanksgiving Day, Christmas Day. Generally, any of these holidays which fall on a Sunday is celebrated on the following Monday. This then makes work performed on that Monday payable at the appropriate overtime rate for holiday pay. Common practice in a given local may alter certain days of celebration such as the day after Thanksgiving for Veterans Day. If in doubt, please check with IDOL.

Oil and chip resealing (O&C) means the application of road oils and liquid asphalt to coat an existing road surface, followed by application of aggregate chips or gravel to coated surface, and subsequent rolling of material to seal the surface.

### EXPLANATION OF CLASSES

ASBESTOS - GENERAL - removal of asbestos material/mold and hazardous materials from any place in a building, including mechanical systems where those mechanical systems are to be removed. This includes the removal of asbestos materials/mold and hazardous materials from

ductwork or pipes in a building when the building is to be demolished at the time or at some close future date.

ASBESTOS - MECHANICAL - removal of asbestos material from mechanical systems, such as pipes, ducts, and boilers, where the mechanical systems are to remain.

#### CERAMIC TILE FINISHER, MARBLE FINISHER, TERRAZZO FINISHER

Assisting, helping or supporting the tile, marble and terrazzo mechanic by performing their historic and traditional work assignments required to complete the proper installation of the work covered by said crafts. The term "Ceramic" is used for naming the classification only and is in no way a limitation of the product handled. Ceramic takes into consideration most hard tiles.

#### ELECTRONIC SYSTEMS TECHNICIAN

Installation, service and maintenance of low-voltage systems which utilizes the transmission and/or transference of voice, sound, vision, or digital for commercial, education, security and entertainment purposes for the following: TV monitoring and surveillance, background/foreground music, intercom and telephone interconnect, field programming, inventory control systems, microwave transmission, multi-media, multiplex, radio page, school, intercom and sound burglar alarms and low voltage master clock systems.

Excluded from this classification are energy management systems, life safety systems, supervisory controls and data acquisition systems not intrinsic with the above listed systems, fire alarm systems, nurse call systems and raceways exceeding fifteen feet in length.

#### TRUCK DRIVER - BUILDING, HEAVY AND HIGHWAY CONSTRUCTION

Class 1. Drivers on 2 axle trucks hauling less than 9 ton. Air compressor and welding machines and brooms, including those pulled by separate units, truck driver helpers, warehouse employees, mechanic helpers, greasers and tiremen, pickup trucks when hauling materials, tools, or workers to and from and on-the-job site, and fork lifts up to 6,000 lb. capacity.

Class 2. Two or three axle trucks hauling more than 9 ton but hauling less than 16 ton. A-frame winch trucks, hydrolift trucks, vactor trucks or similar equipment when used for transportation purposes. Fork lifts over 6,000 lb. capacity, winch trucks, four axle combination units, and ticket writers.

Class 3. Two, three or four axle trucks hauling 16 ton or more. Drivers on water pulls, articulated dump trucks, mechanics and working forepersons, and dispatchers. Five axle or more combination units.

Class 4. Low Boy and Oil Distributors.

Class 5. Drivers who require special protective clothing while employed on hazardous waste work.

#### TRUCK DRIVER - OIL AND CHIP RESEALING ONLY.

This shall encompass laborers, workers and mechanics who drive contractor or subcontractor owned, leased, or hired pickup, dump, service, or oil distributor trucks. The work includes transporting materials and equipment (including but not limited to, oils, aggregate supplies, parts, machinery and tools) to or from the job site;

distributing oil or liquid asphalt and aggregate; stock piling material when in connection with the actual oil and chip contract. The Truck Driver (Oil & Chip Resealing) wage classification does not include supplier delivered materials.

#### OPERATING ENGINEERS - BUILDING

Class 1. Cranes; Overhead Cranes; Gradall; All Cherry Pickers; Mechanics; Central Concrete Mixing Plant Operator; Road Pavers (27E - Dual Drum - Tri Batchers); Blacktop Plant Operators and Plant Engineers; 3 Drum Hoist; Derricks; Hydro Cranes; Shovels; Skimmer Scoops; Koehring Scooper; Drag Lines; Backhoe; Derrick Boats; Pile Drivers and Skid Rigs; Clamshells; Locomotive Cranes; Dredge (all types) Motor Patrol; Power Blades - Dumore - Elevating and similar types; Tower Cranes (Crawler-Mobile) and Stationary; Crane-type Backfiller; Drott Yumbo and similar types considered as Cranes; Caisson Rigs; Dozer; Tournadozer; Work Boats; Ross Carrier; Helicopter; Tournapulls - all and similar types; Scoops (all sizes); Pushcats; Endloaders (all types); Asphalt Surfacing Machine; Slip Form Paver; Rock Crusher; Heavy Equipment Greaser; CMI, CMI Belt Placer, Auto Grade & 3 Track and similar types; Side Booms; Multiple Unit Earth Movers; Creter Crane; Trench Machine; Pump-crete-Belt Crete-Squeeze Cretes-Screw-type Pumps and Gypsum; Bulker & Pump - Operator will clean; Formless Finishing Machine; Flaherty Spreader or similar types; Screed Man on Laydown Machine; Wheel Tractors (industrial or Farm-type w/Dozer-Hoe-Endloader or other attachments); F.W.D. & Similar Types; Vermeer Concrete Saw.

Class 2. Dinkeys; Power Launches; PH One-pass Soil Cement Machine (and similar types); Pugmill with Pump; Backfillers; Euclid Loader; Forklifts; Jeeps w/Ditching Machine or other attachments; Tuneluger; Automatic Cement and Gravel Batching Plants; Mobile Drills (Soil Testing) and similar types; Gurries and Similar Types; (1) and (2) Drum Hoists (Buck Hoist and Similar Types); Chicago Boom; Boring Machine & Pipe Jacking Machine; Hydro Boom; Dewatering System; Straw Blower; Hydro Seeder; Assistant Heavy Equipment Greaser on Spread; Tractors (Track type) without Power Unit pulling Rollers; Rollers on Asphalt -- Brick Macadem; Concrete Breakers; Concrete Spreaders; Mule Pulling Rollers; Center Stripper; Cement Finishing Machines & CMI Texture & Reel Curing Machines; Cement Finishing Machine; Barber Green or similar loaders; Vibro Tamper (All similar types) Self-propelled; Winch or Boom Truck; Mechanical Bull Floats; Mixers over 3 Bag to 27E; Tractor pulling Power Blade or Elevating Grader; Porter Rex Rail; Clary Screed; Truck Type Hoptoe Oilers; Fireman; Spray Machine on Paving; Curb Machines; Truck Crane Oilers; Oil Distributor; Truck-Mounted Saws.

Class 3. Air Compressor; Power Subgrader; Straight Tractor; Trac Air without attachments; Herman Nelson Heater, Dravo, Warner, Silent Glo, and similar types; Roller: Five (5) Ton and under on Earth or Gravel; Form Grader; Crawler Crane & Skid Rig Oilers; Freight Elevators - permanently installed; Pump; Light Plant; Generator; Conveyor (1) or (2) - Operator will clean; Welding Machine; Mixer (3) Bag and Under (Standard Capacity with skip); Bulk Cement Plant; Oiler on Central Concrete Mixing Plant.

#### OPERATING ENGINEERS - HEAVY AND HIGHWAY CONSTRUCTION

Class 1. Cranes; Hydro Crane; Shovels; Crane Type Backfiller; Tower Cranes - Mobile & Crawler & Stationary; Derricks & Hoists (3 Drum); Draglines; Drott Yumbo & similar types considered as Cranes; Back Hoe; Derrick Boats; Pile Driver and Skid Rigs; Clam Shell; Locomotive - Cranes; Road Pavers - Single Drum - Dual Drum - Tri Batchers; Motor

Patrols & Power Blades - Dumore - Elevating & Similar Types;  
Mechanics; Central Concrete Mixing Plant Operator; Asphalt Batch Plant  
Operators and Plant Engineers; Gradall; Caisson Rigs; Skimmer Scoop  
- Koering Scooper; Dredges (all types); Hoptoe; All Cherry Pickers;  
Work Boat; Ross Carrier; Helicopter; Dozer; Tournadozer; Tournapulls  
- all and similar types; Multiple Unit Earth Movers; Scoops (all  
sizes); Pushcats; Endloaders (all types); Asphalt Surfacing Machine;  
Slip Form Paver; Rock Crusher; Heavy Equipment Greaser (top greaser on  
spread); CMI, Auto Grade, CMI Belt Placer & 3 Track and similar  
types; Side Booms; Starting Engineer on Pipeline; Asphalt Heater &  
Planer Combination (used to plane streets); Wheel Tractors (with  
dozer, hoe or endloader attachments); F.W.D. and Similar types; Blaw  
Knox Spreader and Similar types; Trench Machines; Pump Crete - Belt  
Crete - Squeeze Crete - screw type pumps and gypsum (operator will  
clean); Formless Finishing Machines; Flaherty Spreader or similar  
types; Screed Man on Laydown Machine; Vermeer Concrete Saw.

Class 2. Bulker & Pump; Power Launches; Boring Machine & Pipe Jacking  
Machine; Dinkeys; P-H One Pass Soil Cement Machines and similar  
types; Wheel Tractors (Industry or farm type - other); Back Fillers;  
Euclid Loader; Fork Lifts; Jeep w/Ditching Machine or other  
attachments; Tunneluger; Automatic Cement & Gravel Batching Plants;  
Mobile Drills - Soil Testing and similar types; Pugmill with pump; All  
(1) and (2) Drum Hoists; Dewatering System; Straw Blower;  
Hydro-Seeder; Boring Machine; Hydro-Boom; Bump Grinders  
(self-propelled); Assistant Heavy Equipment Greaser; Apsco Spreader;  
Tractors (track-type) without Power Units Pulling Rollers on Asphalt  
- Brick or Macadam; Concrete Breakers; Concrete Spreaders; Cement  
Strippers; Cement Finishing Machines & CMI Texture & Reel Curing  
Machines; Vibro-Tampers (all similar types self-propelled); Mechanical  
Bull Floats; Self-propelled Concrete Saws; Mixers-over three (3) bags  
to 27E; Winch and Boom Trucks; Tractor Pulling Power Blade or  
Elevating Grader; Porter Rex Rail; Clary Screed; Mule Pulling Rollers;  
Pugmill without Pump; Barber Greene or similar Loaders; Track Type  
Tractor w/Power Unit attached (minimum); Fireman; Spray Machine on  
Paving; Curb Machines; Paved Ditch Machine; Power Broom;  
Self-Propelled Conveyors; Power Subgrader; Oil Distributor; Straight  
Tractor; Truck Crane Oiler; Truck Type Oilers; Directional boring  
machine; Horizontal directional drill.

Class 3. Straight framed articulating end dump vehicles and Truck  
mounted vac unit (separately powered); Trac Air Machine (without  
attachments); Herman Nelson Heater, Dravo Warner, Silent Glo &  
similar types; Rollers - five ton and under on earth and gravel; Form  
Graders; Pumps; Light Plant; Generator; Air Compressor (1) or (2);  
Conveyor; Welding Machine; Mixer - 3 bags and under; Bulk Cement  
Plant; Oilers.

#### Other Classifications of Work:

For definitions of classifications not otherwise set out, the  
Department generally has on file such definitions which are available.  
If a task to be performed is not subject to one of the  
classifications of pay set out, the Department will upon being  
contacted state which neighboring county has such a classification and  
provide such rate, such rate being deemed to exist by reference in  
this document. If no neighboring county rate applies to the task,  
the Department shall undertake a special determination, such special  
determination being then deemed to have existed under this  
determination. If a project requires these, or any classification not  
listed, please contact IDOL at 618/993-7271 for wage rates or  
clarifications.

## LANDSCAPING

Landscaping work falls under the existing classifications for laborer, operating engineer and truck driver. The work performed by landscape plantsman and landscape laborer is covered by the existing classification of laborer. The work performed by landscape operators (regardless of equipment used or its size) is covered by the classifications of operating engineer. The work performed by landscape truck drivers (regardless of size of truck driven) is covered by the classifications of truck driver.

# Massac County Prevailing Wage for April 2007

Trade Name	RG	TYP	C	Base	FRMAN	*M-F>8	OSA	OSH	H/W	Pensn	Vac	Trng
=====	==	==	=	=====	=====	=====	==	==	=====	=====	=====	=====
ASBESTOS ABT-GEN		ALL		20.750	21.200	1.5	1.5	2.0	5.250	5.600	0.000	0.700
ASBESTOS ABT-MEC		BLD		20.800	0.000	2.0	2.0	2.0	5.000	3.400	0.000	0.000
BOILERMAKER		BLD		28.500	31.000	1.5	1.5	2.0	6.820	11.03	0.000	0.300
BRICK MASON		BLD		25.470	26.970	1.5	1.5	2.0	6.000	5.400	0.000	0.425
CARPENTER		BLD		27.780	29.280	1.5	1.5	2.0	5.050	3.750	0.000	0.350
CARPENTER		HWY		27.730	29.230	1.5	1.5	2.0	5.050	3.750	0.000	0.350
CEMENT MASON		BLD		23.500	24.500	1.5	1.5	2.0	5.200	3.550	0.000	0.100
CEMENT MASON		HWY		23.750	24.750	1.5	1.5	2.0	5.300	3.700	0.000	0.300
CERAMIC TILE FNSHER		BLD		24.990	0.000	1.5	1.5	2.0	6.000	5.400	0.000	0.425
ELECTRICIAN		ALL		32.910	35.160	1.5	1.5	2.0	5.150	6.580	0.000	0.490
ELECTRONIC SYS TECH		BLD		25.700	27.200	1.5	1.5	2.0	5.150	3.340	0.000	0.250
FLOOR LAYER		BLD		26.930	27.680	1.5	1.5	2.0	5.000	3.750	0.000	0.350
GLAZIER		BLD		22.930	0.000	1.5	1.5	2.0	4.320	3.800	0.000	0.300
HT/FROST INSULATOR		BLD		26.110	27.110	1.5	1.5	2.0	4.800	6.860	0.000	0.190
IRON WORKER		ALL		22.650	23.650	1.5	1.5	2.0	5.760	6.450	0.000	0.310
LABORER		BLD		20.750	21.200	1.5	1.5	2.0	5.250	5.600	0.000	0.600
LABORER		HWY		21.000	21.450	1.5	1.5	2.0	5.350	6.150	0.000	0.600
LABORER		O&C		15.750	16.200	1.5	1.5	2.0	5.350	6.150	0.000	0.600
MACHINIST		BLD		36.890	38.890	2.0	2.0	2.0	4.380	5.650	2.550	0.000
MARBLE FINISHERS		BLD		24.990	0.000	1.5	1.5	2.0	6.000	5.400	0.000	0.425
MARBLE MASON		BLD		25.470	26.970	1.5	1.5	2.0	6.000	5.400	0.000	0.425
MILLWRIGHT		BLD		27.780	29.280	1.5	1.5	2.0	5.050	3.750	0.000	0.350
MILLWRIGHT		HWY		27.730	29.230	1.5	1.5	2.0	5.050	3.750	0.000	0.350
OE RIVER 1		RIV	1	26.900	0.000	1.5	1.5	2.0	5.650	6.100	0.000	1.100
OE RIVER 2		RIV	2	23.450	0.000	1.5	1.5	2.0	5.650	6.100	0.000	1.100
OPERATING ENGINEER		ALL	1	26.800	27.800	1.5	1.5	2.0	5.650	6.100	0.000	1.100
OPERATING ENGINEER		ALL	2	24.900	27.800	1.5	1.5	2.0	5.650	6.100	0.000	1.100
OPERATING ENGINEER		ALL	3	24.150	27.800	1.5	1.5	2.0	5.650	6.100	0.000	1.100
OPERATING ENGINEER		ALL	4	21.400	27.800	1.5	1.5	2.0	5.650	6.100	0.000	1.100
OPERATING ENGINEER		O&C	1	20.100	21.100	1.5	1.5	2.0	5.650	6.100	0.000	1.100
OPERATING ENGINEER		O&C	2	18.680	21.100	1.5	1.5	2.0	5.650	6.100	0.000	1.100
OPERATING ENGINEER		O&C	3	18.120	21.100	1.5	1.5	2.0	5.650	6.100	0.000	1.100
OPERATING ENGINEER		O&C	4	16.050	21.100	1.5	1.5	2.0	5.650	6.100	0.000	1.100
PAINTER		BLD		17.750	18.750	1.5	1.5	2.0	5.250	2.750	0.000	0.000
PAINTER		HWY		24.000	25.000	1.5	1.5	2.0	5.250	2.750	0.000	0.000
PAINTER OVER 30FT		BLD		17.750	18.750	1.5	1.5	2.0	5.250	2.750	0.000	0.000
PAINTER OVER 30FT		HWY		24.250	25.250	1.5	1.5	2.0	5.250	2.750	0.000	0.000
PAINTER PWR EQMT		BLD		17.750	18.750	1.5	1.5	2.0	5.250	2.750	0.000	0.000
PAINTER PWR EQMT		HWY		24.250	25.250	1.5	1.5	2.0	5.250	2.750	0.000	0.000
PILEDRIVER		BLD		27.780	29.280	1.5	1.5	2.0	5.050	3.750	0.000	0.350
PILEDRIVER		HWY		27.730	29.230	1.5	1.5	2.0	5.050	3.750	0.000	0.350
PIPEFITTER		BLD		31.300	34.430	1.5	2.0	2.0	6.450	5.030	0.000	0.620
PLASTERER		BLD		23.500	24.500	1.5	1.5	2.0	5.200	3.550	0.000	0.100
PLUMBER		BLD		31.300	34.430	1.5	2.0	2.0	6.450	5.030	0.000	0.620
ROOFER		BLD		24.690	26.190	1.5	1.5	2.0	4.380	4.000	0.000	0.000
SHEETMETAL WORKER		ALL		27.210	28.460	1.5	1.5	2.0	6.000	4.770	1.630	0.120
SPRINKLER FITTER		BLD		31.240	33.240	1.5	1.5	2.0	6.500	5.350	0.000	0.250
STONE MASON		BLD		25.470	26.970	1.5	1.5	2.0	6.000	5.400	0.000	0.425
TERRAZZO FINISHER		BLD		24.990	0.000	1.5	1.5	2.0	6.000	5.400	0.000	0.425
TRUCK DRIVER		ALL	1	24.990	0.000	1.5	1.5	2.0	7.250	4.200	0.000	0.000
TRUCK DRIVER		ALL	2	25.390	0.000	1.5	1.5	2.0	7.250	4.200	0.000	0.000
TRUCK DRIVER		ALL	3	25.590	0.000	1.5	1.5	2.0	7.250	4.200	0.000	0.000
TRUCK DRIVER		ALL	4	25.840	0.000	1.5	1.5	2.0	7.250	4.200	0.000	0.000
TRUCK DRIVER		ALL	5	26.590	0.000	1.5	1.5	2.0	7.250	4.200	0.000	0.000
TRUCK DRIVER		O&C	1	19.500	0.000	1.5	1.5	2.0	4.275	4.670	0.000	0.000
TRUCK DRIVER		O&C	2	15.900	0.000	1.5	1.5	2.0	4.275	4.670	0.000	0.000
TRUCK DRIVER		O&C	3	16.400	0.000	1.5	1.5	2.0	4.275	4.670	0.000	0.000
TUCK POINTER		BLD		25.470	26.970	1.5	1.5	2.0	6.000	5.400	0.000	0.425

Legend :

M-F>8 (Overtime is required for any hour greater than 8 worked each day, Monday through Friday.)

OSA (Overtime is required for every hour worked on Saturday)

OSH (Overtime is required for every hour worked on Sunday and Holidays)

H/W (Health & Welfare Insurance)

Pensn (Pension)

Vac (Vacation)

Trng (Training)

## Explanations

### MASSAC COUNTY

The following list is considered as those days for which holiday rates of wages for work performed apply: New Years Day, Memorial/Decoration Day, Fourth of July, Labor Day, Veterans Day, Thanksgiving Day, Christmas Day. Generally, any of these holidays which fall on a Sunday is celebrated on the following Monday. This then makes work performed on that Monday payable at the appropriate overtime rate for holiday pay. Common practice in a given local may alter certain days of celebration such as the day after Thanksgiving for Veterans Day. If in doubt, please check with IDOL.

Oil and chip resealing (O&C) means the application of road oils and liquid asphalt to coat an existing road surface, followed by application of aggregate chips or gravel to coated surface, and subsequent rolling of material to seal the surface.

### EXPLANATION OF CLASSES

ASBESTOS - GENERAL - removal of asbestos material/mold and hazardous materials from any place in a building, including mechanical systems where those mechanical systems are to be removed. This includes the removal of asbestos materials/mold and hazardous materials from ductwork or pipes in a building when the building is to be demolished at the time or at some close future date.

ASBESTOS - MECHANICAL - removal of asbestos material from mechanical systems, such as pipes, ducts, and boilers, where the mechanical systems are to remain.

### LABORER - OIL AND CHIP RESEALING ONLY

Hook and unhook chip box from aggregate truck; distribute material within chip box; perform flagging work related to oil and chip resealing; hand spray oil fluids; handle traffic control, including setting-up and maintaining barricades, drums, cones, delineators, signs and other such items, as well as laying-out and applying or removing temporary roadway markings used to control traffic in job site related to oil and chip resealing; and perform clean-up related

to oil and chip resealing.

#### CERAMIC TILE FINISHER, MARBLE FINISHER, TERRAZZO FINISHER

Assisting, helping or supporting the tile, marble and terrazzo mechanic by performing their historic and traditional work assignments required to complete the proper installation of the work covered by said crafts. The term "Ceramic" is used for naming the classification only, and is in no a limitation of the product handled. Ceramic takes into consideration most hard tiles.

#### ELECTRONIC SYSTEMS TECHNICIAN

Installation, service and maintenance of low-voltage systems which utilizes the transmission and/or transference of voice, sound, vision, or digital for commercial, education, security and entertainment purposes for the following: TV monitoring and surveillance, background/foreground music, intercom and telephone interconnect, field programming, inventory control systems, microwave transmission, multi-media, multiplex, radio page, school, intercom and sound burglar alarms and low voltage master clock systems.

Excluded from this classification are energy management systems, life safety systems, supervisory controls and data acquisition systems not intrinsic with the above listed systems, fire alarm systems, nurse call systems and raceways exceeding fifteen feet in length.

#### TRUCK DRIVER - BUILDING, HEAVY AND HIGHWAY CONSTRUCTION

Class 1. Drivers on 2 axle trucks hauling less than 9 ton. Air compressor and welding machines and brooms, including those pulled by separate units, truck driver helpers, warehouse employees, mechanic helpers, greasers and tiremen, pickup trucks when hauling materials, tools, or workers to and from and on-the-job site, and fork lifts up to 6,000 lb. capacity.

Class 2. Two or three axle trucks hauling more than 9 ton but hauling less than 16 ton. A-frame winch trucks, hydrolift trucks, vector trucks or similar equipment when used for transportation purposes. Fork lifts over 6,000 lb. capacity, winch trucks, four axle combination units, and ticket writers.

Class 3. Two, three or four axle trucks hauling 16 ton or more. Drivers on water pulls, articulated dump trucks, mechanics and working forepersons, and dispatchers. Five axle or more combination units.

Class 4. Low Boy and Oil Distributors.

Class 5. Drivers who require special protective clothing while employed on hazardous waste work.

#### TRUCK DRIVER - O & C (Oil and Chip Resealing ONLY)

It involves driving of contractor or subcontractor owned, leased, or hired pickup, dump, service, or oil distributor trucks. Includes transporting materials and equipment (including, but not limited to oils, aggregate supplies, parts, machinery and tools) to or from the job site; distributing oil or liquid asphalt and aggregate; stock piling material; and maintaining trucks at job site related to oil and chip resealing.

Class 1. Distributors, liquid asphalt hauling and hauling of asphalt rubber-tired rollers.



Class 2. Stockpiling.

Class 3. Tandem hauling to job site.

OPERATING ENGINEERS - BUILDING, HEAVY AND HIGHWAY CONSTRUCTION

Class 1. APSCO or Equal Spreading Machine, Backhoe, Backfiller, Boom or Winch Cat, Bituminous Mixplane Machine, Blacksmith, Bituminous Surfacing Machine, Bull-Dozer, Crane, Shovel, Dragline, Truck Crane, Pile Driver, Concrete Breaker, Concrete or Pumpcrete Pumps, Dinky or Standard Locomotives, Well or Caisson Drills, Elevating Grader, Fork Lifts, Flexplane, Gradeall, Hi-Lift Hoists, Guy-Derricks, Hysters, Mechanic Motor Patrol, Mixers-21 cu. ft. or over, Push Cats, Pulls and Scrapers, Two Well Point Pumps, Pulverizer or Tiller, PugMill, Rubber-Tired Farm Type Tractor with Bulldozer/Blade/Auger or hi-lift over 1/2 yd., Jersey Spreader, Tract-Air used with Drill or Hi-Lift, Trenching or Ditching Machines, Wood Chipper w/Tractor, Self-Propelled Roller w/Blade, Equipment Greaser, Self-Propelled Bump Grinder on Concrete pavement, Boat Operator, Skid-Loaders, Tuggers, Lazer Screed, and Self-Propelled Chip Spreader (when others run conveyors).

Class 2. Any type tractor pulling any type roller or disc, Two Air Compressors (220 cu. ft. capacity or over), Two AirTract Drills, Air-Track Drill w/Compressor, Automatic Bins or Scales w/Compressor or Generator, Pipeline Boring Machine, Bulk Cement Plant w/Separate Compressor, Power Operated Bull Float, Hydra-Lift w/Single Motor, Straw Mulcher Blower w/Spout, Self-Propelled Roller/Compactor, Back-End man on Bituminous Surfacing Machine, oiler on milling machine.

Class 3. Air Compressor w/Valve driving piling, Boom or Winch Type Truck, Two Conveyors, Self-Propelled Concrete Saw, Form Grader, Truck Crane Oiler, Self-Propelled Vibrator, Rubber Tired Farm Type Tractor w/Blade/Bulldozer/Auger/hi-lift - 1/2 yd. or less, Elevator Operator, Man Lift (scissor lift) when lifting materials.

Class 4. Air-Track Drill (one), Belt Drag Machine, Power Broom, Mechanical Plasterer Applicator, Trac-Air, Air Compressor (220 cu. ft. or over) One, Air Compressor (under 220 cu. ft) four, Automatic Bin, Bulk Cement Plant w/Built-in Compressor running off same motor or electric motor, Fireman or Switchman, Self-Propelled Form Tamper, Light Plants (4), Welding Machines (4), Pumps (4), or Combination of four (4) Pumps, Light Plants, Welding Machines, Air-Compressors (under 220 cu. ft.), Mudjacks or Wood Chipper, Mixers - less than 21 cu. ft. Mortar Mixer w/Skip or Pump, Pipeline Tract Jack. One Operating Engineer may operate and maintain any combination of the following pieces of equipment, not to exceed four (4) which shall be within a reasonable distance, such combination may include any equipment in this classification: (Compressors, Light Plants, Generators, Welding Machines, Pumps or Conveyors), One Well- Point Pump, Two Motor Driven Heaters, One Air Compressor (under 220 cu. ft.), One Engine-Driven Conveyor, One Motor Driven Heater, One Light Plant, One Pump, One Welding Machine, One Ulmac or Equal Spreader, Oilers, and one Generator 10 kw or greater.

OPERATING ENGINEER - O & C (Oil and Chip Resealing ONLY). Includes the operation of all motorized heavy equipment used in oil and chip rsealing, including but not limited to operating self-propelled chip spreaders, and all types of rollers (both hard and rubber tired); and other duties pertaining to the operation or maintenance of heavy equipment related to oil and chip resealing.

Class 1. See Class 1 above for types of equipment operated.

Class 2. See Class 2 above for types of equipment operated.

Class 3. See Class 3 above for types of equipment operated.

Class 4. See Class 4 above for types of equipment operated.

OPERATING ENGINEER RIVER WORK 1 - operate the following machines when working on River Work and Levee Work on the Mississippi and Ohio Rivers, Lakes and Tributaries: Crane, Shovel, Drageline, Scrapers, Dredge, Derrick, Pile-Driver, Push Boat, all power boat operators, Mechanic, Engineman on Dredge, Leverman on Dredge, All Bituminous Spreader machines, Backhoe, Backfiller, Boom, or Winch Cat, Bituminous Mixplane Machine, Blacksmith, Bituminous Surfacing Machine, Bulldozer, Truck Cranes, Hydraulic Truck Mounted Boom/Crane, Concrete Finishing Machine, or Spreader Machine, Concrete Breaker, Concrete or Pumpcrete Machines, Concrete Plant Operator, All Off Road Material Hauling Equipment, Dinky or Standard Locomotives, Well Drill, Elevating Grader, Fork-Lifts, Flexplane, Gradeall, Hi-Lift, Power Handblade Tugger type Hoist, Hoist Two Drum (or over one), Gyderrick, Hyster, Motor Patrol, Mixers - 21 Cu. Ft. or over, Push Cat, Pulls, & Scrapers, Pumps-Two Well Points, Equipment Greaser, P & H Pulverizer or Pulverizer equal to Pugmill, Pugmill, Rubber-Tired farm type tractor w/Bulldozer/Blade/Auger or Hi-Lift over ½ yard, Skimmer Scoops, Seaman Tiller, Jersey Spreader, Tract-Air used with Drill or Hi-Lift, Trenching or Ditching Machine, Wood Chipper w/Tractor, self-propelled roller w/Blade, Concrete Pumps and Small Equipment Operators.

OPERATING ENGINEER RIVER 2 - when working on River Work and Levee Work on the Mississippi and Ohio Rivers, Lakes and Tributaries shall be employed as the Oiler or Fireman on Crane, Dragline, Shovel, Dredge, Truck Crane, Pile Driver, Gradeall, Dinky or Standard Locomotive, Guy Derrick, Trenching Machine or Ditching Machine 80 H.P. and over, All Terrain (cherry-picker) with over 40 ton Lifting Capacity, Deck Oiler and Deckhands.

#### Other Classifications of Work:

For definitions of classifications not otherwise set out, the Department generally has on file such definitions which are available. If a task to be performed is not subject to one of the classifications of pay set out, the Department will upon being contacted state which neighboring county has such a classification and provide such rate, such rate being deemed to exist by reference in this document. If no neighboring county rate applies to the task, the Department shall undertake a special determination, such special determination being then deemed to have existed under this determination. If a project requires these, or any classification not listed, please contact IDOL at 618/993-7271 for wage rates or clarifications.

#### LANDSCAPING

Landscaping work falls under the existing classifications for laborer, operating engineer and truck driver. The work performed by landscape plantsman and landscape laborer is covered by the existing classification of laborer. The work performed by landscape operators (regardless of equipment used or its size) is covered by the classifications of operating engineer. The work performed by landscape truck drivers (regardless of size of truck driven) is covered by the classifications of truck driver.

# Mcdonough County Prevailing Wage for April 2007

Trade Name	RG	TYP	C	Base	FRMAN	*M-F>8	OSA	OSH	H/W	Pensn	Vac	Trng
=====	==	===	=	=====	=====	=====	===	===	=====	=====	=====	=====
ASBESTOS ABT-GEN		BLD		22.185	22.185	1.5	1.5	2.0	5.300	7.030	0.000	0.600
ASBESTOS ABT-GEN		HWY		21.240	21.990	1.5	1.5	2.0	5.300	7.030	0.000	0.600
ASBESTOS ABT-MEC		BLD		18.750	19.750	1.5	1.5	2.0	4.750	2.000	0.000	0.000
BOILERMAKER		BLD		30.970	33.970	2.0	2.0	2.0	8.270	7.740	0.000	0.300
BRICK MASON		BLD		24.370	25.370	1.5	1.5	2.0	6.000	5.400	0.000	0.490
CARPENTER		BLD		26.210	28.210	1.5	1.5	2.0	6.500	6.920	0.000	0.320
CARPENTER		HWY		27.090	29.090	1.5	1.5	2.0	6.500	6.920	0.000	0.320
CEMENT MASON		BLD		22.800	23.800	1.5	1.5	2.0	5.200	8.080	0.000	0.150
CEMENT MASON		HWY		24.600	25.600	1.5	1.5	2.0	5.200	4.870	0.000	0.250
CERAMIC TILE FNSHER		BLD		23.020	0.000	1.5	1.5	2.0	6.000	5.400	0.000	0.000
ELECTRIC PWR EQMT OP		ALL		30.750	0.000	1.5	1.5	2.0	4.750	8.610	0.000	0.000
ELECTRIC PWR GRNDMAN		ALL		21.090	0.000	1.5	1.5	2.0	4.750	5.905	0.000	0.000
ELECTRIC PWR LINEMAN		ALL		34.160	36.350	1.5	1.5	2.0	4.750	9.560	0.000	0.000
ELECTRIC PWR TRK DRV		ALL		22.130	0.000	1.5	1.5	2.0	4.750	6.200	0.000	0.000
ELECTRICIAN	N	BLD		27.040	29.040	1.5	1.5	2.0	5.150	7.460	0.000	0.250
ELECTRICIAN	S	BLD		25.290	27.290	1.5	1.5	2.0	5.150	6.460	0.000	0.250
ELECTRONIC SYS TECH		BLD		23.850	25.350	1.5	1.5	2.0	5.150	5.625	0.000	0.250
ELEVATOR CONSTRUCTOR		BLD		34.190	38.460	2.0	2.0	2.0	8.275	6.060	2.050	0.000
GLAZIER		BLD		26.320	27.070	1.5	1.5	2.0	5.650	5.750	0.000	0.350
HT/FROST INSULATOR		BLD		25.860	27.060	1.5	1.5	2.0	4.800	7.500	0.000	0.000
IRON WORKER		ALL		21.500	22.750	1.5	1.5	2.0	5.760	6.790	0.000	0.260
LABORER		BLD		22.185	22.185	1.5	1.5	2.0	5.300	7.030	0.000	0.600
LABORER		HWY		21.240	21.990	1.5	1.5	2.0	5.300	7.030	0.000	0.600
LATHER		BLD		26.210	28.210	1.5	1.5	2.0	6.500	6.920	0.000	0.320
MACHINIST		BLD		36.890	38.890	2.0	2.0	2.0	4.380	5.650	2.550	0.000
MARBLE FINISHERS		BLD		23.020	0.000	1.5	1.5	2.0	6.000	5.400	0.000	0.000
MARBLE MASON		BLD		24.520	25.270	1.5	1.5	2.0	6.000	5.400	0.000	0.000
MILLWRIGHT		BLD		26.620	28.620	1.5	1.5	2.0	6.500	6.850	0.000	0.320
MILLWRIGHT		HWY		27.010	29.010	1.5	1.5	2.0	6.500	6.450	0.000	0.320
OPERATING ENGINEER		BLD 1		27.840	30.840	1.5	1.5	2.0	5.900	8.000	0.000	0.900
OPERATING ENGINEER		BLD 2		25.940	30.840	1.5	1.5	2.0	5.900	8.000	0.000	0.900
OPERATING ENGINEER		BLD 3		24.560	30.840	1.5	1.5	2.0	5.900	8.000	0.000	0.900
OPERATING ENGINEER		HWY 1		29.110	32.110	1.5	1.5	2.0	6.250	9.000	0.000	1.000
OPERATING ENGINEER		HWY 2		26.730	32.110	1.5	1.5	2.0	6.250	9.000	0.000	1.000
OPERATING ENGINEER		HWY 3		22.790	32.110	1.5	1.5	2.0	6.250	9.000	0.000	1.000
PAINTER		ALL		26.850	27.850	1.5	1.5	1.5	5.650	5.750	0.000	0.350
PILEDRIVER		BLD		26.710	28.710	1.5	1.5	2.0	6.500	6.920	0.000	0.320
PILEDRIVER		HWY		28.090	30.090	1.5	1.5	2.0	6.500	6.920	0.000	0.320
PIPEFITTER		BLD		31.630	35.110	1.5	1.5	2.0	6.450	7.680	0.000	0.420
PLASTERER		BLD		25.000	26.500	1.5	1.5	2.0	4.830	8.050	0.000	0.500
PLUMBER		BLD		28.390	30.950	1.5	1.5	2.0	6.450	8.990	0.000	0.800
ROOFER		BLD		24.200	25.200	1.5	1.5	2.0	5.350	6.550	0.000	0.150
SHEETMETAL WORKER		BLD		27.300	29.000	1.5	1.5	2.0	6.040	7.300	0.000	0.380
SPRINKLER FITTER		BLD		31.240	33.240	1.5	1.5	2.0	6.500	5.350	0.000	0.250
STONE MASON		BLD		24.370	25.370	1.5	1.5	2.0	6.000	5.400	0.000	0.490
TERRAZZO FINISHER		BLD		23.020	0.000	1.5	1.5	2.0	6.000	5.400	0.000	0.000
TILE MASON		BLD		24.520	25.270	1.5	1.5	2.0	6.000	5.400	0.000	0.000
TRUCK DRIVER		ALL 1		25.787	0.000	1.5	1.5	2.0	7.250	3.317	0.000	0.000
TRUCK DRIVER		ALL 2		26.187	0.000	1.5	1.5	2.0	7.250	3.317	0.000	0.000
TRUCK DRIVER		ALL 3		26.387	0.000	1.5	1.5	2.0	7.250	3.317	0.000	0.000
TRUCK DRIVER		ALL 4		26.637	0.000	1.5	1.5	2.0	7.250	3.317	0.000	0.000
TRUCK DRIVER		ALL 5		27.387	0.000	1.5	1.5	2.0	7.250	3.317	0.000	0.000
TRUCK DRIVER		O&C 1		20.630	0.000	1.5	1.5	2.0	7.250	3.317	0.000	0.000
TRUCK DRIVER		O&C 2		20.950	0.000	1.5	1.5	2.0	7.250	3.317	0.000	0.000
TRUCK DRIVER		O&C 3		21.110	0.000	1.5	1.5	2.0	7.250	3.317	0.000	0.000
TRUCK DRIVER		O&C 4		21.310	0.000	1.5	1.5	2.0	7.250	3.317	0.000	0.000
TRUCK DRIVER		O&C 5		21.910	0.000	1.5	1.5	2.0	7.250	3.317	0.000	0.000
TUCKPOINTER		BLD		24.370	25.370	1.5	1.5	2.0	6.000	5.400	0.000	0.490

Legend :

M-F>8 (Overtime is required for any hour greater than 8 worked each day, Monday through Friday.)

OSA (Overtime is required for every hour worked on Saturday)

OSH (Overtime is required for every hour worked on Sunday and Holidays)

H/W (Health & Welfare Insurance)

Pensn (Pension)

Vac (Vacation)

Trng (Training)

## Explanations

### MCDONOUGH COUNTY

ELECTRICIANS (NORTH) - Blandinville, Bushnell, Chalmers, Colchester, Emmet, Hire, Macomb, Mound, New Sales, Prairie City, Scotland, Sciota, Tennessee, and Walnut Grove.

ELECTRICIANS (SOUTH) - Bethel, Eldorado, Industry and Lamoine.

The following list is considered as those days for which holiday rates of wages for work performed apply: New Years Day, Memorial/Decoration Day, Fourth of July, Labor Day, Veterans Day, Thanksgiving Day, Christmas Day. Generally, any of these holidays which fall on a Sunday is celebrated on the following Monday. This then makes work performed on that Monday payable at the appropriate overtime rate for holiday pay. Common practice in a given local may alter certain days of celebration such as the day after Thanksgiving for Veterans Day. If in doubt, please check with IDOL.

Oil and chip resealing (O&C) means the application of road oils and liquid asphalt to coat an existing road surface, followed by application of aggregate chips or gravel to coated surface, and subsequent rolling of material to seal the surface.

### EXPLANATION OF CLASSES

ASBESTOS - GENERAL - removal of asbestos material/mold and hazardous materials from any place in a building, including mechanical systems where those mechanical systems are to be removed. This includes the removal of asbestos materials/mold and hazardous materials from ductwork or pipes in a building when the building is to be demolished at the time or at some close future date.

ASBESTOS - MECHANICAL - removal of asbestos material from mechanical systems, such as pipes, ducts, and boilers, where the mechanical systems are to remain.

### CERAMIC TILE FINISHER, MARBLE FINISHER, TERRAZZO FINISHER

Assisting, helping or supporting the tile, marble and terrazzo mechanic by performing their historic and traditional work assignments required to complete the proper installation of the work covered by

said crafts. The term "Ceramic" is used for naming the classification only and is in no way a limitation of the product handled. Ceramic takes into consideration most hard tiles.

#### ELECTRONIC SYSTEMS TECHNICIAN

Installation, service and maintenance of low-voltage systems which utilizes the transmission and/or transference of voice, sound, vision, or digital for commercial, education, security and entertainment purposes for the following: TV monitoring and surveillance, background/foreground music, intercom and telephone interconnect, field programming, inventory control systems, microwave transmission, multi-media, multiplex, radio page, school, intercom and sound burglar alarms and low voltage master clock systems.

Excluded from this classification are energy management systems, life safety systems, supervisory controls and data acquisition systems not intrinsic with the above listed systems, fire alarm systems, nurse call systems and raceways exceeding fifteen feet in length.

#### TRUCK DRIVER - BUILDING, HEAVY AND HIGHWAY CONSTRUCTION

Class 1. Drivers on 2 axle trucks hauling less than 9 ton. Air compressor and welding machines and brooms, including those pulled by separate units, truck driver helpers, warehouse employees, mechanic helpers, greasers and tiremen, pickup trucks when hauling materials, tools, or workers to and from and on-the-job site, and fork lifts up to 6,000 lb. capacity.

Class 2. Two or three axle trucks hauling more than 9 ton but hauling less than 16 ton. A-frame winch trucks, hydrolift trucks, vector trucks or similar equipment when used for transportation purposes. Fork lifts over 6,000 lb. capacity, winch trucks, four axle combination units, and ticket writers.

Class 3. Two, three or four axle trucks hauling 16 ton or more. Drivers on water pulls, articulated dump trucks, mechanics and working forepersons, and dispatchers. Five axle or more combination units.

Class 4. Low Boy and Oil Distributors.

Class 5. Drivers who require special protective clothing while employed on hazardous waste work.

#### TRUCK DRIVER - OIL AND CHIP RESEALING ONLY.

This shall encompass laborers, workers and mechanics who drive contractor or subcontractor owned, leased, or hired pickup, dump, service, or oil distributor trucks. The work includes transporting materials and equipment (including but not limited to, oils, aggregate supplies, parts, machinery and tools) to or from the job site; distributing oil or liquid asphalt and aggregate; stock piling material when in connection with the actual oil and chip contract. The Truck Driver (Oil & Chip Resealing) wage classification does not include supplier delivered materials.

#### OPERATING ENGINEERS - BUILDING

Class 1. Cranes; Overhead Cranes; Gradall; All Cherry Pickers; Mechanics; Central Concrete Mixing Plant Operator; Road Pavers (27E - Dual Drum - Tri Batchers); Blacktop Plant Operators and Plant Engineers; 3 Drum Hoist; Derricks; Hydro Cranes; Shovels; Skimmer Scoops; Koehring Scooper; Drag Lines; Backhoe; Derrick Boats; Pile

Drivers and Skid Rigs; Clamshells; Locomotive Cranes; Dredge (all types) Motor Patrol; Power Blades - Dumore - Elevating and similar types; Tower Cranes (Crawler-Mobile) and Stationary; Crane-type Backfiller; Drott Yumbo and similar types considered as Cranes; Caisson Rigs; Dozer; Tournadozer; Work Boats; Ross Carrier; Helicopter; Tournapulls - all and similar types; Scoops (all sizes); Pushcats; Endloaders (all types); Asphalt Surfacing Machine; Slip Form Paver; Rock Crusher; Heavy Equipment Greaser; CMI, CMI Belt Placer, Auto Grade & 3 Track and similar types; Side Booms; Multiple Unit Earth Movers; Creter Crane; Trench Machine; Pump-crete-Belt Crete-Squeeze Cretes-Screw-type Pumps and Gypsum; Bulker & Pump - Operator will clean; Formless Finishing Machine; Flaherty Spreader or similar types; Screed Man on Laydown Machine; Wheel Tractors (industrial or Farm-type w/Dozer-Hoe-Endloader or other attachments); F.W.D. & Similar Types; Vermeer Concrete Saw.

Class 2. Dinkeys; Power Launches; PH One-pass Soil Cement Machine (and similar types); Pugmill with Pump; Backfillers; Euclid Loader; Forklifts; Jeeps w/Ditching Machine or other attachments; Tuneluger; Automatic Cement and Gravel Batching Plants; Mobile Drills (Soil Testing) and similar types; Gurries and Similar Types; (1) and (2) Drum Hoists (Buck Hoist and Similar Types); Chicago Boom; Boring Machine & Pipe Jacking Machine; Hydro Boom; Dewatering System; Straw Blower; Hydro Seeder; Assistant Heavy Equipment Greaser on Spread; Tractors (Track type) without Power Unit pulling Rollers; Rollers on Asphalt -- Brick Macadem; Concrete Breakers; Concrete Spreaders; Mule Pulling Rollers; Center Stripper; Cement Finishing Machines & CMI Texture & Reel Curing Machines; Cement Finishing Machine; Barber Green or similar loaders; Vibro Tamper (All similar types) Self-propelled; Winch or Boom Truck; Mechanical Bull Floats; Mixers over 3 Bag to 27E; Tractor pulling Power Blade or Elevating Grader; Porter Rex Rail; Clary Screed; Truck Type Hoptoe Oilers; Fireman; Spray Machine on Paving; Curb Machines; Truck Crane Oilers; Oil Distributor; Truck-Mounted Saws.

Class 3. Air Compressor; Power Subgrader; Straight Tractor; Trac Air without attachments; Herman Nelson Heater, Dravo, Warner, Silent Glo, and similar types; Roller: Five (5) Ton and under on Earth or Gravel; Form Grader; Crawler Crane & Skid Rig Oilers; Freight Elevators - permanently installed; Pump; Light Plant; Generator; Conveyor (1) or (2) - Operator will clean; Welding Machine; Mixer (3) Bag and Under (Standard Capacity with skip); Bulk Cement Plant; Oiler on Central Concrete Mixing Plant.

#### OPERATING ENGINEERS - HEAVY AND HIGHWAY CONSTRUCTION

Class 1. Cranes; Hydro Crane; Shovels; Crane Type Backfiller; Tower Cranes - Mobile & Crawler & Stationary; Derricks & Hoists (3 Drum); Draglines; Drott Yumbo & similar types considered as Cranes; Back Hoe; Derrick Boats; Pile Driver and Skid Rigs; Clam Shell; Locomotive - Cranes; Road Pavers - Single Drum - Dual Drum - Tri Batcher; Motor Patrols & Power Blades - Dumore - Elevating & Similar Types; Mechanics; Central Concrete Mixing Plant Operator; Asphalt Batch Plant Operators and Plant Engineers; Gradall; Caisson Rigs; Skimmer Scoop - Koering Scooper; Dredges (all types); Hoptoe; All Cherry Pickers; Work Boat; Ross Carrier; Helicopter; Dozer; Tournadozer; Tournapulls - all and similar types; Multiple Unit Earth Movers; Scoops (all sizes); Pushcats; Endloaders (all types); Asphalt Surfacing Machine; Slip Form Paver; Rock Crusher; Heavy Equipment Greaser (top greaser on spread); CMI, Auto Grade, CMI Belt Placer & 3 Track and similar types; Side Booms; Starting Engineer on Pipeline; Asphalt Heater & Planer Combination (used to plane streets); Wheel Tractors (with dozer, hoe or endloader attachments); F.W.D. and Similar types; Blaw

Knox Spreader and Similar types; Trench Machines; Pump Crete - Belt Crete - Squeeze Crete - screw type pumps and gypsum (operator will clean); Formless Finishing Machines; Flaherty Spreader or similar types; Screed Man on Laydown Machine; Vermeer Concrete Saw.

Class 2. Bulker & Pump; Power Launches; Boring Machine & Pipe Jacking Machine; Dinkeys; P-H One Pass Soil Cement Machines and similar types; Wheel Tractors (Industry or farm type - other); Back Fillers; Euclid Loader; Fork Lifts; Jeep w/Ditching Machine or other attachments; Tunneluger; Automatic Cement & Gravel Batching Plants; Mobile Drills - Soil Testing and similar types; Pugmill with pump; All (1) and (2) Drum Hoists; Dewatering System; Straw Blower; Hydro-Seeder; Boring Machine; Hydro-Boom; Bump Grinders (self-propelled); Assistant Heavy Equipment Greaser; Apsco Spreader; Tractors (track-type) without Power Units Pulling Rollers on Asphalt - Brick or Macadam; Concrete Breakers; Concrete Spreaders; Cement Strippers; Cement Finishing Machines & CMI Texture & Reel Curing Machines; Vibro-Tampers (all similar types self-propelled); Mechanical Bull Floats; Self-propelled Concrete Saws; Mixers-over three (3) bags to 27E; Winch and Boom Trucks; Tractor Pulling Power Blade or Elevating Grader; Porter Rex Rail; Clary Screed; Mule Pulling Rollers; Pugmill without Pump; Barber Greene or similar Loaders; Track Type Tractor w/Power Unit attached (minimum); Fireman; Spray Machine on Paving; Curb Machines; Paved Ditch Machine; Power Broom; Self-Propelled Conveyors; Power Subgrader; Oil Distributor; Straight Tractor; Truck Crane Oiler; Truck Type Oilers; Directional boring machine; Horizontal directional drill.

Class 3. Straight framed articulating end dump vehicles and Truck mounted vac unit (separately powered); Trac Air Machine (without attachments); Herman Nelson Heater, Dravo Warner, Silent Glo & similar types; Rollers - five ton and under on earth and gravel; Form Graders; Pumps; Light Plant; Generator; Air Compressor (1) or (2); Conveyor; Welding Machine; Mixer - 3 bags and under; Bulk Cement Plant; Oilers.

Other Classifications of Work:

For definitions of classifications not otherwise set out, the Department generally has on file such definitions which are available. If a task to be performed is not subject to one of the classifications of pay set out, the Department will upon being contacted state which neighboring county has such a classification and provide such rate, such rate being deemed to exist by reference in this document. If no neighboring county rate applies to the task, the Department shall undertake a special determination, such special determination being then deemed to have existed under this determination. If a project requires these, or any classification not listed, please contact IDOL at 618/993-7271 for wage rates or clarifications.

#### LANDSCAPING

Landscaping work falls under the existing classifications for laborer, operating engineer and truck driver. The work performed by landscape plantsman and landscape laborer is covered by the existing classification of laborer. The work performed by landscape operators (regardless of equipment used or its size) is covered by the classifications of operating engineer. The work performed by landscape truck drivers (regardless of size of truck driven) is covered by the classifications of truck driver.

# Mchenry County Prevailing Wage for April 2007

Trade Name	RG	TYP	C	Base	FRMAN	*M-F>8	OSA	OSH	H/W	Pensn	Vac	Trng
=====	==	==	=	=====	=====	=====	==	==	=====	=====	=====	=====
ASBESTOS ABT-GEN		ALL		31.550	32.300	1.5	1.5	2.0	7.460	4.840	0.000	0.170
ASBESTOS ABT-MEC		BLD		23.300	24.800	1.5	1.5	2.0	7.860	4.910	0.000	0.000
BOILERMAKER		BLD		38.540	42.000	2.0	2.0	2.0	6.720	7.440	0.000	0.300
BRICK MASON		BLD		34.850	38.340	1.5	1.5	2.0	7.050	7.870	0.000	0.380
CARPENTER		ALL		35.320	37.320	1.5	1.5	2.0	6.760	5.320	0.000	0.490
CEMENT MASON		ALL		35.300	37.300	2.0	1.5	2.0	6.400	8.910	0.000	0.100
CERAMIC TILE FNSHER		BLD		28.520	0.000	2.0	1.5	2.0	5.650	5.750	0.000	0.330
COMMUNICATION TECH		BLD		29.960	31.760	1.5	1.5	2.0	5.842	6.290	0.000	0.375
ELECTRIC PWR EQMT OP		ALL		27.920	35.880	1.5	1.5	2.0	4.750	7.820	0.000	0.210
ELECTRIC PWR GRNDMAN		ALL		21.640	35.880	1.5	1.5	2.0	4.750	6.060	0.000	0.160
ELECTRIC PWR LINEMAN		ALL		33.220	35.880	1.5	1.5	2.0	4.750	9.310	0.000	0.250
ELECTRIC PWR TRK DRV		ALL		22.340	35.880	1.5	1.5	2.0	4.750	6.260	0.000	0.170
ELECTRICIAN		ALL		38.910	42.800	1.5	1.5	2.0	9.140	8.940	0.000	0.480
ELEVATOR CONSTRUCTOR		BLD		42.045	47.300	2.0	2.0	2.0	8.275	6.060	2.520	0.550
FENCE ERECTOR	E	ALL		27.140	28.640	1.5	1.5	2.0	7.500	7.590	0.000	0.250
FENCE ERECTOR	S	ALL		34.100	35.810	2.0	2.0	2.0	7.690	13.11	0.000	0.230
GLAZIER		BLD		31.400	32.400	1.5	2.0	2.0	6.490	9.050	0.000	0.500
HT/FROST INSULATOR		BLD		33.300	35.050	1.5	1.5	2.0	7.860	8.610	0.000	0.310
IRON WORKER	E	ALL		38.250	40.250	2.0	2.0	2.0	9.470	11.27	0.000	0.300
IRON WORKER	S	ALL		34.100	35.810	2.0	2.0	2.0	7.690	13.11	0.000	0.230
IRON WORKER	W	ALL		30.760	32.300	2.0	2.0	2.0	6.950	16.62	0.000	0.550
LABORER		ALL		31.550	32.300	1.5	1.5	2.0	7.200	5.100	0.000	0.170
LATHER		BLD		35.320	37.320	1.5	1.5	2.0	6.760	5.320	0.000	0.490
MACHINIST		BLD		36.890	38.890	2.0	2.0	2.0	4.380	5.650	2.550	0.000
MARBLE FINISHERS		ALL		25.750	0.000	1.5	1.5	2.0	6.070	7.020	0.000	0.580
MARBLE MASON		BLD		34.850	38.340	1.5	1.5	2.0	7.050	7.870	0.000	0.490
MATERIAL TESTER 1		ALL		21.550	0.000	1.5	1.5	2.0	7.460	4.840	0.000	0.170
MATERIALS TESTER II		ALL		26.550	0.000	1.5	1.5	2.0	7.460	4.840	0.000	0.170
MILLWRIGHT		ALL		35.320	37.320	1.5	1.5	2.0	6.760	5.320	0.000	0.490
OPERATING ENGINEER		BLD	1	41.550	45.550	2.0	2.0	2.0	6.850	5.600	1.900	0.700
OPERATING ENGINEER		BLD	2	40.250	45.550	2.0	2.0	2.0	6.850	5.600	1.900	0.700
OPERATING ENGINEER		BLD	3	37.700	45.550	2.0	2.0	2.0	6.850	5.600	1.900	0.700
OPERATING ENGINEER		BLD	4	35.950	45.550	2.0	2.0	2.0	6.850	5.600	1.900	0.700
OPERATING ENGINEER		HWY	1	39.750	43.750	1.5	1.5	2.0	6.850	5.600	1.900	0.700
OPERATING ENGINEER		HWY	2	39.200	43.750	1.5	1.5	2.0	6.850	5.600	1.900	0.700
OPERATING ENGINEER		HWY	3	37.150	43.750	1.5	1.5	2.0	6.850	5.600	1.900	0.700
OPERATING ENGINEER		HWY	4	35.750	43.750	1.5	1.5	2.0	6.850	5.600	1.900	0.700
OPERATING ENGINEER		HWY	5	34.550	43.750	1.5	1.5	2.0	6.850	5.600	1.900	0.700
ORNAMNTL IRON WORKER	E	ALL		35.600	37.600	2.0	2.0	2.0	7.500	10.84	0.000	0.750
ORNAMNTL IRON WORKER	S	ALL		34.100	35.810	2.0	2.0	2.0	7.690	13.11	0.000	0.230
PAINTER		ALL		34.380	35.380	1.5	1.5	1.5	5.650	5.750	0.000	0.350
PAINTER SIGNS		BLD		28.970	32.520	1.5	1.5	1.5	2.600	2.310	0.000	0.000
PILEDRIVER		ALL		35.320	37.320	1.5	1.5	2.0	6.760	5.320	0.000	0.490
PIPEFITTER		BLD		37.600	39.600	1.5	1.5	2.0	8.660	6.900	0.000	0.940
PLASTERER		BLD		33.850	35.350	1.5	1.5	2.0	6.740	7.100	0.000	0.400
PLUMBER		BLD		37.500	39.500	1.5	1.5	2.0	8.040	6.850	0.000	0.400
ROOFER		BLD		33.650	35.650	1.5	1.5	2.0	6.460	3.310	0.000	0.330
SHEETMETAL WORKER		BLD		36.510	38.510	1.5	1.5	2.0	6.890	8.020	0.000	0.640
SIGN HANGER		BLD		26.070	27.570	1.5	1.5	2.0	3.800	3.550	0.000	0.000
SPRINKLER FITTER		BLD		38.500	40.500	1.5	1.5	2.0	8.250	6.100	0.000	0.500
STEEL ERECTOR	E	ALL		36.250	37.750	2.0	2.0	2.0	8.970	10.77	0.000	0.300
STEEL ERECTOR	S	ALL		34.100	35.810	2.0	2.0	2.0	7.690	13.11	0.000	0.230
STONE MASON		BLD		33.250	36.580	1.5	1.5	2.0	6.450	7.020	0.000	0.440
TERRAZZO FINISHER		BLD		29.290	0.000	1.5	1.5	2.0	5.650	6.940	0.000	0.270
TERRAZZO MASON		BLD		33.650	36.650	1.5	1.5	2.0	5.650	8.610	0.000	0.300
TILE MASON		BLD		34.600	38.600	2.0	1.5	2.0	5.650	7.000	0.000	0.460
TRAFFIC SAFETY WRKR		HWY		22.800	24.400	1.5	1.5	2.0	3.078	1.875	0.000	0.000
TRUCK DRIVER		ALL	1	29.400	29.950	1.5	1.5	2.0	5.200	5.000	0.000	0.000



TRUCK DRIVER	ALL	2	29.550	29.950	1.5	1.5	2.0	5.200	5.000	0.000	0.000
TRUCK DRIVER	ALL	3	29.750	29.950	1.5	1.5	2.0	5.200	5.000	0.000	0.000
TRUCK DRIVER	ALL	4	29.950	29.950	1.5	1.5	2.0	5.200	5.000	0.000	0.000
TUCKPINTER	BLD		34.500	35.500	1.5	1.5	2.0	4.710	6.340	0.000	0.400

Legend :

M-F>8 (Overtime is required for any hour greater than 8 worked each day, Monday through Friday.)

OSA (Overtime is required for every hour worked on Saturday)

OSH (Overtime is required for every hour worked on Sunday and Holidays)

H/W (Health & Welfare Insurance)

Pensn (Pension)

Vac (Vacation)

Trng (Training)

## Explanations

### MCHENRY COUNTY

FENCE ERECTOR (EAST) - That part of the county East and Northeast of a line following Route 31 North to Route 14, northwest to Route 47 north to the Wisconsin State Line.

IRONWORKERS (EAST) - That part of the county East of Rts. 47 and 14.

IRONWORKERS (SOUTH) - That part of the county South of Route 14 and East of Route 47.

IRONWORKERS (WEST) - That part of the county West of Route 47.

The following list is considered as those days for which holiday rates of wages for work performed apply: New Years Day, Memorial/Decoration Day, Fourth of July, Labor Day, Veterans Day, Thanksgiving Day, Christmas Day. Generally, any of these holidays which fall on a Sunday is celebrated on the following Monday. This then makes work performed on that Monday payable at the appropriate overtime rate for holiday pay. Common practice in a given local may alter certain days of celebration such as the day after Thanksgiving for Veterans Day. If in doubt, please check with IDOL.

### EXPLANATION OF CLASSES

ASBESTOS - GENERAL - removal of asbestos material/mold and hazardous materials from any place in a building, including mechanical systems where those mechanical systems are to be removed. This includes the removal of asbestos materials/mold and hazardous materials from ductwork or pipes in a building when the building is to be demolished at the time or at some close future date.

ASBESTOS - MECHANICAL - removal of asbestos material from mechanical systems, such as pipes, ducts, and boilers, where the mechanical systems are to remain.

#### CERAMIC TILE FINISHER

The grouting, cleaning, and polishing of all classes of tile, whether for interior or exterior purposes, all burned, glazed or unglazed products; all composition materials, granite tiles, warning detectable tiles, cement tiles, epoxy composite materials, pavers, glass, mosaics, fiberglass, and all substitute materials, for tile made in tile-like units; all mixtures in tile like form of cement, metals, and other materials that are for and intended for use as a finished floor surface, stair treads, promenade roofs, walks, walls, ceilings, swimming pools, and all other places where tile is to form a finished interior or exterior. The mixing of all setting mortars including but not limited to thin-set mortars, epoxies, wall mud, and any other sand and cement mixtures or adhesives when used in the preparation, installation, repair, or maintenance of tile and/or similar materials. The handling and unloading of all sand, cement, lime, tile, fixtures, equipment, adhesives, or any other materials to be used in the preparation, installation, repair, or maintenance of tile and/or similar materials. Ceramic Tile Finishers shall fill all joints and voids regardless of method on all tile work, particularly and especially after installation of said tile work. Application of any and all protective coverings to all types of tile installations including, but not be limited to, all soap compounds, paper products, tapes, and all polyethylene coverings, plywood, masonite, cardboard, and any new type of products that may be used to protect tile installations, Blastrac equipment, and all floor scarifying equipment used in preparing floors to receive tile. The clean up and removal of all waste and materials. All demolition of existing tile floors and walls to be re-tiled.

#### COMMUNICATIONS TECHNICIAN

Construction, installation, maintenance and removal of telecommunication facilities (voice, sound, data and video), telephone, security systems, fire alarm systems that are a component of a multiplex system and share a common cable, and data inside wire, interconnect, terminal equipment, central offices, PABX and equipment, micro waves, V-SAT, bypass, CATV, WAN (wide area network), LAN (local area networks), and ISDN (integrated system digital network), pulling of wire in raceways, but not the installation of raceways.

#### MARBLE FINISHER

Loading and unloading trucks, distribution of all materials (all stone, sand, etc.), stocking of floors with material, performing all rigging for heavy work, the handling of all material that may be needed for the installation of such materials, building of scaffolding, polishing if needed, patching, waxing of material if damaged, pointing up, caulking, grouting and cleaning of marble, holding water on diamond or Carborundum blade or saw for setters cutting, use of tub saw or any other saw needed for preparation of material, drilling of holes for wires that anchor material set by setters, mixing up of molding plaster for installation of material, mixing up thin set for the installation of material, mixing up of sand to cement for the installation of material and such other work as may be required in helping a Marble Setter in the handling of all material in the erection or installation of interior marble, slate, travertine, art marble, serpentine, alberene stone, blue stone, granite and other stones (meaning as to stone any foreign or domestic materials as are specified and used in building interiors and exteriors and customarily known as stone in the trade), carrara,

sanionyx, vitrolite and similar opaque glass and the laying of all marble tile, terrazzo tile, slate tile and precast tile, steps, risers treads, base, or any other materials that may be used as substitutes for any of the aforementioned materials and which are used on interior and exterior which are installed in a similar manner.

MATERIAL TESTER I: Hand coring and drilling for testing of materials; field inspection of uncured concrete and asphalt.

MATERIAL TESTER II: Field inspection of welds, structural steel, fireproofing, masonry, soil, facade, reinforcing steel, formwork, cured concrete, and concrete and asphalt batch plants; adjusting proportions of bituminous mixtures.

TRAFFIC SAFETY - work associated with barricades, horses and drums used to reduce lane usage on highway work, the installation and removal of temporary lane markings, and the installation and removal of temporary road signs.

#### TRUCK DRIVER - BUILDING, HEAVY AND HIGHWAY CONSTRUCTION

Class 1. Two or three Axle Trucks. A-frame Truck when used for transportation purposes; Air Compressors and Welding Machines, including those pulled by cars, pick-up trucks and tractors; Ambulances; Batch Gate Lockers; Batch Hopperman; Car and Truck Washers; Carry-alls; Fork Lifts and Hoisters; Helpers; Mechanics Helpers and Greasers; Oil Distributors 2-man operation; Pavement Breakers; Pole Trailer, up to 40 feet; Power Mower Tractors; Self-propelled Chip Spreader; Skipman; Slurry Trucks, 2-man operation; Slurry Truck Conveyor Operation, 2 or 3 man; Teamsters; Unskilled dumpman; and Truck Drivers hauling warning lights, barricades, and portable toilets on the job site.

Class 2. Four axle trucks; Dump Crets and Adgetors under 7 yards; Dumpsters, Track Trucks, Euclids, Hug Bottom Dump Turnapulls or Turnatrailers when pulling other than self-loading equipment or similar equipment under 16 cubic yards; Mixer Trucks under 7 yards; Ready-mix Plant Hopper Operator, and Winch Trucks, 2 Axles.

Class 3. Five axle trucks; Dump Crets and Adgetors 7 yards and over; Dumpsters, Track Trucks, Euclids, Hug Bottom Dump Turnatrailers or turnapulls when pulling other than self-loading equipment or similar equipment over 16 cubic yards; Explosives and/or Fission Material Trucks; Mixer Trucks 7 yards or over; Mobile Cranes while in transit; Oil Distributors, 1-man operation; Pole Trailer, over 40 feet; Pole and Expandable Trailers hauling material over 50 feet long; Slurry trucks, 1-man operation; Winch trucks, 3 axles or more; Mechanic--Truck Welder and Truck Painter.

Class 4. Six axle trucks; Dual-purpose vehicles, such as mounted crane trucks with hoist and accessories; Foreman; Master Mechanic; Self-loading equipment like P.B. and trucks with scoops on the front.

#### OPERATING ENGINEERS - BUILDING

Class 1. Mechanic; Asphalt Plant; Asphalt Spreader; Autograde; Backhoes with Caisson attachment; Batch Plant; Benoto; Boiler and Throttle Valve; Caisson Rigs; Central Redi-Mix Plant; Combination Back Hoe Front End-loader Machine; Compressor and Throttle Valve; Concrete Breaker (Truck Mounted); Concrete Conveyor; Concrete Paver; Concrete Placer; Concrete Placing Boom; Concrete Pump (Truck Mounted); Concrete Tower; Cranes, All; Cranes, Hammerhead; Cranes, (GCI and similar Type); Creter Crane; Crusher, Stone, etc.; Derricks, All; Derricks, Traveling; Formless Curb and Gutter Machine; Grader,

Elevating; Grouting Machines; Highlift Shovels or Front Endloader 2-1/4 yd. and over; Hoists, Elevators, outside type rack and pinion and similar machines; Hoists, one, two and three Drum; Hoists, Two Tugger One Floor; Hydraulic Backhoes; Hydraulic Boom Trucks; Hydro Vac (and similar equipment); Locomotives, All; Motor Patrol; Pile Drivers and Skid Rig; Post Hole Digger; Pre-Stress Machine; Pump Cretes Dual Ram; Pump Cretes; Squeeze Cretes-screw Type Pumps; Raised and Blind Hole Drill; Roto Mill Grinder; Scoops - Tractor Drawn; Slip-form Paver; Straddle Buggies; Tournapull; Tractor with Boom and Side Boom; Trenching Machines.

Class 2. Boilers; Broom, All Power Propelled; Bulldozers; Concrete Mixer (Two Bag and Over); Conveyor, Portable; Forklift Trucks; Greaser Engineer; Highlift Shovels or Front Endloaders under 2-1/4 yd.; Hoists, Automatic; Hoists, inside Freight Elevators; Hoists, Sewer Dragging Machine; Hoists, Tugger Single Drum; Laser Screed; Rock Drill (self-propelled); Rock Drill (truck mounted); Rollers, All; Steam Generators; Tractors, All; Tractor Drawn Vibratory Roller; Winch Trucks with "A" Frame.

Class 3. Air Compressor; Combination - Small Equipment Operator; Generators; Heaters, Mechanical; Hoists, Inside Elevators - (Rheostat Manual Controlled); Hydraulic Power Units (Pile Driving, Extracting, and Drilling); Pumps, over 3" (1 to 3 not to exceed a total of 300 ft.); Pumps, Well Points; Welding Machines (2 through 5); Winches, 4 small Electric Drill Winches; Bobcat (up to and including 3/4 cu. yd.).

Class 4. Bobcats and/or other Skid Steer Loaders; Oilers; and Brick Forklift.

#### OPERATING ENGINEERS - HEAVY AND HIGHWAY CONSTRUCTION

Class 1. Craft Foreman; Asphalt Plant; Asphalt Heater and Planer Combination; Asphalt Heater Scarfire; Asphalt Spreader; Autograder/GOMACO or other similar type machines; ABG Paver; Backhoes with Caisson attachment; Ballast Regulator; Belt Loader; Caisson Rigs; Car Dumper; Central Redi-Mix Plant; Combination Backhoe Front Endloader Machine, (1 cu. yd. Backhoe Bucket or over or with attachments); Concrete Breaker (Truck Mounted); Concrete Conveyor; Concrete Paver over 27E cu. ft.; Concrete Placer; Concrete Tube Float; Cranes, all attachments; Cranes, Hammerhead, Linden, Peco & Machines of a like nature; Crete Crane; Crusher, Stone, etc.; Derricks, All; Derrick Boats; Derricks, Traveling; Dowell machine with Air Compressor; Dredges; Field Mechanic-Welder; Formless Curb and Gutter Machine; Gradall and Machines of a like nature; Grader, Elevating; Grader, Motor Grader, Motor Patrol, Auto Patrol, Form Grader, Pull Grader, Subgrader; Guard Rail Post Driver Mounted; Hoists, One, Two and Three Drum; Hydraulic Backhoes; Backhoes with shear attachments; Mucking Machine; Pile Drivers and Skid Rig; Pre-Stress Machine; Pump Cretes Dual Ram; Rock Drill - Crawler or Skid Rig; Rock Drill - Truck Mounted; Roto Mill Grinder; Slip-Form Paver; Soil Test Drill Rig (Truck Mounted); Straddle Buggies; Hydraulic Telescoping Form (Tunnel); Tractor Drawn Belt Loader (with attached pusher - two engineers); Tractor with Boom; Tractaire with Attachments; Trenching Machine; Truck Mounted Concrete Pump with Boom; Raised or Blind Hole; Drills (Tunnel Shaft); Underground Boring and/or Mining Machines; Wheel Excavator; Widener (APSCO).

Class 2. Batch Plant; Bituminous Mixer; Boiler and Throttle Valve; Bulldozers; Car Loader Trailing Conveyors; Combination Backhoe Front Endloader Machine (less than 1 cu. yd. Backhoe Bucket or over or with attachments); Compressor and Throttle Valve; Compressor, Common

Receiver (3); Concrete Breaker or Hydro Hammer; Concrete Grinding Machine; Concrete Mixer or Paver 7S Series to and including 27 cu. ft.; Concrete Spreader; Concrete Curing Machine, Burlap Machine, Belting Machine and Sealing Machine; Concrete Wheel Saw; Conveyor Muck Cars (Haglund or Similar Type); Drills, All; Finishing Machine - Concrete; Greaser Engineer; Highlift Shovels or Front Endloader; Hoist - Sewer Dragging Machine; Hydraulic Boom Trucks (All Attachments); Hydro-Blaster; All Locomotives, Dinky; Pump Cretes; Squeeze Cretes-Screw Type Pumps, Gypsum Bulker and Pump; Roller, Asphalt; Rotary Snow Plows; Rototiller, Seaman, etc., self-propelled; Scoops - Tractor Drawn; Self-Propelled Compactor; Spreader - Chip - Stone, etc.; Scraper; Scraper - Prime Mover in Tandem (Regardless of Size); Tank Car Heater; Tractors, Push, Pulling Sheeps Foot, Disc, Compactor, etc.; Tug Boats.

Class 3. Boilers; Brooms, All Power Propelled; Cement Supply Tender; Compressor, Common Receiver (2); Concrete Mixer (Two Bag and Over); Conveyor, Portable; Farm-Type Tractors Used for Mowing, Seeding, etc.; Fireman on Boilers; Forklift Trucks; Grouting Machine; Hoists, Automatic; Hoists, All Elevators; Hoists, Tugger Single Drum; Jeep Diggers; Pipe Jacking Machines; Post-Hole Digger; Power Saw, Concrete Power Driven; Pug Mills; Rollers, other than asphalt; Seed and Straw Blower; Steam Generators; Stump Machine; Winch Trucks with "A" Frame; Work Boats; Tamper - Form-Motor Driven.

Class 4. Air Compressor; Combination - Small Equipment Operator; Directional Boring Machine; Generators; Heaters, Mechanical; Hydraulic Power Unit (Pile Driving, Extracting, or Drilling); Hydro-Blaster; Light Plants, All (1 through 5); Pumps, over 3" (1 to 3 not to exceed a total of 300 ft.); Pumps, Well Points; Tractaire; Welding Machines (2 through 5); Winches, 4 Small Electric Drill Winches.

Class 5. Bobcats (all); Brick Forklifts; Oilers.

#### TERRAZZO FINISHER

The handling of sand, cement, marble chips, and all other materials that may be used by the Mosaic Terrazzo Mechanic, and the mixing, grinding, grouting, cleaning and sealing of all Marble, Mosaic, and Terrazzo work, floors, base, stairs, and wainscoting by hand or machine, and in addition, assisting and aiding Marble, Masonic, and Terrazzo Mechanics.

#### Other Classifications of Work:

For definitions of classifications not otherwise set out, the Department generally has on file such definitions which are available. If a task to be performed is not subject to one of the classifications of pay set out, the Department will upon being contacted state which neighboring county has such a classification and provide such rate, such rate being deemed to exist by reference in this document. If no neighboring county rate applies to the task, the Department shall undertake a special determination, such special determination being then deemed to have existed under this determination. If a project requires these, or any classification not listed, please contact IDOL at 618/993-7271 for wage rates or clarifications.

#### LANDSCAPING

Landscaping work falls under the existing classifications for laborer, operating engineer and truck driver. The work performed by landscape plantsman and landscape laborer is covered by the existing

classification of laborer. The work performed by landscape operators (regardless of equipment used or its size) is covered by the classifications of operating engineer. The work performed by landscape truck drivers (regardless of size of truck driven) is covered by the classifications of truck driver.

# McLean County Prevailing Wage for April 2007

Trade Name	RG	TYP	C	Base	FRMAN	*M-F>8	OSA	OSH	H/W	Pensn	Vac	Trng
=====	==	==	=	=====	=====	=====	==	==	=====	=====	=====	=====
ASBESTOS ABT-GEN		BLD		25.110	25.860	1.5	1.5	2.0	5.850	5.230	0.000	0.600
ASBESTOS ABT-GEN		HWY		25.850	26.400	1.5	1.5	2.0	5.850	5.270	0.000	0.700
ASBESTOS ABT-MEC		BLD		23.300	24.800	1.5	1.5	2.0	7.860	4.910	0.000	0.000
BOILERMAKER		BLD		30.970	33.970	2.0	2.0	2.0	8.270	7.740	0.000	0.300
BRICK MASON		BLD		26.510	28.010	1.5	1.5	2.0	5.500	6.750	0.000	0.380
CARPENTER		BLD		26.850	28.850	1.5	1.5	2.0	6.500	6.250	0.000	0.320
CARPENTER		HWY		27.960	29.960	1.5	1.5	2.0	6.500	6.500	0.000	0.320
CEMENT MASON		ALL		24.690	25.440	1.5	1.5	2.0	5.050	8.350	0.000	0.300
CERAMIC TILE FNSHER		BLD		24.910	0.000	1.5	1.5	2.0	5.500	6.350	0.000	0.380
ELECTRIC PWR EQMT OP		ALL		30.750	0.000	1.5	1.5	2.0	4.750	8.610	0.000	0.000
ELECTRIC PWR GRNDMAN		ALL		21.090	0.000	1.5	1.5	2.0	4.750	5.905	0.000	0.000
ELECTRIC PWR LINEMAN		ALL		34.160	36.350	1.5	1.5	2.0	4.750	9.560	0.000	0.000
ELECTRIC PWR TRK DRV		ALL		22.130	0.000	1.5	1.5	2.0	4.750	6.200	0.000	0.000
ELECTRICIAN		BLD		31.400	34.540	1.5	1.5	2.0	5.150	6.190	0.000	0.470
ELECTRONIC SYS TECH		BLD		24.290	25.790	1.5	1.5	2.0	5.150	3.730	0.000	0.250
ELEVATOR CONSTRUCTOR		BLD		34.190	38.460	2.0	2.0	2.0	8.275	6.060	2.050	0.000
FENCE ERECTOR	E	ALL		26.420	28.170	1.5	1.5	2.0	6.590	6.150	0.000	0.500
GLAZIER		BLD		26.320	27.070	1.5	1.5	2.0	5.650	5.750	0.000	0.350
HT/FROST INSULATOR		BLD		34.750	36.500	1.5	1.5	2.0	8.260	9.110	0.000	0.310
IRON WORKER	E	ALL		26.420	28.170	1.5	1.5	2.0	6.590	6.150	0.000	0.500
IRON WORKER	W	BLD		24.960	26.710	1.5	1.5	2.0	8.040	7.410	0.000	0.400
IRON WORKER	W	HWY		25.920	27.420	1.5	1.5	2.0	8.040	7.410	0.000	0.350
LABORER		BLD		24.110	24.860	1.5	1.5	2.0	5.850	5.230	0.000	0.600
LABORER		HWY		24.850	25.400	1.5	1.5	2.0	5.850	5.270	0.000	0.700
LABORER, SKILLED		BLD		24.110	24.860	1.5	1.5	2.0	5.850	5.230	0.000	0.600
LABORER, SKILLED		HWY		24.850	25.400	1.5	1.5	2.0	5.850	5.270	0.000	0.600
LATHER		BLD		26.850	28.850	1.5	1.5	2.0	6.500	6.250	0.000	0.320
MACHINERY MOVER	W	HWY		25.920	27.420	1.5	1.5	2.0	8.040	7.410	0.000	0.350
MACHINIST		BLD		36.890	38.890	2.0	2.0	2.0	4.380	5.650	2.550	0.000
MARBLE FINISHERS		BLD		24.910	0.000	1.5	1.5	2.0	5.500	6.350	0.000	0.380
MARBLE MASON		BLD		26.520	27.770	1.5	1.5	2.0	5.500	6.350	0.000	0.380
MILLWRIGHT		BLD		26.680	28.680	1.5	1.5	2.0	6.500	6.850	0.000	0.320
MILLWRIGHT		HWY		27.460	29.460	1.5	1.5	2.0	6.500	6.450	0.000	0.320
OPERATING ENGINEER		BLD	1	27.840	30.840	1.5	1.5	2.0	5.900	8.000	0.000	0.900
OPERATING ENGINEER		BLD	2	25.940	30.840	1.5	1.5	2.0	5.900	8.000	0.000	0.900
OPERATING ENGINEER		BLD	3	24.560	30.840	1.5	1.5	2.0	5.900	8.000	0.000	0.900
OPERATING ENGINEER		HWY	1	29.110	32.110	1.5	1.5	2.0	6.250	9.000	0.000	1.000
OPERATING ENGINEER		HWY	2	26.730	32.110	1.5	1.5	2.0	6.250	9.000	0.000	1.000
OPERATING ENGINEER		HWY	3	22.790	32.110	1.5	1.5	2.0	6.250	9.000	0.000	1.000
PAINTER		ALL		26.850	27.850	1.5	1.5	1.5	5.650	5.750	0.000	0.350
PAINTER SIGNS		BLD		28.970	32.520	1.5	1.5	1.5	2.600	2.310	0.000	0.000
PILEDRIVER		BLD		27.350	29.350	1.5	1.5	2.0	6.500	6.250	0.000	0.320
PILEDRIVER		HWY		28.960	30.960	1.5	1.5	2.0	6.500	6.500	0.000	0.320
PIPEFITTER		BLD		34.100	36.830	1.5	1.5	2.0	6.450	6.400	0.000	1.150
PLASTERER		BLD		25.920	27.920	1.5	1.5	2.0	4.700	9.300	0.000	0.400
PLUMBER		BLD		34.100	36.830	1.5	1.5	2.0	6.450	6.400	0.000	1.150
ROOFER		BLD		24.200	25.200	1.5	1.5	2.0	5.350	6.550	0.000	0.150
SHEETMETAL WORKER		BLD		27.740	29.130	1.5	1.5	2.0	5.670	9.310	0.000	0.310
SIGN HANGER	W	HWY		25.920	27.420	1.5	1.5	2.0	8.040	7.410	0.000	0.350
SPRINKLER FITTER		BLD		31.240	33.240	1.5	1.5	2.0	6.500	5.350	0.000	0.250
STEEL ERECTOR	W	HWY		25.920	27.420	1.5	1.5	2.0	8.040	7.410	0.000	0.350
TERRAZZO FINISHER		BLD		24.910	0.000	1.5	1.5	2.0	5.500	6.350	0.000	0.380
TERRAZZO MASON		BLD		26.520	27.770	1.5	1.5	2.0	5.500	6.350	0.000	0.380
TILE MASON		BLD		26.520	27.770	1.5	1.5	2.0	5.500	6.350	0.000	0.380
TRUCK DRIVER		O&C	1	20.630	0.000	1.5	1.5	2.0	7.250	3.317	0.000	0.000
TRUCK DRIVER		O&C	2	20.950	0.000	1.5	1.5	2.0	7.250	3.317	0.000	0.000
TRUCK DRIVER		O&C	3	21.110	0.000	1.5	1.5	2.0	7.250	3.317	0.000	0.000
TRUCK DRIVER		O&C	4	21.310	0.000	1.5	1.5	2.0	7.250	3.317	0.000	0.000

TRUCK DRIVER		O&C	5	21.910	0.000	1.5	1.5	2.0	7.250	3.317	0.000	0.000
TRUCK DRIVER	N	ALL	1	32.040	32.590	1.5	1.5	2.0	5.830	3.680	0.000	0.000
TRUCK DRIVER	N	ALL	2	32.190	32.590	1.5	1.5	2.0	5.830	3.680	0.000	0.000
TRUCK DRIVER	N	ALL	3	32.390	32.590	1.5	1.5	2.0	5.830	3.680	0.000	0.000
TRUCK DRIVER	N	ALL	4	32.590	32.590	1.5	1.5	2.0	5.830	3.680	0.000	0.000
TRUCK DRIVER	S	ALL	1	25.787	0.000	1.5	1.5	2.0	7.250	3.317	0.000	0.000
TRUCK DRIVER	S	ALL	2	26.187	0.000	1.5	1.5	2.0	7.250	3.317	0.000	0.000
TRUCK DRIVER	S	ALL	3	26.387	0.000	1.5	1.5	2.0	7.250	3.317	0.000	0.000
TRUCK DRIVER	S	ALL	4	26.637	0.000	1.5	1.5	2.0	7.250	3.317	0.000	0.000
TRUCK DRIVER	S	ALL	5	27.387	0.000	1.5	1.5	2.0	7.250	3.317	0.000	0.000

Legend:

M-F>8 (Overtime is required for any hour greater than 8 worked each day, Monday through Friday.)

OSA (Overtime is required for every hour worked on Saturday)

OSH (Overtime is required for every hour worked on Sunday and Holidays)

H/W (Health & Welfare Insurance)

Pensn (Pension)

Vac (Vacation)

Trng (Training)

## Explanations

### MCLEAN COUNTY

FENCE ERECTOR - See Ironworkers.

IRONWORKERS (EAST) - That part of the county East of a diagonal line from Heyworth to a point half way between Chenoa and Weston.

TEAMSTERS (NORTH) - North of a straight line starting on the west side where Route 24 crosses McClean County line in a southeasterly direction to the most south-southwestern corner of Livingston County.

The following list is considered as those days for which holiday rates of wages for work performed apply: New Years Day, Memorial/Decoration Day, Fourth of July, Labor Day, Veterans Day, Thanksgiving Day, Christmas Day. Generally, any of these holidays which fall on a Sunday is celebrated on the following Monday. This then makes work performed on that Monday payable at the appropriate overtime rate for holiday pay. Common practice in a given local may alter certain days of celebration such as the day after Thanksgiving for Veterans Day. If in doubt, please check with IDOL.

Oil and chip resealing (O&C) means the application of road oils and liquid asphalt to coat an existing road surface, followed by application of aggregate chips or gravel to coated surface, and subsequent rolling of material to seal the surface.

### EXPLANATION OF CLASSES

ASBESTOS - GENERAL - removal of asbestos material/mold and hazardous materials from any place in a building, including mechanical systems



where those mechanical systems are to be removed. This includes the removal of asbestos materials/mold and hazardous materials from ductwork or pipes in a building when the building is to be demolished at the time or at some close future date.

ASBESTOS - MECHANICAL - removal of asbestos material from mechanical systems, such as pipes, ducts, and boilers, where the mechanical systems are to remain.

#### CERAMIC TILE FINISHER, MARBLE FINISHER, TERRAZZO FINISHER

Assisting, helping or supporting the tile, marble and terrazzo mechanic by performing their historic and traditional work assignments required to complete the proper installation of the work covered by said crafts. The term "Ceramic" is used for naming the classification only and is in no way a limitation of the product handled. Ceramic takes into consideration most hard tiles.

#### ELECTRONIC SYSTEMS TECHNICIAN

Installation, service and maintenance of low-voltage systems which utilizes the transmission and/or transference of voice, sound, vision, or digital for commercial, education, security and entertainment purposes for the following: TV monitoring and surveillance, background/foreground music, intercom and telephone interconnect, field programming, inventory control systems, microwave transmission, multi-media, multiplex, radio page, school, intercom and sound burglar alarms and low voltage master clock systems.

Excluded from this classification are energy management systems, life safety systems, supervisory controls and data acquisition systems not intrinsic with the above listed systems, fire alarm systems, nurse call systems and raceways exceeding fifteen feet in length.

#### LABORER, SKILLED - BUILDING

The skilled laborer building (BLD) classification shall encompass the following types of work, irrespective of the site of the work: tending of carpenters in unloading, handling, stockpiling and distribution operations, also other building crafts, mixing, handling, and conveying of all materials used by masons, plasterers and other building construction crafts, whether done by hand or by any process. The drying of plastering when done by salamander heat, and the cleaning and clearing of all debris. All work pertaining to and in preparation of asbestos abatement and removal. The building of scaffolding and staging for masons and plasterers. The excavations for buildings and all other construction, digging, of trenches, piers, foundations and holes, digging, lagging, sheeting, cribbing, bracing and propping of foundations, holes, caissons, cofferdams, and dikes, the setting of all guidelines for machine or hand excavation and subgrading. The mixing, handling, conveying, pouring, vibrating, gunniting and otherwise applying of concrete, whether by hand or other method of concrete for any walls, foundations, floors, or for other construction concrete sealant men. The wrecking, stripping, dismantling, and handling of concrete forms and false work, and the building of centers for fireproofing purposes. Boring machine, gas, electric or air in preparation for shoving pipe, telephone cable, and so forth, under highways, roads, streets and alleys. All hand and power operating cross cut saws when used for clearing. All work in compressed air construction. All work on acetylene burners in salvaging. The blocking and tamping of concrete. The laying of sewer tile and conduit, and pre-cast materials. The assembling and dismantling of all jacks and sectional scaffolding, including elevator construction and running of slip form jacks. The work of drill

running and blasting, including wagon drills. The wrecking, stripping, dismantling, cleaning, moving and oiling of forms. The cutting off of concrete piles. The loading, unloading, handling and carrying to place of installation of all rods, (and materials for use in reinforcing) concrete and the hoisting of same and all signaling where hoist is used in this type of construction coming under the jurisdiction of the Laborers' Union. And, all other labor work not awarded to any other craft. Mortar mixers, kettlemen and carrier of hot stuff, tool crib men, watchmen (Laborer), firemen or salamander tenders, flagmen, deck hands, installation and maintenance of temporary gas-fired heating units, gravel box men, dumpmen and spotters, fencing Laborers, cleaning lumber, pit men, material checkers, dispatchers, unloading explosives, asphalt plant laborers, writer of scale tickets, fireproofing laborers, janitors, asbestos abatement and removal laborers, handling of materials treated with oil, creosote, chloride, asphalt, and/or foreign material harmful to skin or clothing, Laborers with de-watering systems, gunnite nozzle men, laborers tending masons with hot material or where foreign materials are used, Laborers handling masterplate or similar materials, laser beam operator, concrete burning machine operator, material selector men working with firebrick or combustible material, dynamite men, track laborers, cement handlers, chloride handlers, the unloading and laborers with steel workers and re-bars, concrete workers (wet), luteman, asphalt raker, curb asphalt machine operator, ready mix scalemen, permanent, portable or temporary plant drilling machine operator, plaster tenders, underpinning and shoring of buildings, fire watch, signaling of all power equipment, to include trucks excavating equipment, etc., tree topper or trimmer when in connection to construction, tunnel helpers in free air, batch dumpers, kettle and tar men, tank cleaners, plastic installers, scaffold workers, motorized buggies or motorized unit used for wet concrete or handling of building materials, sewer workers, rod and chain men, vibrator operators, mortar mixer operator, cement silica, clay, fly ash, lime and plasters, handlers (bulk or bag), cofferdam workers, on concrete paving, placing, cutting and tying of reinforcing, deck hand, dredge hand and shore laborers, bankmen on floating plant, asphalt workers with machine & layers, grade checker, power tools, caisson workers, lead man on sewer work, welders, cutters, burners and torch men, chain saw operators, paving breaker, jackhammer and drill operator, layout man and/or drainage tile layer, steel form setters -- street and highway, air tamping hammerman, signal man on crane, concrete saw operator, screen man on asphalt pavers, front end man on chip spreader, multiple concrete duct -- lead man.

#### LABORER, SKILLED - HIGHWAY

The skilled laborer heavy and highway (HWY) classification shall encompass the following types of work, irrespective of the site of the work: handling of materials treated with oil, creosote, asphalt and/or any foreign materials harmful to skin or clothing, track laborers, chloride handlers, the unloading and loading with steel workers and re-bars, concrete workers (wet), tunnel helpers in free air, batch dumpers, mason tenders, kettle and tar men, plastic installers, scaffold workers, motorized buggies or motorized unit used for wet concrete or handling of building materials, laborers with de-watering systems, sewer workers plus depth, rod and chainmen, vibrator operators, mortar mixer operators, cement silica, clay, fly ash, lime and plasters, handlers (bulk or bag), cofferdam workers plus depth, on concrete paving, placing, cutting and tying or reinforcing, deck hand, dredge hand shore laborers, bankmen on floating plant, asphalt workers with machine, and layers, grade checker, power tools, stripping of all concrete forms excluding paving forms, dumpmen and spotters, when necessary, caisson workers plus depth, gunnite nozzle

men, welders, cutters, burners and torchmen, chain saw operators, paving breaker, jackhammer and drill operators, layout man and/or drainage tile layer, steel form setters - street and highway, air tamping hammerman, signal man on crane, concrete saw operator, screedman on asphalt pavers, front end man on chip spreader, multiple concrete duct, luteman, asphalt raker, curb asphalt machine operator, ready mix scalemen (portable or temporary plant), laser beam operator, concrete burning machine operator, and coring machine operator.

#### TRUCK DRIVER - BUILDING, HEAVY AND HIGHWAY CONSTRUCTION - SOUTH

Class 1. Drivers on 2 axle trucks hauling less than 9 ton. Air compressor and welding machines and brooms, including those pulled by separate units, truck driver helpers, warehouse employees, mechanic helpers, greasers and tiremen, pickup trucks when hauling materials, tools, or workers to and from and on-the-job site, and fork lifts up to 6,000 lb. capacity.

Class 2. Two or three axle trucks hauling more than 9 ton but hauling less than 16 ton. A-frame winch trucks, hydrolift trucks, vector trucks or similar equipment when used for transportation purposes. Fork lifts over 6,000 lb. capacity, winch trucks, four axle combination units, and ticket writers.

Class 3. Two, three or four axle trucks hauling 16 ton or more. Drivers on water pulls, articulated dump trucks, mechanics and working forepersons, and dispatchers. Five axle or more combination units.

Class 4. Low Boy and Oil Distributors.

Class 5. Drivers who require special protective clothing while employed on hazardous waste work.

#### TRUCK DRIVER - BUILDING, HEAVY AND HIGHWAY CONSTRUCTION - NORTH

Class 1. Two or three Axle Trucks. A-frame Truck when used for transportation purposes; Air Compressors and Welding Machines, including those pulled by cars, pick-up trucks and tractors; Ambulances; Batch Gate Lockers; Batch Hopperman; Car and Truck Washers; Carry-alls; Fork Lifts and Hoisters; Helpers; Mechanics Helpers and Greasers; Oil Distributors 2-man operation; Pavement Breakers; Pole Trailer, up to 40 feet; Power Mower Tractors; Self-propelled Chip Spreader; Skipman; Slurry Trucks, 2-man operation; Slurry Truck Conveyor Operation, 2 or 3 man; Teamsters; Unskilled dumpman; and Truck Drivers hauling warning lights, barricades, and portable toilets on the job site.

Class 2. Four axle trucks; Dump Crets and Adgetors under 7 yards; Dumpsters, Track Trucks, Euclids, Hug Bottom Dump Turnapulls or Turnatrailers when pulling other than self-loading equipment or similar equipment under 16 cubic yards; Mixer Trucks under 7 yards; Ready-mix Plant Hopper Operator, and Winch Trucks, 2 Axles.

Class 3. Five axle trucks; Dump Crets and Adgetors 7 yards and over; Dumpsters, Track Trucks, Euclids, Hug Bottom Dump Turnatrailers or turnapulls when pulling other than self-loading equipment or similar equipment over 16 cubic yards; Explosives and/or Fission Material Trucks; Mixer Trucks 7 yards or over; Mobile Cranes while in transit; Oil Distributors, 1-man operation; Pole Trailer, over 40 feet; Pole and Expandable Trailers hauling material over 50 feet long; Slurry trucks, 1-man operation; Winch trucks, 3 axles or more; Mechanic--Truck Welder and Truck Painter.

Class 4. Six axle trucks; Dual-purpose vehicles, such as mounted crane trucks with hoist and accessories; Foreman; Master Mechanic; Self-loading equipment like P.B. and trucks with scoops on the front.

TRUCK DRIVER - OIL AND CHIP RESEALING ONLY.

This shall encompass laborers, workers and mechanics who drive contractor or subcontractor owned, leased, or hired pickup, dump, service, or oil distributor trucks. The work includes transporting materials and equipment (including but not limited to, oils, aggregate supplies, parts, machinery and tools) to or from the job site; distributing oil or liquid asphalt and aggregate; stock piling material when in connection with the actual oil and chip contract. The Truck Driver (Oil & Chip Resealing) wage classification does not include supplier delivered materials.

OPERATING ENGINEERS - BUILDING

Class 1. Cranes; Overhead Cranes; Gradall; All Cherry Pickers; Mechanics; Central Concrete Mixing Plant Operator; Road Pavers (27E - Dual Drum - Tri Batchers); Blacktop Plant Operators and Plant Engineers; 3 Drum Hoist; Derricks; Hydro Cranes; Shovels; Skimmer Scoops; Koehring Scooper; Drag Lines; Backhoe; Derrick Boats; Pile Drivers and Skid Rigs; Clamshells; Locomotive Cranes; Dredge (all types) Motor Patrol; Power Blades - Dumore - Elevating and similar types; Tower Cranes (Crawler-Mobile) and Stationary; Crane-type Backfiller; Drott Yumbo and similar types considered as Cranes; Caisson Rigs; Dozer; Tournadozer; Work Boats; Ross Carrier; Helicopter; Tournapulls - all and similar types; Scoops (all sizes); Pushcats; Endloaders (all types); Asphalt Surfacing Machine; Slip Form Paver; Rock Crusher; Heavy Equipment Greaser; CMI, CMI Belt Placer, Auto Grade & 3 Track and similar types; Side Booms; Multiple Unit Earth Movers; Creter Crane; Trench Machine; Pump-crete-Belt Crete-Squeeze Cretes-Screw-type Pumps and Gypsum; Bulker & Pump - Operator will clean; Formless Finishing Machine; Flaherty Spreader or similar types; Screed Man on Laydown Machine; Wheel Tractors (industrial or Farm-type w/Dozer-Hoe-Endloader or other attachments); F.W.D. & Similar Types; Vermeer Concrete Saw.

Class 2. Dinkeys; Power Launches; PH One-pass Soil Cement Machine (and similar types); Pugmill with Pump; Backfillers; Euclid Loader; Forklifts; Jeeps w/Ditching Machine or other attachments; Tuneluger; Automatic Cement and Gravel Batching Plants; Mobile Drills (Soil Testing) and similar types; Gurries and Similar Types; (1) and (2) Drum Hoists (Buck Hoist and Similar Types); Chicago Boom; Boring Machine & Pipe Jacking Machine; Hydro Boom; Dewatering System; Straw Blower; Hydro Seeder; Assistant Heavy Equipment Greaser on Spread; Tractors (Track type) without Power Unit pulling Rollers; Rollers on Asphalt -- Brick Macadem; Concrete Breakers; Concrete Spreaders; Mule Pulling Rollers; Center Stripper; Cement Finishing Machines & CMI Texture & Reel Curing Machines; Cement Finishing Machine; Barber Green or similar loaders; Vibro Tamper (All similar types) Self-propelled; Winch or Boom Truck; Mechanical Bull Floats; Mixers over 3 Bag to 27E; Tractor pulling Power Blade or Elevating Grader; Porter Rex Rail; Clary Screed; Truck Type Hoptoe Oilers; Fireman; Spray Machine on Paving; Curb Machines; Truck Crane Oilers; Oil Distributor; Truck-Mounted Saws.

Class 3. Air Compressor; Power Subgrader; Straight Tractor; Trac Air without attachments; Herman Nelson Heater, Dravo, Warner, Silent Glo, and similar types; Roller: Five (5) Ton and under on Earth or

Gravel; Form Grader; Crawler Crane & Skid Rig Oilers; Freight Elevators - permanently installed; Pump; Light Plant; Generator; Conveyor (1) or (2) - Operator will clean; Welding Machine; Mixer (3) Bag and Under (Standard Capacity with skip); Bulk Cement Plant; Oiler on Central Concrete Mixing Plant.

#### OPERATING ENGINEERS - HEAVY AND HIGHWAY CONSTRUCTION

Class 1. Cranes; Hydro Crane; Shovels; Crane Type Backfiller; Tower Cranes - Mobile & Crawler & Stationary; Derricks & Hoists (3 Drum); Draglines; Drott Yumbo & similar types considered as Cranes; Back Hoe; Derrick Boats; Pile Driver and Skid Rigs; Clam Shell; Locomotive - Cranes; Road Pavers - Single Drum - Dual Drum - Tri Batcher; Motor Patrols & Power Blades - Dumore - Elevating & Similar Types; Mechanics; Central Concrete Mixing Plant Operator; Asphalt Batch Plant Operators and Plant Engineers; Gradall; Caisson Rigs; Skimmer Scoop - Koering Scooper; Dredges (all types); Hoptoe; All Cherry Pickers; Work Boat; Ross Carrier; Helicopter; Dozer; Tournadozer; Tournapulls - all and similar types; Multiple Unit Earth Movers; Scoops (all sizes); Pushcats; Endloaders (all types); Asphalt Surfacing Machine; Slip Form Paver; Rock Crusher; Heavy Equipment Greaser (top greaser on spread); CMI, Auto Grade, CMI Belt Placer & 3 Track and similar types; Side Booms; Starting Engineer on Pipeline; Asphalt Heater & Planer Combination (used to plane streets); Wheel Tractors (with dozer, hoe or endloader attachments); F.W.D. and Similar types; Blaw Knox Spreader and Similar types; Trench Machines; Pump Crete - Belt Crete - Squeeze Crete - screw type pumps and gypsum (operator will clean); Formless Finishing Machines; Flaherty Spreader or similar types; Screed Man on Laydown Machine; Vermeer Concrete Saw.

Class 2. Bulker & Pump; Power Launches; Boring Machine & Pipe Jacking Machine; Dinkeys; P-H One Pass Soil Cement Machines and similar types; Wheel Tractors (Industry or farm type - other); Back Fillers; Euclid Loader; Fork Lifts; Jeep w/Ditching Machine or other attachments; Tunneluger; Automatic Cement & Gravel Batching Plants; Mobile Drills - Soil Testing and similar types; Pugmill with pump; All (1) and (2) Drum Hoists; Dewatering System; Straw Blower; Hydro-Seeder; Boring Machine; Hydro-Boom; Bump Grinders (self-propelled); Assistant Heavy Equipment Greaser; Apsco Spreader; Tractors (track-type) without Power Units Pulling Rollers on Asphalt - Brick or Macadam; Concrete Breakers; Concrete Spreaders; Cement Strippers; Cement Finishing Machines & CMI Texture & Reel Curing Machines; Vibro-Tampers (all similar types self-propelled); Mechanical Bull Floats; Self-propelled Concrete Saws; Mixers-over three (3) bags to 27E; Winch and Boom Trucks; Tractor Pulling Power Blade or Elevating Grader; Porter Rex Rail; Clary Screed; Mule Pulling Rollers; Pugmill without Pump; Barber Greene or similar Loaders; Track Type Tractor w/Power Unit attached (minimum); Fireman; Spray Machine on Paving; Curb Machines; Paved Ditch Machine; Power Broom; Self-Propelled Conveyors; Power Subgrader; Oil Distributor; Straight Tractor; Truck Crane Oiler; Truck Type Oilers; Directional boring machine; Horizontal directional drill.

Class 3. Straight framed articulating end dump vehicles and Truck mounted vac unit (separately powered); Trac Air Machine (without attachments); Herman Nelson Heater, Dravo Warner, Silent Glo & similar types; Rollers - five ton and under on earth and gravel; Form Graders; Pumps; Light Plant; Generator; Air Compressor (1) or (2); Conveyor; Welding Machine; Mixer - 3 bags and under; Bulk Cement Plant; Oilers.

Other Classifications of Work:

For definitions of classifications not otherwise set out, the Department generally has on file such definitions which are available. If a task to be performed is not subject to one of the classifications of pay set out, the Department will upon being contacted state which neighboring county has such a classification and provide such rate, such rate being deemed to exist by reference in this document. If no neighboring county rate applies to the task, the Department shall undertake a special determination, such special determination being then deemed to have existed under this determination. If a project requires these, or any classification not listed, please contact IDOL at 618/993-7271 for wage rates or clarifications.

#### LANDSCAPING

Landscaping work falls under the existing classifications for laborer, operating engineer and truck driver. The work performed by landscape plantsman and landscape laborer is covered by the existing classification of laborer. The work performed by landscape operators (regardless of equipment used or its size) is covered by the classifications of operating engineer. The work performed by landscape truck drivers (regardless of size of truck driven) is covered by the classifications of truck driver.

# Menard County Prevailing Wage for April 2007

Trade Name	RG	TYP	C	Base	FRMAN	*M-F>8	OSA	OSH	H/W	Pensn	Vac	Trng
=====	==	==	=	=====	=====	=====	==	==	=====	=====	=====	=====
ASBESTOS ABT-GEN		BLD		25.370	26.370	1.5	1.5	2.0	5.050	5.330	0.000	0.700
ASBESTOS ABT-MEC		BLD		25.290	26.290	1.5	1.5	2.0	4.450	2.500	0.000	0.250
BOILERMAKER		BLD		28.500	31.000	1.5	1.5	2.0	6.820	11.03	0.000	0.300
BRICK MASON		BLD		24.650	25.400	2.0	2.0	2.0	6.000	6.700	0.000	0.490
CARPENTER		BLD		25.910	27.910	1.5	1.5	2.0	6.500	6.480	0.000	0.320
CARPENTER		HWY		25.750	27.500	1.5	1.5	2.0	6.500	6.500	0.000	0.300
CEMENT MASON		BLD		22.800	23.800	1.5	1.5	2.0	5.200	8.080	0.000	0.150
CEMENT MASON		HWY		22.170	23.170	1.5	1.5	2.0	5.200	7.300	0.000	0.250
CERAMIC TILE FNSHER		BLD		23.300	0.000	1.5	1.5	2.0	6.000	6.700	0.000	0.000
ELECTRIC PWR EQMT OP		ALL		30.750	0.000	1.5	1.5	2.0	4.750	8.610	0.000	0.000
ELECTRIC PWR GRNDMAN		ALL		21.090	0.000	1.5	1.5	2.0	4.750	5.905	0.000	0.000
ELECTRIC PWR LINEMAN		ALL		34.160	36.350	1.5	1.5	2.0	4.750	9.560	0.000	0.000
ELECTRIC PWR TRK DRV		ALL		22.130	0.000	1.5	1.5	2.0	4.750	6.200	0.000	0.000
ELECTRICIAN		BLD		31.220	33.220	1.5	1.5	2.0	5.150	5.340	0.000	0.300
ELECTRONIC SYS TECH		BLD		24.830	26.330	1.5	1.5	2.0	5.150	3.190	0.000	0.250
ELEVATOR CONSTRUCTOR		BLD		34.190	38.460	2.0	2.0	2.0	8.275	6.060	2.050	0.000
GLAZIER		BLD		27.130	28.130	1.5	2.0	2.0	5.430	4.000	0.000	0.280
HT/FROST INSULATOR		BLD		30.440	31.440	1.5	1.5	2.0	4.850	8.360	0.000	0.450
IRON WORKER		BLD		25.400	27.150	1.5	1.5	2.0	5.860	7.900	0.000	0.300
IRON WORKER		HWY		25.400	26.900	1.5	1.5	2.0	5.860	7.900	0.000	0.300
LABORER		BLD		23.870	24.870	1.5	1.5	2.0	5.050	5.330	0.000	0.600
LABORER		HWY		24.000	24.750	1.5	1.5	2.0	5.050	5.330	0.000	0.600
LATHER		BLD		25.910	27.910	1.5	1.5	2.0	6.500	6.480	0.000	0.320
MACHINIST		BLD		36.890	38.890	2.0	2.0	2.0	4.380	5.650	2.550	0.000
MARBLE FINISHERS		BLD		23.300	0.000	1.5	1.5	2.0	6.000	6.700	0.000	0.000
MARBLE MASON		BLD		24.800	25.550	2.0	2.0	2.0	6.000	6.700	0.000	0.000
MILLWRIGHT		BLD		26.000	28.000	1.5	1.5	2.0	6.500	6.850	0.000	0.320
MILLWRIGHT		HWY		19.270	20.520	1.5	1.5	2.0	2.800	3.000	0.000	0.000
OPERATING ENGINEER		BLD	1	26.550	0.000	1.5	1.5	2.0	6.150	6.200	0.000	0.850
OPERATING ENGINEER		BLD	2	24.200	0.000	1.5	1.5	2.0	6.150	6.200	0.000	0.850
OPERATING ENGINEER		BLD	3	20.600	0.000	1.5	1.5	2.0	6.150	6.200	0.000	0.850
OPERATING ENGINEER		BLD	4	28.050	0.000	1.5	1.5	2.0	6.150	6.200	0.000	0.850
OPERATING ENGINEER		HWY	1	26.800	0.000	1.5	1.5	2.0	6.150	6.200	0.000	0.850
OPERATING ENGINEER		HWY	2	24.030	0.000	1.5	1.5	2.0	6.150	6.200	0.000	0.850
OPERATING ENGINEER		HWY	3	19.800	0.000	1.5	1.5	2.0	6.150	6.200	0.000	0.850
OPERATING ENGINEER		HWY	4	28.300	0.000	1.5	1.5	2.0	6.150	6.200	0.000	0.850
PAINTER		ALL		25.390	26.390	1.5	1.5	2.0	4.650	5.500	0.000	0.250
PAINTER OVER 30FT		ALL		26.390	27.390	1.5	1.5	2.0	4.650	5.500	0.000	0.250
PAINTER PWR EQMT		ALL		26.390	27.390	1.5	1.5	2.0	4.650	5.500	0.000	0.250
PILEDRIVER		BLD		26.410	28.410	1.5	1.5	2.0	6.500	6.480	0.000	0.320
PILEDRIVER		HWY		26.250	28.000	1.5	1.5	2.0	6.500	6.500	0.000	0.300
PIPEFITTER		BLD		34.700	37.200	1.5	1.5	2.0	6.450	4.750	0.000	0.350
PLASTERER		BLD		25.000	26.500	1.5	1.5	2.0	4.830	8.050	0.000	0.500
PLUMBER		BLD		34.700	37.200	1.5	1.5	2.0	6.450	4.750	0.000	0.350
ROOFER		BLD		24.310	26.740	1.5	1.5	2.0	4.650	5.250	0.000	0.100
SHEETMETAL WORKER		BLD		27.820	29.570	1.5	1.5	2.0	7.150	7.880	0.000	0.350
SPRINKLER FITTER		BLD		31.240	33.240	1.5	1.5	2.0	6.500	5.350	0.000	0.250
STONE MASON		BLD		24.650	25.400	2.0	2.0	2.0	6.000	6.700	0.000	0.490
TERRAZZO FINISHER		BLD		23.300	0.000	1.5	1.5	2.0	6.000	6.700	0.000	0.000
TERRAZZO MASON		BLD		24.800	25.550	2.0	2.0	2.0	6.000	6.700	0.000	0.000
TILE MASON		BLD		24.800	25.550	2.0	2.0	2.0	6.000	6.700	0.000	0.000
TRUCK DRIVER		ALL	1	25.930	0.000	1.5	1.5	2.0	7.250	3.425	0.000	0.000
TRUCK DRIVER		ALL	2	26.330	0.000	1.5	1.5	2.0	7.250	3.425	0.000	0.000
TRUCK DRIVER		ALL	3	26.530	0.000	1.5	1.5	2.0	7.250	3.425	0.000	0.000
TRUCK DRIVER		ALL	4	26.780	0.000	1.5	1.5	2.0	7.250	3.425	0.000	0.000
TRUCK DRIVER		ALL	5	27.530	0.000	1.5	1.5	2.0	7.250	3.425	0.000	0.000
TRUCK DRIVER		O&C	1	20.740	0.000	1.5	1.5	2.0	7.250	3.425	0.000	0.000
TRUCK DRIVER		O&C	2	21.060	0.000	1.5	1.5	2.0	7.250	3.425	0.000	0.000

TRUCK DRIVER	O&C 3	21.220	0.000	1.5	1.5	2.0	7.250	3.425	0.000	0.000
TRUCK DRIVER	O&C 4	21.420	0.000	1.5	1.5	2.0	7.250	3.425	0.000	0.000
TRUCK DRIVER	O&C 5	22.020	0.000	1.5	1.5	2.0	7.250	3.425	0.000	0.000
TUCKPINTER	BLD	24.650	25.400	2.0	2.0	2.0	6.000	6.700	0.000	0.490

Legend :

M-F>8 (Overtime is required for any hour greater than 8 worked each day, Monday through Friday.)

OSA (Overtime is required for every hour worked on Saturday)

OSH (Overtime is required for every hour worked on Sunday and Holidays)

H/W (Health & Welfare Insurance)

Pensn (Pension)

Vac (Vacation)

Trng (Training)

## Explanations

### MENARD COUNTY

The following list is considered as those days for which holiday rates of wages for work performed apply: New Years Day, Memorial/Decoration Day, Fourth of July, Labor Day, Veterans Day, Thanksgiving Day, Christmas Day. Generally, any of these holidays which fall on a Sunday is celebrated on the following Monday. This then makes work performed on that Monday payable at the appropriate overtime rate for holiday pay. Common practice in a given local may alter certain days of celebration such as the day after Thanksgiving for Veterans Day. If in doubt, please check with IDOL.

Oil and chip resealing (O&C) means the application of road oils and liquid asphalt to coat an existing road surface, followed by application of aggregate chips or gravel to coated surface, and subsequent rolling of material to seal the surface.

### EXPLANATION OF CLASSES

ASBESTOS - GENERAL - removal of asbestos material/mold and hazardous materials from any place in a building, including mechanical systems where those mechanical systems are to be removed. This includes the removal of asbestos materials/mold and hazardous materials from ductwork or pipes in a building when the building is to be demolished at the time or at some close future date.

ASBESTOS - MECHANICAL - removal of asbestos material from mechanical systems, such as pipes, ducts, and boilers, where the mechanical systems are to remain.

### CERAMIC TILE FINISHER, MARBLE FINISHER, TERRAZZO FINISHER

Assisting, helping or supporting the tile, marble and terrazzo mechanic by performing their historic and traditional work assignments



required to complete the proper installation of the work covered by said crafts. The term "Ceramic" is used for naming the classification only and is in no way a limitation of the product handled. Ceramic takes into consideration most hard tiles.

#### ELECTRONIC SYSTEMS TECHNICIAN

Installation, service and maintenance of low-voltage systems which utilizes the transmission and/or transference of voice, sound, vision, or digital for commercial, education, security and entertainment purposes for the following: TV monitoring and surveillance, background/foreground music, intercom and telephone interconnect, field programming, inventory control systems, microwave transmission, multi-media, multiplex, radio page, school, intercom and sound burglar alarms and low voltage master clock systems.

Excluded from this classification are energy management systems, life safety systems, supervisory controls and data acquisition systems not intrinsic with the above listed systems, fire alarm systems, nurse call systems and raceways exceeding fifteen feet in length.

#### TRUCK DRIVER - BUILDING, HEAVY AND HIGHWAY CONSTRUCTION

Class 1. Drivers on 2 axle trucks hauling less than 9 ton. Air compressor and welding machines and brooms, including those pulled by separate units, truck driver helpers, warehouse employees, mechanic helpers, greasers and tiremen, pickup trucks when hauling materials, tools, or workers to and from and on-the-job site, and fork lifts up to 6,000 lb. capacity.

Class 2. Two or three axle trucks hauling more than 9 ton but hauling less than 16 ton. A-frame winch trucks, hydrolift trucks, vactor trucks or similar equipment when used for transportation purposes. Fork lifts over 6,000 lb. capacity, winch trucks, four axle combination units, and ticket writers.

Class 3. Two, three or four axle trucks hauling 16 ton or more. Drivers on water pulls, articulated dump trucks, mechanics and working forepersons, and dispatchers. Five axle or more combination units.

Class 4. Low Boy and Oil Distributors.

Class 5. Drivers who require special protective clothing while employed on hazardous waste work.

#### TRUCK DRIVER - OIL AND CHIP RESEALING ONLY.

This shall encompass laborers, workers and mechanics who drive contractor or subcontractor owned, leased, or hired pickup, dump, service, or oil distributor trucks. The work includes transporting materials and equipment (including but not limited to, oils, aggregate supplies, parts, machinery and tools) to or from the job site; distributing oil or liquid asphalt and aggregate; stock piling material when in connection with the actual oil and chip contract. The Truck Driver (Oil & Chip Resealing) wage classification does not include supplier delivered materials.

#### OPERATING ENGINEERS - BUILDING

CLASS 1. Asphalt Screed Man; Aspco Concrete Spreaders; Asphalt Pavers; Asphalt Plant Engineer; Asphalt Rollers on Bituminous Concrete; Athey Loaders; Backfillers, Crane Type; Backhoes; Barber Green Loaders; Bulldozers; Cableways; Cherry Pickers; Clam Shells; C.M.I. & similar type autograde formless paver, autograde placer &

finisher; Concrete Breakers; Concrete Pumps; Derricks; Derrick Boats; Draglines; Earth Auger or Boring Machines; Elevating Graders; Engineers on Dredges; Gravel Processing Machines; Head Equipment Greaser; High Lifts or Fork Lifts; Hoists with two or more drums or two or more load lines; Locomotives, All; Mechanics; Motor Graders or Auto Patrols; Operators or Leverman on Dredges; Operators, Power Boat; Operators, Pug Mill (Asphalt Plants); Orange Peels; Overhead Cranes; Paving Mixers; Piledrivers; Pipe Wrapping and Painting Machines; Pushdozers, or Push Cats; Robotic Controlled Equipment in this Classification; Rock Crushers; Ross Carrier or Similar Machines; Rotomill; Scoops, Skimmer, two cu. yd. capacity and under; Scoops, All or Tournapull; Sheep-Foot Roller (Self Propelled); Shovels; Skid Steer; Skimmer Scoops; Temporary Concrete Plant Operators; Test Hole Drilling Machines; Tower Machines; Tower Mixers; Track Type End Loaders; Track Type Fork Lifts or High Lifts; Track Jacks and Tampers; Tractors, Sideboom; Trenching or Ditching Machine; Tunnelluggers; Vermeer Type Saws; Water Blaster Cutting Head; Wheel Type End Loaders; Winch Cat.

CLASS 2. Air Compressors (six to eight)\*; Asphalt Boosters and Heaters; Asphalt Distributors; Asphalt Plant Fireman; Oiler on Two Paving Mixers When Used in Tandem; Boom or Winch Trucks; Bull Floats or Flexplanes; Concrete Finishing Machine; Concrete Saws, Self-Propelled; Concrete Spreading Machines; Conveyors (six to eight)\*; Generators (six to eight)\*; Gravel or Stone Spreader, Power Operated; Hoist (with One Drum and One Load Line); Light Plants (six to eight)\*; Mechanical Heaters (six to eight)\*; Mud Jacks; Post Hole Digger, Mechanical; Pug Mills when used for other than Asphalt operation; Robotic Controlled Equipment in this Classification; Road or Street Sweeper, Self Propelled; Rollers (except bituminous concrete); Seaman Tiller; Straw Machine; Vibratory Compactor; Water Blaster, Power Unit; Welding Machines (six to eight)\*; Well Drill Machines.

CLASS 3. Air Compressors(one to five)\*; Air Compressors, Track or Self-Propelled; Automatic Hoist; Building Elevators; Bulk Cement Batching Plants; Conveyors (one to five)\*; Concrete Mixers (Except Plant, Paver, or Tower); Firemen; Generators (one to five)\*; Greasers; Helper on Single Paving Mixer; Hoist, Automatic; Light Plants (one to five)\*; Mechanic Helpers; Mechanical Heaters (one to five)\*; Oilers; Power Form Graders; Power Sub-Graders; Robotic Controlled Equipment in this Classification; Scissors Hoist; Tractors without power attachments regardless of size or type; Truck Crane Oiler and Driver (1 man); Vibratory Hammer (power source); Water Pumps (one to five)\*; Welding Machines (1/300 Amp. or over)\*; Welding machines (one to five)\*

CLASS 4. Lattice Boom Crawler Cranes; Lattice Boom Truck Cranes; Telescopic Truck-Mounted Cranes; Tower Cranes.

\* Combinations of one to eight of any Air Compressors, Conveyors, Welding Machines, Water Pumps, Light Plants, or Generators shall be in batteries or within 400 feet and shall be paid as per the Classification Schedule contained in this Article.

#### OPERATING ENGINEERS - HIGHWAY

CLASS 1. Asphalt Screed Man; Asphco Concrete Spreaders; Asphalt Pavers; Asphalt Plant Engineer; Asphalt Rollers on Bituminous Concrete; Athey Loaders; Backhoes; Barber Green Loaders; Bulldozers; Cableways; Carry Deck Pickers; Cherry Pickers (Rough Terrain); C.M.I. & similar type-autograde formless paver, autograde placer & finisher; Concrete Breakers; Concrete Plant Operators; Concrete Pumps; Derricks;

Derrick Boats; Dewatering Systems; Earth Auger or Boring Machines; Elevating Graders; Engineers on Dredges; Gravel Processing Machines; Grout Pump; Head Equipment Greaser; High Lifts or Fork Lifts; Hoists with two or more drums or two or more load lines; Hydro Jet or Hydro Laser; Locomotives, All; Mechanics; Motor Graders or Auto Patrols; Multi-Point Power Lifting Equipment; Operators or Leverman on Dredges; Operators, Power Boat; Operators, Pug Mill (Asphalt Plants); Overhead Cranes; Paving Mixers; Piledrivers; Pipe Wrapping and Painting Machines; Push-dozers, or Push Cats; Robotic Controlled Equipment in this Classification; Rock Crushers; Ross Carrier or Similar Machines; Roto-Mill; Scoops, Skimmer, two cu. yd. capacity and under; Sheep-Foot Roller (Self Pro-pelled); Shovels; Skid Steer; Skimmer Scoops; Test Hole Drilling Machines; Tower Machines; Tower Mixers; Track Type End Loaders; Track Type Fork Lifts or High Lifts; Track Jacks and Tampers; Tractors, Side-boom; Trenching or Ditching Machine; Tunnelluggers; Vermeer-Type Saws; Wheel Type End Loaders; Winch Cat; Scoops, All or Tournapull.

CLASS 2. Air Compressors (six to eight)\*; Articulated Dumps; Asphalt Boosters and Heaters; Asphalt Distributors; Asphalt Plant Fireman; Boom or Winch Trucks; Building Elevators; Bull Floats or Flexplanes; Concrete Finishing Machine; Concrete Saws, Self-Propelled; Concrete Spreading Machines; Conveyors (six to eight)\*; Generators (six to eight)\*; Gravel or Stone Spreader, Power Operated; Hoist, Automatic; Hoist with One Drum and One Load Line; Light Plants (six to eight)\*; Mechanical Heaters (six to eight)\*; Mud Jacks; Off Road Water Wagons; Oiler on Two Paving Mixers When Used in Tandem; Post Hole Digger, Mechanical; Robotic Controlled Equipment in This Classification; Road or Street Sweeper, Self-Propelled; Rollers (except bituminous concrete); Scissor Hoist; Sea-man Tiller; Straw Machine; Vibratory Compactor; Water Pumps (six to eight)\*; Well Drill Machines.

CLASS 3. Air Compressors (one to five)\*; Air Compressors, Track or Self-Propelled; Bulk Cement Batching Plants; Conveyors (one to five)\*; Concrete Mixers (Except Plant, Paver, or Tower); Firemen; Generators (one to five)\*; Greasers; Helper on Single Paving Mixer; Light Plants (one to five)\*; Mechanic Helpers; Mechanical Heaters (one to five)\*; Oilers; Power Form Graders; Power Sub-Graders; Pug Mills when used for other than Asphalt operation; Robotic Controlled Equipment in This Classification; Tractors without power attachments, regardless of size or type; Truck Crane Oiler and Driver (1 man); Vibratory Hammer (power source); Water Pumps (one to five)\*; Welding Machines (one 300 Amp. or over)\*; Welding Machines (one to five)\*.

CLASS 4. Lattice Boom Crawler Crane; Lattice Boom Truck Crane; Telescopic Truck-Mounted Crane; Tower Crane.

\*Combinations of one to eight of any Air Compressors, Conveyors, Welding Machines, Water Pumps, Light Plants or Generators shall be in batteries or within 400 feet and shall be paid as per the Classification Schedule contained in this Article.

Other Classifications of Work:

For definitions of classifications not otherwise set out, the Department generally has on file such definitions which are available. If a task to be performed is not subject to one of the classifications of pay set out, the Department will upon being contacted state which neighboring county has such a classification and provide such rate, such rate being deemed to exist by reference in this document. If no neighboring county rate applies to the task, the Department shall undertake a special determination, such special

determination being then deemed to have existed under this determination. If a project requires these, or any classification not listed, please contact IDOL at 618/993-7271 for wage rates or clarifications.

#### LANDSCAPING

Landscaping work falls under the existing classifications for laborer, operating engineer and truck driver. The work performed by landscape plantsman and landscape laborer is covered by the existing classification of laborer. The work performed by landscape operators (regardless of equipment used or its size) is covered by the classifications of operating engineer. The work performed by landscape truck drivers (regardless of size of truck driven) is covered by the classifications of truck driver.

# Mercer County Prevailing Wage for April 2007

Trade Name	RG	TYP	C	Base	FRMAN	*M-F>8	OSA	OSH	H/W	Pensn	Vac	Trng
=====	==	==	=	=====	=====	=====	==	==	=====	=====	=====	=====
ASBESTOS ABT-GEN		BLD		21.910	22.410	1.5	1.5	2.0	5.450	4.000	0.000	0.600
ASBESTOS ABT-GEN		HWY		23.160	24.160	1.5	1.5	2.0	5.600	4.400	0.000	0.600
ASBESTOS ABT-MEC		BLD		18.750	19.750	1.5	1.5	2.0	4.750	2.000	0.000	0.000
BOILERMAKER		BLD		30.970	33.970	2.0	2.0	2.0	8.270	7.740	0.000	0.300
BRICK MASON		BLD		24.300	25.550	1.5	1.5	2.0	6.250	4.750	0.000	0.360
CARPENTER		BLD		24.750	25.990	1.5	1.5	2.0	5.700	5.160	0.000	0.400
CARPENTER		HWY		25.540	27.290	1.5	1.5	2.0	5.860	6.260	0.000	0.400
CEMENT MASON		BLD		22.840	23.840	1.5	1.5	2.0	5.200	5.300	0.000	0.250
CEMENT MASON		HWY		23.060	24.060	1.5	1.5	2.0	5.300	5.800	0.000	0.500
CERAMIC TILE FNSHER		BLD		17.190	0.000	1.5	1.5	2.0	6.250	4.000	0.000	0.210
ELECTRIC PWR EQMT OP		ALL		30.750	0.000	1.5	1.5	2.0	4.750	8.610	0.000	0.000
ELECTRIC PWR GRNDMAN		ALL		21.090	0.000	1.5	1.5	2.0	4.750	5.905	0.000	0.000
ELECTRIC PWR LINEMAN		ALL		34.160	36.350	1.5	1.5	2.0	4.750	9.560	0.000	0.000
ELECTRIC PWR TRK DRV		ALL		22.130	0.000	1.5	1.5	2.0	4.750	6.200	0.000	0.000
ELECTRICIAN	NW	BLD		27.770	29.770	1.5	1.5	2.0	5.500	7.660	0.000	0.310
ELECTRICIAN	SE	BLD		27.040	29.040	1.5	1.5	2.0	5.150	7.460	0.000	0.250
ELECTRONIC SYS TECH		BLD		23.850	25.350	1.5	1.5	2.0	5.150	5.625	0.000	0.250
ELEVATOR CONSTRUCTOR		BLD		33.140	37.280	2.0	2.0	2.0	8.275	6.060	1.990	0.000
GLAZIER		BLD		23.220	24.610	1.5	1.5	2.0	4.750	3.900	0.000	0.200
HT/FROST INSULATOR		BLD		25.860	27.060	1.5	1.5	2.0	4.800	7.500	0.000	0.000
IRON WORKER		ALL		23.100	24.950	1.5	1.5	2.0	8.040	7.990	0.000	0.420
LABORER		BLD	1	20.410	20.910	1.5	1.5	2.0	5.450	4.000	0.000	0.600
LABORER		BLD	2	21.910	22.410	1.5	1.5	2.0	5.450	4.000	0.000	0.600
LABORER		BLD	3	22.560	23.060	1.5	1.5	2.0	5.450	4.000	0.000	0.600
LABORER		HWY	1	22.660	23.660	1.5	1.5	2.0	5.600	4.400	0.000	0.600
LABORER		HWY	2	23.160	24.160	1.5	1.5	2.0	5.600	4.400	0.000	0.600
LABORER		HWY	3	23.790	24.790	1.5	1.5	2.0	5.600	4.400	0.000	0.600
LATHER		BLD		24.750	25.990	1.5	1.5	2.0	5.700	5.160	0.000	0.400
MACHINIST		BLD		36.890	38.890	2.0	2.0	2.0	4.380	5.650	2.550	0.000
MARBLE FINISHERS		BLD		17.190	0.000	1.5	1.5	2.0	6.250	4.000	0.000	0.210
MARBLE MASON		BLD		21.530	22.030	1.5	1.5	2.0	6.250	4.000	0.000	0.210
MILLWRIGHT		BLD		25.000	26.700	1.5	1.5	2.0	5.550	7.730	0.000	0.560
MILLWRIGHT		HWY		19.330	20.580	1.5	1.5	2.0	1.550	2.000	0.000	0.000
OPERATING ENGINEER		BLD	1	26.150	0.000	1.5	1.5	2.0	6.850	5.800	1.500	0.550
OPERATING ENGINEER		BLD	2	23.500	0.000	1.5	1.5	2.0	6.850	5.800	1.500	0.550
OPERATING ENGINEER		BLD	3	22.450	0.000	1.5	1.5	2.0	6.850	5.800	1.500	0.550
OPERATING ENGINEER		HWY	1	26.150	27.150	1.5	1.5	2.0	6.850	5.800	1.500	0.550
OPERATING ENGINEER		HWY	2	24.550	27.150	1.5	1.5	2.0	6.850	5.800	1.500	0.550
OPERATING ENGINEER		HWY	3	23.400	27.150	1.5	1.5	2.0	6.850	5.800	1.500	0.550
PAINTER		ALL		23.470	24.470	1.5	1.5	1.5	4.650	4.850	0.000	0.600
PAINTER OVER 30FT		ALL		24.720	25.720	1.5	1.5	1.5	4.650	4.850	0.000	0.600
PAINTER PWR EQMT		ALL		23.970	24.970	1.5	1.5	1.5	4.650	4.850	0.000	0.600
PILEDRIVER		BLD		24.750	25.990	1.5	1.5	2.0	5.700	5.160	0.000	0.400
PILEDRIVER		HWY		25.540	27.290	1.5	1.5	2.0	5.860	6.260	0.000	0.400
PIPEFITTER		ALL		30.520	33.570	1.5	1.5	2.0	4.800	7.960	0.000	0.530
PLASTERER		BLD		25.900	27.450	1.5	1.5	2.0	4.000	4.400	0.000	0.100
PLUMBER		ALL		30.520	33.570	1.5	1.5	2.0	4.800	7.960	0.000	0.530
ROOFER		BLD		22.850	24.100	1.5	1.5	2.0	5.840	4.870	0.000	0.190
SHEETMETAL WORKER		BLD		27.300	29.000	1.5	1.5	2.0	6.040	7.300	0.000	0.380
SPRINKLER FITTER		BLD		31.240	33.240	1.5	1.5	2.0	6.500	5.350	0.000	0.250
STONE MASON		BLD		24.300	25.550	1.5	1.5	2.0	6.250	4.750	0.000	0.360
TERRAZZO FINISHER		BLD		17.190	0.000	1.5	1.5	2.0	6.250	4.000	0.000	0.210
TERRAZZO MASON		BLD		21.530	22.030	1.5	1.5	2.0	6.250	4.000	0.000	0.210
TILE LAYER		BLD		24.750	25.990	1.5	1.5	2.0	5.700	5.160	0.000	0.400
TILE MASON		BLD		21.530	22.030	1.5	1.5	2.0	6.250	4.000	0.000	0.210
TRUCK DRIVER		ALL	1	25.930	0.000	1.5	1.5	2.0	7.250	3.425	0.000	0.000
TRUCK DRIVER		ALL	2	26.333	0.000	1.5	1.5	2.0	7.250	3.425	0.000	0.000
TRUCK DRIVER		ALL	3	26.530	0.000	1.5	1.5	2.0	7.250	3.425	0.000	0.000

TRUCK DRIVER	ALL	4	26.780	0.000	1.5	1.5	2.0	7.250	3.425	0.000	0.000
TRUCK DRIVER	ALL	5	27.530	0.000	1.5	1.5	2.0	7.250	3.425	0.000	0.000
TRUCK DRIVER	O&C	1	20.740	0.000	1.5	1.5	2.0	7.250	3.425	0.000	0.000
TRUCK DRIVER	O&C	2	21.060	0.000	1.5	1.5	2.0	7.250	3.425	0.000	0.000
TRUCK DRIVER	O&C	3	21.220	0.000	1.5	1.5	2.0	7.250	3.425	0.000	0.000
TRUCK DRIVER	O&C	4	21.420	0.000	1.5	1.5	2.0	7.250	3.425	0.000	0.000
TRUCK DRIVER	O&C	5	22.020	0.000	1.5	1.5	2.0	7.250	3.425	0.000	0.000
TUCKPOINTER	BLD		24.300	25.550	1.5	1.5	2.0	6.250	4.750	0.000	0.360

Legend:

M-F>8 (Overtime is required for any hour greater than 8 worked each day, Monday through Friday.)

OSA (Overtime is required for every hour worked on Saturday)

OSH (Overtime is required for every hour worked on Sunday and Holidays)

H/W (Health & Welfare Insurance)

Pensn (Pension)

Vac (Vacation)

Trng (Training)

## Explanations

### MERCER COUNTY

ELECTRICIAN (SOUTHEAST) - Townships of Ohio Grove, Suez, and North Henderson.

The following list is considered as those days for which holiday rates of wages for work performed apply: New Years Day, Memorial/Decoration Day, Fourth of July, Labor Day, Veterans Day, Thanksgiving Day, Christmas Day. Generally, any of these holidays which fall on a Sunday is celebrated on the following Monday. This then makes work performed on that Monday payable at the appropriate overtime rate for holiday pay. Common practice in a given local may alter certain days of celebration such as the day after Thanksgiving for Veterans Day. If in doubt, please check with IDOL.

Oil and chip resealing (O&C) means the application of road oils and liquid asphalt to coat an existing road surface, followed by application of aggregate chips or gravel to coated surface, and subsequent rolling of material to seal the surface.

### EXPLANATION OF CLASSES

ASBESTOS - GENERAL - removal of asbestos material/mold and hazardous materials from any place in a building, including mechanical systems where those mechanical systems are to be removed. This includes the removal of asbestos materials/mold and hazardous materials from ductwork or pipes in a building when the building is to be demolished at the time or at some close future date.

ASBESTOS - MECHANICAL - removal of asbestos material from mechanical systems, such as pipes, ducts, and boilers, where the mechanical systems are to remain.

CERAMIC TIEL FINISHER, MARBLE FINISHER, TERRAZZO FINISHER

Assisting, helping or supporting the tile, marble and terrazzo mechanic by performing their historic and traditional work assignments required to complete the proper installation of the work covered by said crafts. The term "Ceramic" is used for naming the classification only and is in no way a limitation of the product handled. Ceramic takes into consideration most hard tiles.

ELECTRONIC SYSTEMS TECHNICIAN

Installation, service and maintenance of low-voltage systems which utilizes the transmission and/or transference of voice, sound, vision, or digital for commercial, education, security and entertainment purposes for the following: TV monitoring and surveillance, background/foreground music, intercom and telephone interconnect, field programming, inventory control systems, microwave transmission, multi-media, multiplex, radio page, school, intercom and sound burglar alarms and low voltage master clock systems.

Excluded from this classification are energy management systems, life safety systems, supervisory controls and data acquisition systems not intrinsic with the above listed systems, fire alarm systems, nurse call systems and raceways exceeding fifteen feet in length.

TRUCK DRIVER - BUILDING, HEAVY AND HIGHWAY CONSTRUCTION

Class 1. Drivers on 2 axle trucks hauling less than 9 ton. Air compressor and welding machines and brooms, including those pulled by separate units, truck driver helpers, warehouse employees, mechanic helpers, greasers and tiremen, pickup trucks when hauling materials, tools, or workers to and from and on-the-job site, and fork lifts up to 6,000 lb. capacity.

Class 2. Two or three axle trucks hauling more than 9 ton but hauling less than 16 ton. A-frame winch trucks, hydrolift trucks, vector trucks or similar equipment when used for transportation purposes. Fork lifts over 6,000 lb. capacity, winch trucks, four axle combination units, and ticket writers.

Class 3. Two, three or four axle trucks hauling 16 ton or more. Drivers on water pulls, articulated dump trucks, mechanics and working forepersons, and dispatchers. Five axle or more combination units.

Class 4. Low Boy and Oil Distributors.

Class 5. Drivers who require special protective clothing while employed on hazardous waste work.

TRUCK DRIVER - OIL AND CHIP RESEALING ONLY.

This shall encompass laborers, workers and mechanics who drive contractor or subcontractor owned, leased, or hired pickup, dump, service, or oil distributor trucks. The work includes transporting materials and equipment (including but not limited to, oils, aggregate supplies, parts, machinery and tools) to or from the job site; distributing oil or liquid asphalt and aggregate; stock piling material when in connection with the actual oil and chip contract. The Truck Driver (Oil & Chip Resealing) wage classification does not include supplier delivered materials.

OPERATING ENGINEERS - BUILDING, HEAVY AND HIGHWAY CONSTRUCTION

Class 1. An engineer on Crane, Shovel, Clamshell, Dragline, Backhoe,

Derrick, Tower Crane, Cable Way, Spreader (servicing two pavers), Asphalt Spreader, Asphalt Mixer, Plant Engineer, Dipper Dredge Operator, Dipper Dredge Craneman, Dual Purpose Truck (boom or winch), Leverman or Engineman (hydraulic dredge), Mechanic, Paving Mixer with tower attached, Pile Driver, Boom Tractor, Stationary, Portable or Floating Mixing Plant, Trenching Machine (over 40 H.P.), Building Hoist (two drums), Hot Paint Wrapping Machine, Cleaning and Priming Machine, Backfiller (throw bucket), Locomotive Engineer, Qualified Welder, Tow or Push Boat, Concrete Paver, Seaman Trav-L- Plant or similar machines, CMI Autograder or similar machines, Slip Form Paver, Caisson Augering Machine, Mucking Machine, Asphalt Heater-Planer Unit, Hydraulic Cranes, Mine Hoists. An engineer on Athey, Barber-Green, Euclid or Haiss Loader, Asphalt Pug Mill, Fireman and Drier, Concrete Pump, Concrete Spreader (servicing one paver) Bulldozer, Endloader, Log Chippers or similar machines, Elevating Grader, Group Equipment Greaser, LeTourneaupul and similar machines, off-road haul units, DW-10 Hyster Winch and similar machines, Motor Patrol, Power Blade, Push Cat, Tractor Pulling elevating Grader or Power Blade, Tractor Operating Scoop or Scraper, Tractor with Power Attachment, Roller on Asphalt or Blacktop, Single Drum Hoist, Jaeger Mix and Place Machine, Pipe Bending Machine, Flexaplane or similar machines, Automatic Curbing Machines, Automatic Cement and Gravel Batch Plants (one stop set-up), Seaman Pulvi-Mixer or similar machines, Blastholer Self-propelled Rotary Drill or similar machines, Work Boat, Combination Concrete Finishing Machine and Float, Self-propelled Sheep Foot Roller or Compactor (used in conjunction with a Grading Spread), Asphalt Spreader Screed Operator, Apsco spreader or similar machine, Slusher, Forklift (over 6000 lb. cap. or working at heights above 28 ft.) Concrete Conveyors, Chip Spreader, Underground Boring Machine (BUILDING ONLY), Straddle Carrier, Hydro-Hammer (BUILDING ONLY), Hydraulic Pumps or Power Units Driven by any power source (except manually), used to hoist or lift machinery or material.

Class 2. An engineer on Asphalt Booster, Fireman and Pump Operator at Asphalt Plant, Mud Jack, Underground Boring Machine (HIGHWAY ONLY), Concrete Finishing Machine, Form Grader with Roller on Earth, Mixers (3 bag to 16E), Power Operated Bull Float, Tractor without Power attachment, Dope Pot (agitating motor), Dope Chop Machine, Distributor (back end), Straddle Carrier, Portable Machine Fireman, Hydro-Hammer (HIGHWAY ONLY), Power Winch on Paving Work, Self-propelled Roller or Compactor (other than provided for above), Pump Operator (more than one well-point pump), Portable Crusher Operator, Trench Machine (under 40 H.P.), Power Subgrader (on forms) or similar machines, Forklift (6000 or less cap.) Gypsum Pump, Conveyor over 20 H.P., Fuller Kenyon Cement Pump or similar machines. An engineer on Air Compressor (400 c.f.m. or over HIGHWAY ONLY), Light Plant, Mixers (1 or 2 bag), Power Batching Machine (Cement Auger or Conveyor), Boiler (Engineer or Fireman), Water Pumps (HIGHWAY ONLY), Mechanical Broom, Automatic Cement and Gravel Batch Plants (two or three stop set-up), Small Rubber-tired Tractors (not including backhoes or endloaders), Self-propelled Curing Machine, Brush Chipper, Driver on Truck Crane or similar machines.

Class 3. Oiler, Mechanic's Helper, Mechanical Heater (other than steam boiler), Belt Machine, Small Outboard Motor Boats (Safety Boat and Life Boat), Engine Driven Welding Machine, and Small Tractors (used to unroll or roll wire mesh), Water pumps (BUILDING ONLY), Air Compressors (BUILDING ONLY), Permanent Automatic Elevators.

#### LABORER - BUILDING

Class 1: General laborer, carpenter tender, tool cribman, salamander



tender, flagman, form handler, floor sweeper, material handler, fencing laborer, cleaning lumber, landscaper, unloading explosives, laying of sod, planting/removal of trees, wrecking laborer, unloading of Re-Bars, scaffold worker, signal man on crane.

Class 2: Handling of materials treated with creosote, kettle men, prime mover or motorized unit used for wet concrete or handling of building materials, vibrator operator, mortar mixer, power tools used under the jurisdiction of laborers, sand points, gunnite nozzle men, welders, cutters, burners and torchmen, chain saw operator, jackhammer and drill operators, paving breakers, air tamping hammerman, concrete saw operator, concrete burning machine operator, coring machine operator - hod carrier and plasterer tender.

Class 3: Caisson worker after 6 foot depth, dynamite man, asbestos abatement worker, tunnel miners - mixerman (plaster only), pump man.

#### LABOR - HEAVY & HIGHWAY

Class 1: Rod or chain man, flagman, dumpman, spotter, broom man, landscaper, planting and removal of trees, fencing laborers, dispatcher, ticket writer, scaleman, cleaning of forms or lumber (in bone yard), laying of sod, moving and/or maintenance of flares and barricades.

Class 2: Operation of all hand, electric, air, hydraulic or mechanically powered tools under the jurisdiction of Laborers' including jackhammers, tempers, air spades, augers, concrete saws, chain saws, utility saws, rock drills, vibrators, mortar mixer, power and hand saw (when clearing timber) general laborer (not elsewhere covered), craft-tender, material checker, material handler, form handler, concrete dumper, puddler, form setter helper, explosives handler, dynamite helper, center strip, reinforcing in concrete, wire mesh handler and installer, prime mover or any mechanical device taking the place of concrete buggy or wheelbarrow, sandpoint setter, asphalt kettleman. Sheeting hammer drivers, laying and jointing of telephone conduit, gas distribution men, pipe setter on laterals, drain tiles, culvert pipe, and storm sewer catch basin leads, catch basins, manholes, batch dumpers, tank cleaners, cofferdam workers, bankman on floating plant, jointman with pipelayers. Back-up man (corker, joint maker) with pipe setter on sewer and water mains, batterboard man or laser operator on sewer and water main, labor in ditch, or tunnel, on sewer or water mains and telephone conduit. Cutters, burners, torchman, gravel box man, asphalt plant laborers, concrete plant laborer, deck hand, unloading of steel and rebar, laser beam operator, wrecking laborers.

Class 3: Asphalt raker or luteman, head form setter, head dynamite man (powderman) head string or wireline man (on paving), pipe setter on sewer or water main, gunnite nozzle man, asphalt or concrete curb machine operator, head grade man, head tunnel miner, concrete burning machine operator, coring machine operator, welder.

#### Other Classifications of Work:

For definitions of classifications not otherwise set out, the Department generally has on file such definitions which are available. If a task to be performed is not subject to one of the classifications of pay set out, the Department will upon being contacted state which neighboring county has such a classification and provide such rate, such rate being deemed to exist by reference in this document. If no neighboring county rate applies to the task, the Department shall undertake a special determination, such special determination being then deemed to have existed under this

determination. If a project requires these, or any classification not listed, please contact IDOL at 618/993-7271 for wage rates or clarifications.

#### LANDSCAPING

Landscaping work falls under the existing classifications for laborer, operating engineer and truck driver. The work performed by landscape plantsman and landscape laborer is covered by the existing classification of laborer. The work performed by landscape operators (regardless of equipment used or its size) is covered by the classifications of operating engineer. The work performed by landscape truck drivers (regardless of size of truck driven) is covered by the classifications of truck driver.

# Monroe County Prevailing Wage for April 2007

Trade Name	RG	TYP	C	Base	FRMAN	*M-F>8	OSA	OSH	H/W	Pensn	Vac	Trng
=====	==	==	=	=====	=====	=====	==	==	=====	=====	=====	=====
ASBESTOS ABT-GEN		ALL		22.800	23.300	1.5	1.5	2.0	5.250	8.000	0.000	0.600
ASBESTOS ABT-MEC		BLD		25.290	26.290	1.5	1.5	2.0	4.450	2.500	0.000	0.250
BOILERMAKER		BLD		28.500	31.000	1.5	1.5	2.0	6.820	11.03	0.000	0.300
BRICK MASON		BLD		26.400	28.100	1.5	1.5	5.0	4.750	8.250	2.000	0.390
CARPENTER		ALL		30.480	31.980	1.5	1.5	2.0	5.050	3.750	0.000	0.350
CEMENT MASON		ALL		26.750	27.500	1.5	1.5	2.0	5.650	8.250	0.000	0.200
CERAMIC TILE FNSHER		BLD		22.610	0.000	1.5	1.5	2.0	5.000	4.300	0.000	0.400
ELECTRIC PWR EQMT OP		ALL		31.510	37.980	1.5	2.0	2.0	4.530	7.880	0.000	0.160
ELECTRIC PWR GRNDMAN		ALL		23.530	37.980	1.5	2.0	2.0	3.380	5.890	0.000	0.120
ELECTRIC PWR LINEMAN		ALL		36.220	37.980	1.5	2.0	2.0	5.210	9.060	0.000	0.180
ELECTRIC PWR TRK DRV		ALL		25.710	37.980	1.5	2.0	2.0	3.700	6.430	0.000	0.130
ELECTRICIAN		ALL		32.590	34.550	1.5	1.5	2.0	5.210	6.360	0.000	0.490
ELECTRONIC SYS TECH		BLD		25.810	27.310	1.5	1.5	2.0	2.800	5.490	0.000	0.250
ELEVATOR CONSTRUCTOR		BLD		37.115	41.750	2.0	2.0	2.0	8.275	4.460	2.227	0.000
FLOOR LAYER		BLD		26.930	27.680	1.5	1.5	2.0	5.000	3.750	0.000	0.350
GLAZIER		BLD		29.480	0.000	2.0	2.0	2.0	8.550	6.920	2.360	0.160
HT/FROST INSULATOR		BLD		30.440	31.440	1.5	1.5	2.0	4.850	8.360	0.000	0.450
IRON WORKER		ALL		26.350	27.850	1.5	1.5	2.0	6.360	8.250	0.000	0.420
LABORER		ALL		22.300	22.800	1.5	1.5	2.0	5.250	8.000	0.000	0.600
MACHINIST		BLD		36.890	38.890	2.0	2.0	2.0	4.380	5.650	2.550	0.000
MARBLE FINISHERS		BLD		22.610	0.000	1.5	1.5	2.0	5.000	4.300	0.000	0.400
MARBLE MASON		BLD		26.400	28.100	1.5	1.5	5.0	4.750	8.250	2.000	0.390
MILLWRIGHT		ALL		30.480	31.980	1.5	1.5	2.0	5.050	3.750	0.000	0.350
OPERATING ENGINEER		ALL	1	25.900	27.030	1.5	1.5	2.0	6.200	11.45	0.000	1.000
OPERATING ENGINEER		ALL	2	24.770	27.030	1.5	1.5	2.0	6.200	11.45	0.000	1.000
OPERATING ENGINEER		ALL	3	20.290	27.030	1.5	1.5	2.0	6.200	11.45	0.000	1.000
OPERATING ENGINEER		ALL	4	20.350	27.030	1.5	1.5	2.0	6.200	11.45	0.000	1.000
OPERATING ENGINEER		ALL	5	20.020	27.030	1.5	1.5	2.0	6.200	11.45	0.000	1.000
OPERATING ENGINEER		ALL	6	26.450	27.030	1.5	1.5	2.0	6.200	11.45	0.000	1.000
OPERATING ENGINEER		ALL	7	26.750	27.030	1.5	1.5	2.0	6.200	11.45	0.000	1.000
OPERATING ENGINEER		ALL	8	27.030	27.030	1.5	1.5	2.0	6.200	11.45	0.000	1.000
PAINTER		BLD		25.700	26.700	1.5	1.5	2.0	4.650	5.150	0.000	0.350
PAINTER		HWY		26.800	27.800	1.5	1.5	2.0	4.650	5.150	0.000	0.350
PAINTER OVER 30FT		BLD		26.700	27.700	1.5	1.5	2.0	4.650	5.150	0.000	0.350
PAINTER PWR EQMT		BLD		26.700	27.700	1.5	1.5	2.0	4.650	5.150	0.000	0.350
PAINTER PWR EQMT		HWY		27.800	28.800	1.5	1.5	2.0	4.650	5.150	0.000	0.350
PILEDRIVER		ALL		30.480	31.980	1.5	1.5	2.0	5.050	3.750	0.000	0.350
PIPEFITTER		BLD		30.000	32.000	1.5	1.5	2.0	5.940	7.000	0.000	0.350
PLASTERER		BLD		27.000	28.000	1.5	1.5	2.0	5.650	7.250	0.000	0.250
PLUMBER		BLD		30.450	32.950	1.5	1.5	2.0	4.950	5.450	0.000	0.300
ROOFER		BLD		26.250	28.250	1.5	1.5	2.0	6.100	5.950	0.000	0.200
SHEETMETAL WORKER		ALL		27.210	28.460	1.5	1.5	2.0	6.000	4.770	1.630	0.120
SPRINKLER FITTER		BLD		34.230	36.480	2.0	2.0	2.0	6.650	7.850	0.000	0.650
TERRAZZO FINISHER		BLD		31.240	0.000	1.5	1.5	2.0	0.000	0.000	0.000	0.000
TERRAZZO MASON		BLD		30.780	31.080	1.5	1.5	2.0	0.000	3.750	0.000	0.000
TRUCK DRIVER		ALL	1	25.930	0.000	1.5	1.5	2.0	7.250	3.425	0.000	0.000
TRUCK DRIVER		ALL	2	26.330	0.000	1.5	1.5	2.0	7.250	3.425	0.000	0.000
TRUCK DRIVER		ALL	3	26.530	0.000	1.5	1.5	2.0	7.250	3.425	0.000	0.000
TRUCK DRIVER		ALL	4	26.780	0.000	1.5	1.5	2.0	7.250	3.425	0.000	0.000
TRUCK DRIVER		ALL	5	27.530	0.000	1.5	1.5	2.0	7.250	3.425	0.000	0.000
TRUCK DRIVER		O&C	1	20.740	0.000	1.5	1.5	2.0	7.250	3.425	0.000	0.000
TRUCK DRIVER		O&C	2	21.060	0.000	1.5	1.5	2.0	7.250	3.425	0.000	0.000
TRUCK DRIVER		O&C	3	21.220	0.000	1.5	1.5	2.0	7.250	3.425	0.000	0.000
TRUCK DRIVER		O&C	4	21.420	0.000	1.5	1.5	2.0	7.250	3.425	0.000	0.000
TRUCK DRIVER		O&C	5	22.020	0.000	1.5	1.5	2.0	7.250	3.425	0.000	0.000

Legend:

M-F>8 (Overtime is required for any hour greater than 8 worked each day, Monday through Friday.)

OSA (Overtime is required for every hour worked on Saturday)

OSH (Overtime is required for every hour worked on Sunday and Holidays)

H/W (Health & Welfare Insurance)

Pensn (Pension)

Vac (Vacation)

Trng (Training)

## Explanations

### MONROE COUNTY

The following list is considered as those days for which holiday rates of wages for work performed apply: New Years Day, Memorial/Decoration Day, Fourth of July, Labor Day, Veterans Day, Thanksgiving Day, Christmas Day. Generally, any of these holidays which fall on a Sunday is celebrated on the following Monday. This then makes work performed on that Monday payable at the appropriate overtime rate for holiday pay. Common practice in a given local may alter certain days of celebration such as the day after Thanksgiving for Veterans Day. If in doubt, please check with IDOL.

Oil and chip resealing (O&C) means the application of road oils and liquid asphalt to coat an existing road surface, followed by application of aggregate chips or gravel to coated surface, and subsequent rolling of material to seal the surface.

### EXPLANATION OF CLASSES

ASBESTOS - GENERAL - removal of asbestos material/mold and hazardous materials from any place in a building, including mechanical systems where those mechanical systems are to be removed. This includes the removal of asbestos materials/mold and hazardous materials from ductwork or pipes in a building when the building is to be demolished at the time or at some close future date.

ASBESTOS - MECHANICAL - removal of asbestos material from mechanical systems, such as pipes, ducts, and boilers, where the mechanical systems are to remain.

### CERAMIC TILE FINISHER AND MARBLE FINISHER

The handling, at the building site, of all sand, cement, tile, marble or stone and all other materials that may be used and installed by [a] tile layer or marble mason. In addition, the grouting, cleaning, sealing, and mixing on the job site, and all other work as required in assisting the setter. The term "Ceramic" is used for naming the classification only and is in no way a limitation of the product handled. Ceramic takes into consideration most hard tiles.

## ELECTRONIC SYSTEMS TECHNICIAN

Installation, service and maintenance of low-voltage systems which utilizes the transmission and/or transference of voice, sound, vision, or digital for commercial, education, security and entertainment purposes for the following: TV monitoring and surveillance, background/foreground music, intercom and telephone interconnect, field programming, inventory control systems, microwave transmission, multi-media, multiplex, radio page, school, intercom and sound burglar alarms and low voltage master clock systems.

Excluded from this classification are energy management systems, life safety systems, supervisory controls and data acquisition systems not intrinsic with the above listed systems, fire alarm systems, nurse call systems and raceways exceeding fifteen feet in length.

## TRUCK DRIVER - BUILDING, HEAVY AND HIGHWAY CONSTRUCTION

Class 1. Drivers on 2 axle trucks hauling less than 9 ton. Air compressor and welding machines and brooms, including those pulled by separate units, truck driver helpers, warehouse employees, mechanic helpers, greasers and tiremen, pickup trucks when hauling materials, tools, or workers to and from and on-the-job site, and fork lifts up to 6,000 lb. capacity.

Class 2. Two or three axle trucks hauling more than 9 ton but hauling less than 16 ton. A-frame winch trucks, hydrolift trucks, vector trucks or similar equipment when used for transportation purposes. Fork lifts over 6,000 lb. capacity, winch trucks, four axle combination units, and ticket writers.

Class 3. Two, three or four axle trucks hauling 16 ton or more. Drivers on water pulls, articulated dump trucks, mechanics and working forepersons, and dispatchers. Five axle or more combination units.

Class 4. Low Boy and Oil Distributors.

Class 5. Drivers who require special protective clothing while employed on hazardous waste work.

## TRUCK DRIVER - OIL AND CHIP RESEALING ONLY.

This shall encompass laborers, workers and mechanics who drive contractor or subcontractor owned, leased, or hired pickup, dump, service, or oil distributor trucks. The work includes transporting materials and equipment (including but not limited to, oils, aggregate supplies, parts, machinery and tools) to or from the job site; distributing oil or liquid asphalt and aggregate; stock piling material when in connection with the actual oil and chip contract. The Truck Driver (Oil & Chip Resealing) wage classification does not include supplier delivered materials.

## OPERATING ENGINEERS

GROUP I. Cranes, Dragline, Shovels, Skimmer Scoops, Clamshells or Derrick Boats, Pile Drivers, Crane-Type Backhoes, Asphalt Plant Operators, Concrete Plant Operators, Dredges, Asphalt Spreading Machines, All Locomotives, Cable Ways, or Tower Machines, Hoists, Hydraulic Backhoes, Ditching Machines or Backfiller, Cherrypickers, Overhead Cranes, Roller, Steam or Gas, Concrete Pavers, Excavators, Concrete Breakers, Concrete Pumps, Bulk Cement Plants, Cement Pumps, Derrick-Type Drills, Boat Operators, Motor Graders or Pushcats, Scoops or Tournapulls, Bulldozers, Endloaders or Fork Lifts, Power Blade or Elevating Graders, Winch Cats, Boom or Winch Trucks or Boom Tractors,

Pipe Wrapping or Painting Machines, Asphalt Plant Engineer, Journeyman Lubricating Engineer, Drills (other than Derrick Type), Mud Jacks, or Well Drilling Machines, Boring Machines or Track Jacks, Mixers, Conveyors (Two), Air Compressors (Two), Water Pumps regardless of size (Two), Welding Machines (Two), Siphons or Jets (Two), Winch Heads or Apparatuses (Two), Light Plants (Two), Waterblasters (two), All Tractors regardless of size (straight tractor only), Fireman on Stationary Boilers, Automatic Elevators, Form Grading Machines, Finishing Machines, Power Sub-Grader or Ribbon Machines, Longitudinal Floats, Distributor Operators on Trucks, Winch Heads or Apparatuses (One), Mobil Track air and heaters (two to five), Heavy Equipment Greaser, Relief Operator, Assistant Master Mechanic and Heavy Duty Mechanic, all Operators (except those listed below).

GROUP II. Assistant Operators.

GROUP III. Air Compressors (One), Water Pumps, regardless of Size (One), Waterblasters (one), Welding Machine (One), Mixers (One Bag), Conveyor (One), Siphon or Jet (One), Light Plant (One), Heater (One), Immobile Track Air (One), and Self Propelled Walk-Behind Rollers.

GROUP IV. Asphalt Spreader Oilers, Fireman on Whirlies and Heavy Equipment Oilers, Truck Cranes, Dredges, Monigans, Large Cranes - (Over 65-ton rated capacity) Concrete Plant Oiler, Blacktop Plant Oiler, and Creter Crane Oiler (when required). GROUP V. Oiler.

GROUP VI. Master Mechanics, Operators on equipment with Booms, including jibs, 100 feet and over, and less than 150 feet long.

GROUP VII. Operators on equipment with Booms, including jibs, 150 feet and over, and less than 200 feet long.

GROUP VIII. Operators on Equipment with Booms, including jibs, 200 feet and over; Tower Cranes; Whirlie Cranes; and Operator Foreman.

#### TERRAZZO FINISHER

The handling of all materials used for Mosaic and Terrazzo work including preparing, mixing by hand, by mixing machine or transporting of pre-mixed materials and distributing with shovel, rake, hoe, or pail, all kinds of concrete foundations necessary for Mosaic and Terrazzo work, all cement terrazzo, magnesite terrazzo, Do-O-Tex terrazzo, epoxy matrix ter-razzo, exposed aggregate, rustic or rough washed for exterior or interior of buildings placed either by machine or by hand, and any other kind of mixture of plastics composed of chips or granules when mixed with cement, rubber, neoprene, vinyl, magnesium chloride or any other resinous or chemical substances used for seamless flooring systems, and all other building materials, all similar materials and all precast terrazzo work on jobs, all scratch coat used for Mosaic and Terrazzo work and sub-bed, tar paper and wire mesh (2x2 etc.) or lath. The rubbing, grinding, cleaning and finishing of same either by hand or by machine or by terrazzo resurfacing equipment on new or existing floors. When necessary finishers shall be allowed to assist the mechanics to spread sand bed, lay tarpaper and wire mesh (2x2 etc.) or lath. The finishing of cement floors where additional aggregate of stone is added by spreading or sprinkling on top of the finished base, and troweled or rolled into the finish and then the surface is ground by grinding machines.

Other Classifications of Work:

For definitions of classifications not otherwise set out, the Department generally has on file such definitions which are available. If a task to be performed is not subject to one of the classifications of pay set out, the Department will upon being contacted state which neighboring county has such a classification and provide such rate, such rate being deemed to exist by reference in this document. If no neighboring county rate applies to the task, the Department shall undertake a special determination, such special determination being then deemed to have existed under this determination. If a project requires these, or any classification not listed, please contact IDOL at 618/993-7271 for wage rates or clarifications.

#### LANDSCAPING

Landscaping work falls under the existing classifications for laborer, operating engineer and truck driver. The work performed by landscape plantsman and landscape laborer is covered by the existing classification of laborer. The work performed by landscape operators (regardless of equipment used or its size) is covered by the classifications of operating engineer. The work performed by landscape truck drivers (regardless of size of truck driven) is covered by the classifications of truck driver.

# Montgomery County Prevailing Wage for April 2007

Trade Name	RG	TYP	C	Base	FRMAN	*M-F>8	OSA	OSH	H/W	Pensn	Vac	Trng
=====	==	==	=	=====	=====	=====	==	==	=====	=====	=====	=====
ASBESTOS ABT-GEN		ALL		21.450	21.950	1.5	1.5	2.0	5.050	9.550	0.000	0.600
ASBESTOS ABT-MEC		BLD		25.290	26.290	1.5	1.5	2.0	4.450	2.500	0.000	0.250
BOILERMAKER		BLD		28.500	31.000	1.5	1.5	2.0	6.820	11.03	0.000	0.300
BRICK MASON		BLD		26.400	28.100	1.5	1.5	5.0	4.750	8.250	2.000	0.390
CARPENTER	N	BLD		25.910	27.910	1.5	1.5	2.0	6.500	6.480	0.000	0.320
CARPENTER	N	HWY		25.750	27.500	1.5	1.5	2.0	6.500	6.500	0.000	0.300
CARPENTER	S	BLD		24.520	26.520	1.5	1.5	2.0	6.500	7.870	0.000	0.320
CARPENTER	S	HWY		25.050	26.800	1.5	1.5	2.0	6.500	7.200	0.000	0.300
CEMENT MASON		ALL		26.750	27.500	1.5	1.5	2.0	5.650	8.250	0.000	0.200
CERAMIC TILE FNSHER		BLD		22.610	0.000	1.5	1.5	2.0	5.000	4.300	0.000	0.400
ELECTRIC PWR EQMT OP	NE	ALL		30.750	0.000	1.5	1.5	2.0	4.750	8.610	0.000	0.000
ELECTRIC PWR EQMT OP	SW	ALL		31.510	37.980	1.5	2.0	2.0	4.530	7.880	0.000	0.160
ELECTRIC PWR GRNDMAN	NE	ALL		21.090	0.000	1.5	1.5	2.0	4.750	5.905	0.000	0.000
ELECTRIC PWR GRNDMAN	SW	ALL		23.530	37.980	1.5	2.0	2.0	3.380	5.890	0.000	0.120
ELECTRIC PWR LINEMAN	NE	ALL		34.160	36.350	1.5	1.5	2.0	4.750	9.560	0.000	0.000
ELECTRIC PWR LINEMAN	SW	ALL		36.220	37.980	1.5	2.0	2.0	5.210	9.060	0.000	0.180
ELECTRIC PWR TRK DRV	NE	ALL		22.130	0.000	1.5	1.5	2.0	4.750	6.200	0.000	0.000
ELECTRIC PWR TRK DRV	SW	ALL		25.710	37.980	1.5	2.0	2.0	3.700	6.430	0.000	0.130
ELECTRICIAN	E	BLD		29.480	32.420	1.5	1.5	2.0	5.150	5.300	0.000	0.440
ELECTRICIAN	NW	BLD		31.220	33.220	1.5	1.5	2.0	5.150	5.340	0.000	0.300
ELECTRICIAN	SW	ALL		32.590	34.550	1.5	1.5	2.0	5.210	6.360	0.000	0.490
ELECTRONIC SYS TECH	E	BLD		24.370	25.870	1.5	1.5	2.0	5.150	3.650	0.000	0.250
ELECTRONIC SYS TECH	W	BLD		25.810	27.310	1.5	1.5	2.0	2.800	5.490	0.000	0.250
ELEVATOR CONSTRUCTOR		BLD		37.115	41.750	2.0	2.0	2.0	8.275	4.460	2.227	0.000
GLAZIER		BLD		27.130	28.130	1.5	2.0	2.0	5.430	4.000	0.000	0.280
HT/FROST INSULATOR		BLD		30.440	31.440	1.5	1.5	2.0	4.850	8.360	0.000	0.450
IRON WORKER	N	BLD		25.400	27.150	1.5	1.5	2.0	5.860	7.900	0.000	0.300
IRON WORKER	N	HWY		25.400	26.900	1.5	1.5	2.0	5.860	7.900	0.000	0.300
IRON WORKER	S	ALL		26.350	27.850	1.5	1.5	2.0	6.360	8.250	0.000	0.420
LABORER		ALL		20.950	21.450	1.5	1.5	2.0	5.050	9.550	0.000	0.600
LATHER		BLD		25.910	27.910	1.5	1.5	2.0	6.500	6.480	0.000	0.320
MACHINIST		BLD		36.890	38.890	2.0	2.0	2.0	4.380	5.650	2.550	0.000
MARBLE FINISHERS		BLD		22.610	0.000	1.5	1.5	2.0	5.000	4.300	0.000	0.400
MILLWRIGHT		BLD		26.000	28.000	1.5	1.5	2.0	6.500	6.850	0.000	0.320
MILLWRIGHT		HWY		19.270	20.520	1.5	1.5	2.0	2.800	3.000	0.000	0.000
OPERATING ENGINEER		ALL	1	25.900	27.030	1.5	1.5	2.0	6.200	11.45	0.000	1.000
OPERATING ENGINEER		ALL	2	24.770	27.030	1.5	1.5	2.0	6.200	11.45	0.000	1.000
OPERATING ENGINEER		ALL	3	20.290	27.030	1.5	1.5	2.0	6.200	11.45	0.000	1.000
OPERATING ENGINEER		ALL	4	20.350	27.030	1.5	1.5	2.0	6.200	11.45	0.000	1.000
OPERATING ENGINEER		ALL	5	20.020	27.030	1.5	1.5	2.0	6.200	11.45	0.000	1.000
OPERATING ENGINEER		ALL	6	26.450	27.030	1.5	1.5	2.0	6.200	11.45	0.000	1.000
OPERATING ENGINEER		ALL	7	26.750	27.030	1.5	1.5	2.0	6.200	11.45	0.000	1.000
OPERATING ENGINEER		ALL	8	27.030	27.030	1.5	1.5	2.0	6.200	11.45	0.000	1.000
PAINTER		BLD		25.700	26.700	1.5	1.5	2.0	4.650	5.150	0.000	0.350
PAINTER		HWY		26.800	27.800	1.5	1.5	2.0	4.650	5.150	0.000	0.350
PAINTER OVER 30FT		BLD		26.700	27.700	1.5	1.5	2.0	4.650	5.150	0.000	0.350
PAINTER PWR EQMT		BLD		26.700	27.700	1.5	1.5	2.0	4.650	5.150	0.000	0.350
PAINTER PWR EQMT		HWY		27.800	28.800	1.5	1.5	2.0	4.650	5.150	0.000	0.350
PILEDRIVER	N	BLD		26.410	28.410	1.5	1.5	2.0	6.500	6.480	0.000	0.320
PILEDRIVER	N	HWY		26.250	28.000	1.5	1.5	2.0	6.500	6.500	0.000	0.300
PILEDRIVER	S	BLD		25.020	27.020	1.5	1.5	2.0	6.500	7.870	0.000	0.320
PILEDRIVER	S	HWY		25.550	27.300	1.5	1.5	2.0	6.500	7.200	0.000	0.300
PIPEFITTER	NE	BLD		34.700	37.200	1.5	1.5	2.0	6.450	4.750	0.000	0.350
PIPEFITTER	SW	BLD		30.600	32.100	2.0	2.0	2.0	5.350	6.100	0.000	0.130
PLASTERER		BLD		27.000	28.000	1.5	1.5	2.0	5.650	7.250	0.000	0.250
PLUMBER	NE	BLD		34.700	37.200	1.5	1.5	2.0	6.450	4.750	0.000	0.350
PLUMBER	SW	BLD		30.600	32.100	2.0	2.0	2.0	5.350	6.100	0.000	0.130
ROOFER		BLD		24.310	26.740	1.5	1.5	2.0	4.650	5.250	0.000	0.100



SHEETMETAL WORKER	ALL	27.210	28.460	1.5	1.5	2.0	6.000	4.770	1.630	0.120
SPRINKLER FITTER	BLD	31.240	33.240	1.5	1.5	2.0	6.500	5.350	0.000	0.250
TERRAZZO FINISHER	BLD	31.240	0.000	1.5	1.5	2.0	0.000	0.000	0.000	0.000
TERRAZZO MASON	BLD	30.780	31.080	1.5	1.5	2.0	0.000	3.750	0.000	0.000
TRUCK DRIVER	ALL 1	25.930	0.000	1.5	1.5	2.0	7.250	3.425	0.000	0.000
TRUCK DRIVER	ALL 2	26.330	0.000	1.5	1.5	2.0	7.250	3.425	0.000	0.000
TRUCK DRIVER	ALL 3	26.530	0.000	1.5	1.5	2.0	7.250	3.425	0.000	0.000
TRUCK DRIVER	ALL 4	26.780	0.000	1.5	1.5	2.0	7.250	3.425	0.000	0.000
TRUCK DRIVER	ALL 5	27.530	0.000	1.5	1.5	2.0	7.250	3.425	0.000	0.000
TRUCK DRIVER	O&C 1	20.740	0.000	1.5	1.5	2.0	7.250	3.425	0.000	0.000
TRUCK DRIVER	O&C 2	21.060	0.000	1.5	1.5	2.0	7.250	3.425	0.000	0.000
TRUCK DRIVER	O&C 3	21.220	0.000	1.5	1.5	2.0	7.250	3.425	0.000	0.000
TRUCK DRIVER	O&C 4	21.420	0.000	1.5	1.5	2.0	7.250	3.425	0.000	0.000
TRUCK DRIVER	O&C 5	22.020	0.000	1.5	1.5	2.0	7.250	3.425	0.000	0.000

Legend:

M-F>8 (Overtime is required for any hour greater than 8 worked each day, Monday through Friday.)

OSA (Overtime is required for every hour worked on Saturday)

OSH (Overtime is required for every hour worked on Sunday and Holidays)

H/W (Health & Welfare Insurance)

Pensn (Pension)

Vac (Vacation)

Trng (Training)

## Explanations

### MONTGOMERY COUNTY

CARPENTERS AND PILEDRIVERS (NORTH) - The area north of Route 108, running east to Route 55, then north to Routes 48/127, east following Route 48 from Raymond to Harvel.

ELECTRICIANS (EAST) - Townships of Audubon, East Fork, Fillmore, Irving, Nikomis, Roundtree, South Fillmore and Witt.

ELECTRICIANS (NW) - Townships of Bois D'Arc, Pitman, and Harvel (Northern projection).

ELECTRICIANS (SW) - Townships of Zanesville, Raymond, North and South Litchfield, Butler Grove, Hillsboro, Walshville and Grishman.

ELECTRIC POWER LINEMAN, GROUNDMAN, EQUIPMENT OPERATOR, TRUCK DRIVER (NE) - Entire county except Butler Grove, Grisham, Hillsboro, North and South Litchfield, Raymond, Walshville, and Zanesville Townships.

IRONWORKERS (NORTH) - That part of the county north of a diagonal line through Taylor Springs and Chapman.

PLUMBERS & PIPEFITTERS (SW) - That part of the county South and West of Route 127.

ELECTRONIC SYSTEMS TECHNICIAN (WEST) - Townships of Zanesville,

Raymond, North Litchfield, Butler Grove, South Litchfield, Hillsboro, Walshville and Grisham.

The following list is considered as those days for which holiday rates of wages for work performed apply: New Years Day, Memorial/Decoration Day, Fourth of July, Labor Day, Veterans Day, Thanksgiving Day, Christmas Day. Generally, any of these holidays which fall on a Sunday is celebrated on the following Monday. This then makes work performed on that Monday payable at the appropriate overtime rate for holiday pay. Common practice in a given local may alter certain days of celebration such as the day after Thanksgiving for Veterans Day. If in doubt, please check with IDOL.

Oil and chip resealing (O&C) means the application of road oils and liquid asphalt to coat an existing road surface, followed by application of aggregate chips or gravel to coated surface, and subsequent rolling of material to seal the surface.

#### EXPLANATION OF CLASSES

ASBESTOS - GENERAL - removal of asbestos material/mold and hazardous materials from any place in a building, including mechanical systems where those mechanical systems are to be removed. This includes the removal of asbestos materials/mold and hazardous materials from ductwork or pipes in a building when the building is to be demolished at the time or at some close future date.

ASBESTOS - MECHANICAL - removal of asbestos material from mechanical systems, such as pipes, ducts, and boilers, where the mechanical systems are to remain.

#### CERAMIC TILE FINISHER AND MARBLE FINISHER

The handling, at the building site, of all sand, cement, tile, marble or stone and all other materials that may be used and installed by [a] tile layer or marble mason. In addition, the grouting, cleaning, sealing, and mixing on the job site, and all other work as required in assisting the setter. The term "Ceramic" is used for naming the classification only and is in no way a limitation of the product handled. Ceramic takes into consideration most hard tiles.

#### ELECTRONIC SYSTEMS ELECTRICIAN

Installation, service and maintenance of low-voltage systems which utilizes the transmission and/or transference of voice, sound, vision, or digital for commercial, education, security and entertainment purposes for the following: TV monitoring and surveillance, background/foreground music, intercom and telephone interconnect, field programming, inventory control systems, microwave transmission, multi-media, multiplex, radio page, school, intercom and sound burglar alarms and low voltage master clock systems.

Excluded from this classification are energy management systems, life safety systems, supervisory controls and data acquisition systems not intrinsic with the above listed systems, fire alarm systems, nurse call systems and raceways exceeding fifteen feet in length.

#### TRUCK DRIVER - BUILDING, HEAVY AND HIGHWAY CONSTRUCTION

Class 1. Drivers on 2 axle trucks hauling less than 9 ton. Air compressor and welding machines and brooms, including those pulled by separate units, truck driver helpers, warehouse employees, mechanic helpers, greasers and tiremen, pickup trucks when hauling materials, tools, or workers to and from and on-the-job site, and fork lifts up

to 6,000 lb. capacity.

Class 2. Two or three axle trucks hauling more than 9 ton but hauling less than 16 ton. A-frame winch trucks, hydrolift trucks, vactor trucks or similar equipment when used for transportation purposes. Fork lifts over 6,000 lb. capacity, winch trucks, four axle combination units, and ticket writers.

Class 3. Two, three or four axle trucks hauling 16 ton or more. Drivers on water pulls, articulated dump trucks, mechanics and working forepersons, and dispatchers. Five axle or more combination units.

Class 4. Low Boy and Oil Distributors.

Class 5. Drivers who require special protective clothing while employed on hazardous waste work.

TRUCK DRIVER - OIL AND CHIP RESEALING ONLY.

This shall encompass laborers, workers and mechanics who drive contractor or subcontractor owned, leased, or hired pickup, dump, service, or oil distributor trucks. The work includes transporting materials and equipment (including but not limited to, oils, aggregate supplies, parts, machinery and tools) to or from the job site; distributing oil or liquid asphalt and aggregate; stock piling material when in connection with the actual oil and chip contract. The Truck Driver (Oil & Chip Resealing) wage classification does not include supplier delivered materials.

#### OPERATING ENGINEERS

GROUP I. Cranes, Dragline, Shovels, Skimmer Scoops, Clamshells or Derrick Boats, Pile Drivers, Crane-Type Backhoes, Asphalt Plant Operators, Concrete Plant Operators, Dredges, Asphalt Spreading Machines, All Locomotives, Cable Ways, or Tower Machines, Hoists, Hydraulic Backhoes, Ditching Machines or Backfiller, Cherrypickers, Overhead Cranes, Roller, Steam or Gas, Concrete Pavers, Excavators, Concrete Breakers, Concrete Pumps, Bulk Cement Plants, Cement Pumps, Derrick-Type Drills, Boat Operators, Motor Graders or Pushcats, Scoops or Tournapulls, Bulldozers, Endloaders or Fork Lifts, Power Blade or Elevating Graders, Winch Cats, Boom or Winch Trucks or Boom Tractors, Pipe Wrapping or Painting Machines, Asphalt Plant Engineer, Journeyman Lubricating Engineer, Drills (other than Derrick Type), Mud Jacks, or Well Drilling Machines, Boring Machines or Track Jacks, Mixers, Conveyors (Two), Air Compressors (Two), Water Pumps regardless of size (Two), Welding Machines (Two), Siphons or Jets (Two), Winch Heads or Apparatuses (Two), Light Plants (Two), Waterblasters (two), All Tractors regardless of size (straight tractor only), Fireman on Stationary Boilers, Automatic Elevators, Form Grading Machines, Finishing Machines, Power Sub-Grader or Ribbon Machines, Longitudinal Floats, Distributor Operators on Trucks, Winch Heads or Apparatuses (One), Mobil Track air and heaters (two to five), Heavy Equipment Greaser, Relief Operator, Assistant Master Mechanic and Heavy Duty Mechanic, all Operators (except those listed below).

GROUP II. Assistant Operators.

GROUP III. Air Compressors (One), Water Pumps, regardless of Size (One), Waterblasters (one), Welding Machine (One), Mixers (One Bag), Conveyor (One), Siphon or Jet (One), Light Plant (One), Heater (One), Immobile Track Air (One), and Self Propelled Walk-Behind Rollers.

GROUP IV. Asphalt Spreader Oilers, Fireman on Whirlies and Heavy

Equipment Oilers, Truck Cranes, Dredges, Monigans, Large Cranes - (Over 65-ton rated capacity) Concrete Plant Oiler, Blacktop Plant Oiler, and Creter Crane Oiler (when required).

GROUP V. Oiler.

GROUP VI. Master Mechanics, Operators on equipment with Booms, including jibs, 100 feet and over, and less than 150 feet long.

GROUP VII. Operators on equipment with Booms, including jibs, 150 feet and over, and less than 200 feet long.

GROUP VIII. Operators on Equipment with Booms, including jibs, 200 feet and over; Tower Cranes; Whirlie Cranes; and Operator Foreman.

#### TERRAZZO FINISHER

The handling of all materials used for Mosaic and Terrazzo work including preparing, mixing by hand, by mixing machine or transporting of pre-mixed materials and distributing with shovel, rake, hoe, or pail, all kinds of concrete foundations necessary for Mosaic and Terrazzo work, all cement terrazzo, magnesite terrazzo, Do-O-Tex terrazzo, epoxy matrix ter-razzo, exposed aggregate, rustic or rough washed for exterior or interior of buildings placed either by machine or by hand, and any other kind of mixture of plastics composed of chips or granules when mixed with cement, rubber, neoprene, vinyl, magnesium chloride or any other resinous or chemical substances used for seamless flooring systems, and all other building materials, all similar materials and all precast terrazzo work on jobs, all scratch coat used for Mosaic and Terrazzo work and sub-bed, tar paper and wire mesh (2x2 etc.) or lath. The rubbing, grinding, cleaning and finishing of same either by hand or by machine or by terrazzo resurfacing equipment on new or existing floors. When necessary finishers shall be allowed to assist the mechanics to spread sand bed, lay tarpaper and wire mesh (2x2 etc.) or lath. The finishing of cement floors where additional aggregate of stone is added by spreading or sprinkling on top of the finished base, and troweled or rolled into the finish and then the surface is ground by grinding machines.

#### Other Classifications of Work:

For definitions of classifications not otherwise set out, the Department generally has on file such definitions which are available. If a task to be performed is not subject to one of the classifications of pay set out, the Department will upon being contacted state which neighboring county has such a classification and provide such rate, such rate being deemed to exist by reference in this document. If no neighboring county rate applies to the task, the Department shall undertake a special determination, such special determination being then deemed to have existed under this determination. If a project requires these, or any classification not listed, please contact IDOL at 217/782/1710 for wage rates or clarifications.

#### LANDSCAPING

Landscaping work falls under the existing classifications for laborer, operating engineer and truck driver. The work performed by landscape plantsman and landscape laborer is covered by the existing classification of laborer. The work performed by landscape operators (regardless of equipment used or its size) is covered by the

classifications of operating engineer. The work performed by landscape truck drivers (regardless of size of truck driven) is covered by the classifications of truck driver.

# Morgan County Prevailing Wage for April 2007

Trade Name	RG	TYP	C	Base	FRMAN	*M-F>8	OSA	OSH	H/W	Pensn	Vac	Trng
=====	==	==	=	=====	=====	=====	==	==	=====	=====	=====	=====
ASBESTOS ABT-GEN		BLD		23.210	24.210	1.5	1.5	2.0	5.050	5.330	0.000	0.700
ASBESTOS ABT-MEC		BLD		25.290	26.290	1.5	1.5	2.0	4.450	2.500	0.000	0.250
BOILERMAKER		BLD		28.500	31.000	1.5	1.5	2.0	6.820	11.03	0.000	0.300
BRICK MASON		BLD		24.370	25.370	1.5	1.5	2.0	6.000	5.400	0.000	0.490
CARPENTER		BLD		24.490	26.490	1.5	1.5	2.0	6.500	7.900	0.000	0.320
CARPENTER		HWY		24.250	26.000	1.5	1.5	2.0	6.500	7.800	0.000	0.300
CEMENT MASON		BLD		24.470	25.570	2.0	2.0	2.0	6.000	5.400	0.000	0.490
CEMENT MASON		HWY		24.020	25.020	1.5	1.5	2.0	6.000	4.900	0.000	0.000
CERAMIC TILE FNSHER		BLD		23.020	0.000	1.5	1.5	2.0	6.000	5.400	0.000	0.000
ELECTRIC PWR EQMT OP		ALL		30.750	0.000	1.5	1.5	2.0	4.750	8.610	0.000	0.000
ELECTRIC PWR GRNDMAN		ALL		21.090	0.000	1.5	1.5	2.0	4.750	5.905	0.000	0.000
ELECTRIC PWR LINEMAN		ALL		34.160	36.350	1.5	1.5	2.0	4.750	9.560	0.000	0.000
ELECTRIC PWR TRK DRV		ALL		22.130	0.000	1.5	1.5	2.0	4.750	6.200	0.000	0.000
ELECTRICIAN		BLD		31.220	33.220	1.5	1.5	2.0	5.150	5.340	0.000	0.300
ELECTRONIC SYS TECH		BLD		24.830	26.330	1.5	1.5	2.0	5.150	3.190	0.000	0.250
ELEVATOR CONSTRUCTOR		BLD		34.190	38.460	2.0	2.0	2.0	8.275	6.060	2.050	0.000
GLAZIER		BLD		27.130	28.130	1.5	2.0	2.0	5.430	4.000	0.000	0.280
HT/FROST INSULATOR		BLD		30.440	31.440	1.5	1.5	2.0	4.850	8.360	0.000	0.450
IRON WORKER		BLD		25.400	27.150	1.5	1.5	2.0	5.860	7.900	0.000	0.300
IRON WORKER		HWY		25.400	26.900	1.5	1.5	2.0	5.860	7.900	0.000	0.300
LABORER		BLD		21.710	22.710	1.5	1.5	2.0	5.050	5.330	0.000	0.600
LABORER		HWY		22.680	23.430	1.5	1.5	2.0	5.050	5.330	0.000	0.600
LATHER		BLD		24.490	26.490	1.5	1.5	2.0	6.500	7.900	0.000	0.320
MACHINIST		BLD		36.890	38.890	2.0	2.0	2.0	4.380	5.650	2.550	0.000
MARBLE FINISHERS		BLD		23.020	0.000	1.5	1.5	2.0	6.000	5.400	0.000	0.000
MARBLE MASON		BLD		24.520	25.270	1.5	1.5	2.0	6.000	5.400	0.000	0.000
MILLWRIGHT		BLD		26.000	28.000	1.5	1.5	2.0	6.500	6.850	0.000	0.320
MILLWRIGHT		HWY		19.070	20.320	1.5	1.5	2.0	2.800	3.000	0.000	0.000
OPERATING ENGINEER		BLD	1	26.550	0.000	1.5	1.5	2.0	6.150	6.200	0.000	0.850
OPERATING ENGINEER		BLD	2	24.200	0.000	1.5	1.5	2.0	6.150	6.200	0.000	0.850
OPERATING ENGINEER		BLD	3	20.600	0.000	1.5	1.5	2.0	6.150	6.200	0.000	0.850
OPERATING ENGINEER		BLD	4	28.050	0.000	1.5	1.5	2.0	6.150	6.200	0.000	0.850
OPERATING ENGINEER		HWY	1	26.800	0.000	1.5	1.5	2.0	6.150	6.200	0.000	0.850
OPERATING ENGINEER		HWY	2	24.030	0.000	1.5	1.5	2.0	6.150	6.200	0.000	0.850
OPERATING ENGINEER		HWY	3	19.800	0.000	1.5	1.5	2.0	6.150	6.200	0.000	0.850
OPERATING ENGINEER		HWY	4	28.300	0.000	1.5	1.5	2.0	6.150	6.200	0.000	0.850
PAINTER		ALL		25.390	26.390	1.5	1.5	2.0	4.650	5.500	0.000	0.250
PAINTER OVER 30FT		ALL		26.390	27.390	1.5	1.5	2.0	4.650	5.500	0.000	0.250
PAINTER PWR EQMT		ALL		26.390	27.390	1.5	1.5	2.0	4.650	5.500	0.000	0.250
PILEDRIVER		BLD		24.990	26.990	1.5	1.5	2.0	6.500	7.900	0.000	0.320
PILEDRIVER		HWY		24.750	26.500	1.5	1.5	2.0	6.500	7.800	0.000	0.300
PIPEFITTER		BLD		34.700	37.200	1.5	1.5	2.0	6.450	4.750	0.000	0.350
PLASTERER		BLD		24.470	25.570	2.0	2.0	2.0	6.000	5.400	0.000	0.490
PLUMBER		BLD		34.700	37.200	1.5	1.5	2.0	6.450	4.750	0.000	0.350
ROOFER		BLD		24.310	26.740	1.5	1.5	2.0	4.650	5.250	0.000	0.100
SHEETMETAL WORKER		BLD		27.820	29.570	1.5	1.5	2.0	7.150	7.880	0.000	0.350
SPRINKLER FITTER		BLD		31.240	33.240	1.5	1.5	2.0	6.500	5.350	0.000	0.250
STONE MASON		BLD		24.370	25.370	1.5	1.5	2.0	6.000	5.400	0.000	0.490
TERRAZZO FINISHER		BLD		23.020	0.000	1.5	1.5	2.0	6.000	5.400	0.000	0.000
TERRAZZO MASON		BLD		24.520	25.270	1.5	1.5	2.0	6.000	5.400	0.000	0.000
TILE MASON		BLD		24.520	25.270	1.5	1.5	2.0	6.000	5.400	0.000	0.000
TRUCK DRIVER		ALL	1	25.930	0.000	1.5	1.5	2.0	7.250	3.425	0.000	0.000
TRUCK DRIVER		ALL	2	26.330	0.000	1.5	1.5	2.0	7.250	3.425	0.000	0.000
TRUCK DRIVER		ALL	3	26.530	0.000	1.5	1.5	2.0	7.250	3.425	0.000	0.000
TRUCK DRIVER		ALL	4	26.780	0.000	1.5	1.5	2.0	7.250	3.425	0.000	0.000
TRUCK DRIVER		ALL	5	27.530	0.000	1.5	1.5	2.0	7.250	3.425	0.000	0.000
TRUCK DRIVER		O&C	1	20.740	0.000	1.5	1.5	2.0	7.250	3.425	0.000	0.000
TRUCK DRIVER		O&C	2	21.060	0.000	1.5	1.5	2.0	7.250	3.425	0.000	0.000

TRUCK DRIVER	O&C 3	21.220	0.000	1.5	1.5	2.0	7.250	3.425	0.000	0.000
TRUCK DRIVER	O&C 4	21.420	0.000	1.5	1.5	2.0	7.250	3.425	0.000	0.000
TRUCK DRIVER	O&C 5	22.020	0.000	1.5	1.5	2.0	7.250	3.425	0.000	0.000
TUCKPOINTER	BLD	24.370	25.370	1.5	1.5	2.0	6.000	5.400	0.000	0.490

Legend:

M-F>8 (Overtime is required for any hour greater than 8 worked each day, Monday through Friday.)

OSA (Overtime is required for every hour worked on Saturday)

OSH (Overtime is required for every hour worked on Sunday and Holidays)

H/W (Health & Welfare Insurance)

Pensn (Pension)

Vac (Vacation)

Trng (Training)

## Explanations

### MORGAN COUNTY

The following list is considered as those days for which holiday rates of wages for work performed apply: New Years Day, Memorial/Decoration Day, Fourth of July, Labor Day, Veterans Day, Thanksgiving Day, Christmas Day. Generally, any of these holidays which fall on a Sunday is celebrated on the following Monday. This then makes work performed on that Monday payable at the appropriate overtime rate for holiday pay. Common practice in a given local may alter certain days of celebration such as the day after Thanksgiving for Veterans Day. If in doubt, please check with IDOL.

Oil and chip resealing (O&C) means the application of road oils and liquid asphalt to coat an existing road surface, followed by application of aggregate chips or gravel to coated surface, and subsequent rolling of material to seal the surface.

### EXPLANATION OF CLASSES

ASBESTOS - GENERAL - removal of asbestos material/mold and hazardous materials from any place in a building, including mechanical systems where those mechanical systems are to be removed. This includes the removal of asbestos materials/mold and hazardous materials from ductwork or pipes in a building when the building is to be demolished at the time or at some close future date.

ASBESTOS - MECHANICAL - removal of asbestos material from mechanical systems, such as pipes, ducts, and boilers, where the mechanical systems are to remain.

### CERAMIC TILE FINISHER, MARBLE FINISHER, TERRAZZO FINISHER

Assisting, helping or supporting the tile, marble and terrazzo mechanic by performing their historic and traditional work assignments required to complete the proper installation of the work covered by said crafts. The term "Ceramic" is used for naming the classification

only and is in no way a limitation of the product handled. Ceramic takes into consideration most hard tiles.

#### ELECTRONIC SYSTEMS TECHNICIAN

Installation, service and maintenance of low-voltage systems which utilizes the transmission and/or transference of voice, sound, vision, or digital for commercial, education, security and entertainment purposes for the following: TV monitoring and surveillance, background/foreground music, intercom and telephone interconnect, field programming, inventory control systems, microwave transmission, multi-media, multiplex, radio page, school, intercom and sound burglar alarms and low voltage master clock systems.

Excluded from this classification are energy management systems, life safety systems, supervisory controls and data acquisition systems not intrinsic with the above listed systems, fire alarm systems, nurse call systems and raceways exceeding fifteen feet in length.

#### TRUCK DRIVER - BUILDING, HEAVY AND HIGHWAY CONSTRUCTION

Class 1. Drivers on 2 axle trucks hauling less than 9 ton. Air compressor and welding machines and brooms, including those pulled by separate units, truck driver helpers, warehouse employees, mechanic helpers, greasers and tiremen, pickup trucks when hauling materials, tools, or workers to and from and on-the-job site, and fork lifts up to 6,000 lb. capacity.

Class 2. Two or three axle trucks hauling more than 9 ton but hauling less than 16 ton. A-frame winch trucks, hydrolift trucks, vector trucks or similar equipment when used for transportation purposes. Fork lifts over 6,000 lb. capacity, winch trucks, four axle combination units, and ticket writers.

Class 3. Two, three or four axle trucks hauling 16 ton or more. Drivers on water pulls, articulated dump trucks, mechanics and working forepersons, and dispatchers. Five axle or more combination units.

Class 4. Low Boy and Oil Distributors.

Class 5. Drivers who require special protective clothing while employed on hazardous waste work.

#### TRUCK DRIVER - OIL AND CHIP RESEALING ONLY.

This shall encompass laborers, workers and mechanics who drive contractor or subcontractor owned, leased, or hired pickup, dump, service, or oil distributor trucks. The work includes transporting materials and equipment (including but not limited to, oils, aggregate supplies, parts, machinery and tools) to or from the job site; distributing oil or liquid asphalt and aggregate; stock piling material when in connection with the actual oil and chip contract. The Truck Driver (Oil & Chip Resealing) wage classification does not include supplier delivered materials.

#### OPERATING ENGINEERS - BUILDING

CLASS 1. Asphalt Screed Man; Aspco Concrete Spreaders; Asphalt Pavers; Asphalt Plant Engineer; Asphalt Rollers on Bituminous Concrete; Athey Loaders; Backfillers, Crane Type; Backhoes; Barber Green Loaders; Bulldozers; Cableways; Cherry Pickers; Clam Shells; C.M.I. & similar type autograde formless paver, autograde placer & finisher; Concrete Breakers; Concrete Pumps; Derricks; Derrick Boats; Draglines; Earth Auger or Boring Machines; Elevating Graders;



Engineers on Dredges; Gravel Processing Machines; Head Equipment Greaser; High Lifts or Fork Lifts; Hoists with two or more drums or two or more load lines; Locomotives, All; Mechanics; Motor Graders or Auto Patrols; Operators or Leverman on Dredges; Operators, Power Boat; Operators, Pug Mill (Asphalt Plants); Orange Peels; Overhead Cranes; Paving Mixers; Piledrivers; Pipe Wrapping and Painting Machines; Pushdozers, or Push Cats; Robotic Controlled Equipment in this Classification; Rock Crushers; Ross Carrier or Similar Machines; Rotomill; Scoops, Skimmer, two cu. yd. capacity and under; Scoops, All or Tournapull; Sheep-Foot Roller (Self Propelled); Shovels; Skid Steer; Skimmer Scoops; Temporary Concrete Plant Operators; Test Hole Drilling Machines; Tower Machines; Tower Mixers; Track Type End Loaders; Track Type Fork Lifts or High Lifts; Track Jacks and Tampers; Tractors, Sideboom; Trenching or Ditching Machine; Tunnelluggers; Vermeer Type Saws; Water Blaster Cutting Head; Wheel Type End Loaders; Winch Cat.

CLASS 2. Air Compressors (six to eight)\*; Asphalt Boosters and Heaters; Asphalt Distributors; Asphalt Plant Fireman; Oiler on Two Paving Mixers When Used in Tandem; Boom or Winch Trucks; Bull Floats or Flexplanes; Concrete Finishing Machine; Concrete Saws, Self-Propelled; Concrete Spreading Machines; Conveyors (six to eight)\*; Generators (six to eight)\*; Gravel or Stone Spreader, Power Operated; Hoist (with One Drum and One Load Line); Light Plants (six to eight)\*; Mechanical Heaters (six to eight)\*; Mud Jacks; Post Hole Digger, Mechanical; Pug Mills when used for other than Asphalt operation; Robotic Controlled Equipment in this Classification; Road or Street Sweeper, Self Propelled; Rollers (except bituminous concrete); Seaman Tiller; Straw Machine; Vibratory Compactor; Water Blaster, Power Unit; Welding Machines (six to eight)\*; Well Drill Machines.

CLASS 3. Air Compressors(one to five)\*; Air Compressors, Track or Self-Propelled; Automatic Hoist; Building Elevators; Bulk Cement Batching Plants; Conveyors (one to five)\*; Concrete Mixers (Except Plant, Paver, or Tower); Firemen; Generators (one to five)\*; Greasers; Helper on Single Paving Mixer; Hoist, Automatic; Light Plants (one to five)\*; Mechanic Helpers; Mechanical Heaters (one to five)\*; Oilers; Power Form Graders; Power Sub-Graders; Robotic Controlled Equipment in this Classification; Scissors Hoist; Tractors without power attachments regardless of size or type; Truck Crane Oiler and Driver (1 man); Vibratory Hammer (power source); Water Pumps (one to five)\*; Welding Machines (1/300 Amp. or over)\*; Welding machines (one to five)\*

CLASS 4. Lattice Boom Crawler Cranes; Lattice Boom Truck Cranes; Telescopic Truck-Mounted Cranes; Tower Cranes.

\* Combinations of one to eight of any Air Compressors, Conveyors, Welding Machines, Water Pumps, Light Plants, or Generators shall be in batteries or within 400 feet and shall be paid as per the Classification Schedule contained in this Article.

#### OPERATING ENGINEERS - HIGHWAY

CLASS 1. Asphalt Screed Man; Asphco Concrete Spreaders; Asphalt Pavers; Asphalt Plant Engineer; Asphalt Rollers on Bituminous Concrete; Athey Loaders; Backhoes; Barber Green Loaders; Bulldozers; Cableways; Carry Deck Pickers; Cherry Pickers (Rough Terrain); C.M.I. & similar type-autograde formless paver, autograde placer & finisher; Concrete Breakers; Concrete Plant Operators; Concrete Pumps; Derricks; Derrick Boats; Dewatering Systems; Earth Auger or Boring Machines; Elevating Graders; Engineers on Dredges; Gravel Processing Machines;

Grout Pump; Head Equipment Greaser; High Lifts or Fork Lifts; Hoists with two or more drums or two or more load lines; Hydro Jet or Hydro Laser; Locomotives, All; Mechanics; Motor Graders or Auto Patrols; Multi-Point Power Lifting Equipment; Operators or Leverman on Dredges; Operators, Power Boat; Operators, Pug Mill (Asphalt Plants); Overhead Cranes; Paving Mixers; Piledrivers; Pipe Wrapping and Painting Machines; Push-dozers, or Push Cats; Robotic Controlled Equipment in this Classification; Rock Crushers; Ross Carrier or Similar Machines; Roto-Mill; Scoops, Skimmer, two cu. yd. capacity and under; Sheep-Foot Roller (Self Pro-pelled); Shovels; Skid Steer; Skimmer Scoops; Test Hole Drilling Machines; Tower Machines; Tower Mixers; Track Type End Loaders; Track Type Fork Lifts or High Lifts; Track Jacks and Tampers; Tractors, Side-boom; Trenching or Ditching Machine; Tunnelluggers; Vermeer-Type Saws; Wheel Type End Loaders; Winch Cat; Scoops, All or Tournapull.

CLASS 2. Air Compressors (six to eight)\*; Articulated Dumps; Asphalt Boosters and Heaters; Asphalt Distributors; Asphalt Plant Fireman; Boom or Winch Trucks; Building Elevators; Bull Floats or Flexplanes; Concrete Finishing Machine; Concrete Saws, Self-Propelled; Concrete Spreading Machines; Conveyors (six to eight)\*; Generators (six to eight)\*; Gravel or Stone Spreader, Power Operated; Hoist, Automatic; Hoist with One Drum and One Load Line; Light Plants (six to eight)\*; Mechanical Heaters (six to eight)\*; Mud Jacks; Off Road Water Wagons; Oiler on Two Paving Mixers When Used in Tandem; Post Hole Digger, Mechanical; Robotic Controlled Equipment in This Classification; Road or Street Sweeper, Self-Propelled; Rollers (except bituminous concrete); Scissor Hoist; Sea-man Tiller; Straw Machine; Vibratory Compactor; Water Pumps (six to eight)\*; Well Drill Machines.

CLASS 3. Air Compressors (one to five)\*; Air Compressors, Track or Self-Propelled; Bulk Cement Batching Plants; Conveyors (one to five)\*; Concrete Mixers (Except Plant, Paver, or Tower); Firemen; Generators (one to five)\*; Greasers; Helper on Single Paving Mixer; Light Plants (one to five)\*; Mechanic Helpers; Mechanical Heaters (one to five)\*; Oilers; Power Form Graders; Power Sub-Graders; Pug Mills when used for other than Asphalt operation; Robotic Controlled Equipment in This Classification; Tractors without power attachments, regardless of size or type; Truck Crane Oiler and Driver (1 man); Vibratory Hammer (power source); Water Pumps (one to five)\*; Welding Machines (one 300 Amp. or over)\*; Welding Machines (one to five)\*.

CLASS 4. Lattice Boom Crawler Crane; Lattice Boom Truck Crane; Telescopic Truck-Mounted Crane; Tower Crane.

\*Combinations of one to eight of any Air Compressors, Conveyors, Welding Machines, Water Pumps, Light Plants or Generators shall be in batteries or within 400 feet and shall be paid as per the Classification Schedule contained in this Article.

Other Classifications of Work:

For definitions of classifications not otherwise set out, the Department generally has on file such definitions which are available. If a task to be performed is not subject to one of the classifications of pay set out, the Department will upon being contacted state which neighboring county has such a classification and provide such rate, such rate being deemed to exist by reference in this document. If no neighboring county rate applies to the task, the Department shall undertake a special determination, such special determination being then deemed to have existed under this determination. If a project requires these, or any classification not

listed, please contact IDOL at 618/993-7271 for wage rates or clarifications.

#### LANDSCAPING

Landscaping work falls under the existing classifications for laborer, operating engineer and truck driver. The work performed by landscape plantsman and landscape laborer is covered by the existing classification of laborer. The work performed by landscape operators (regardless of equipment used or its size) is covered by the classifications of operating engineer. The work performed by landscape truck drivers (regardless of size of truck driven) is covered by the classifications of truck driver.

# Moultrie County Prevailing Wage for April 2007

Trade Name	RG	TYP	C	Base	FRMAN	*M-F>8	OSA	OSH	H/W	Pensn	Vac	Trng
=====	==	===	=	=====	=====	=====	===	===	=====	=====	=====	=====
ASBESTOS ABT-GEN	N	BLD		24.420	25.420	1.5	1.5	2.0	5.050	5.330	0.000	0.700
ASBESTOS ABT-GEN	S	BLD		24.720	25.720	1.5	1.5	2.0	5.050	5.330	0.000	0.700
ASBESTOS ABT-MEC		BLD		25.290	26.290	1.5	1.5	2.0	4.450	2.500	0.000	0.250
BOILERMAKER		BLD		28.500	31.000	1.5	1.5	2.0	6.820	11.03	0.000	0.300
BRICK MASON		BLD		24.950	26.450	1.5	1.5	2.0	6.000	6.400	0.000	0.490
CARPENTER		BLD		25.590	27.590	1.5	1.5	2.0	6.500	6.800	0.000	0.320
CARPENTER		HWY		25.040	26.790	1.5	1.5	2.0	6.500	7.300	0.000	0.300
CEMENT MASON		BLD		25.830	27.080	1.5	1.5	2.0	5.200	7.000	0.000	0.300
CEMENT MASON		HWY		24.170	25.170	1.5	1.5	2.0	5.200	7.000	0.000	0.300
CERAMIC TILE FNSHER		BLD		23.600	0.000	1.5	1.5	2.0	6.000	6.400	0.000	0.000
ELECTRIC PWR EQMT OP		ALL		30.750	0.000	1.5	1.5	2.0	4.750	8.610	0.000	0.000
ELECTRIC PWR GRNDMAN		ALL		21.090	0.000	1.5	1.5	2.0	4.750	5.905	0.000	0.000
ELECTRIC PWR LINEMAN		ALL		34.160	36.350	1.5	1.5	2.0	4.750	9.560	0.000	0.000
ELECTRIC PWR TRK DRV		ALL		22.130	0.000	1.5	1.5	2.0	4.750	6.200	0.000	0.000
ELECTRICIAN		BLD		29.480	32.420	1.5	1.5	2.0	5.150	5.300	0.000	0.440
ELECTRONIC SYS TECH		BLD		24.370	25.870	1.5	1.5	2.0	5.150	3.650	0.000	0.250
ELEVATOR CONSTRUCTOR		BLD		34.190	38.460	2.0	2.0	2.0	8.275	6.060	2.050	0.000
FENCE ERECTOR		ALL		26.420	28.170	1.5	1.5	2.0	6.590	6.150	0.000	0.500
GLAZIER		BLD		27.130	28.130	1.5	2.0	2.0	5.430	4.000	0.000	0.280
HT/FROST INSULATOR		BLD		30.440	31.440	1.5	1.5	2.0	4.850	8.360	0.000	0.450
IRON WORKER		ALL		26.420	28.170	1.5	1.5	2.0	6.590	6.150	0.000	0.500
LABORER		HWY		24.220	24.970	1.5	1.5	2.0	5.050	5.330	0.000	0.600
LABORER	N	BLD		22.920	23.920	1.5	1.5	2.0	5.050	5.330	0.000	0.600
LABORER	S	BLD		23.220	24.220	1.5	1.5	2.0	5.050	5.330	0.000	0.600
LATHER		BLD		25.590	27.590	1.5	1.5	2.0	6.500	6.800	0.000	0.320
MACHINIST		BLD		36.890	38.890	2.0	2.0	2.0	4.380	5.650	2.550	0.000
MARBLE FINISHERS		BLD		23.600	0.000	1.5	1.5	2.0	6.000	6.400	0.000	0.000
MARBLE MASON		BLD		25.100	26.350	1.5	1.5	2.0	6.000	6.400	0.000	0.000
MILLWRIGHT		BLD		26.000	28.000	1.5	1.5	2.0	6.500	6.850	0.000	0.320
MILLWRIGHT		HWY		19.410	20.660	1.5	1.5	2.0	2.800	3.000	0.000	0.000
OPERATING ENGINEER		ALL	1	28.650	0.000	1.5	1.5	2.0	5.200	6.750	0.000	0.650
OPERATING ENGINEER		ALL	2	18.600	0.000	1.5	1.5	2.0	5.200	6.750	0.000	0.650
PAINTER		ALL		24.380	25.380	1.5	1.5	2.0	5.050	5.950	0.000	0.400
PAINTER OVER 30FT		ALL		25.380	26.380	1.5	1.5	2.0	5.050	5.950	0.000	0.400
PAINTER PWR EQMT		ALL		25.130	26.130	1.5	1.5	2.0	5.050	5.950	0.000	0.400
PILEDRIIVER		BLD		26.090	28.090	1.5	1.5	2.0	6.500	6.800	0.000	0.320
PILEDRIIVER		HWY		25.540	27.290	1.5	1.5	2.0	6.500	7.300	0.000	0.300
PIPEFITTER		BLD		32.480	34.980	1.5	1.5	2.0	6.450	4.800	0.000	0.670
PLASTERER		BLD		23.940	25.440	1.5	1.5	2.0	5.200	8.200	0.000	0.300
PLUMBER		BLD		32.480	34.980	1.5	1.5	2.0	6.450	4.800	0.000	0.670
ROOFER		BLD		22.350	24.850	1.5	1.5	2.0	6.000	5.550	0.000	0.550
SHEETMETAL WORKER		BLD		28.600	30.600	1.5	1.5	2.0	7.150	7.330	0.000	0.520
SPRINKLER FITTER		BLD		31.240	33.240	1.5	1.5	2.0	6.500	5.350	0.000	0.250
STONE MASON		BLD		24.950	26.450	1.5	1.5	2.0	6.000	6.400	0.000	0.490
TERRAZZO FINISHER		BLD		23.600	0.000	1.5	1.5	2.0	6.000	6.400	0.000	0.000
TERRAZZO MASON		BLD		25.100	26.350	1.5	1.5	2.0	6.000	6.400	0.000	0.000
TILE LAYER		BLD		25.360	27.110	1.5	1.5	2.0	5.000	6.800	0.000	0.300
TILE MASON		BLD		25.100	26.350	1.5	1.5	2.0	6.000	6.400	0.000	0.000
TRUCK DRIVER	NW	ALL	1	25.930	0.000	1.5	1.5	2.0	7.250	3.425	0.000	0.000
TRUCK DRIVER	NW	ALL	2	26.330	0.000	1.5	1.5	2.0	7.250	3.425	0.000	0.000
TRUCK DRIVER	NW	ALL	3	26.530	0.000	1.5	1.5	2.0	7.250	3.425	0.000	0.000
TRUCK DRIVER	NW	ALL	4	26.780	0.000	1.5	1.5	2.0	7.250	3.425	0.000	0.000
TRUCK DRIVER	NW	ALL	5	27.530	0.000	1.5	1.5	2.0	7.250	3.425	0.000	0.000
TRUCK DRIVER	NW	O&C	1	20.740	0.000	1.5	1.5	2.0	7.250	3.425	0.000	0.000
TRUCK DRIVER	NW	O&C	2	21.060	0.000	1.5	1.5	2.0	7.250	3.425	0.000	0.000
TRUCK DRIVER	NW	O&C	3	21.220	0.000	1.5	1.5	2.0	7.250	3.425	0.000	0.000
TRUCK DRIVER	NW	O&C	4	21.420	0.000	1.5	1.5	2.0	7.250	3.425	0.000	0.000
TRUCK DRIVER	NW	O&C	5	22.020	0.000	1.5	1.5	2.0	7.250	3.425	0.000	0.000

TRUCK DRIVER	SE ALL	1	25.787	0.000	1.5	1.5	2.0	7.250	3.317	0.000	0.000
TRUCK DRIVER	SE ALL	2	26.187	0.000	1.5	1.5	2.0	7.250	3.317	0.000	0.000
TRUCK DRIVER	SE ALL	3	26.387	0.000	1.5	1.5	2.0	7.250	3.317	0.000	0.000
TRUCK DRIVER	SE ALL	4	26.637	0.000	1.5	1.5	2.0	7.250	3.317	0.000	0.000
TRUCK DRIVER	SE ALL	5	27.387	0.000	1.5	1.5	2.0	7.250	3.317	0.000	0.000
TRUCK DRIVER	SE O&C	1	20.630	0.000	1.5	1.5	2.0	7.250	3.317	0.000	0.000
TRUCK DRIVER	SE O&C	2	20.950	0.000	1.5	1.5	2.0	7.250	3.317	0.000	0.000
TRUCK DRIVER	SE O&C	3	21.110	0.000	1.5	1.5	2.0	7.250	3.317	0.000	0.000
TRUCK DRIVER	SE O&C	4	21.310	0.000	1.5	1.5	2.0	7.250	3.317	0.000	0.000
TRUCK DRIVER	SE O&C	5	21.910	0.000	1.5	1.5	2.0	7.250	3.317	0.000	0.000
TUCKPOINTER	BLD		24.950	26.450	1.5	1.5	2.0	6.000	6.400	0.000	0.490

Legend:

M-F>8 (Overtime is required for any hour greater than 8 worked each day, Monday through Friday.)

OSA (Overtime is required for every hour worked on Saturday)

OSH (Overtime is required for every hour worked on Sunday and Holidays)

H/W (Health & Welfare Insurance)

Pensn (Pension)

Vac (Vacation)

Trng (Training)

## Explanations

### MOULTRIE COUNTY

CARPENTERS (NORTHWEST) - That part of the county North and West from a line between Pierson Station (Piatt County) and Rt. 133, West on 133 to the Okaw River following the river to the Moweaqua Road (Shelby County) to the West county line (Includes PILEDRIVERS, AND LATHERS).

LABORERS (SOUTH) - South of Route 121 including all of the City of Sullivan.

TRUCK DRIVERS (SOUTHEAST) - Southeast of a line from the northeast corner of Moultrie in a southwesterly direction to the point where such line continuing on to Findlay in Shelby County intersects the Moultrie-Shelby Counties line.

The following list is considered as those days for which holiday rates of wages for work performed apply: New Years Day, Memorial/Decoration Day, Fourth of July, Labor Day, Veterans Day, Thanksgiving Day, Christmas Day. Generally, any of these holidays which fall on a Sunday is celebrated on the following Monday. This then makes work performed on that Monday payable at the appropriate overtime rate for holiday pay. Common practice in a given local may alter certain days of celebration such as the day after Thanksgiving for Veterans Day. If in doubt, please check with IDOL.

Oil and chip resealing (O&C) means the application of road oils and liquid asphalt to coat an existing road surface, followed by application of aggregate chips or gravel to coated surface, and subsequent rolling of material to seal the surface.

## EXPLANATION OF CLASSES

ASBESTOS - GENERAL - removal of asbestos material/mold and hazardous materials from any place in a building, including mechanical systems where those mechanical systems are to be removed. This includes the removal of asbestos materials/mold and hazardous materials from ductwork or pipes in a building when the building is to be demolished at the time or at some close future date.

ASBESTOS - MECHANICAL - removal of asbestos material from mechanical systems, such as pipes, ducts, and boilers, where the mechanical systems are to remain.

### CERAMIC TILE FINISHER, MARBLE FINISHER, TERRAZZO FINISHER

Assisting, helping or supporting the tile, marble and terrazzo mechanic by performing their historic and traditional work assignments required to complete the proper installation of the work covered by said crafts. The term "Ceramic" is used for naming the classification only and is in no way a limitation of the product handled. Ceramic takes into consideration most hard tiles.

### ELECTRONIC SYSTEMS TECHNICIAN

Installation, service and maintenance of low-voltage systems which utilizes the transmission and/or transference of voice, sound, vision, or digital for commercial, education, security and entertainment purposes for the following: TV monitoring and surveillance, background/foreground music, intercom and telephone interconnect, field programming, inventory control systems, microwave transmission, multi-media, multiplex, radio page, school, intercom and sound burglar alarms and low voltage master clock systems.

Excluded from this classification are energy management systems, life safety systems, supervisory controls and data acquisition systems not intrinsic with the above listed systems, fire alarm systems, nurse call systems and raceways exceeding fifteen feet in length.

### TRUCK DRIVER - BUILDING, HEAVY AND HIGHWAY CONSTRUCTION

Class 1. Drivers on 2 axle trucks hauling less than 9 ton. Air compressor and welding machines and brooms, including those pulled by separate units, truck driver helpers, warehouse employees, mechanic helpers, greasers and tiremen, pickup trucks when hauling materials, tools, or workers to and from and on-the-job site, and fork lifts up to 6,000 lb. capacity.

Class 2. Two or three axle trucks hauling more than 9 ton but hauling less than 16 ton. A-frame winch trucks, hydrolift trucks, vactor trucks or similar equipment when used for transportation purposes. Fork lifts over 6,000 lb. capacity, winch trucks, four axle combination units, and ticket writers.

Class 3. Two, three or four axle trucks hauling 16 ton or more. Drivers on water pulls, articulated dump trucks, mechanics and working forepersons, and dispatchers. Five axle or more combination units.

Class 4. Low Boy and Oil Distributors.

Class 5. Drivers who require special protective clothing while employed on hazardous waste work.

TRUCK DRIVER - OIL AND CHIP RESEALING ONLY.

This shall encompass laborers, workers and mechanics who drive contractor or subcontractor owned, leased, or hired pickup, dump, service, or oil distributor trucks. The work includes transporting materials and equipment (including but not limited to, oils, aggregate supplies, parts, machinery and tools) to or from the job site; distributing oil or liquid asphalt and aggregate; stock piling material when in connection with the actual oil and chip contract. The Truck Driver (Oil & Chip Resealing) wage classification does not include supplier delivered materials.

OPERATING ENGINEERS - BUILDING, HEAVY AND HIGHWAY CONSTRUCTION

Class 1. Power Cranes, Draglines, Derricks, Shovels, Gradalls, Mechanics, Tractor Highlift, Tournadozer, Concrete Mixers with Skip, Tournamixer, Two Drum Machine, One Drum Hoist with Tower or Boom, Cableways, Tower Machines, Motor Patrol, Boom Tractor, Boom or Winch Truck, Winch or Hydraulic Boom Truck, Truck Crane, Tournapull, Tractor Operating Scoops, Bulldozer, Push Tractor, Asphalt Planer, Finishing Machine on Asphalt, Large Rollers on Earth, Rollers on Asphalt Mix, Ross Carrier or similar Machine, Gravel Processing Machine, Asphalt Plant Engineer, Paver Operator, Dredging Equipment, or Dredge Engineer, or Dredge Operator, Central Mix Plant Engineer, CMI or similar type machine, Concrete Pump, Truck or Skid Mounted, Tower Crane, Engineer or Rock Crusher Plant, Concrete Plant Engineer, Ditching Machine with dual attachment, Tractor Mounted Loaders, Cherry Picker, Hydro Crane, Standard or Dinkey Locomotives, Scoopmobiles, Euclid Loader, Soil Cement Machine, Back Filler, Elevating Machine, Power Blade, Drilling Machine, including Well Testing, Caissons, Shaft or any similar type drilling machines, Motor Driven Paint Machine, Pipe Cleaning Machine, Pipe Wrapping Machine, Pipe Bending Machine, Apsco Paver, Boring Machine, (Head Equipment Greaser), Barber-Greene Loaders, Formless Paver, (Well Point System), Concrete Spreader, Hydra Ax, Span Saw, Marine Scoops, Brush Mulcher, Brush Burner, Mesh Placer, Tree Mover, Helicopter Crew (3), Piledriver-Skid or Crawler, Stump Remover, Root Rake, Tug Boat Operator, Refrigerating Machine, Freezing Operator, Chair Cart-Self-Propelled, Hydra Seeder, Straw Blower, Power Sub Grader, Bull Float, Finishing Machine, Self-Propelled Pavement Breaker, Lull (or similar type Machine), Two Air Compressors, Compressors hooked in Manifold, Overhead Crane, Chip Spreader, Mud Cat, Sull-Air, Fork Lifts (except when used for landscaping work), Soil Stabilizer (Seaman Tiller, Bo Mag, Rago Gator, and similar types of equipment), Tube Float, Spray Machine, Curing Machine, Concrete or Asphalt Milling Machine, Snooper Truck-Operator, Backhoe, Farm Tractors (with attachments), 4 Point Lift System (Power Lift or similar type), Skid-Steer (Bob Cat or similar type), Wrecking Shears, Water Blaster.

Class 2. Concrete Mixers without Skips, Rock Crusher, Ditching Machine under 6', Curbing Machine, One Drum Machines without Tower or Boom, Air Tugger, Self-Propelled Concrete Saw, Machine Mounted Post Hole Digger, two to four Generators, Water Pumps or Welding Machines, within 400 feet, Air Compressor 600 cu. ft. and under, Rollers on Aggregate and Seal Coat Surfaces, Fork Lift (when used for landscaping work), Concrete and Blacktop Curb Machine, One Water Pump, Oilers, Air Valves or Steam Valves, One Welding Machine, Truck Jack, Mud Jack, Gunnite Machine, House Elevators when used for hoisting material, Engine Tenders, Fireman, Wagon Drill, Flex Plane, Conveyor, Siphons and Pulsometer, Switchman, Fireman on Paint Pots, Fireman on Asphalt Plants, Distributor Operator on Trucks, Tampers, Self-Propelled Power Broom, Striping Machine (motor driven), Form Tamper, Bulk Cement Plant, Equipment Greaser, Deck Hands, Truck Crane Oiler-Driver,

Cement Blimps, Form Grader, Temporary Heat, Throttle Valve, Super Sucker (and similar type of equipment).

Other Classifications of Work:

For definitions of classifications not otherwise set out, the Department generally has on file such definitions which are available. If a task to be performed is not subject to one of the classifications of pay set out, the Department will upon being contacted state which neighboring county has such a classification and provide such rate, such rate being deemed to exist by reference in this document. If no neighboring county rate applies to the task, the Department shall undertake a special determination, such special determination being then deemed to have existed under this determination. If a project requires these, or any classification not listed, please contact IDOL at 618/993-7271 for wage rates or clarifications.

LANDSCAPING

Landscaping work falls under the existing classifications for laborer, operating engineer and truck driver. The work performed by landscape plantsman and landscape laborer is covered by the existing classification of laborer. The work performed by landscape operators (regardless of equipment used or its size) is covered by the classifications of operating engineer. The work performed by landscape truck drivers (regardless of size of truck driven) is covered by the classifications of truck driver.



# Ogle County Prevailing Wage for April 2007

Trade Name	RG	TYP	C	Base	FRMAN	*M-F>8	OSA	OSH	H/W	Pensn	Vac	Trng
=====	==	==	=	=====	=====	=====	==	==	=====	=====	=====	=====
ASBESTOS ABT-GEN		BLD		23.760	24.760	1.5	1.5	2.0	5.850	8.730	0.000	0.600
ASBESTOS ABT-MEC		BLD		18.950	0.000	1.5	1.5	2.0	2.700	3.350	0.000	0.000
BOILERMAKER		BLD		30.970	33.970	2.0	2.0	2.0	8.270	7.740	0.000	0.300
BRICK MASON		BLD		30.000	32.500	1.5	1.5	2.0	5.500	8.680	0.000	0.420
CARPENTER		HWY		27.440	29.190	1.5	1.5	2.0	6.300	7.680	0.000	0.400
CARPENTER	N	BLD		30.230	33.560	1.5	1.5	2.0	5.500	7.450	0.000	0.600
CARPENTER	S	BLD		27.040	30.010	1.5	1.5	2.0	6.100	8.220	0.000	0.600
CEMENT MASON		ALL		30.000	32.500	1.5	1.5	2.0	5.500	7.530	0.000	0.100
CERAMIC TILE FNSHER		BLD		24.860	0.000	1.5	1.5	2.0	5.500	4.000	0.000	0.360
COMMUNICATION TECH		BLD		28.700	30.700	1.5	1.5	2.0	8.200	8.340	0.000	0.570
ELECTRIC PWR EQMT OP		ALL		27.920	35.880	1.5	1.5	2.0	4.750	7.820	0.000	0.210
ELECTRIC PWR GRNDMAN		ALL		21.640	35.880	1.5	1.5	2.0	4.750	6.060	0.000	0.160
ELECTRIC PWR LINEMAN		ALL		33.220	35.880	1.5	1.5	2.0	4.750	9.310	0.000	0.250
ELECTRIC PWR TRK DRV		ALL		22.340	35.880	1.5	1.5	2.0	4.750	6.260	0.000	0.170
ELECTRICIAN		BLD		33.570	36.930	1.5	1.5	2.0	8.200	11.15	0.000	0.670
ELEVATOR CONSTRUCTOR		BLD		38.620	43.450	2.0	2.0	2.0	8.275	6.060	2.320	0.000
GLAZIER		BLD		27.680	28.680	1.5	1.5	2.0	6.400	6.500	0.000	0.500
HT/FROST INSULATOR		BLD		29.630	31.850	1.5	1.5	2.0	6.000	8.720	0.000	0.000
IRON WORKER		ALL		30.760	32.300	2.0	2.0	2.0	6.950	16.62	0.000	0.550
LABORER		BLD		23.760	24.760	1.5	1.5	2.0	5.850	8.730	0.000	0.600
LABORER		HWY		23.310	24.060	1.5	1.5	2.0	5.850	8.330	0.000	0.600
LABORER, SKILLED		HWY		24.710	25.460	1.5	1.5	2.0	5.850	8.330	0.000	0.600
LATHER	N	BLD		30.230	33.560	1.5	1.5	2.0	5.500	7.450	0.000	0.600
LATHER	S	BLD		27.040	30.010	1.5	1.5	2.0	6.100	8.220	0.000	0.600
MACHINIST		BLD		36.890	38.890	2.0	2.0	2.0	4.380	5.650	2.550	0.000
MARBLE FINISHERS		BLD		24.860	0.000	1.5	1.5	2.0	5.500	4.000	0.000	0.360
MARBLE MASON		BLD		28.140	28.390	1.5	1.5	2.0	5.500	5.220	0.000	0.380
MATERIAL TESTER 1		ALL		21.550	0.000	1.5	1.5	2.0	7.460	4.840	0.000	0.170
MATERIALS TESTER II		ALL		26.550	0.000	1.5	1.5	2.0	7.460	4.840	0.000	0.170
MILLWRIGHT		BLD		32.150	35.370	1.5	1.5	2.0	5.150	9.450	0.000	0.560
OPERATING ENGINEER		BLD	1	37.050	41.050	2.0	2.0	2.0	6.850	6.150	1.900	0.700
OPERATING ENGINEER		BLD	2	36.350	41.050	2.0	2.0	2.0	6.850	6.150	1.900	0.700
OPERATING ENGINEER		BLD	3	33.900	41.050	2.0	2.0	2.0	6.850	6.150	1.900	0.700
OPERATING ENGINEER		BLD	4	31.900	41.050	2.0	2.0	2.0	6.850	6.150	1.900	0.700
OPERATING ENGINEER		HWY	1	36.900	40.900	1.5	1.5	2.0	6.850	6.150	1.900	0.700
OPERATING ENGINEER		HWY	2	36.350	40.900	1.5	1.5	2.0	6.850	6.150	1.900	0.700
OPERATING ENGINEER		HWY	3	35.050	40.900	1.5	1.5	2.0	6.850	6.150	1.900	0.700
OPERATING ENGINEER		HWY	4	33.600	40.900	1.5	1.5	2.0	6.850	6.150	1.900	0.700
OPERATING ENGINEER		HWY	5	32.150	40.900	1.5	1.5	2.0	6.850	6.150	1.900	0.700
PAINTER		ALL		29.650	30.650	1.5	1.5	1.5	5.650	5.750	0.000	0.350
PILEDRIVER		HWY		27.440	29.190	1.5	1.5	2.0	6.300	7.680	0.000	0.400
PILEDRIVER	N	BLD		31.230	34.670	1.5	1.5	2.0	5.500	7.450	0.000	0.600
PILEDRIVER	S	BLD		28.040	31.120	1.5	1.5	2.0	6.100	8.220	0.000	0.600
PIPEFITTER		BLD		33.700	36.060	1.5	1.5	2.0	6.430	7.130	0.000	0.630
PLASTERER		BLD		29.540	32.490	2.0	2.0	2.0	5.500	7.350	0.000	0.100
PLUMBER		BLD		33.700	36.060	1.5	1.5	2.0	6.430	7.130	0.000	0.630
ROOFER		BLD		33.650	35.650	1.5	1.5	2.0	6.460	3.310	0.000	0.330
SHEETMETAL WORKER		BLD		30.690	32.620	1.5	1.5	2.0	4.600	9.690	0.520	0.290
SPRINKLER FITTER		BLD		31.240	33.240	1.5	1.5	2.0	6.500	5.350	0.000	0.250
STONE MASON		BLD		30.000	32.500	1.5	1.5	2.0	5.500	8.680	0.000	0.420
TERRAZZO FINISHER		BLD		24.860	0.000	1.5	1.5	2.0	5.500	4.000	0.000	0.360
TERRAZZO MASON		BLD		28.140	28.390	1.5	1.5	2.0	5.500	5.220	0.000	0.380
TILE LAYER	N	BLD		30.230	33.560	1.5	1.5	2.0	5.500	7.450	0.000	0.600
TILE LAYER	S	BLD		27.040	30.010	1.5	1.5	2.0	6.100	8.220	0.000	0.600
TILE MASON		BLD		28.140	28.390	1.5	1.5	2.0	5.500	5.220	0.000	0.380
TRUCK DRIVER		O&C	1	20.630	0.000	1.5	1.5	2.0	7.250	3.317	0.000	0.000
TRUCK DRIVER		O&C	2	20.950	0.000	1.5	1.5	2.0	7.250	3.317	0.000	0.000
TRUCK DRIVER		O&C	3	21.110	0.000	1.5	1.5	2.0	7.250	3.317	0.000	0.000

TRUCK DRIVER		O&C	4	21.310	0.000	1.5	1.5	2.0	7.250	3.317	0.000	0.000	
TRUCK DRIVER		O&C	5	21.910	0.000	1.5	1.5	2.0	7.250	3.317	0.000	0.000	
TRUCK DRIVER		E	ALL	1	29.700	30.250	1.5	1.5	2.0	6.500	3.400	0.000	0.000
TRUCK DRIVER		E	ALL	2	29.850	30.250	1.5	1.5	2.0	6.500	3.400	0.000	0.000
TRUCK DRIVER		E	ALL	3	30.050	30.250	1.5	1.5	2.0	6.500	3.400	0.000	0.000
TRUCK DRIVER		E	ALL	4	30.250	30.250	1.5	1.5	2.0	6.500	3.400	0.000	0.000
TRUCK DRIVER		N	ALL	1	25.880	26.430	1.5	1.5	2.0	5.150	6.500	0.000	0.000
TRUCK DRIVER		N	ALL	2	26.030	26.430	1.5	1.5	2.0	5.150	6.500	0.000	0.000
TRUCK DRIVER		N	ALL	3	26.230	26.430	1.5	1.5	2.0	5.150	6.500	0.000	0.000
TRUCK DRIVER		N	ALL	4	26.430	26.430	1.5	1.5	2.0	5.150	6.500	0.000	0.000
TRUCK DRIVER		S	ALL	1	25.787	0.000	1.5	1.5	2.0	7.250	3.317	0.000	0.000
TRUCK DRIVER		S	ALL	2	26.187	0.000	1.5	1.5	2.0	7.250	3.317	0.000	0.000
TRUCK DRIVER		S	ALL	3	26.387	0.000	1.5	1.5	2.0	7.250	3.317	0.000	0.000
TRUCK DRIVER		S	ALL	4	26.637	0.000	1.5	1.5	2.0	7.250	3.317	0.000	0.000
TRUCK DRIVER		S	ALL	5	27.387	0.000	1.5	1.5	2.0	7.250	3.317	0.000	0.000
TUCKPOINTER		BLD		30.000	32.500	1.5	1.5	2.0	5.500	8.680	0.000	0.420	

Legend:

M-F>8 (Overtime is required for any hour greater than 8 worked each day, Monday through Friday.)

OSA (Overtime is required for every hour worked on Saturday)

OSH (Overtime is required for every hour worked on Sunday and Holidays)

H/W (Health & Welfare Insurance)

Pensn (Pension)

Vac (Vacation)

Trng (Training)

## Explanations

### OGLE COUNTY

CARPENTER, LATHER, MILLWRIGHT, PILEDRIIVER AND TILE LAYER (NORTH) - That part of Ogle County East from the Winnebago County western boundary and North of an imaginary line running east and west located 4 miles north of the City of Oregon.

TRUCK DRIVER (EAST) - That part of the county East of Rt. 251, including all portions of the city of Rochelle, and South of Rt. 72.

TRUCK DRIVER (SOUTH) - That part of the county West of Rt. 251 and South of Rt. 72.

TRUCK DRIVER (NORTH) - That part of the county North of Route 72.

The following list is considered as those days for which holiday rates of wages for work performed apply:

New Years Day, Memorial/Decoration Day, Fourth of July, Labor Day, Veterans Day, Thanksgiving Day, Christmas Day. Generally, any of these holidays which fall on a Sunday is celebrated on the following Monday. This then makes work performed on that Monday payable at the appropriate overtime rate for holiday pay. Common practice in a given local may alter certain days of celebration such as the day after

Thanksgiving for Veterans Day. If in doubt, please check with IDOL.

Oil and chip resealing (O&C) means the application of road oils and liquid asphalt to coat an existing road surface, followed by application of aggregate chips or gravel to coated surface, and subsequent rolling of material to seal the surface.

#### EXPLANATION OF CLASSES

ASBESTOS - GENERAL - removal of asbestos material/mold and hazardous materials from any place in a building, including mechanical systems where those mechanical systems are to be removed. This includes the removal of asbestos materials/mold and hazardous materials from ductwork or pipes in a building when the building is to be demolished at the time or at some close future date.

ASBESTOS - MECHANICAL - removal of asbestos material from mechanical systems, such as pipes, ducts, and boilers, where the mechanical systems are to remain.

#### CERAMIC TILE FINISHER, MARBLE FINISHER, TERRAZZO FINISHER

Assisting, helping or supporting the tile, marble and terrazzo mechanic by performing their historic and traditional work assignments required to complete the proper installation of the work covered by said crafts. The term "Ceramic" is used for naming the classification only and is in no way a limitation of the product handled. Ceramic takes into consideration most hard tiles.

#### COMMUNICATIONS TECHNICIAN

Installing, manufacturing, assembling and maintaining sound and intercom, protection alarm (security), fire alarm, master antenna television, closed circuit television, low voltage control for computers and/or door monitoring, school communications systems, telephones and servicing of nurse and emergency calls, and the installation and maintenance of transmit and receive antennas, transmitters, receivers, and associated apparatus which operates in conjunction with above systems. All work associated with these system installations will be included EXCEPT the installation of protective metallic conduit in new construction projects (excluding less than ten-foot runs strictly for protection of cable) and 120 volt AC (or higher) power wiring and associated hardware.

#### LABORER, SKILLED - HIGHWAY

Individuals engaged in the following types of work, irrespective of the site of the work: asbestos abatement worker, handling of any materials with any foreign matter harmful to skin or clothing, track laborer, cement handlers, chloride handlers, the unloading and loading with steel workers and re-bars, concrete workers wet, tunnel helpers in free air, batch dumpers, mason tenders, kettle and tar men, tank cleaners, plastic installers, scaffold workers, motorized buggies or motorized unit used for wet concrete or handling of building materials, laborers with de-watering systems, sewer workers plus depth, rod and chainmen with technical engineers, rod and chainmen with land surveyors, rod and chainmen with surveyors, vibrator operators, cement silica, clay, fly ash, lime and plasters, handlers (bulk or bag), cofferdam workers plus depth, on concrete paving, placing, cutting and tying of reinforcing, deck hand, dredge hand, and shore laborers, bankmen on floating plant, grade checker, power tools, front end man on chip spreaders, cession workers plus depth, gunnite nozzle men, lead man on sewer work, welders, cutters, burners

and torchmen, chainsaw operators, jackhammer and drill operators, layout man and/or drainage tile layer, steel form setter - street and highway, air tamping hammermen, signal man on crane, concrete saw operator, screedman on asphalt pavers, laborers tending masons with hot material or where foreign materials are used, mortar mixer operators, multiple concrete duct - leadsman, lumen, asphalt raker, curb asphalt machine operator, ready mix scalemen (permanent, portable or temporary plant), laborers handling masterplate or similar materials, laser beam operator, concrete burning machine operator, coring machine operator, plaster tender, underpinning and shoring of buildings, pump men, manhole and catch basin, dirt and stone tamper, hose men on concrete pumps, hazardous waste worker, lead base paint abatement worker, lining of pipe, refusing machine, assisting on direct boring machine, the work of laying watermain, fire hydrants, all mechanical joints to watermain work, sewer worker, and tapping water service and forced lift station mechanical worker.

MATERIAL TESTER I: Hand coring and drilling for testing of materials; field inspection of uncured concrete and asphalt.

MATERIAL TESTER II: Field inspection of welds, structural steel, fireproofing, masonry, soil, facade, reinforcing steel, formwork, cured concrete, and concrete and asphalt batch plants; adjusting proportions of bituminous mixtures.

TRUCK DRIVER - BUILDING, HEAVY AND HIGHWAY CONSTRUCTION - SOUTH

Class 1. Drivers on 2 axle trucks hauling less than 9 ton. Air compressor and welding machines and brooms, including those pulled by separate units, truck driver helpers, warehouse employees, mechanic helpers, greasers and tiremen, pickup trucks when hauling materials, tools, or workers to and from and on-the-job site, and fork lifts up to 6,000 lb. capacity.

Class 2. Two or three axle trucks hauling more than 9 ton but hauling less than 16 ton. A-frame winch trucks, hydrolift trucks, vector trucks or similar equipment when used for transportation purposes. Fork lifts over 6,000 lb. capacity, winch trucks, four axle combination units, and ticket writers.

Class 3. Two, three or four axle trucks hauling 16 ton or more. Drivers on water pulls, articulated dump trucks, mechanics and working forepersons, and dispatchers. Five axle or more combination units.

Class 4. Low Boy and Oil Distributors.

Class 5. Drivers who require special protective clothing while employed on hazardous waste work.

TRUCK DRIVER - OIL AND CHIP RESEALING ONLY.

This shall encompass laborers, workers and mechanics who drive contractor or subcontractor owned, leased, or hired pickup, dump, service, or oil distributor trucks. The work includes transporting materials and equipment (including but not limited to, oils, aggregate supplies, parts, machinery and tools) to or from the job site; distributing oil or liquid asphalt and aggregate; stock piling material when in connection with the actual oil and chip contract. The Truck Driver (Oil & Chip Resealing) wage classification does not include supplier delivered materials.

TRUCK DRIVER - BUILDING, HEAVY AND HIGHWAY CONSTRUCTION - EAST AND NORTH

Class 1. Two or three Axle Trucks. A-frame Truck when used for transportation purposes; Air Compressors and Welding Machines, including those pulled by cars, pick-up trucks and tractors; Ambulances; Batch Gate Lockers; Batch Hopperman; Car and Truck Washers; Carry-alls; Fork Lifts and Hoisters; Helpers; Mechanics Helpers and Greasers; Oil Distributors 2-man operation; Pavement Breakers; Pole Trailer, up to 40 feet; Power Mower Tractors; Self-propelled Chip Spreader; Skipman; Slurry Trucks, 2-man operation; Slurry Truck Conveyor Operation, 2 or 3 man; Teamsters; Unskilled dumpman; and Truck Drivers hauling warning lights, barricades, and portable toilets on the job site.

Class 2. Four axle trucks; Dump Crets and Adgetors under 7 yards; Dumpsters, Track Trucks, Euclids, Hug Bottom Dump Turnapulls or Turnatrailers when pulling other than self-loading equipment or similar equipment under 16 cubic yards; Mixer Trucks under 7 yards; Ready-mix Plant Hopper Operator, and Winch Trucks, 2 Axles.

Class 3. Five axle trucks; Dump Crets and Adgetors 7 yards and over; Dumpsters, Track Trucks, Euclids, Hug Bottom Dump Turnatrailers or turnapulls when pulling other than self-loading equipment or similar equipment over 16 cubic yards; Explosives and/or Fission Material Trucks; Mixer Trucks 7 yards or over; Mobile Cranes while in transit; Oil Distributors, 1-man operation; Pole Trailer, over 40 feet; Pole and Expandable Trailers hauling material over 50 feet long; Slurry trucks, 1-man operation; Winch trucks, 3 axles or more; mechanic--Truck Welder and Truck Painter.

Class 4. Six axle trucks; Dual-purpose vehicles, such as mounted crane trucks with hoist and accessories; Foreman; Master Mechanic; Self-loading equipment like P.B. and trucks with scoops on the front.

OPERATING ENGINEERS - BUILDING

Class 1. Assistant Craft Foreman; Craft Foreman; Mechanic; Asphalt Plant; Asphalt Spreader; Autograde; Batch Plant; Benoto (requires Two Engineers); Boiler and Throttle Valve; Caisson Rigs; Central Redi-Mix Plant; Combination Back Hoe Front End-loader Machine; Compressor and Throttle Valve; Concrete Breaker (Truck Mounted); Concrete Conveyor; Concrete Paver; Concrete Placer; Concrete Pump (Truck Mounted); Concrete Tower, Cranes, All, Cranes, Hammerhead, Creter Crane; Crusher, Stone, etc.; Derricks, All; Derricks, Traveling; Formless Curb and Gutter Machine; Grader, Elevating; Grouting Machines; Highlift Shovels or Front Endloader 2-1/4 yd. and over; Hoists, Elevators, outside type rack and pinion and similar machines; Hoists, one, two and three Drum; Hoists, Two tigger One Floor; Hydraulic Backhoes; Hydraulic Boom Trucks; Locomotives, All; Motor Patrol; Pile Drivers and Skid Rig; Post Hole Digger; Pre-Stress Machine; Pump Cretes; Squeeze Cretes-screw Type Pumps; Gypsum Bulker and Pump; Raised and Blind Hole Drill; Rock Drill; Roto Mill Grinder; Scoops - Tractor Drawn; Slip-form Paver; Straddle Buggies; Tie Back Machine; Tractor with Book and Side Boom; Trenching Machines.

Class 2. Bobcat (over 3/4 cu. yd.); Boilers; Brick Forklift; Broom, All Power Propelled; Bulldozers; Concrete Mixer (Two Bag and Over); Conveyor, Portable; Forklift Trucks; Greaser Engineer; Highlift

Shovels or Front Endloaders under 2-1/4 yd.; Hoists, Automatic; Hoists, Sewer Dragging Machine; Hoists, Tugger Single Drum; Rollers, All; Steam Generators; Tractors, All; Tractor Drawn Vibratory Roller; Winch Trucks with "A" Frame.

Class 3. Air Compressor; Asphalt Spreader; Combination - Small Equipment Operator; Generators; Heaters, Mechanical; Hoists, Inside Elevators - (Rheostat Manual Controlled); Hydraulic Power Units (Pile Driving and Extracting); Pumps, over 3" (1 to 3 not to exceed a total of 300 ft.); Pumps, Well Points; Welding Machines (2 through 5); Winches, 4 small Electric Drill Winches; Bobcat (up to and including 3/4 cu. yd.).

Class 4. Hoists, Inside Elevators, Push Button with Automatic Doors; Oilers; Brick Forklift.

#### OPERATING ENGINEERS - HEAVY AND HIGHWAY CONSTRUCTION

Class 1. Craft Foreman; Asphalt Plant, Asphalt Heater and Planer Combination; Asphalt Heater Scarfire; Asphalt Silo Tender; Asphalt Spreader; Autograder; ABG Paver; Backhoes with Caisson attachment; Ballast Regulator, Belt Loader; Caisson Rigs; Car Dumper; Central Redi-Mix Plant; Backhoe w/shear attachments; Combination Backhoe Front Endloader Machine, (1 cu. yd. Backhoe Bucket or over or with attachments); Concrete Breaker (Truck mounted); Concrete Conveyor; Concrete Paver over 27E cu. ft.; Concrete Placer; Concrete Tube Float; Cranes, all attachments; Cranes, Hammerhead, Linden, Peco & Machines of a like nature; Crete Crane; Crusher, Stone, etc.; Derricks, All; Derrick Boats; Derricks, Traveling; Directional Boring Machine over 12"; Dredges; Field Mechanic-Welder; Formless Curb and Gutter Machine; Gradall and Machines of a like nature; Grader, levating; Grader, Motor Grader, Motor Patrol, Auto Patrol, Form Grader, Pull Grader, Subgrader; Guard Rail Post Driver Mounted; Hoists, One, Two and Three Drum; Hydraulic Backhoes; Pile Drivers and Skid Rig; Pre-Stress Machine; Pump Cretes Dual Ram; Rock Drill - Crawler or Skid Rig; Rock Drill - Truck Mounted; Rock/Track Tamper; Roto Mill Grinder; Slip-Form Paver; Soil Test Drill Rig (Truck Mounted); Straddle Buggies; GCI Crane; Hydraulic Telescoping form (Tunnel); Tie Back Machine; Tractor Drawn Belt Loader; Tractor with Boom; Tractor-aire with Attachments; Traffic Barrier conveyor machine; Raised or Blind Hole; Trenching Machine; Truck Mounted Concrete Pump with Boom; Truck Mounted Concrete Conveyor; Underground Boring and/or Mining Machines; Wheel Excavator; Widener (APSCO).

Class 2. Batch Plant; Bituminous Mixer; Boiler and Throttle Valve; Bulldozers; Car Loader Trailing Conveyors; Combination Backhoe Front Endloader Machine (less than 1 cu. yd. Backhoe Bucket or over or with attachments); Compressor and Throttle Valve; Compressor, Common Receiver (3); Concrete Breaker or Hydro Hammer; Concrete Grinding Machine; Concrete Mixer or Paver 7S Series to and including 27 cu. ft.; Concrete Spreader; Concrete Curing Machine, Burlap Machine, Belting Machine and Sealing Machine; Conveyor Muck Cars (Haglund or Similar Type); Drills, all; Finishing Machine - Concrete; Greaser Engineer; Highlift Shovels or Front Endloader; Hoist - Sewer Dragging Machine; Hydraulic Boom Trucks (All Attachments); Hydro Blaster; Laser Screed; All Locomotives, Dinky; Pump Cretes; Squeeze Cretes-Screw Type Pumps, Gypsum Bulker and Pump; Roller, Asphalt; Rotary Snow Plows; Rototiller, Seaman, etc., self-propelled; Scoops - Tractor Drawn; Self-Propelled Compactor; Spreader - Chip - Stone, etc.; Scraper; Scraper - Prime Mover in Tandem (Regardless of Size); Tank Car Heater; Tractors, Push, Pulling Sheeps Foot, Disc,

Compactor, etc. Tug Boats.

Class 3. Boilers; Brooms, All Power Propelled; Cement Supply Tender; Compressor, Common Receiver (2); Concrete Mixer (Two Bag and Over); Conveyor, Portable; Farm-Type Tractors Used for Mowing, Seeding, etc.; Fireman on Boilers; Forklift Trucks; Grouting Machine; Hoists, Automatic; Hoists, All Elevators; Hoists, Tugger Single Drum; Jeep Diggers, Low Boys; Pipe Jacking Machines; Post-Hole Digger; Power Saw, Concrete Power Driven; Pug Mills; Rollers, other than asphalt; Seed and Straw Blower; Steam Generators; Stump Machine; Winch Trucks with "A" Frame; Work Boats; Tamper - Form-Motor Driven.

Class 4. Air Compressor - Small and Large; Asphalt Spreader, Backend Man; Bobcat (Skid Steer) all; Combination - Small Equipment Operator; Directional Boring Machine up to 12"; Generators - Small 50kw and Under; Generators - Large over 50kw; Heaters, Mechanical; Hydraulic Power Unit (Pile Driving, Extracting, or Drilling); Hydro-Blaster; Light Plants, All (1 through 5); Pumps, over 3" (1 to 3 not to exceed a total of 300 ft.); Pumps, Well Points; Tract-aire; Welding Machines (2 through 5); Winches, 4 Small Electric Drill Winches.

Class 5. Oilers and Directional Boring Machine Locator.

Other Classifications of Work:

For definitions of classifications not otherwise set out, the Department generally has on file such definitions which are available. If a task to be performed is not subject to one of the classifications of pay set out, the Department will upon being contacted state which neighboring county has such a classification and provide such rate, such rate being deemed to exist by reference in this document. If no neighboring county rate applies to the task, the Department shall undertake a special determination, such special determination being then deemed to have existed under this determination. If a project requires these, or any classification not listed, please contact IDOL at 618/993-7271 for wage rates or clarifications.

#### LANDSCAPING

Landscaping work falls under the existing classifications for laborer, operating engineer and truck driver. The work performed by landscape plantsman and landscape laborer is covered by the existing classification of laborer. The work performed by landscape operators (regardless of equipment used or its size) is covered by the classifications of operating engineer. The work performed by landscape truck drivers (regardless of size of truck driven) is covered by the classifications of truck driver.

# Peoria County Prevailing Wage for April 2007

Trade Name	RG	TYP	C	Base	FRMAN	*M-F>8	OSA	OSH	H/W	Pensn	Vac	Trng
=====	==	==	=	=====	=====	=====	==	==	=====	=====	=====	=====
ASBESTOS ABT-GEN		BLD		22.980	24.480	1.5	1.5	2.0	5.850	8.410	0.000	0.750
ASBESTOS ABT-GEN		HWY		24.540	25.290	1.5	1.5	2.0	5.850	8.410	0.000	0.750
ASBESTOS ABT-MEC		BLD		23.300	24.800	1.5	1.5	2.0	7.860	4.910	0.000	0.000
BOILERMAKER		BLD		30.970	33.970	2.0	2.0	2.0	8.270	7.740	0.000	0.300
BRICK MASON		BLD		27.020	28.520	1.5	1.5	2.0	5.500	6.350	0.000	0.390
CARPENTER		BLD		25.980	27.980	1.5	1.5	2.0	6.500	7.150	0.000	0.320
CARPENTER		HWY		25.910	27.910	1.5	1.5	2.0	6.500	8.100	0.000	0.320
CEMENT MASON		BLD		23.120	24.870	1.5	1.5	2.0	5.290	10.00	0.000	0.500
CEMENT MASON		HWY		24.140	25.140	1.5	1.5	2.0	5.290	10.00	0.000	0.500
CERAMIC TILE FNSHER		BLD		24.910	0.000	1.5	1.5	2.0	5.500	6.350	0.000	0.380
ELECTRIC PWR EQMT OP		ALL		30.750	0.000	1.5	1.5	2.0	4.750	8.610	0.000	0.000
ELECTRIC PWR GRNDMAN		ALL		21.090	0.000	1.5	1.5	2.0	4.750	5.905	0.000	0.000
ELECTRIC PWR LINEMAN		ALL		34.160	36.350	1.5	1.5	2.0	4.750	9.560	0.000	0.000
ELECTRIC PWR TRK DRV		ALL		22.130	0.000	1.5	1.5	2.0	4.750	6.200	0.000	0.000
ELECTRICIAN		BLD		29.860	31.860	1.5	1.5	2.0	5.150	8.060	0.000	0.250
ELECTRONIC SYS TECH		BLD		23.850	25.350	1.5	1.5	2.0	5.150	5.625	0.000	0.250
ELEVATOR CONSTRUCTOR		BLD		34.190	38.460	2.0	2.0	2.0	8.275	6.060	2.050	0.000
GLAZIER		BLD		26.320	27.070	1.5	1.5	2.0	5.650	5.750	0.000	0.350
HT/FROST INSULATOR		BLD		34.750	36.500	1.5	1.5	2.0	8.260	9.110	0.000	0.310
IRON WORKER		BLD		24.960	26.710	1.5	1.5	2.0	8.040	7.410	0.000	0.400
IRON WORKER		HWY		25.920	27.420	1.5	1.5	2.0	8.040	7.410	0.000	0.350
LABORER		BLD		21.980	23.480	1.5	1.5	2.0	5.850	8.410	0.000	0.600
LABORER		HWY		23.790	24.540	1.5	1.5	2.0	5.850	8.410	0.000	0.600
LABORER, SKILLED		BLD		22.380	23.880	1.5	1.5	2.0	5.850	8.410	0.000	0.600
LABORER, SKILLED		HWY		24.090	24.840	1.5	1.5	2.0	5.850	8.410	0.000	0.600
LATHER		BLD		25.980	27.980	1.5	1.5	2.0	6.500	7.150	0.000	0.320
MACHINERY MOVER		HWY		25.920	27.420	1.5	1.5	2.0	8.040	7.410	0.000	0.350
MACHINIST		BLD		36.890	38.890	2.0	2.0	2.0	4.380	5.650	2.550	0.000
MARBLE FINISHERS		BLD		24.910	0.000	1.5	1.5	2.0	5.500	6.350	0.000	0.380
MARBLE MASON		BLD		26.520	27.770	1.5	1.5	2.0	5.500	6.350	0.000	0.380
MILLWRIGHT		BLD		26.620	28.620	1.5	1.5	2.0	6.500	6.850	0.000	0.320
MILLWRIGHT		HWY		27.010	29.010	1.5	1.5	2.0	6.500	6.450	0.000	0.320
OPERATING ENGINEER		BLD	1	27.840	30.840	1.5	1.5	2.0	5.900	8.000	0.000	0.900
OPERATING ENGINEER		BLD	2	25.940	30.840	1.5	1.5	2.0	5.900	8.000	0.000	0.900
OPERATING ENGINEER		BLD	3	24.560	30.840	1.5	1.5	2.0	5.900	8.000	0.000	0.900
OPERATING ENGINEER		HWY	1	29.110	32.110	1.5	1.5	2.0	6.250	9.000	0.000	1.000
OPERATING ENGINEER		HWY	2	26.730	32.110	1.5	1.5	2.0	6.250	9.000	0.000	1.000
OPERATING ENGINEER		HWY	3	22.790	32.110	1.5	1.5	2.0	6.250	9.000	0.000	1.000
PAINTER		ALL		26.850	27.850	1.5	1.5	1.5	5.650	5.750	0.000	0.350
PAINTER SIGNS		BLD		28.970	32.520	1.5	1.5	1.5	2.600	2.310	0.000	0.000
PILEDRIVER		BLD		26.480	28.480	1.5	1.5	2.0	6.500	7.150	0.000	0.320
PILEDRIVER		HWY		26.910	28.910	1.5	1.5	2.0	6.500	8.100	0.000	0.320
PIPEFITTER		BLD		31.630	35.110	1.5	1.5	2.0	6.450	7.680	0.000	0.420
PLASTERER		BLD		23.400	24.650	1.5	1.5	2.0	5.290	9.800	0.000	0.500
PLUMBER		BLD		28.390	30.950	1.5	1.5	2.0	6.450	8.990	0.000	0.800
ROOFER		BLD		24.200	25.200	1.5	1.5	2.0	5.350	6.550	0.000	0.150
SHEETMETAL WORKER		BLD		27.740	29.130	1.5	1.5	2.0	5.670	9.310	0.000	0.310
SIGN HANGER		HWY		25.920	27.420	1.5	1.5	2.0	8.040	7.410	0.000	0.350
SPRINKLER FITTER		BLD		31.240	33.240	1.5	1.5	2.0	6.500	5.350	0.000	0.250
STEEL ERECTOR		HWY		25.920	27.420	1.5	1.5	2.0	8.040	7.410	0.000	0.350
STONE MASON		BLD		27.020	28.520	1.5	1.5	2.0	5.500	6.350	0.000	0.390
TERRAZZO FINISHER		BLD		24.910	0.000	1.5	1.5	2.0	5.500	6.350	0.000	0.380
TERRAZZO MASON		BLD		26.520	27.770	1.5	1.5	2.0	5.500	6.350	0.000	0.380
TILE MASON		BLD		26.520	27.770	1.5	1.5	2.0	5.500	6.350	0.000	0.380
TRUCK DRIVER		ALL	1	25.787	0.000	1.5	1.5	2.0	7.250	3.317	0.000	0.000
TRUCK DRIVER		ALL	2	26.187	0.000	1.5	1.5	2.0	7.250	3.317	0.000	0.000
TRUCK DRIVER		ALL	3	26.387	0.000	1.5	1.5	2.0	7.250	3.317	0.000	0.000
TRUCK DRIVER		ALL	4	26.637	0.000	1.5	1.5	2.0	7.250	3.317	0.000	0.000



TRUCK DRIVER	ALL	5	27.387	0.000	1.5	1.5	2.0	7.250	3.317	0.000	0.000
TRUCK DRIVER	O&C	1	20.630	0.000	1.5	1.5	2.0	7.250	3.317	0.000	0.000
TRUCK DRIVER	O&C	2	20.950	0.000	1.5	1.5	2.0	7.250	3.317	0.000	0.000
TRUCK DRIVER	O&C	3	21.110	0.000	1.5	1.5	2.0	7.250	3.317	0.000	0.000
TRUCK DRIVER	O&C	4	21.310	0.000	1.5	1.5	2.0	7.250	3.317	0.000	0.000
TRUCK DRIVER	O&C	5	21.910	0.000	1.5	1.5	2.0	7.250	3.317	0.000	0.000
TUCKPOINTER	BLD		27.020	28.520	1.5	1.5	2.0	5.500	6.350	0.000	0.390

Legend:

M-F>8 (Overtime is required for any hour greater than 8 worked each day, Monday through Friday.)

OSA (Overtime is required for every hour worked on Saturday)

OSH (Overtime is required for every hour worked on Sunday and Holidays)

H/W (Health & Welfare Insurance)

Pensn (Pension)

Vac (Vacation)

Trng (Training)

## Explanations

PEORIA COUNTY

The following list is considered as those days for which holiday rates of wages for work performed apply: New Years Day, Memorial/Decoration Day, Fourth of July, Labor Day, Veterans Day, Thanksgiving Day, Christmas Day. Generally, any of these holidays which fall on a Sunday is celebrated on the following Monday. This then makes work performed on that Monday payable at the appropriate overtime rate for holiday pay. Common practice in a given local may alter certain days of celebration such as the day after Thanksgiving for Veterans Day. If in doubt, please check with IDOL.

Oil and chip resealing (O&C) means the application of road oils and liquid asphalt to coat an existing road surface, followed by application of aggregate chips or gravel to coated surface, and subsequent rolling of material to seal the surface.

### EXPLANATION OF CLASSES

ASBESTOS - GENERAL - removal of asbestos material/mold and hazardous materials from any place in a building, including mechanical systems where those mechanical systems are to be removed. This includes the removal of asbestos materials/mold and hazardous materials from ductwork or pipes in a building when the building is to be demolished at the time or at some close future date.

ASBESTOS - MECHANICAL - removal of asbestos material from mechanical systems, such as pipes, ducts, and boilers, where the mechanical systems are to remain.

CERAMIC TILE FINISHER, MARBLE FINISHER, TERRAZZO FINISHER

Assisting, helping or supporting the tile, marble and terrazzo mechanic by performing their historic and traditional work assignments required to complete the proper installation of the work covered by said crafts. The term "Ceramic" is used for naming the classification only and is in no way a limitation of the product handled. Ceramic takes into consideration most hard tiles.

#### ELECTRONIC SYSTEMS TECHNICIAN

Installation, service and maintenance of low-voltage systems which utilizes the transmission and/or transference of voice, sound, vision, or digital for commercial, education, security and entertainment purposes for the following: TV monitoring and surveillance, background/foreground music, intercom and telephone interconnect, field programming, inventory control systems, microwave transmission, multi-media, multiplex, radio page, school, intercom and sound burglar alarms and low voltage master clock systems.

Excluded from this classification are energy management systems, life safety systems, supervisory controls and data acquisition systems not intrinsic with the above listed systems, fire alarm systems, nurse call systems and raceways exceeding fifteen feet in length.

#### LABORER, SKILLED - BUILDING

The skilled laborer building (BLD) classification shall encompass the following types of work, irrespective of the site of the work: cutting & acetylene torch, gunnite nozzlemen, gunnite pump men & pots, kettlemen & carriers of men handling hot stuff, sandblaster nozzle men, sandblasting pump men & pots, setting up and using concrete burning bars, wood block setters, underpinning & shoring of existing buildings, and the unloading and handling of all material coated with creosote.

#### LABORER, SKILLED - HIGHWAY

The skilled laborer heavy & highway (HWY) classification shall encompass the following types of work, irrespective of the site of the work: jackhammer & drill operator, gunnite pump & pot man, puddlers, vibrator men, wire fabric placer, sandblast pump & pot man, strike off concrete, unloading, handling & carrying of all creosoted piles, ties or timber, concrete burning bars, power wheelbarrows or buggies, asphalt raker, bricksetters, cutting torchman (electric & acetylene), men setting lines to level forms, form setters, gunnite nozzle man & sandblasting nozzle man, power man, and rip-rapping by hand.

#### TRUCK DRIVER - BUILDING, HEAVY AND HIGHWAY CONSTRUCTION

Class 1. Drivers on 2 axle trucks hauling less than 9 ton. Air compressor and welding machines and brooms, including those pulled by separate units, truck driver helpers, warehouse employees, mechanic helpers, greasers and tiremen, pickup trucks when hauling materials, tools, or workers to and from and on-the-job site, and fork lifts up to 6,000 lb. capacity.

Class 2. Two or three axle trucks hauling more than 9 ton but hauling less than 16 ton. A-frame winch trucks, hydrolift trucks, vector trucks or similar equipment when used for transportation purposes. Fork lifts over 6,000 lb. capacity, winch trucks, four axle combination units, and ticket writers.

Class 3. Two, three or four axle trucks hauling 16 ton or more. Drivers on water pulls, articulated dump trucks, mechanics and working

forepersons, and dispatchers. Five axle or more combination units.

Class 4. Low Boy and Oil Distributors.

Class 5. Drivers who require special protective clothing while employed on hazardous waste work.

#### TRUCK DRIVER - OIL AND CHIP RESEALING ONLY.

This shall encompass laborers, workers and mechanics who drive contractor or subcontractor owned, leased, or hired pickup, dump, service, or oil distributor trucks. The work includes transporting materials and equipment (including but not limited to, oils, aggregate supplies, parts, machinery and tools) to or from the job site; distributing oil or liquid asphalt and aggregate; stock piling material when in connection with the actual oil and chip contract. The Truck Driver (Oil & Chip Resealing) wage classification does not include supplier delivered materials.

#### OPERATING ENGINEERS - BUILDING

Class 1. Cranes; Overhead Cranes; Gradall; All Cherry Pickers; Mechanics; Central Concrete Mixing Plant Operator; Road Pavers (27E - Dual Drum - Tri Batchers); Blacktop Plant Operators and Plant Engineers; 3 Drum Hoist; Derricks; Hydro Cranes; Shovels; Skimmer Scoops; Koehring Scooper; Drag Lines; Backhoe; Derrick Boats; Pile Drivers and Skid Rigs; Clamshells; Locomotive Cranes; Dredge (all types) Motor Patrol; Power Blades - Dumore - Elevating and similar types; Tower Cranes (Crawler-Mobile) and Stationary; Crane-type Backfiller; Drott Yumbo and similar types considered as Cranes; Caisson Rigs; Dozer; Tournadozer; Work Boats; Ross Carrier; Helicopter; Tournapulls - all and similar types; Scoops (all sizes); Pushcats; Endloaders (all types); Asphalt Surfacing Machine; Slip Form Paver; Rock Crusher; Heavy Equipment Greaser; CMI, CMI Belt Placer, Auto Grade & 3 Track and similar types; Side Booms; Multiple Unit Earth Movers; Creter Crane; Trench Machine; Pump-crete-Belt Crete-Squeeze Cretes-Screw-type Pumps and Gypsum; Bulker & Pump - Operator will clean; Formless Finishing Machine; Flaherty Spreader or similar types; Screed Man on Laydown Machine; Wheel Tractors (industrial or Farm-type w/Dozer-Hoe-Endloader or other attachments); F.W.D. & Similar Types; Vermeer Concrete Saw.

Class 2. Dinkeys; Power Launches; PH One-pass Soil Cement Machine (and similar types); Pugmill with Pump; Backfillers; Euclid Loader; Forklifts; Jeeps w/Ditching Machine or other attachments; Tuneluger; Automatic Cement and Gravel Batching Plants; Mobile Drills (Soil Testing) and similar types; Gurries and Similar Types; (1) and (2) Drum Hoists (Buck Hoist and Similar Types); Chicago Boom; Boring Machine & Pipe Jacking Machine; Hydro Boom; Dewatering System; Straw Blower; Hydro Seeder; Assistant Heavy Equipment Greaser on Spread; Tractors (Track type) without Power Unit pulling Rollers; Rollers on Asphalt -- Brick Macadem; Concrete Breakers; Concrete Spreaders; Mule Pulling Rollers; Center Stripper; Cement Finishing Machines & CMI Texture & Reel Curing Machines; Cement Finishing Machine; Barber Green or similar loaders; Vibro Tamper (All similar types) Self-propelled; Winch or Boom Truck; Mechanical Bull Floats; Mixers over 3 Bag to 27E; Tractor pulling Power Blade or Elevating Grader; Porter Rex Rail; Clary Screed; Truck Type Hoptoe Oilers; Fireman; Spray Machine on Paving; Curb Machines; Truck Crane Oilers; Oil Distributor; Truck-Mounted Saws.

Class 3. Air Compressor; Power Subgrader; Straight Tractor; Trac Air

without attachments; Herman Nelson Heater, Dravo, Warner, Silent Glo, and similar types; Roller: Five (5) Ton and under on Earth or Gravel; Form Grader; Crawler Crane & Skid Rig Oilers; Freight Elevators - permanently installed; Pump; Light Plant; Generator; Conveyor (1) or (2) - Operator will clean; Welding Machine; Mixer (3) Bag and Under (Standard Capacity with skip); Bulk Cement Plant; Oiler on Central Concrete Mixing Plant.

#### OPERATING ENGINEERS - HEAVY AND HIGHWAY CONSTRUCTION

Class 1. Cranes; Hydro Crane; Shovels; Crane Type Backfiller; Tower Cranes - Mobile & Crawler & Stationary; Derricks & Hoists (3 Drum); Draglines; Drott Yumbo & similar types considered as Cranes; Back Hoe; Derrick Boats; Pile Driver and Skid Rigs; Clam Shell; Locomotive - Cranes; Road Pavers - Single Drum - Dual Drum - Tri Batcher; Motor Patrols & Power Blades - Dumore - Elevating & Similar Types; Mechanics; Central Concrete Mixing Plant Operator; Asphalt Batch Plant Operators and Plant Engineers; Gradall; Caisson Rigs; Skimmer Scoop - Koering Scooper; Dredges (all types); Hoptoe; All Cherry Pickers; Work Boat; Ross Carrier; Helicopter; Dozer; Tournadozer; Tournapulls - all and similar types; Multiple Unit Earth Movers; Scoops (all sizes); Pushcats; Endloaders (all types); Asphalt Surfacing Machine; Slip Form Paver; Rock Crusher; Heavy Equipment Greaser (top greaser on spread); CMI, Auto Grade, CMI Belt Placer & 3 Track and similar types; Side Booms; Starting Engineer on Pipeline; Asphalt Heater & Planer Combination (used to plane streets); Wheel Tractors (with dozer, hoe or endloader attachments); F.W.D. and Similar types; Blaw Knox Spreader and Similar types; Trench Machines; Pump Crete - Belt Crete - Squeeze Crete - screw type pumps and gypsum (operator will clean); Formless Finishing Machines; Flaherty Spreader or similar types; Screed Man on Laydown Machine; Vermeer Concrete Saw.

Class 2. Bulker & Pump; Power Launches; Boring Machine & Pipe Jacking Machine; Dinkeys; P-H One Pass Soil Cement Machines and similar types; Wheel Tractors (Industry or farm type - other); Back Fillers; Euclid Loader; Fork Lifts; Jeep w/Ditching Machine or other attachments; Tunneluger; Automatic Cement & Gravel Batching Plants; Mobile Drills - Soil Testing and similar types; Pugmill with pump; All (1) and (2) Drum Hoists; Dewatering System; Straw Blower; Hydro-Seeder; Boring Machine; Hydro-Boom; Bump Grinders (self-propelled); Assistant Heavy Equipment Greaser; Apsco Spreader; Tractors (track-type) without Power Units Pulling Rollers on Asphalt - Brick or Macadam; Concrete Breakers; Concrete Spreaders; Cement Strippers; Cement Finishing Machines & CMI Texture & Reel Curing Machines; Vibro-Tampers (all similar types self-propelled); Mechanical Bull Floats; Self-propelled Concrete Saws; Mixers-over three (3) bags to 27E; Winch and Boom Trucks; Tractor Pulling Power Blade or Elevating Grader; Porter Rex Rail; Clary Screed; Mule Pulling Rollers; Pugmill without Pump; Barber Greene or similar Loaders; Track Type Tractor w/Power Unit attached (minimum); Fireman; Spray Machine on Paving; Curb Machines; Paved Ditch Machine; Power Broom; Self-Propelled Conveyors; Power Subgrader; Oil Distributor; Straight Tractor; Truck Crane Oiler; Truck Type Oilers; Directional boring machine; Horizontal directional drill.

Class 3. Straight framed articulating end dump vehicles and Truck mounted vac unit (separately powered); Trac Air Machine (without attachments); Herman Nelson Heater, Dravo Warner, Silent Glo & similar types; Rollers - five ton and under on earth and gravel; Form Graders; Pumps; Light Plant; Generator; Air Compressor (1) or (2); Conveyor; Welding Machine; Mixer - 3 bags and under; Bulk Cement Plant; Oilers.

#### Other Classifications of Work:

For definitions of classifications not otherwise set out, the Department generally has on file such definitions which are available. If a task to be performed is not subject to one of the classifications of pay set out, the Department will upon being contacted state which neighboring county has such a classification and provide such rate, such rate being deemed to exist by reference in this document. If no neighboring county rate applies to the task, the Department shall undertake a special determination, such special determination being then deemed to have existed under this determination. If a project requires these, or any classification not listed, please contact IDOL at 618/993-7271 for wage rates or clarifications.

#### LANDSCAPING

Landscaping work falls under the existing classifications for laborer, operating engineer and truck driver. The work performed by landscape plantsman and landscape laborer is covered by the existing classification of laborer. The work performed by landscape operators (regardless of equipment used or its size) is covered by the classifications of operating engineer. The work performed by landscape truck drivers (regardless of size of truck driven) is covered by the classifications of truck driver.

# Perry County Prevailing Wage for April 2007

Trade Name	RG	TYP	C	Base	FRMAN	*M-F>8	OSA	OSH	H/W	Pensn	Vac	Trng
=====	==	==	=	=====	=====	=====	==	==	=====	=====	=====	=====
ASBESTOS ABT-GEN		ALL		20.750	21.200	1.5	1.5	2.0	5.250	5.600	0.000	0.700
ASBESTOS ABT-MEC		BLD		25.290	26.290	1.5	1.5	2.0	4.450	2.500	0.000	0.250
BOILERMAKER		BLD		28.500	31.000	1.5	1.5	2.0	6.820	11.03	0.000	0.300
BRICK MASON		BLD		25.470	26.970	1.5	1.5	2.0	6.000	5.400	0.000	0.425
CARPENTER		BLD		27.780	29.280	1.5	1.5	2.0	5.050	3.750	0.000	0.350
CARPENTER		HWY		27.730	29.230	1.5	1.5	2.0	5.050	3.750	0.000	0.350
CEMENT MASON		BLD		23.500	24.500	1.5	1.5	2.0	5.200	3.550	0.000	0.100
CEMENT MASON		HWY		23.750	24.750	1.5	1.5	2.0	5.300	3.700	0.000	0.300
CERAMIC TILE FNSHER		BLD		24.990	0.000	1.5	1.5	2.0	6.000	5.400	0.000	0.425
ELECTRICIAN		ALL		32.910	35.160	1.5	1.5	2.0	5.150	6.580	0.000	0.490
ELECTRONIC SYS TECH		BLD		25.700	27.200	1.5	1.5	2.0	5.150	3.340	0.000	0.250
ELEVATOR CONSTRUCTOR		BLD		37.115	41.750	2.0	2.0	2.0	8.275	4.460	2.227	0.000
FLOOR LAYER		BLD		26.930	27.680	1.5	1.5	2.0	5.000	3.750	0.000	0.350
GLAZIER		BLD		29.480	0.000	2.0	2.0	2.0	8.550	6.920	2.360	0.160
HT/FROST INSULATOR		BLD		30.440	31.440	1.5	1.5	2.0	4.850	8.360	0.000	0.450
IRON WORKER		ALL		26.350	27.850	1.5	1.5	2.0	6.360	8.250	0.000	0.420
LABORER		BLD		20.750	21.200	1.5	1.5	2.0	5.250	5.600	0.000	0.600
LABORER		HWY		21.000	21.450	1.5	1.5	2.0	5.350	6.150	0.000	0.600
LABORER		O&C		15.750	16.200	1.5	1.5	2.0	5.350	6.150	0.000	0.600
MACHINIST		BLD		36.890	38.890	2.0	2.0	2.0	4.380	5.650	2.550	0.000
MARBLE FINISHERS		BLD		24.990	0.000	1.5	1.5	2.0	6.000	5.400	0.000	0.425
MARBLE MASON		BLD		25.470	26.970	1.5	1.5	2.0	6.000	5.400	0.000	0.425
MILLWRIGHT		BLD		27.780	29.280	1.5	1.5	2.0	5.050	3.750	0.000	0.350
MILLWRIGHT		HWY		27.730	29.230	1.5	1.5	2.0	5.050	3.750	0.000	0.350
OPERATING ENGINEER		ALL	1	25.900	27.030	1.5	1.5	2.0	6.200	11.45	0.000	1.000
OPERATING ENGINEER		ALL	2	24.770	27.030	1.5	1.5	2.0	6.200	11.45	0.000	1.000
OPERATING ENGINEER		ALL	3	20.290	27.030	1.5	1.5	2.0	6.200	11.45	0.000	1.000
OPERATING ENGINEER		ALL	4	20.350	27.030	1.5	1.5	2.0	6.200	11.45	0.000	1.000
OPERATING ENGINEER		ALL	5	20.020	27.030	1.5	1.5	2.0	6.200	11.45	0.000	1.000
OPERATING ENGINEER		ALL	6	26.450	27.030	1.5	1.5	2.0	6.200	11.45	0.000	1.000
OPERATING ENGINEER		ALL	7	26.750	27.030	1.5	1.5	2.0	6.200	11.45	0.000	1.000
OPERATING ENGINEER		ALL	8	27.030	27.030	1.5	1.5	2.0	6.200	11.45	0.000	1.000
OPERATING ENGINEER		O&C	1	20.100	21.100	1.5	1.5	2.0	5.650	6.100	0.000	1.100
OPERATING ENGINEER		O&C	2	18.680	21.100	1.5	1.5	2.0	5.650	6.100	0.000	1.100
OPERATING ENGINEER		O&C	3	18.120	21.100	1.5	1.5	2.0	5.650	6.100	0.000	1.100
OPERATING ENGINEER		O&C	4	16.050	21.100	1.5	1.5	2.0	5.650	6.100	0.000	1.100
PAINTER		BLD		22.790	23.790	1.5	1.5	2.0	5.430	4.500	0.000	0.250
PAINTER		HWY		27.090	28.090	1.5	1.5	2.0	5.430	4.500	0.000	0.250
PAINTER OVER 30FT		BLD		23.790	24.790	1.5	1.5	2.0	5.430	4.500	0.000	0.250
PAINTER PWR EQMT		BLD		23.790	24.790	1.5	1.5	2.0	5.430	4.500	0.000	0.250
PAINTER PWR EQMT		HWY		28.090	29.090	1.5	1.5	2.0	5.430	4.500	0.000	0.250
PILEDRIVER		BLD		27.780	29.280	1.5	1.5	2.0	5.050	3.750	0.000	0.350
PILEDRIVER		HWY		27.730	29.230	1.5	1.5	2.0	5.050	3.750	0.000	0.350
PIPEFITTER		BLD		31.300	34.430	1.5	2.0	2.0	6.450	5.030	0.000	0.620
PLASTERER		BLD		23.500	24.500	1.5	1.5	2.0	5.200	3.550	0.000	0.100
PLUMBER		BLD		31.300	34.430	1.5	2.0	2.0	6.450	5.030	0.000	0.620
ROOFER		BLD		19.700	20.500	1.5	1.5	2.0	5.700	3.800	0.000	0.000
SHEETMETAL WORKER		ALL		27.210	28.460	1.5	1.5	2.0	6.000	4.770	1.630	0.120
SPRINKLER FITTER		BLD		31.240	33.240	1.5	1.5	2.0	6.500	5.350	0.000	0.250
STONE MASON		BLD		25.470	26.970	1.5	1.5	2.0	6.000	5.400	0.000	0.425
TERRAZZO FINISHER		BLD		24.990	0.000	1.5	1.5	2.0	6.000	5.400	0.000	0.425
TERRAZZO MASON		BLD		25.470	26.970	1.5	1.5	2.0	6.000	5.400	0.000	0.425
TRUCK DRIVER		ALL	1	24.990	0.000	1.5	1.5	2.0	7.250	4.200	0.000	0.000
TRUCK DRIVER		ALL	2	25.390	0.000	1.5	1.5	2.0	7.250	4.200	0.000	0.000
TRUCK DRIVER		ALL	3	25.590	0.000	1.5	1.5	2.0	7.250	4.200	0.000	0.000
TRUCK DRIVER		ALL	4	25.840	0.000	1.5	1.5	2.0	7.250	4.200	0.000	0.000
TRUCK DRIVER		ALL	5	26.590	0.000	1.5	1.5	2.0	7.250	4.200	0.000	0.000
TRUCK DRIVER		O&C	1	19.500	0.000	1.5	1.5	2.0	4.275	4.670	0.000	0.000

TRUCK DRIVER	O&C 2	15.900	0.000	1.5	1.5	2.0	4.275	4.670	0.000	0.000
TRUCK DRIVER	O&C 3	16.400	0.000	1.5	1.5	2.0	4.275	4.670	0.000	0.000
TUCKPINTER	BLD	25.470	26.970	1.5	1.5	2.0	6.000	5.400	0.000	0.425

Legend:

M-F>8 (Overtime is required for any hour greater than 8 worked each day, Monday through Friday.)

OSA (Overtime is required for every hour worked on Saturday)

OSH (Overtime is required for every hour worked on Sunday and Holidays)

H/W (Health & Welfare Insurance)

Pensn (Pension)

Vac (Vacation)

Trng (Training)

## Explanations

### PERRY COUNTY

The following list is considered as those days for which holiday rates of wages for work performed apply: New Years Day, Memorial/Decoration Day, Fourth of July, Labor Day, Veterans Day, Thanksgiving Day, Christmas Day. Generally, any of these holidays which fall on a Sunday is celebrated on the following Monday. This then makes work performed on that Monday payable at the appropriate overtime rate for holiday pay. Common practice in a given local may alter certain days of celebration such as the day after Thanksgiving for Veterans Day. If in doubt, please check with IDOL.

OIL AND CHIP RESEALING means the application of road oils and liquid asphalt to coat an existing road surface, followed by application of aggregate chips or gravel to coated surface, and subsequent rolling of material to seal the surface.

### EXPLANATION OF CLASSES

ASBESTOS - GENERAL - removal of asbestos material/mold and hazardous materials from any place in a building, including mechanical systems where those mechanical systems are to be removed. This includes the removal of asbestos materials/mold and hazardous materials from ductwork or pipes in a building when the building is to be demolished at the time or at some close future date.

ASBESTOS - MECHANICAL - removal of asbestos material from mechanical systems, such as pipes, ducts, and boilers, where the mechanical systems are to remain.

### LABORER - OIL AND CHIP RESEALING ONLY

Hook and unhook chip box from aggregate truck; distribute material within chip box; perform flagging work related to oil and chip resealing; hand spray oil fluids; handle traffic control, including setting-up and maintaining barricades, drums, cones, delineators, signs and other such items, as well as laying-out and applying or

removing temporary roadway markings used to control traffic in job site related to oil and chip resealing; and perform clean-up related to oil and chip resealing.

#### CERAMIC TILE FINISHER, MARBLE FINISHER, TERRAZZO FINISHER

Assisting, helping or supporting the tile, marble and terrazzo mechanic by performing their historic and traditional work assignments required to complete the proper installation of the work covered by said crafts. The term "Ceramic" is used for naming the classification only, and is in no a limitation of the product handled. Ceramic takes into consideration most hard tiles.

#### ELECTRONIC SYSTEMS TECHNICIAN

Installation, service and maintenance of low-voltage systems which utilizes the transmission and/or transference of voice, sound, vision, or digital for commercial, education, security and entertainment purposes for the following: TV monitoring and surveillance, background/foreground music, intercom and telephone interconnect, field programming, inventory control systems, microwave transmission, multi-media, multiplex, radio page, school, intercom and sound burglar alarms and low voltage master clock systems.

Excluded from this classification are energy management systems, life safety systems, supervisory controls and data acquisition systems not intrinsic with the above listed systems, fire alarm systems, nurse call systems and raceways exceeding fifteen feet in length.

#### TRUCK DRIVER - BUILDING, HEAVY AND HIGHWAY CONSTRUCTION

Class 1. Drivers on 2 axle trucks hauling less than 9 ton. Air compressor and welding machines and brooms, including those pulled by separate units, truck driver helpers, warehouse employees, mechanic helpers, greasers and tiremen, pickup trucks when hauling materials, tools, or workers to and from and on-the-job site, and fork lifts up to 6,000 lb. capacity.

Class 2. Two or three axle trucks hauling more than 9 ton but hauling less than 16 ton. A-frame winch trucks, hydrolift trucks, vector trucks or similar equipment when used for transportation purposes. Fork lifts over 6,000 lb. capacity, winch trucks, four axle combination units, and ticket writers.

Class 3. Two, three or four axle trucks hauling 16 ton or more. Drivers on water pulls, articulated dump trucks, mechanics and working forepersons, and dispatchers. Five axle or more combination units.

Class 4. Low Boy and Oil Distributors.

Class 5. Drivers who require special protective clothing while employed on hazardous waste work.

#### TRUCK DRIVER - O & C (Oil and Chip Resealing ONLY)

It involves driving of contractor or subcontractor owned, leased, or hired pickup, dump, service, or oil distributor trucks. Includes transporting materials and equipment (including, but not limited to oils, aggregate supplies, parts, machinery and tools) to or from the job site; distributing oil or liquid asphalt and aggregate; stock piling material; and maintaining trucks at job site related to oil and chip resealing.

Class 1. Distributors, liquid asphalt hauling and hauling of asphalt



rubber-tired rollers.

Class 2. Stockpiling.

Class 3. Tandem hauling to job site.

#### OPERATING ENGINEERS

GROUP I. Cranes, Dragline, Shovels, Skimmer Scoops, Clamshells or Derrick Boats, Pile Drivers, Crane-Type Backhoes, Asphalt Plant Operators, Concrete Plant Operators, Dredges, Asphalt Spreading Machines, All Locomotives, Cable Ways, or Tower Machines, Hoists, Hydraulic Backhoes, Ditching Machines or Backfiller, Cherrypickers, Overhead Cranes, Roller, Steam or Gas, Concrete Pavers, Excavators, Concrete Breakers, Concrete Pumps, Bulk Cement Plants, Cement Pumps, Derrick-Type Drills, Boat Operators, Motor Graders or Pushcats, Scoops or Tournapulls, Bulldozers, Endloaders or Fork Lifts, Power Blade or Elevating Graders, Winch Cats, Boom or Winch Trucks or Boom Tractors, Pipe Wrapping or Painting Machines, Asphalt Plant Engineer, Journeyman Lubricating Engineer, Drills (other than Derrick Type), Mud Jacks, or Well Drilling Machines, Boring Machines or Track Jacks, Mixers, Conveyors (Two), Air Compressors (Two), Water Pumps regardless of size (Two), Welding Machines (Two), Siphons or Jets (Two), Winch Heads or Apparatuses (Two), Light Plants (Two), Waterblasters (two), All Tractors regardless of size (straight tractor only), Fireman on Stationary Boilers, Automatic Elevators, Form Grading Machines, Finishing Machines, Power Sub-Grader or Ribbon Machines, Longitudinal Floats, Distributor Operators on Trucks, Winch Heads or Apparatuses (One), Mobil Track air and heaters (two to five), Heavy Equipment Greaser, Relief Operator, Assistant Master Mechanic and Heavy Duty Mechanic, all Operators (except those listed below).

GROUP II. Assistant Operators.

GROUP III. Air Compressors (One), Water Pumps, regardless of Size (One), Waterblasters (one), Welding Machine (One), Mixers (One Bag), Conveyor (One), Siphon or Jet (One), Light Plant (One), Heater (One), Immobile Track Air (One), and Self Propelled Walk-Behind Rollers.

GROUP IV. Asphalt Spreader Oilers, Fireman on Whirlies and Heavy Equipment Oilers, Truck Cranes, Dredges, Monigans, Large Cranes - (Over 65-ton rated capacity) Concrete Plant Oiler, Blacktop Plant Oiler, and Creter Crane Oiler (when required).

GROUP V. Oiler.

GROUP VI. Master Mechanics, Operators on equipment with Booms, including jibs, 100 feet and over, and less than 150 feet long.

GROUP VII. Operators on equipment with Booms, including jibs, 150 feet and over, and less than 200 feet long.

GROUP VIII. Operators on Equipment with Booms, including jibs, 200 feet and over; Tower Cranes; Whirlie Cranes; and Operator Foreman.

OPERATING ENGINEER - O & C (Oil and Chip Resealing ONLY). Includes the operation of all motorized heavy equipment used in oil and chip rsealing, including but not limited to operating self-propelled chip spreaders, and all types of rollers (both hard and rubber tired); and other duties pertaining to the operation or maintenance of heavy equipment related to oil and chip resealing.

Class 1. See Class 1 above for types of equipment operated.

Class 2. See Class 2 above for types of equipment operated.

Class 3. See Class 3 above for types of equipment operated.

Class 4. See Class 4 above for types of equipment operated.

Class 5. See Class 5 above for types of equipment operated.

Other Classifications of Work:

For definitions of classifications not otherwise set out, the Department generally has on file such definitions which are available. If a task to be performed is not subject to one of the classifications of pay set out, the Department will upon being contacted state which neighboring county has such a classification and provide such rate, such rate being deemed to exist by reference in this document. If no neighboring county rate applies to the task, the Department shall undertake a special determination, such special determination being then deemed to have existed under this determination. If a project requires these, or any classification not listed, please contact IDOL at 618/993-7271 for wage rates or clarifications.

LANDSCAPING

Landscaping work falls under the existing classifications for laborer, operating engineer and truck driver. The work performed by landscape plantsman and landscape laborer is covered by the existing classification of laborer. The work performed by landscape operators (regardless of equipment used or its size) is covered by the classifications of operating engineer. The work performed by landscape truck drivers (regardless of size of truck driven) is covered by the classifications of truck driver.

# Piatt County Prevailing Wage for April 2007

Trade Name	RG	TYP	C	Base	FRMAN	*M-F>8	OSA	OSH	H/W	Pensn	Vac	Trng
=====	==	==	=	=====	=====	=====	==	==	=====	=====	=====	=====
ASBESTOS ABT-GEN		BLD		24.450	25.450	1.5	1.5	2.0	5.050	6.090	0.000	0.700
ASBESTOS ABT-MEC		BLD		25.290	26.290	1.5	1.5	2.0	4.450	2.500	0.000	0.250
BOILERMAKER		BLD		28.500	31.000	1.5	1.5	2.0	6.820	11.03	0.000	0.300
BRICK MASON		BLD		25.500	27.000	1.5	1.5	2.0	5.200	6.500	0.000	0.630
CARPENTER		HWY		25.200	26.950	1.5	1.5	2.0	6.500	7.140	0.000	0.300
CARPENTER	NE	BLD		27.790	29.790	1.5	1.5	2.0	6.500	4.600	0.000	0.320
CARPENTER	SW	BLD		25.250	27.250	1.5	1.5	2.0	6.500	7.140	0.000	0.320
CEMENT MASON		BLD		25.830	27.080	1.5	1.5	2.0	5.200	7.000	0.000	0.300
CEMENT MASON		HWY		24.170	25.170	1.5	1.5	2.0	5.200	7.000	0.000	0.300
CERAMIC TILE FNSHER		BLD		25.500	0.000	1.5	1.5	2.0	5.200	5.600	0.000	0.000
ELECTRIC PWR EQMT OP		ALL		30.750	0.000	1.5	1.5	2.0	4.750	8.610	0.000	0.000
ELECTRIC PWR GRNDMAN		ALL		21.090	0.000	1.5	1.5	2.0	4.750	5.905	0.000	0.000
ELECTRIC PWR LINEMAN		ALL		34.160	36.350	1.5	1.5	2.0	4.750	9.560	0.000	0.000
ELECTRIC PWR TRK DRV		ALL		22.130	0.000	1.5	1.5	2.0	4.750	6.200	0.000	0.000
ELECTRICIAN	NE	BLD		32.010	34.010	1.5	1.5	2.0	5.150	5.410	0.000	0.480
ELECTRICIAN	SW	BLD		29.480	32.420	1.5	1.5	2.0	5.150	5.300	0.000	0.440
ELECTRONIC SYS TECH		BLD		24.370	25.870	1.5	1.5	2.0	5.150	3.650	0.000	0.250
ELEVATOR CONSTRUCTOR		BLD		34.190	38.460	2.0	2.0	2.0	8.275	6.060	2.050	0.000
FENCE ERECTOR		ALL		26.420	28.170	1.5	1.5	2.0	6.590	6.150	0.000	0.500
GLAZIER		BLD		27.130	28.130	1.5	2.0	2.0	5.430	4.000	0.000	0.280
HT/FROST INSULATOR		BLD		30.440	31.440	1.5	1.5	2.0	4.850	8.360	0.000	0.450
IRON WORKER		ALL		26.420	28.170	1.5	1.5	2.0	6.590	6.150	0.000	0.500
LABORER		BLD		22.950	23.950	1.5	1.5	2.0	5.050	6.090	0.000	0.600
LABORER		HWY		23.860	24.610	1.5	1.5	2.0	5.050	6.090	0.000	0.600
LATHER	NE	BLD		27.790	29.790	1.5	1.5	2.0	6.500	4.600	0.000	0.320
LATHER	SW	BLD		25.250	27.250	1.5	1.5	2.0	6.500	7.140	0.000	0.320
MACHINIST		BLD		36.890	38.890	2.0	2.0	2.0	4.380	5.650	2.550	0.000
MARBLE FINISHERS		BLD		25.500	0.000	1.5	1.5	2.0	5.200	5.600	0.000	0.000
MARBLE MASON		BLD		27.000	0.000	1.5	1.5	2.0	5.200	5.600	0.000	0.000
MILLWRIGHT		BLD		26.000	28.000	1.5	1.5	2.0	6.500	6.850	0.000	0.320
MILLWRIGHT		HWY		19.410	20.660	1.5	1.5	2.0	2.800	3.000	0.000	0.000
OPERATING ENGINEER		BLD	1	26.550	0.000	1.5	1.5	2.0	6.150	6.200	0.000	0.850
OPERATING ENGINEER		BLD	2	24.200	0.000	1.5	1.5	2.0	6.150	6.200	0.000	0.850
OPERATING ENGINEER		BLD	3	20.600	0.000	1.5	1.5	2.0	6.150	6.200	0.000	0.850
OPERATING ENGINEER		BLD	4	28.050	0.000	1.5	1.5	2.0	6.150	6.200	0.000	0.850
OPERATING ENGINEER		HWY	1	26.800	0.000	1.5	1.5	2.0	6.150	6.200	0.000	0.850
OPERATING ENGINEER		HWY	2	24.030	0.000	1.5	1.5	2.0	6.150	6.200	0.000	0.850
OPERATING ENGINEER		HWY	3	19.800	0.000	1.5	1.5	2.0	6.150	6.200	0.000	0.850
OPERATING ENGINEER		HWY	4	28.300	0.000	1.5	1.5	2.0	6.150	6.200	0.000	0.850
PAINTER		ALL		24.380	25.380	1.5	1.5	2.0	5.050	5.950	0.000	0.400
PAINTER OVER 30FT		ALL		25.380	26.380	1.5	1.5	2.0	5.050	5.950	0.000	0.400
PAINTER PWR EQMT		ALL		25.130	26.130	1.5	1.5	2.0	5.050	5.950	0.000	0.400
PILEDRIVER		HWY		25.700	27.450	1.5	1.5	2.0	6.500	7.140	0.000	0.300
PILEDRIVER	NE	BLD		28.290	30.290	1.5	1.5	2.0	6.500	4.600	0.000	0.320
PILEDRIVER	SW	BLD		25.750	27.750	1.5	1.5	2.0	6.500	7.140	0.000	0.320
PIPEFITTER	E	BLD		33.100	35.600	1.5	1.5	2.0	6.450	5.760	0.000	0.620
PIPEFITTER	W	BLD		32.480	34.980	1.5	1.5	2.0	6.450	4.800	0.000	0.670
PLASTERER		BLD		23.940	25.440	1.5	1.5	2.0	5.200	8.200	0.000	0.300
PLUMBER	E	BLD		33.100	35.600	1.5	1.5	2.0	6.450	5.760	0.000	0.620
PLUMBER	W	BLD		32.480	34.980	1.5	1.5	2.0	6.450	4.800	0.000	0.670
ROOFER		BLD		25.460	26.460	1.5	1.5	2.0	6.350	5.150	0.000	0.200
SHEETMETAL WORKER		BLD		28.600	30.600	1.5	1.5	2.0	7.150	7.330	0.000	0.520
SPRINKLER FITTER		BLD		31.240	33.240	1.5	1.5	2.0	6.500	5.350	0.000	0.250
STONE MASON		BLD		25.500	27.000	1.5	1.5	2.0	5.200	6.500	0.000	0.630
TERRAZZO FINISHER		BLD		25.500	0.000	1.5	1.5	2.0	5.200	5.600	0.000	0.000
TERRAZZO MASON		BLD		27.000	0.000	1.5	1.5	2.0	5.200	5.600	0.000	0.000
TILE MASON		BLD		27.000	0.000	1.5	1.5	2.0	5.200	5.600	0.000	0.000
TRUCK DRIVER	NE	ALL	1	25.787	0.000	1.5	1.5	2.0	7.250	3.317	0.000	0.000

TRUCK DRIVER	NE ALL	2	26.187	0.000	1.5	1.5	2.0	7.250	3.317	0.000	0.000
TRUCK DRIVER	NE ALL	3	26.387	0.000	1.5	1.5	2.0	7.250	3.317	0.000	0.000
TRUCK DRIVER	NE ALL	4	26.637	0.000	1.5	1.5	2.0	7.250	3.317	0.000	0.000
TRUCK DRIVER	NE ALL	5	27.387	0.000	1.5	1.5	2.0	7.250	3.317	0.000	0.000
TRUCK DRIVER	NE O&C	1	20.630	0.000	1.5	1.5	2.0	7.250	3.317	0.000	0.000
TRUCK DRIVER	NE O&C	2	20.950	0.000	1.5	1.5	2.0	7.250	3.317	0.000	0.000
TRUCK DRIVER	NE O&C	3	21.110	0.000	1.5	1.5	2.0	7.250	3.317	0.000	0.000
TRUCK DRIVER	NE O&C	4	21.310	0.000	1.5	1.5	2.0	7.250	3.317	0.000	0.000
TRUCK DRIVER	NE O&C	5	21.910	0.000	1.5	1.5	2.0	7.250	3.317	0.000	0.000
TRUCK DRIVER	SW ALL	1	25.930	0.000	1.5	1.5	2.0	7.250	3.425	0.000	0.000
TRUCK DRIVER	SW ALL	2	26.330	0.000	1.5	1.5	2.0	7.250	3.425	0.000	0.000
TRUCK DRIVER	SW ALL	3	26.530	0.000	1.5	1.5	2.0	7.250	3.425	0.000	0.000
TRUCK DRIVER	SW ALL	4	26.780	0.000	1.5	1.5	2.0	7.250	3.425	0.000	0.000
TRUCK DRIVER	SW ALL	5	27.530	0.000	1.5	1.5	2.0	7.250	3.425	0.000	0.000
TRUCK DRIVER	SW O&C	1	20.740	0.000	1.5	1.5	2.0	7.250	3.425	0.000	0.000
TRUCK DRIVER	SW O&C	2	21.060	0.000	1.5	1.5	2.0	7.250	3.425	0.000	0.000
TRUCK DRIVER	SW O&C	3	21.220	0.000	1.5	1.5	2.0	7.250	3.425	0.000	0.000
TRUCK DRIVER	SW O&C	4	21.420	0.000	1.5	1.5	2.0	7.250	3.425	0.000	0.000
TRUCK DRIVER	SW O&C	5	22.020	0.000	1.5	1.5	2.0	7.250	3.425	0.000	0.000
TUCKPOINTER	BLD		25.500	27.000	1.5	1.5	2.0	5.200	6.500	0.000	0.630

Legend :

M-F>8 (Overtime is required for any hour greater than 8 worked each day, Monday through Friday.)

OSA (Overtime is required for every hour worked on Saturday)

OSH (Overtime is required for every hour worked on Sunday and Holidays)

H/W (Health & Welfare Insurance)

Pensn (Pension)

Vac (Vacation)

Trng (Training)

## Explanations

PIATT COUNTY

ASBESTOS - SEE LABORERS

CARPENTERS (SOUTHWEST) - Commencing at the southeastern corner where Piatt County line meets the Douglas and Moultrie county lines, proceeding north on Piatt County line to County Road 1475 East, then proceeding north to County Road 500 North, then north to County Road 525 North and then west to County Road 1425 East and then north and west to County Road 1400 East and proceeding north to County Road 1000 North, then proceeding west to County Road 500 East, then north to County Road 1300 North, then west to County Road 300 East, then proceeding north to Old Highway 48 and then west to Old Route 48 to the Piatt County Line.

ELECTRICIANS (NORTHEAST) - Townships of Blue Ridge, Sangamon and Monticello (Northeast quadrant).

PLUMBERS & PIPEFITTERS (EAST) - That part of the county East of an extension of Rt. 105 from the Northern to the Southern boundary of the

county.

TRUCK DRIVERS (NORTHEAST) - East of a line starting at the intersection of the DeWitt-Piatt Counties line and Route 10 in a southerasterly direction to the southeast corner of Piatt County.

The following list is considered as those days for which holiday rates of wages for work performed apply: New Years Day, Memorial/Decoration Day, Fourth of July, Labor Day, Veterans Day, Thanksgiving Day, Christmas Day. Generally, any of these holidays which fall on a Sunday is celebrated on the following Monday. This then makes work performed on that Monday payable at the appropriate overtime rate for holiday pay. Common practice in a given local may alter certain days of celebration such as the day after Thanksgiving for Veterans Day. If in doubt, please check with IDOL.

Oil and chip resealing (O&C) means the application of road oils and liquid asphalt to coat an existing road surface, followed by application of aggregate chips or gravel to coated surface, and subsequent rolling of material to seal the surface.

#### EXPLANATION OF CLASSES

ASBESTOS - GENERAL - removal of asbestos material/mold and hazardous materials from any place in a building, including mechanical systems where those mechanical systems are to be removed. This includes the removal of asbestos materials/mold and hazardous materials from ductwork or pipes in a building when the building is to be demolished at the time or at some close future date.

ASBESTOS - MECHANICAL - removal of asbestos material from mechanical systems, such as pipes, ducts, and boilers, where the mechanical systems are to remain.

#### CERAMIC TILE FINISHER, MARBLE FINISHER, TERRAZZO FINISHER

Assisting, helping or supporting the tile, marble and terrazzo mechanic by performing their historic and traditional work assignments required to complete the proper installation of the work covered by said crafts. The term "Ceramic" is used for naming the classification only and is in no way a limitation of the product handled. Ceramic takes into consideration most hard tiles.

#### ELECTRONIC SYSTEMS TECHNICIAN

Installation, service and maintenance of low-voltage systems which utilizes the transmission and/or transference of voice, sound, vision, or digital for commercial, education, security and entertainment purposes for the following: TV monitoring and surveillance, background/foreground music, intercom and telephone interconnect, field programming, inventory control systems, microwave transmission, multi-media, multiplex, radio page, school, intercom and sound burglar alarms and low voltage master clock systems.

Excluded from this classification are energy management systems, life safety systems, supervisory controls and data acquisition systems not intrinsic with the above listed systems, fire alarm systems, nurse call systems and raceways exceeding fifteen feet in length.

#### TRUCK DRIVER - BUILDING, HEAVY AND HIGHWAY CONSTRUCTION

Class 1. Drivers on 2 axle trucks hauling less than 9 ton. Air compressor and welding machines and brooms, including those pulled by separate units, truck driver helpers, warehouse employees, mechanic

helpers, greasers and tiremen, pickup trucks when hauling materials, tools, or workers to and from and on-the-job site, and fork lifts up to 6,000 lb. capacity.

Class 2. Two or three axle trucks hauling more than 9 ton but hauling less than 16 ton. A-frame winch trucks, hydrolift trucks, vactor trucks or similar equipment when used for transportation purposes. Fork lifts over 6,000 lb. capacity, winch trucks, four axle combination units, and ticket writers.

Class 3. Two, three or four axle trucks hauling 16 ton or more. Drivers on water pulls, articulated dump trucks, mechanics and working forepersons, and dispatchers. Five axle or more combination units.

Class 4. Low Boy and Oil Distributors.

Class 5. Drivers who require special protective clothing while employed on hazardous waste work.

#### TRUCK DRIVER - OIL AND CHIP RESEALING ONLY.

This shall encompass laborers, workers and mechanics who drive contractor or subcontractor owned, leased, or hired pickup, dump, service, or oil distributor trucks. The work includes transporting materials and equipment (including but not limited to, oils, aggregate supplies, parts, machinery and tools) to or from the job site; distributing oil or liquid asphalt and aggregate; stock piling material when in connection with the actual oil and chip contract. The Truck Driver (Oil & Chip Resealing) wage classification does not include supplier delivered materials.

#### OPERATING ENGINEERS - BUILDING

CLASS 1. Asphalt Screed Man; Aspco Concrete Spreaders; Asphalt Pavers; Asphalt Plant Engineer; Asphalt Rollers on Bituminous Concrete; Athey Loaders; Backfillers, Crane Type; Backhoes; Barber Green Loaders; Bulldozers; Cableways; Cherry Pickers; Clam Shells; C.M.I. & similar type autograde formless paver, autograde placer & finisher; Concrete Breakers; Concrete Pumps; Derricks; Derrick Boats; Draglines; Earth Auger or Boring Machines; Elevating Graders; Engineers on Dredges; Gravel Processing Machines; Head Equipment Greaser; High Lifts or Fork Lifts; Hoists with two or more drums or two or more load lines; Locomotives, All; Mechanics; Motor Graders or Auto Patrols; Operators or Leverman on Dredges; Operators, Power Boat; Operators, Pug Mill (Asphalt Plants); Orange Peels; Overhead Cranes; Paving Mixers; Piledrivers; Pipe Wrapping and Painting Machines; Pushdozers, or Push Cats; Robotic Controlled Equipment in this Classification; Rock Crushers; Ross Carrier or Similar Machines; Rotomill; Scoops, Skimmer, two cu. yd. capacity and under; Scoops, All or Tournapull; Sheep-Foot Roller (Self Propelled); Shovels; Skid Steer; Skimmer Scoops; Temporary Concrete Plant Operators; Test Hole Drilling Machines; Tower Machines; Tower Mixers; Track Type End Loaders; Track Type Fork Lifts or High Lifts; Track Jacks and Tampers; Tractors, Sideboom; Trenching or Ditching Machine; Tunnelluggers; Vermeer Type Saws; Water Blaster Cutting Head; Wheel Type End Loaders; Winch Cat.

CLASS 2. Air Compressors (six to eight)\*; Asphalt Boosters and Heaters; Asphalt Distributors; Asphalt Plant Fireman; Oiler on Two Paving Mixers When Used in Tandem; Boom or Winch Trucks; Bull Floats or Flexplanes; Concrete Finishing Machine; Concrete Saws, Self-Propelled; Concrete Spreading Machines; Conveyors (six to

eight)\*; Generators (six to eight)\*; Gravel or Stone Spreader, Power Operated; Hoist (with One Drum and One Load Line); Light Plants (six to eight)\*; Mechanical Heaters (six to eight)\*; Mud Jacks; Post Hole Digger, Mechanical; Pug Mills when used for other than Asphalt operation; Robotic Controlled Equipment in this Classification; Road or Street Sweeper, Self Propelled; Rollers (except bituminous concrete); Seaman Tiller; Straw Machine; Vibratory Compactor; Water Blaster, Power Unit; Welding Machines (six to eight)\*; Well Drill Machines.

CLASS 3. Air Compressors(one to five)\*; Air Compressors, Track or Self-Propelled; Automatic Hoist; Building Elevators; Bulk Cement Batching Plants; Conveyors (one to five)\*; Concrete Mixers (Except Plant, Paver, or Tower); Firemen; Generators (one to five)\*; Greasers; Helper on Single Paving Mixer; Hoist, Automatic; Light Plants (one to five)\*; Mechanic Helpers; Mechanical Heaters (one to five)\*; Oilers; Power Form Graders; Power Sub-Graders; Robotic Controlled Equipment in this Classification; Scissors Hoist; Tractors without power attachments regardless of size or type; Truck Crane Oiler and Driver (1 man); Vibratory Hammer (power source); Water Pumps (one to five)\*; Welding Machines (1/300 Amp. or over)\*; Welding machines (one to five)\*

CLASS 4. Lattice Boom Crawler Cranes; Lattice Boom Truck Cranes; Telescopic Truck-Mounted Cranes; Tower Cranes.

\* Combinations of one to eight of any Air Compressors, Conveyors, Welding Machines, Water Pumps, Light Plants, or Generators shall be in batteries or within 400 feet and shall be paid as per the Classification Schedule contained in this Article.

#### OPERATING ENGINEERS - HIGHWAY

CLASS 1. Asphalt Screed Man; Asphco Concrete Spreaders; Asphalt Pavers; Asphalt Plant Engineer; Asphalt Rollers on Bituminous Concrete; Athey Loaders; Backhoes; Barber Green Loaders; Bulldozers; Cableways; Carry Deck Pickers; Cherry Pickers (Rough Terrain); C.M.I. & similar type-autograde formless paver, autograde placer & finisher; Concrete Breakers; Concrete Plant Operators; Concrete Pumps; Derricks; Derrick Boats; Dewatering Systems; Earth Auger or Boring Machines; Elevating Graders; Engineers on Dredges; Gravel Processing Machines; Grout Pump; Head Equipment Greaser; High Lifts or Fork Lifts; Hoists with two or more drums or two or more load lines; Hydro Jet or Hydro Laser; Locomotives, All; Mechanics; Motor Graders or Auto Patrols; Multi-Point Power Lifting Equipment; Operators or Leverman on Dredges; Operators, Power Boat; Operators, Pug Mill (Asphalt Plants); Overhead Cranes; Paving Mixers; Piledrivers; Pipe Wrapping and Painting Machines; Push-dozers, or Push Cats; Robotic Controlled Equipment in this Classification; Rock Crushers; Ross Carrier or Similar Machines; Roto-Mill; Scoops, Skimmer, two cu. yd. capacity and under; Sheep-Foot Roller (Self Pro-pelled); Shovels; Skid Steer; Skimmer Scoops; Test Hole Drilling Machines; Tower Machines; Tower Mixers; Track Type End Loaders; Track Type Fork Lifts or High Lifts; Track Jacks and Tampers; Tractors, Side-boom; Trenching or Ditching Machine; Tunnelluggers; Vermeer-Type Saws; Wheel Type End Loaders; Winch Cat; Scoops, All or Tournapull.

CLASS 2. Air Compressors (six to eight)\*; Articulated Dumps; Asphalt Boosters and Heaters; Asphalt Distributors; Asphalt Plant Fireman; Boom or Winch Trucks; Building Elevators; Bull Floats or Flexplanes; Concrete Finishing Machine; Concrete Saws, Self-Propelled; Concrete Spreading Machines; Conveyors (six to eight)\*; Generators (six to

eight)\*; Gravel or Stone Spreader, Power Operated; Hoist, Automatic; Hoist with One Drum and One Load Line; Light Plants (six to eight)\*; Mechanical Heaters (six to eight)\*; Mud Jacks; Off Road Water Wagons; Oiler on Two Paving Mixers When Used in Tandem; Post Hole Digger, Mechanical; Robotic Controlled Equipment in This Classification; Road or Street Sweeper, Self-Propelled; Rollers (except bituminous concrete); Scissor Hoist; Sea-man Tiller; Straw Machine; Vibratory Compactor; Water Pumps (six to eight)\*; Well Drill Machines.

CLASS 3. Air Compressors (one to five)\*; Air Compressors, Track or Self-Propelled; Bulk Cement Batching Plants; Conveyors (one to five)\*; Concrete Mixers (Except Plant, Paver, or Tower); Firemen; Generators (one to five)\*; Greasers; Helper on Single Paving Mixer; Light Plants (one to five)\*; Mechanic Helpers; Mechanical Heaters (one to five)\*; Oilers; Power Form Graders; Power Sub-Graders; Pug Mills when used for other than Asphalt operation; Robotic Controlled Equipment in This Classification; Tractors without power attachments, regardless of size or type; Truck Crane Oiler and Driver (1 man); Vibratory Hammer (power source); Water Pumps (one to five)\*; Welding Machines (one 300 Amp. or over)\*; Welding Machines (one to five)\*.

CLASS 4. Lattice Boom Crawler Crane; Lattice Boom Truck Crane; Telescopic Truck-Mounted Crane; Tower Crane.

\*Combinations of one to eight of any Air Compressors, Conveyors, Welding Machines, Water Pumps, Light Plants or Generators shall be in batteries or within 400 feet and shall be paid as per the Classification Schedule contained in this Article.

Other Classifications of Work:

For definitions of classifications not otherwise set out, the Department generally has on file such definitions which are available. If a task to be performed is not subject to one of the classifications of pay set out, the Department will upon being contacted state which neighboring county has such a classification and provide such rate, such rate being deemed to exist by reference in this document. If no neighboring county rate applies to the task, the Department shall undertake a special determination, such special determination being then deemed to have existed under this determination. If a project requires these, or any classification not listed, please contact IDOL at 618/993-7271 for wage rates or clarifications.

#### LANDSCAPING

Landscaping work falls under the existing classifications for laborer, operating engineer and truck driver. The work performed by landscape plantsman and landscape laborer is covered by the existing classification of laborer. The work performed by landscape operators (regardless of equipment used or its size) is covered by the classifications of operating engineer. The work performed by landscape truck drivers (regardless of size of truck driven) is covered by the classifications of truck driver.



# Pike County Prevailing Wage for April 2007

Trade Name	RG	TYP	C	Base	FRMAN	*M-F>8	OSA	OSH	H/W	Pensn	Vac	Trng
=====	==	==	=	=====	=====	=====	==	==	=====	=====	=====	=====
ASBESTOS ABT-GEN		BLD		22.260	23.260	1.5	1.5	2.0	5.300	6.030	0.000	0.600
ASBESTOS ABT-MEC		BLD		25.290	26.290	1.5	1.5	2.0	4.450	2.500	0.000	0.250
BOILERMAKER		BLD		28.500	31.000	1.5	1.5	2.0	6.820	11.03	0.000	0.300
BRICK MASON		BLD		24.370	25.370	1.5	1.5	2.0	6.000	5.400	0.000	0.490
CARPENTER		BLD		24.490	26.490	1.5	1.5	2.0	6.500	7.900	0.000	0.320
CARPENTER		HWY		24.250	26.000	1.5	1.5	2.0	6.500	7.800	0.000	0.300
CEMENT MASON		BLD		22.800	23.800	1.5	1.5	2.0	5.200	8.080	0.000	0.150
CEMENT MASON		HWY		22.170	23.170	1.5	1.5	2.0	5.200	7.300	0.000	0.250
CERAMIC TILE FNSHER		BLD		23.020	0.000	1.5	1.5	2.0	6.000	5.400	0.000	0.000
ELECTRIC PWR EQMT OP		ALL		30.750	0.000	1.5	1.5	2.0	4.750	8.610	0.000	0.000
ELECTRIC PWR GRNDMAN		ALL		21.090	0.000	1.5	1.5	2.0	4.750	5.905	0.000	0.000
ELECTRIC PWR LINEMAN		ALL		34.160	36.350	1.5	1.5	2.0	4.750	9.560	0.000	0.000
ELECTRIC PWR TRK DRV		ALL		22.130	0.000	1.5	1.5	2.0	4.750	6.200	0.000	0.000
ELECTRICIAN		BLD		25.290	27.290	1.5	1.5	2.0	5.150	6.460	0.000	0.250
ELECTRONIC SYS TECH		BLD		23.850	25.350	1.5	1.5	2.0	5.150	5.625	0.000	0.250
ELEVATOR CONSTRUCTOR		BLD		34.190	38.460	2.0	2.0	2.0	8.275	6.060	2.050	0.000
GLAZIER		BLD		27.130	28.130	1.5	2.0	2.0	5.430	4.000	0.000	0.280
HT/FROST INSULATOR		BLD		30.440	31.440	1.5	1.5	2.0	4.850	8.360	0.000	0.450
IRON WORKER		BLD		25.400	27.150	1.5	1.5	2.0	5.860	7.900	0.000	0.300
IRON WORKER		HWY		25.400	26.900	1.5	1.5	2.0	5.860	7.900	0.000	0.300
LABORER		BLD		20.760	21.760	1.5	1.5	2.0	5.300	6.030	0.000	0.600
LABORER		HWY		21.680	22.430	1.5	1.5	2.0	5.300	6.030	0.000	0.600
LATHER		BLD		24.490	26.490	1.5	1.5	2.0	6.500	7.900	0.000	0.320
MACHINIST		BLD		36.890	38.890	2.0	2.0	2.0	4.380	5.650	2.550	0.000
MARBLE FINISHERS		BLD		23.020	0.000	1.5	1.5	2.0	6.000	5.400	0.000	0.000
MARBLE MASON		BLD		24.520	25.270	1.5	1.5	2.0	6.000	5.400	0.000	0.000
MILLWRIGHT		BLD		26.000	28.000	1.5	1.5	2.0	6.500	6.850	0.000	0.320
MILLWRIGHT		HWY		19.070	20.320	1.5	1.5	2.0	2.800	3.000	0.000	0.000
OPERATING ENGINEER		BLD	1	26.550	0.000	1.5	1.5	2.0	6.150	6.200	0.000	0.850
OPERATING ENGINEER		BLD	2	24.200	0.000	1.5	1.5	2.0	6.150	6.200	0.000	0.850
OPERATING ENGINEER		BLD	3	20.600	0.000	1.5	1.5	2.0	6.150	6.200	0.000	0.850
OPERATING ENGINEER		BLD	4	28.050	0.000	1.5	1.5	2.0	6.150	6.200	0.000	0.850
OPERATING ENGINEER		HWY	1	26.800	0.000	1.5	1.5	2.0	6.150	6.200	0.000	0.850
OPERATING ENGINEER		HWY	2	24.030	0.000	1.5	1.5	2.0	6.150	6.200	0.000	0.850
OPERATING ENGINEER		HWY	3	19.800	0.000	1.5	1.5	2.0	6.150	6.200	0.000	0.850
OPERATING ENGINEER		HWY	4	28.300	0.000	1.5	1.5	2.0	6.150	6.200	0.000	0.850
PAINTER		BLD		25.700	26.700	1.5	1.5	2.0	4.650	5.150	0.000	0.350
PAINTER		HWY		26.800	27.800	1.5	1.5	2.0	4.650	5.150	0.000	0.350
PAINTER OVER 30FT		BLD		26.700	27.700	1.5	1.5	2.0	4.650	5.150	0.000	0.350
PAINTER PWR EQMT		BLD		26.700	27.700	1.5	1.5	2.0	4.650	5.150	0.000	0.350
PAINTER PWR EQMT		HWY		27.800	28.800	1.5	1.5	2.0	4.650	5.150	0.000	0.350
PILEDRIVER		BLD		24.990	26.990	1.5	1.5	2.0	6.500	7.900	0.000	0.320
PILEDRIVER		HWY		24.750	26.500	1.5	1.5	2.0	6.500	7.800	0.000	0.300
PIPEFITTER		BLD		34.700	37.200	1.5	1.5	2.0	6.450	4.750	0.000	0.350
PLASTERER		BLD		25.000	26.500	1.5	1.5	2.0	4.830	8.050	0.000	0.500
PLUMBER		BLD		34.700	37.200	1.5	1.5	2.0	6.450	4.750	0.000	0.350
ROOFER		BLD		24.200	25.200	1.5	1.5	2.0	5.350	6.550	0.000	0.150
SHEETMETAL WORKER		BLD		24.150	25.710	1.5	1.5	2.0	6.040	7.000	0.000	0.380
SPRINKLER FITTER		BLD		31.240	33.240	1.5	1.5	2.0	6.500	5.350	0.000	0.250
STONE MASON		BLD		24.370	25.370	1.5	1.5	2.0	6.000	5.400	0.000	0.490
TERRAZZO FINISHER		BLD		23.020	0.000	1.5	1.5	2.0	6.000	5.400	0.000	0.000
TERRAZZO MASON		BLD		24.520	25.270	1.5	1.5	2.0	6.000	5.400	0.000	0.000
TILE MASON		BLD		24.520	25.270	1.5	1.5	2.0	6.000	5.400	0.000	0.000
TRUCK DRIVER		ALL	1	25.930	0.000	1.5	1.5	2.0	7.250	3.425	0.000	0.000
TRUCK DRIVER		ALL	2	26.330	0.000	1.5	1.5	2.0	7.250	3.425	0.000	0.000
TRUCK DRIVER		ALL	3	26.530	0.000	1.5	1.5	2.0	7.250	3.425	0.000	0.000
TRUCK DRIVER		ALL	4	26.780	0.000	1.5	1.5	2.0	7.250	3.425	0.000	0.000
TRUCK DRIVER		ALL	5	27.530	0.000	1.5	1.5	2.0	7.250	3.425	0.000	0.000

TRUCK DRIVER	O&C 1	20.740	0.000	1.5	1.5	2.0	7.250	3.425	0.000	0.000
TRUCK DRIVER	O&C 2	21.060	0.000	1.5	1.5	2.0	7.250	3.425	0.000	0.000
TRUCK DRIVER	O&C 3	21.220	0.000	1.5	1.5	2.0	7.250	3.425	0.000	0.000
TRUCK DRIVER	O&C 4	21.420	0.000	1.5	1.5	2.0	7.250	3.425	0.000	0.000
TRUCK DRIVER	O&C 5	22.020	0.000	1.5	1.5	2.0	7.250	3.425	0.000	0.000
TUCKPOINTER	BLD	24.370	25.370	1.5	1.5	2.0	6.000	5.400	0.000	0.490

Legend:

M-F>8 (Overtime is required for any hour greater than 8 worked each day, Monday through Friday.)

OSA (Overtime is required for every hour worked on Saturday)

OSH (Overtime is required for every hour worked on Sunday and Holidays)

H/W (Health & Welfare Insurance)

Pensn (Pension)

Vac (Vacation)

Trng (Training)

## Explanations

### PIKE COUNTY

GLAZIERS (SOUTHWEST) - That part of the county Southwest of a diagonal line from Hannibal, MO. through Independence to the county line.

The following list is considered as those days for which holiday rates of wages for work performed apply: New Years Day, Memorial/Decoration Day, Fourth of July, Labor Day, Veterans Day, Thanksgiving Day, Christmas Day. Generally, any of these holidays which fall on a Sunday is celebrated on the following Monday. This then makes work performed on that Monday payable at the appropriate overtime rate for holiday pay. Common practice in a given local may alter certain days of celebration such as the day after Thanksgiving for Veterans Day. If in doubt, please check with IDOL.

Oil and chip resealing (O&C) means the application of road oils and liquid asphalt to coat an existing road surface, followed by application of aggregate chips or gravel to coated surface, and subsequent rolling of material to seal the surface.

### EXPLANATION OF CLASSES

ASBESTOS - GENERAL - removal of asbestos material/mold and hazardous materials from any place in a building, including mechanical systems where those mechanical systems are to be removed. This includes the removal of asbestos materials/mold and hazardous materials from ductwork or pipes in a building when the building is to be demolished at the time or at some close future date.

ASBESTOS - MECHANICAL - removal of asbestos material from mechanical systems, such as pipes, ducts, and boilers, where the mechanical systems are to remain.

CERAMIC TILE FINISHER, MARBLE FINISHER, TERRAZZO FINISHER

Assisting, helping or supporting the tile, marble and terrazzo mechanic by performing their historic and traditional work assignments required to complete the proper installation of the work covered by said crafts. The term "Ceramic" is used for naming the classification only and is in no way a limitation of the product handled. Ceramic takes into consideration most hard tiles.

#### ELECTRONIC SYSTEMS TECHNICIAN

Installation, service and maintenance of low-voltage systems which utilizes the transmission and/or transference of voice, sound, vision, or digital for commercial, education, security and entertainment purposes for the following: TV monitoring and surveillance, background/foreground music, intercom and telephone interconnect, field programming, inventory control systems, microwave transmission, multi-media, multiplex, radio page, school, intercom and sound burglar alarms and low voltage master clock systems.

Excluded from this classification are energy management systems, life safety systems, supervisory controls and data acquisition systems not intrinsic with the above listed systems, fire alarm systems, nurse call systems and raceways exceeding fifteen feet in length.

#### TRUCK DRIVER - BUILDING, HEAVY AND HIGHWAY CONSTRUCTION

Class 1. Drivers on 2 axle trucks hauling less than 9 ton. Air compressor and welding machines and brooms, including those pulled by separate units, truck driver helpers, warehouse employees, mechanic helpers, greasers and tiremen, pickup trucks when hauling materials, tools, or workers to and from and on-the-job site, and fork lifts up to 6,000 lb. capacity.

Class 2. Two or three axle trucks hauling more than 9 ton but hauling less than 16 ton. A-frame winch trucks, hydrolift trucks, vector trucks or similar equipment when used for transportation purposes. Fork lifts over 6,000 lb. capacity, winch trucks, four axle combination units, and ticket writers.

Class 3. Two, three or four axle trucks hauling 16 ton or more. Drivers on water pulls, articulated dump trucks, mechanics and working forepersons, and dispatchers. Five axle or more combination units.

Class 4. Low Boy and Oil Distributors.

Class 5. Drivers who require special protective clothing while employed on hazardous waste work.

#### TRUCK DRIVER - OIL AND CHIP RESEALING ONLY.

This shall encompass laborers, workers and mechanics who drive contractor or subcontractor owned, leased, or hired pickup, dump, service, or oil distributor trucks. The work includes transporting materials and equipment (including but not limited to, oils, aggregate supplies, parts, machinery and tools) to or from the job site; distributing oil or liquid asphalt and aggregate; stock piling material when in connection with the actual oil and chip contract. The Truck Driver (Oil & Chip Resealing) wage classification does not include supplier delivered materials.

#### OPERATING ENGINEERS - BUILDING

CLASS 1. Asphalt Screed Man; Aspco Concrete Spreaders; Asphalt Pavers; Asphalt Plant Engineer; Asphalt Rollers on Bituminous Concrete; Athey Loaders; Backfillers, Crane Type; Backhoes; Barber

Green Loaders; Bulldozers; Cableways; Cherry Pickers; Clam Shells; C.M.I. & similar type autograde formless paver, autograde placer & finisher; Concrete Breakers; Concrete Pumps; Derricks; Derrick Boats; Draglines; Earth Auger or Boring Machines; Elevating Graders; Engineers on Dredges; Gravel Processing Machines; Head Equipment Greaser; High Lifts or Fork Lifts; Hoists with two or more drums or two or more load lines; Locomotives, All; Mechanics; Motor Graders or Auto Patrols; Operators or Leverman on Dredges; Operators, Power Boat; Operators, Pug Mill (Asphalt Plants); Orange Peels; Overhead Cranes; Paving Mixers; Piledrivers; Pipe Wrapping and Painting Machines; Pushdozers, or Push Cats; Robotic Controlled Equipment in this Classification; Rock Crushers; Ross Carrier or Similar Machines; Rotomill; Scoops, Skimmer, two cu. yd. capacity and under; Scoops, All or Tournapull; Sheep-Foot Roller (Self Propelled); Shovels; Skid Steer; Skimmer Scoops; Temporary Concrete Plant Operators; Test Hole Drilling Machines; Tower Machines; Tower Mixers; Track Type End Loaders; Track Type Fork Lifts or High Lifts; Track Jacks and Tampers; Tractors, Sideboom; Trenching or Ditching Machine; Tunnelluggers; Vermeer Type Saws; Water Blaster Cutting Head; Wheel Type End Loaders; Winch Cat.

CLASS 2. Air Compressors (six to eight)\*; Asphalt Boosters and Heaters; Asphalt Distributors; Asphalt Plant Fireman; Oiler on Two Paving Mixers When Used in Tandem; Boom or Winch Trucks; Bull Floats or Flexplanes; Concrete Finishing Machine; Concrete Saws, Self-Propelled; Concrete Spreading Machines; Conveyors (six to eight)\*; Generators (six to eight)\*; Gravel or Stone Spreader, Power Operated; Hoist (with One Drum and One Load Line); Light Plants (six to eight)\*; Mechanical Heaters (six to eight)\*; Mud Jacks; Post Hole Digger, Mechanical; Pug Mills when used for other than Asphalt operation; Robotic Controlled Equipment in this Classification; Road or Street Sweeper, Self Propelled; Rollers (except bituminous concrete); Seaman Tiller; Straw Machine; Vibratory Compactor; Water Blaster, Power Unit; Welding Machines (six to eight)\*; Well Drill Machines.

CLASS 3. Air Compressors(one to five)\*; Air Compressors, Track or Self-Propelled; Automatic Hoist; Building Elevators; Bulk Cement Batching Plants; Conveyors (one to five)\*; Concrete Mixers (Except Plant, Paver, or Tower); Firemen; Generators (one to five)\*; Greasers; Helper on Single Paving Mixer; Hoist, Automatic; Light Plants (one to five)\*; Mechanic Helpers; Mechanical Heaters (one to five)\*; Oilers; Power Form Graders; Power Sub-Graders; Robotic Controlled Equipment in this Classification; Scissors Hoist; Tractors without power attachments regardless of size or type; Truck Crane Oiler and Driver (1 man); Vibratory Hammer (power source); Water Pumps (one to five)\*; Welding Machines (1/300 Amp. or over)\*; Welding machines (one to five)\*

CLASS 4. Lattice Boom Crawler Cranes; Lattice Boom Truck Cranes; Telescopic Truck-Mounted Cranes; Tower Cranes.

\* Combinations of one to eight of any Air Compressors, Conveyors, Welding Machines, Water Pumps, Light Plants, or Generators shall be in batteries or within 400 feet and shall be paid as per the Classification Schedule contained in this Article.

#### OPERATING ENGINEERS - HIGHWAY

CLASS 1. Asphalt Screed Man; Asphco Concrete Spreaders; Asphalt Pavers; Asphalt Plant Engineer; Asphalt Rollers on Bituminous Concrete; Athey Loaders; Backhoes; Barber Green Loaders; Bulldozers;

Cableways; Carry Deck Pickers; Cherry Pickers (Rough Terrain); C.M.I. & similar type-autograde formless paver, autograde placer & finisher; Concrete Breakers; Concrete Plant Operators; Concrete Pumps; Derricks; Derrick Boats; Dewatering Systems; Earth Auger or Boring Machines; Elevating Graders; Engineers on Dredges; Gravel Processing Machines; Grout Pump; Head Equipment Greaser; High Lifts or Fork Lifts; Hoists with two or more drums or two or more load lines; Hydro Jet or Hydro Laser; Locomotives, All; Mechanics; Motor Graders or Auto Patrols; Multi-Point Power Lifting Equipment; Operators or Leverman on Dredges; Operators, Power Boat; Operators, Pug Mill (Asphalt Plants); Overhead Cranes; Paving Mixers; Piledrivers; Pipe Wrapping and Painting Machines; Push-dozers, or Push Cats; Robotic Controlled Equipment in this Classification; Rock Crushers; Ross Carrier or Similar Machines; Roto-Mill; Scoops, Skimmer, two cu. yd. capacity and under; Sheep-Foot Roller (Self Pro-pelled); Shovels; Skid Steer; Skimmer Scoops; Test Hole Drilling Machines; Tower Machines; Tower Mixers; Track Type End Loaders; Track Type Fork Lifts or High Lifts; Track Jacks and Tampers; Tractors, Side-boom; Trenching or Ditching Machine; Tunnelluggers; Vermeer-Type Saws; Wheel Type End Loaders; Winch Cat; Scoops, All or Tournapull.

CLASS 2. Air Compressors (six to eight)\*; Articulated Dumps; Asphalt Boosters and Heaters; Asphalt Distributors; Asphalt Plant Fireman; Boom or Winch Trucks; Building Elevators; Bull Floats or Flexplanes; Concrete Finishing Machine; Concrete Saws, Self-Propelled; Concrete Spreading Machines; Conveyors (six to eight)\*; Generators (six to eight)\*; Gravel or Stone Spreader, Power Operated; Hoist, Automatic; Hoist with One Drum and One Load Line; Light Plants (six to eight)\*; Mechanical Heaters (six to eight)\*; Mud Jacks; Off Road Water Wagons; Oiler on Two Paving Mixers When Used in Tandem; Post Hole Digger, Mechanical; Robotic Controlled Equipment in This Classification; Road or Street Sweeper, Self-Propelled; Rollers (except bituminous concrete); Scissor Hoist; Sea-man Tiller; Straw Machine; Vibratory Compactor; Water Pumps (six to eight)\*; Well Drill Machines.

CLASS 3. Air Compressors (one to five)\*; Air Compressors, Track or Self-Propelled; Bulk Cement Batching Plants; Conveyors (one to five)\*; Concrete Mixers (Except Plant, Paver, or Tower); Firemen; Generators (one to five)\*; Greasers; Helper on Single Paving Mixer; Light Plants (one to five)\*; Mechanic Helpers; Mechanical Heaters (one to five)\*; Oilers; Power Form Graders; Power Sub-Graders; Pug Mills when used for other than Asphalt operation; Robotic Controlled Equipment in This Classification; Tractors without power attachments, regardless of size or type; Truck Crane Oiler and Driver (1 man); Vibratory Hammer (power source); Water Pumps (one to five)\*; Welding Machines (one 300 Amp. or over)\*; Welding Machines (one to five)\*.

CLASS 4. Lattice Boom Crawler Crane; Lattice Boom Truck Crane; Telescopic Truck-Mounted Crane; Tower Crane.

\*Combinations of one to eight of any Air Compressors, Conveyors, Welding Machines, Water Pumps, Light Plants or Generators shall be in batteries or within 400 feet and shall be paid as per the Classification Schedule contained in this Article.

Other Classifications of Work:

For definitions of classifications not otherwise set out, the Department generally has on file such definitions which are available. If a task to be performed is not subject to one of the classifications of pay set out, the Department will upon being contacted state which neighboring county has such a classification and

provide such rate, such rate being deemed to exist by reference in this document. If no neighboring county rate applies to the task, the Department shall undertake a special determination, such special determination being then deemed to have existed under this determination. If a project requires these, or any classification not listed, please contact IDOL at 618/993-7271 for wage rates or clarifications.

#### LANDSCAPING

Landscaping work falls under the existing classifications for laborer, operating engineer and truck driver. The work performed by landscape plantsman and landscape laborer is covered by the existing classification of laborer. The work performed by landscape operators (regardless of equipment used or its size) is covered by the classifications of operating engineer. The work performed by landscape truck drivers (regardless of size of truck driven) is covered by the classifications of truck driver.

# Pope County Prevailing Wage for April 2007

Trade Name	RG	TYP	C	Base	FRMAN	*M-F>8	OSA	OSH	H/W	Pensn	Vac	Trng
=====	==	==	=	=====	=====	=====	==	==	=====	=====	=====	=====
ASBESTOS ABT-GEN		ALL		20.750	21.200	1.5	1.5	2.0	5.250	5.600	0.000	0.700
ASBESTOS ABT-MEC		BLD		20.800	0.000	2.0	2.0	2.0	5.000	3.400	0.000	0.000
BOILERMAKER		BLD		28.500	31.000	1.5	1.5	2.0	6.820	11.03	0.000	0.300
BRICK MASON		BLD		25.470	26.970	1.5	1.5	2.0	6.000	5.400	0.000	0.425
CARPENTER		BLD		27.780	29.280	1.5	1.5	2.0	5.050	3.750	0.000	0.350
CARPENTER		HWY		27.730	29.230	1.5	1.5	2.0	5.050	3.750	0.000	0.350
CEMENT MASON		BLD		23.500	24.500	1.5	1.5	2.0	5.200	3.550	0.000	0.100
CEMENT MASON		HWY		23.750	24.750	1.5	1.5	2.0	5.300	3.700	0.000	0.300
CERAMIC TILE FNSHER		BLD		24.990	0.000	1.5	1.5	2.0	6.000	5.400	0.000	0.425
ELECTRICIAN		ALL		32.910	35.160	1.5	1.5	2.0	5.150	6.580	0.000	0.490
ELECTRONIC SYS TECH		BLD		25.700	27.200	1.5	1.5	2.0	5.150	3.340	0.000	0.250
FLOOR LAYER		BLD		26.930	27.680	1.5	1.5	2.0	5.000	3.750	0.000	0.350
GLAZIER		BLD		22.930	0.000	1.5	1.5	2.0	4.320	3.800	0.000	0.300
HT/FROST INSULATOR		BLD		26.110	27.110	1.5	1.5	2.0	4.800	6.860	0.000	0.190
IRON WORKER		ALL		22.650	23.650	1.5	1.5	2.0	5.760	6.450	0.000	0.310
LABORER		BLD		20.750	21.200	1.5	1.5	2.0	5.250	5.600	0.000	0.600
LABORER		HWY		21.000	21.450	1.5	1.5	2.0	5.350	6.150	0.000	0.600
LABORER		O&C		15.750	16.200	1.5	1.5	2.0	5.350	6.150	0.000	0.600
MACHINIST		BLD		36.890	38.890	2.0	2.0	2.0	4.380	5.650	2.550	0.000
MARBLE FINISHERS		BLD		24.990	0.000	1.5	1.5	2.0	6.000	5.400	0.000	0.425
MARBLE MASON		BLD		25.470	26.970	1.5	1.5	2.0	6.000	5.400	0.000	0.425
MILLWRIGHT		BLD		27.780	29.280	1.5	1.5	2.0	5.050	3.750	0.000	0.350
MILLWRIGHT		HWY		27.730	29.230	1.5	1.5	2.0	5.050	3.750	0.000	0.350
OE RIVER 1		RIV	1	26.900	0.000	1.5	1.5	2.0	5.650	6.100	0.000	1.100
OE RIVER 2		RIV	2	23.450	0.000	1.5	1.5	2.0	5.650	6.100	0.000	1.100
OPERATING ENGINEER		ALL	1	26.800	27.800	1.5	1.5	2.0	5.650	6.100	0.000	1.100
OPERATING ENGINEER		ALL	2	24.900	27.800	1.5	1.5	2.0	5.650	6.100	0.000	1.100
OPERATING ENGINEER		ALL	3	24.150	27.800	1.5	1.5	2.0	5.650	6.100	0.000	1.100
OPERATING ENGINEER		ALL	4	21.400	27.800	1.5	1.5	2.0	5.650	6.100	0.000	1.100
OPERATING ENGINEER		O&C	1	20.100	21.100	1.5	1.5	2.0	5.650	6.100	0.000	1.100
OPERATING ENGINEER		O&C	2	18.680	21.100	1.5	1.5	2.0	5.650	6.100	0.000	1.100
OPERATING ENGINEER		O&C	3	18.120	21.100	1.5	1.5	2.0	5.650	6.100	0.000	1.100
OPERATING ENGINEER		O&C	4	16.050	21.100	1.5	1.5	2.0	5.650	6.100	0.000	1.100
PAINTER		BLD		22.790	23.790	1.5	1.5	2.0	5.430	4.500	0.000	0.250
PAINTER		HWY		27.090	28.090	1.5	1.5	2.0	5.430	4.500	0.000	0.250
PAINTER OVER 30FT		BLD		23.790	24.790	1.5	1.5	2.0	5.430	4.500	0.000	0.250
PAINTER PWR EQMT		BLD		23.790	24.790	1.5	1.5	2.0	5.430	4.500	0.000	0.250
PAINTER PWR EQMT		HWY		28.090	29.090	1.5	1.5	2.0	5.430	4.500	0.000	0.250
PILEDRIVER		BLD		27.780	29.280	1.5	1.5	2.0	5.050	3.750	0.000	0.350
PILEDRIVER		HWY		27.730	29.230	1.5	1.5	2.0	5.050	3.750	0.000	0.350
PIPEFITTER		BLD		31.300	34.430	1.5	2.0	2.0	6.450	5.030	0.000	0.620
PLASTERER		BLD		23.500	24.500	1.5	1.5	2.0	5.200	3.550	0.000	0.100
PLUMBER		BLD		31.300	34.430	1.5	2.0	2.0	6.450	5.030	0.000	0.620
ROOFER		BLD		19.700	20.500	1.5	1.5	2.0	5.700	3.800	0.000	0.000
SHEETMETAL WORKER		ALL		27.210	28.460	1.5	1.5	2.0	6.000	4.770	1.630	0.120
SPRINKLER FITTER		BLD		31.240	33.240	1.5	1.5	2.0	6.500	5.350	0.000	0.250
STONE MASON		BLD		25.470	26.970	1.5	1.5	2.0	6.000	5.400	0.000	0.425
TERRAZZO FINISHER		BLD		24.990	0.000	1.5	1.5	2.0	6.000	5.400	0.000	0.425
TRUCK DRIVER		ALL	1	24.990	0.000	1.5	1.5	2.0	7.250	4.200	0.000	0.000
TRUCK DRIVER		ALL	2	25.390	0.000	1.5	1.5	2.0	7.250	4.200	0.000	0.000
TRUCK DRIVER		ALL	3	25.590	0.000	1.5	1.5	2.0	7.250	4.200	0.000	0.000
TRUCK DRIVER		ALL	4	25.840	0.000	1.5	1.5	2.0	7.250	4.200	0.000	0.000
TRUCK DRIVER		ALL	5	26.590	0.000	1.5	1.5	2.0	7.250	4.200	0.000	0.000
TRUCK DRIVER		O&C	1	19.500	0.000	1.5	1.5	2.0	4.275	4.670	0.000	0.000
TRUCK DRIVER		O&C	2	15.900	0.000	1.5	1.5	2.0	4.275	4.670	0.000	0.000
TRUCK DRIVER		O&C	3	16.400	0.000	1.5	1.5	2.0	4.275	4.670	0.000	0.000
TUCKPOINTER		BLD		25.470	26.970	1.5	1.5	2.0	6.000	5.400	0.000	0.425

Legend :

M-F>8 (Overtime is required for any hour greater than 8 worked each day, Monday through Friday.)

OSA (Overtime is required for every hour worked on Saturday)

OSH (Overtime is required for every hour worked on Sunday and Holidays)

H/W (Health & Welfare Insurance)

Pensn (Pension)

Vac (Vacation)

Trng (Training)

## Explanations

### POPE COUNTY

The following list is considered as those days for which holiday rates of wages for work performed apply: New Years Day, Memorial/Decoration Day, Fourth of July, Labor Day, Veterans Day, Thanksgiving Day, Christmas Day. Generally, any of these holidays which fall on a Sunday is celebrated on the following Monday. This then makes work performed on that Monday payable at the appropriate overtime rate for holiday pay. Common practice in a given local may alter certain days of celebration such as the day after Thanksgiving for Veterans Day. If in doubt, please check with IDOL.

Oil and chip resealing (O&C) means the application of road oils and liquid asphalt to coat an existing road surface, followed by application of aggregate chips or gravel to coated surface, and subsequent rolling of material to seal the surface.

### EXPLANATION OF CLASSES

ASBESTOS - GENERAL - removal of asbestos material/mold and hazardous materials from any place in a building, including mechanical systems where those mechanical systems are to be removed. This includes the removal of asbestos materials/mold and hazardous materials from ductwork or pipes in a building when the building is to be demolished at the time or at some close future date.

ASBESTOS - MECHANICAL - removal of asbestos material from mechanical systems, such as pipes, ducts, and boilers, where the mechanical systems are to remain.

### LABORER - OIL AND CHIP RESEALING ONLY

Hook and unhook chip box from aggregate truck; distribute material within chip box; perform flagging work related to oil and chip resealing; hand spray oil fluids; handle traffic control, including setting-up and maintaining barricades, drums, cones, delineators, signs and other such items, as well as laying-out and applying or removing temporary roadway markings used to control traffic in job site related to oil and chip resealing; and perform clean-up related to oil and chip resealing.



## CERAMIC TILE FINISHER, MARBLE FINISHER, TERRAZZO FINISHER

Assisting, helping or supporting the tile, marble and terrazzo mechanic by performing their historic and traditional work assignments required to complete the proper installation of the work covered by said crafts. The term "Ceramic" is used for naming the classification only, and is in no a limitation of the product handled. Ceramic takes into consideration most hard tiles.

## ELECTRONIC SYSTEMS TECHNICIAN

Installation, service and maintenance of low-voltage systems which utilizes the transmission and/or transference of voice, sound, vision, or digital for commercial, education, security and entertainment purposes for the following: TV monitoring and surveillance, background/foreground music, intercom and telephone interconnect, field programming, inventory control systems, microwave transmission, multi-media, multiplex, radio page, school, intercom and sound burglar alarms and low voltage master clock systems.

Excluded from this classification are energy management systems, life safety systems, supervisory controls and data acquisition systems not intrinsic with the above listed systems, fire alarm systems, nurse call systems and raceways exceeding fifteen feet in length.

## TRUCK DRIVER - BUILDING, HEAVY AND HIGHWAY CONSTRUCTION

Class 1. Drivers on 2 axle trucks hauling less than 9 ton. Air compressor and welding machines and brooms, including those pulled by separate units, truck driver helpers, warehouse employees, mechanic helpers, greasers and tiremen, pickup trucks when hauling materials, tools, or workers to and from and on-the-job site, and fork lifts up to 6,000 lb. capacity.

Class 2. Two or three axle trucks hauling more than 9 ton but hauling less than 16 ton. A-frame winch trucks, hydrolift trucks, vector trucks or similar equipment when used for transportation purposes. Fork lifts over 6,000 lb. capacity, winch trucks, four axle combination units, and ticket writers.

Class 3. Two, three or four axle trucks hauling 16 ton or more. Drivers on water pulls, articulated dump trucks, mechanics and working forepersons, and dispatchers. Five axle or more combination units.

Class 4. Low Boy and Oil Distributors.

Class 5. Drivers who require special protective clothing while employed on hazardous waste work.

## TRUCK DRIVER - O & C (Oil and Chip Resealing ONLY)

It involves driving of contractor or subcontractor owned, leased, or hired pickup, dump, service, or oil distributor trucks. Includes transporting materials and equipment (including, but not limited to oils, aggregate supplies, parts, machinery and tools) to or from the job site; distributing oil or liquid asphalt and aggregate; stock piling material; and maintaining trucks at job site related to oil and chip resealing.

Class 1. Distributors, liquid asphalt hauling and hauling of asphalt rubber-tired rollers.

Class 2. Stockpiling.

Class 3. Tandem hauling to job site.

OPERATING ENGINEERS - BUILDING, HEAVY AND HIGHWAY CONSTRUCTION

Class 1. APSCO or Equal Spreading Machine, Backhoe, Backfiller, Boom or Winch Cat, Bituminous Mixplane Machine, Blacksmith, Bituminous Surfacing Machine, Bull-Dozer, Crane, Shovel, Dragline, Truck Crane, Pile Driver, Concrete Breaker, Concrete or Pumpcrete Pumps, Dinky or Standard Locomotives, Well or Caisson Drills, Elevating Grader, Fork Lifts, Flexplane, Gradeall, Hi-Lift Hoists, Guy-Derricks, Hysters, Mechanic Motor Patrol, Mixers-21 cu. ft. or over, Push Cats, Pulls and Scrapers, Two Well Point Pumps, Pulverizer or Tiller, PugMill, Rubber-Tired Farm Type Tractor with Bulldozer/Blade/Auger or hi-lift over 1/2 yd., Jersey Spreader, Tract-Air used with Drill or Hi-Lift, Trenching or Ditching Machines, Wood Chipper w/Tractor, Self-Propelled Roller w/Blade, Equipment Greaser, Self-Propelled Bump Grinder on Concrete pavement, Boat Operator, Skid-Loaders, Tuggers, Lazer Screed, and Self-Propelled Chip Spreader (when others run conveyors).

Class 2. Any type tractor pulling any type roller or disc, Two Air Compressors (220 cu. ft. capacity or over), Two AirTract Drills, Air-Track Drill w/Compressor, Automatic Bins or Scales w/Compressor or Generator, Pipeline Boring Machine, Bulk Cement Plant w/Separate Compressor, Power Operated Bull Float, Hydra-Lift w/Single Motor, Straw Mulcher Blower w/Spout, Self-Propelled Roller/Compactor, Back-End man on Bituminous Surfacing Machine, oiler on milling machine.

Class 3. Air Compressor w/Valve driving piling, Boom or Winch Type Truck, Two Conveyors, Self-Propelled Concrete Saw, Form Grader, Truck Crane Oiler, Self-Propelled Vibrator, Rubber Tired Farm Type Tractor w/Blade/Bulldozer/Auger/hi-lift - 1/2 yd. or less, Elevator Operator, Man Lift (scissor lift) when lifting materials.

Class 4. Air-Track Drill (one), Belt Drag Machine, Power Broom, Mechanical Plasterer Applicator, Trac-Air, Air Compressor (220 cu. ft. or over) One, Air Compressor (under 220 cu. ft) four, Automatic Bin, Bulk Cement Plant w/Built-in Compressor running off same motor or electric motor, Fireman or Switchman, Self-Propelled Form Tamper, Light Plants (4), Welding Machines (4), Pumps (4), or Combination of four (4) Pumps, Light Plants, Welding Machines, Air-Compressors (under 220 cu. ft.), Mudjacks or Wood Chipper, Mixers - less than 21 cu. ft. Mortar Mixer w/Skip or Pump, Pipeline Tract Jack. One Operating Engineer may operate and maintain any combination of the following pieces of equipment, not to exceed four (4) which shall be within a reasonable distance, such combination may include any equipment in this classification: (Compressors, Light Plants, Generators, Welding Machines, Pumps or Conveyors), One Well- Point Pump, Two Motor Driven Heaters, One Air Compressor (under 220 cu. ft.), One Engine-Driven Conveyor, One Motor Driven Heater, One Light Plant, One Pump, One Welding Machine, One Ulmac or Equal Spreader, Oilers, and one Generator 10 kw or greater.

OPERATING ENGINEER - O & C (Oil and Chip Resealing ONLY). Includes the operation of all motorized heavy equipment used in oil and chip rsealing, including but not limited to operating self-propelled chip spreaders, and all types of rollers (both hard and rubber tired); and other duties pertaining to the operation or maintenance of heavy equipment related to oil and chip resealing.

Class 1. See Class 1 above for types of equipment operated.

Class 2. See Class 2 above for types of equipment operated.

Class 3. See Class 3 above for types of equipment operated.

Class 4. See Class 4 above for types of equipment operated.

OPERATING ENGINEER RIVER WORK 1 - operate the following machines when working on River Work and Levee Work on the Mississippi and Ohio Rivers, Lakes and Tributaries: Crane, Shovel, Drageline, Scrapers, Dredge, Derrick, Pile-Driver, Push Boat, all power boat operators, Mechanic, Engineman on Dredge, Leverman on Dredge, All Bituminous Spreader machines, Backhoe, Backfiller, Boom, or Winch Cat, Bituminous Mixplane Machine, Blacksmith, Bituminous Surfacing Machine, Bulldozer, Truck Cranes, Hydraulic Truck Mounted Boom/Crane, Concrete Finishing Machine, or Spreader Machine, Concrete Breaker, Concrete or Pumpcrete Machines, Concrete Plant Operator, All Off Road Material Hauling Equipment, Dinky or Standard Locomotives, Well Drill, Elevating Grader, Fork-Lifts, Flexplane, Gradeall, Hi-Lift, Power Handblade Tugger type Hoist, Hoist Two Drum (or over one), Gyderrick, Hyster, Motor Patrol, Mixers - 21 Cu. Ft. or over, Push Cat, Pulls, & Scrapers, Pumps-Two Well Points, Equipment Greaser, P & H Pulverizer or Pulverizer equal to Pugmill, Pugmill, Rubber-Tired farm type tractor w/Bulldozer/Blade/Auger or Hi-Lift over ½ yard, Skimmer Scoops, Seaman Tiller, Jersey Spreader, Tract-Air used with Drill or Hi-Lift, Trenching or Ditching Machine, Wood Chipper w/Tractor, self-propelled roller w/Blade, Concrete Pumps and Small Equipment Operators.

OPERATING ENGINEER RIVER 2 - when working on River Work and Levee Work on the Mississippi and Ohio Rivers, Lakes and Tributaries shall be employed as the Oiler or Fireman on Crane, Dragline, Shovel, Dredge, Truck Crane, Pile Driver, Gradeall, Dinky or Standard Locomotive, Guy Derrick, Trenching Machine or Ditching Machine 80 H.P. and over, All Terrain (cherry-picker) with over 40 ton Lifting Capacity, Deck Oiler and Deckhands.

#### Other Classifications of Work:

For definitions of classifications not otherwise set out, the Department generally has on file such definitions which are available. If a task to be performed is not subject to one of the classifications of pay set out, the Department will upon being contacted state which neighboring county has such a classification and provide such rate, such rate being deemed to exist by reference in this document. If no neighboring county rate applies to the task, the Department shall undertake a special determination, such special determination being then deemed to have existed under this determination. If a project requires these, or any classification not listed, please contact IDOL at 618/993-7271 for wage rates or clarifications.

#### LANDSCAPING

Landscaping work falls under the existing classifications for laborer, operating engineer and truck driver. The work performed by landscape plantsman and landscape laborer is covered by the existing classification of laborer. The work performed by landscape operators (regardless of equipment used or its size) is covered by the classifications of operating engineer. The work performed by landscape truck drivers (regardless of size of truck driven) is covered by the classifications of truck driver.

# Pulaski County Prevailing Wage for April 2007

Trade Name	RG	TYP	C	Base	FRMAN	*M-F>8	OSA	OSH	H/W	Pensn	Vac	Trng
=====	==	===	=	=====	=====	=====	===	===	=====	=====	=====	=====
ASBESTOS ABT-GEN		ALL		20.750	21.200	1.5	1.5	2.0	5.250	5.600	0.000	0.700
ASBESTOS ABT-MEC		BLD		20.800	0.000	2.0	2.0	2.0	5.000	3.400	0.000	0.000
BOILERMAKER		BLD		28.500	31.000	1.5	1.5	2.0	6.820	11.03	0.000	0.300
BRICK MASON		BLD		25.470	26.970	1.5	1.5	2.0	6.000	5.400	0.000	0.425
CARPENTER		BLD		27.780	29.280	1.5	1.5	2.0	5.050	3.750	0.000	0.350
CARPENTER		HWY		27.730	29.230	1.5	1.5	2.0	5.050	3.750	0.000	0.350
CEMENT MASON		BLD		23.500	24.500	1.5	1.5	2.0	5.200	3.550	0.000	0.100
CEMENT MASON		HWY		23.750	24.750	1.5	1.5	2.0	5.300	3.700	0.000	0.300
CERAMIC TILE FNSHER		BLD		24.990	0.000	1.5	1.5	2.0	6.000	5.400	0.000	0.425
ELECTRICIAN		ALL		32.910	35.160	1.5	1.5	2.0	5.150	6.580	0.000	0.490
ELECTRONIC SYS TECH		BLD		25.700	27.200	1.5	1.5	2.0	5.150	3.340	0.000	0.250
FLOOR LAYER		BLD		26.930	27.680	1.5	1.5	2.0	5.000	3.750	0.000	0.350
GLAZIER		BLD		22.930	0.000	1.5	1.5	2.0	4.320	3.800	0.000	0.300
HT/FROST INSULATOR		BLD		26.110	27.110	1.5	1.5	2.0	4.800	6.860	0.000	0.190
IRON WORKER		ALL		22.650	23.650	1.5	1.5	2.0	5.760	6.450	0.000	0.310
LABORER		BLD		20.750	21.200	1.5	1.5	2.0	5.250	5.600	0.000	0.600
LABORER		HWY		21.000	21.450	1.5	1.5	2.0	5.350	6.150	0.000	0.600
LABORER		O&C		15.750	16.200	1.5	1.5	2.0	5.350	6.150	0.000	0.600
MACHINIST		BLD		36.890	38.890	2.0	2.0	2.0	4.380	5.650	2.550	0.000
MARBLE FINISHERS		BLD		24.990	0.000	1.5	1.5	2.0	6.000	5.400	0.000	0.425
MARBLE MASON		BLD		25.470	26.970	1.5	1.5	2.0	6.000	5.400	0.000	0.425
MILLWRIGHT		BLD		27.780	29.280	1.5	1.5	2.0	5.050	3.750	0.000	0.350
MILLWRIGHT		HWY		27.730	29.230	1.5	1.5	2.0	5.050	3.750	0.000	0.350
OE RIVER 1		RIV 1		26.900	0.000	1.5	1.5	2.0	5.650	6.100	0.000	1.100
OE RIVER 2		RIV 2		23.450	0.000	1.5	1.5	2.0	5.650	6.100	0.000	1.100
OPERATING ENGINEER		ALL 1		26.800	27.800	1.5	1.5	2.0	5.650	6.100	0.000	1.100
OPERATING ENGINEER		ALL 2		24.900	27.800	1.5	1.5	2.0	5.650	6.100	0.000	1.100
OPERATING ENGINEER		ALL 3		24.150	27.800	1.5	1.5	2.0	5.650	6.100	0.000	1.100
OPERATING ENGINEER		ALL 4		21.400	27.800	1.5	1.5	2.0	5.650	6.100	0.000	1.100
OPERATING ENGINEER		O&C 1		20.100	21.100	1.5	1.5	2.0	5.650	6.100	0.000	1.100
OPERATING ENGINEER		O&C 2		18.680	21.100	1.5	1.5	2.0	5.650	6.100	0.000	1.100
OPERATING ENGINEER		O&C 3		18.120	21.100	1.5	1.5	2.0	5.650	6.100	0.000	1.100
OPERATING ENGINEER		O&C 4		16.050	21.100	1.5	1.5	2.0	5.650	6.100	0.000	1.100
PAINTER		BLD		22.790	23.790	1.5	1.5	2.0	5.430	4.500	0.000	0.250
PAINTER		HWY		27.090	28.090	1.5	1.5	2.0	5.430	4.500	0.000	0.250
PAINTER OVER 30FT		BLD		23.790	24.790	1.5	1.5	2.0	5.430	4.500	0.000	0.250
PAINTER PWR EQMT		BLD		23.790	24.790	1.5	1.5	2.0	5.430	4.500	0.000	0.250
PAINTER PWR EQMT		HWY		28.090	29.090	1.5	1.5	2.0	5.430	4.500	0.000	0.250
PILEDRIVER		BLD		27.780	29.280	1.5	1.5	2.0	5.050	3.750	0.000	0.350
PILEDRIVER		HWY		27.730	29.230	1.5	1.5	2.0	5.050	3.750	0.000	0.350
PIPEFITTER		BLD		31.300	34.430	1.5	2.0	2.0	6.450	5.030	0.000	0.620
PLASTERER		BLD		23.500	24.500	1.5	1.5	2.0	5.200	3.550	0.000	0.100
PLUMBER		BLD		31.300	34.430	1.5	2.0	2.0	6.450	5.030	0.000	0.620
ROOFER		BLD		19.700	20.500	1.5	1.5	2.0	5.700	3.800	0.000	0.000
SHEETMETAL WORKER		ALL		27.210	28.460	1.5	1.5	2.0	6.000	4.770	1.630	0.120
SPRINKLER FITTER		BLD		31.240	33.240	1.5	1.5	2.0	6.500	5.350	0.000	0.250
STONE MASON		BLD		25.470	26.970	1.5	1.5	2.0	6.000	5.400	0.000	0.425
TERRAZZO FINISHER		BLD		24.990	0.000	1.5	1.5	2.0	6.000	5.400	0.000	0.425
TERRAZZO MASON		BLD		25.470	26.970	1.5	1.5	2.0	6.000	5.400	0.000	0.425
TRUCK DRIVER		ALL 1		24.990	0.000	1.5	1.5	2.0	7.250	4.200	0.000	0.000
TRUCK DRIVER		ALL 2		25.390	0.000	1.5	1.5	2.0	7.250	4.200	0.000	0.000
TRUCK DRIVER		ALL 3		25.590	0.000	1.5	1.5	2.0	7.250	4.200	0.000	0.000
TRUCK DRIVER		ALL 4		25.840	0.000	1.5	1.5	2.0	7.250	4.200	0.000	0.000
TRUCK DRIVER		ALL 5		26.590	0.000	1.5	1.5	2.0	7.250	4.200	0.000	0.000
TRUCK DRIVER		O&C 1		19.500	0.000	1.5	1.5	2.0	4.275	4.670	0.000	0.000
TRUCK DRIVER		O&C 2		15.900	0.000	1.5	1.5	2.0	4.275	4.670	0.000	0.000
TRUCK DRIVER		O&C 3		16.400	0.000	1.5	1.5	2.0	4.275	4.670	0.000	0.000
TUCKPOINTS		BLD		25.470	26.970	1.5	1.5	2.0	6.000	5.400	0.000	0.425

Legend :

M-F>8 (Overtime is required for any hour greater than 8 worked each day, Monday through Friday.)

OSA (Overtime is required for every hour worked on Saturday)

OSH (Overtime is required for every hour worked on Sunday and Holidays)

H/W (Health & Welfare Insurance)

Pensn (Pension)

Vac (Vacation)

Trng (Training)

## Explanations

### PULASKI COUNTY

The following list is considered as those days for which holiday rates of wages for work performed apply: New Years Day, Memorial/Decoration Day, Fourth of July, Labor Day, Veterans Day, Thanksgiving Day, Christmas Day. Generally, any of these holidays which fall on a Sunday is celebrated on the following Monday. This then makes work performed on that Monday payable at the appropriate overtime rate for holiday pay. Common practice in a given local may alter certain days of celebration such as the day after Thanksgiving for Veterans Day. If in doubt, please check with IDOL.

Oil and chip resealing (O&C) means the application of road oils and liquid asphalt to coat an existing road surface, followed by application of aggregate chips or gravel to coated surface, and subsequent rolling of material to seal the surface.

### EXPLANATION OF CLASSES

ASBESTOS - GENERAL - removal of asbestos material/mold and hazardous materials from any place in a building, including mechanical systems where those mechanical systems are to be removed. This includes the removal of asbestos materials/mold and hazardous materials from ductwork or pipes in a building when the building is to be demolished at the time or at some close future date.

ASBESTOS - MECHANICAL - removal of asbestos material from mechanical systems, such as pipes, ducts, and boilers, where the mechanical systems are to remain.

### LABORER - OIL AND CHIP RESEALING ONLY

Hook and unhook chip box from aggregate truck; distribute material within chip box; perform flagging work related to oil and chip resealing; hand spray oil fluids; handle traffic control, including setting-up and maintaining barricades, drums, cones, delineators, signs and other such items, as well as laying-out and applying or removing temporary roadway markings used to control traffic in job site related to oil and chip resealing; and perform clean-up related to oil and chip resealing.

#### CERAMIC TILE FINISHER, MARBLE FINISHER, TERRAZZO FINISHER

Assisting, helping or supporting the tile, marble and terrazzo mechanic by performing their historic and traditional work assignments required to complete the proper installation of the work covered by said crafts. The term "Ceramic" is used for naming the classification only, and is in no a limitation of the product handled. Ceramic takes into consideration most hard tiles.

#### ELECTRONIC SYSTEMS TECHNICIAN

Installation, service and maintenance of low-voltage systems which utilizes the transmission and/or transference of voice, sound, vision, or digital for commercial, education, security and entertainment purposes for the following: TV monitoring and surveillance, background/foreground music, intercom and telephone interconnect, field programming, inventory control systems, microwave transmission, multi-media, multiplex, radio page, school, intercom and sound burglar alarms and low voltage master clock systems.

Excluded from this classification are energy management systems, life safety systems, supervisory controls and data acquisition systems not intrinsic with the above listed systems, fire alarm systems, nurse call systems and raceways exceeding fifteen feet in length.

#### TRUCK DRIVER - BUILDING, HEAVY AND HIGHWAY CONSTRUCTION

Class 1. Drivers on 2 axle trucks hauling less than 9 ton. Air compressor and welding machines and brooms, including those pulled by separate units, truck driver helpers, warehouse employees, mechanic helpers, greasers and tiremen, pickup trucks when hauling materials, tools, or workers to and from and on-the-job site, and fork lifts up to 6,000 lb. capacity.

Class 2. Two or three axle trucks hauling more than 9 ton but hauling less than 16 ton. A-frame winch trucks, hydrolift trucks, vector trucks or similar equipment when used for transportation purposes. Fork lifts over 6,000 lb. capacity, winch trucks, four axle combination units, and ticket writers.

Class 3. Two, three or four axle trucks hauling 16 ton or more. Drivers on water pulls, articulated dump trucks, mechanics and working forepersons, and dispatchers. Five axle or more combination units.

Class 4. Low Boy and Oil Distributors.

Class 5. Drivers who require special protective clothing while employed on hazardous waste work.

#### TRUCK DRIVER - O & C (Oil and Chip Resealing ONLY)

It involves driving of contractor or subcontractor owned, leased, or hired pickup, dump, service, or oil distributor trucks. Includes transporting materials and equipment (including, but not limited to oils, aggregate supplies, parts, machinery and tools) to or from the job site; distributing oil or liquid asphalt and aggregate; stock piling material; and maintaining trucks at job site related to oil and chip resealing.

Class 1. Distributors, liquid asphalt hauling and hauling of asphalt rubber-tired rollers.

Class 2. Stockpiling.

Class 3. Tandem hauling to job site.

OPERATING ENGINEERS - BUILDING, HEAVY AND HIGHWAY CONSTRUCTION

Class 1. APSCO or Equal Spreading Machine, Backhoe, Backfiller, Boom or Winch Cat, Bituminous Mixplane Machine, Blacksmith, Bituminous Surfacing Machine, Bull-Dozer, Crane, Shovel, Dragline, Truck Crane, Pile Driver, Concrete Breaker, Concrete or Pumpcrete Pumps, Dinky or Standard Locomotives, Well or Caisson Drills, Elevating Grader, Fork Lifts, Flexplane, Gradeall, Hi-Lift Hoists, Guy-Derricks, Hysters, Mechanic Motor Patrol, Mixers-21 cu. ft. or over, Push Cats, Pulls and Scrapers, Two Well Point Pumps, Pulverizer or Tiller, PugMill, Rubber-Tired Farm Type Tractor with Bulldozer/Blade/Auger or hi-lift over 1/2 yd., Jersey Spreader, Tract-Air used with Drill or Hi-Lift, Trenching or Ditching Machines, Wood Chipper w/Tractor, Self-Propelled Roller w/Blade, Equipment Greaser, Self-Propelled Bump Grinder on Concrete pavement, Boat Operator, Skid-Loaders, Tuggers, Lazer Screed, and Self-Propelled Chip Spreader (when others run conveyors).

Class 2. Any type tractor pulling any type roller or disc, Two Air Compressors (220 cu. ft. capacity or over), Two AirTract Drills, Air-Track Drill w/Compressor, Automatic Bins or Scales w/Compressor or Generator, Pipeline Boring Machine, Bulk Cement Plant w/Separate Compressor, Power Operated Bull Float, Hydra-Lift w/Single Motor, Straw Mulcher Blower w/Spout, Self-Propelled Roller/Compactor, Back-End man on Bituminous Surfacing Machine, oiler on milling machine.

Class 3. Air Compressor w/Valve driving piling, Boom or Winch Type Truck, Two Conveyors, Self-Propelled Concrete Saw, Form Grader, Truck Crane Oiler, Self-Propelled Vibrator, Rubber Tired Farm Type Tractor w/Blade/Bulldozer/Auger/hi-lift - 1/2 yd. or less, Elevator Operator, Man Lift (scissor lift) when lifting materials.

Class 4. Air-Track Drill (one), Belt Drag Machine, Power Broom, Mechanical Plasterer Applicator, Trac-Air, Air Compressor (220 cu. ft. or over) One, Air Compressor (under 220 cu. ft) four, Automatic Bin, Bulk Cement Plant w/Built-in Compressor running off same motor or electric motor, Fireman or Switchman, Self-Propelled Form Tamper, Light Plants (4), Welding Machines (4), Pumps (4), or Combination of four (4) Pumps, Light Plants, Welding Machines, Air-Compressors (under 220 cu. ft.), Mudjacks or Wood Chipper, Mixers - less than 21 cu. ft. Mortar Mixer w/Skip or Pump, Pipeline Tract Jack. One Operating Engineer may operate and maintain any combination of the following pieces of equipment, not to exceed four (4) which shall be within a reasonable distance, such combination may include any equipment in this classification: (Compressors, Light Plants, Generators, Welding Machines, Pumps or Conveyors), One Well- Point Pump, Two Motor Driven Heaters, One Air Compressor (under 220 cu. ft.), One Engine-Driven Conveyor, One Motor Driven Heater, One Light Plant, One Pump, One Welding Machine, One Ulmac or Equal Spreader, Oilers, and one Generator 10 kw or greater.

OPERATING ENGINEER - O & C (Oil and Chip Resealing ONLY). Includes the operation of all motorized heavy equipment used in oil and chip rsealing, including but not limited to operating self-propelled chip spreaders, and all types of rollers (both hard and rubber tired); and other duties pertaining to the operation or maintenance of heavy equipment related to oil and chip resealing.

Class 1. See Class 1 above for types of equipment operated.

Class 2. See Class 2 above for types of equipment operated.

Class 3. See Class 3 above for types of equipment operated.

Class 4. See Class 4 above for types of equipment operated.

OPERATING ENGINEER RIVER WORK 1 - operate the following machines when working on River Work and Levee Work on the Mississippi and Ohio Rivers, Lakes and Tributaries: Crane, Shovel, Drageline, Scrapers, Dredge, Derrick, Pile-Driver, Push Boat, all power boat operators, Mechanic, Engineman on Dredge, Leverman on Dredge, All Bituminous Spreader machines, Backhoe, Backfiller, Boom, or Winch Cat, Bituminous Mixplane Machine, Blacksmith, Bituminous Surfacing Machine, Bulldozer, Truck Cranes, Hydraulic Truck Mounted Boom/Crane, Concrete Finishing Machine, or Spreader Machine, Concrete Breaker, Concrete or Pumpcrete Machines, Concrete Plant Operator, All Off Road Material Hauling Equipment, Dinky or Standard Locomotives, Well Drill, Elevating Grader, Fork-Lifts, Flexplane, Gradeall, Hi-Lift, Power Handblade Tugger type Hoist, Hoist Two Drum (or over one), Gyderrick, Hyster, Motor Patrol, Mixers - 21 Cu. Ft. or over, Push Cat, Pulls, & Scrapers, Pumps-Two Well Points, Equipment Greaser, P & H Pulverizer or Pulverizer equal to Pugmill, Pugmill, Rubber-Tired farm type tractor w/Bulldozer/Blade/Auger or Hi-Lift over ½ yard, Skimmer Scoops, Seaman Tiller, Jersey Spreader, Tract-Air used with Drill or Hi-Lift, Trenching or Ditching Machine, Wood Chipper w/Tractor, self-propelled roller w/Blade, Concrete Pumps and Small Equipment Operators.

OPERATING ENGINEER RIVER 2 - when working on River Work and Levee Work on the Mississippi and Ohio Rivers, Lakes and Tributaries shall be employed as the Oiler or Fireman on Crane, Dragline, Shovel, Dredge, Truck Crane, Pile Driver, Gradeall, Dinky or Standard Locomotive, Guy Derrick, Trenching Machine or Ditching Machine 80 H.P. and over, All Terrain (cherry-picker) with over 40 ton Lifting Capacity, Deck Oiler and Deckhands.

#### Other Classifications of Work:

For definitions of classifications not otherwise set out, the Department generally has on file such definitions which are available. If a task to be performed is not subject to one of the classifications of pay set out, the Department will upon being contacted state which neighboring county has such a classification and provide such rate, such rate being deemed to exist by reference in this document. If no neighboring county rate applies to the task, the Department shall undertake a special determination, such special determination being then deemed to have existed under this determination. If a project requires these, or any classification not listed, please contact IDOL at 618/993-7271 for wage rates or clarifications.

#### LANDSCAPING

Landscaping work falls under the existing classifications for laborer, operating engineer and truck driver. The work performed by landscape plantsman and landscape laborer is covered by the existing classification of laborer. The work performed by landscape operators (regardless of equipment used or its size) is covered by the classifications of operating engineer. The work performed by landscape truck drivers (regardless of size of truck driven) is covered by the classifications of truck driver.



# Putnam County Prevailing Wage for April 2007

Trade Name	RG	TYP	C	Base	FRMAN	*M-F>8	OSA	OSH	H/W	Pensn	Vac	Trng
=====	==	===	=	=====	=====	=====	===	===	=====	=====	=====	=====
ASBESTOS ABT-GEN		ALL		25.460	26.460	1.5	1.5	2.0	5.850	4.500	0.000	0.600
ASBESTOS ABT-MEC		BLD		23.300	24.800	1.5	1.5	2.0	7.860	4.910	0.000	0.000
BOILERMAKER		BLD		30.970	33.970	2.0	2.0	2.0	8.270	7.740	0.000	0.300
BRICK MASON		BLD		29.500	30.500	1.5	1.5	5.0	6.070	6.000	0.000	0.400
CARPENTER		BLD		27.220	28.720	1.5	1.5	2.0	5.810	8.170	0.000	0.570
CARPENTER		HWY		26.480	28.230	1.5	1.5	2.0	5.810	7.670	0.000	0.500
CEMENT MASON		ALL		30.000	31.000	2.0	2.0	2.0	5.500	5.390	0.000	0.100
CERAMIC TILE FNSHER		BLD		24.860	0.000	1.5	1.5	2.0	5.500	4.000	0.000	0.360
COMMUNICATION TECH		BLD		29.110	30.610	1.5	1.5	2.0	8.270	8.670	0.000	0.290
ELECTRIC PWR EQMT OP		ALL		30.750	0.000	1.5	1.5	2.0	4.750	8.610	0.000	0.000
ELECTRIC PWR GRNDMAN		ALL		21.090	0.000	1.5	1.5	2.0	4.750	5.905	0.000	0.000
ELECTRIC PWR LINEMAN		ALL		34.160	36.350	1.5	1.5	2.0	4.750	9.560	0.000	0.000
ELECTRIC PWR TRK DRV		ALL		22.130	0.000	1.5	1.5	2.0	4.750	6.200	0.000	0.000
ELECTRICIAN		BLD		33.950	37.010	1.5	1.5	2.0	8.570	11.01	0.000	0.340
ELEVATOR CONSTRUCTOR		BLD		34.190	38.460	2.0	2.0	2.0	8.275	6.060	2.050	0.000
GLAZIER		BLD		26.320	27.070	1.5	1.5	2.0	5.650	5.750	0.000	0.350
HT/FROST INSULATOR		BLD		33.300	35.050	1.5	1.5	2.0	7.860	8.610	0.000	0.310
IRON WORKER		ALL		28.000	29.000	2.0	2.0	2.0	8.040	11.85	0.000	0.550
LABORER		ALL		24.460	25.460	1.5	1.5	2.0	5.850	4.500	0.000	0.600
LABORER, SKILLED		BLD		24.860	25.860	1.5	1.5	2.0	5.850	4.500	0.000	0.600
LABORER, SKILLED		HWY		24.860	25.860	1.5	1.5	2.0	5.850	4.500	0.000	0.600
LATHER		BLD		27.220	28.720	1.5	1.5	2.0	5.810	8.170	0.000	0.570
MACHINIST		BLD		36.890	38.890	2.0	2.0	2.0	4.380	5.650	2.550	0.000
MARBLE FINISHERS		BLD		24.860	0.000	1.5	1.5	2.0	5.500	4.000	0.000	0.360
MARBLE MASON		BLD		28.140	28.390	1.5	1.5	2.0	5.500	5.220	0.000	0.380
MILLWRIGHT		BLD		32.000	35.200	1.5	1.5	2.0	6.100	9.250	0.000	0.560
MILLWRIGHT		HWY		17.100	18.350	1.5	1.5	2.0	1.450	1.500	0.000	0.000
OPERATING ENGINEER	E	BLD	1	39.750	43.750	2.0	2.0	2.0	6.850	5.600	1.900	0.700
OPERATING ENGINEER	E	BLD	2	38.450	43.750	2.0	2.0	2.0	6.850	5.600	1.900	0.700
OPERATING ENGINEER	E	BLD	3	35.900	43.750	2.0	2.0	2.0	6.850	5.600	1.900	0.700
OPERATING ENGINEER	E	BLD	4	34.150	43.750	2.0	2.0	2.0	6.850	5.600	1.900	0.700
OPERATING ENGINEER	E	HWY	1	39.750	43.750	1.5	1.5	2.0	6.850	5.600	1.900	0.700
OPERATING ENGINEER	E	HWY	2	39.200	43.750	1.5	1.5	2.0	6.850	5.600	1.900	0.700
OPERATING ENGINEER	E	HWY	3	37.150	43.750	1.5	1.5	2.0	6.850	5.600	1.900	0.700
OPERATING ENGINEER	E	HWY	4	35.750	43.750	1.5	1.5	2.0	6.850	5.600	1.900	0.700
OPERATING ENGINEER	E	HWY	5	34.550	43.750	1.5	1.5	2.0	6.850	5.600	1.900	0.700
OPERATING ENGINEER	W	BLD	1	27.840	30.840	1.5	1.5	2.0	5.900	8.000	0.000	0.900
OPERATING ENGINEER	W	BLD	2	25.940	30.840	1.5	1.5	2.0	5.900	8.000	0.000	0.900
OPERATING ENGINEER	W	BLD	3	24.560	30.840	1.5	1.5	2.0	5.900	8.000	0.000	0.900
OPERATING ENGINEER	W	HWY	1	29.110	32.110	1.5	1.5	2.0	6.250	9.000	0.000	1.000
OPERATING ENGINEER	W	HWY	2	26.730	32.110	1.5	1.5	2.0	6.250	9.000	0.000	1.000
OPERATING ENGINEER	W	HWY	3	22.790	32.110	1.5	1.5	2.0	6.250	9.000	0.000	1.000
PAINTER		ALL		26.850	27.850	1.5	1.5	1.5	5.650	5.750	0.000	0.350
PAINTER SIGNS		BLD		28.970	32.520	1.5	1.5	1.5	2.600	2.310	0.000	0.000
PILEDRIIVER		BLD		27.470	28.970	1.5	1.5	2.0	5.810	8.170	0.000	0.570
PILEDRIIVER		HWY		26.480	28.230	1.5	1.5	2.0	5.810	7.670	0.000	0.500
PIPEFITTER		BLD		37.600	39.600	1.5	1.5	2.0	8.660	6.900	0.000	0.940
PLASTERER		BLD		30.000	31.000	2.0	2.0	2.0	5.500	5.390	0.000	0.100
PLUMBER		BLD		37.500	39.500	1.5	1.5	2.0	7.050	8.500	0.000	0.760
ROOFER		BLD		26.560	27.560	1.5	1.5	2.0	6.460	3.310	0.000	0.330
SHEETMETAL WORKER		BLD		29.890	31.140	1.5	1.5	2.0	5.770	6.730	0.000	0.200
SPRINKLER FITTER		BLD		31.240	33.240	1.5	1.5	2.0	6.500	5.350	0.000	0.250
STONE MASON		BLD		29.500	30.500	1.5	1.5	5.0	6.070	6.000	0.000	0.400
TERRAZZO FINISHER		BLD		24.860	0.000	1.5	1.5	2.0	5.500	4.000	0.000	0.360
TILE LAYER		BLD		27.220	28.720	1.5	1.5	2.0	5.810	8.170	0.000	0.570
TILE MASON		BLD		28.140	28.390	1.5	1.5	2.0	5.500	5.220	0.000	0.380
TRUCK DRIVER		ALL	1	25.787	0.000	1.5	1.5	2.0	7.250	3.317	0.000	0.000
TRUCK DRIVER		ALL	2	26.187	0.000	1.5	1.5	2.0	7.250	3.317	0.000	0.000
TRUCK DRIVER		ALL	3	26.387	0.000	1.5	1.5	2.0	7.250	3.317	0.000	0.000

TRUCK DRIVER	ALL	4	26.637	0.000	1.5	1.5	2.0	7.250	3.317	0.000	0.000
TRUCK DRIVER	ALL	5	27.387	0.000	1.5	1.5	2.0	7.250	3.317	0.000	0.000
TRUCK DRIVER	O&C	1	20.630	0.000	1.5	1.5	2.0	7.250	3.317	0.000	0.000
TRUCK DRIVER	O&C	2	20.950	0.000	1.5	1.5	2.0	7.250	3.317	0.000	0.000
TRUCK DRIVER	O&C	3	21.110	0.000	1.5	1.5	2.0	7.250	3.317	0.000	0.000
TRUCK DRIVER	O&C	4	21.310	0.000	1.5	1.5	2.0	7.250	3.317	0.000	0.000
TRUCK DRIVER	O&C	5	21.910	0.000	1.5	1.5	2.0	7.250	3.317	0.000	0.000
TUCKPOINTER	BLD		29.500	30.500	1.5	1.5	5.0	6.070	6.000	0.000	0.400

Legend:

M-F>8 (Overtime is required for any hour greater than 8 worked each day, Monday through Friday.)

OSA (Overtime is required for every hour worked on Saturday)

OSH (Overtime is required for every hour worked on Sunday and Holidays)

H/W (Health & Welfare Insurance)

Pensn (Pension)

Vac (Vacation)

Trng (Training)

## Explanations

### PUTNAM COUNTY

OPERATING ENGINEERS (EAST) - That part of the county east of the Illinois River.

The following list is considered as those days for which holiday rates of wages for work performed apply: New Years Day, Memorial/Decoration Day, Fourth of July, Labor Day, Veterans Day, Thanksgiving Day, Christmas Day. Generally, any of these holidays which fall on a Sunday is celebrated on the following Monday. This then makes work performed on that Monday payable at the appropriate overtime rate for holiday pay. Common practice in a given local may alter certain days of celebration such as the day after Thanksgiving for Veterans Day. If in doubt, please check with IDOL.

Oil and chip resealing (O&C) means the application of road oils and liquid asphalt to coat an existing road surface, followed by application of aggregate chips or gravel to coated surface, and subsequent rolling of material to seal the surface.

### EXPLANATION OF CLASSES

ASBESTOS - GENERAL - removal of asbestos material/mold and hazardous materials from any place in a building, including mechanical systems where those mechanical systems are to be removed. This includes the removal of asbestos materials/mold and hazardous materials from ductwork or pipes in a building when the building is to be demolished at the time or at some close future date.

ASBESTOS - MECHANICAL - removal of asbestos material from mechanical systems, such as pipes, ducts, and boilers, where the mechanical systems are to remain.

#### CERAMIC TILE FINISHER, MARBLE FINISHER, TERRAZO FINISHER

Assisting, helping or supporting the tile, marble and terrazzo mechanic by performing their historic and traditional work assignments required to complete the proper installation of the work covered by said crafts. The term "Ceramic" is used for naming the classification only and is in no way a limitation of the product handled. Ceramic takes into consideration most hard tiles.

#### COMMUNICATIONS TECHNICIAN

Installation, operation, inspection, maintenance, repair and service of radio, television, recording, voice, sound and vision production and reproduction, telephone and telephone interconnect, facsimile, equipment and appliances used for domestic, commercial, educational and entertainment purposes, pulling of wire through conduit but not the installation of conduit.

#### LABORER, SKILLED - BUILDING AND HIGHWAY

The skilled laborer building (BLD) and heavy & highway (HWY) classification shall encompass the following types of work, irrespective of the site of the work: flagging, caisson worker plus depth, gunnite nozzle men, lead man on sewer work, welders, cutter burners and torchmen, chain saw operator, paving breaker, jackhammer and drill operators, layout man and/or drainage tile layer, steel form setter - street and highway, air tamping hammerman, signal man on crane, concrete saw operator, concrete saw operator walk behind, screenman on asphalt pavers, front end man on chip spreader, laborers tending masons with hot material or where foreign materials are used, multiple concrete duct - leadman, luteman, asphalt raker, curb asphalt machine operator, ready mix scalemen (permanent, portable or temporary plant), laborers handling masterplate or similar materials, laser beam operator, coring machine operator, plaster tenders, underpinning and shoring of buildings, material selector when working with fire-brick or castable material, fire watch, signaling of all power equipment, tree topper or trimmer when in connection with construction, and diver tender.

#### TRUCK DRIVER - BUILDING, HEAVY AND HIGHWAY CONSTRUCTION

Class 1. Drivers on 2 axle trucks hauling less than 9 ton. Air compressor and welding machines and brooms, including those pulled by separate units, truck driver helpers, warehouse employees, mechanic helpers, greasers and tiremen, pickup trucks when hauling materials, tools, or workers to and from and on-the-job site, and fork lifts up to 6,000 lb. capacity.

Class 2. Two or three axle trucks hauling more than 9 ton but hauling less than 16 ton. A-frame winch trucks, hydrolift trucks, vector trucks or similar equipment when used for transportation purposes. Fork lifts over 6,000 lb. capacity, winch trucks, four axle combination units, and ticket writers.

Class 3. Two, three or four axle trucks hauling 16 ton or more. Drivers on water pulls, articulated dump trucks, mechanics and working forepersons, and dispatchers. Five axle or more combination units.

Class 4. Low Boy and Oil Distributors.

Class 5. Drivers who require special protective clothing while employed on hazardous waste work.

TRUCK DRIVER - OIL AND CHIP RESEALING ONLY.

This shall encompass laborers, workers and mechanics who drive contractor or subcontractor owned, leased, or hired pickup, dump, service, or oil distributor trucks. The work includes transporting materials and equipment (including but not limited to, oils, aggregate supplies, parts, machinery and tools) to or from the job site; distributing oil or liquid asphalt and aggregate; stock piling material when in connection with the actual oil and chip contract. The Truck Driver (Oil & Chip Resealing) wage classification does not include supplier delivered materials.

OPERATING ENGINEERS - BUILDING - EAST

Class 1. Assistant Craft Foreman; Craft Foreman; Mechanic; Asphalt Plant; Asphalt Spreader; Autograde; Backhoes w/Caisson attachment; Batch Plant; Benoto; Boiler and Throttle Valve; Caisson Rigs; Central Redi-Mix Plant; Combination Back Hoe Front End-loader Machine; Compressor and Throttle Valve; Concrete Breaker (Truck Mounted); Concrete Conveyor; Concrete Paver; Concrete Placer; Concrete Pump (Truck Mounted); Concrete Tower; Cranes, All; Cranes, Hammerhead; Creter Crane; Crusher, Stone, etc.; Derricks, All; Derricks, Traveling; Formless Curb and Gutter Machine; Grader, Elevating; Grouting Machines; Highlift Shovels or Front Endloader 2-1/4 yd. and over; Hoists, Elevators, outside type rack and pinion and similar machines; Hoists, one, two and three Drum; Hoists, Two tigger One Floor; Hydraulic Backhoes; Hydraulic Boom Trucks; Hydro Vac (and similar equipment.); Locomotives, All; Motor Patrol; Pile Drivers and Skid Rig; Post Hole Digger; Pre-Stress Machine; Pump Cretes; Squeeze Cretes-screw Type Pumps; Gypsum Bulker and Pump; Roto Mill Grinder; Scoops - Tractor Drawn; Slip-form Paver; Straddle Buggies; Tournapull; Tractor with Boom and Side Boom; Trenching Machines.

Class 2. Boilers; Broom, All Power Propelled; Bulldozers; Concrete Mixer (Two Bag and Over); Conveyor, Portable; Forklift Trucks; Greaser Engineer; Highlift Shovels or Front Endloaders under 2-1/4 yd.; Hoists, Automatic; Hoists, inside Freight Elevators; Hoists, Sewer Dragging Machine; Hoists, Tigger Single Drum; Laser Screed; Rock Drill (self-propelled); Rock Drill (Truck mounted); Rollers, All; Steam Generators; Tractors, All; Tractor Drawn Vibratory Roller; Winch Trucks with "A" Frame.

Class 3. Air Compressors; Combination - Small Equipment Operator; Generators; Heaters, Mechanical; Hoists, Inside Elevators - (Rheostat Manual Controlled); Hoists, Inside Elevators; Hydraulic Power Units (Pile Driving and Extracting); Vibratory Roller; Lowboys; Pumps, over 3" (1 to 3 not to exceed a total of 300 ft.); Pumps, Well Points; Welding Machines (2 through 5); Winches, 4 small Electric Drill Winches.

Class 4. Bobcat/Skid Steer Loader; Brick Forklift; Hoists, Inside Elevators push button with automatic doors; Oilers.

OPERATING ENGINEERS - HEAVY AND HIGHWAY CONSTRUCTION - EAST

Class 1. Craft Foreman; Asphalt Plant; Asphalt Heater and Planer Combination; Asphalt Heater Scarfire; Asphalt Spreader; Autograder; ABC Paver; Backhoes with Caisson Attachment; Belt Loader; Caisson Rigs; Car Dumper; Central Redi-Mix Plant; Combination Backhoe Front Endloader Machine, (1 cu. yd. Backhoe Bucket or over or with attachments); Concrete Breaker (Truck Mounted); Concrete Conveyor;

Concrete Paver over 27E cu. ft.; Concrete Placer; Concrete Tube Float; Cranes, all attachments; Cranes, Hammerhead, Linden, Peco & Machines of a like nature; Creter Crane; Crusher, Stone, etc.; Derricks, All; Derrick Boats; Derricks, Traveling; Dowell Machine; Dredges; Field Mechanic-Welder; Formless Curb and Gutter Machine; Gradall and Machines of a like nature; Grader, Elevating; Grader, Motor Grader, Motor Patrol, Auto Patrol, Form Grader, Pull Grader, Subgrader; Guard Rail Post Driver Truck Mounted; Hoists, One, Two and Three Drum; Hydraulic Backhoes; Mucking Machine; Pile Drivers and Skid Rig; Pre-Stress Machine; Pump Cretes Dual Ram; Rock/Track Tamper; Rock Drill - Truck Mounted; Roto Mill Grinder; Slip-Form Paver; Soil Test Drill Rig (Truck Mounted); Straddle Buggies; Hydraulic Telescoping form (Tunnel); Tractor Drawn Belt Loader with attached pusher; Tractor with Boom; Tractaire with Attachments; Trenching Machine; Truck Mounted Concrete Pump with Boom; Raised or Blind Hole; Drills (Tunnel Shaft); Underground Boring and/or Mining Machines; Wheel Excavator; Widener (APSCO).

Class 2. Batch Plant; Bituminous Mixer; Boiler and Throttle Valve; Bulldozers; Car Loader Trailing Conveyors; Combination Backhoe Front Endloader Machine (less than 1 cu. yd. Backhoe Bucket or over or with attachments); Compressor and Throttle Valve; Compressor, Common Receiver (3); Concrete Breaker or Hydro Hammer; Concrete Grinding Machine; Concrete Mixer or Paver 7S Series to and including 27 cu. ft.; Concrete Spreader; Concrete Curing Machine, Burlap Machine, Belting Machine and Sealing Machine; Concrete Wheel Saw; Conveyor Muck Cars (Haglund or Similar Type); Drills, All; Finishing Machine - Concrete; Greaser Engineer; Highlift Shovels or Front Endloader; Hoist - Sewer Dragging Machine; Hydraulic Boom Trucks (All Attachments); Hydro-Blaster; Locomotives, Dinky; Laser Screed; Pump Cretes; Squeeze Cretes-Screw Type Pumps, Gypsum Bulker and Pump; Rock Drill - Crawler or Skid Rig; Rock Drill - Truck Mounted; Roller, Asphalt; Rotary Snow Plows; Rototiller, Seaman, etc., self-propelled; Scoops - Tractor Drawn; Self-Propelled Compactor; Spreader - Chip - Stone, etc.; Scraper; Scraper - Prime Mover in Tandem; Tank Car Heater; Tractors, Push, Pulling Sheeps Foot, Disc, Compactor, etc. Tug Boats.

Class 3. Boilers; Brooms, All Power Propelled; Cement Supply Tender; Compressor, Common Receiver (2); Concrete Mixer (Two Bag and Over); Conveyor, Portable; Farm-Type Tractors Used for Mowing, Seeding, etc.; Fireman on Boilers; Forklift Trucks; Grouting Machine; Hoists, Automatic; Hoists, All Elevators; Hoists, Tugger Single Drum; Jeep Diggers; Pipe Jacking Machines; Post-Hole Digger; Power Saw, Concrete Power Driven; Pug Mills; Rollers, other than asphalt; Seed and Straw Blower; Steam Generators; Stump Machine; Winch Trucks with "A" Frame; Work Boats; Tamper - Form-Motor Driven.

Class 4. Air Compressor; Combination - Small Equipment Operator; Directional Boring Machine; Generators; Heaters, Mechanical; Hydraulic Power Unit (Pile Driving, Extracting, or Drilling); Hydro-Blaster; Light Plants, All (1 through 5); Pumps, over 3" (1 to 3 not to exceed a total of 300 ft.); Pumps; Tractaire; Welding Machines (2 through 5); Winches.

Class 5. Bobcats (All); Brick Forklifts; Oilers.

#### OPERATING ENGINEERS - BUILDING - WEST

Class 1. Cranes; Overhead Cranes; Gradall; All Cherry Pickers; Mechanics; Central Concrete Mixing Plant Operator; Road Pavers (27E - Dual Drum - Tri Batchers); Blacktop Plant Operators and Plant Engineers; 3 Drum Hoist; Derricks; Hydro Cranes; Shovels; Skimmer

Scoops; Koehring Scooper; Drag Lines; Backhoe; Derrick Boats; Pile Drivers and Skid Rigs; Clamshells; Locomotive Cranes; Dredge (all types) Motor Patrol; Power Blades - Dumore - Elevating and similar types; Tower Cranes (Crawler-Mobile) and Stationary; Crane-type Backfiller; Drott Yumbo and similar types considered as Cranes; Caisson Rigs; Dozer; Tournadozer; Work Boats; Ross Carrier; Helicopter; Tournapulls - all and similar types; Scoops (all sizes); Pushcats; Endloaders (all types); Asphalt Surfacing Machine; Slip Form Paver; Rock Crusher; Heavy Equipment Greaser; CMI, CMI Belt Placer, Auto Grade & 3 Track and similar types; Side Booms; Multiple Unit Earth Movers; Creter Crane; Trench Machine; Pump-crete-Belt Crete-Squeeze Cretes-Screw-type Pumps and Gypsum; Bulker & Pump - Operator will clean; Formless Finishing Machine; Flaherty Spreader or similar types; Screed Man on Laydown Machine; Wheel Tractors (industrial or Farm-type w/Dozer-Hoe-Endloader or other attachments); F.W.D. & Similar Types; Vermeer Concrete Saw.

Class 2. Dinkeys; Power Launches; PH One-pass Soil Cement Machine (and similar types); Pugmill with Pump; Backfillers; Euclid Loader; Forklifts; Jeeps w/Ditching Machine or other attachments; Tuneluger; Automatic Cement and Gravel Batching Plants; Mobile Drills (Soil Testing) and similar types; Gurries and Similar Types; (1) and (2) Drum Hoists (Buck Hoist and Similar Types); Chicago Boom; Boring Machine & Pipe Jacking Machine; Hydro Boom; Dewatering System; Straw Blower; Hydro Seeder; Assistant Heavy Equipment Greaser on Spread; Tractors (Track type) without Power Unit pulling Rollers; Rollers on Asphalt -- Brick Macadem; Concrete Breakers; Concrete Spreaders; Mule Pulling Rollers; Center Stripper; Cement Finishing Machines & CMI Texture & Reel Curing Machines; Cement Finishing Machine; Barber Green or similar loaders; Vibro Tamper (All similar types) Self-propelled; Winch or Boom Truck; Mechanical Bull Floats; Mixers over 3 Bag to 27E; Tractor pulling Power Blade or Elevating Grader; Porter Rex Rail; Clary Screed; Truck Type Hoptoe Oilers; Fireman; Spray Machine on Paving; Curb Machines; Truck Crane Oilers; Oil Distributor; Truck-Mounted Saws.

Class 3. Air Compressor; Power Subgrader; Straight Tractor; Trac Air without attachments; Herman Nelson Heater, Dravo, Warner, Silent Glo, and similar types; Roller: Five (5) Ton and under on Earth or Gravel; Form Grader; Crawler Crane & Skid Rig Oilers; Freight Elevators - permanently installed; Pump; Light Plant; Generator; Conveyor (1) or (2) - Operator will clean; Welding Machine; Mixer (3) Bag and Under (Standard Capacity with skip); Bulk Cement Plant; Oiler on Central Concrete Mixing Plant.

#### OPERATING ENGINEERS - HEAVY AND HIGHWAY CONSTRUCTION - WEST

Class 1. Cranes; Hydro Crane; Shovels; Crane Type Backfiller; Tower Cranes - Mobile & Crawler & Stationary; Derricks & Hoists (3 Drum); Draglines; Drott Yumbo & similar types considered as Cranes; Back Hoe; Derrick Boats; Pile Driver and Skid Rigs; Clam Shell; Locomotive - Cranes; Road Pavers - Single Drum - Dual Drum - Tri Batcher; Motor Patrols & Power Blades - Dumore - Elevating & Similar Types; Mechanics; Central Concrete Mixing Plant Operator; Asphalt Batch Plant Operators and Plant Engineers; Gradall; Caisson Rigs; Skimmer Scoop - Koering Scooper; Dredges (all types); Hoptoe; All Cherry Pickers; Work Boat; Ross Carrier; Helicopter; Dozer; Tournadozer; Tournapulls - all and similar types; Multiple Unit Earth Movers; Scoops (all sizes); Pushcats; Endloaders (all types); Asphalt Surfacing Machine; Slip Form Paver; Rock Crusher; Heavy Equipment Greaser (top greaser on spread); CMI, Auto Grade, CMI Belt Placer & 3 Track and similar types; Side Booms; Starting Engineer on Pipeline; Asphalt Heater & Planer Combination (used to plane streets); Wheel Tractors (with

dozer, hoe or endloader attachments); F.W.D. and Similar types; Blaw Knox Spreader and Similar types; Trench Machines; Pump Crete - Belt Crete - Squeeze Crete - screw type pumps and gypsum (operator will clean); Formless Finishing Machines; Flaherty Spreader or similar types; Screed Man on Laydown Machine; Vermeer Concrete Saw.

Class 2. Bulker & Pump; Power Launches; Boring Machine & Pipe Jacking Machine; Dinkeys; P-H One Pass Soil Cement Machines and similar types; Wheel Tractors (Industry or farm type - other); Back Fillers; Euclid Loader; Fork Lifts; Jeep w/Ditching Machine or other attachments; Tunneluger; Automatic Cement & Gravel Batching Plants; Mobile Drills - Soil Testing and similar types; Pugmill with pump; All (1) and (2) Drum Hoists; Dewatering System; Straw Blower; Hydro-Seeder; Boring Machine; Hydro-Boom; Bump Grinders (self-propelled); Assistant Heavy Equipment Greaser; Apsco Spreader; Tractors (track-type) without Power Units Pulling Rollers on Asphalt - Brick or Macadam; Concrete Breakers; Concrete Spreaders; Cement Strippers; Cement Finishing Machines & CMI Texture & Reel Curing Machines; Vibro-Tampers (all similar types self-propelled); Mechanical Bull Floats; Self-propelled Concrete Saws; Mixers-over three (3) bags to 27E; Winch and Boom Trucks; Tractor Pulling Power Blade or Elevating Grader; Porter Rex Rail; Clary Screed; Mule Pulling Rollers; Pugmill without Pump; Barber Greene or similar Loaders; Track Type Tractor w/Power Unit attached (minimum); Fireman; Spray Machine on Paving; Curb Machines; Paved Ditch Machine; Power Broom; Self-Propelled Conveyors; Power Subgrader; Oil Distributor; Straight Tractor; Truck Crane Oiler; Truck Type Oilers; Directional boring machine; Horizontal directional drill.

Class 3. Straight framed articulating end dump vehicle and Truck mounted vac unit (separately powered); Trac Air Machine (without attachments); Herman Nelson Heater, Dravo Warner, Silent Glo & similar types; Rollers - five ton and under on earth and gravel; Form Graders; Pumps; Light Plant; Generator; Air Compressor (1) or (2); Conveyor; Welding Machine; Mixer - 3 bags and under; Bulk Cement Plant; Oilers.

#### Other Classifications of Work:

For definitions of classifications not otherwise set out, the Department generally has on file such definitions which are available. If a task to be performed is not subject to one of the classifications of pay set out, the Department will upon being contacted state which neighboring county has such a classification and provide such rate, such rate being deemed to exist by reference in this document. If no neighboring county rate applies to the task, the Department shall undertake a special determination, such special determination being then deemed to have existed under this determination. If a project requires these, or any classification not listed, please contact IDOL at 618/993-7271 for wage rates or clarifications.

#### LANDSCAPING

Landscaping work falls under the existing classifications for laborer, operating engineer and truck driver. The work performed by landscape plantsman and landscape laborer is covered by the existing classification of laborer. The work performed by landscape operators (regardless of equipment used or its size) is covered by the classifications of operating engineer. The work performed by landscape truck drivers (regardless of size of truck driven) is covered by the classifications of truck driver.

# Randolph County Prevailing Wage for April 2007

Trade Name	RG	TYP	C	Base	FRMAN	*M-F>8	OSA	OSH	H/W	Pensn	Vac	Trng
=====	==	===	=	=====	=====	=====	===	===	=====	=====	=====	=====
ASBESTOS ABT-GEN		ALL		22.600	23.100	1.5	1.5	2.0	5.250	8.200	0.000	0.600
ASBESTOS ABT-MEC		BLD		25.290	26.290	1.5	1.5	2.0	4.450	2.500	0.000	0.250
BOILERMAKER		BLD		28.500	31.000	1.5	1.5	2.0	6.820	11.03	0.000	0.300
BRICK MASON		BLD		25.470	26.970	1.5	1.5	2.0	6.000	5.400	0.000	0.425
CARPENTER		ALL		30.480	31.980	1.5	1.5	2.0	5.050	3.750	0.000	0.350
CEMENT MASON		BLD		23.500	24.500	1.5	1.5	2.0	5.200	3.550	0.000	0.100
CEMENT MASON		HWY		23.750	24.750	1.5	1.5	2.0	5.300	3.700	0.000	0.300
CERAMIC TILE FNSHER		BLD		24.990	0.000	1.5	1.5	2.0	6.000	5.400	0.000	0.425
ELECTRIC PWR EQMT OP		ALL		31.510	37.980	1.5	2.0	2.0	4.530	7.880	0.000	0.160
ELECTRIC PWR GRNDMAN		ALL		23.530	37.980	1.5	2.0	2.0	3.380	5.890	0.000	0.120
ELECTRIC PWR LINEMAN		ALL		36.220	37.980	1.5	2.0	2.0	5.210	9.060	0.000	0.180
ELECTRIC PWR TRK DRV		ALL		25.710	37.980	1.5	2.0	2.0	3.700	6.430	0.000	0.130
ELECTRICIAN	NW	ALL		32.590	34.550	1.5	1.5	2.0	5.210	6.360	0.000	0.490
ELECTRICIAN	SE	ALL		32.910	35.160	1.5	1.5	2.0	5.150	6.580	0.000	0.490
ELECTRONIC SYS TECH	NW	BLD		25.810	27.310	1.5	1.5	2.0	2.800	5.490	0.000	0.250
ELECTRONIC SYS TECH	SE	BLD		25.700	27.200	1.5	1.5	2.0	5.150	3.340	0.000	0.250
ELEVATOR CONSTRUCTOR		BLD		37.115	41.750	2.0	2.0	2.0	8.275	4.460	2.227	0.000
FLOOR LAYER		BLD		26.930	27.680	1.5	1.5	2.0	5.000	3.750	0.000	0.350
GLAZIER		BLD		29.480	0.000	2.0	2.0	2.0	8.550	6.920	2.360	0.160
HT/FROST INSULATOR		BLD		30.440	31.440	1.5	1.5	2.0	4.850	8.360	0.000	0.450
IRON WORKER		ALL		26.350	27.850	1.5	1.5	2.0	6.360	8.250	0.000	0.420
LABORER		ALL		22.100	22.600	1.5	1.5	2.0	5.250	8.200	0.000	0.600
MACHINIST		BLD		36.890	38.890	2.0	2.0	2.0	4.380	5.650	2.550	0.000
MARBLE FINISHERS		BLD		24.990	0.000	1.5	1.5	2.0	6.000	5.400	0.000	0.425
MARBLE MASON		BLD		25.470	26.970	1.5	1.5	2.0	6.000	5.400	0.000	0.425
MILLWRIGHT		ALL		30.480	31.980	1.5	1.5	2.0	5.050	3.750	0.000	0.350
OPERATING ENGINEER		ALL	1	25.900	27.030	1.5	1.5	2.0	6.200	11.45	0.000	1.000
OPERATING ENGINEER		ALL	2	24.770	27.030	1.5	1.5	2.0	6.200	11.45	0.000	1.000
OPERATING ENGINEER		ALL	3	20.290	27.030	1.5	1.5	2.0	6.200	11.45	0.000	1.000
OPERATING ENGINEER		ALL	4	20.350	27.030	1.5	1.5	2.0	6.200	11.45	0.000	1.000
OPERATING ENGINEER		ALL	5	20.020	27.030	1.5	1.5	2.0	6.200	11.45	0.000	1.000
OPERATING ENGINEER		ALL	6	26.450	27.030	1.5	1.5	2.0	6.200	11.45	0.000	1.000
OPERATING ENGINEER		ALL	7	26.750	27.030	1.5	1.5	2.0	6.200	11.45	0.000	1.000
OPERATING ENGINEER		ALL	8	27.030	27.030	1.5	1.5	2.0	6.200	11.45	0.000	1.000
PAINTER		BLD		22.790	23.790	1.5	1.5	2.0	5.430	4.500	0.000	0.250
PAINTER		HWY		27.090	28.090	1.5	1.5	2.0	5.430	4.500	0.000	0.250
PAINTER OVER 30FT		BLD		23.790	24.790	1.5	1.5	2.0	5.430	4.500	0.000	0.250
PAINTER PWR EQMT		BLD		23.790	24.790	1.5	1.5	2.0	5.430	4.500	0.000	0.250
PAINTER PWR EQMT		HWY		28.090	29.090	1.5	1.5	2.0	5.430	4.500	0.000	0.250
PILEDRIVER		ALL		30.480	31.980	1.5	1.5	2.0	5.050	3.750	0.000	0.350
PIPEFITTER	N	BLD		31.000	33.500	1.5	1.5	2.0	5.800	3.950	0.000	0.475
PIPEFITTER	SE	BLD		31.300	34.430	1.5	2.0	2.0	6.450	5.030	0.000	0.620
PIPEFITTER	W	BLD		30.000	32.000	1.5	1.5	2.0	5.940	7.000	0.000	0.350
PLASTERER		BLD		23.500	24.500	1.5	1.5	2.0	5.200	3.550	0.000	0.100
PLUMBER	N	BLD		31.000	33.500	1.5	1.5	2.0	5.800	3.950	0.000	0.475
PLUMBER	SE	BLD		31.300	34.430	1.5	2.0	2.0	6.450	5.030	0.000	0.620
PLUMBER	W	BLD		30.450	32.950	1.5	1.5	2.0	4.950	5.450	0.000	0.300
ROOFER		BLD		26.250	28.250	1.5	1.5	2.0	6.100	5.950	0.000	0.200
SHEETMETAL WORKER		ALL		27.210	28.460	1.5	1.5	2.0	6.000	4.770	1.630	0.120
SPRINKLER FITTER		BLD		34.230	36.480	2.0	2.0	2.0	6.650	7.850	0.000	0.650
STONE MASON		BLD		25.470	26.970	1.5	1.5	2.0	6.000	5.400	0.000	0.425
TERRAZZO FINISHER		BLD		24.990	0.000	1.5	1.5	2.0	6.000	5.400	0.000	0.425
TERRAZZO MASON		BLD		28.500	28.800	1.5	1.5	2.0	0.000	2.950	0.000	0.000
TRUCK DRIVER		ALL	1	25.930	0.000	1.5	1.5	2.0	7.250	3.425	0.000	0.000
TRUCK DRIVER		ALL	2	26.330	0.000	1.5	1.5	2.0	7.250	3.425	0.000	0.000
TRUCK DRIVER		ALL	3	26.530	0.000	1.5	1.5	2.0	7.250	3.425	0.000	0.000
TRUCK DRIVER		ALL	4	26.780	0.000	1.5	1.5	2.0	7.250	3.425	0.000	0.000
TRUCK DRIVER		ALL	5	27.530	0.000	1.5	1.5	2.0	7.250	3.425	0.000	0.000
TRUCK DRIVER		O&C	1	20.740	0.000	1.5	1.5	2.0	7.250	3.425	0.000	0.000



TRUCK DRIVER	O&C 2	21.060	0.000	1.5	1.5	2.0	7.250	3.425	0.000	0.000
TRUCK DRIVER	O&C 3	21.220	0.000	1.5	1.5	2.0	7.250	3.425	0.000	0.000
TRUCK DRIVER	O&C 4	21.420	0.000	1.5	1.5	2.0	7.250	3.425	0.000	0.000
TRUCK DRIVER	O&C 5	22.020	0.000	1.5	1.5	2.0	7.250	3.425	0.000	0.000
TUCKPOINTER	BLD	25.470	26.970	1.5	1.5	2.0	6.000	5.400	0.000	0.425

Legend:

M-F>8 (Overtime is required for any hour greater than 8 worked each day, Monday through Friday.)

OSA (Overtime is required for every hour worked on Saturday)

OSH (Overtime is required for every hour worked on Sunday and Holidays)

H/W (Health & Welfare Insurance)

Pensn (Pension)

Vac (Vacation)

Trng (Training)

## Explanations

### RANDOLPH COUNTY

ELECTRICIANS AND ELECTRONIC SYSTEMS TECHNICIAN (NORTHWEST) - Township of Red Bud.

PLUMBERS & PIPEFITTERS (NORTH) - Towns of Red Bud, Prairie, and Ruma.

PLUMBERS & PIPEFITTERS (SOUTHEAST) - That part of the county East of a line between Ste. Genevieve, Mo. and Rt. 155 then south of a diagonal line to the North-East corner of the county.

PLUMBERS & PIPEFITTERS (WEST) - Towns of Roots, Kellog, Modoc and Prairie DuRocher.

The following list is considered as those days for which holiday rates of wages for work performed apply: New Years Day, Memorial/Decoration Day, Fourth of July, Labor Day, Veterans Day, Thanksgiving Day, Christmas Day. Generally, any of these holidays which fall on a Sunday is celebrated on the following Monday. This then makes work performed on that Monday payable at the appropriate overtime rate for holiday pay. Common practice in a given local may alter certain days of celebration such as the day after Thanksgiving for Veterans Day. If in doubt, please check with IDOL.

Oil and chip resealing (O&C) means the application of road oils and liquid asphalt to coat an existing road surface, followed by application of aggregate chips or gravel to coated surface, and subsequent rolling of material to seal the surface.

### EXPLANATION OF CLASSES

ASBESTOS - GENERAL - removal of asbestos material/mold and hazardous materials from any place in a building, including mechanical systems where those mechanical systems are to be removed. This includes the removal of asbestos materials/mold and hazardous materials from

ductwork or pipes in a building when the building is to be demolished at the time or at some close future date.

ASBESTOS - MECHANICAL - removal of asbestos material from mechanical systems, such as pipes, ducts, and boilers, where the mechanical systems are to remain.

#### CERAMIC TILE FINISHER, MARBLE FINISHER, TERRAZZO FINISHER

Assisting, helping or supporting the tile, marble and terrazzo mechanic by performing their historic and traditional work assignments required to complete the proper installation of the work covered by said crafts. The term "Ceramic" is used for naming the classification only, and is in no a limitation of the product handled. Ceramic takes into consideration most hard tiles.

#### ELECTRONIC SYSTEMS TECHNICIAN

Installation, service and maintenance of low-voltage systems which utilizes the transmission and/or transference of voice, sound, vision, or digital for commercial, education, security and entertainment purposes for the following: TV monitoring and surveillance, background/foreground music, intercom and telephone interconnect, field programming, inventory control systems, microwave transmission, multi-media, multiplex, radio page, school, intercom and sound burglar alarms and low voltage master clock systems.

Excluded from this classification are energy management systems, life safety systems, supervisory controls and data acquisition systems not intrinsic with the above listed systems, fire alarm systems, nurse call systems and raceways exceeding fifteen feet in length.

#### TRUCK DRIVER - BUILDING, HEAVY AND HIGHWAY CONSTRUCTION

Class 1. Drivers on 2 axle trucks hauling less than 9 ton. Air compressor and welding machines and brooms, including those pulled by separate units, truck driver helpers, warehouse employees, mechanic helpers, greasers and tiremen, pickup trucks when hauling materials, tools, or workers to and from and on-the-job site, and fork lifts up to 6,000 lb. capacity.

Class 2. Two or three axle trucks hauling more than 9 ton but hauling less than 16 ton. A-frame winch trucks, hydrolift trucks, vector trucks or similar equipment when used for transportation purposes. Fork lifts over 6,000 lb. capacity, winch trucks, four axle combination units, and ticket writers.

Class 3. Two, three or four axle trucks hauling 16 ton or more. Drivers on water pulls, articulated dump trucks, mechanics and working forepersons, and dispatchers. Five axle or more combination units.

Class 4. Low Boy and Oil Distributors.

Class 5. Drivers who require special protective clothing while employed on hazardous waste work.

#### TRUCK DRIVER - OIL AND CHIP RESEALING ONLY.

This shall encompass laborers, workers and mechanics who drive contractor or subcontractor owned, leased, or hired pickup, dump, service, or oil distributor trucks. The work includes transporting materials and equipment (including but not limited to, oils, aggregate supplies, parts, machinery and tools) to or from the job site; distributing oil or liquid asphalt and aggregate; stock piling material when in connection with the actual oil and chip contract.

The Truck Driver (Oil & Chip Resealing) wage classification does not include supplier delivered materials.

#### OPERATING ENGINEERS

GROUP I. Cranes, Dragline, Shovels, Skimmer Scoops, Clamshells or Derrick Boats, Pile Drivers, Crane-Type Backhoes, Asphalt Plant Operators, Concrete Plant Operators, Dredges, Asphalt Spreading Machines, All Locomotives, Cable Ways, or Tower Machines, Hoists, Hydraulic Backhoes, Ditching Machines or Backfiller, Cherrypickers, Overhead Cranes, Roller, Steam or Gas, Concrete Pavers, Excavators, Concrete Breakers, Concrete Pumps, Bulk Cement Plants, Cement Pumps, Derrick-Type Drills, Boat Operators, Motor Graders or Pushcats, Scoops or Tournapulls, Bulldozers, Endloaders or Fork Lifts, Power Blade or Elevating Graders, Winch Cats, Boom or Winch Trucks or Boom Tractors, Pipe Wrapping or Painting Machines, Asphalt Plant Engineer, Journeyman Lubricating Engineer, Drills (other than Derrick Type), Mud Jacks, or Well Drilling Machines, Boring Machines or Track Jacks, Mixers, Conveyors (Two), Air Compressors (Two), Water Pumps regardless of size (Two), Welding Machines (Two), Siphons or Jets (Two), Winch Heads or Apparatuses (Two), Light Plants (Two), Waterblasters (two), All Tractors regardless of size (straight tractor only), Fireman on Stationary Boilers, Automatic Elevators, Form Grading Machines, Finishing Machines, Power Sub-Grader or Ribbon Machines, Longitudinal Floats, Distributor Operators on Trucks, Winch Heads or Apparatuses (One), Mobil Track air and heaters (two to five), Heavy Equipment Greaser, Relief Operator, Assistant Master Mechanic and Heavy Duty Mechanic, all Operators (except those listed below).

GROUP II. Assistant Operators.

GROUP III. Air Compressors (One), Water Pumps, regardless of Size (One), Waterblasters (one), Welding Machine (One), Mixers (One Bag), Conveyor (One), Siphon or Jet (One), Light Plant (One), Heater (One), Immobile Track Air (One), and Self Propelled Walk-Behind Rollers.

GROUP IV. Asphalt Spreader Oilers, Fireman on Whirlies and Heavy Equipment Oilers, Truck Cranes, Dredges, Monigans, Large Cranes - (Over 65-ton rated capacity) Concrete Plant Oiler, Blacktop Plant Oiler, and Creter Crane Oiler (when required).

GROUP V. Oiler.

GROUP VI. Master Mechanics, Operators on equipment with Booms, including jibs, 100 feet and over, and less than 150 feet long.

GROUP VII. Operators on equipment with Booms, including jibs, 150 feet and over, and less than 200 feet long.

GROUP VIII. Operators on Equipment with Booms, including jibs, 200 feet and over; Tower Cranes; Whirlie Cranes; and Operator Foreman.

Other Classifications of Work:

For definitions of classifications not otherwise set out, the Department generally has on file such definitions which are available. If a task to be performed is not subject to one of the classifications of pay set out, the Department will upon being contacted state which neighboring county has such a classification and provide such rate, such rate being deemed to exist by reference in this document. If no neighboring county rate applies to the task, the Department shall undertake a special determination, such special determination being then deemed to have existed under this

determination. If a project requires these, or any classification not listed, please contact IDOL at 618/993-7271 for wage rates or clarifications.

#### LANDSCAPING

Landscaping work falls under the existing classifications for laborer, operating engineer and truck driver. The work performed by landscape plantsman and landscape laborer is covered by the existing classification of laborer. The work performed by landscape operators (regardless of equipment used or its size) is covered by the classifications of operating engineer. The work performed by landscape truck drivers (regardless of size of truck driven) is covered by the classifications of truck driver.

# Richland County Prevailing Wage for April 2007

Trade Name	RG	TYP	C	Base	FRMAN	*M-F>8	OSA	OSH	H/W	Pensn	Vac	Trng
ASBESTOS ABT-GEN		ALL		20.750	21.200	1.5	1.5	2.0	5.250	5.600	0.000	0.700
ASBESTOS ABT-MEC		BLD		20.800	0.000	2.0	2.0	2.0	5.000	3.400	0.000	0.000
BOILERMAKER		BLD		28.500	31.000	1.5	1.5	2.0	6.820	11.03	0.000	0.300
BRICK MASON		BLD		25.470	26.970	1.5	1.5	2.0	6.000	5.400	0.000	0.425
CARPENTER		BLD		27.780	29.280	1.5	1.5	2.0	5.050	3.750	0.000	0.350
CARPENTER		HWY		27.730	29.480	1.5	1.5	2.0	5.050	3.750	0.000	0.350
CEMENT MASON		BLD		23.500	24.500	1.5	1.5	2.0	5.200	3.550	0.000	0.100
CEMENT MASON		HWY		23.500	25.000	1.5	1.5	2.0	5.200	2.750	0.000	0.200
CERAMIC TILE FNSHER		BLD		24.990	0.000	1.5	1.5	2.0	6.000	5.400	0.000	0.425
COMM SYSTEMS TECH		BLD		23.350	25.700	1.5	1.5	2.0	5.150	4.310	0.000	0.000
ELECTRICIAN		BLD		29.090	31.130	1.5	1.5	2.0	5.150	5.530	0.000	0.290
FLOOR LAYER		BLD		26.930	27.680	1.5	1.5	2.0	5.000	3.750	0.000	0.350
GLAZIER		BLD		22.930	0.000	1.5	1.5	2.0	4.320	3.800	0.000	0.300
HT/FROST INSULATOR		BLD		26.110	27.110	1.5	1.5	2.0	4.800	6.860	0.000	0.190
IRON WORKER		ALL		24.000	25.250	1.5	1.5	2.0	5.780	6.850	0.000	0.345
LABORER		BLD		20.750	21.200	1.5	1.5	2.0	5.250	5.600	0.000	0.600
LABORER		HWY		21.000	21.450	1.5	1.5	2.0	5.350	6.150	0.000	0.600
MACHINIST		BLD		36.890	38.890	2.0	2.0	2.0	4.380	5.650	2.550	0.000
MARBLE FINISHERS		BLD		24.990	0.000	1.5	1.5	2.0	6.000	5.400	0.000	0.425
MARBLE MASON		BLD		25.470	26.970	1.5	1.5	2.0	6.000	5.400	0.000	0.425
MILLWRIGHT		BLD		27.780	29.280	1.5	1.5	2.0	5.050	3.750	0.000	0.350
MILLWRIGHT		HWY		28.230	29.980	1.5	1.5	2.0	5.050	3.750	0.000	0.350
OPERATING ENGINEER		ALL	1	28.650	0.000	1.5	1.5	2.0	5.200	6.750	0.000	0.650
OPERATING ENGINEER		ALL	2	18.600	0.000	1.5	1.5	2.0	5.200	6.750	0.000	0.650
PAINTER		ALL		23.000	24.000	1.5	1.5	2.0	5.500	6.200	0.000	0.180
PILEDRIVER		BLD		27.780	29.280	1.5	1.5	2.0	5.050	3.750	0.000	0.350
PILEDRIVER		HWY		28.230	29.980	1.5	1.5	2.0	5.050	3.750	0.000	0.350
PIPEFITTER		ALL		28.850	31.010	1.5	1.5	2.0	5.450	4.750	0.000	0.510
PLASTERER		BLD		23.500	24.500	1.5	1.5	2.0	5.200	3.550	0.000	0.100
PLUMBER		ALL		28.850	31.010	1.5	1.5	2.0	5.450	4.750	0.000	0.510
ROOFER		BLD		22.350	24.850	1.5	1.5	2.0	6.000	5.550	0.000	0.550
SHEETMETAL WORKER		ALL		27.210	28.460	1.5	1.5	2.0	6.000	4.770	1.630	0.120
SPRINKLER FITTER		BLD		31.240	33.240	1.5	1.5	2.0	6.500	5.350	0.000	0.250
STONE MASON		BLD		25.470	26.970	1.5	1.5	2.0	6.000	5.400	0.000	0.425
TERRAZZO FINISHER		BLD		24.990	0.000	1.5	1.5	2.0	6.000	5.400	0.000	0.425
TILE MASON		BLD		25.470	26.970	1.5	1.5	2.0	6.000	5.400	0.000	0.425
TRUCK DRIVER		ALL	1	25.010	0.000	1.5	1.5	2.0	6.500	2.225	0.000	0.000
TRUCK DRIVER		ALL	2	25.410	0.000	1.5	1.5	2.0	6.500	2.225	0.000	0.000
TRUCK DRIVER		ALL	3	25.610	0.000	1.5	1.5	2.0	6.500	2.225	0.000	0.000
TRUCK DRIVER		ALL	4	25.860	0.000	1.5	1.5	2.0	6.500	2.225	0.000	0.000
TRUCK DRIVER		ALL	5	26.610	0.000	1.5	1.5	2.0	6.500	2.225	0.000	0.000
TUCKPOINTER		BLD		25.470	26.970	1.5	1.5	2.0	6.000	5.400	0.000	0.425

Legend :

M-F>8 (Overtime is required for any hour greater than 8 worked each day, Monday through Friday.)

OSA (Overtime is required for every hour worked on Saturday)

OSH (Overtime is required for every hour worked on Sunday and Holidays)

H/W (Health & Welfare Insurance)

Pensn (Pension)

Vac (Vacation)

Trng (Training)

## Explanations

### RICHLAND COUNTY

The following list is considered as those days for which holiday rates of wages for work performed apply: New Years Day, Memorial/Decoration Day, Fourth of July, Labor Day, Veterans Day, Thanksgiving Day, Christmas Day. Generally, any of these holidays which fall on a Sunday is celebrated on the following Monday. This then makes work performed on that Monday payable at the appropriate overtime rate for holiday pay. Common practice in a given local may alter certain days of celebration such as the day after Thanksgiving for Veterans Day. If in doubt, please check with IDOL.

### EXPLANATION OF CLASSES

ASBESTOS - GENERAL - removal of asbestos material/mold and hazardous materials from any place in a building, including mechanical systems where those mechanical systems are to be removed. This includes the removal of asbestos materials/mold and hazardous materials from ductwork or pipes in a building when the building is to be demolished at the time or at some close future date.

ASBESTOS - MECHANICAL - removal of asbestos material from mechanical systems, such as pipes, ducts, and boilers, where the mechanical systems are to remain.

### CERAMIC TILE FINISHER, MARBLE FINISHER, TERRAZZO FINISHER

Assisting, helping or supporting the tile, marble and terrazzo mechanic by performing their historic and traditional work assignments required to complete the proper installation of the work covered by said crafts. The term "Ceramic" is used for naming the classification only, and is in no a limitation of the product handled. Ceramic takes into consideration most hard tiles.

### COMMUNICATION SYSTEMS TECHNICIAN

Installation, operation, inspection, maintenance, repair, and service of radio, television, recording, voice sound and vision production and reproduction apparatus, equipment and appliances used for domestic, commercial, education, entertainment and private telephone systems.

### TRUCK DRIVER - BUILDING, HEAVY AND HIGHWAY CONSTRUCTION

Class 1. Drivers on 2 axle trucks hauling less than 9 ton. Air compressor and welding machines and brooms, including those pulled by separate units, truck driver helpers, warehouse employees, mechanic helpers, greasers and tiremen, pickup trucks when hauling materials, tools, or workers to and from and on-the-job site, and fork lifts up to 6,000 lb. capacity.

Class 2. Two or three axle trucks hauling more than 9 ton but hauling less than 16 ton. A-frame winch trucks, hydrolift trucks, vactor trucks or similar equipment when used for transportation purposes. Fork lifts over 6,000 lb. capacity, winch trucks, four axle combination units, and ticket writers.

Class 3. Two, three or four axle trucks hauling 16 ton or more. Drivers on water pulls, articulated dump trucks, mechanics and working forepersons, and dispatchers. Five axle or more combination units.

Class 4. Low Boy and Oil Distributors.

Class 5. Drivers who require special protective clothing while employed on hazardous waste work.

#### OPERATING ENGINEERS - BUILDING, HEAVY AND HIGHWAY CONSTRUCTION

Class 1. Power Cranes, Draglines, Derricks, Shovels, Gradalls, Mechanics, Tractor Highlift, Tournadozer, Concrete Mixers with Skip, Tournamixer, Two Drum Machine, One Drum Hoist with Tower or Boom, Cableways, Tower Machines, Motor Patrol, Boom Tractor, Boom or Winch Truck, Winch or Hydraulic Boom Truck, Truck Crane, Tournapull, Tractor Operating Scoops, Bulldozer, Push Tractor, Asphalt Planer, Finishing Machine on Asphalt, Large Rollers on Earth, Rollers on Asphalt Mix, Ross Carrier or similar Machine, Gravel Processing Machine, Asphalt Plant Engineer, Paver Operator, Dredging Equipment, or Dredge Engineer, or Dredge Operator, Central Mix Plant Engineer, CMI or similar type machine, Concrete Pump, Truck or Skid Mounted, Tower Crane, Engineer or Rock Crusher Plant, Concrete Plant Engineer, Ditching Machine with dual attachment, Tractor Mounted Loaders, Cherry Picker, Hydro Crane, Standard or Dinkey Locomotives, Scoopmobiles, Euclid Loader, Soil Cement Machine, Back Filler, Elevating Machine, Power Blade, Drilling Machine, including Well Testing, Caissons, Shaft or any similar type drilling machines, Motor Driven Paint Machine, Pipe Cleaning Machine, Pipe Wrapping Machine, Pipe Bending Machine, Apsco Paver, Boring Machine, (Head Equipment Greaser), Barber-Greene Loaders, Formless Paver, (Well Point System), Concrete Spreader, Hydra Ax, Span Saw, Marine Scoops, Brush Mulcher, Brush Burner, Mesh Placer, Tree Mover, Helicopter Crew (3), Piledriver-Skid or Crawler, Stump Remover, Root Rake, Tug Boat Operator, Refrigerating Machine, Freezing Operator, Chair Cart-Self-Propelled, Hydra Seeder, Straw Blower, Power Sub Grader, Bull Float, Finishing Machine, Self-Propelled Pavement Breaker, Lull (or similar type Machine), Two Air Compressors, Compressors hooked in Manifold, Overhead Crane, Chip Spreader, Mud Cat, Sull-Air, Fork Lifts (except when used for landscaping work), Soil Stabilizer (Seaman Tiller, Bo Mag, Rago Gator, and similar types of equipment), Tube Float, Spray Machine, Curing Machine, Concrete or Asphalt Milling Machine, Snooper Truck-Operator, Backhoe, Farm Tractors (with attachments), 4 Point Lift System (Power Lift or similar type), Skid-Steer (Bob Cat or similar type), Wrecking Shears, Water Blaster.

Class 2. Concrete Mixers without Skips, Rock Crusher, Ditching Machine under 6', Curbing Machine, One Drum Machines without Tower or Boom, Air Tugger, Self-Propelled Concrete Saw, Machine Mounted Post Hole Digger, two to four Generators, Water Pumps or Welding Machines, within 400 feet, Air Compressor 600 cu. ft. and under, Rollers on Aggregate and Seal Coat Surfaces, Fork Lift (when used for landscaping work), Concrete and Blacktop Curb Machine, One Water Pump, Oilers, Air Valves or Steam Valves, One Welding Machine, Truck Jack, Mud Jack, Gunnite Machine, House Elevators when used for hoisting material, Engine Tenders, Fireman, Wagon Drill, Flex Plane, Conveyor, Siphons and Pulsometer, Switchman, Fireman on Paint Pots, Fireman on Asphalt Plants, Distributor Operator on Trucks, Tampers, Self-Propelled Power Broom, Striping Machine (motor driven), Form Tamper, Bulk Cement Plant, Equipment Greaser, Deck Hands, Truck Crane Oiler-Driver, Cement Blimps, Form Grader, Temporary Heat, Throttle Valve, Super Sucker (and similar type of equipment).

Other Classifications of Work:

For definitions of classifications not otherwise set out, the Department generally has on file such definitions which are available. If a task to be performed is not subject to one of the classifications of pay set out, the Department will upon being contacted state which neighboring county has such a classification and provide such rate, such rate being deemed to exist by reference in this document. If no neighboring county rate applies to the task, the Department shall undertake a special determination, such special determination being then deemed to have existed under this determination. If a project requires these, or any classification not listed, please contact IDOL at 618/993-7271 for wage rates or clarifications.

LANDSCAPING

Landscaping work falls under the existing classifications for laborer, operating engineer and truck driver. The work performed by landscape plantsman and landscape laborer is covered by the existing classification of laborer. The work performed by landscape operators (regardless of equipment used or its size) is covered by the classifications of operating engineer. The work performed by landscape truck drivers (regardless of size of truck driven) is covered by the classifications of truck driver.



# Rock Island County Prevailing Wage for April 2007

Trade Name	RG	TYP	C	Base	FRMAN	*M-F>8	OSA	OSH	H/W	Pensn	Vac	Trng
=====	==	==	=	=====	=====	=====	==	==	=====	=====	=====	=====
ASBESTOS ABT-GEN		BLD		21.910	22.410	1.5	1.5	2.0	5.450	4.000	0.000	0.600
ASBESTOS ABT-GEN		HWY		23.160	24.160	1.5	1.5	2.0	5.600	4.400	0.000	0.600
ASBESTOS ABT-MEC		BLD		18.750	19.750	1.5	1.5	2.0	4.750	2.000	0.000	0.000
BOILERMAKER		BLD		30.970	33.970	2.0	2.0	2.0	8.270	7.740	0.000	0.300
BRICK MASON		BLD		24.300	25.550	1.5	1.5	2.0	6.250	4.750	0.000	0.360
CARPENTER		BLD		24.750	25.990	1.5	1.5	2.0	5.700	5.160	0.000	0.400
CARPENTER		HWY		25.540	27.290	1.5	1.5	2.0	5.860	6.260	0.000	0.400
CEMENT MASON		BLD		22.840	23.840	1.5	1.5	2.0	5.200	5.300	0.000	0.250
CEMENT MASON		HWY		23.060	24.060	1.5	1.5	2.0	5.300	5.800	0.000	0.500
CERAMIC TILE FNSHER		BLD		17.190	0.000	1.5	1.5	2.0	6.250	4.000	0.000	0.210
ELECTRIC PWR EQMT OP		ALL		23.520	0.000	1.5	1.5	2.0	4.750	6.350	0.000	0.120
ELECTRIC PWR GRNDMAN		ALL		19.660	0.000	1.5	1.5	2.0	4.750	5.310	0.000	0.100
ELECTRIC PWR LINEMAN		ALL		29.650	31.430	1.5	1.5	2.0	4.750	8.010	0.000	0.150
ELECTRICIAN		BLD		27.770	29.770	1.5	1.5	2.0	5.500	7.660	0.000	0.310
ELECTRONIC SYS TECH		BLD		19.800	21.400	1.5	1.5	2.0	5.880	4.040	0.000	0.310
ELEVATOR CONSTRUCTOR		BLD		33.140	37.280	2.0	2.0	2.0	8.275	6.060	1.990	0.000
GLAZIER		BLD		23.220	24.610	1.5	1.5	2.0	4.750	3.900	0.000	0.200
HT/FROST INSULATOR		BLD		25.860	27.060	1.5	1.5	2.0	4.800	7.500	0.000	0.000
IRON WORKER		ALL		23.100	24.950	1.5	1.5	2.0	8.040	7.990	0.000	0.420
LABORER		BLD 1		20.410	20.910	1.5	1.5	2.0	5.450	4.000	0.000	0.600
LABORER		BLD 2		21.910	22.410	1.5	1.5	2.0	5.450	4.000	0.000	0.600
LABORER		BLD 3		22.560	23.060	1.5	1.5	2.0	5.450	4.000	0.000	0.600
LABORER		HWY 1		22.660	23.660	1.5	1.5	2.0	5.600	4.400	0.000	0.600
LABORER		HWY 2		23.160	24.160	1.5	1.5	2.0	5.600	4.400	0.000	0.600
LABORER		HWY 3		23.790	24.790	1.5	1.5	2.0	5.600	4.400	0.000	0.600
LATHER		BLD		24.750	25.990	1.5	1.5	2.0	5.700	5.160	0.000	0.400
MACHINIST		BLD		36.890	38.890	2.0	2.0	2.0	4.380	5.650	2.550	0.000
MARBLE FINISHERS		BLD		17.190	0.000	1.5	1.5	2.0	6.250	4.000	0.000	0.210
MARBLE MASON		BLD		21.530	22.030	1.5	1.5	2.0	6.250	4.000	0.000	0.210
MILLWRIGHT	N	BLD		32.000	35.200	1.5	1.5	2.0	6.100	9.250	0.000	0.560
MILLWRIGHT	S	BLD		25.000	26.700	1.5	1.5	2.0	5.550	7.730	0.000	0.560
OPERATING ENGINEER		BLD 1		26.150	0.000	1.5	1.5	2.0	6.850	5.800	1.500	0.550
OPERATING ENGINEER		BLD 2		23.500	0.000	1.5	1.5	2.0	6.850	5.800	1.500	0.550
OPERATING ENGINEER		BLD 3		22.450	0.000	1.5	1.5	2.0	6.850	5.800	1.500	0.550
OPERATING ENGINEER		HWY 1		26.150	27.150	1.5	1.5	2.0	6.850	5.800	1.500	0.550
OPERATING ENGINEER		HWY 2		24.550	27.150	1.5	1.5	2.0	6.850	5.800	1.500	0.550
OPERATING ENGINEER		HWY 3		23.400	27.150	1.5	1.5	2.0	6.850	5.800	1.500	0.550
PAINTER		ALL		23.470	24.470	1.5	1.5	1.5	4.650	4.850	0.000	0.600
PAINTER OVER 30FT		ALL		24.720	25.720	1.5	1.5	1.5	4.650	4.850	0.000	0.600
PAINTER PWR EQMT		ALL		23.970	24.970	1.5	1.5	1.5	4.650	4.850	0.000	0.600
PILEDRIVER		BLD		24.750	25.990	1.5	1.5	2.0	5.700	5.160	0.000	0.400
PILEDRIVER		HWY		25.540	27.290	1.5	1.5	2.0	5.860	6.260	0.000	0.400
PIPEFITTER		ALL		30.520	33.570	1.5	1.5	2.0	4.800	7.960	0.000	0.530
PLASTERER		BLD		25.900	27.450	1.5	1.5	2.0	4.000	4.400	0.000	0.100
PLUMBER		ALL		30.520	33.570	1.5	1.5	2.0	4.800	7.960	0.000	0.530
ROOFER		BLD		22.850	24.100	1.5	1.5	2.0	5.840	4.870	0.000	0.190
SHEETMETAL WORKER		BLD		27.300	29.000	1.5	1.5	2.0	6.040	7.300	0.000	0.380
SPRINKLER FITTER		BLD		31.240	33.240	1.5	1.5	2.0	6.500	5.350	0.000	0.250
STONE MASON		BLD		24.300	25.550	1.5	1.5	2.0	6.250	4.750	0.000	0.360
TERRAZZO FINISHER		BLD		17.190	0.000	1.5	1.5	2.0	6.250	4.000	0.000	0.210
TERRAZZO MASON		BLD		21.530	22.030	1.5	1.5	2.0	6.250	4.000	0.000	0.210
TILE LAYER		BLD		24.750	25.990	1.5	1.5	2.0	5.700	5.160	0.000	0.400
TILE MASON		BLD		21.530	22.030	1.5	1.5	2.0	6.250	4.000	0.000	0.210
TRUCK DRIVER		ALL 1		25.930	0.000	1.5	1.5	2.0	7.250	3.425	0.000	0.000
TRUCK DRIVER		ALL 2		26.333	0.000	1.5	1.5	2.0	7.250	3.425	0.000	0.000
TRUCK DRIVER		ALL 3		26.530	0.000	1.5	1.5	2.0	7.250	3.425	0.000	0.000
TRUCK DRIVER		ALL 4		26.780	0.000	1.5	1.5	2.0	7.250	3.425	0.000	0.000
TRUCK DRIVER		ALL 5		27.530	0.000	1.5	1.5	2.0	7.250	3.425	0.000	0.000

TRUCK DRIVER	O&C 1	20.740	0.000	1.5	1.5	2.0	7.250	3.425	0.000	0.000
TRUCK DRIVER	O&C 2	21.060	0.000	1.5	1.5	2.0	7.250	3.425	0.000	0.000
TRUCK DRIVER	O&C 3	21.220	0.000	1.5	1.5	2.0	7.250	3.425	0.000	0.000
TRUCK DRIVER	O&C 4	21.420	0.000	1.5	1.5	2.0	7.250	3.425	0.000	0.000
TRUCK DRIVER	O&C 5	22.020	0.000	1.5	1.5	2.0	7.250	3.425	0.000	0.000
TUCKPOINTER	BLD	24.300	25.550	1.5	1.5	2.0	6.250	4.750	0.000	0.360

Legend:

M-F>8 (Overtime is required for any hour greater than 8 worked each day, Monday through Friday.)

OSA (Overtime is required for every hour worked on Saturday)

OSH (Overtime is required for every hour worked on Sunday and Holidays)

H/W (Health & Welfare Insurance)

Pensn (Pension)

Vac (Vacation)

Trng (Training)

## Explanations

ROCK ISLAND COUNTY

MILLWRIGHT (SOUTH) - South of Interstate 80.

The following list is considered as those days for which holiday rates of wages for work performed apply: New Years Day, Memorial/Decoration Day, Fourth of July, Labor Day, Veterans Day, Thanksgiving Day, Christmas Day. Generally, any of these holidays which fall on a Sunday is celebrated on the following Monday. This then makes work performed on that Monday payable at the appropriate overtime rate for holiday pay. Common practice in a given local may alter certain days of celebration such as the day after Thanksgiving for Veterans Day. If in doubt, please check with IDOL.

Oil and chip resealing (O&C) means the application of road oils and liquid asphalt to coat an existing road surface, followed by application of aggregate chips or gravel to coated surface, and subsequent rolling of material to seal the surface.

### EXPLANATION OF CLASSES

ASBESTOS - GENERAL - removal of asbestos material/mold and hazardous materials from any place in a building, including mechanical systems where those mechanical systems are to be removed. This includes the removal of asbestos materials/mold and hazardous materials from ductwork or pipes in a building when the building is to be demolished at the time or at some close future date.

ASBESTOS - MECHANICAL - removal of asbestos material from mechanical systems, such as pipes, ducts, and boilers, where the mechanical systems are to remain.

CERAMIC TILE FINISHER, MARBLE FINISHER, TERRAZZO FINISHER

Assisting, helping or supporting the tile, marble and terrazzo mechanic by performing their historic and traditional work assignments required to complete the proper installation of the work covered by said crafts. The term "Ceramic" is used for naming the classification only and is in no way a limitation of the product handled. Ceramic takes into consideration most hard tiles.

#### ELECTRONIC SYSTEMS TECHNICIAN

Installing, assembling and maintaining sound and intercom, protection alarm (security), master antenna television, closed circuit television, computer hardware and software programming and installation to the network's outlet and input (EXCLUDING all cabling, power and cable termination work historically performed by wiremen), door monitoring and control, nurse and emergency call programming and installation to the system's outlet and input (EXCLUDING all cabling, power and cable termination work historically performed by wiremen), clock and timing; and the installation and maintenance of transmit and receive antennas, transmitters, receivers, and associated apparatus which operates in conjunction with the above systems. All work associated with these system installations will be included EXCEPT (1) installation of protective metallic conduit, excluding less than ten-foot runs strictly for protection of cable, and (2) 120 volt AC (or higher) power wiring and associated hardware.

#### TRUCK DRIVER - BUILDING, HEAVY AND HIGHWAY CONSTRUCTION

Class 1. Drivers on 2 axle trucks hauling less than 9 ton. Air compressor and welding machines and brooms, including those pulled by separate units, truck driver helpers, warehouse employees, mechanic helpers, greasers and tiremen, pickup trucks when hauling materials, tools, or workers to and from and on-the-job site, and fork lifts up to 6,000 lb. capacity.

Class 2. Two or three axle trucks hauling more than 9 ton but hauling less than 16 ton. A-frame winch trucks, hydrolift trucks, vector trucks or similar equipment when used for transportation purposes. Fork lifts over 6,000 lb. capacity, winch trucks, four axle combination units, and ticket writers.

Class 3. Two, three or four axle trucks hauling 16 ton or more. Drivers on water pulls, articulated dump trucks, mechanics and working forepersons, and dispatchers. Five axle or more combination units.

Class 4. Low Boy and Oil Distributors.

Class 5. Drivers who require special protective clothing while employed on hazardous waste work.

#### TRUCK DRIVER - OIL AND CHIP RESEALING ONLY.

This shall encompass laborers, workers and mechanics who drive contractor or subcontractor owned, leased, or hired pickup, dump, service, or oil distributor trucks. The work includes transporting materials and equipment (including but not limited to, oils, aggregate supplies, parts, machinery and tools) to or from the job site; distributing oil or liquid asphalt and aggregate; stock piling material when in connection with the actual oil and chip contract. The Truck Driver (Oil & Chip Resealing) wage classification does not include supplier delivered materials.

#### OPERATING ENGINEERS - BUILDING, HEAVY AND HIGHWAY CONSTRUCTION

Class 1. An engineer on Crane, Shovel, Clamshell, Dragline, Backhoe,

Derrick, Tower Crane, Cable Way, Concrete Spreader (servicing two pavers), Asphalt Spreader, Asphalt Mixer, Plant Engineer, Dipper Dredge Operator, Dipper Dredge Craneman, Dual Purpose Truck (boom or winch), Leverman or Engineman (hydraulic dredge), Mechanic, Paving Mixer with tower attached, Pile Driver, Boom Tractor, Stationary, Portable or Floating Mixing Plant, Trenching Machine (over 40 H.P.), Building Hoist (two drums), Hot Paint Wrapping Machine, Cleaning and Priming Machine, Backfiller (throw bucket), Locomotive Engineer, Qualified Welder, Tow or Push Boat, Concrete Paver, Seaman Trav-L-Plant or similar machines, CMI Autograder or similar machines, Slip Form Paver, Caisson Augering Machine, Mucking Machine, Asphalt Heater-Planer Unit, Hydraulic Cranes, Mine Hoists. An engineer on Athey, Barber-Green, Euclid or Haiss Loader, Asphalt Pug Mill, Fireman and Drier, Concrete Pump, Concrete Spreader (servicing one paver) Bulldozer, Endloader, Log Chippers or similar machines, Elevating Grader, Group Equipment Greaser, LeTourneaupul and similar machines, off-road haul units, DW-10 Hyster Winch and similar machines, Motor Patrol, Power Blade, Push Cat, Tractor Pulling elevating Grader or Power Blade, Tractor Operating Scoop or Scraper, Tractor with Power Attachment, Roller on Asphalt or Blacktop, Single Drum Hoist, Jaeger Mix and Place Machine, Pipe Bending Machine, Flexaplane or similar machines, Automatic Curbing Machines, Automatic Cement and Gravel Batch Plants (one stop set-up), Seaman Pulvi-Mixer or similar machines, Blastholer Self-propelled Rotary Drill or similar machines, Work Boat, Combination Concrete Finishing Machine and Float, Self-propelled Sheep Foot Roller or Compactor (used in conjunction with a Grading Spread), Asphalt Spreader Screed Operator, Apsco spreader or similar machine, Slusher, Forklift (over 6000 lb. cap. or working at heights above 28 ft.) Concrete Conveyors, Chip Spreader, Underground Boring Machine (BUILDING ONLY), Straddle Carrier, Hydro-Hammer (BUILDING ONLY), Hydraulic Pumps or Power Units Driven by any power source (except manually), used to hoist or lift machinery or material.

Class 2. An engineer on Asphalt Booster, Fireman and Pump Operator at Asphalt Plant, Mud Jack, Underground Boring Machine (HIGHWAY ONLY), Concrete Finishing Machine, Form Grader with Roller on Earth, Mixers (3 bag to 16E), Power Operated Bull Float, Tractor without Power attachment, Dope Pot (agitating motor), Dope Chop Machine, Distributor (back end), Straddle Carrier, Portable Machine Fireman, Hydro-Hammer (HIGHWAY ONLY), Power Winch on Paving Work, Self-propelled Roller or Compactor (other than provided for above), Pump Operator (more than one well-point pump), Portable Crusher Operator, Trench Machine (under 40 H.P.), Power Subgrader (on forms) or similar machines, Forklift (6000 or less cap.) Gypsum Pump, Conveyor over 20 H.P., Fuller Kenyon Cement Pump or similar machines. An engineer on Air Compressor (400 c.f.m. or over HIGHWAY ONLY), Light Plant, Mixers (1 or 2 bag), Power Batching Machine (Cement Auger or Conveyor), Boiler (Engineer or Fireman), Water Pumps (HIGHWAY ONLY), Mechanical Broom, Automatic Cement and Gravel Batch Plants (two or three stop set-up), Small Rubber-tired Tractors (not including backhoes or endloaders), Self-propelled Curing Machine, Brush Chipper, Driver on Truck Crane or similar machines.

Class 3. Oiler, Mechanic's Helper, Mechanical Heater (other than steam boiler), Belt Machine, Small Outboard Motor Boats (Safety Boat and Life Boat), Engine Driven Welding Machine, and Small Tractors (used to unroll or roll wire mesh), Water pumps (BUILDING ONLY), Air Compressors (BUILDING ONLY), Permanent Automatic Elevators.

#### LABORER - BUILDING

Class 1: General laborer, carpenter tender, tool cribman, salamander

tender, flagman, form handler, floor sweeper, material handler, fencing laborer, cleaning lumber, landscaper, unloading explosives, laying of sod, planting/removal of trees, wrecking laborer, unloading of Re-Bars, scaffold worker, signal man on crane.

Class 2: Handling of materials treated with creosote, kettle men, prime mover or motorized unit used for wet concrete or handling of building materials, vibrator operator, mortar mixer, power tools used under the jurisdiction of laborers, sand points, gunnite nozzle men, welders, cutters, burners and torchmen, chain saw operator, jackhammer and drill operators, paving breakers, air tamping hammerman, concrete saw operator, concrete burning machine operator, coring machine operator - hod carrier and plasterer tender.

Class 3: Caisson worker after 6 foot depth, dynamite man, asbestos abatement worker, tunnel miners - mixerman (plaster only), pump man.

#### LABORER - HEAVY & HIGHWAY

Class 1: Rod or chain man, flagman, dumpman, spotter, broom man, landscaper, planting and removal of trees, fencing laborers, dispatcher, ticket writer, scaleman, cleaning of forms or lumber (in bone yard), laying of sod, moving and/or maintenance of flares and barricades.

Class 2: Operation of all hand, electric, air, hydraulic or mechanically powered tools under the jurisdiction of Laborers' including jackhammers, tempers, air spades, augers, concrete saws, chain saws, utility saws, rock drills, vibrators, mortar mixer, power and hand saw (when clearing timber) general laborer (not elsewhere covered), craft-tender, material checker, material handler, form handler, concrete dumper, puddler, form setter helper, explosives handler, dynamite helper, center strip, reinforcing in concrete, wire mesh handler and installer, prime mover or any mechanical device taking the place of concrete buggy or wheelbarrow, sandpoint setter, asphalt kettleman. Sheeting hammer drivers, laying and jointing of telephone conduit, gas distribution men, pipe setter on laterals, drain tiles, culvert pipe, and storm sewer catch basin leads, catch basins, manholes, batch dumpers, tank cleaners, cofferdam workers, bankman on floating plant, jointman with pipelayers. Back-up man (corker, joint maker) with pipe setter on sewer and water mains, batterboard man or laser operator on sewer and water main, labor in ditch, or tunnel, on sewer or water mains and telephone conduit. Cutters, burners, torchman, gravel box man, asphalt plant laborers, concrete plant laborer, deck hand, unloading of steel and rebar, laser beam operator, wrecking laborers.

Class 3: Asphalt raker or luteman, head form setter, head dynamite man (powderman) head string or wireline man (on paving), pipe setter on sewer or water main, gunnite nozzle man, asphalt or concrete curb machine operator, head grade man, head tunnel miner, concrete burning machine operator, coring machine operator, welder.

#### Other Classifications of Work:

For definitions of classifications not otherwise set out, the Department generally has on file such definitions which are available. If a task to be performed is not subject to one of the classifications of pay set out, the Department will upon being contacted state which neighboring county has such a classification and provide such rate, such rate being deemed to exist by reference in this document. If no neighboring county rate applies to the task, the Department shall undertake a special determination, such special determination being then deemed to have existed under this

determination. If a project requires these, or any classification not listed, please contact IDOL at 618/993-7271 for wage rates or clarifications.

#### LANDSCAPING

Landscaping work falls under the existing classifications for laborer, operating engineer and truck driver. The work performed by landscape plantsman and landscape laborer is covered by the existing classification of laborer. The work performed by landscape operators (regardless of equipment used or its size) is covered by the classifications of operating engineer. The work performed by landscape truck drivers (regardless of size of truck driven) is covered by the classifications of truck driver.

# Saint Clair County Prevailing Wage for April 2007

Trade Name	RG	TYP	C	Base	FRMAN	*M-F>8	OSA	OSH	H/W	Pensn	Vac	Trng
=====	==	==	=	=====	=====	=====	==	==	=====	=====	=====	=====
ASBESTOS ABT-GEN		BLD		24.750	25.250	1.5	1.5	2.0	5.250	6.350	0.000	0.600
ASBESTOS ABT-MEC		BLD		25.290	26.290	1.5	1.5	2.0	4.450	2.500	0.000	0.250
BOILERMAKER		BLD		28.500	31.000	1.5	1.5	2.0	6.820	11.03	0.000	0.300
BRICK MASON		BLD		26.400	28.100	1.5	1.5	5.0	4.750	8.250	2.000	0.390
CARPENTER		ALL		30.480	31.980	1.5	1.5	2.0	5.050	3.750	0.000	0.350
CEMENT MASON		ALL		26.750	27.500	1.5	1.5	2.0	5.650	8.250	0.000	0.200
CERAMIC TILE FNSHER		BLD		22.610	0.000	1.5	1.5	2.0	5.000	4.300	0.000	0.400
ELECTRIC PWR EQMT OP		ALL		31.510	37.980	1.5	2.0	2.0	4.530	7.880	0.000	0.160
ELECTRIC PWR GRNDMAN		ALL		23.530	37.980	1.5	2.0	2.0	3.380	5.890	0.000	0.120
ELECTRIC PWR LINEMAN		ALL		36.220	37.980	1.5	2.0	2.0	5.210	9.060	0.000	0.180
ELECTRIC PWR TRK DRV		ALL		25.710	37.980	1.5	2.0	2.0	3.700	6.430	0.000	0.130
ELECTRICIAN		ALL		32.590	34.550	1.5	1.5	2.0	5.210	6.360	0.000	0.490
ELECTRONIC SYS TECH		BLD		25.810	27.310	1.5	1.5	2.0	2.800	5.490	0.000	0.250
ELEVATOR CONSTRUCTOR		BLD		37.115	41.750	2.0	2.0	2.0	8.275	4.460	2.227	0.000
FLOOR LAYER		BLD		26.930	27.680	1.5	1.5	2.0	5.000	3.750	0.000	0.350
GLAZIER		BLD		29.480	0.000	2.0	2.0	2.0	8.550	6.920	2.360	0.160
HT/FROST INSULATOR		BLD		30.440	31.440	1.5	1.5	2.0	4.850	8.360	0.000	0.450
IRON WORKER		ALL		26.350	27.850	1.5	1.5	2.0	6.360	8.250	0.000	0.420
LABORER	N	ALL		24.250	24.750	1.5	1.5	2.0	5.250	6.350	0.000	0.600
LABORER	S	ALL		22.100	22.600	1.5	1.5	2.0	5.250	8.200	0.000	0.600
MACHINIST		BLD		36.890	38.890	2.0	2.0	2.0	4.380	5.650	2.550	0.000
MARBLE FINISHERS		BLD		22.610	0.000	1.5	1.5	2.0	5.000	4.300	0.000	0.400
MARBLE MASON		BLD		26.400	28.100	1.5	1.5	5.0	4.750	8.250	2.000	0.390
MILLWRIGHT		ALL		30.480	31.980	1.5	1.5	2.0	5.050	3.750	0.000	0.350
OPERATING ENGINEER		ALL	1	25.900	27.030	1.5	1.5	2.0	6.200	11.45	0.000	1.000
OPERATING ENGINEER		ALL	2	24.770	27.030	1.5	1.5	2.0	6.200	11.45	0.000	1.000
OPERATING ENGINEER		ALL	3	20.290	27.030	1.5	1.5	2.0	6.200	11.45	0.000	1.000
OPERATING ENGINEER		ALL	4	20.350	27.030	1.5	1.5	2.0	6.200	11.45	0.000	1.000
OPERATING ENGINEER		ALL	5	20.020	27.030	1.5	1.5	2.0	6.200	11.45	0.000	1.000
OPERATING ENGINEER		ALL	6	26.450	27.030	1.5	1.5	2.0	6.200	11.45	0.000	1.000
OPERATING ENGINEER		ALL	7	26.750	27.030	1.5	1.5	2.0	6.200	11.45	0.000	1.000
OPERATING ENGINEER		ALL	8	27.030	27.030	1.5	1.5	2.0	6.200	11.45	0.000	1.000
PAINTER		BLD		25.700	26.700	1.5	1.5	2.0	4.650	5.150	0.000	0.350
PAINTER		HWY		26.800	27.800	1.5	1.5	2.0	4.650	5.150	0.000	0.350
PAINTER OVER 30FT		BLD		26.700	27.700	1.5	1.5	2.0	4.650	5.150	0.000	0.350
PAINTER PWR EQMT		BLD		26.700	27.700	1.5	1.5	2.0	4.650	5.150	0.000	0.350
PAINTER PWR EQMT		HWY		27.800	28.800	1.5	1.5	2.0	4.650	5.150	0.000	0.350
PILEDRIVER		ALL		30.480	31.980	1.5	1.5	2.0	5.050	3.750	0.000	0.350
PIPEFITTER	NW	BLD		30.000	32.000	1.5	1.5	2.0	5.940	7.000	0.000	0.350
PIPEFITTER	SE	BLD		31.000	33.500	1.5	1.5	2.0	5.800	3.950	0.000	0.475
PLASTERER		BLD		27.000	28.000	1.5	1.5	2.0	5.650	7.250	0.000	0.250
PLUMBER	NW	BLD		30.450	32.950	1.5	1.5	2.0	4.950	5.450	0.000	0.300
PLUMBER	SE	BLD		31.000	33.500	1.5	1.5	2.0	5.800	3.950	0.000	0.475
ROOFER		BLD		26.250	28.250	1.5	1.5	2.0	6.100	5.950	0.000	0.200
SHEETMETAL WORKER		ALL		27.210	28.460	1.5	1.5	2.0	6.000	4.770	1.630	0.120
SPRINKLER FITTER		BLD		34.230	36.480	2.0	2.0	2.0	6.650	7.850	0.000	0.650
TERRAZZO FINISHER		BLD		31.240	0.000	1.5	1.5	2.0	0.000	0.000	0.000	0.000
TERRAZZO MASON		BLD		30.780	31.080	1.5	1.5	2.0	0.000	3.750	0.000	0.000
TRUCK DRIVER		ALL	1	25.930	0.000	1.5	1.5	2.0	7.250	3.425	0.000	0.000
TRUCK DRIVER		ALL	2	26.330	0.000	1.5	1.5	2.0	7.250	3.425	0.000	0.000
TRUCK DRIVER		ALL	3	26.530	0.000	1.5	1.5	2.0	7.250	3.425	0.000	0.000
TRUCK DRIVER		ALL	4	26.780	0.000	1.5	1.5	2.0	7.250	3.425	0.000	0.000
TRUCK DRIVER		ALL	5	27.530	0.000	1.5	1.5	2.0	7.250	3.425	0.000	0.000
TRUCK DRIVER		O&C	1	20.740	0.000	1.5	1.5	2.0	7.250	3.425	0.000	0.000
TRUCK DRIVER		O&C	2	21.060	0.000	1.5	1.5	2.0	7.250	3.425	0.000	0.000
TRUCK DRIVER		O&C	3	21.220	0.000	1.5	1.5	2.0	7.250	3.425	0.000	0.000
TRUCK DRIVER		O&C	4	21.420	0.000	1.5	1.5	2.0	7.250	3.425	0.000	0.000
TRUCK DRIVER		O&C	5	22.020	0.000	1.5	1.5	2.0	7.250	3.425	0.000	0.000

Legend :

M-F>8 (Overtime is required for any hour greater than 8 worked each day, Monday through Friday.)

OSA (Overtime is required for every hour worked on Saturday)

OSH (Overtime is required for every hour worked on Sunday and Holidays)

H/W (Health & Welfare Insurance)

Pensn (Pension)

Vac (Vacation)

Trng (Training)

## Explanations

### ST. CLAIR COUNTY

LABORERS (NORTH) - The area bounded by Route 159 to a point south of Fairview Heights and west-southwest to Route 3 at Monroe County line.

PLUMBERS & PIPEFITTERS (SOUTHEAST) - That part of the county bordered by Rt. 50 on the North and West including Belleville.

PLUMBERS (NORTHWEST) - Towns of Aloraton, Brooklyn, Cahokia, Caseyville, Centreville, Dupo, East Carondelet, E. St. Louis, Fairview Heights, French Village, National City, O'Fallon, Sauget, and Washington Park.

The following list is considered as those days for which holiday rates of wages for work performed apply: New Years Day, Memorial/Decoration Day, Fourth of July, Labor Day, Veterans Day, Thanksgiving Day, Christmas Day. Generally, any of these holidays which fall on a Sunday is celebrated on the following Monday. This then makes work performed on that Monday payable at the appropriate overtime rate for holiday pay. Common practice in a given local may alter certain days of celebration such as the day after Thanksgiving for Veterans Day. If in doubt, please check with IDOL.

Oil and chip resealing (O&C) means the application of road oils and liquid asphalt to coat an existing road surface, followed by application of aggregate chips or gravel to coated surface, and subsequent rolling of material to seal the surface.

### EXPLANATION OF CLASSES

ASBESTOS - GENERAL - removal of asbestos material/mold and hazardous materials from any place in a building, including mechanical systems where those mechanical systems are to be removed. This includes the removal of asbestos materials/mold and hazardous materials from ductwork or pipes in a building when the building is to be demolished at the time or at some close future date.

ASBESTOS - MECHANICAL - removal of asbestos material from mechanical systems, such as pipes, ducts, and boilers, where the mechanical systems are to remain.



#### CERAMIC TILE FINISHER AND MARBLE FINISHER

The handling, at the building site, of all sand, cement, tile, marble or stone and all other materials that may be used and installed by [a] tile layer or marble mason. In addition, the grouting, cleaning, sealing, and mixing on the job site, and all other work as required in assisting the setter. The term "Ceramic" is used for naming the classification only and is in no way a limitation of the product handled. Ceramic takes into consideration most hard tiles.

#### ELECTRONIC SYSTEMS TECHNICIAN

Installation, service and maintenance of low-voltage systems which utilizes the transmission and/or transference of voice, sound, vision, or digital for commercial, education, security and entertainment purposes for the following: TV monitoring and surveillance, background/foreground music, intercom and telephone interconnect, field programming, inventory control systems, microwave transmission, multi-media, multiplex, radio page, school, intercom and sound burglar alarms and low voltage master clock systems.

Excluded from this classification are energy management systems, life safety systems, supervisory controls and data acquisition systems not intrinsic with the above listed systems, fire alarm systems, nurse call systems and raceways exceeding fifteen feet in length.

#### TRUCK DRIVER - BUILDING, HEAVY AND HIGHWAY CONSTRUCTION

Class 1. Drivers on 2 axle trucks hauling less than 9 ton. Air compressor and welding machines and brooms, including those pulled by separate units, truck driver helpers, warehouse employees, mechanic helpers, greasers and tiremen, pickup trucks when hauling materials, tools, or workers to and from and on-the-job site, and fork lifts up to 6,000 lb. capacity.

Class 2. Two or three axle trucks hauling more than 9 ton but hauling less than 16 ton. A-frame winch trucks, hydrolift trucks, vector trucks or similar equipment when used for transportation purposes. Fork lifts over 6,000 lb. capacity, winch trucks, four axle combination units, and ticket writers.

Class 3. Two, three or four axle trucks hauling 16 ton or more. Drivers on water pulls, articulated dump trucks, mechanics and working forepersons, and dispatchers. Five axle or more combination units.

Class 4. Low Boy and Oil Distributors.

Class 5. Drivers who require special protective clothing while employed on hazardous waste work.

#### TRUCK DRIVER - OIL AND CHIP RESEALING ONLY.

This shall encompass laborers, workers and mechanics who drive contractor or subcontractor owned, leased, or hired pickup, dump, service, or oil distributor trucks. The work includes transporting materials and equipment (including but not limited to, oils, aggregate supplies, parts, machinery and tools) to or from the job site; distributing oil or liquid asphalt and aggregate; stock piling material when in connection with the actual oil and chip contract. The Truck Driver (Oil & Chip Resealing) wage classification does not include supplier delivered materials.

#### OPERATING ENGINEERS

GROUP I. Cranes, Dragline, Shovels, Skimmer Scoops, Clamshells or Derrick Boats, Pile Drivers, Crane-Type Backhoes, Asphalt Plant Operators, Concrete Plant Operators, Dredges, Asphalt Spreading Machines, All Locomotives, Cable Ways, or Tower Machines, Hoists, Hydraulic Backhoes, Ditching Machines or Backfiller, Cherrypickers, Overhead Cranes, Roller, Steam or Gas, Concrete Pavers, Excavators, Concrete Breakers, Concrete Pumps, Bulk Cement Plants, Cement Pumps, Derrick-Type Drills, Boat Operators, Motor Graders or Pushcats, Scoops or Tournapulls, Bulldozers, Endloaders or Fork Lifts, Power Blade or Elevating Graders, Winch Cats, Boom or Winch Trucks or Boom Tractors, Pipe Wrapping or Painting Machines, Asphalt Plant Engineer, Journeyman Lubricating Engineer, Drills (other than Derrick Type), Mud Jacks, or Well Drilling Machines, Boring Machines or Track Jacks, Mixers, Conveyors (Two), Air Compressors (Two), Water Pumps regardless of size (Two), Welding Machines (Two), Siphons or Jets (Two), Winch Heads or Apparatuses (Two), Light Plants (Two), Waterblasters (two), All Tractors regardless of size (straight tractor only), Fireman on Stationary Boilers, Automatic Elevators, Form Grading Machines, Finishing Machines, Power Sub-Grader or Ribbon Machines, Longitudinal Floats, Distributor Operators on Trucks, Winch Heads or Apparatuses (One), Mobil Track air and heaters (two to five), Heavy Equipment Greaser, Relief Operator, Assistant Master Mechanic and Heavy Duty Mechanic, all Operators (except those listed below).

GROUP II. Assistant Operators.

GROUP III. Air Compressors (One), Water Pumps, regardless of Size (One), Waterblasters (one), Welding Machine (One), Mixers (One Bag), Conveyor (One), Siphon or Jet (One), Light Plant (One), Heater (One), Immobile Track Air (One), and Self Propelled Walk-Behind Rollers.

GROUP IV. Asphalt Spreader Oilers, Fireman on Whirlies and Heavy Equipment Oilers, Truck Cranes, Dredges, Monigans, Large Cranes - (Over 65-ton rated capacity) Concrete Plant Oiler, Blacktop Plant Oiler, and Creter Crane Oiler (when required).

GROUP V. Oiler.

GROUP VI. Master Mechanics, Operators on equipment with Booms, including jibs, 100 feet and over, and less than 150 feet long.

GROUP VII. Operators on equipment with Booms, including jibs, 150 feet and over, and less than 200 feet long.

GROUP VIII. Operators on Equipment with Booms, including jibs, 200 feet and over; Tower Cranes; Whirlie Cranes; and Operator Foreman.

TERRAZZO FINISHER

The handling of all materials used for Mosaic and Terrazzo work including preparing, mixing by hand, by mixing machine or transporting of pre-mixed materials and distributing with shovel, rake, hoe, or pail, all kinds of concrete foundations necessary for Mosaic and Terrazzo work, all cement terrazzo, magnesite terrazzo, Do-O-Tex terrazzo, epoxy matrix ter-razzo, exposed aggregate, rustic or rough washed for exterior or interior of buildings placed either by machine or by hand, and any other kind of mixture of plastics composed of chips or granules when mixed with cement, rubber, neoprene, vinyl, magnesium chloride or any other resinous or chemical substances used for seamless flooring systems, and all other building materials, all similar materials and all precast terrazzo work on jobs, all scratch

coat used for Mosaic and Terrazzo work and sub-bed, tar paper and wire mesh (2x2 etc.) or lath. The rubbing, grinding, cleaning and finishing of same either by hand or by machine or by terrazzo resurfacing equipment on new or existing floors. When necessary finishers shall be allowed to assist the mechanics to spread sand bed, lay tarpaper and wire mesh (2x2 etc.) or lath. The finishing of cement floors where additional aggregate of stone is added by spreading or sprinkling on top of the finished base, and troweled or rolled into the finish and then the surface is ground by grinding machines.

#### Other Classifications of Work:

For definitions of classifications not otherwise set out, the Department generally has on file such definitions which are available. If a task to be performed is not subject to one of the classifications of pay set out, the Department will upon being contacted state which neighboring county has such a classification and provide such rate, such rate being deemed to exist by reference in this document. If no neighboring county rate applies to the task, the Department shall undertake a special determination, such special determination being then deemed to have existed under this determination. If a project requires these, or any classification not listed, please contact IDOL at 618/993-7271 for wage rates or clarifications.

#### LANDSCAPING

Landscaping work falls under the existing classifications for laborer, operating engineer and truck driver. The work performed by landscape plantsman and landscape laborer is covered by the existing classification of laborer. The work performed by landscape operators (regardless of equipment used or its size) is covered by the classifications of operating engineer. The work performed by landscape truck drivers (regardless of size of truck driven) is covered by the classifications of truck driver.

# Saline County Prevailing Wage for April 2007

Trade Name	RG	TYP	C	Base	FRMAN	*M-F>8	OSA	OSH	H/W	Pensn	Vac	Trng
=====	==	==	=	=====	=====	=====	==	==	=====	=====	=====	=====
ASBESTOS ABT-GEN		ALL		20.750	21.200	1.5	1.5	2.0	5.250	5.600	0.000	0.700
ASBESTOS ABT-MEC		BLD		20.800	0.000	2.0	2.0	2.0	5.000	3.400	0.000	0.000
BOILERMAKER		BLD		28.500	31.000	1.5	1.5	2.0	6.820	11.03	0.000	0.300
BRICK MASON		BLD		25.470	26.970	1.5	1.5	2.0	6.000	5.400	0.000	0.425
CARPENTER		BLD		27.780	29.280	1.5	1.5	2.0	5.050	3.750	0.000	0.350
CARPENTER		HWY		27.730	29.230	1.5	1.5	2.0	5.050	3.750	0.000	0.350
CEMENT MASON		BLD		23.500	24.500	1.5	1.5	2.0	5.200	3.550	0.000	0.100
CEMENT MASON		HWY		23.750	24.750	1.5	1.5	2.0	5.300	3.700	0.000	0.300
CERAMIC TILE FNSHER		BLD		24.990	0.000	1.5	1.5	2.0	6.000	5.400	0.000	0.425
ELECTRICIAN		ALL		32.910	35.160	1.5	1.5	2.0	5.150	6.580	0.000	0.490
ELECTRONIC SYS TECH		BLD		25.700	27.200	1.5	1.5	2.0	5.150	3.340	0.000	0.250
FLOOR LAYER		BLD		26.930	27.680	1.5	1.5	2.0	5.000	3.750	0.000	0.350
GLAZIER		BLD		22.930	0.000	1.5	1.5	2.0	4.320	3.800	0.000	0.300
HT/FROST INSULATOR		BLD		26.110	27.110	1.5	1.5	2.0	4.800	6.860	0.000	0.190
IRON WORKER		ALL		24.000	25.250	1.5	1.5	2.0	5.780	6.850	0.000	0.345
LABORER		BLD		20.750	21.200	1.5	1.5	2.0	5.250	5.600	0.000	0.600
LABORER		HWY		21.000	21.450	1.5	1.5	2.0	5.350	6.150	0.000	0.600
LABORER		O&C		15.750	16.200	1.5	1.5	2.0	5.350	6.150	0.000	0.600
MACHINIST		BLD		36.890	38.890	2.0	2.0	2.0	4.380	5.650	2.550	0.000
MARBLE FINISHERS		BLD		24.990	0.000	1.5	1.5	2.0	6.000	5.400	0.000	0.425
MARBLE MASON		BLD		25.470	26.970	1.5	1.5	2.0	6.000	5.400	0.000	0.425
MILLWRIGHT		BLD		27.780	29.280	1.5	1.5	2.0	5.050	3.750	0.000	0.350
MILLWRIGHT		HWY		27.730	29.230	1.5	1.5	2.0	5.050	3.750	0.000	0.350
OE RIVER 1		RIV	1	26.900	0.000	1.5	1.5	2.0	5.650	6.100	0.000	1.100
OE RIVER 2		RIV	2	23.450	0.000	1.5	1.5	2.0	5.650	6.100	0.000	1.100
OPERATING ENGINEER		ALL	1	26.800	27.800	1.5	1.5	2.0	5.650	6.100	0.000	1.100
OPERATING ENGINEER		ALL	2	24.900	27.800	1.5	1.5	2.0	5.650	6.100	0.000	1.100
OPERATING ENGINEER		ALL	3	24.150	27.800	1.5	1.5	2.0	5.650	6.100	0.000	1.100
OPERATING ENGINEER		ALL	4	21.400	27.800	1.5	1.5	2.0	5.650	6.100	0.000	1.100
OPERATING ENGINEER		O&C	1	20.100	21.100	1.5	1.5	2.0	5.650	6.100	0.000	1.100
OPERATING ENGINEER		O&C	2	18.680	21.100	1.5	1.5	2.0	5.650	6.100	0.000	1.100
OPERATING ENGINEER		O&C	3	18.120	21.100	1.5	1.5	2.0	5.650	6.100	0.000	1.100
OPERATING ENGINEER		O&C	4	16.050	21.100	1.5	1.5	2.0	5.650	6.100	0.000	1.100
PAINTER		BLD		22.790	23.790	1.5	1.5	2.0	5.430	4.500	0.000	0.250
PAINTER		HWY		27.090	28.090	1.5	1.5	2.0	5.430	4.500	0.000	0.250
PAINTER OVER 30FT		BLD		23.790	24.790	1.5	1.5	2.0	5.430	4.500	0.000	0.250
PAINTER PWR EQMT		BLD		23.790	24.790	1.5	1.5	2.0	5.430	4.500	0.000	0.250
PAINTER PWR EQMT		HWY		28.090	29.090	1.5	1.5	2.0	5.430	4.500	0.000	0.250
PILEDRIVER		BLD		27.780	29.280	1.5	1.5	2.0	5.050	3.750	0.000	0.350
PILEDRIVER		HWY		27.730	29.230	1.5	1.5	2.0	5.050	3.750	0.000	0.350
PIPEFITTER		BLD		28.750	31.620	1.5	1.5	2.0	6.000	7.500	0.000	0.400
PLASTERER		BLD		23.500	24.500	1.5	1.5	2.0	5.200	3.550	0.000	0.100
PLUMBER		BLD		29.500	32.450	1.5	1.5	2.0	6.600	7.500	0.000	0.550
ROOFER		BLD		19.700	20.500	1.5	1.5	2.0	5.700	3.800	0.000	0.000
SHEETMETAL WORKER		ALL		27.210	28.460	1.5	1.5	2.0	6.000	4.770	1.630	0.120
SPRINKLER FITTER		BLD		31.240	33.240	1.5	1.5	2.0	6.500	5.350	0.000	0.250
STONE MASON		BLD		25.470	26.970	1.5	1.5	2.0	6.000	5.400	0.000	0.425
TERRAZZO FINISHER		BLD		24.990	0.000	1.5	1.5	2.0	6.000	5.400	0.000	0.425
TERRAZZO MASON		BLD		28.500	28.800	1.5	1.5	2.0	0.000	2.950	0.000	0.000
TRUCK DRIVER		ALL	1	24.990	0.000	1.5	1.5	2.0	7.250	4.200	0.000	0.000
TRUCK DRIVER		ALL	2	25.390	0.000	1.5	1.5	2.0	7.250	4.200	0.000	0.000
TRUCK DRIVER		ALL	3	25.590	0.000	1.5	1.5	2.0	7.250	4.200	0.000	0.000
TRUCK DRIVER		ALL	4	25.840	0.000	1.5	1.5	2.0	7.250	4.200	0.000	0.000
TRUCK DRIVER		ALL	5	26.590	0.000	1.5	1.5	2.0	7.250	4.200	0.000	0.000
TRUCK DRIVER		O&C	1	19.500	0.000	1.5	1.5	2.0	4.275	4.670	0.000	0.000
TRUCK DRIVER		O&C	2	15.900	0.000	1.5	1.5	2.0	4.275	4.670	0.000	0.000
TRUCK DRIVER		O&C	3	16.400	0.000	1.5	1.5	2.0	4.275	4.670	0.000	0.000
TUCKPOINTER		BLD		25.470	26.970	1.5	1.5	2.0	6.000	5.400	0.000	0.425

## Legend:

M-F>8 (Overtime is required for any hour greater than 8 worked each day, Monday through Friday.)

OSA (Overtime is required for every hour worked on Saturday)

OSH (Overtime is required for every hour worked on Sunday and Holidays)

H/W (Health & Welfare Insurance)

Pensn (Pension)

Vac (Vacation)

Trng (Training)

## Explanations

### SALINE COUNTY

The following list is considered as those days for which holiday rates of wages for work performed apply: New Years Day, Memorial/Decoration Day, Fourth of July, Labor Day, Veterans Day, Thanksgiving Day, Christmas Day. Generally, any of these holidays which fall on a Sunday is celebrated on the following Monday. This then makes work performed on that Monday payable at the appropriate overtime rate for holiday pay. Common practice in a given local may alter certain days of celebration such as the day after Thanksgiving for Veterans Day. If in doubt, please check with IDOL.

Oil and chip resealing (O&C) means the application of road oils and liquid asphalt to coat an existing road surface, followed by application of aggregate chips or gravel to coated surface, and subsequent rolling of material to seal the surface.

### EXPLANATION OF CLASSES

ASBESTOS - GENERAL - removal of asbestos material/mold and hazardous materials from any place in a building, including mechanical systems where those mechanical systems are to be removed. This includes the removal of asbestos materials/mold and hazardous materials from ductwork or pipes in a building when the building is to be demolished at the time or at some close future date.

ASBESTOS - MECHANICAL - removal of asbestos material from mechanical systems, such as pipes, ducts, and boilers, where the mechanical systems are to remain.

### LABORER - OIL AND CHIP RESEALING ONLY

Hook and unhook chip box from aggregate truck; distribute material within chip box; perform flagging work related to oil and chip resealing; hand spray oil fluids; handle traffic control, including setting-up and maintaining barricades, drums, cones, delineators, signs and other such items, as well as laying-out and applying or removing temporary roadway markings used to control traffic in job site related to oil and chip resealing; and perform clean-up related

to oil and chip resealing.

#### CERAMIC TILE FINISHER, MARBLE FINISHER, TERRAZZO FINISHER

Assisting, helping or supporting the tile, marble and terrazzo mechanic by performing their historic and traditional work assignments required to complete the proper installation of the work covered by said crafts. The term "Ceramic" is used for naming the classification only, and is in no a limitation of the product handled. Ceramic takes into consideration most hard tiles.

#### ELECTRONIC SYSTEMS TECHNICIAN

Installation, service and maintenance of low-voltage systems which utilizes the transmission and/or transference of voice, sound, vision, or digital for commercial, education, security and entertainment purposes for the following: TV monitoring and surveillance, background/foreground music, intercom and telephone interconnect, field programming, inventory control systems, microwave transmission, multi-media, multiplex, radio page, school, intercom and sound burglar alarms and low voltage master clock systems.

Excluded from this classification are energy management systems, life safety systems, supervisory controls and data acquisition systems not intrinsic with the above listed systems, fire alarm systems, nurse call systems and raceways exceeding fifteen feet in length.

#### TRUCK DRIVER - BUILDING, HEAVY AND HIGHWAY CONSTRUCTION

Class 1. Drivers on 2 axle trucks hauling less than 9 ton. Air compressor and welding machines and brooms, including those pulled by separate units, truck driver helpers, warehouse employees, mechanic helpers, greasers and tiremen, pickup trucks when hauling materials, tools, or workers to and from and on-the-job site, and fork lifts up to 6,000 lb. capacity.

Class 2. Two or three axle trucks hauling more than 9 ton but hauling less than 16 ton. A-frame winch trucks, hydrolift trucks, vector trucks or similar equipment when used for transportation purposes. Fork lifts over 6,000 lb. capacity, winch trucks, four axle combination units, and ticket writers.

Class 3. Two, three or four axle trucks hauling 16 ton or more. Drivers on water pulls, articulated dump trucks, mechanics and working forepersons, and dispatchers. Five axle or more combination units.

Class 4. Low Boy and Oil Distributors.

Class 5. Drivers who require special protective clothing while employed on hazardous waste work.

#### TRUCK DRIVER - O & C (Oil and Chip Resealing ONLY)

It involves driving of contractor or subcontractor owned, leased, or hired pickup, dump, service, or oil distributor trucks. Includes transporting materials and equipment (including, but not limited to oils, aggregate supplies, parts, machinery and tools) to or from the job site; distributing oil or liquid asphalt and aggregate; stock piling material; and maintaining trucks at job site related to oil and chip resealing.

Class 1. Distributors, liquid asphalt hauling and hauling of asphalt rubber-tired rollers.

Class 2. Stockpiling.

Class 3. Tandem hauling to job site.

OPERATING ENGINEERS - BUILDING, HEAVY AND HIGHWAY CONSTRUCTION

Class 1. APSCO or Equal Spreading Machine, Backhoe, Backfiller, Boom or Winch Cat, Bituminous Mixplane Machine, Blacksmith, Bituminous Surfacing Machine, Bull-Dozer, Crane, Shovel, Dragline, Truck Crane, Pile Driver, Concrete Breaker, Concrete or Pumpcrete Pumps, Dinky or Standard Locomotives, Well or Caisson Drills, Elevating Grader, Fork Lifts, Flexplane, Gradeall, Hi-Lift Hoists, Guy-Derricks, Hysters, Mechanic Motor Patrol, Mixers-21 cu. ft. or over, Push Cats, Pulls and Scrapers, Two Well Point Pumps, Pulverizer or Tiller, PugMill, Rubber-Tired Farm Type Tractor with Bulldozer/Blade/Auger or hi-lift over 1/2 yd., Jersey Spreader, Tract-Air used with Drill or Hi-Lift, Trenching or Ditching Machines, Wood Chipper w/Tractor, Self-Propelled Roller w/Blade, Equipment Greaser, Self-Propelled Bump Grinder on Concrete pavement, Boat Operator, Skid-Loaders, Tuggers, Lazer Screed, and Self-Propelled Chip Spreader (when others run conveyors).

Class 2. Any type tractor pulling any type roller or disc, Two Air Compressors (220 cu. ft. capacity or over), Two AirTract Drills, Air-Track Drill w/Compressor, Automatic Bins or Scales w/Compressor or Generator, Pipeline Boring Machine, Bulk Cement Plant w/Separate Compressor, Power Operated Bull Float, Hydra-Lift w/Single Motor, Straw Mulcher Blower w/Spout, Self-Propelled Roller/Compactor, Back-End man on Bituminous Surfacing Machine, oiler on milling machine.

Class 3. Air Compressor w/Valve driving piling, Boom or Winch Type Truck, Two Conveyors, Self-Propelled Concrete Saw, Form Grader, Truck Crane Oiler, Self-Propelled Vibrator, Rubber Tired Farm Type Tractor w/Blade/Bulldozer/Auger/hi-lift - 1/2 yd. or less, Elevator Operator, Man Lift (scissor lift) when lifting materials.

Class 4. Air-Track Drill (one), Belt Drag Machine, Power Broom, Mechanical Plasterer Applicator, Trac-Air, Air Compressor (220 cu. ft. or over) One, Air Compressor (under 220 cu. ft) four, Automatic Bin, Bulk Cement Plant w/Built-in Compressor running off same motor or electric motor, Fireman or Switchman, Self-Propelled Form Tamper, Light Plants (4), Welding Machines (4), Pumps (4), or Combination of four (4) Pumps, Light Plants, Welding Machines, Air-Compressors (under 220 cu. ft.), Mudjacks or Wood Chipper, Mixers - less than 21 cu. ft. Mortar Mixer w/Skip or Pump, Pipeline Tract Jack. One Operating Engineer may operate and maintain any combination of the following pieces of equipment, not to exceed four (4) which shall be within a reasonable distance, such combination may include any equipment in this classification: (Compressors, Light Plants, Generators, Welding Machines, Pumps or Conveyors), One Well- Point Pump, Two Motor Driven Heaters, One Air Compressor (under 220 cu. ft.), One Engine-Driven Conveyor, One Motor Driven Heater, One Light Plant, One Pump, One Welding Machine, One Ulmac or Equal Spreader, Oilers, and one Generator 10 kw or greater.

OPERATING ENGINEER - O & C (Oil and Chip Resealing ONLY). Includes the operation of all motorized heavy equipment used in oil and chip rsealing, including but not limited to operating self-propelled chip spreaders, and all types of rollers (both hard and rubber tired); and other duties pertaining to the operation or maintenance of heavy equipment relatd to oil and chip resealing.

Class 1. See Class 1 above for types of equipment operated.

Class 2. See Class 2 above for types of equipment operated.

Class 3. See Class 3 above for types of equipment operated.

Class 4. See Class 4 above for types of equipment operated.

OPERATING ENGINEER RIVER WORK 1 - operate the following machines when working on River Work and Levee Work on the Mississippi and Ohio Rivers, Lakes and Tributaries: Crane, Shovel, Drageline, Scrapers, Dredge, Derrick, Pile-Driver, Push Boat, all power boat operators, Mechanic, Engineman on Dredge, Leverman on Dredge, All Bituminous Spreader machines, Backhoe, Backfiller, Boom, or Winch Cat, Bituminous Mixplane Machine, Blacksmith, Bituminous Surfacing Machine, Bulldozer, Truck Cranes, Hydraulic Truck Mounted Boom/Crane, Concrete Finishing Machine, or Spreader Machine, Concrete Breaker, Concrete or Pumpcrete Machines, Concrete Plant Operator, All Off Road Material Hauling Equipment, Dinky or Standard Locomotives, Well Drill, Elevating Grader, Fork-Lifts, Flexplane, Gradeall, Hi-Lift, Power Handblade Tugger type Hoist, Hoist Two Drum (or over one), Gyderrick, Hyster, Motor Patrol, Mixers - 21 Cu. Ft. or over, Push Cat, Pulls, & Scrapers, Pumps-Two Well Points, Equipment Greaser, P & H Pulverizer or Pulverizer equal to Pugmill, Pugmill, Rubber-Tired farm type tractor w/Bulldozer/Blade/Auger or Hi-Lift over ½ yard, Skimmer Scoops, Seaman Tiller, Jersey Spreader, Tract-Air used with Drill or Hi-Lift, Trenching or Ditching Machine, Wood Chipper w/Tractor, self-propelled roller w/Blade, Concrete Pumps and Small Equipment Operators.

OPERATING ENGINEER RIVER 2 - when working on River Work and Levee Work on the Mississippi and Ohio Rivers, Lakes and Tributaries shall be employed as the Oiler or Fireman on Crane, Dragline, Shovel, Dredge, Truck Crane, Pile Driver, Gradeall, Dinky or Standard Locomotive, Guy Derrick, Trenching Machine or Ditching Machine 80 H.P. and over, All Terrain (cherry-picker) with over 40 ton Lifting Capacity, Deck Oiler and Deckhands.

#### Other Classifications of Work:

For definitions of classifications not otherwise set out, the Department generally has on file such definitions which are available. If a task to be performed is not subject to one of the classifications of pay set out, the Department will upon being contacted state which neighboring county has such a classification and provide such rate, such rate being deemed to exist by reference in this document. If no neighboring county rate applies to the task, the Department shall undertake a special determination, such special determination being then deemed to have existed under this determination. If a project requires these, or any classification not listed, please contact IDOL at 618/993-7271 for wage rates or clarifications.

#### LANDSCAPING

Landscaping work falls under the existing classifications for laborer, operating engineer and truck driver. The work performed by landscape plantsman and landscape laborer is covered by the existing classification of laborer. The work performed by landscape operators (regardless of equipment used or its size) is covered by the classifications of operating engineer. The work performed by landscape truck drivers (regardless of size of truck driven) is covered by the classifications of truck driver.



# Sangamon County Prevailing Wage for April 2007

Trade Name	RG	TYP	C	Base	FRMAN	*M-F>8	OSA	OSH	H/W	Pensn	Vac	Trng
=====	==	===	=	=====	=====	=====	===	===	=====	=====	=====	=====
ASBESTOS ABT-GEN		BLD		25.370	26.370	1.5	1.5	2.0	5.050	5.330	0.000	0.700
ASBESTOS ABT-MEC		BLD		25.290	26.290	1.5	1.5	2.0	4.450	2.500	0.000	0.250
BOILERMAKER		BLD		28.500	31.000	1.5	1.5	2.0	6.820	11.03	0.000	0.300
BRICK MASON		BLD		24.650	25.400	2.0	2.0	2.0	6.000	6.700	0.000	0.490
CARPENTER		BLD		25.910	27.910	1.5	1.5	2.0	6.500	6.480	0.000	0.320
CARPENTER		HWY		25.750	27.500	1.5	1.5	2.0	6.500	6.500	0.000	0.300
CEMENT MASON		BLD		22.800	23.800	1.5	1.5	2.0	5.200	8.080	0.000	0.150
CEMENT MASON		HWY		22.170	23.170	1.5	1.5	2.0	5.200	7.300	0.000	0.250
CERAMIC TILE FNSHER		BLD		23.300	0.000	1.5	1.5	2.0	6.000	6.700	0.000	0.000
ELECTRIC PWR EQMT OP		ALL		30.750	0.000	1.5	1.5	2.0	4.750	8.610	0.000	0.000
ELECTRIC PWR GRNDMAN		ALL		21.090	0.000	1.5	1.5	2.0	4.750	5.905	0.000	0.000
ELECTRIC PWR LINEMAN		ALL		34.160	36.350	1.5	1.5	2.0	4.750	9.560	0.000	0.000
ELECTRIC PWR TRK DRV		ALL		22.130	0.000	1.5	1.5	2.0	4.750	6.200	0.000	0.000
ELECTRICIAN		BLD		31.220	33.220	1.5	1.5	2.0	5.150	5.340	0.000	0.300
ELECTRONIC SYS TECH		BLD		24.830	26.330	1.5	1.5	2.0	5.150	3.190	0.000	0.250
ELEVATOR CONSTRUCTOR		BLD		34.190	38.460	2.0	2.0	2.0	8.275	6.060	2.050	0.000
GLAZIER		BLD		27.130	28.130	1.5	2.0	2.0	5.430	4.000	0.000	0.280
HT/FROST INSULATOR		BLD		30.440	31.440	1.5	1.5	2.0	4.850	8.360	0.000	0.450
IRON WORKER		BLD		25.400	27.150	1.5	1.5	2.0	5.860	7.900	0.000	0.300
IRON WORKER		HWY		25.400	26.900	1.5	1.5	2.0	5.860	7.900	0.000	0.300
LABORER		BLD		23.870	24.870	1.5	1.5	2.0	5.050	5.330	0.000	0.600
LABORER		HWY		24.000	24.750	1.5	1.5	2.0	5.050	5.330	0.000	0.600
LATHER		BLD		25.910	27.910	1.5	1.5	2.0	6.500	6.480	0.000	0.320
MACHINIST		BLD		36.890	38.890	2.0	2.0	2.0	4.380	5.650	2.550	0.000
MARBLE FINISHERS		BLD		23.300	0.000	1.5	1.5	2.0	6.000	6.700	0.000	0.000
MARBLE MASON		BLD		24.800	25.550	2.0	2.0	2.0	6.000	6.700	0.000	0.000
MILLWRIGHT		BLD		26.000	28.000	1.5	1.5	2.0	6.500	6.850	0.000	0.320
MILLWRIGHT		HWY		19.410	20.660	1.5	1.5	2.0	2.800	3.000	0.000	0.000
OPERATING ENGINEER		BLD	1	26.550	0.000	1.5	1.5	2.0	6.150	6.200	0.000	0.850
OPERATING ENGINEER		BLD	2	24.200	0.000	1.5	1.5	2.0	6.150	6.200	0.000	0.850
OPERATING ENGINEER		BLD	3	20.600	0.000	1.5	1.5	2.0	6.150	6.200	0.000	0.850
OPERATING ENGINEER		BLD	4	28.050	0.000	1.5	1.5	2.0	6.150	6.200	0.000	0.850
OPERATING ENGINEER		HWY	1	26.800	0.000	1.5	1.5	2.0	6.150	6.200	0.000	0.850
OPERATING ENGINEER		HWY	2	24.030	0.000	1.5	1.5	2.0	6.150	6.200	0.000	0.850
OPERATING ENGINEER		HWY	3	19.800	0.000	1.5	1.5	2.0	6.150	6.200	0.000	0.850
OPERATING ENGINEER		HWY	4	28.300	0.000	1.5	1.5	2.0	6.150	6.200	0.000	0.850
PAINTER		ALL		25.390	26.390	1.5	1.5	2.0	4.650	5.500	0.000	0.250
PAINTER OVER 30FT		ALL		26.390	27.390	1.5	1.5	2.0	4.650	5.500	0.000	0.250
PAINTER PWR EQMT		ALL		26.390	27.390	1.5	1.5	2.0	4.650	5.500	0.000	0.250
PAINTER SIGNS		ALL		14.440	0.000	1.5	1.5	2.0	0.000	0.000	0.000	0.000
PILEDRIVER		BLD		26.410	28.410	1.5	1.5	2.0	6.500	6.480	0.000	0.320
PILEDRIVER		HWY		26.250	28.000	1.5	1.5	2.0	6.500	6.500	0.000	0.300
PIPEFITTER		BLD		34.700	37.200	1.5	1.5	2.0	6.450	4.750	0.000	0.350
PLASTERER		BLD		25.000	26.500	1.5	1.5	2.0	4.830	8.050	0.000	0.500
PLUMBER		BLD		34.700	37.200	1.5	1.5	2.0	6.450	4.750	0.000	0.350
ROOFER		BLD		24.310	26.740	1.5	1.5	2.0	4.650	5.250	0.000	0.100
SHEETMETAL WORKER		BLD		27.820	29.570	1.5	1.5	2.0	7.150	7.880	0.000	0.350
SPRINKLER FITTER		BLD		31.240	33.240	1.5	1.5	2.0	6.500	5.350	0.000	0.250
STONE MASON		BLD		24.650	25.400	2.0	2.0	2.0	6.000	6.700	0.000	0.490
TERRAZZO FINISHER		BLD		23.300	0.000	1.5	1.5	2.0	6.000	6.700	0.000	0.000
TERRAZZO MASON		BLD		24.800	25.550	2.0	2.0	2.0	6.000	6.700	0.000	0.000
TILE MASON		BLD		24.800	25.550	2.0	2.0	2.0	6.000	6.700	0.000	0.000
TRUCK DRIVER		ALL	1	25.930	0.000	1.5	1.5	2.0	7.250	3.425	0.000	0.000
TRUCK DRIVER		ALL	2	26.330	0.000	1.5	1.5	2.0	7.250	3.425	0.000	0.000
TRUCK DRIVER		ALL	3	26.530	0.000	1.5	1.5	2.0	7.250	3.425	0.000	0.000
TRUCK DRIVER		ALL	4	26.780	0.000	1.5	1.5	2.0	7.250	3.425	0.000	0.000
TRUCK DRIVER		ALL	5	27.530	0.000	1.5	1.5	2.0	7.250	3.425	0.000	0.000
TRUCK DRIVER		O&C	1	20.740	0.000	1.5	1.5	2.0	7.250	3.425	0.000	0.000
TRUCK DRIVER		O&C	2	21.060	0.000	1.5	1.5	2.0	7.250	3.425	0.000	0.000

TRUCK DRIVER	O&C 3	21.220	0.000	1.5	1.5	2.0	7.250	3.425	0.000	0.000
TRUCK DRIVER	O&C 4	21.420	0.000	1.5	1.5	2.0	7.250	3.425	0.000	0.000
TRUCK DRIVER	O&C 5	22.020	0.000	1.5	1.5	2.0	7.250	3.425	0.000	0.000
TUCKPOINTER	BLD	24.650	25.400	2.0	2.0	2.0	6.000	6.700	0.000	0.490

Legend:

M-F>8 (Overtime is required for any hour greater than 8 worked each day, Monday through Friday.)

OSA (Overtime is required for every hour worked on Saturday)

OSH (Overtime is required for every hour worked on Sunday and Holidays)

H/W (Health & Welfare Insurance)

Pensn (Pension)

Vac (Vacation)

Trng (Training)

## Explanations

### SANGAMON COUNTY

The following list is considered as those days for which holiday rates of wages for work performed apply: New Years Day, Memorial/Decoration Day, Fourth of July, Labor Day, Veterans Day, Thanksgiving Day, Christmas Day. Generally, any of these holidays which fall on a Sunday is celebrated on the following Monday. This then makes work performed on that Monday payable at the appropriate overtime rate for holiday pay. Common practice in a given local may alter certain days of celebration such as the day after Thanksgiving for Veterans Day. If in doubt, please check with IDOL.

Oil and chip resealing (O&C) means the application of road oils and liquid asphalt to coat an existing road surface, followed by application of aggregate chips or gravel to coated surface, and subsequent rolling of material to seal the surface.

### EXPLANATION OF CLASSES

ASBESTOS - GENERAL - removal of asbestos material/mold and hazardous materials from any place in a building, including mechanical systems where those mechanical systems are to be removed. This includes the removal of asbestos materials/mold and hazardous materials from ductwork or pipes in a building when the building is to be demolished at the time or at some close future date.

ASBESTOS - MECHANICAL - removal of asbestos material from mechanical systems, such as pipes, ducts, and boilers, where the mechanical systems are to remain.

### CERAMIC TILE FINISHER, MARBLE FINISHER, TERRAZZO FINISHER

Assisting, helping or supporting the tile, marble and terrazzo mechanic by performing their historic and traditional work assignments required to complete the proper installation of the work covered by said crafts. The term "Ceramic" is used for naming the classification

only and is in no way a limitation of the product handled. Ceramic takes into consideration most hard tiles.

#### ELECTRONIC SYSTEMS TECHNICIAN

Installation, service and maintenance of low-voltage systems which utilizes the transmission and/or transference of voice, sound, vision, or digital for commercial, education, security and entertainment purposes for the following: TV monitoring and surveillance, background/foreground music, intercom and telephone interconnect, field programming, inventory control systems, microwave transmission, multi-media, multiplex, radio page, school, intercom and sound burglar alarms and low voltage master clock systems.

Excluded from this classification are energy management systems, life safety systems, supervisory controls and data acquisition systems not intrinsic with the above listed systems, fire alarm systems, nurse call systems and raceways exceeding fifteen feet in length.

#### TRUCK DRIVER - BUILDING, HEAVY AND HIGHWAY CONSTRUCTION

Class 1. Drivers on 2 axle trucks hauling less than 9 ton. Air compressor and welding machines and brooms, including those pulled by separate units, truck driver helpers, warehouse employees, mechanic helpers, greasers and tiremen, pickup trucks when hauling materials, tools, or workers to and from and on-the-job site, and fork lifts up to 6,000 lb. capacity.

Class 2. Two or three axle trucks hauling more than 9 ton but hauling less than 16 ton. A-frame winch trucks, hydrolift trucks, vector trucks or similar equipment when used for transportation purposes. Fork lifts over 6,000 lb. capacity, winch trucks, four axle combination units, and ticket writers.

Class 3. Two, three or four axle trucks hauling 16 ton or more. Drivers on water pulls, articulated dump trucks, mechanics and working forepersons, and dispatchers. Five axle or more combination units.

Class 4. Low Boy and Oil Distributors.

Class 5. Drivers who require special protective clothing while employed on hazardous waste work.

#### TRUCK DRIVER - OIL AND CHIP RESEALING ONLY.

This shall encompass laborers, workers and mechanics who drive contractor or subcontractor owned, leased, or hired pickup, dump, service, or oil distributor trucks. The work includes transporting materials and equipment (including but not limited to, oils, aggregate supplies, parts, machinery and tools) to or from the job site; distributing oil or liquid asphalt and aggregate; stock piling material when in connection with the actual oil and chip contract. The Truck Driver (Oil & Chip Resealing) wage classification does not include supplier delivered materials.

#### OPERATING ENGINEERS - BUILDING

CLASS 1. Asphalt Screed Man; Aspco Concrete Spreaders; Asphalt Pavers; Asphalt Plant Engineer; Asphalt Rollers on Bituminous Concrete; Athey Loaders; Backfillers, Crane Type; Backhoes; Barber Green Loaders; Bulldozers; Cableways; Cherry Pickers; Clam Shells; C.M.I. & similar type autograde formless paver, autograde placer & finisher; Concrete Breakers; Concrete Pumps; Derricks; Derrick Boats; Draglines; Earth Auger or Boring Machines; Elevating Graders; Engineers on Dredges; Gravel Processing Machines; Head Equipment

Greaser; High Lifts or Fork Lifts; Hoists with two or more drums or two or more load lines; Locomotives, All; Mechanics; Motor Graders or Auto Patrols; Operators or Leverman on Dredges; Operators, Power Boat; Operators, Pug Mill (Asphalt Plants); Orange Peels; Overhead Cranes; Paving Mixers; Piledrivers; Pipe Wrapping and Painting Machines; Pushdozers, or Push Cats; Robotic Controlled Equipment in this Classification; Rock Crushers; Ross Carrier or Similar Machines; Rotomill; Scoops, Skimmer, two cu. yd. capacity and under; Scoops, All or Tournapull; Sheep-Foot Roller (Self Propelled); Shovels; Skid Steer; Skimmer Scoops; Temporary Concrete Plant Operators; Test Hole Drilling Machines; Tower Machines; Tower Mixers; Track Type End Loaders; Track Type Fork Lifts or High Lifts; Track Jacks and Tampers; Tractors, Sideboom; Trenching or Ditching Machine; Tunnelluggers; Vermeer Type Saws; Water Blaster Cutting Head; Wheel Type End Loaders; Winch Cat.

CLASS 2. Air Compressors (six to eight)\*; Asphalt Boosters and Heaters; Asphalt Distributors; Asphalt Plant Fireman; Oiler on Two Paving Mixers When Used in Tandem; Boom or Winch Trucks; Bull Floats or Flexplanes; Concrete Finishing Machine; Concrete Saws, Self-Propelled; Concrete Spreading Machines; Conveyors (six to eight)\*; Generators (six to eight)\*; Gravel or Stone Spreader, Power Operated; Hoist (with One Drum and One Load Line); Light Plants (six to eight)\*; Mechanical Heaters (six to eight)\*; Mud Jacks; Post Hole Digger, Mechanical; Pug Mills when used for other than Asphalt operation; Robotic Controlled Equipment in this Classification; Road or Street Sweeper, Self Propelled; Rollers (except bituminous concrete); Seaman Tiller; Straw Machine; Vibratory Compactor; Water Blaster, Power Unit; Welding Machines (six to eight)\*; Well Drill Machines.

CLASS 3. Air Compressors(one to five)\*; Air Compressors, Track or Self-Propelled; Automatic Hoist; Building Elevators; Bulk Cement Batching Plants; Conveyors (one to five)\*; Concrete Mixers (Except Plant, Paver, or Tower); Firemen; Generators (one to five)\*; Greasers; Helper on Single Paving Mixer; Hoist, Automatic; Light Plants (one to five)\*; Mechanic Helpers; Mechanical Heaters (one to five)\*; Oilers; Power Form Graders; Power Sub-Graders; Robotic Controlled Equipment in this Classification; Scissors Hoist; Tractors without power attachments regardless of size or type; Truck Crane Oiler and Driver (1 man); Vibratory Hammer (power source); Water Pumps (one to five)\*; Welding Machines (1/300 Amp. or over)\*; Welding machines (one to five)\*

CLASS 4. Lattice Boom Crawler Cranes; Lattice Boom Truck Cranes; Telescopic Truck-Mounted Cranes; Tower Cranes.

\* Combinations of one to eight of any Air Compressors, Conveyors, Welding Machines, Water Pumps, Light Plants, or Generators shall be in batteries or within 400 feet and shall be paid as per the Classification Schedule contained in this Article.

#### OPERATING ENGINEERS - HIGHWAY

CLASS 1. Asphalt Screed Man; Asphco Concrete Spreaders; Asphalt Pavers; Asphalt Plant Engineer; Asphalt Rollers on Bituminous Concrete; Athey Loaders; Backhoes; Barber Green Loaders; Bulldozers; Cableways; Carry Deck Pickers; Cherry Pickers (Rough Terrain); C.M.I. & similar type-autograde formless paver, autograde placer & finisher; Concrete Breakers; Concrete Plant Operators; Concrete Pumps; Derricks; Derrick Boats; Dewatering Systems; Earth Auger or Boring Machines; Elevating Graders; Engineers on Dredges; Gravel Processing Machines;

Grout Pump; Head Equipment Greaser; High Lifts or Fork Lifts; Hoists with two or more drums or two or more load lines; Hydro Jet or Hydro Laser; Locomotives, All; Mechanics; Motor Graders or Auto Patrols; Multi-Point Power Lifting Equipment; Operators or Leverman on Dredges; Operators, Power Boat; Operators, Pug Mill (Asphalt Plants); Overhead Cranes; Paving Mixers; Piledrivers; Pipe Wrapping and Painting Machines; Push-dozers, or Push Cats; Robotic Controlled Equipment in this Classification; Rock Crushers; Ross Carrier or Similar Machines; Roto-Mill; Scoops, Skimmer, two cu. yd. capacity and under; Sheep-Foot Roller (Self Pro-pelled); Shovels; Skid Steer; Skimmer Scoops; Test Hole Drilling Machines; Tower Machines; Tower Mixers; Track Type End Loaders; Track Type Fork Lifts or High Lifts; Track Jacks and Tampers; Tractors, Side-boom; Trenching or Ditching Machine; Tunnelluggers; Vermeer-Type Saws; Wheel Type End Loaders; Winch Cat; Scoops, All or Tournapull.

CLASS 2. Air Compressors (six to eight)\*; Articulated Dumps; Asphalt Boosters and Heaters; Asphalt Distributors; Asphalt Plant Fireman; Boom or Winch Trucks; Building Elevators; Bull Floats or Flexplanes; Concrete Finishing Machine; Concrete Saws, Self-Propelled; Concrete Spreading Machines; Conveyors (six to eight)\*; Generators (six to eight)\*; Gravel or Stone Spreader, Power Operated; Hoist, Automatic; Hoist with One Drum and One Load Line; Light Plants (six to eight)\*; Mechanical Heaters (six to eight)\*; Mud Jacks; Off Road Water Wagons; Oiler on Two Paving Mixers When Used in Tandem; Post Hole Digger, Mechanical; Robotic Controlled Equipment in This Classification; Road or Street Sweeper, Self-Propelled; Rollers (except bituminous concrete); Scissor Hoist; Sea-man Tiller; Straw Machine; Vibratory Compactor; Water Pumps (six to eight)\*; Well Drill Machines.

CLASS 3. Air Compressors (one to five)\*; Air Compressors, Track or Self-Propelled; Bulk Cement Batching Plants; Conveyors (one to five)\*; Concrete Mixers (Except Plant, Paver, or Tower); Firemen; Generators (one to five)\*; Greasers; Helper on Single Paving Mixer; Light Plants (one to five)\*; Mechanic Helpers; Mechanical Heaters (one to five)\*; Oilers; Power Form Graders; Power Sub-Graders; Pug Mills when used for other than Asphalt operation; Robotic Controlled Equipment in This Classification; Tractors without power attachments, regardless of size or type; Truck Crane Oiler and Driver (1 man); Vibratory Hammer (power source); Water Pumps (one to five)\*; Welding Machines (one 300 Amp. or over)\*; Welding Machines (one to five)\*.

CLASS 4. Lattice Boom Crawler Crane; Lattice Boom Truck Crane; Telescopic Truck-Mounted Crane; Tower Crane.

\*Combinations of one to eight of any Air Compressors, Conveyors, Welding Machines, Water Pumps, Light Plants or Generators shall be in batteries or within 400 feet and shall be paid as per the Classification Schedule contained in this Article.

Other Classifications of Work:

For definitions of classifications not otherwise set out, the Department generally has on file such definitions which are available. If a task to be performed is not subject to one of the classifications of pay set out, the Department will upon being contacted state which neighboring county has such a classification and provide such rate, such rate being deemed to exist by reference in this document. If no neighboring county rate applies to the task, the Department shall undertake a special determination, such special determination being then deemed to have existed under this determination. If a project requires these, or any classification not

listed, please contact IDOL at 618/993-7271 for wage rates or clarifications.

#### LANDSCAPING

Landscaping work falls under the existing classifications for laborer, operating engineer and truck driver. The work performed by landscape plantsman and landscape laborer is covered by the existing classification of laborer. The work performed by landscape operators (regardless of equipment used or its size) is covered by the classifications of operating engineer. The work performed by landscape truck drivers (regardless of size of truck driven) is covered by the classifications of truck driver.

# Schuyler County Prevailing Wage for April 2007

Trade Name	RG	TYP	C	Base	FRMAN	*M-F>8	OSA	OSH	H/W	Pensn	Vac	Trng
=====	==	==	=	=====	=====	=====	==	==	=====	=====	=====	=====
ASBESTOS ABT-GEN		BLD		22.260	23.260	1.5	1.5	2.0	5.300	6.030	0.000	0.600
ASBESTOS ABT-MEC		BLD		25.290	26.290	1.5	1.5	2.0	4.450	2.500	0.000	0.250
BOILERMAKER		BLD		30.970	33.970	2.0	2.0	2.0	8.270	7.740	0.000	0.300
BRICK MASON		BLD		24.370	25.370	1.5	1.5	2.0	6.000	5.400	0.000	0.490
CARPENTER		BLD		24.490	26.490	1.5	1.5	2.0	6.500	7.900	0.000	0.320
CARPENTER		HWY		24.250	26.000	1.5	1.5	2.0	6.500	7.800	0.000	0.300
CEMENT MASON		BLD		22.800	23.800	1.5	1.5	2.0	5.200	8.080	0.000	0.150
CEMENT MASON		HWY		24.600	25.600	1.5	1.5	2.0	5.200	4.870	0.000	0.250
CERAMIC TILE FNSHER		BLD		23.020	0.000	1.5	1.5	2.0	6.000	5.400	0.000	0.000
ELECTRIC PWR EQMT OP		ALL		30.750	0.000	1.5	1.5	2.0	4.750	8.610	0.000	0.000
ELECTRIC PWR GRNDMAN		ALL		21.090	0.000	1.5	1.5	2.0	4.750	5.905	0.000	0.000
ELECTRIC PWR LINEMAN		ALL		34.160	36.350	1.5	1.5	2.0	4.750	9.560	0.000	0.000
ELECTRIC PWR TRK DRV		ALL		22.130	0.000	1.5	1.5	2.0	4.750	6.200	0.000	0.000
ELECTRICIAN		BLD		25.290	27.290	1.5	1.5	2.0	5.150	6.460	0.000	0.250
ELECTRONIC SYS TECH		BLD		23.850	25.350	1.5	1.5	2.0	5.150	5.625	0.000	0.250
ELEVATOR CONSTRUCTOR		BLD		34.190	38.460	2.0	2.0	2.0	8.275	6.060	2.050	0.000
GLAZIER		BLD		27.130	28.130	1.5	2.0	2.0	5.430	4.000	0.000	0.280
HT/FROST INSULATOR		BLD		30.440	31.440	1.5	1.5	2.0	4.850	8.360	0.000	0.450
IRON WORKER		BLD		25.400	27.150	1.5	1.5	2.0	5.860	7.900	0.000	0.300
IRON WORKER		HWY		25.400	26.900	1.5	1.5	2.0	5.860	7.900	0.000	0.300
LABORER		BLD		20.760	21.760	1.5	1.5	2.0	5.300	6.030	0.000	0.600
LABORER		HWY		21.680	22.430	1.5	1.5	2.0	5.300	6.030	0.000	0.600
LATHER		BLD		24.490	26.490	1.5	1.5	2.0	6.500	7.900	0.000	0.320
MACHINIST		BLD		36.890	38.890	2.0	2.0	2.0	4.380	5.650	2.550	0.000
MARBLE FINISHERS		BLD		23.020	0.000	1.5	1.5	2.0	6.000	5.400	0.000	0.000
MARBLE MASON		BLD		24.520	25.270	1.5	1.5	2.0	6.000	5.400	0.000	0.000
MILLWRIGHT		BLD		26.000	28.000	1.5	1.5	2.0	6.500	6.850	0.000	0.320
MILLWRIGHT		HWY		19.290	20.540	1.5	1.5	2.0	2.800	3.000	0.000	0.000
OPERATING ENGINEER		BLD	1	26.550	0.000	1.5	1.5	2.0	6.150	6.200	0.000	0.850
OPERATING ENGINEER		BLD	2	24.200	0.000	1.5	1.5	2.0	6.150	6.200	0.000	0.850
OPERATING ENGINEER		BLD	3	20.600	0.000	1.5	1.5	2.0	6.150	6.200	0.000	0.850
OPERATING ENGINEER		BLD	4	28.050	0.000	1.5	1.5	2.0	6.150	6.200	0.000	0.850
OPERATING ENGINEER		HWY	1	26.800	0.000	1.5	1.5	2.0	6.150	6.200	0.000	0.850
OPERATING ENGINEER		HWY	2	24.030	0.000	1.5	1.5	2.0	6.150	6.200	0.000	0.850
OPERATING ENGINEER		HWY	3	19.800	0.000	1.5	1.5	2.0	6.150	6.200	0.000	0.850
OPERATING ENGINEER		HWY	4	28.300	0.000	1.5	1.5	2.0	6.150	6.200	0.000	0.850
PAINTER		ALL		26.850	27.850	1.5	1.5	1.5	5.650	5.750	0.000	0.350
PILEDRIVER		BLD		24.990	26.990	1.5	1.5	2.0	6.500	7.900	0.000	0.320
PILEDRIVER		HWY		24.750	26.500	1.5	1.5	2.0	6.500	7.800	0.000	0.300
PIPEFITTER	E	BLD		31.630	35.110	1.5	1.5	2.0	6.450	7.680	0.000	0.420
PIPEFITTER	W	ALL		30.520	33.570	1.5	1.5	2.0	4.800	7.960	0.000	0.530
PLASTERER		BLD		25.000	26.500	1.5	1.5	2.0	4.830	8.050	0.000	0.500
PLUMBER	E	BLD		28.390	30.950	1.5	1.5	2.0	6.450	8.990	0.000	0.800
PLUMBER	W	ALL		30.520	33.570	1.5	1.5	2.0	4.800	7.960	0.000	0.530
ROOFER		BLD		24.200	25.200	1.5	1.5	2.0	5.350	6.550	0.000	0.150
SHEETMETAL WORKER		BLD		27.820	29.570	1.5	1.5	2.0	7.150	7.880	0.000	0.350
SPRINKLER FITTER		BLD		31.240	33.240	1.5	1.5	2.0	6.500	5.350	0.000	0.250
STONE MASON		BLD		24.370	25.370	1.5	1.5	2.0	6.000	5.400	0.000	0.490
TERRAZZO FINISHER		BLD		23.020	0.000	1.5	1.5	2.0	6.000	5.400	0.000	0.000
TERRAZZO MASON		BLD		24.520	25.270	1.5	1.5	2.0	6.000	5.400	0.000	0.000
TILE MASON		BLD		24.520	25.270	1.5	1.5	2.0	6.000	5.400	0.000	0.000
TRUCK DRIVER		ALL	1	25.930	0.000	1.5	1.5	2.0	7.250	3.425	0.000	0.000
TRUCK DRIVER		ALL	2	26.330	0.000	1.5	1.5	2.0	7.250	3.425	0.000	0.000
TRUCK DRIVER		ALL	3	26.530	0.000	1.5	1.5	2.0	7.250	3.425	0.000	0.000
TRUCK DRIVER		ALL	4	26.780	0.000	1.5	1.5	2.0	7.250	3.425	0.000	0.000
TRUCK DRIVER		ALL	5	27.530	0.000	1.5	1.5	2.0	7.250	3.425	0.000	0.000
TRUCK DRIVER		O&C	1	20.740	0.000	1.5	1.5	2.0	7.250	3.425	0.000	0.000
TRUCK DRIVER		O&C	2	21.060	0.000	1.5	1.5	2.0	7.250	3.425	0.000	0.000

TRUCK DRIVER	O&C 3	21.220	0.000	1.5	1.5	2.0	7.250	3.425	0.000	0.000
TRUCK DRIVER	O&C 4	21.420	0.000	1.5	1.5	2.0	7.250	3.425	0.000	0.000
TRUCK DRIVER	O&C 5	22.020	0.000	1.5	1.5	2.0	7.250	3.425	0.000	0.000
TUCKPOINTER	BLD	24.370	25.370	1.5	1.5	2.0	6.000	5.400	0.000	0.490

Legend:

M-F>8 (Overtime is required for any hour greater than 8 worked each day, Monday through Friday.)

OSA (Overtime is required for every hour worked on Saturday)

OSH (Overtime is required for every hour worked on Sunday and Holidays)

H/W (Health & Welfare Insurance)

Pensn (Pension)

Vac (Vacation)

Trng (Training)

## Explanations

### SCHUYLER COUNTY

PLUMBERS & PIPEFITTERS (EAST) - Townships of Frederick, Browning and Hickory (Eastern extension).

The following list is considered as those days for which holiday rates of wages for work performed apply: New Years Day, Memorial/Decoration Day, Fourth of July, Labor Day, Veterans Day, Thanksgiving Day, Christmas Day. Generally, any of these holidays which fall on a Sunday is celebrated on the following Monday. This then makes work performed on that Monday payable at the appropriate overtime rate for holiday pay. Common practice in a given local may alter certain days of celebration such as the day after Thanksgiving for Veterans Day. If in doubt, please check with IDOL.

Oil and chip resealing (O&C) means the application of road oils and liquid asphalt to coat an existing road surface, followed by application of aggregate chips or gravel to coated surface, and subsequent rolling of material to seal the surface.

### EXPLANATION OF CLASSES

ASBESTOS - GENERAL - removal of asbestos material/mold and hazardous materials from any place in a building, including mechanical systems where those mechanical systems are to be removed. This includes the removal of asbestos materials/mold and hazardous materials from ductwork or pipes in a building when the building is to be demolished at the time or at some close future date.

ASBESTOS - MECHANICAL - removal of asbestos material from mechanical systems, such as pipes, ducts, and boilers, where the mechanical systems are to remain.

CERAMIC TILE FINISHER, MARBLE FINISHER, TERRAZZO FINISHER



Assisting, helping or supporting the tile, marble and terrazzo mechanic by performing their historic and traditional work assignments required to complete the proper installation of the work covered by said crafts. The term "Ceramic" is used for naming the classification only and is in no way a limitation of the product handled. Ceramic takes into consideration most hard tiles.

#### ELECTRONIC SYSTEMS TECHNICIAN

Installation, service and maintenance of low-voltage systems which utilizes the transmission and/or transference of voice, sound, vision, or digital for commercial, education, security and entertainment purposes for the following: TV monitoring and surveillance, background/foreground music, intercom and telephone interconnect, field programming, inventory control systems, microwave transmission, multi-media, multiplex, radio page, school, intercom and sound burglar alarms and low voltage master clock systems.

Excluded from this classification are energy management systems, life safety systems, supervisory controls and data acquisition systems not intrinsic with the above listed systems, fire alarm systems, nurse call systems and raceways exceeding fifteen feet in length.

#### TRUCK DRIVER - BUILDING, HEAVY AND HIGHWAY CONSTRUCTION

Class 1. Drivers on 2 axle trucks hauling less than 9 ton. Air compressor and welding machines and brooms, including those pulled by separate units, truck driver helpers, warehouse employees, mechanic helpers, greasers and tiremen, pickup trucks when hauling materials, tools, or workers to and from and on-the-job site, and fork lifts up to 6,000 lb. capacity.

Class 2. Two or three axle trucks hauling more than 9 ton but hauling less than 16 ton. A-frame winch trucks, hydrolift trucks, vector trucks or similar equipment when used for transportation purposes. Fork lifts over 6,000 lb. capacity, winch trucks, four axle combination units, and ticket writers.

Class 3. Two, three or four axle trucks hauling 16 ton or more. Drivers on water pulls, articulated dump trucks, mechanics and working forepersons, and dispatchers. Five axle or more combination units.

Class 4. Low Boy and Oil Distributors.

Class 5. Drivers who require special protective clothing while employed on hazardous waste work.

#### TRUCK DRIVER - OIL AND CHIP RESEALING ONLY.

This shall encompass laborers, workers and mechanics who drive contractor or subcontractor owned, leased, or hired pickup, dump, service, or oil distributor trucks. The work includes transporting materials and equipment (including but not limited to, oils, aggregate supplies, parts, machinery and tools) to or from the job site; distributing oil or liquid asphalt and aggregate; stock piling material when in connection with the actual oil and chip contract. The Truck Driver (Oil & Chip Resealing) wage classification does not include supplier delivered materials.

#### OPERATING ENGINEERS - BUILDING

CLASS 1. Asphalt Screed Man; Aspco Concrete Spreaders; Asphalt Pavers; Asphalt Plant Engineer; Asphalt Rollers on Bituminous Concrete; Athey Loaders; Backfillers, Crane Type; Backhoes; Barber Green Loaders; Bulldozers; Cableways; Cherry Pickers; Clam Shells;

C.M.I. & similar type autograde formless paver, autograde placer & finisher; Concrete Breakers; Concrete Pumps; Derricks; Derrick Boats; Draglines; Earth Auger or Boring Machines; Elevating Graders; Engineers on Dredges; Gravel Processing Machines; Head Equipment Greaser; High Lifts or Fork Lifts; Hoists with two or more drums or two or more load lines; Locomotives, All; Mechanics; Motor Graders or Auto Patrols; Operators or Leverman on Dredges; Operators, Power Boat; Operators, Pug Mill (Asphalt Plants); Orange Peels; Overhead Cranes; Paving Mixers; Piledrivers; Pipe Wrapping and Painting Machines; Pushdozers, or Push Cats; Robotic Controlled Equipment in this Classification; Rock Crushers; Ross Carrier or Similar Machines; Rotomill; Scoops, Skimmer, two cu. yd. capacity and under; Scoops, All or Tournapull; Sheep-Foot Roller (Self Propelled); Shovels; Skid Steer; Skimmer Scoops; Temporary Concrete Plant Operators; Test Hole Drilling Machines; Tower Machines; Tower Mixers; Track Type End Loaders; Track Type Fork Lifts or High Lifts; Track Jacks and Tampers; Tractors, Sideboom; Trenching or Ditching Machine; Tunnelluggers; Vermeer Type Saws; Water Blaster Cutting Head; Wheel Type End Loaders; Winch Cat.

CLASS 2. Air Compressors (six to eight)\*; Asphalt Boosters and Heaters; Asphalt Distributors; Asphalt Plant Fireman; Oiler on Two Paving Mixers When Used in Tandem; Boom or Winch Trucks; Bull Floats or Flexplanes; Concrete Finishing Machine; Concrete Saws, Self-Propelled; Concrete Spreading Machines; Conveyors (six to eight)\*; Generators (six to eight)\*; Gravel or Stone Spreader, Power Operated; Hoist (with One Drum and One Load Line); Light Plants (six to eight)\*; Mechanical Heaters (six to eight)\*; Mud Jacks; Post Hole Digger, Mechanical; Pug Mills when used for other than Asphalt operation; Robotic Controlled Equipment in this Classification; Road or Street Sweeper, Self Propelled; Rollers (except bituminous concrete); Seaman Tiller; Straw Machine; Vibratory Compactor; Water Blaster, Power Unit; Welding Machines (six to eight)\*; Well Drill Machines.

CLASS 3. Air Compressors(one to five)\*; Air Compressors, Track or Self-Propelled; Automatic Hoist; Building Elevators; Bulk Cement Batching Plants; Conveyors (one to five)\*; Concrete Mixers (Except Plant, Paver, or Tower); Firemen; Generators (one to five)\*; Greasers; Helper on Single Paving Mixer; Hoist, Automatic; Light Plants (one to five)\*; Mechanic Helpers; Mechanical Heaters (one to five)\*; Oilers; Power Form Graders; Power Sub-Graders; Robotic Controlled Equipment in this Classification; Scissors Hoist; Tractors without power attachments regardless of size or type; Truck Crane Oiler and Driver (1 man); Vibratory Hammer (powersource); Water Pumps (one to five)\*; Welding Machines (1/300 Amp. or over)\*; Welding machines (one to five)\*

CLASS 4. Lattice Boom Crawler Cranes; Lattice Boom Truck Cranes; Telescopic Truck-Mounted Cranes; Tower Cranes.

\* Combinations of one to eight of any Air Compressors, Conveyors, Welding Machines, Water Pumps, Light Plants, or Generators shall be in batteries or within 400 feet and shall be paid as per the Classification Schedule contained in this Article.

#### OPERATING ENGINEERS - HIGHWAY

CLASS 1. Asphalt Screed Man; Asphco Concrete Spreaders; Asphalt Pavers; Asphalt Plant Engineer; Asphalt Rollers on Bituminous Concrete; Athey Loaders; Backhoes; Barber Green Loaders; Bulldozers; Cableways; Carry Deck Pickers; Cherry Pickers (Rough Terrain); C.M.I.

& similar type-autograde formless paver, autograde placer & finisher; Concrete Breakers; Concrete Plant Operators; Concrete Pumps; Derricks; Derrick Boats; Dewatering Systems; Earth Auger or Boring Machines; Elevating Graders; Engineers on Dredges; Gravel Processing Machines; Grout Pump; Head Equipment Greaser; High Lifts or Fork Lifts; Hoists with two or more drums or two or more load lines; Hydro Jet or Hydro Laser; Locomotives, All; Mechanics; Motor Graders or Auto Patrols; Multi-Point Power Lifting Equipment; Operators or Leverman on Dredges; Operators, Power Boat; Operators, Pug Mill (Asphalt Plants); Overhead Cranes; Paving Mixers; Piledrivers; Pipe Wrapping and Painting Machines; Push-dozers, or Push Cats; Robotic Controlled Equipment in this Classification; Rock Crushers; Ross Carrier or Similar Machines; Roto-Mill; Scoops, Skimmer, two cu. yd. capacity and under; Sheep-Foot Roller (Self Pro-pelled); Shovels; Skid Steer; Skimmer Scoops; Test Hole Drilling Machines; Tower Machines; Tower Mixers; Track Type End Loaders; Track Type Fork Lifts or High Lifts; Track Jacks and Tampers; Tractors, Side-boom; Trenching or Ditching Machine; Tunnelluggers; Vermeer-Type Saws; Wheel Type End Loaders; Winch Cat; Scoops, All or Tournapull.

CLASS 2. Air Compressors (six to eight)\*; Articulated Dumps; Asphalt Boosters and Heaters; Asphalt Distributors; Asphalt Plant Fireman; Boom or Winch Trucks; Building Elevators; Bull Floats or Flexplanes; Concrete Finishing Machine; Concrete Saws, Self-Propelled; Concrete Spreading Machines; Conveyors (six to eight)\*; Generators (six to eight)\*; Gravel or Stone Spreader, Power Operated; Hoist, Automatic; Hoist with One Drum and One Load Line; Light Plants (six to eight)\*; Mechanical Heaters (six to eight)\*; Mud Jacks; Off Road Water Wagons; Oiler on Two Paving Mixers When Used in Tandem; Post Hole Digger, Mechanical; Robotic Controlled Equipment in This Classification; Road or Street Sweeper, Self-Propelled; Rollers (except bituminous concrete); Scissor Hoist; Sea-man Tiller; Straw Machine; Vibratory Compactor; Water Pumps (six to eight)\*; Well Drill Machines.

CLASS 3. Air Compressors (one to five)\*; Air Compressors, Track or Self-Propelled; Bulk Cement Batching Plants; Conveyors (one to five)\*; Concrete Mixers (Except Plant, Paver, or Tower); Firemen; Generators (one to five)\*; Greasers; Helper on Single Paving Mixer; Light Plants (one to five)\*; Mechanic Helpers; Mechanical Heaters (one to five)\*; Oilers; Power Form Graders; Power Sub-Graders; Pug Mills when used for other than Asphalt operation; Robotic Controlled Equipment in This Classification; Tractors without power attachments, regardless of size or type; Truck Crane Oiler and Driver (1 man); Vibratory Hammer (power source); Water Pumps (one to five)\*; Welding Machines (one 300 Amp. or over)\*; Welding Machines (one to five)\*.

CLASS 4. Lattice Boom Crawler Crane; Lattice Boom Truck Crane; Telescopic Truck-Mounted Crane; Tower Crane.

\*Combinations of one to eight of any Air Compressors, Conveyors, Welding Machines, Water Pumps, Light Plants or Generators shall be in batteries or within 400 feet and shall be paid as per the Classification Schedule contained in this Article.

Other Classifications of Work:

For definitions of classifications not otherwise set out, the Department generally has on file such definitions which are available. If a task to be performed is not subject to one of the classifications of pay set out, the Department will upon being contacted state which neighboring county has such a classification and provide such rate, such rate being deemed to exist by reference in

this document. If no neighboring county rate applies to the task, the Department shall undertake a special determination, such special determination being then deemed to have existed under this determination. If a project requires these, or any classification not listed, please contact IDOL at 618/993-7271 for wage rates or clarifications.

#### LANDSCAPING

Landscaping work falls under the existing classifications for laborer, operating engineer and truck driver. The work performed by landscape plantsman and landscape laborer is covered by the existing classification of laborer. The work performed by landscape operators (regardless of equipment used or its size) is covered by the classifications of operating engineer. The work performed by landscape truck drivers (regardless of size of truck driven) is covered by the classifications of truck driver.

# Scott County Prevailing Wage for April 2007

Trade Name	RG	TYP	C	Base	FRMAN	*M-F>8	OSA	OSH	H/W	Pensn	Vac	Trng
=====	==	==	=	=====	=====	=====	==	==	=====	=====	=====	=====
ASBESTOS ABT-GEN		BLD		23.210	24.210	1.5	1.5	2.0	5.050	5.330	0.000	0.700
ASBESTOS ABT-MEC		BLD		25.290	26.290	1.5	1.5	2.0	4.450	2.500	0.000	0.250
BOILERMAKER		BLD		28.500	31.000	1.5	1.5	2.0	6.820	11.03	0.000	0.300
BRICK MASON		BLD		24.370	25.370	1.5	1.5	2.0	6.000	5.400	0.000	0.490
CARPENTER		BLD		24.490	26.490	1.5	1.5	2.0	6.500	7.900	0.000	0.320
CARPENTER		HWY		24.250	26.000	1.5	1.5	2.0	6.500	7.800	0.000	0.300
CEMENT MASON		BLD		24.470	25.570	2.0	2.0	2.0	6.000	5.400	0.000	0.490
CEMENT MASON		HWY		24.020	25.020	1.5	1.5	2.0	6.000	4.900	0.000	0.000
CERAMIC TILE FNSHER		BLD		23.020	0.000	1.5	1.5	2.0	6.000	5.400	0.000	0.000
ELECTRIC PWR EQMT OP		ALL		30.750	0.000	1.5	1.5	2.0	4.750	8.610	0.000	0.000
ELECTRIC PWR GRNDMAN		ALL		21.090	0.000	1.5	1.5	2.0	4.750	5.905	0.000	0.000
ELECTRIC PWR LINEMAN		ALL		34.160	36.350	1.5	1.5	2.0	4.750	9.560	0.000	0.000
ELECTRIC PWR TRK DRV		ALL		22.130	0.000	1.5	1.5	2.0	4.750	6.200	0.000	0.000
ELECTRICIAN		BLD		31.220	33.220	1.5	1.5	2.0	5.150	5.340	0.000	0.300
ELECTRONIC SYS TECH		BLD		24.830	26.330	1.5	1.5	2.0	5.150	3.190	0.000	0.250
ELEVATOR CONSTRUCTOR		BLD		34.190	38.460	2.0	2.0	2.0	8.275	6.060	2.050	0.000
GLAZIER		BLD		27.130	28.130	1.5	2.0	2.0	5.430	4.000	0.000	0.280
HT/FROST INSULATOR		BLD		30.440	31.440	1.5	1.5	2.0	4.850	8.360	0.000	0.450
IRON WORKER		BLD		25.400	27.150	1.5	1.5	2.0	5.860	7.900	0.000	0.300
IRON WORKER		HWY		25.400	26.900	1.5	1.5	2.0	5.860	7.900	0.000	0.300
LABORER		BLD		21.710	22.710	1.5	1.5	2.0	5.050	5.330	0.000	0.600
LABORER		HWY		22.680	23.430	1.5	1.5	2.0	5.050	5.330	0.000	0.600
LATHER		BLD		24.490	26.490	1.5	1.5	2.0	6.500	7.900	0.000	0.320
MACHINIST		BLD		36.890	38.890	2.0	2.0	2.0	4.380	5.650	2.550	0.000
MARBLE FINISHERS		BLD		23.020	0.000	1.5	1.5	2.0	6.000	5.400	0.000	0.000
MARBLE MASON		BLD		24.520	25.270	1.5	1.5	2.0	6.000	5.400	0.000	0.000
MILLWRIGHT		BLD		26.000	28.000	1.5	1.5	2.0	6.500	6.850	0.000	0.320
MILLWRIGHT		HWY		19.070	20.320	1.5	1.5	2.0	2.800	3.000	0.000	0.000
OPERATING ENGINEER		BLD	1	26.550	0.000	1.5	1.5	2.0	6.150	6.200	0.000	0.850
OPERATING ENGINEER		BLD	2	24.200	0.000	1.5	1.5	2.0	6.150	6.200	0.000	0.850
OPERATING ENGINEER		BLD	3	20.600	0.000	1.5	1.5	2.0	6.150	6.200	0.000	0.850
OPERATING ENGINEER		BLD	4	28.050	0.000	1.5	1.5	2.0	6.150	6.200	0.000	0.850
OPERATING ENGINEER		HWY	1	26.800	0.000	1.5	1.5	2.0	6.150	6.200	0.000	0.850
OPERATING ENGINEER		HWY	2	24.030	0.000	1.5	1.5	2.0	6.150	6.200	0.000	0.850
OPERATING ENGINEER		HWY	3	19.800	0.000	1.5	1.5	2.0	6.150	6.200	0.000	0.850
OPERATING ENGINEER		HWY	4	28.300	0.000	1.5	1.5	2.0	6.150	6.200	0.000	0.850
PAINTER		ALL		25.390	26.390	1.5	1.5	2.0	4.650	5.500	0.000	0.250
PAINTER OVER 30FT		ALL		26.390	27.390	1.5	1.5	2.0	4.650	5.500	0.000	0.250
PAINTER PWR EQMT		ALL		26.390	27.390	1.5	1.5	2.0	4.650	5.500	0.000	0.250
PILEDRIVER		BLD		24.990	26.990	1.5	1.5	2.0	6.500	7.900	0.000	0.320
PILEDRIVER		HWY		24.750	26.500	1.5	1.5	2.0	6.500	7.800	0.000	0.300
PIPEFITTER		BLD		34.700	37.200	1.5	1.5	2.0	6.450	4.750	0.000	0.350
PLASTERER		BLD		24.470	25.570	2.0	2.0	2.0	6.000	5.400	0.000	0.490
PLUMBER		BLD		34.700	37.200	1.5	1.5	2.0	6.450	4.750	0.000	0.350
ROOFER		BLD		24.310	26.740	1.5	1.5	2.0	4.650	5.250	0.000	0.100
SHEETMETAL WORKER		BLD		27.820	29.570	1.5	1.5	2.0	7.150	7.880	0.000	0.350
SPRINKLER FITTER		BLD		31.240	33.240	1.5	1.5	2.0	6.500	5.350	0.000	0.250
STONE MASON		BLD		24.370	25.370	1.5	1.5	2.0	6.000	5.400	0.000	0.490
TERRAZZO FINISHER		BLD		23.020	0.000	1.5	1.5	2.0	6.000	5.400	0.000	0.000
TERRAZZO MASON		BLD		24.520	25.270	1.5	1.5	2.0	6.000	5.400	0.000	0.000
TILE MASON		BLD		24.520	25.270	1.5	1.5	2.0	6.000	5.400	0.000	0.000
TRUCK DRIVER		ALL	1	25.930	0.000	1.5	1.5	2.0	7.250	3.425	0.000	0.000
TRUCK DRIVER		ALL	2	26.330	0.000	1.5	1.5	2.0	7.250	3.425	0.000	0.000
TRUCK DRIVER		ALL	3	26.530	0.000	1.5	1.5	2.0	7.250	3.425	0.000	0.000
TRUCK DRIVER		ALL	4	26.780	0.000	1.5	1.5	2.0	7.250	3.425	0.000	0.000
TRUCK DRIVER		ALL	5	27.530	0.000	1.5	1.5	2.0	7.250	3.425	0.000	0.000
TRUCK DRIVER		O&C	1	20.740	0.000	1.5	1.5	2.0	7.250	3.425	0.000	0.000
TRUCK DRIVER		O&C	2	21.060	0.000	1.5	1.5	2.0	7.250	3.425	0.000	0.000

TRUCK DRIVER	O&C 3	21.220	0.000	1.5	1.5	2.0	7.250	3.425	0.000	0.000
TRUCK DRIVER	O&C 4	21.420	0.000	1.5	1.5	2.0	7.250	3.425	0.000	0.000
TRUCK DRIVER	O&C 5	22.020	0.000	1.5	1.5	2.0	7.250	3.425	0.000	0.000
TUCKPOINTER	BLD	24.370	25.370	1.5	1.5	2.0	6.000	5.400	0.000	0.490

Legend:

M-F>8 (Overtime is required for any hour greater than 8 worked each day, Monday through Friday.)

OSA (Overtime is required for every hour worked on Saturday)

OSH (Overtime is required for every hour worked on Sunday and Holidays)

H/W (Health & Welfare Insurance)

Pensn (Pension)

Vac (Vacation)

Trng (Training)

## Explanations

### SCOTT COUNTY

The following list is considered as those days for which holiday rates of wages for work performed apply: New Years Day, Memorial/Decoration Day, Fourth of July, Labor Day, Veterans Day, Thanksgiving Day, Christmas Day. Generally, any of these holidays which fall on a Sunday is celebrated on the following Monday. This then makes work performed on that Monday payable at the appropriate overtime rate for holiday pay. Common practice in a given local may alter certain days of celebration such as the day after Thanksgiving for Veterans Day. If in doubt, please check with IDOL.

Oil and chip resealing (O&C) means the application of road oils and liquid asphalt to coat an existing road surface, followed by application of aggregate chips or gravel to coated surface, and subsequent rolling of material to seal the surface.

### EXPLANATION OF CLASSES

ASBESTOS - GENERAL - removal of asbestos material/mold and hazardous materials from any place in a building, including mechanical systems where those mechanical systems are to be removed. This includes the removal of asbestos materials/mold and hazardous materials from ductwork or pipes in a building when the building is to be demolished at the time or at some close future date.

ASBESTOS - MECHANICAL - removal of asbestos material from mechanical systems, such as pipes, ducts, and boilers, where the mechanical systems are to remain.

### CERAMIC TILE FINISHER, MARBLE FINISHER, TERRAZZO FINISHER

Assisting, helping or supporting the tile, marble and terrazzo mechanic by performing their historic and traditional work assignments required to complete the proper installation of the work covered by said crafts. The term "Ceramic" is used for naming the classification

only and is in no way a limitation of the product handled. Ceramic takes into consideration most hard tiles.

#### ELECTRONIC SYSTEMS TECHNICIAN

Installation, service and maintenance of low-voltage systems which utilizes the transmission and/or transference of voice, sound, vision, or digital for commercial, education, security and entertainment purposes for the following: TV monitoring and surveillance, background/foreground music, intercom and telephone interconnect, field programming, inventory control systems, microwave transmission, multi-media, multiplex, radio page, school, intercom and sound burglar alarms and low voltage master clock systems.

Excluded from this classification are energy management systems, life safety systems, supervisory controls and data acquisition systems not intrinsic with the above listed systems, fire alarm systems, nurse call systems and raceways exceeding fifteen feet in length.

#### TRUCK DRIVER - BUILDING, HEAVY AND HIGHWAY CONSTRUCTION

Class 1. Drivers on 2 axle trucks hauling less than 9 ton. Air compressor and welding machines and brooms, including those pulled by separate units, truck driver helpers, warehouse employees, mechanic helpers, greasers and tiremen, pickup trucks when hauling materials, tools, or workers to and from and on-the-job site, and fork lifts up to 6,000 lb. capacity.

Class 2. Two or three axle trucks hauling more than 9 ton but hauling less than 16 ton. A-frame winch trucks, hydrolift trucks, vector trucks or similar equipment when used for transportation purposes. Fork lifts over 6,000 lb. capacity, winch trucks, four axle combination units, and ticket writers.

Class 3. Two, three or four axle trucks hauling 16 ton or more. Drivers on water pulls, articulated dump trucks, mechanics and working forepersons, and dispatchers. Five axle or more combination units.

Class 4. Low Boy and Oil Distributors.

Class 5. Drivers who require special protective clothing while employed on hazardous waste work.

#### TRUCK DRIVER - OIL AND CHIP RESEALING ONLY.

This shall encompass laborers, workers and mechanics who drive contractor or subcontractor owned, leased, or hired pickup, dump, service, or oil distributor trucks. The work includes transporting materials and equipment (including but not limited to, oils, aggregate supplies, parts, machinery and tools) to or from the job site; distributing oil or liquid asphalt and aggregate; stock piling material when in connection with the actual oil and chip contract. The Truck Driver (Oil & Chip Resealing) wage classification does not include supplier delivered materials.

#### OPERATING ENGINEERS - BUILDING

CLASS 1. Asphalt Screed Man; Aspco Concrete Spreaders; Asphalt Pavers; Asphalt Plant Engineer; Asphalt Rollers on Bituminous Concrete; Athey Loaders; Backfillers, Crane Type; Backhoes; Barber Green Loaders; Bulldozers; Cableways; Cherry Pickers; Clam Shells; C.M.I. & similar type autograde formless paver, autograde placer & finisher; Concrete Breakers; Concrete Pumps; Derricks; Derrick Boats; Draglines; Earth Auger or Boring Machines; Elevating Graders; Engineers on Dredges; Gravel Processing Machines; Head Equipment

Greaser; High Lifts or Fork Lifts; Hoists with two or more drums or two or more load lines; Locomotives, All; Mechanics; Motor Graders or Auto Patrols; Operators or Leverman on Dredges; Operators, Power Boat; Operators, Pug Mill (Asphalt Plants); Orange Peels; Overhead Cranes; Paving Mixers; Piledrivers; Pipe Wrapping and Painting Machines; Pushdozers, or Push Cats; Robotic Controlled Equipment in this Classification; Rock Crushers; Ross Carrier or Similar Machines; Rotomill; Scoops, Skimmer, two cu. yd. capacity and under; Scoops, All or Tournapull; Sheep-Foot Roller (Self Propelled); Shovels; Skid Steer; Skimmer Scoops; Temporary Concrete Plant Operators; Test Hole Drilling Machines; Tower Machines; Tower Mixers; Track Type End Loaders; Track Type Fork Lifts or High Lifts; Track Jacks and Tampers; Tractors, Sideboom; Trenching or Ditching Machine; Tunnelluggers; Vermeer Type Saws; Water Blaster Cutting Head; Wheel Type End Loaders; Winch Cat.

CLASS 2. Air Compressors (six to eight)\*; Asphalt Boosters and Heaters; Asphalt Distributors; Asphalt Plant Fireman; Oiler on Two Paving Mixers When Used in Tandem; Boom or Winch Trucks; Bull Floats or Flexplanes; Concrete Finishing Machine; Concrete Saws, Self-Propelled; Concrete Spreading Machines; Conveyors (six to eight)\*; Generators (six to eight)\*; Gravel or Stone Spreader, Power Operated; Hoist (with One Drum and One Load Line); Light Plants (six to eight)\*; Mechanical Heaters (six to eight)\*; Mud Jacks; Post Hole Digger, Mechanical; Pug Mills when used for other than Asphalt operation; Robotic Controlled Equipment in this Classification; Road or Street Sweeper, Self Propelled; Rollers (except bituminous concrete); Seaman Tiller; Straw Machine; Vibratory Compactor; Water Blaster, Power Unit; Welding Machines (six to eight)\*; Well Drill Machines.

CLASS 3. Air Compressors(one to five)\*; Air Compressors, Track or Self-Propelled; Automatic Hoist; Building Elevators; Bulk Cement Batching Plants; Conveyors (one to five)\*; Concrete Mixers (Except Plant, Paver, or Tower); Firemen; Generators (one to five)\*; Greasers; Helper on Single Paving Mixer; Hoist, Automatic; Light Plants (one to five)\*; Mechanic Helpers; Mechanical Heaters (one to five)\*; Oilers; Power Form Graders; Power Sub-Graders; Robotic Controlled Equipment in this Classification; Scissors Hoist; Tractors without power attachments regardless of size or type; Truck Crane Oiler and Driver (1 man); Vibratory Hammer (power source); Water Pumps (one to five)\*; Welding Machines (1/300 Amp. or over)\*; Welding machines (one to five)\*

CLASS 4. Lattice Boom Crawler Cranes; Lattice Boom Truck Cranes; Telescopic Truck-Mounted Cranes; Tower Cranes.

\* Combinations of one to eight of any Air Compressors, Conveyors, Welding Machines, Water Pumps, Light Plants, or Generators shall be in batteries or within 400 feet and shall be paid as per the Classification Schedule contained in this Article.

#### OPERATING ENGINEERS - HIGHWAY

CLASS 1. Asphalt Screed Man; Asphco Concrete Spreaders; Asphalt Pavers; Asphalt Plant Engineer; Asphalt Rollers on Bituminous Concrete; Athey Loaders; Backhoes; Barber Green Loaders; Bulldozers; Cableways; Carry Deck Pickers; Cherry Pickers (Rough Terrain); C.M.I. & similar type-autograde formless paver, autograde placer & finisher; Concrete Breakers; Concrete Plant Operators; Concrete Pumps; Derricks; Derrick Boats; Dewatering Systems; Earth Auger or Boring Machines; Elevating Graders; Engineers on Dredges; Gravel Processing Machines;



Grout Pump; Head Equipment Greaser; High Lifts or Fork Lifts; Hoists with two or more drums or two or more load lines; Hydro Jet or Hydro Laser; Locomotives, All; Mechanics; Motor Graders or Auto Patrols; Multi-Point Power Lifting Equipment; Operators or Leverman on Dredges; Operators, Power Boat; Operators, Pug Mill (Asphalt Plants); Overhead Cranes; Paving Mixers; Piledrivers; Pipe Wrapping and Painting Machines; Push-dozers, or Push Cats; Robotic Controlled Equipment in this Classification; Rock Crushers; Ross Carrier or Similar Machines; Roto-Mill; Scoops, Skimmer, two cu. yd. capacity and under; Sheep-Foot Roller (Self Pro-pelled); Shovels; Skid Steer; Skimmer Scoops; Test Hole Drilling Machines; Tower Machines; Tower Mixers; Track Type End Loaders; Track Type Fork Lifts or High Lifts; Track Jacks and Tampers; Tractors, Side-boom; Trenching or Ditching Machine; Tunnelluggers; Vermeer-Type Saws; Wheel Type End Loaders; Winch Cat; Scoops, All or Tournapull.

CLASS 2. Air Compressors (six to eight)\*; Articulated Dumps; Asphalt Boosters and Heaters; Asphalt Distributors; Asphalt Plant Fireman; Boom or Winch Trucks; Building Elevators; Bull Floats or Flexplanes; Concrete Finishing Machine; Concrete Saws, Self-Propelled; Concrete Spreading Machines; Conveyors (six to eight)\*; Generators (six to eight)\*; Gravel or Stone Spreader, Power Operated; Hoist, Automatic; Hoist with One Drum and One Load Line; Light Plants (six to eight)\*; Mechanical Heaters (six to eight)\*; Mud Jacks; Off Road Water Wagons; Oiler on Two Paving Mixers When Used in Tandem; Post Hole Digger, Mechanical; Robotic Controlled Equipment in This Classification; Road or Street Sweeper, Self-Propelled; Rollers (except bituminous concrete); Scissor Hoist; Sea-man Tiller; Straw Machine; Vibratory Compactor; Water Pumps (six to eight)\*; Well Drill Machines.

CLASS 3. Air Compressors (one to five)\*; Air Compressors, Track or Self-Propelled; Bulk Cement Batching Plants; Conveyors (one to five)\*; Concrete Mixers (Except Plant, Paver, or Tower); Firemen; Generators (one to five)\*; Greasers; Helper on Single Paving Mixer; Light Plants (one to five)\*; Mechanic Helpers; Mechanical Heaters (one to five)\*; Oilers; Power Form Graders; Power Sub-Graders; Pug Mills when used for other than Asphalt operation; Robotic Controlled Equipment in This Classification; Tractors without power attachments, regardless of size or type; Truck Crane Oiler and Driver (1 man); Vibratory Hammer (power source); Water Pumps (one to five)\*; Welding Machines (one 300 Amp. or over)\*; Welding Machines (one to five)\*.

CLASS 4. Lattice Boom Crawler Crane; Lattice Boom Truck Crane; Telescopic Truck-Mounted Crane; Tower Crane.

\*Combinations of one to eight of any Air Compressors, Conveyors, Welding Machines, Water Pumps, Light Plants or Generators shall be in batteries or within 400 feet and shall be paid as per the Classification Schedule contained in this Article.

Other Classifications of Work:

For definitions of classifications not otherwise set out, the Department generally has on file such definitions which are available. If a task to be performed is not subject to one of the classifications of pay set out, the Department will upon being contacted state which neighboring county has such a classification and provide such rate, such rate being deemed to exist by reference in this document. If no neighboring county rate applies to the task, the Department shall undertake a special determination, such special determination being then deemed to have existed under this determination. If a project requires these, or any classification not

listed, please contact IDOL at 618/993-7271 for wage rates or clarifications.

#### LANDSCAPING

Landscaping work falls under the existing classifications for laborer, operating engineer and truck driver. The work performed by landscape plantsman and landscape laborer is covered by the existing classification of laborer. The work performed by landscape operators (regardless of equipment used or its size) is covered by the classifications of operating engineer. The work performed by landscape truck drivers (regardless of size of truck driven) is covered by the classifications of truck driver.

# Shelby County Prevailing Wage for April 2007

Trade Name	RG	TYP	C	Base	FRMAN	*M-F>8	OSA	OSH	H/W	Pensn	Vac	Trng
=====	==	==	=	=====	=====	=====	==	==	=====	=====	=====	=====
ASBESTOS ABT-GEN		BLD		24.420	25.420	1.5	1.5	2.0	5.050	5.330	0.000	0.700
ASBESTOS ABT-MEC		BLD		25.290	26.290	1.5	1.5	2.0	4.450	2.500	0.000	0.250
BOILERMAKER		BLD		28.500	31.000	1.5	1.5	2.0	6.820	11.03	0.000	0.300
BRICK MASON		BLD		24.950	26.450	1.5	1.5	2.0	6.000	6.400	0.000	0.490
CARPENTER		BLD		25.590	27.590	1.5	1.5	2.0	6.500	6.800	0.000	0.320
CARPENTER		HWY		25.040	26.790	1.5	1.5	2.0	6.500	7.300	0.000	0.300
CEMENT MASON		BLD		25.830	27.080	1.5	1.5	2.0	5.200	7.000	0.000	0.300
CEMENT MASON		HWY		24.170	25.170	1.5	1.5	2.0	5.200	7.000	0.000	0.300
CERAMIC TILE FNSHER		BLD		23.600	0.000	1.5	1.5	2.0	6.000	6.400	0.000	0.000
ELECTRIC PWR EQMT OP		ALL		30.750	0.000	1.5	1.5	2.0	4.750	8.610	0.000	0.000
ELECTRIC PWR GRNDMAN		ALL		21.090	0.000	1.5	1.5	2.0	4.750	5.905	0.000	0.000
ELECTRIC PWR LINEMAN		ALL		34.160	36.350	1.5	1.5	2.0	4.750	9.560	0.000	0.000
ELECTRIC PWR TRK DRV		ALL		22.130	0.000	1.5	1.5	2.0	4.750	6.200	0.000	0.000
ELECTRICIAN		BLD		29.480	32.420	1.5	1.5	2.0	5.150	5.300	0.000	0.440
ELECTRONIC SYS TECH		BLD		24.370	25.870	1.5	1.5	2.0	5.150	3.650	0.000	0.250
ELEVATOR CONSTRUCTOR		BLD		34.190	38.460	2.0	2.0	2.0	8.275	6.060	2.050	0.000
GLAZIER		BLD		27.130	28.130	1.5	2.0	2.0	5.430	4.000	0.000	0.280
HT/FROST INSULATOR		BLD		30.440	31.440	1.5	1.5	2.0	4.850	8.360	0.000	0.450
IRON WORKER		BLD		25.400	27.150	1.5	1.5	2.0	5.860	7.900	0.000	0.300
IRON WORKER		HWY		25.400	26.900	1.5	1.5	2.0	5.860	7.900	0.000	0.300
LABORER		BLD		22.920	23.920	1.5	1.5	2.0	5.050	5.330	0.000	0.600
LABORER		HWY		24.220	24.970	1.5	1.5	2.0	5.050	5.330	0.000	0.600
LATHER		BLD		25.590	27.590	1.5	1.5	2.0	6.500	6.800	0.000	0.320
MACHINIST		BLD		36.890	38.890	2.0	2.0	2.0	4.380	5.650	2.550	0.000
MARBLE FINISHERS		BLD		23.600	0.000	1.5	1.5	2.0	6.000	6.400	0.000	0.000
MARBLE MASON		BLD		25.100	26.350	1.5	1.5	2.0	6.000	6.400	0.000	0.000
MILLWRIGHT		BLD		26.000	28.000	1.5	1.5	2.0	6.500	6.850	0.000	0.320
MILLWRIGHT		HWY		19.410	20.660	1.5	1.5	2.0	2.800	3.000	0.000	0.000
OPERATING ENGINEER		BLD	1	26.550	0.000	1.5	1.5	2.0	6.150	6.200	0.000	0.850
OPERATING ENGINEER		BLD	2	24.200	0.000	1.5	1.5	2.0	6.150	6.200	0.000	0.850
OPERATING ENGINEER		BLD	3	20.600	0.000	1.5	1.5	2.0	6.150	6.200	0.000	0.850
OPERATING ENGINEER		BLD	4	28.050	0.000	1.5	1.5	2.0	6.150	6.200	0.000	0.850
OPERATING ENGINEER		HWY	1	26.800	0.000	1.5	1.5	2.0	6.150	6.200	0.000	0.850
OPERATING ENGINEER		HWY	2	24.030	0.000	1.5	1.5	2.0	6.150	6.200	0.000	0.850
OPERATING ENGINEER		HWY	3	19.800	0.000	1.5	1.5	2.0	6.150	6.200	0.000	0.850
OPERATING ENGINEER		HWY	4	28.300	0.000	1.5	1.5	2.0	6.150	6.200	0.000	0.850
PAINTER		ALL		24.380	25.380	1.5	1.5	2.0	5.050	5.950	0.000	0.400
PAINTER OVER 30FT		ALL		25.380	26.380	1.5	1.5	2.0	5.050	5.950	0.000	0.400
PAINTER PWR EQMT		ALL		25.130	26.130	1.5	1.5	2.0	5.050	5.950	0.000	0.400
PILEDRIVER		BLD		26.090	28.090	1.5	1.5	2.0	6.500	6.800	0.000	0.320
PILEDRIVER		HWY		25.540	27.290	1.5	1.5	2.0	6.500	7.300	0.000	0.300
PIPEFITTER		BLD		32.480	34.980	1.5	1.5	2.0	6.450	4.800	0.000	0.670
PLASTERER		BLD		23.940	25.440	1.5	1.5	2.0	5.200	8.200	0.000	0.300
PLUMBER		BLD		32.480	34.980	1.5	1.5	2.0	6.450	4.800	0.000	0.670
ROOFER		BLD		22.350	24.850	1.5	1.5	2.0	6.000	5.550	0.000	0.550
SHEETMETAL WORKER		BLD		28.600	30.600	1.5	1.5	2.0	7.150	7.330	0.000	0.520
SPRINKLER FITTER		BLD		31.240	33.240	1.5	1.5	2.0	6.500	5.350	0.000	0.250
STONE MASON		BLD		24.950	26.450	1.5	1.5	2.0	6.000	6.400	0.000	0.490
TERRAZZO FINISHER		BLD		23.600	0.000	1.5	1.5	2.0	6.000	6.400	0.000	0.000
TERRAZZO MASON		BLD		25.100	26.350	1.5	1.5	2.0	6.000	6.400	0.000	0.000
TILE LAYER		BLD		25.590	27.590	1.5	1.5	2.0	6.500	6.800	0.000	0.320
TILE MASON		BLD		25.100	26.350	1.5	1.5	2.0	6.000	6.400	0.000	0.000
TRUCK DRIVER	E	ALL	1	25.787	0.000	1.5	1.5	2.0	7.250	3.317	0.000	0.000
TRUCK DRIVER	E	ALL	2	26.187	0.000	1.5	1.5	2.0	7.250	3.317	0.000	0.000
TRUCK DRIVER	E	ALL	3	26.387	0.000	1.5	1.5	2.0	7.250	3.317	0.000	0.000
TRUCK DRIVER	E	ALL	4	26.637	0.000	1.5	1.5	2.0	7.250	3.317	0.000	0.000
TRUCK DRIVER	E	ALL	5	27.387	0.000	1.5	1.5	2.0	7.250	3.317	0.000	0.000
TRUCK DRIVER	E	O&C	1	20.630	0.000	1.5	1.5	2.0	7.250	3.317	0.000	0.000

TRUCK DRIVER	E	O&C	2	20.950	0.000	1.5	1.5	2.0	7.250	3.317	0.000	0.000
TRUCK DRIVER	E	O&C	3	21.110	0.000	1.5	1.5	2.0	7.250	3.317	0.000	0.000
TRUCK DRIVER	E	O&C	4	21.310	0.000	1.5	1.5	2.0	7.250	3.317	0.000	0.000
TRUCK DRIVER	E	O&C	5	21.910	0.000	1.5	1.5	2.0	7.250	3.317	0.000	0.000
TRUCK DRIVER	W	ALL	1	25.930	0.000	1.5	1.5	2.0	7.250	3.425	0.000	0.000
TRUCK DRIVER	W	ALL	2	26.330	0.000	1.5	1.5	2.0	7.250	3.425	0.000	0.000
TRUCK DRIVER	W	ALL	3	26.530	0.000	1.5	1.5	2.0	7.250	3.425	0.000	0.000
TRUCK DRIVER	W	ALL	4	26.780	0.000	1.5	1.5	2.0	7.250	3.425	0.000	0.000
TRUCK DRIVER	W	ALL	5	27.530	0.000	1.5	1.5	2.0	7.250	3.425	0.000	0.000
TRUCK DRIVER	W	O&C	1	20.740	0.000	1.5	1.5	2.0	7.250	3.425	0.000	0.000
TRUCK DRIVER	W	O&C	2	21.060	0.000	1.5	1.5	2.0	7.250	3.425	0.000	0.000
TRUCK DRIVER	W	O&C	3	21.220	0.000	1.5	1.5	2.0	7.250	3.425	0.000	0.000
TRUCK DRIVER	W	O&C	4	21.420	0.000	1.5	1.5	2.0	7.250	3.425	0.000	0.000
TRUCK DRIVER	W	O&C	5	22.020	0.000	1.5	1.5	2.0	7.250	3.425	0.000	0.000
TUCKPOINTER		BLD		24.950	26.450	1.5	1.5	2.0	6.000	6.400	0.000	0.490

Legend :

M-F>8 (Overtime is required for any hour greater than 8 worked each day, Monday through Friday.)

OSA (Overtime is required for every hour worked on Saturday)

OSH (Overtime is required for every hour worked on Sunday and Holidays)

H/W (Health & Welfare Insurance)

Pensn (Pension)

Vac (Vacation)

Trng (Training)

## Explanations

### SHELBY COUNTY

TRUCK DRIVERS (EAST) - East of a line starting where such line from the northeast corner of Moultrie County in a southwesterly direction to Findlay intersects the Moultrie-Shelby Counties line, to Findlay, continuing in a southerly direction to a point approximately 2-1/2 miles south of Middlesworth, continuing to a point on the Shelby-Cumberland Counties line approximately one mile south of the Trowbridge Neoga Road.

The following list is considered as those days for which holiday rates of wages for work performed apply: New Years Day, Memorial/Decoration Day, Fourth of July, Labor Day, Veterans Day, Thanksgiving Day, Christmas Day. Generally, any of these holidays which fall on a Sunday is celebrated on the following Monday. This then makes work performed on that Monday payable at the appropriate overtime rate for holiday pay. Common practice in a given local may alter certain days of celebration such as the day after Thanksgiving for Veterans Day. If in doubt, please check with IDOL.

Oil and chip resealing (O&C) means the application of road oils and liquid asphalt to coat an existing road surface, followed by application of aggregate chips or gravel to coated surface, and subsequent rolling of material to seal the surface.

## EXPLANATION OF CLASSES

ASBESTOS - GENERAL - removal of asbestos material/mold and hazardous materials from any place in a building, including mechanical systems where those mechanical systems are to be removed. This includes the removal of asbestos materials/mold and hazardous materials from ductwork or pipes in a building when the building is to be demolished at the time or at some close future date.

ASBESTOS - MECHANICAL - removal of asbestos material from mechanical systems, such as pipes, ducts, and boilers, where the mechanical systems are to remain.

### CERAMIC TILE FINISHER, MARBLE FINISHER, TERRAZZO FINISHER

Assisting, helping or supporting the tile, marble and terrazzo mechanic by performing their historic and traditional work assignments required to complete the proper installation of the work covered by said crafts. The term "Ceramic" is used for naming the classification only and is in no way a limitation of the product handled. Ceramic takes into consideration most hard tiles.

### ELECTRONIC SYSTEMS TECHNICIAN

Installation, service and maintenance of low-voltage systems which utilizes the transmission and/or transference of voice, sound, vision, or digital for commercial, education, security and entertainment purposes for the following: TV monitoring and surveillance, background/foreground music, intercom and telephone interconnect, field programming, inventory control systems, microwave transmission, multi-media, multiplex, radio page, school, intercom and sound burglar alarms and low voltage master clock systems.

Excluded from this classification are energy management systems, life safety systems, supervisory controls and data acquisition systems not intrinsic with the above listed systems, fire alarm systems, nurse call systems and raceways exceeding fifteen feet in length.

### TRUCK DRIVER - BUILDING, HEAVY AND HIGHWAY CONSTRUCTION

Class 1. Drivers on 2 axle trucks hauling less than 9 ton. Air compressor and welding machines and brooms, including those pulled by separate units, truck driver helpers, warehouse employees, mechanic helpers, greasers and tiremen, pickup trucks when hauling materials, tools, or workers to and from and on-the-job site, and fork lifts up to 6,000 lb. capacity.

Class 2. Two or three axle trucks hauling more than 9 ton but hauling less than 16 ton. A-frame winch trucks, hydrolift trucks, vector trucks or similar equipment when used for transportation purposes. Fork lifts over 6,000 lb. capacity, winch trucks, four axle combination units, and ticket writers.

Class 3. Two, three or four axle trucks hauling 16 ton or more. Drivers on water pulls, articulated dump trucks, mechanics and working forepersons, and dispatchers. Five axle or more combination units.

Class 4. Low Boy and Oil Distributors.

Class 5. Drivers who require special protective clothing while employed on hazardous waste work.

### TRUCK DRIVER - OIL AND CHIP RESEALING ONLY.

This shall encompass laborers, workers and mechanics who drive contractor or subcontractor owned, leased, or hired pickup, dump, service, or oil distributor trucks. The work includes transporting materials and equipment (including but not limited to, oils, aggregate supplies, parts, machinery and tools) to or from the job site; distributing oil or liquid asphalt and aggregate; stock piling material when in connection with the actual oil and chip contract. The Truck Driver (Oil & Chip Resealing) wage classification does not include supplier delivered materials.

#### OPERATING ENGINEERS - BUILDING

CLASS 1. Asphalt Screed Man; Aspco Concrete Spreaders; Asphalt Pavers; Asphalt Plant Engineer; Asphalt Rollers on Bituminous Concrete; Athey Loaders; Backfillers, Crane Type; Backhoes; Barber Green Loaders; Bulldozers; Cableways; Cherry Pickers; Clam Shells; C.M.I. & similar type autograde formless paver, autograde placer & finisher; Concrete Breakers; Concrete Pumps; Derricks; Derrick Boats; Draglines; Earth Auger or Boring Machines; Elevating Graders; Engineers on Dredges; Gravel Processing Machines; Head Equipment Greaser; High Lifts or Fork Lifts; Hoists with two or more drums or two or more load lines; Locomotives, All; Mechanics; Motor Graders or Auto Patrols; Operators or Leverman on Dredges; Operators, Power Boat; Operators, Pug Mill (Asphalt Plants); Orange Peels; Overhead Cranes; Paving Mixers; Piledrivers; Pipe Wrapping and Painting Machines; Pushdozers, or Push Cats; Robotic Controlled Equipment in this Classification; Rock Crushers; Ross Carrier or Similar Machines; Rotomill; Scoops, Skimmer, two cu. yd. capacity and under; Scoops, All or Tournapull; Sheep-Foot Roller (Self Propelled); Shovels; Skid Steer; Skimmer Scoops; Temporary Concrete Plant Operators; Test Hole Drilling Machines; Tower Machines; Tower Mixers; Track Type End Loaders; Track Type Fork Lifts or High Lifts; Track Jacks and Tampers; Tractors, Sideboom; Trenching or Ditching Machine; Tunnelluggers; Vermeer Type Saws; Water Blaster Cutting Head; Wheel Type End Loaders; Winch Cat.

CLASS 2. Air Compressors (six to eight)\*; Asphalt Boosters and Heaters; Asphalt Distributors; Asphalt Plant Fireman; Oiler on Two Paving Mixers When Used in Tandem; Boom or Winch Trucks; Bull Floats or Flexplanes; Concrete Finishing Machine; Concrete Saws, Self-Propelled; Concrete Spreading Machines; Conveyors (six to eight)\*; Generators (six to eight)\*; Gravel or Stone Spreader, Power Operated; Hoist (with One Drum and One Load Line); Light Plants (six to eight)\*; Mechanical Heaters (six to eight)\*; Mud Jacks; Post Hole Digger, Mechanical; Pug Mills when used for other than Asphalt operation; Robotic Controlled Equipment in this Classification; Road or Street Sweeper, Self Propelled; Rollers (except bituminous concrete); Seaman Tiller; Straw Machine; Vibratory Compactor; Water Blaster, Power Unit; Welding Machines (six to eight)\*; Well Drill Machines.

CLASS 3. Air Compressors(one to five)\*; Air Compressors, Track or Self-Propelled; Automatic Hoist; Building Elevators; Bulk Cement Batching Plants; Conveyors (one to five)\*; Concrete Mixers (Except Plant, Paver, or Tower); Firemen; Generators (one to five)\*; Greasers; Helper on Single Paving Mixer; Hoist, Automatic; Light Plants (one to five)\*; Mechanic Helpers; Mechanical Heaters (one to five)\*; Oilers; Power Form Graders; Power Sub-Graders; Robotic Controlled Equipment in this Classification; Scissors Hoist; Tractors without power attachments regardless of size or type; Truck Crane Oiler and Driver (1 man); Vibratory Hammer (power source); Water Pumps (one to five)\*; Welding Machines (1/300 Amp. or over)\*; Welding machines (one to five)\*

CLASS 4. Lattice Boom Crawler Cranes; Lattice Boom Truck Cranes; Telescopic Truck-Mounted Cranes; Tower Cranes.

\* Combinations of one to eight of any Air Compressors, Conveyors, Welding Machines, Water Pumps, Light Plants, or Generators shall be in batteries or within 400 feet and shall be paid as per the Classification Schedule contained in this Article.

#### OPERATING ENGINEERS - HIGHWAY

CLASS 1. Asphalt Screed Man; Asphco Concrete Spreaders; Asphalt Pavers; Asphalt Plant Engineer; Asphalt Rollers on Bituminous Concrete; Athey Loaders; Backhoes; Barber Green Loaders; Bulldozers; Cableways; Carry Deck Pickers; Cherry Pickers (Rough Terrain); C.M.I. & similar type-autograde formless paver, autograde placer & finisher; Concrete Breakers; Concrete Plant Operators; Concrete Pumps; Derricks; Derrick Boats; Dewatering Systems; Earth Auger or Boring Machines; Elevating Graders; Engineers on Dredges; Gravel Processing Machines; Grout Pump; Head Equipment Greaser; High Lifts or Fork Lifts; Hoists with two or more drums or two or more load lines; Hydro Jet or Hydro Laser; Locomotives, All; Mechanics; Motor Graders or Auto Patrols; Multi-Point Power Lifting Equipment; Operators or Leverman on Dredges; Operators, Power Boat; Operators, Pug Mill (Asphalt Plants); Overhead Cranes; Paving Mixers; Piledrivers; Pipe Wrapping and Painting Machines; Push-dozers, or Push Cats; Robotic Controlled Equipment in this Classification; Rock Crushers; Ross Carrier or Similar Machines; Roto-Mill; Scoops, Skimmer, two cu. yd. capacity and under; Sheep-Foot Roller (Self Pro-pelled); Shovels; Skid Steer; Skimmer Scoops; Test Hole Drilling Machines; Tower Machines; Tower Mixers; Track Type End Loaders; Track Type Fork Lifts or High Lifts; Track Jacks and Tampers; Tractors, Side-boom; Trenching or Ditching Machine; Tunnelluggers; Vermeer-Type Saws; Wheel Type End Loaders; Winch Cat; Scoops, All or Tournapull.

CLASS 2. Air Compressors (six to eight)\*; Articulated Dumps; Asphalt Boosters and Heaters; Asphalt Distributors; Asphalt Plant Fireman; Boom or Winch Trucks; Building Elevators; Bull Floats or Flexplanes; Concrete Finishing Machine; Concrete Saws, Self-Propelled; Concrete Spreading Machines; Conveyors (six to eight)\*; Generators (six to eight)\*; Gravel or Stone Spreader, Power Operated; Hoist, Automatic; Hoist with One Drum and One Load Line; Light Plants (six to eight)\*; Mechanical Heaters (six to eight)\*; Mud Jacks; Off Road Water Wagons; Oiler on Two Paving Mixers When Used in Tandem; Post Hole Digger, Mechanical; Robotic Controlled Equipment in This Classification; Road or Street Sweeper, Self-Propelled; Rollers (except bituminous concrete); Scissor Hoist; Sea-man Tiller; Straw Machine; Vibratory Compactor; Water Pumps (six to eight)\*; Well Drill Machines.

CLASS 3. Air Compressors (one to five)\*; Air Compressors, Track or Self-Propelled; Bulk Cement Batching Plants; Conveyors (one to five)\*; Concrete Mixers (Except Plant, Paver, or Tower); Firemen; Generators (one to five)\*; Greasers; Helper on Single Paving Mixer; Light Plants (one to five)\*; Mechanic Helpers; Mechanical Heaters (one to five)\*; Oilers; Power Form Graders; Power Sub-Graders; Pug Mills when used for other than Asphalt operation; Robotic Controlled Equipment in This Classification; Tractors without power attachments, regardless of size or type; Truck Crane Oiler and Driver (1 man); Vibratory Hammer (power source); Water Pumps (one to five)\*; Welding Machines (one 300 Amp. or over)\*; Welding Machines (one to five)\*.

CLASS 4. Lattice Boom Crawler Crane; Lattice Boom Truck Crane;

Telescopic Truck-Mounted Crane; Tower Crane.

\*Combinations of one to eight of any Air Compressors, Conveyors, Welding Machines, Water Pumps, Light Plants or Generators shall be in batteries or within 400 feet and shall be paid as per the Classification Schedule contained in this Article.

Other Classifications of Work:

For definitions of classifications not otherwise set out, the Department generally has on file such definitions which are available. If a task to be performed is not subject to one of the classifications of pay set out, the Department will upon being contacted state which neighboring county has such a classification and provide such rate, such rate being deemed to exist by reference in this document. If no neighboring county rate applies to the task, the Department shall undertake a special determination, such special determination being then deemed to have existed under this determination. If a project requires these, or any classification not listed, please contact IDOL at 618/993-7271 for wage rates or clarifications.

LANDSCAPING

Landscaping work falls under the existing classifications for laborer, operating engineer and truck driver. The work performed by landscape plantsman and landscape laborer is covered by the existing classification of laborer. The work performed by landscape operators (regardless of equipment used or its size) is covered by the classifications of operating engineer. The work performed by landscape truck drivers (regardless of size of truck driven) is covered by the classifications of truck driver.



# Stark County Prevailing Wage for April 2007

Trade Name	RG	TYP	C	Base	FRMAN	*M-F>8	OSA	OSH	H/W	Pensn	Vac	Trng
=====	==	===	=	=====	=====	=====	===	===	=====	=====	=====	=====
ASBESTOS ABT-GEN	E	BLD		25.090	25.840	1.5	1.5	2.0	5.850	5.250	0.000	0.600
ASBESTOS ABT-GEN	E	HWY		25.870	26.420	1.5	1.5	2.0	5.850	5.250	0.000	0.700
ASBESTOS ABT-GEN	W	BLD		23.510	24.260	1.5	1.5	2.0	5.850	6.180	0.000	0.600
ASBESTOS ABT-GEN	W	HWY		22.940	23.440	1.5	1.5	2.0	5.850	5.850	0.000	0.700
ASBESTOS ABT-MEC		BLD		23.300	24.800	1.5	1.5	2.0	7.860	4.910	0.000	0.000
BOILERMAKER		BLD		30.970	33.970	2.0	2.0	2.0	8.270	7.740	0.000	0.300
BRICK MASON		BLD		29.500	30.500	1.5	1.5	5.0	6.070	6.000	0.000	0.400
CARPENTER		BLD		27.220	28.720	1.5	1.5	2.0	5.810	8.170	0.000	0.570
CARPENTER		HWY		26.480	28.230	1.5	1.5	2.0	5.810	7.670	0.000	0.500
CEMENT MASON		ALL		30.000	31.000	1.5	1.5	2.0	5.500	7.390	0.000	0.100
CERAMIC TILE FNSHER		BLD		24.860	0.000	1.5	1.5	2.0	5.500	4.000	0.000	0.360
COMMUNICATION TECH	N	BLD		29.110	30.610	1.5	1.5	2.0	8.270	8.670	0.000	0.290
ELECTRIC PWR EQMT OP		ALL		30.750	0.000	1.5	1.5	2.0	4.750	8.610	0.000	0.000
ELECTRIC PWR GRNDMAN		ALL		21.090	0.000	1.5	1.5	2.0	4.750	5.905	0.000	0.000
ELECTRIC PWR LINEMAN		ALL		34.160	36.350	1.5	1.5	2.0	4.750	9.560	0.000	0.000
ELECTRIC PWR TRK DRV		ALL		22.130	0.000	1.5	1.5	2.0	4.750	6.200	0.000	0.000
ELECTRICIAN	N	BLD		33.950	37.010	1.5	1.5	2.0	8.570	11.01	0.000	0.340
ELECTRICIAN	S	BLD		29.860	31.860	1.5	1.5	2.0	5.150	8.060	0.000	0.250
ELECTRONIC SYS TECH	S	BLD		23.850	25.350	1.5	1.5	2.0	5.150	5.625	0.000	0.250
ELEVATOR CONSTRUCTOR		BLD		34.190	38.460	2.0	2.0	2.0	8.275	6.060	2.050	0.000
GLAZIER		BLD		26.320	27.070	1.5	1.5	2.0	5.650	5.750	0.000	0.350
HT/FROST INSULATOR		BLD		34.750	36.500	1.5	1.5	2.0	8.260	9.110	0.000	0.310
IRON WORKER	NE	ALL		28.000	29.000	2.0	2.0	2.0	8.040	11.85	0.000	0.550
IRON WORKER	SW	BLD		24.960	26.710	1.5	1.5	2.0	8.040	7.410	0.000	0.400
IRON WORKER	SW	HWY		25.920	27.420	1.5	1.5	2.0	8.040	7.410	0.000	0.350
LABORER	E	BLD		24.090	24.840	1.5	1.5	2.0	5.850	5.250	0.000	0.600
LABORER	E	HWY		24.870	25.420	1.5	1.5	2.0	5.850	5.250	0.000	0.600
LABORER	W	BLD		22.510	23.260	1.5	1.5	2.0	5.850	6.180	0.000	0.600
LABORER	W	HWY		21.940	22.440	1.5	1.5	2.0	5.850	5.850	0.000	0.600
LABORER, SKILLED		BLD		22.510	23.260	1.5	1.5	2.0	5.850	6.180	0.000	0.600
LABORER, SKILLED		HWY		22.240	22.740	1.5	1.5	2.0	5.850	5.850	0.000	0.600
LATHER		BLD		27.220	28.720	1.5	1.5	2.0	5.810	8.170	0.000	0.570
MACHINERY MOVER	SW	HWY		25.920	27.420	1.5	1.5	2.0	8.040	7.410	0.000	0.350
MACHINIST		BLD		36.890	38.890	2.0	2.0	2.0	4.380	5.650	2.550	0.000
MARBLE FINISHERS		BLD		24.860	0.000	1.5	1.5	2.0	5.500	4.000	0.000	0.360
MARBLE MASON		BLD		28.140	28.390	1.5	1.5	2.0	5.500	5.220	0.000	0.380
MILLWRIGHT		BLD		32.000	35.200	1.5	1.5	2.0	6.100	9.250	0.000	0.560
MILLWRIGHT		HWY		19.330	20.580	1.5	1.5	2.0	1.550	2.000	0.000	0.000
OPERATING ENGINEER		BLD	1	27.840	30.840	1.5	1.5	2.0	5.900	8.000	0.000	0.900
OPERATING ENGINEER		BLD	2	25.940	30.840	1.5	1.5	2.0	5.900	8.000	0.000	0.900
OPERATING ENGINEER		BLD	3	24.560	30.840	1.5	1.5	2.0	5.900	8.000	0.000	0.900
OPERATING ENGINEER		HWY	1	29.110	32.110	1.5	1.5	2.0	6.250	9.000	0.000	1.000
OPERATING ENGINEER		HWY	2	26.730	32.110	1.5	1.5	2.0	6.250	9.000	0.000	1.000
OPERATING ENGINEER		HWY	3	22.790	32.110	1.5	1.5	2.0	6.250	9.000	0.000	1.000
PAINTER		ALL		26.850	27.850	1.5	1.5	1.5	5.650	5.750	0.000	0.350
PAINTER SIGNS		BLD		28.970	32.520	1.5	1.5	1.5	2.600	2.310	0.000	0.000
PILEDRIVER		BLD		27.470	28.970	1.5	1.5	2.0	5.810	8.170	0.000	0.570
PILEDRIVER		HWY		26.480	28.230	1.5	1.5	2.0	5.810	7.670	0.000	0.500
PIPEFITTER		BLD		31.630	35.110	1.5	1.5	2.0	6.450	7.680	0.000	0.420
PLASTERER		BLD		28.690	29.690	1.5	1.5	2.0	5.150	7.050	0.000	0.050
PLUMBER		BLD		28.390	30.950	1.5	1.5	2.0	6.450	8.990	0.000	0.800
ROOFER		BLD		24.200	25.200	1.5	1.5	2.0	5.350	6.550	0.000	0.150
SHEETMETAL WORKER		BLD		29.890	31.140	1.5	1.5	2.0	5.770	6.730	0.000	0.200
SIGN HANGER	SW	HWY		25.920	27.420	1.5	1.5	2.0	8.040	7.410	0.000	0.350
SPRINKLER FITTER		BLD		31.240	33.240	1.5	1.5	2.0	6.500	5.350	0.000	0.250
STEEL ERECTOR	SW	HWY		25.920	27.420	1.5	1.5	2.0	8.040	7.410	0.000	0.350
STONE MASON		BLD		29.500	30.500	1.5	1.5	5.0	6.070	6.000	0.000	0.400
TERRAZZO FINISHER		BLD		24.860	0.000	1.5	1.5	2.0	5.500	4.000	0.000	0.360

TILE LAYER	BLD	27.220	28.720	1.5	1.5	2.0	5.810	8.170	0.000	0.570
TILE MASON	BLD	28.140	28.390	1.5	1.5	2.0	5.500	5.220	0.000	0.380
TRUCK DRIVER	ALL 1	25.787	0.000	1.5	1.5	2.0	7.250	3.317	0.000	0.000
TRUCK DRIVER	ALL 2	26.187	0.000	1.5	1.5	2.0	7.250	3.317	0.000	0.000
TRUCK DRIVER	ALL 3	26.387	0.000	1.5	1.5	2.0	7.250	3.317	0.000	0.000
TRUCK DRIVER	ALL 4	26.637	0.000	1.5	1.5	2.0	7.250	3.317	0.000	0.000
TRUCK DRIVER	ALL 5	27.387	0.000	1.5	1.5	2.0	7.250	3.317	0.000	0.000
TRUCK DRIVER	O&C 1	20.630	0.000	1.5	1.5	2.0	7.250	3.317	0.000	0.000
TRUCK DRIVER	O&C 2	20.950	0.000	1.5	1.5	2.0	7.250	3.317	0.000	0.000
TRUCK DRIVER	O&C 3	21.110	0.000	1.5	1.5	2.0	7.250	3.317	0.000	0.000
TRUCK DRIVER	O&C 4	21.310	0.000	1.5	1.5	2.0	7.250	3.317	0.000	0.000
TRUCK DRIVER	O&C 5	21.910	0.000	1.5	1.5	2.0	7.250	3.317	0.000	0.000
TUCKPOINTER	BLD	29.500	30.500	1.5	1.5	5.0	6.070	6.000	0.000	0.400

Legend:

M-F>8 (Overtime is required for any hour greater than 8 worked each day, Monday through Friday.)

OSA (Overtime is required for every hour worked on Saturday)

OSH (Overtime is required for every hour worked on Sunday and Holidays)

H/W (Health & Welfare Insurance)

Pensn (Pension)

Vac (Vacation)

Trng (Training)

## Explanations

### STARK COUNTY

ELECTRICIANS AND ELECTRONIC SYSTEMS TECHNICIAN (SOUTH) - West Jersey, Essex and Valley Townships.

IRONWORKERS (SOUTHWEST) - That part of the county South of a diagonal line through Toulon and Bradford.

LABORERS & ASBESTOS (EAST) - That part east of a north/south line parallel to the east border of Stark County running through the center of Wyoming on Route 91 and continuing north and south through Stark County.

The following list is considered as those days for which holiday rates of wages for work performed apply: New Years Day, Memorial/Decoration Day, Fourth of July, Labor Day, Veterans Day, Thanksgiving Day, Christmas Day. Generally, any of these holidays which fall on a Sunday is celebrated on the following Monday. This then makes work performed on that Monday payable at the appropriate overtime rate for holiday pay. Common practice in a given local may alter certain days of celebration such as the day after Thanksgiving for Veterans Day. If in doubt, please check with IDOL.

Oil and chip resealing (O&C) means the application of road oils and liquid asphalt to coat an existing road surface, followed by application of aggregate chips or gravel to coated surface, and

subsequent rolling of material to seal the surface.

#### EXPLANATION OF CLASSES

ASBESTOS - GENERAL - removal of asbestos material/mold and hazardous materials from any place in a building, including mechanical systems where those mechanical systems are to be removed. This includes the removal of asbestos materials/mold and hazardous materials from ductwork or pipes in a building when the building is to be demolished at the time or at some close future date.

ASBESTOS - MECHANICAL - removal of asbestos material from mechanical systems, such as pipes, ducts, and boilers, where the mechanical systems are to remain.

#### CERAMIC TILE FINISHER, MARBLE FINISHER, TERRAZO FINISHER

Assisting, helping or supporting the tile, marble and terrazzo mechanic by performing their historic and traditional work assignments required to complete the proper installation of the work covered by said crafts. The term "Ceramic" is used for naming the classification only and is in no way a limitation of the product handled. Ceramic takes into consideration most hard tiles.

#### COMMUNICATIONS TECHNICIAN

Installation, operation, inspection, maintenance, repair and service of radio, television, recording, voice, sound and vision production and reproduction, telephone and telephone interconnect, facsimile, equipment and appliances used for domestic, commercial, educational and entertainment purposes, pulling of wire through conduit but not the installation of conduit.

#### ELECTRONIC SYSTEMS TECHNICIAN

Installation, service and maintenance of low-voltage systems which utilizes the transmission and/or transference of voice, sound, vision, or digital for commercial, education, security and entertainment purposes for the following: TV monitoring and surveillance, background/foreground music, intercom and telephone interconnect, field programming, inventory control systems, microwave transmission, multi-media, multiplex, radio page, school, intercom and sound burglar alarms and low voltage master clock systems.

Excluded from this classification are energy management systems, life safety systems, supervisory controls and data acquisition systems not intrinsic with the above listed systems, fire alarm systems, nurse call systems and raceways exceeding fifteen feet in length.

#### LABORER, SKILLED - BUILDING

The skilled laborer building (BLD) classification shall encompass the following types of work, irrespective of the site of the work: tending of carpenters in unloading, handling, stockpiling and distribution operations, also other building crafts, mixing, handling, and conveying of all materials used by masons, plasterers and other building construction crafts, whether done by hand or by any process. The drying of plastering when done by salamander heat, and the cleaning and clearing of all debris. All work pertaining to and in preparation of asbestos abatement and removal. The building of scaffolding and staging for masons and plasterers. The excavations for buildings and all other construction, digging, of trenches, piers, foundations and holes, digging, lagging, sheeting, cribbing, bracing

and propping of foundations, holes, caissons, cofferdams, and dikes, the setting of all guidelines for machine or hand excavation and subgrading. The mixing, handling, conveying, pouring, vibrating, gunniting and otherwise applying of concrete, whether by hand or other method of concrete for any walls, foundations, floors, or for other construction concrete sealant men. The wrecking, stripping, dismantling, and handling of concrete forms and false work, and the building of centers for fireproofing purposes. Boring machine, gas, electric or air in preparation for shoving pipe, telephone cable, and so forth, under highways, roads, streets and alleys. All hand and power operating cross cut saws when used for clearing. All work in compressed air construction. All work on acetylene burners in salvaging. The blocking and tamping of concrete. The laying of sewer tile and conduit, and pre-cast materials. The assembling and dismantling of all jacks and sectional scaffolding, including elevator construction and running of slip form jacks. The work of drill running and blasting, including wagon drills. The wrecking, stripping, dismantling, cleaning, moving and oiling of forms. The cutting off of concrete piles. The loading, unloading, handling and carrying to place of installation of all rods, (and materials for use in reinforcing) concrete and the hoisting of same and all signaling where hoist is used in this type of construction coming under the jurisdiction of the Laborers' Union. And, all other labor work not awarded to any other craft. Mortar mixers, kettlemen and carrier of hot stuff, tool crib men, watchmen (Laborer), firemen or salamander tenders, flagmen, deck hands, installation and maintenance of temporary gas-fired heating units, gravel box men, dumpmen and spotters, fencing Laborers, cleaning lumber, pit men, material checkers, dispatchers, unloading explosives, asphalt plant laborers, writer of scale tickets, fireproofing laborers, janitors, asbestos abatement and removal laborers, handling of materials treated with oil, creosote, chloride, asphalt, and/or foreign material harmful to skin or clothing, Laborers with de-watering systems, gunnite nozzle men, laborers tending masons with hot material or where foreign materials are used, Laborers handling masterplate or similar materials, laser beam operator, concrete burning machine operator, material selector men working with firebrick or combustible material, dynamite men, track laborers, cement handlers, chloride handlers, the unloading and laborers with steel workers and re-bars, concrete workers (wet), luteman, asphalt raker, curb asphalt machine operator, ready mix scalemen, permanent, portable or temporary plant drilling machine operator, plaster tenders, underpinning and shoring of buildings, fire watch, signaling of all power equipment, to include trucks excavating equipment, etc., tree topper or trimmer when in connection to construction, tunnel helpers in free air, batch dumpers, kettle and tar men, tank cleaners, plastic installers, scaffold workers, motorized buggies or motorized unit used for wet concrete or handling of building materials, sewer workers, rod and chain men, vibrator operators, mortar mixer operator, cement silica, clay, fly ash, lime and plasters, handlers (bulk or bag), cofferdam workers, on concrete paving, placing, cutting and tying of reinforcing, deck hand, dredge hand and shore laborers, bankmen on floating plant, asphalt workers with machine & layers, grade checker, power tools, caisson workers, lead man on sewer work, welders, cutters, burners and torch men, chain saw operators, paving breaker, jackhammer and drill operator, layout man and/or drainage tile layer, steel form setters -- street and highway, air tamping hammerman, signal man on crane, concrete saw operator, screen man on asphalt pavers, front end man on chip spreader, multiple concrete duct -- lead man.

LABORER, SKILLED - HIGHWAY

The skilled laborer heavy and highway (HWY) classification shall

encompass the following types of work, irrespective of the site of the work: handling of materials treated with oil, creosote, asphalt and/or any foreign materials harmful to skin or clothing, track laborers, chloride handlers, the unloading and loading with steel workers and re-bars, concrete workers (wet), tunnel helpers in free air, batch dumpers, mason tenders, kettle and tar men, plastic installers, scaffold workers, motorized buggies or motorized unit used for wet concrete or handling of building materials, laborers with de-watering systems, sewer workers plus depth, rod and chainmen, vibrator operators, mortar mixer operators, cement silica, clay, fly ash, lime and plasters, handlers (bulk or bag), cofferdam workers plus depth, on concrete paving, placing, cutting and tying or reinforcing, deck hand, dredge hand shore laborers, bankmen on floating plant, asphalt workers with machine, and layers, grade checker, power tools, stripping of all concrete forms excluding paving forms, dumpmen and spotters, when necessary, caisson workers plus depth, gunnite nozzle men, welders, cutters, burners and torchmen, chain saw operators, paving breaker, jackhammer and drill operators, layout man and/or drainage tile layer, steel form setters - street and highway, air tamping hammerman, signal man on crane, concrete saw operator, screedman on asphalt pavers, front end man on chip spreader, multiple concrete duct, luteman, asphalt raker, curb asphalt machine operator, ready mix scalemen (portable or temporary plant), laser beam operator, concrete burning machine operator, and coring machine operator.

#### TRUCK DRIVER - BUILDING, HEAVY AND HIGHWAY CONSTRUCTION

Class 1. Drivers on 2 axle trucks hauling less than 9 ton. Air compressor and welding machines and brooms, including those pulled by separate units, truck driver helpers, warehouse employees, mechanic helpers, greasers and tiremen, pickup trucks when hauling materials, tools, or workers to and from and on-the-job site, and fork lifts up to 6,000 lb. capacity.

Class 2. Two or three axle trucks hauling more than 9 ton but hauling less than 16 ton. A-frame winch trucks, hydrolift trucks, vector trucks or similar equipment when used for transportation purposes. Fork lifts over 6,000 lb. capacity, winch trucks, four axle combination units, and ticket writers.

Class 3. Two, three or four axle trucks hauling 16 ton or more. Drivers on water pulls, articulated dump trucks, mechanics and working forepersons, and dispatchers. Five axle or more combination units.

Class 4. Low Boy and Oil Distributors.

Class 5. Drivers who require special protective clothing while employed on hazardous waste work.

#### TRUCK DRIVER - OIL AND CHIP RESEALING ONLY.

This shall encompass laborers, workers and mechanics who drive contractor or subcontractor owned, leased, or hired pickup, dump, service, or oil distributor trucks. The work includes transporting materials and equipment (including but not limited to, oils, aggregate supplies, parts, machinery and tools) to or from the job site; distributing oil or liquid asphalt and aggregate; stock piling material when in connection with the actual oil and chip contract. The Truck Driver (Oil & Chip Resealing) wage classification does not include supplier delivered materials.

#### OPERATING ENGINEERS - BUILDING

Class 1. Cranes; Overhead Cranes; Gradall; All Cherry Pickers; Mechanics; Central Concrete Mixing Plant Operator; Road Pavers (27E - Dual Drum - Tri Batchers); Blacktop Plant Operators and Plant Engineers; 3 Drum Hoist; Derricks; Hydro Cranes; Shovels; Skimmer Scoops; Koehring Scooper; Drag Lines; Backhoe; Derrick Boats; Pile Drivers and Skid Rigs; Clamshells; Locomotive Cranes; Dredge (all types) Motor Patrol; Power Blades - Dumore - Elevating and similar types; Tower Cranes (Crawler-Mobile) and Stationary; Crane-type Backfiller; Drott Yumbo and similar types considered as Cranes; Caisson Rigs; Dozer; Tournadozer; Work Boats; Ross Carrier; Helicopter; Tournapulls - all and similar types; Scoops (all sizes); Pushcats; Endloaders (all types); Asphalt Surfacing Machine; Slip Form Paver; Rock Crusher; Heavy Equipment Greaser; CMI, CMI Belt Placer, Auto Grade & 3 Track and similar types; Side Booms; Multiple Unit Earth Movers; Creter Crane; Trench Machine; Pump-crete-Belt Crete-Squeeze Cretes-Screw-type Pumps and Gypsum; Bulker & Pump - Operator will clean; Formless Finishing Machine; Flaherty Spreader or similar types; Screed Man on Laydown Machine; Wheel Tractors (industrial or Farm-type w/Dozer-Hoe-Endloader or other attachments); F.W.D. & Similar Types; Vermeer Concrete Saw.

Class 2. Dinkeys; Power Launches; PH One-pass Soil Cement Machine (and similar types); Pugmill with Pump; Backfillers; Euclid Loader; Forklifts; Jeeps w/Ditching Machine or other attachments; Tuneluger; Automatic Cement and Gravel Batching Plants; Mobile Drills (Soil Testing) and similar types; Gurries and Similar Types; (1) and (2) Drum Hoists (Buck Hoist and Similar Types); Chicago Boom; Boring Machine & Pipe Jacking Machine; Hydro Boom; Dewatering System; Straw Blower; Hydro Seeder; Assistant Heavy Equipment Greaser on Spread; Tractors (Track type) without Power Unit pulling Rollers; Rollers on Asphalt -- Brick Macadem; Concrete Breakers; Concrete Spreaders; Mule Pulling Rollers; Center Stripper; Cement Finishing Machines & CMI Texture & Reel Curing Machines; Cement Finishing Machine; Barber Green or similar loaders; Vibro Tamper (All similar types) Self-propelled; Winch or Boom Truck; Mechanical Bull Floats; Mixers over 3 Bag to 27E; Tractor pulling Power Blade or Elevating Grader; Porter Rex Rail; Clary Screed; Truck Type Hoptoe Oilers; Fireman; Spray Machine on Paving; Curb Machines; Truck Crane Oilers; Oil Distributor; Truck-Mounted Saws.

Class 3. Air Compressor; Power Subgrader; Straight Tractor; Trac Air without attachments; Herman Nelson Heater, Dravo, Warner, Silent Glo, and similar types; Roller: Five (5) Ton and under on Earth or Gravel; Form Grader; Crawler Crane & Skid Rig Oilers; Freight Elevators - permanently installed; Pump; Light Plant; Generator; Conveyor (1) or (2) - Operator will clean; Welding Machine; Mixer (3) Bag and Under (Standard Capacity with skip); Bulk Cement Plant; Oiler on Central Concrete Mixing Plant.

#### OPERATING ENGINEERS - HEAVY AND HIGHWAY CONSTRUCTION

Class 1. Cranes; Hydro Crane; Shovels; Crane Type Backfiller; Tower Cranes - Mobile & Crawler & Stationary; Derricks & Hoists (3 Drum); Draglines; Drott Yumbo & similar types considered as Cranes; Back Hoe; Derrick Boats; Pile Driver and Skid Rigs; Clam Shell; Locomotive - Cranes; Road Pavers - Single Drum - Dual Drum - Tri Batchers; Motor Patrols & Power Blades - Dumore - Elevating & Similar Types; Mechanics; Central Concrete Mixing Plant Operator; Asphalt Batch Plant Operators and Plant Engineers; Gradall; Caisson Rigs; Skimmer Scoop - Koehring Scooper; Dredges (all types); Hoptoe; All Cherry Pickers; Work Boat; Ross Carrier; Helicopter; Dozer; Tournadozer; Tournapulls - all and similar types; Multiple Unit Earth Movers; Scoops (all sizes); Pushcats; Endloaders (all types); Asphalt Surfacing Machine;

Slip Form Paver; Rock Crusher; Heavy Equipment Greaser (top greaser on spread); CMI, Auto Grade, CMI Belt Placer & 3 Track and similar types; Side Booms; Starting Engineer on Pipeline; Asphalt Heater & Planer Combination (used to plane streets); Wheel Tractors (with dozer, hoe or endloader attachments); F.W.D. and Similar types; Blaw Knox Spreader and Similar types; Trench Machines; Pump Crete - Belt Crete - Squeeze Crete - screw type pumps and gypsum (operator will clean); Formless Finishing Machines; Flaherty Spreader or similar types; Screed Man on Laydown Machine; Vermeer Concrete Saw.

Class 2. Bulker & Pump; Power Launches; Boring Machine & Pipe Jacking Machine; Dinkeys; P-H One Pass Soil Cement Machines and similar types; Wheel Tractors (Industry or farm type - other); Back Fillers; Euclid Loader; Fork Lifts; Jeep w/Ditching Machine or other attachments; Tunneluger; Automatic Cement & Gravel Batching Plants; Mobile Drills - Soil Testing and similar types; Pugmill with pump; All (1) and (2) Drum Hoists; Dewatering System; Straw Blower; Hydro-Seeder; Boring Machine; Hydro-Boom; Bump Grinders (self-propelled); Assistant Heavy Equipment Greaser; Apsco Spreader; Tractors (track-type) without Power Units Pulling Rollers on Asphalt - Brick or Macadam; Concrete Breakers; Concrete Spreaders; Cement Strippers; Cement Finishing Machines & CMI Texture & Reel Curing Machines; Vibro-Tampers (all similar types self-propelled); Mechanical Bull Floats; Self-propelled Concrete Saws; Mixers-over three (3) bags to 27E; Winch and Boom Trucks; Tractor Pulling Power Blade or Elevating Grader; Porter Rex Rail; Clary Screed; Mule Pulling Rollers; Pugmill without Pump; Barber Greene or similar Loaders; Track Type Tractor w/Power Unit attached (minimum); Fireman; Spray Machine on Paving; Curb Machines; Paved Ditch Machine; Power Broom; Self-Propelled Conveyors; Power Subgrader; Oil Distributor; Straight Tractor; Truck Crane Oiler; Truck Type Oilers; Directional boring machine; Horizontal directional drill.

Class 3. Straight framed articulating end dump vehicles and Truck mounted vac unit (separately powered); Trac Air Machine (without attachments); Herman Nelson Heater, Dravo Warner, Silent Glo & similar types; Rollers - five ton and under on earth and gravel; Form Graders; Pumps; Light Plant; Generator; Air Compressor (1) or (2); Conveyor; Welding Machine; Mixer - 3 bags and under; Bulk Cement Plant; Oilers.

#### Other Classifications of Work:

For definitions of classifications not otherwise set out, the Department generally has on file such definitions which are available. If a task to be performed is not subject to one of the classifications of pay set out, the Department will upon being contacted state which neighboring county has such a classification and provide such rate, such rate being deemed to exist by reference in this document. If no neighboring county rate applies to the task, the Department shall undertake a special determination, such special determination being then deemed to have existed under this determination. If a project requires these, or any classification not listed, please contact IDOL at 618/993-7271 for wage rates or clarifications.

#### LANDSCAPING

Landscaping work falls under the existing classifications for laborer, operating engineer and truck driver. The work performed by landscape plantsman and landscape laborer is covered by the existing classification of laborer. The work performed by landscape operators (regardless of equipment used or its size) is covered by the

classifications of operating engineer. The work performed by landscape truck drivers (regardless of size of truck driven) is covered by the classifications of truck driver.



# Stephenson County Prevailing Wage for April 2007

Trade Name	RG	TYP	C	Base	FRMAN	*M-F>8	OSA	OSH	H/W	Pensn	Vac	Trng
ASBESTOS ABT-GEN		BLD		23.760	24.760	1.5	1.5	2.0	5.850	8.730	0.000	0.600
ASBESTOS ABT-MEC		BLD		18.950	0.000	1.5	1.5	2.0	2.700	3.350	0.000	0.000
BOILERMAKER		BLD		30.970	33.970	2.0	2.0	2.0	8.270	7.740	0.000	0.300
BRICK MASON		BLD		30.000	32.500	1.5	1.5	2.0	5.500	8.680	0.000	0.420
CARPENTER		BLD		27.040	30.010	1.5	1.5	2.0	6.100	8.220	0.000	0.600
CARPENTER		HWY		27.440	29.190	1.5	1.5	2.0	6.300	7.680	0.000	0.400
CEMENT MASON		ALL		30.000	32.500	1.5	1.5	2.0	5.500	7.530	0.000	0.100
CERAMIC TILE FNSHER		BLD		24.860	0.000	1.5	1.5	2.0	5.500	4.000	0.000	0.360
COMMUNICATION TECH		BLD		28.700	30.700	1.5	1.5	2.0	8.200	8.340	0.000	0.570
ELECTRIC PWR EQMT OP		ALL		27.920	35.880	1.5	1.5	2.0	4.750	7.820	0.000	0.210
ELECTRIC PWR GRNDMAN		ALL		21.640	35.880	1.5	1.5	2.0	4.750	6.060	0.000	0.160
ELECTRIC PWR LINEMAN		ALL		33.220	35.880	1.5	1.5	2.0	4.750	9.310	0.000	0.250
ELECTRIC PWR TRK DRV		ALL		22.340	35.880	1.5	1.5	2.0	4.750	6.260	0.000	0.170
ELECTRICIAN		BLD		33.570	36.930	1.5	1.5	2.0	8.200	11.15	0.000	0.670
ELEVATOR CONSTRUCTOR		BLD		38.620	43.450	2.0	2.0	2.0	8.275	6.060	2.320	0.000
GLAZIER		BLD		27.680	28.680	1.5	1.5	2.0	6.400	6.500	0.000	0.500
HT/FROST INSULATOR		BLD		29.630	31.850	1.5	1.5	2.0	6.000	8.720	0.000	0.000
IRON WORKER		ALL		30.760	32.300	2.0	2.0	2.0	6.950	16.62	0.000	0.550
LABORER		BLD		23.760	24.760	1.5	1.5	2.0	5.850	8.730	0.000	0.600
LABORER		HWY		23.310	24.060	1.5	1.5	2.0	5.850	8.330	0.000	0.600
LABORER, SKILLED		HWY		24.710	25.460	1.5	1.5	2.0	5.850	8.330	0.000	0.600
LATHER		BLD		27.040	30.010	1.5	1.5	2.0	6.100	8.220	0.000	0.600
MACHINIST		BLD		36.890	38.890	2.0	2.0	2.0	4.380	5.650	2.550	0.000
MARBLE FINISHERS		BLD		24.860	0.000	1.5	1.5	2.0	5.500	4.000	0.000	0.360
MARBLE MASON		BLD		28.140	28.390	1.5	1.5	2.0	5.500	5.220	0.000	0.380
MILLWRIGHT		BLD		32.150	35.370	1.5	1.5	2.0	5.150	9.450	0.000	0.560
OPERATING ENGINEER		BLD	1	37.050	41.050	2.0	2.0	2.0	6.850	6.150	1.900	0.700
OPERATING ENGINEER		BLD	2	36.350	41.050	2.0	2.0	2.0	6.850	6.150	1.900	0.700
OPERATING ENGINEER		BLD	3	33.900	41.050	2.0	2.0	2.0	6.850	6.150	1.900	0.700
OPERATING ENGINEER		BLD	4	31.900	41.050	2.0	2.0	2.0	6.850	6.150	1.900	0.700
OPERATING ENGINEER		HWY	1	36.900	40.900	1.5	1.5	2.0	6.850	6.150	1.900	0.700
OPERATING ENGINEER		HWY	2	36.350	40.900	1.5	1.5	2.0	6.850	6.150	1.900	0.700
OPERATING ENGINEER		HWY	3	35.050	40.900	1.5	1.5	2.0	6.850	6.150	1.900	0.700
OPERATING ENGINEER		HWY	4	33.600	40.900	1.5	1.5	2.0	6.850	6.150	1.900	0.700
OPERATING ENGINEER		HWY	5	32.150	40.900	1.5	1.5	2.0	6.850	6.150	1.900	0.700
PAINTER		ALL		29.650	30.650	1.5	1.5	1.5	5.650	5.750	0.000	0.350
PILEDRIIVER		BLD		28.040	31.120	1.5	1.5	2.0	6.100	8.220	0.000	0.600
PILEDRIIVER		HWY		27.440	29.190	1.5	1.5	2.0	6.300	7.680	0.000	0.400
PIPEFITTER		BLD		33.700	36.060	1.5	1.5	2.0	6.430	7.130	0.000	0.630
PLASTERER		BLD		29.540	32.490	2.0	2.0	2.0	5.500	7.350	0.000	0.100
PLUMBER		BLD		33.700	36.060	1.5	1.5	2.0	6.430	7.130	0.000	0.630
ROOFER		BLD		33.650	35.650	1.5	1.5	2.0	6.460	3.310	0.000	0.330
SHEETMETAL WORKER		BLD		31.690	33.620	1.5	1.5	2.0	4.850	10.29	0.520	0.290
SPRINKLER FITTER		BLD		31.240	33.240	1.5	1.5	2.0	6.500	5.350	0.000	0.250
STONE MASON		BLD		30.000	32.500	1.5	1.5	2.0	5.500	8.680	0.000	0.420
TERRAZZO FINISHER		BLD		24.860	0.000	1.5	1.5	2.0	5.500	4.000	0.000	0.360
TERRAZZO MASON		BLD		28.140	28.390	1.5	1.5	2.0	5.500	5.220	0.000	0.380
TILE LAYER		BLD		27.040	30.010	1.5	1.5	2.0	6.100	8.220	0.000	0.600
TILE MASON		BLD		28.140	28.390	1.5	1.5	2.0	5.500	5.220	0.000	0.380
TRUCK DRIVER		ALL	1	25.880	26.430	1.5	1.5	2.0	5.150	6.500	0.000	0.000
TRUCK DRIVER		ALL	2	26.030	26.430	1.5	1.5	2.0	5.150	6.500	0.000	0.000
TRUCK DRIVER		ALL	3	26.230	26.430	1.5	1.5	2.0	5.150	6.500	0.000	0.000
TRUCK DRIVER		ALL	4	26.430	26.430	1.5	1.5	2.0	5.150	6.500	0.000	0.000
TUCKPOINTER		BLD		30.000	32.500	1.5	1.5	2.0	5.500	8.680	0.000	0.420

Legend :

M-F>8 (Overtime is required for any hour greater than 8 worked each day, Monday through Friday.)

OSA (Overtime is required for every hour worked on Saturday)

OSH (Overtime is required for every hour worked on Sunday and Holidays)

H/W (Health & Welfare Insurance)

Pensn (Pension)

Vac (Vacation)

Trng (Training)

## Explanations

### STEPHENSON COUNTY

The following list is considered as those days for which holiday rates of wages for work performed apply: New Years Day, Memorial/Decoration Day, Fourth of July, Labor Day, Veterans Day, Thanksgiving Day, Christmas Day. Generally, any of these holidays which fall on a Sunday is celebrated on the following Monday. This then makes work performed on that Monday payable at the appropriate overtime rate for holiday pay. Common practice in a given local may alter certain days of celebration such as the day after Thanksgiving for Veterans Day. If in doubt, please check with IDOL.

### EXPLANATION OF CLASSES

ASBESTOS - GENERAL - removal of asbestos material/mold and hazardous materials from any place in a building, including mechanical systems where those mechanical systems are to be removed. This includes the removal of asbestos materials/mold and hazardous materials from ductwork or pipes in a building when the building is to be demolished at the time or at some close future date.

ASBESTOS - MECHANICAL - removal of asbestos material from mechanical systems, such as pipes, ducts, and boilers, where the mechanical systems are to remain.

### CERAMIC TILE FINISHER, MARBLE FINISHER, TERRAZZO FINISHER

Assisting, helping or supporting the tile, marble and terrazzo mechanic by performing their historic and traditional work assignments required to complete the proper installation of the work covered by said crafts. The term "Ceramic" is used for naming the classification only and is in no way a limitation of the product handled. Ceramic takes into consideration most hard tiles.

### COMMUNICATIONS TECHNICIAN

Installing, manufacturing, assembling and maintaining sound and intercom, protection alarm (security), fire alarm, master antenna television, closed circuit television, low voltage control for computers and/or door monitoring, school communications systems, telephones and servicing of nurse and emergency calls, and the installation and maintenance of transmit and receive antennas, transmitters, receivers, and associated apparatus which operates in conjunction with above systems. All work associated with these system installations will be included EXCEPT the installation of

protective metallic conduit in new construction projects (excluding less than ten-foot, runs strictly for protection of cable) and 120 volt AC (or higher) power wiring and associated hardware.

#### LABORER, SKILLED - HIGHWAY

Individuals engaged in the following types of work, irrespective of the site of the work: asbestos abatement worker, handling of any materials with any foreign matter harmful to skin or clothing, track laborer, cement handlers, chloride handlers, the unloading and loading with steel workers and re-bars, concrete workers wet, tunnel helpers in free air, batch dumpers, mason tenders, kettle and tar men, tank cleaners, plastic installers, scaffold workers, motorized buggies or motorized unit used for wet concrete or handling of building materials, laborers with de-watering systems, sewer workers plus depth, rod and chainmen with technical engineers, rod and chainmen with land surveyors, rod and chainmen with surveyors, vibrator operators, cement silica, clay, fly ash, lime and plasters, handlers (bulk or bag), cofferdam workers plus depth, on concrete paving, placing, cutting and tying of reinforcing, deck hand, dredge hand, and shore laborers, bankmen on floating plant, grade checker, power tools, front end man on chip spreaders, cession workers plus depth, gunnite nozzle men, lead man on sewer work, welders, cutters, burners and torchmen, chainsaw operators, jackhammer and drill operators, layout man and/or drainage tile layer, steel form setter - street and highway, air tamping hammermen, signal man on crane, concrete saw operator, screedman on asphalt pavers, laborers tending masons with hot material or where foreign materials are used, mortar mixer operators, multiple concrete duct - leadsman, lumen, asphalt raker, curb asphalt machine operator, ready mix scalemen (permanent, portable or temporary plant), laborers handling masterplate or similar materials, laser beam operator, concrete burning machine operator, coring machine operator, plaster tender, underpinning and shoring of buildings, pump men, manhole and catch basin, dirt and stone tamper, hose men on concrete pumps, hazardous waste worker, lead base paint abatement worker, lining of pipe, refusing machine, assisting on direct boring machine, the work of laying watermain, fire hydrants, all mechanical joints to watermain work, sewer worker, and tapping water service and forced lift station mechanical worker.

#### TRUCK DRIVER - BUILDING, HEAVY AND HIGHWAY CONSTRUCTION

Class 1. Two or three Axle Trucks. A-frame Truck when used for transportation purposes; Air Compressors and Welding Machines, including those pulled by cars, pick-up trucks and tractors; Ambulances; Batch Gate Lockers; Batch Hopperman; Car and Truck Washers; Carry-alls; Fork Lifts and Hoisters; Helpers; Mechanics Helpers and Greasers; Oil Distributors 2-man operation; Pavement Breakers; Pole Trailer, up to 40 feet; Power Mower Tractors; Self-propelled Chip Spreader; Skipman; Slurry Trucks, 2-man operation; Slurry Truck Conveyor Operation, 2 or 3 man; Teamsters; Unskilled dumpman; and Truck Drivers hauling warning lights, barricades, and portable toilets on the job site.

Class 2. Four axle trucks; Dump Crets and Adgetors under 7 yards; Dumpsters, Track Trucks, Euclids, Hug Bottom Dump Turnapulls or Turnatrailers when pulling other than self-loading equipment or similar equipment under 16 cubic yards; Mixer Trucks under 7 yards; Ready-mix Plant Hopper Operator, and Winch Trucks, 2 Axles.

Class 3. Five axle trucks; Dump Crets and Adgetors 7 yards and over; Dumpsters, Track Trucks, Euclids, Hug Bottom Dump Turnatrailers or turnapulls when pulling other than self-loading equipment or similar

equipment over 16 cubic yards; Explosives and/or Fission Material Trucks; Mixer Trucks 7 yards or over; Mobile Cranes while in transit; Oil Distributors, 1-man operation; Pole Trailer, over 40 feet; Pole and Expandable Trailers hauling material over 50 feet long; Slurry trucks, 1-man operation; Winch trucks, 3 axles or more; Mechanic--Truck Welder and Truck Painter.

Class 4. Six axle trucks; Dual-purpose vehicles, such as mounted crane trucks with hoist and accessories; Foreman; Master Mechanic; Self-loading equipment like P.B. and trucks with scoops on the front.

#### OPERATING ENGINEERS - BUILDING

Class 1. Assistant Craft Foreman; Craft Foreman; Mechanic; Asphalt Plant; Asphalt Spreader; Autograde; Batch Plant; Benoto (requires Two Engineers); Boiler and Throttle Valve; Caisson Rigs; Central Redi-Mix Plant; Combination Back Hoe Front End-loader Machine; Compressor and Throttle Valve; Concrete Breaker (Truck Mounted); Concrete Conveyor; Concrete Paver; Concrete Placer; Concrete Pump (Truck Mounted); Concrete Tower, Cranes, All, Cranes, Hammerhead, Creter Crane; Crusher, Stone, etc.; Derricks, All; Derricks, Traveling; Formless Curb and Gutter Machine; Grader, Elevating; Grouting Machines; Highlift Shovels or Front Endloader 2-1/4 yd. and over; Hoists, Elevators, outside type rack and pinion and similar machines; Hoists, one, two and three Drum; Hoists, Two tigger One Floor; Hydraulic Backhoes; Hydraulic Boom Trucks; Locomotives, All; Motor Patrol; Pile Drivers and Skid Rig; Post Hole Digger; Pre-Stress Machine; Pump Cretes; Squeeze Cretes-screw Type Pumps; Gypsum Bulker and Pump; Raised and Blind Hole Drill; Rock Drill; Roto Mill Grinder; Scoops - Tractor Drawn; Slip-form Paver; Straddle Buggies; Tie Back Machine; Tractor with Book and Side Boom; Trenching Machines.

Class 2. Bobcat (over 3/4 cu. yd.); Boilers Brick Forklift; Broom, All Power Propelled; Bulldozers; Concrete Mixer (Two Bag and Over); Conveyor, Portable; Forklift Trucks; Greaser Engineer; Highlift Shovels or Front Endloaders under 2-1/4 yd.; Hoists, Automatic; Hoists, Sewer Dragging Machine; Hoists, Tigger Single Drum; Rollers, All; Steam Generators; Tractors, All; Tractor Drawn Vibratory Roller; Winch Trucks with "A" Frame.

Class 3. Air Compressor; Asphalt Spreader; Combination - Small Equipment Operator; Generators; Heaters, Mechanical; Hoists, Inside Elevators - (Rheostat Manual Controlled); Hydraulic Power Units (Pile Driving and Extracting); Pumps, over 3" (1 to 3 not to exceed a total of 300 ft.); Pumps, Well Points; Welding Machines (2 through 5); Winches, 4 small Electric Drill Winches; Bobcat (up to and including 3/4 cu. yd.).

Class 4. Hoists, Inside Elevators, Push Button with Automatic Doors; Oilers; Brick Forklift.

#### OPERATING ENGINEERS - HEAVY AND HIGHWAY CONSTRUCTION

Class 1. Craft Foreman; Asphalt Plant, Asphalt Heater and Planer Combination; Asphalt Heater Scarfire; Asphalt Silo Tender; Asphalt Spreader; Autograder; ABG Paver; Backhoes with Caisson attachment; Ballast Regulator, Belt Loader; Caisson Rigs; Car Dumper; Central Redi-Mix Plant; Backhoe w/shear attachments; Combination Backhoe Front Endloader Machine, (1 cu. yd. Backhoe Bucket or over or with attachments); Concrete Breaker (Truck Mounted); Concrete Conveyor; Concrete Paver over 27E cu. ft.; Concrete Placer; Concrete Tube Float; Cranes, all attachments; Cranes, Hammerhead, Linden, Peco & Machines of a like nature; Crete Crane; Crusher, Stone, etc.; Derricks, All; Derrick Boats; Derricks, Traveling; Directional Boring Machine over

12"; Dredges; Field Mechanic-Welder; Formless Curb and Gutter Machine; Gradall and Machines of a like nature; Grader, Elevating; Grader, Motor Grader, Motor Patrol, Auto Patrol, Form Grader, Pull Grader, Subgrader; Guard Rail Post Driver Mounted; Hoists, One, Two and Three Drum; Hydraulic Backhoes; Pile Drivers and Skid Rig; Pre-Stress Machine; Pump Cretes Dual Ram; Rock Drill - Crawler or Skid Rig; Rock Drill - Truck Mounted; Rock/Track Tamper; Roto Mill Grinder; Slip-Form Paver; Soil Test Drill Rig (Truck Mounted); Straddle Buggies; GCI Crane; Hydraulic Telescoping form (Tunnel); Tie Back Machine; Tractor Drawn Belt Loader; Tractor with Boom; Tractor-aire with Attachments; Traffic Barrier conveyor machine; Raised or Blind Hole; Trenching Machine; Truck Mounted Concrete Pump with Boom; Truck Mounted Concrete Conveyor; Underground Boring and/or Mining Machines; Wheel Excavator; Widener (APSCO).

Class 2. Batch Plant; Bituminous Mixer; Boiler and Throttle Valve; Bulldozers; Car Loader Trailing Conveyors; Combination Backhoe Front Endloader Machine (less than 1 cu. yd. Backhoe Bucket or over or with attachments); Compressor and Throttle Valve; Compressor, Common Receiver (3); Concrete Breaker or Hydro Hammer; Concrete Grinding Machine; Concrete Mixer or Paver 7S Series to and including 27 cu. ft.; Concrete Spreader; Concrete Curing Machine, Burlap Machine, Belting Machine and Sealing Machine; Conveyor Muck Cars (Haglund or Similar Type); Drills, all; Finishing Machine - Concrete; Greaser Engineer; Highlift Shovels or Front Endloader; Hoist - Sewer Dragging Machine; Hydraulic Boom Trucks (All Attachments); Hydro Blaster; Laser Screed; All Locomotives, Dinky; Pump Cretes; Squeeze Cretes-Screw Type Pumps, Gypsum Bulker and Pump; Roller, Asphalt; Rotary Snow Plows; Rototiller, Seaman, etc., self-propelled; Scoops - Tractor Drawn; Self-Propelled Compactor; Spreader - Chip - Stone, etc.; Scraper; Scraper - Prime Mover in Tandem (Regardless of Size); Tank Car Heater; Tractors, Push, Pulling Sheeps Foot, Disc, Compactor, etc. Tug Boats.

Class 3. Boilers; Brooms, All Power Propelled; Cement Supply Tender; Compressor, Common Receiver (2); Concrete Mixer (Two Bag and Over); Conveyor, Portable; Farm-Type Tractors Used for Mowing, Seeding, etc.; Fireman on Boilers; Forklift Trucks; Grouting Machine; Hoists, Automatic; Hoists, All Elevators; Hoists, Tugger Single Drum; Jeep Diggers, Low Boys; Pipe Jacking Machines; Post-Hole Digger; Power Saw, Concrete Power Driven; Pug Mills; Rollers, other than asphalt; Seed and Straw Blower; Steam Generators; Stump Machine; Winch Trucks with "A" Frame; Work Boats; Tamper - Form-Motor Driven.

Class 4. Air Compressor - Small and Large; Asphalt Spreader, Backend Man; Bobcat (Skid Steer) all; Combination - Small Equipment Operator; Directional Boring Machine up to 12"; Generators - Small 50kw and Under; Generators - Large over 50kw; Heaters, Mechanical; Hydraulic Power Unit (Pile Driving, Extracting, or Drilling); Hydro-Blaster; Light Plants, All (1 through 5); Pumps, over 3" (1 to 3 not to exceed a total of 300 ft.); Pumps, Well Points; Tract-aire; Welding Machines (2 through 5); Winches, 4 Small Electric Drill Winches.

Class 5. Oilers and Directional Boring Machine Locator.  
Other Classifications of Work:

For definitions of classifications not otherwise set out, the Department generally has on file such definitions which are available. If a task to be performed is not subject to one of the classifications of pay set out, the Department will upon being contacted state which neighboring county has such a classification and provide such rate, such rate being deemed to exist by reference in this document. If no neighboring county rate applies to the task, the Department shall undertake a special determination, such special

determination being then deemed to have existed under this determination. If a project requires these, or any classification not listed, please contact IDOL at 618/993-7271 for wage rates or clarifications.

#### LANDSCAPING

Landscaping work falls under the existing classifications for laborer, operating engineer and truck driver. The work performed by landscape plantsman and landscape laborer is covered by the existing classification of laborer. The work performed by landscape operators (regardless of equipment used or its size) is covered by the classifications of operating engineer. The work performed by landscape truck drivers (regardless of size of truck driven) is covered by the classifications of truck driver.

# Tazewell County Prevailing Wage for April 2007

Trade Name	RG	TYP	C	Base	FRMAN	*M-F>8	OSA	OSH	H/W	Pensn	Vac	Trng
=====	==	===	=	=====	=====	=====	===	===	=====	=====	=====	=====
ASBESTOS ABT-GEN	NW	BLD		22.980	24.480	1.5	1.5	2.0	5.850	8.410	0.000	0.750
ASBESTOS ABT-GEN	NW	HWY		24.540	25.290	1.5	1.5	2.0	5.850	8.410	0.000	0.750
ASBESTOS ABT-GEN	SE	BLD		23.290	24.040	1.5	1.5	2.0	5.300	7.030	0.000	0.600
ASBESTOS ABT-MEC		BLD		23.300	24.800	1.5	1.5	2.0	7.860	4.910	0.000	0.000
BOILERMAKER		BLD		30.970	33.970	2.0	2.0	2.0	8.270	7.740	0.000	0.300
BRICK MASON		BLD		27.020	28.520	1.5	1.5	2.0	5.500	6.350	0.000	0.390
CARPENTER	N	BLD		25.980	27.980	1.5	1.5	2.0	6.500	7.150	0.000	0.320
CARPENTER	N	HWY		25.910	27.910	1.5	1.5	2.0	6.500	8.100	0.000	0.320
CARPENTER	S	BLD		26.210	28.210	1.5	1.5	2.0	6.500	6.920	0.000	0.320
CARPENTER	S	HWY		27.090	29.090	1.5	1.5	2.0	6.500	6.920	0.000	0.320
CEMENT MASON		BLD		23.120	24.870	1.5	1.5	2.0	5.290	10.00	0.000	0.500
CEMENT MASON		HWY		24.140	25.140	1.5	1.5	2.0	5.290	10.00	0.000	0.500
CERAMIC TILE FNSHER		BLD		24.910	0.000	1.5	1.5	2.0	5.500	6.350	0.000	0.380
ELECTRIC PWR EQMT OP		ALL		30.750	0.000	1.5	1.5	2.0	4.750	8.610	0.000	0.000
ELECTRIC PWR GRNDMAN		ALL		21.090	0.000	1.5	1.5	2.0	4.750	5.905	0.000	0.000
ELECTRIC PWR LINEMAN		ALL		34.160	36.350	1.5	1.5	2.0	4.750	9.560	0.000	0.000
ELECTRIC PWR TRK DRV		ALL		22.130	0.000	1.5	1.5	2.0	4.750	6.200	0.000	0.000
ELECTRICIAN		BLD		29.860	31.860	1.5	1.5	2.0	5.150	8.060	0.000	0.250
ELECTRONIC SYS TECH		BLD		23.850	25.350	1.5	1.5	2.0	5.150	5.625	0.000	0.250
ELEVATOR CONSTRUCTOR		BLD		34.190	38.460	2.0	2.0	2.0	8.275	6.060	2.050	0.000
GLAZIER		BLD		26.320	27.070	1.5	1.5	2.0	5.650	5.750	0.000	0.350
HT/FROST INSULATOR		BLD		34.750	36.500	1.5	1.5	2.0	8.260	9.110	0.000	0.310
IRON WORKER		BLD		24.960	26.710	1.5	1.5	2.0	8.040	7.410	0.000	0.400
IRON WORKER		HWY		25.920	27.420	1.5	1.5	2.0	8.040	7.410	0.000	0.350
LABORER	NW	BLD		21.980	23.480	1.5	1.5	2.0	5.850	8.410	0.000	0.600
LABORER	NW	HWY		23.790	24.540	1.5	1.5	2.0	5.850	8.410	0.000	0.600
LABORER	SE	BLD		23.290	24.040	1.5	1.5	2.0	5.300	7.030	0.000	0.600
LABORER	SE	HWY		24.150	25.150	1.5	1.5	2.0	5.300	7.030	0.000	0.600
LATHER		BLD		25.980	27.980	1.5	1.5	2.0	6.500	7.150	0.000	0.320
MACHINERY MOVER		HWY		25.920	27.420	1.5	1.5	2.0	8.040	7.410	0.000	0.350
MACHINIST		BLD		36.890	38.890	2.0	2.0	2.0	4.380	5.650	2.550	0.000
MARBLE FINISHERS		BLD		24.910	0.000	1.5	1.5	2.0	5.500	6.350	0.000	0.380
MARBLE MASON		BLD		26.520	27.770	1.5	1.5	2.0	5.500	6.350	0.000	0.380
MILLWRIGHT		BLD		26.620	28.620	1.5	1.5	2.0	6.500	6.850	0.000	0.320
MILLWRIGHT		HWY		27.010	29.010	1.5	1.5	2.0	6.500	6.450	0.000	0.320
OPERATING ENGINEER		BLD	1	27.840	30.840	1.5	1.5	2.0	5.900	8.000	0.000	0.900
OPERATING ENGINEER		BLD	2	25.940	30.840	1.5	1.5	2.0	5.900	8.000	0.000	0.900
OPERATING ENGINEER		BLD	3	24.560	30.840	1.5	1.5	2.0	5.900	8.000	0.000	0.900
OPERATING ENGINEER		HWY	1	29.110	32.110	1.5	1.5	2.0	6.250	9.000	0.000	1.000
OPERATING ENGINEER		HWY	2	26.730	32.110	1.5	1.5	2.0	6.250	9.000	0.000	1.000
OPERATING ENGINEER		HWY	3	22.790	32.110	1.5	1.5	2.0	6.250	9.000	0.000	1.000
PAINTER		ALL		26.850	27.850	1.5	1.5	1.5	5.650	5.750	0.000	0.350
PAINTER SIGNS		BLD		28.970	32.520	1.5	1.5	1.5	2.600	2.310	0.000	0.000
PILEDRIVER	N	BLD		26.480	28.480	1.5	1.5	2.0	6.500	7.150	0.000	0.320
PILEDRIVER	N	HWY		26.910	28.910	1.5	1.5	2.0	6.500	8.100	0.000	0.320
PILEDRIVER	S	BLD		26.710	28.710	1.5	1.5	2.0	6.500	6.920	0.000	0.320
PILEDRIVER	S	HWY		27.090	29.090	1.5	1.5	2.0	6.500	6.920	0.000	0.320
PIPEFITTER		BLD		31.630	35.110	1.5	1.5	2.0	6.450	7.680	0.000	0.420
PLASTERER		BLD		23.400	24.650	1.5	1.5	2.0	5.290	9.800	0.000	0.500
PLUMBER		BLD		28.390	30.950	1.5	1.5	2.0	6.450	8.990	0.000	0.800
ROOFER		BLD		24.200	25.200	1.5	1.5	2.0	5.350	6.550	0.000	0.150
SHEETMETAL WORKER		BLD		27.740	29.130	1.5	1.5	2.0	5.670	9.310	0.000	0.310
SIGN HANGER		HWY		25.920	27.420	1.5	1.5	2.0	8.040	7.410	0.000	0.350
SPRINKLER FITTER		BLD		31.240	33.240	1.5	1.5	2.0	6.500	5.350	0.000	0.250
STEEL ERECTOR		HWY		25.920	27.420	1.5	1.5	2.0	8.040	7.410	0.000	0.350
STONE MASON		BLD		27.020	28.520	1.5	1.5	2.0	5.500	6.350	0.000	0.390
TERRAZZO FINISHER		BLD		24.910	0.000	1.5	1.5	2.0	5.500	6.350	0.000	0.380
TERRAZZO MASON		BLD		26.520	27.770	1.5	1.5	2.0	5.500	6.350	0.000	0.380

TILE MASON	BLD	26.520	27.770	1.5	1.5	2.0	5.500	6.350	0.000	0.380
TRUCK DRIVER	ALL 1	25.787	0.000	1.5	1.5	2.0	7.250	3.317	0.000	0.000
TRUCK DRIVER	ALL 2	26.187	0.000	1.5	1.5	2.0	7.250	3.317	0.000	0.000
TRUCK DRIVER	ALL 3	26.387	0.000	1.5	1.5	2.0	7.250	3.317	0.000	0.000
TRUCK DRIVER	ALL 4	26.637	0.000	1.5	1.5	2.0	7.250	3.317	0.000	0.000
TRUCK DRIVER	ALL 5	27.387	0.000	1.5	1.5	2.0	7.250	3.317	0.000	0.000
TRUCK DRIVER	O&C 1	20.630	0.000	1.5	1.5	2.0	7.250	3.317	0.000	0.000
TRUCK DRIVER	O&C 2	20.950	0.000	1.5	1.5	2.0	7.250	3.317	0.000	0.000
TRUCK DRIVER	O&C 3	21.110	0.000	1.5	1.5	2.0	7.250	3.317	0.000	0.000
TRUCK DRIVER	O&C 4	21.310	0.000	1.5	1.5	2.0	7.250	3.317	0.000	0.000
TRUCK DRIVER	O&C 5	21.910	0.000	1.5	1.5	2.0	7.250	3.317	0.000	0.000
TUCKPOINTER	BLD	27.020	28.520	1.5	1.5	2.0	5.500	6.350	0.000	0.390

Legend:

M-F>8 (Overtime is required for any hour greater than 8 worked each day, Monday through Friday.)

OSA (Overtime is required for every hour worked on Saturday)

OSH (Overtime is required for every hour worked on Sunday and Holidays)

H/W (Health & Welfare Insurance)

Pensn (Pension)

Vac (Vacation)

Trng (Training)

## Explanations

TAZEWELL COUNTY

ASBESTOS - See Laborers

CARPENTERS (NORTH) - That part of the county North including the towns of Marquette Hts., Morton, Creve Coeur and Deer Creek.

LABORERS (NORTHWEST) - The area bounded by the old city limits of East Peoria.

MILLWRIGHTS - See Carpenters

PILEDRIVERS - See Carpenters

The following list is considered as those days for which holiday rates of wages for work performed apply: New Years Day, Memorial/Decoration Day, Fourth of July, Labor Day, Veterans Day, Thanksgiving Day, Christmas Day. Generally, any of these holidays which fall on a Sunday is celebrated on the following Monday. This then makes work performed on that Monday payable at the appropriate overtime rate for holiday pay. Common practice in a given local may alter certain days of celebration such as the day after Thanksgiving for Veterans Day. If in doubt, please check with IDOL.

Oil and chip resealing (O&C) means the application of road oils and liquid asphalt to coat an existing road surface, followed by application of aggregate chips or gravel to coated surface, and subsequent rolling of material to seal the surface.



## EXPLANATION OF CLASSES

ASBESTOS - GENERAL - removal of asbestos material/mold and hazardous materials from any place in a building, including mechanical systems where those mechanical systems are to be removed. This includes the removal of asbestos materials/mold and hazardous materials from ductwork or pipes in a building when the building is to be demolished at the time or at some close future date.

ASBESTOS - MECHANICAL - Removal of asbestos material from mechanical systems, such as pipes, ducts, and boilers, where the mechanical systems are to remain.

### CERAMIC TILE FINISHER, MARBLE FINISHER, TERRAZZO FINISHER

Assisting, helping or supporting the tile, marble and terrazzo mechanic by performing their historic and traditional work assignments required to complete the proper installation of the work covered by said crafts. The term "Ceramic" is used for naming the classification only and is in no way a limitation of the product handled. Ceramic takes into consideration most hard tiles.

### ELECTRONIC SYSTEMS TECHNICIAN

Installation, service and maintenance of low-voltage systems which utilizes the transmission and/or transference of voice, sound, vision, or digital for commercial, education, security and entertainment purposes for the following: TV monitoring and surveillance, background/foreground music, intercom and telephone interconnect, field programming, inventory control systems, microwave transmission, multi-media, multiplex, radio page, school, intercom and sound burglar alarms and low voltage master clock systems.

Excluded from this classification are energy management systems, life safety systems, supervisory controls and data acquisition systems not intrinsic with the above listed systems, fire alarm systems, nurse call systems and raceways exceeding fifteen feet in length.

### TRUCK DRIVER - BUILDING, HEAVY AND HIGHWAY CONSTRUCTION

Class 1. Drivers on 2 axle trucks hauling less than 9 ton. Air compressor and welding machines and brooms, including those pulled by separate units, truck driver helpers, warehouse employees, mechanic helpers, greasers and tiremen, pickup trucks when hauling materials, tools, or workers to and from and on-the-job site, and fork lifts up to 6,000 lb. capacity.

Class 2. Two or three axle trucks hauling more than 9 ton but hauling less than 16 ton. A-frame winch trucks, hydrolift trucks, vector trucks or similar equipment when used for transportation purposes. Fork lifts over 6,000 lb. capacity, winch trucks, four axle combination units, and ticket writers.

Class 3. Two, three or four axle trucks hauling 16 ton or more. Drivers on water pulls, articulated dump trucks, mechanics and working forepersons, and dispatchers. Five axle or more combination units.

Class 4. Low Boy and Oil Distributors.

Class 5. Drivers who require special protective clothing while employed on hazardous waste work.

### TRUCK DRIVER - OIL AND CHIP RESEALING ONLY.

This shall encompass laborers, workers and mechanics who drive contractor or subcontractor owned, leased, or hired pickup, dump, service, or oil distributor trucks. The work includes transporting materials and equipment (including but not limited to, oils, aggregate supplies, parts, machinery and tools) to or from the job site; distributing oil or liquid asphalt and aggregate; stock piling material when in connection with the actual oil and chip contract. The Truck Driver (Oil & Chip Resealing) wage classification does not include supplier delivered materials.

#### OPERATING ENGINEERS - BUILDING

Class 1. Cranes; Overhead Cranes; Gradall; All Cherry Pickers; Mechanics; Central Concrete Mixing Plant Operator; Road Pavers (27E - Dual Drum - Tri Batchers); Blacktop Plant Operators and Plant Engineers; 3 Drum Hoist; Derricks; Hydro Cranes; Shovels; Skimmer Scoops; Koehring Scooper; Drag Lines; Backhoe; Derrick Boats; Pile Drivers and Skid Rigs; Clamshells; Locomotive Cranes; Dredge (all types) Motor Patrol; Power Blades - Dumore - Elevating and similar types; Tower Cranes (Crawler-Mobile) and Stationary; Crane-type Backfiller; Drott Yumbo and similar types considered as Cranes; Caisson Rigs; Dozer; Tournadozer; Work Boats; Ross Carrier; Helicopter; Tournapulls - all and similar types; Scoops (all sizes); Pushcats; Endloaders (all types); Asphalt Surfacing Machine; Slip Form Paver; Rock Crusher; Heavy Equipment Greaser; CMI, CMI Belt Placer, Auto Grade & 3 Track and similar types; Side Booms; Multiple Unit Earth Movers; Creter Crane; Trench Machine; Pump-crete-Belt Crete-Squeeze Cretes-Screw-type Pumps and Gypsum; Bulker & Pump - Operator will clean; Formless Finishing Machine; Flaherty Spreader or similar types; Screed Man on Laydown Machine; Wheel Tractors (industrial or Farm-type w/Dozer-Hoe-Endloader or other attachments); F.W.D. & Similar Types; Vermeer Concrete Saw.

Class 2. Dinkeys; Power Launches; PH One-pass Soil Cement Machine (and similar types); Pugmill with Pump; Backfillers; Euclid Loader; Forklifts; Jeeps w/Ditching Machine or other attachments; Tuneluger; Automatic Cement and Gravel Batching Plants; Mobile Drills (Soil Testing) and similar types; Gurries and Similar Types; (1) and (2) Drum Hoists (Buck Hoist and Similar Types); Chicago Boom; Boring Machine & Pipe Jacking Machine; Hydro Boom; Dewatering System; Straw Blower; Hydro Seeder; Assistant Heavy Equipment Greaser on Spread; Tractors (Track type) without Power Unit pulling Rollers; Rollers on Asphalt -- Brick Macadem; Concrete Breakers; Concrete Spreaders; Mule Pulling Rollers; Center Stripper; Cement Finishing Machines & CMI Texture & Reel Curing Machines; Cement Finishing Machine; Barber Green or similar loaders; Vibro Tamper (All similar types) Self-propelled; Winch or Boom Truck; Mechanical Bull Floats; Mixers over 3 Bag to 27E; Tractor pulling Power Blade or Elevating Grader; Porter Rex Rail; Clary Screed; Truck Type Hoptoe Oilers; Fireman; Spray Machine on Paving; Curb Machines; Truck Crane Oilers; Oil Distributor; Truck-Mounted Saws.

Class 3. Air Compressor; Power Subgrader; Straight Tractor; Trac Air without attachments; Herman Nelson Heater, Dravo, Warner, Silent Glo, and similar types; Roller: Five (5) Ton and under on Earth or Gravel; Form Grader; Crawler Crane & Skid Rig Oilers; Freight Elevators - permanently installed; Pump; Light Plant; Generator; Conveyor (1) or (2) - Operator will clean; Welding Machine; Mixer (3) Bag and Under (Standard Capacity with skip); Bulk Cement Plant; Oiler on Central Concrete Mixing Plant.

#### OPERATING ENGINEERS - HEAVY AND HIGHWAY CONSTRUCTION

Class 1. Cranes; Hydro Crane; Shovels; Crane Type Backfiller; Tower Cranes - Mobile & Crawler & Stationary; Derricks & Hoists (3 Drum); Draglines; Drott Yumbo & similar types considered as Cranes; Back Hoe; Derrick Boats; Pile Driver and Skid Rigs; Clam Shell; Locomotive - Cranes; Road Pavers - Single Drum - Dual Drum - Tri Batcher; Motor Patrols & Power Blades - Dumore - Elevating & Similar Types; Mechanics; Central Concrete Mixing Plant Operator; Asphalt Batch Plant Operators and Plant Engineers; Gradall; Caisson Rigs; Skimmer Scoop - Koering Scooper; Dredges (all types); Hoptoe; All Cherry Pickers; Work Boat; Ross Carrier; Helicopter; Dozer; Tournadozer; Tournapulls - all and similar types; Multiple Unit Earth Movers; Scoops (all sizes); Pushcats; Endloaders (all types); Asphalt Surfacing Machine; Slip Form Paver; Rock Crusher; Heavy Equipment Greaser (top greaser on spread); CMI, Auto Grade, CMI Belt Placer & 3 Track and similar types; Side Booms; Starting Engineer on Pipeline; Asphalt Heater & Planer Combination (used to plane streets); Wheel Tractors (with dozer, hoe or endloader attachments); F.W.D. and Similar types; Blaw Knox Spreader and Similar types; Trench Machines; Pump Crete - Belt Crete - Squeeze Crete - screw type pumps and gypsum (operator will clean); Formless Finishing Machines; Flaherty Spreader or similar types; Screed Man on Laydown Machine; Vermeer Concrete Saw.

Class 2. Bulker & Pump; Power Launches; Boring Machine & Pipe Jacking Machine; Dinkeys; P-H One Pass Soil Cement Machines and similar types; Wheel Tractors (Industry or farm type - other); Back Fillers; Euclid Loader; Fork Lifts; Jeep w/Ditching Machine or other attachments; Tunneluger; Automatic Cement & Gravel Batching Plants; Mobile Drills - Soil Testing and similar types; Pugmill with pump; All (1) and (2) Drum Hoists; Dewatering System; Straw Blower; Hydro-Seeder; Boring Machine; Hydro-Boom; Bump Grinders (self-propelled); Assistant Heavy Equipment Greaser; Apsco Spreader; Tractors (track-type) without Power Units Pulling Rollers on Asphalt - Brick or Macadam; Concrete Breakers; Concrete Spreaders; Cement Strippers; Cement Finishing Machines & CMI Texture & Reel Curing Machines; Vibro-Tampers (all similar types self-propelled); Mechanical Bull Floats; Self-propelled Concrete Saws; Mixers-over three (3) bags to 27E; Winch and Boom Trucks; Tractor Pulling Power Blade or Elevating Grader; Porter Rex Rail; Clary Screed; Mule Pulling Rollers; Pugmill without Pump; Barber Greene or similar Loaders; Track Type Tractor w/Power Unit attached (minimum); Fireman; Spray Machine on Paving; Curb Machines; Paved Ditch Machine; Power Broom; Self-Propelled Conveyors; Power Subgrader; Oil Distributor; Straight Tractor; Truck Crane Oiler; Truck Type Oilers; Directional boring machine; Horizontal directional drill.

Class 3. Straight framed articulating end dump vehicles and Truck mounted vac unit (separately powered); Trac Air Machine (without attachments); Herman Nelson Heater, Dravo Warner, Silent Glo & similar types; Rollers - five ton and under on earth and gravel; Form Graders; Pumps; Light Plant; Generator; Air Compressor (1) or (2); Conveyor; Welding Machine; Mixer - 3 bags and under; Bulk Cement Plant; Oilers.

Other Classifications of Work:

For definitions of classifications not otherwise set out, the Department generally has on file such definitions which are available. If a task to be performed is not subject to one of the classifications of pay set out, the Department will upon being contacted state which neighboring county has such a classification and provide such rate, such rate being deemed to exist by reference in this document. If no neighboring county rate applies to the task,

the Department shall undertake a special determination, such special determination being then deemed to have existed under this determination. If a project requires these, or any classification not listed, please contact IDOL at 618/993-7271 for wage rates or clarifications.

#### LANDSCAPING

Landscaping work falls under the existing classifications for laborer, operating engineer and truck driver. The work performed by landscape plantsman and landscape laborer is covered by the existing classification of laborer. The work performed by landscape operators (regardless of equipment used or its size) is covered by the classifications of operating engineer. The work performed by landscape truck drivers (regardless of size of truck driven) is covered by the classifications of truck driver.

# Union County Prevailing Wage for April 2007

Trade Name	RG	TYP	C	Base	FRMAN	*M-F>8	OSA	OSH	H/W	Pensn	Vac	Trng
=====	==	==	=	=====	=====	=====	=====	=====	=====	=====	=====	=====
ASBESTOS ABT-GEN		ALL		20.750	21.200	1.5	1.5	2.0	5.250	5.600	0.000	0.700
ASBESTOS ABT-MEC		BLD		25.290	26.290	1.5	1.5	2.0	4.450	2.500	0.000	0.250
BOILERMAKER		BLD		28.500	31.000	1.5	1.5	2.0	6.820	11.03	0.000	0.300
BRICK MASON		BLD		25.470	26.970	1.5	1.5	2.0	6.000	5.400	0.000	0.425
CARPENTER		BLD		27.780	29.280	1.5	1.5	2.0	5.050	3.750	0.000	0.350
CARPENTER		HWY		27.730	29.230	1.5	1.5	2.0	5.050	3.750	0.000	0.350
CEMENT MASON		BLD		23.500	24.500	1.5	1.5	2.0	5.200	3.550	0.000	0.100
CEMENT MASON		HWY		23.750	24.750	1.5	1.5	2.0	5.300	3.700	0.000	0.300
CERAMIC TILE FNSHER		BLD		24.990	0.000	1.5	1.5	2.0	6.000	5.400	0.000	0.425
ELECTRICIAN		ALL		32.910	35.160	1.5	1.5	2.0	5.150	6.580	0.000	0.490
ELECTRONIC SYS TECH		BLD		25.700	27.200	1.5	1.5	2.0	5.150	3.340	0.000	0.250
FLOOR LAYER		BLD		26.930	27.680	1.5	1.5	2.0	5.000	3.750	0.000	0.350
GLAZIER		BLD		22.930	0.000	1.5	1.5	2.0	4.320	3.800	0.000	0.300
HT/FROST INSULATOR		BLD		30.440	31.440	1.5	1.5	2.0	4.850	8.360	0.000	0.450
IRON WORKER		ALL		22.650	23.650	1.5	1.5	2.0	5.760	6.450	0.000	0.310
LABORER		BLD		20.750	21.200	1.5	1.5	2.0	5.250	5.600	0.000	0.600
LABORER		HWY		21.000	21.450	1.5	1.5	2.0	5.350	6.150	0.000	0.600
LABORER		O&C		15.750	16.200	1.5	1.5	2.0	5.350	6.150	0.000	0.600
MACHINIST		BLD		36.890	38.890	2.0	2.0	2.0	4.380	5.650	2.550	0.000
MARBLE FINISHERS		BLD		24.990	0.000	1.5	1.5	2.0	6.000	5.400	0.000	0.425
MARBLE MASON		BLD		25.470	26.970	1.5	1.5	2.0	6.000	5.400	0.000	0.425
MILLWRIGHT		BLD		27.780	29.280	1.5	1.5	2.0	5.050	3.750	0.000	0.350
MILLWRIGHT		HWY		27.730	29.230	1.5	1.5	2.0	5.050	3.750	0.000	0.350
OE RIVER 1		RIV	1	26.900	0.000	1.5	1.5	2.0	5.650	6.100	0.000	1.100
OE RIVER 2		RIV	2	23.450	0.000	1.5	1.5	2.0	5.650	6.100	0.000	1.100
OPERATING ENGINEER		ALL	1	26.800	27.800	1.5	1.5	2.0	5.650	6.100	0.000	1.100
OPERATING ENGINEER		ALL	2	24.900	27.800	1.5	1.5	2.0	5.650	6.100	0.000	1.100
OPERATING ENGINEER		ALL	3	24.150	27.800	1.5	1.5	2.0	5.650	6.100	0.000	1.100
OPERATING ENGINEER		ALL	4	21.400	27.800	1.5	1.5	2.0	5.650	6.100	0.000	1.100
OPERATING ENGINEER		O&C	1	20.100	21.100	1.5	1.5	2.0	5.650	6.100	0.000	1.100
OPERATING ENGINEER		O&C	2	18.680	21.100	1.5	1.5	2.0	5.650	6.100	0.000	1.100
OPERATING ENGINEER		O&C	3	18.120	21.100	1.5	1.5	2.0	5.650	6.100	0.000	1.100
OPERATING ENGINEER		O&C	4	16.050	21.100	1.5	1.5	2.0	5.650	6.100	0.000	1.100
PAINTER		BLD		22.790	23.790	1.5	1.5	2.0	5.430	4.500	0.000	0.250
PAINTER		HWY		27.090	28.090	1.5	1.5	2.0	5.430	4.500	0.000	0.250
PAINTER OVER 30FT		BLD		23.790	24.790	1.5	1.5	2.0	5.430	4.500	0.000	0.250
PAINTER PWR EQMT		BLD		23.790	24.790	1.5	1.5	2.0	5.430	4.500	0.000	0.250
PAINTER PWR EQMT		HWY		28.090	29.090	1.5	1.5	2.0	5.430	4.500	0.000	0.250
PILEDRIVER		BLD		27.780	29.280	1.5	1.5	2.0	5.050	3.750	0.000	0.350
PILEDRIVER		HWY		27.730	29.230	1.5	1.5	2.0	5.050	3.750	0.000	0.350
PIPEFITTER		BLD		31.300	34.430	1.5	2.0	2.0	6.450	5.030	0.000	0.620
PLASTERER		BLD		23.500	24.500	1.5	1.5	2.0	5.200	3.550	0.000	0.100
PLUMBER		BLD		31.300	34.430	1.5	2.0	2.0	6.450	5.030	0.000	0.620
ROOFER		BLD		19.700	20.500	1.5	1.5	2.0	5.700	3.800	0.000	0.000
SHEETMETAL WORKER		ALL		27.210	28.460	1.5	1.5	2.0	6.000	4.770	1.630	0.120
SPRINKLER FITTER		BLD		31.240	33.240	1.5	1.5	2.0	6.500	5.350	0.000	0.250
STONE MASON		BLD		25.470	26.970	1.5	1.5	2.0	6.000	5.400	0.000	0.425
TERRAZZO FINISHER		BLD		24.990	0.000	1.5	1.5	2.0	6.000	5.400	0.000	0.425
TERRAZZO MASON		BLD		28.500	28.800	1.5	1.5	2.0	0.000	2.950	0.000	0.000
TRUCK DRIVER		ALL	1	24.990	0.000	1.5	1.5	2.0	7.250	4.200	0.000	0.000
TRUCK DRIVER		ALL	2	25.390	0.000	1.5	1.5	2.0	7.250	4.200	0.000	0.000
TRUCK DRIVER		ALL	3	25.590	0.000	1.5	1.5	2.0	7.250	4.200	0.000	0.000
TRUCK DRIVER		ALL	4	25.840	0.000	1.5	1.5	2.0	7.250	4.200	0.000	0.000
TRUCK DRIVER		ALL	5	26.590	0.000	1.5	1.5	2.0	7.250	4.200	0.000	0.000
TRUCK DRIVER		O&C	1	19.500	0.000	1.5	1.5	2.0	4.275	4.670	0.000	0.000
TRUCK DRIVER		O&C	2	15.900	0.000	1.5	1.5	2.0	4.275	4.670	0.000	0.000
TRUCK DRIVER		O&C	3	16.400	0.000	1.5	1.5	2.0	4.275	4.670	0.000	0.000
TUCK POINTER		BLD		25.470	26.970	1.5	1.5	2.0	6.000	5.400	0.000	0.425

Legend :

M-F>8 (Overtime is required for any hour greater than 8 worked each day, Monday through Friday.)

OSA (Overtime is required for every hour worked on Saturday)

OSH (Overtime is required for every hour worked on Sunday and Holidays)

H/W (Health & Welfare Insurance)

Pensn (Pension)

Vac (Vacation)

Trng (Training)

## Explanations

### UNION COUNTY

The following list is considered as those days for which holiday rates of wages for work performed apply: New Years Day, Memorial/Decoration Day, Fourth of July, Labor Day, Veterans Day, Thanksgiving Day, Christmas Day. Generally, any of these holidays which fall on a Sunday is celebrated on the following Monday. This then makes work performed on that Monday payable at the appropriate overtime rate for holiday pay. Common practice in a given local may alter certain days of celebration such as the day after Thanksgiving for Veterans Day. If in doubt, please check with IDOL.

Oil and chip resealing (O&C) means the application of road oils and liquid asphalt to coat an existing road surface, followed by application of aggregate chips or gravel to coated surface, and subsequent rolling of material to seal the surface.

### EXPLANATION OF CLASSES

ASBESTOS - GENERAL - removal of asbestos material/mold and hazardous materials from any place in a building, including mechanical systems where those mechanical systems are to be removed. This includes the removal of asbestos materials/mold and hazardous materials from ductwork or pipes in a building when the building is to be demolished at the time or at some close future date.

ASBESTOS - MECHANICAL - removal of asbestos material from mechanical systems, such as pipes, ducts, and boilers, where the mechanical systems are to remain.

### LABORER - OIL AND CHIP RESEALING ONLY

Hook and unhook chip box from aggregate truck; distribute material within chip box; perform flagging work related to oil and chip resealing; hand spray oil fluids; handle traffic control, including setting-up and maintaining barricades, drums, cones, delineators, signs and other such items, as well as laying-out and applying or removing temporary roadway markings used to control traffic in job site related to oil and chip resealing; and perform clean-up related to oil and chip resealing.

## CERAMIC TILE FINISHER, MARBLE FINISHER, TERRAZZO FINISHER

Assisting, helping or supporting the tile, marble and terrazzo mechanic by performing their historic and traditional work assignments required to complete the proper installation of the work covered by said crafts. The term "Ceramic" is used for naming the classification only, and is in no a limitation of the product handled. Ceramic takes into consideration most hard tiles.

## ELECTRONIC SYSTEMS TECHNICIAN

Installation, service and maintenance of low-voltage systems which utilizes the transmission and/or transference of voice, sound, vision, or digital for commercial, education, security and entertainment purposes for the following: TV monitoring and surveillance, background/foreground music, intercom and telephone interconnect, field programming, inventory control systems, microwave transmission, multi-media, multiplex, radio page, school, intercom and sound burglar alarms and low voltage master clock systems.

Excluded from this classification are energy management systems, life safety systems, supervisory controls and data acquisition systems not intrinsic with the above listed systems, fire alarm systems, nurse call systems and raceways exceeding fifteen feet in length.

## TRUCK DRIVER - BUILDING, HEAVY AND HIGHWAY CONSTRUCTION

Class 1. Drivers on 2 axle trucks hauling less than 9 ton. Air compressor and welding machines and brooms, including those pulled by separate units, truck driver helpers, warehouse employees, mechanic helpers, greasers and tiremen, pickup trucks when hauling materials, tools, or workers to and from and on-the-job site, and fork lifts up to 6,000 lb. capacity.

Class 2. Two or three axle trucks hauling more than 9 ton but hauling less than 16 ton. A-frame winch trucks, hydrolift trucks, vector trucks or similar equipment when used for transportation purposes. Fork lifts over 6,000 lb. capacity, winch trucks, four axle combination units, and ticket writers.

Class 3. Two, three or four axle trucks hauling 16 ton or more. Drivers on water pulls, articulated dump trucks, mechanics and working forepersons, and dispatchers. Five axle or more combination units.

Class 4. Low Boy and Oil Distributors.

Class 5. Drivers who require special protective clothing while employed on hazardous waste work.

## TRUCK DRIVER - O & C (Oil and Chip Resealing ONLY)

It involves driving of contractor or subcontractor owned, leased, or hired pickup, dump, service, or oil distributor trucks. Includes transporting materials and equipment (including, but not limited to oils, aggregate supplies, parts, machinery and tools) to or from the job site; distributing oil or liquid asphalt and aggregate; stock piling material; and maintaining trucks at job site related to oil and chip resealing.

Class 1. Distributors, liquid asphalt hauling and hauling of asphalt rubber-tired rollers.

Class 2. Stockpiling.

Class 3. Tandem hauling to job site.

OPERATING ENGINEERS - BUILDING, HEAVY AND HIGHWAY CONSTRUCTION

Class 1. APSCO or Equal Spreading Machine, Backhoe, Backfiller, Boom or Winch Cat, Bituminous Mixplane Machine, Blacksmith, Bituminous Surfacing Machine, Bull-Dozer, Crane, Shovel, Dragline, Truck Crane, Pile Driver, Concrete Breaker, Concrete or Pumpcrete Pumps, Dinky or Standard Locomotives, Well or Caisson Drills, Elevating Grader, Fork Lifts, Flexplane, Gradeall, Hi-Lift Hoists, Guy-Derricks, Hysters, Mechanic Motor Patrol, Mixers-21 cu. ft. or over, Push Cats, Pulls and Scrapers, Two Well Point Pumps, Pulverizer or Tiller, PugMill, Rubber-Tired Farm Type Tractor with Bulldozer/Blade/Auger or hi-lift over 1/2 yd., Jersey Spreader, Tract-Air used with Drill or Hi-Lift, Trenching or Ditching Machines, Wood Chipper w/Tractor, Self-Propelled Roller w/Blade, Equipment Greaser, Self-Propelled Bump Grinder on Concrete pavement, Boat Operator, Skid-Loaders, Tuggers, Lazer Screed, and Self-Propelled Chip Spreader (when others run conveyors).

Class 2. Any type tractor pulling any type roller or disc, Two Air Compressors (220 cu. ft. capacity or over), Two AirTract Drills, Air-Track Drill w/Compressor, Automatic Bins or Scales w/Compressor or Generator, Pipeline Boring Machine, Bulk Cement Plant w/Separate Compressor, Power Operated Bull Float, Hydra-Lift w/Single Motor, Straw Mulcher Blower w/Spout, Self-Propelled Roller/Compactor, Back-End man on Bituminous Surfacing Machine, oiler on milling machine.

Class 3. Air Compressor w/Valve driving piling, Boom or Winch Type Truck, Two Conveyors, Self-Propelled Concrete Saw, Form Grader, Truck Crane Oiler, Self-Propelled Vibrator, Rubber Tired Farm Type Tractor w/Blade/Bulldozer/Auger/hi-lift - 1/2 yd. or less, Elevator Operator, Man Lift (scissor lift) when lifting materials.

Class 4. Air-Track Drill (one), Belt Drag Machine, Power Broom, Mechanical Plasterer Applicator, Trac-Air, Air Compressor (220 cu. ft. or over) One, Air Compressor (under 220 cu. ft) four, Automatic Bin, Bulk Cement Plant w/Built-in Compressor running off same motor or electric motor, Fireman or Switchman, Self-Propelled Form Tamper, Light Plants (4), Welding Machines (4), Pumps (4), or Combination of four (4) Pumps, Light Plants, Welding Machines, Air-Compressors (under 220 cu. ft.), Mudjacks or Wood Chipper, Mixers - less than 21 cu. ft. Mortar Mixer w/Skip or Pump, Pipeline Tract Jack. One Operating Engineer may operate and maintain any combination of the following pieces of equipment, not to exceed four (4) which shall be within a reasonable distance, such combination may include any equipment in this classification: (Compressors, Light Plants, Generators, Welding Machines, Pumps or Conveyors), One Well- Point Pump, Two Motor Driven Heaters, One Air Compressor (under 220 cu. ft.), One Engine-Driven Conveyor, One Motor Driven Heater, One Light Plant, One Pump, One Welding Machine, One Ulmac or Equal Spreader, Oilers, and one Generator 10 kw or greater.

OPERATING ENGINEER - O & C (Oil and Chip Resealing ONLY). Includes the operation of all motorized heavy equipment used in oil and chip rsealing, including but not limited to operating self-propelled chip spreaders, and all types of rollers (both hard and rubber tired); and other duties pertaining to the operation or maintenance of heavy equipment relatd to oil and chip resealing.

Class 1. See Class 1 above for types of equipment operated.

Class 2. See Class 2 above for types of equipment operated.



Class 3. See Class 3 above for types of equipment operated.

Class 4. See Class 4 above for types of equipment operated.

OPERATING ENGINEER RIVER WORK 1 - operate the following machines when working on River Work and Levee Work on the Mississippi and Ohio Rivers, Lakes and Tributaries: Crane, Shovel, Dragline, Scrapers, Dredge, Derrick, Pile-Driver, Push Boat, all power boat operators, Mechanic, Engineman on Dredge, Leverman on Dredge, All Bituminous Spreader machines, Backhoe, Backfiller, Boom, or Winch Cat, Bituminous Mixplane Machine, Blacksmith, Bituminous Surfacing Machine, Bulldozer, Truck Cranes, Hydraulic Truck Mounted Boom/Crane, Concrete Finishing Machine, or Spreader Machine, Concrete Breaker, Concrete or Pumpcrete Machines, Concrete Plant Operator, All Off Road Material Hauling Equipment, Dinky or Standard Locomotives, Well Drill, Elevating Grader, Fork-Lifts, Flexplane, Gradeall, Hi-Lift, Power Handblade Tugger type Hoist, Hoist Two Drum (or over one), Gyderrick, Hyster, Motor Patrol, Mixers - 21 Cu. Ft. or over, Push Cat, Pulls, & Scrapers, Pumps-Two Well Points, Equipment Greaser, P & H Pulverizer or Pulverizer equal to Pugmill, Pugmill, Rubber-Tired farm type tractor w/Bulldozer/Blade/Auger or Hi-Lift over ½ yard, Skimmer Scoops, Seaman Tiller, Jersey Spreader, Tract-Air used with Drill or Hi-Lift, Trenching or Ditching Machine, Wood Chipper w/Tractor, self-propelled roller w/Blade, Concrete Pumps and Small Equipment Operators.

OPERATING ENGINEER RIVER 2 - when working on River Work and Levee Work on the Mississippi and Ohio Rivers, Lakes and Tributaries shall be employed as the Oiler or Fireman on Crane, Dragline, Shovel, Dredge, Truck Crane, Pile Driver, Gradeall, Dinky or Standard Locomotive, Guy Derrick, Trenching Machine or Ditching Machine 80 H.P. and over, All Terrain (cherry-picker) with over 40 ton Lifting Capacity, Deck Oiler and Deckhands.

Other Classifications of Work:

For definitions of classifications not otherwise set out, the Department generally has on file such definitions which are available. If a task to be performed is not subject to one of the classifications of pay set out, the Department will upon being contacted state which neighboring county has such a classification and provide such rate, such rate being deemed to exist by reference in this document. If no neighboring county rate applies to the task, the Department shall undertake a special determination, such special determination being then deemed to have existed under this determination. If a project requires these, or any classification not listed, please contact IDOL at 618/993-7271 for wage rates or clarifications.

#### LANDSCAPING

Landscaping work falls under the existing classifications for laborer, operating engineer and truck driver. The work performed by landscape plantsman and landscape laborer is covered by the existing classification of laborer. The work performed by landscape operators (regardless of equipment used or its size) is covered by the classifications of operating engineer. The work performed by landscape truck drivers (regardless of size of truck driven) is covered by the classifications of truck driver.

# Vermilion County Prevailing Wage for April 2007

Trade Name	RG	TYP	C	Base	FRMAN	*M-F>8	OSA	OSH	H/W	Pensn	Vac	Trng
=====	==	===	=	=====	=====	=====	===	===	=====	=====	=====	=====
ASBESTOS ABT-GEN		BLD		23.220	24.220	1.5	1.5	2.0	5.050	6.300	0.000	0.700
ASBESTOS ABT-MEC		BLD		20.190	0.000	1.5	1.5	2.0	5.000	3.400	0.000	0.000
BOILERMAKER		BLD		30.970	33.970	2.0	2.0	2.0	8.270	7.740	0.000	0.300
BRICK MASON		BLD		25.500	27.000	1.5	1.5	2.0	5.200	6.500	0.000	0.630
CARPENTER		BLD		27.790	29.790	1.5	1.5	2.0	6.500	4.600	0.000	0.320
CARPENTER		HWY		27.740	29.490	1.5	1.5	2.0	6.500	4.600	0.000	0.300
CEMENT MASON		BLD		25.830	27.080	1.5	1.5	2.0	5.200	7.000	0.000	0.300
CEMENT MASON		HWY		24.170	25.170	1.5	1.5	2.0	5.200	7.000	0.000	0.300
CERAMIC TILE FNSHER		BLD		25.500	0.000	1.5	1.5	2.0	5.200	5.600	0.000	0.000
ELECTRIC PWR EQMT OP		ALL		30.750	0.000	1.5	1.5	2.0	4.750	8.610	0.000	0.000
ELECTRIC PWR GRNDMAN		ALL		21.090	0.000	1.5	1.5	2.0	4.750	5.905	0.000	0.000
ELECTRIC PWR LINEMAN		ALL		34.160	36.350	1.5	1.5	2.0	4.750	9.560	0.000	0.000
ELECTRIC PWR TRK DRV		ALL		22.130	0.000	1.5	1.5	2.0	4.750	6.200	0.000	0.000
ELECTRICIAN		ALL		28.210	31.030	1.5	1.5	2.0	5.150	5.850	0.000	0.210
ELECTRONIC SYS TECH		BLD		24.870	26.370	1.5	1.5	2.0	5.150	3.150	0.000	0.250
FENCE ERECTOR		ALL		26.420	28.170	1.5	1.5	2.0	6.590	6.150	0.000	0.500
GLAZIER		BLD		24.430	25.930	1.5	1.5	2.0	4.500	4.800	0.000	0.300
HT/FROST INSULATOR		BLD		28.470	0.000	1.5	1.5	2.0	5.040	5.800	0.000	0.130
IRON WORKER		ALL		26.420	28.170	1.5	1.5	2.0	6.590	6.150	0.000	0.500
LABORER		BLD		21.720	22.720	1.5	1.5	2.0	5.050	6.300	0.000	0.600
LABORER		HWY		23.200	23.950	1.5	1.5	2.0	5.050	6.300	0.000	0.600
LATHER		BLD		27.790	29.790	1.5	1.5	2.0	6.500	4.600	0.000	0.320
MACHINIST		BLD		36.890	38.890	2.0	2.0	2.0	4.380	5.650	2.550	0.000
MARBLE FINISHERS		BLD		25.500	0.000	1.5	1.5	2.0	5.200	5.600	0.000	0.000
MARBLE MASON		BLD		27.000	0.000	1.5	1.5	2.0	5.200	5.600	0.000	0.000
MILLWRIGHT		BLD		26.000	28.000	1.5	1.5	2.0	6.500	6.850	0.000	0.320
MILLWRIGHT		HWY		19.410	20.660	1.5	1.5	2.0	2.800	3.000	0.000	0.000
OPERATING ENGINEER		ALL	1	28.650	0.000	1.5	1.5	2.0	5.200	6.750	0.000	0.650
OPERATING ENGINEER		ALL	2	18.600	0.000	1.5	1.5	2.0	5.200	6.750	0.000	0.650
PAINTER		ALL		28.450	29.800	1.5	1.5	2.0	5.200	2.800	0.000	0.320
PAINTER SIGNS		BLD		28.970	32.520	1.5	1.5	1.5	2.600	2.310	0.000	0.000
PILEDRIVER		BLD		28.290	30.290	1.5	1.5	2.0	6.500	4.600	0.000	0.320
PILEDRIVER		HWY		28.240	29.990	1.5	1.5	2.0	6.500	4.600	0.000	0.300
PIPEFITTER		ALL		28.850	31.010	1.5	1.5	2.0	5.450	4.750	0.000	0.510
PLASTERER		BLD		23.940	25.440	1.5	1.5	2.0	5.200	8.200	0.000	0.300
PLUMBER		ALL		28.850	31.010	1.5	1.5	2.0	5.450	4.750	0.000	0.510
ROOFER		BLD		25.460	26.460	1.5	1.5	2.0	6.350	5.150	0.000	0.200
SHEETMETAL WORKER		BLD		28.600	30.600	1.5	1.5	2.0	7.150	7.330	0.000	0.520
SPRINKLER FITTER		BLD		31.240	33.240	1.5	1.5	2.0	6.500	5.350	0.000	0.250
STONE MASON		BLD		25.500	27.000	1.5	1.5	2.0	5.200	6.500	0.000	0.630
TERRAZZO FINISHER		BLD		25.500	0.000	1.5	1.5	2.0	5.200	5.600	0.000	0.000
TERRAZZO MASON		BLD		27.000	0.000	1.5	1.5	2.0	5.200	5.600	0.000	0.000
TILE MASON		BLD		27.000	0.000	1.5	1.5	2.0	5.200	5.600	0.000	0.000
TRUCK DRIVER		ALL	1	25.787	0.000	1.5	1.5	2.0	7.250	3.317	0.000	0.000
TRUCK DRIVER		ALL	2	26.187	0.000	1.5	1.5	2.0	7.250	3.317	0.000	0.000
TRUCK DRIVER		ALL	3	26.387	0.000	1.5	1.5	2.0	7.250	3.317	0.000	0.000
TRUCK DRIVER		ALL	4	26.637	0.000	1.5	1.5	2.0	7.250	3.317	0.000	0.000
TRUCK DRIVER		ALL	5	27.387	0.000	1.5	1.5	2.0	7.250	3.317	0.000	0.000
TRUCK DRIVER		O&C	1	20.630	0.000	1.5	1.5	2.0	7.250	3.317	0.000	0.000
TRUCK DRIVER		O&C	2	20.950	0.000	1.5	1.5	2.0	7.250	3.317	0.000	0.000
TRUCK DRIVER		O&C	3	21.110	0.000	1.5	1.5	2.0	7.250	3.317	0.000	0.000
TRUCK DRIVER		O&C	4	21.310	0.000	1.5	1.5	2.0	7.250	3.317	0.000	0.000
TRUCK DRIVER		O&C	5	21.910	0.000	1.5	1.5	2.0	7.250	3.317	0.000	0.000
TUCKPOINTER		BLD		25.500	27.000	1.5	1.5	2.0	5.200	6.500	0.000	0.630

Legend:

M-F>8 (Overtime is required for any hour greater than 8 worked each day, Monday through Friday.)

OSA (Overtime is required for every hour worked on Saturday)

OSH (Overtime is required for every hour worked on Sunday and Holidays)

H/W (Health & Welfare Insurance)

Pensn (Pension)

Vac (Vacation)

Trng (Training)

## Explanations

### VERMILION COUNTY

The following list is considered as those days for which holiday rates of wages for work performed apply: New Years Day, Memorial/Decoration Day, Fourth of July, Labor Day, Veterans Day, Thanksgiving Day, Christmas Day. Generally, any of these holidays which fall on a Sunday is celebrated on the following Monday. This then makes work performed on that Monday payable at the appropriate overtime rate for holiday pay. Common practice in a given local may alter certain days of celebration such as the day after Thanksgiving for Veterans Day. If in doubt, please check with IDOL.

Oil and chip resealing (O&C) means the application of road oils and liquid asphalt to coat an existing road surface, followed by application of aggregate chips or gravel to coated surface, and subsequent rolling of material to seal the surface.

### EXPLANATION OF CLASSES

ASBESTOS - GENERAL - removal of asbestos material/mold and hazardous materials from any place in a building, including mechanical systems where those mechanical systems are to be removed. This includes the removal of asbestos materials/mold and hazardous materials from ductwork or pipes in a building when the building is to be demolished at the time or at some close future date.

ASBESTOS - MECHANICAL - removal of asbestos material from mechanical systems, such as pipes, ducts, and boilers, where the mechanical systems are to remain.

### CERAMIC TILE FINISHER, MARBLE FINISHER, TERRAZZO FINISHER

Assisting, helping or supporting the tile, marble and terrazzo mechanic by performing their historic and traditional work assignments required to complete the proper installation of the work covered by said crafts. The term "Ceramic" is used for naming the classification only and is in no way a limitation of the product handled. Ceramic takes into consideration most hard tiles.

### ELECTRONIC SYSTEMS TECHNICIAN

Installation, service and maintenance of low-voltage systems which utilizes the transmission and/or transference of voice, sound, vision, or digital for commercial, education, security and entertainment purposes for the following: TV monitoring and surveillance, background/foreground music, intercom and telephone interconnect,

field programming, inventory control systems, microwave transmission, multi-media, multiplex, radio page, school, intercom and sound burglar alarms and low voltage master clock systems.

Excluded from this classification are energy management systems, life safety systems, supervisory controls and data acquisition systems not intrinsic with the above listed systems, fire alarm systems, nurse call systems and raceways exceeding fifteen feet in length.

#### TRUCK DRIVER - BUILDING, HEAVY AND HIGHWAY CONSTRUCTION

Class 1. Drivers on 2 axle trucks hauling less than 9 ton. Air compressor and welding machines and brooms, including those pulled by separate units, truck driver helpers, warehouse employees, mechanic helpers, greasers and tiremen, pickup trucks when hauling materials, tools, or workers to and from and on-the-job site, and fork lifts up to 6,000 lb. capacity.

Class 2. Two or three axle trucks hauling more than 9 ton but hauling less than 16 ton. A-frame winch trucks, hydrolift trucks, vector trucks or similar equipment when used for transportation purposes. Fork lifts over 6,000 lb. capacity, winch trucks, four axle combination units, and ticket writers.

Class 3. Two, three or four axle trucks hauling 16 ton or more. Drivers on water pulls, articulated dump trucks, mechanics and working forepersons, and dispatchers. Five axle or more combination units.

Class 4. Low Boy and Oil Distributors.

Class 5. Drivers who require special protective clothing while employed on hazardous waste work.

#### TRUCK DRIVER - OIL AND CHIP RESEALING ONLY.

This shall encompass laborers, workers and mechanics who drive contractor or subcontractor owned, leased, or hired pickup, dump, service, or oil distributor trucks. The work includes transporting materials and equipment (including but not limited to, oils, aggregate supplies, parts, machinery and tools) to or from the job site; distributing oil or liquid asphalt and aggregate; stock piling material when in connection with the actual oil and chip contract. The Truck Driver (Oil & Chip Resealing) wage classification does not include supplier delivered materials.

#### OPERATING ENGINEERS - BUILDING, HEAVY AND HIGHWAY CONSTRUCTION

Class 1. Power Cranes, Draglines, Derricks, Shovels, Gradalls, Mechanics, Tractor Highlift, Tournadozer, Concrete Mixers with Skip, Tournamixer, Two Drum Machine, One Drum Hoist with Tower or Boom, Cableways, Tower Machines, Motor Patrol, Boom Tractor, Boom or Winch Truck, Winch or Hydraulic Boom Truck, Truck Crane, Tournapull, Tractor Operating Scoops, Bulldozer, Push Tractor, Asphalt Planer, Finishing Machine on Asphalt, Large Rollers on Earth, Rollers on Asphalt Mix, Ross Carrier or similar Machine, Gravel Processing Machine, Asphalt Plant Engineer, Paver Operator, Dredging Equipment, or Dredge Engineer, or Dredge Operator, Central Mix Plant Engineer, CMI or similar type machine, Concrete Pump, Truck or Skid Mounted, Tower Crane, Engineer or Rock Crusher Plant, Concrete Plant Engineer, Ditching Machine with dual attachment, Tractor Mounted Loaders, Cherry Picker, Hydro Crane, Standard or Dinkey Locomotives, Scoopmobiles, Euclid Loader, Soil Cement Machine, Back Filler, Elevating Machine, Power Blade, Drilling Machine, including Well Testing, Caissons, Shaft or any similar type drilling machines, Motor Driven Paint Machine, Pipe Cleaning Machine, Pipe Wrapping Machine,

Pipe Bending Machine, Apsco Paver, Boring Machine, (Head Equipment Greaser), Barber-Greene Loaders, Formless Paver, (Well Point System), Concrete Spreader, Hydra Ax, Span Saw, Marine Scoops, Brush Mulcher, Brush Burner, Mesh Placer, Tree Mover, Helicopter Crew (3), Piledriver-Skid or Crawler, Stump Remover, Root Rake, Tug Boat Operator, Refrigerating Machine, Freezing Operator, Chair Cart-Self-Propelled, Hydra Seeder, Straw Blower, Power Sub Grader, Bull Float, Finishing Machine, Self-Propelled Pavement Breaker, Lull (or similar type Machine), Two Air Compressors, Compressors hooked in Manifold, Overhead Crane, Chip Spreader, Mud Cat, Sull-Air, Fork Lifts (except when used for landscaping work), Soil Stabilizer (Seaman Tiller, Bo Mag, Rago Gator, and similar types of equipment), Tube Float, Spray Machine, Curing Machine, Concrete or Asphalt Milling Machine, Snooper Truck-Operator, Backhoe, Farm Tractors (with attachments), 4 Point Lift System (Power Lift or similar type), Skid-Steer (Bob Cat or similar type), Wrecking Shears, Water Blaster.

Class 2. Concrete Mixers without Skips, Rock Crusher, Ditching Machine under 6', Curbing Machine, One Drum Machines without Tower or Boom, Air Tugger, Self-Propelled Concrete Saw, Machine Mounted Post Hole Digger, two to four Generators, Water Pumps or Welding Machines, within 400 feet, Air Compressor 600 cu. ft. and under, Rollers on Aggregate and Seal Coat Surfaces, Fork Lift (when used for landscaping work), Concrete and Blacktop Curb Machine, One Water Pump, Oilers, Air Valves or Steam Valves, One Welding Machine, Truck Jack, Mud Jack, Gunnite Machine, House Elevators when used for hoisting material, Engine Tenders, Fireman, Wagon Drill, Flex Plane, Conveyor, Siphons and Pulsometer, Switchman, Fireman on Paint Pots, Fireman on Asphalt Plants, Distributor Operator on Trucks, Tampers, Self-Propelled Power Broom, Striping Machine (motor driven), Form Tamper, Bulk Cement Plant, Equipment Greaser, Deck Hands, Truck Crane Oiler-Driver, Cement Blimps, Form Grader, Temporary Heat, Throttle Valve, Super Sucker (and similar type of equipment).

#### Other Classifications of Work:

For definitions of classifications not otherwise set out, the Department generally has on file such definitions which are available. If a task to be performed is not subject to one of the classifications of pay set out, the Department will upon being contacted state which neighboring county has such a classification and provide such rate, such rate being deemed to exist by reference in this document. If no neighboring county rate applies to the task, the Department shall undertake a special determination, such special determination being then deemed to have existed under this determination. If a project requires these, or any classification not listed, please contact IDOL at 618/993-7271 for wage rates or clarifications.

#### LANDSCAPING

Landscaping work falls under the existing classifications for laborer, operating engineer and truck driver. The work performed by landscape plantsman and landscape laborer is covered by the existing classification of laborer. The work performed by landscape operators (regardless of equipment used or its size) is covered by the classifications of operating engineer. The work performed by landscape truck drivers (regardless of size of truck driven) is covered by the classifications of truck driver.

# Wabash County Prevailing Wage for April 2007

Trade Name	RG	TYP	C	Base	FRMAN	*M-F>8	OSA	OSH	H/W	Pensn	Vac	Trng
=====	==	==	=	=====	=====	=====	==	==	=====	=====	=====	=====
ASBESTOS ABT-GEN		ALL		20.750	21.200	1.5	1.5	2.0	5.250	5.600	0.000	0.700
ASBESTOS ABT-MEC		BLD		20.800	0.000	2.0	2.0	2.0	5.000	3.400	0.000	0.000
BOILERMAKER		BLD		28.500	31.000	1.5	1.5	2.0	6.820	11.03	0.000	0.300
BRICK MASON		BLD		25.470	26.970	1.5	1.5	2.0	6.000	5.400	0.000	0.425
CARPENTER		BLD		27.780	29.280	1.5	1.5	2.0	5.050	3.750	0.000	0.350
CARPENTER		HWY		27.730	29.480	1.5	1.5	2.0	5.050	3.750	0.000	0.350
CEMENT MASON		BLD		25.830	27.080	1.5	1.5	2.0	5.200	7.000	0.000	0.300
CEMENT MASON		HWY		22.400	23.900	1.5	1.5	2.0	5.200	3.850	0.000	0.200
CERAMIC TILE FNSHER		BLD		24.990	0.000	1.5	1.5	2.0	6.000	5.400	0.000	0.425
COMMUNICATION TECH		BLD		18.350	19.650	1.5	1.5	2.0	0.000	0.550	0.000	0.000
ELECTRICIAN		BLD		27.560	29.560	1.5	1.5	2.0	5.150	6.340	0.000	0.360
FLOOR LAYER		BLD		26.930	27.680	1.5	1.5	2.0	5.000	3.750	0.000	0.350
GLAZIER		BLD		22.930	0.000	1.5	1.5	2.0	4.320	3.800	0.000	0.300
HT/FROST INSULATOR		BLD		26.110	27.110	1.5	1.5	2.0	4.800	6.860	0.000	0.190
IRON WORKER		ALL		24.000	25.250	1.5	1.5	2.0	5.780	6.850	0.000	0.345
LABORER		BLD		20.750	21.200	1.5	1.5	2.0	5.250	5.600	0.000	0.600
LABORER		HWY		21.000	21.450	1.5	1.5	2.0	5.350	6.150	0.000	0.600
MACHINIST		BLD		36.890	38.890	2.0	2.0	2.0	4.380	5.650	2.550	0.000
MARBLE FINISHERS		BLD		24.990	0.000	1.5	1.5	2.0	6.000	5.400	0.000	0.425
MARBLE MASON		BLD		25.470	26.970	1.5	1.5	2.0	6.000	5.400	0.000	0.425
MILLWRIGHT		BLD		27.780	29.280	1.5	1.5	2.0	5.050	3.750	0.000	0.350
MILLWRIGHT		HWY		28.230	29.980	1.5	1.5	2.0	5.050	3.750	0.000	0.350
OPERATING ENGINEER		ALL	1	28.650	0.000	1.5	1.5	2.0	5.200	6.750	0.000	0.650
OPERATING ENGINEER		ALL	2	18.600	0.000	1.5	1.5	2.0	5.200	6.750	0.000	0.650
OPERATING ENGINEER		O&C		14.570	0.000	1.5	1.5	2.0	4.200	2.200	0.000	0.000
PAINTER		BLD		22.850	23.850	1.5	1.5	2.0	5.150	3.950	0.000	0.250
PAINTER		HWY		24.000	25.000	1.5	1.5	2.0	5.150	3.950	0.000	0.250
PAINTER OVER 30FT		BLD		23.600	24.600	1.5	1.5	2.0	5.150	3.950	0.000	0.250
PAINTER PWR EQMT		BLD		23.850	24.850	1.5	1.5	2.0	5.150	3.950	0.000	0.250
PAINTER PWR EQMT		HWY		25.000	26.000	1.5	1.5	2.0	5.150	3.950	0.000	0.250
PILEDRIVER		BLD		27.780	29.280	1.5	1.5	2.0	5.050	3.750	0.000	0.350
PILEDRIVER		HWY		28.230	29.980	1.5	1.5	2.0	5.050	3.750	0.000	0.350
PIPEFITTER		BLD		27.580	29.230	1.5	1.5	2.0	5.450	7.010	0.000	0.700
PLASTERER		BLD		23.940	25.440	1.5	1.5	2.0	5.200	8.200	0.000	0.300
PLUMBER		BLD		27.580	29.230	1.5	1.5	2.0	5.450	7.010	0.000	0.700
ROOFER		BLD		24.690	26.190	1.5	1.5	2.0	4.380	4.000	0.000	0.000
SHEETMETAL WORKER		ALL		27.210	28.460	1.5	1.5	2.0	6.000	4.770	1.630	0.120
SPRINKLER FITTER		BLD		31.240	33.240	1.5	1.5	2.0	6.500	5.350	0.000	0.250
STONE MASON		BLD		25.470	26.970	1.5	1.5	2.0	6.000	5.400	0.000	0.425
TERRAZZO FINISHER		BLD		24.990	0.000	1.5	1.5	2.0	6.000	5.400	0.000	0.425
TERRAZZO MASON		BLD		25.470	26.970	1.5	1.5	2.0	6.000	5.400	0.000	0.425
TILE MASON		BLD		25.470	26.970	1.5	1.5	2.0	6.000	5.400	0.000	0.425
TRUCK DRIVER		ALL	1	25.010	0.000	1.5	1.5	2.0	6.500	2.225	0.000	0.000
TRUCK DRIVER		ALL	2	25.410	0.000	1.5	1.5	2.0	6.500	2.225	0.000	0.000
TRUCK DRIVER		ALL	3	25.610	0.000	1.5	1.5	2.0	6.500	2.225	0.000	0.000
TRUCK DRIVER		ALL	4	25.860	0.000	1.5	1.5	2.0	6.500	2.225	0.000	0.000
TRUCK DRIVER		ALL	5	26.610	0.000	1.5	1.5	2.0	6.500	2.225	0.000	0.000
TRUCK DRIVER		O&C		13.940	0.000	1.5	1.5	2.0	2.550	1.500	0.000	0.000
TUCKPOINTS		BLD		25.470	26.970	1.5	1.5	2.0	6.000	5.400	0.000	0.425

Legend:

M-F>8 (Overtime is required for any hour greater than 8 worked each day, Monday through Friday.)

OSA (Overtime is required for every hour worked on Saturday)

OSH (Overtime is required for every hour worked on Sunday and Holidays)

H/W (Health & Welfare Insurance)

Pensn (Pension)

Vac (Vacation)

Trng (Training)

## Explanations

### WABASH COUNTY

The following list is considered as those days for which holiday rates of wages for work performed apply: New Years Day, Memorial/Decoration Day, Fourth of July, Labor Day, Veterans Day, Thanksgiving Day, Christmas Day. Generally, any of these holidays which fall on a Sunday is celebrated on the following Monday. This then makes work performed on that Monday payable at the appropriate overtime rate for holiday pay. Common practice in a given local may alter certain days of celebration such as the day after Thanksgiving for Veterans Day. If in doubt, please check with IDOL.

### EXPLANATION OF CLASSES

ASBESTOS - GENERAL - removal of asbestos material/mold and hazardous materials from any place in a building, including mechanical systems where those mechanical systems are to be removed. This includes the removal of asbestos materials/mold and hazardous materials from ductwork or pipes in a building when the building is to be demolished at the time or at some close future date.

ASBESTOS - MECHANICAL - removal of asbestos material from mechanical systems, such as pipes, ducts, and boilers, where the mechanical systems are to remain.

### CERAMIC TILE FINISHER, MARBLE FINISHER, TERRAZZO FINISHER

Assisting, helping or supporting the tile, marble and terrazzo mechanic by performing their historic and traditional work assignments required to complete the proper installation of the work covered by said crafts. The term "Ceramic" is used for naming the classification only, and is in no a limitation of the product handled. Ceramic takes into consideration most hard tiles.

### COMMUNICATIONS TECHNICIAN

Installation, operation, inspection, modification, maintenance and repair of systems used for the transmission and reception of signals of any nature, for any purpose, including but not limited to, sound and voice transmission/transference systems, communication systems that transmit or receive information and/or control systems, television and video systems, micro-processor controlled fire alarm systems, and security systems, and the performance of any task directly related to such installation or service. EXCLUDES installation of electrical power wiring and conduit raceways exceeding fifteen (15) feet in length.

### TRUCK DRIVER - BUILDING, HEAVY AND HIGHWAY CONSTRUCTION

Class 1. Drivers on 2 axle trucks hauling less than 9 ton. Air compressor and welding machines and brooms, including those pulled by separate units, truck driver helpers, warehouse employees, mechanic helpers, greasers and tiremen, pickup trucks when hauling materials, tools, or workers to and from and on-the-job site, and fork lifts up to 6,000 lb. capacity.

Class 2. Two or three axle trucks hauling more than 9 ton but hauling less than 16 ton. A-frame winch trucks, hydrolift trucks, vactor trucks or similar equipment when used for transportation purposes. Fork lifts over 6,000 lb. capacity, winch trucks, four axle combination units, and ticket writers.

Class 3. Two, three or four axle trucks hauling 16 ton or more. Drivers on water pulls, articulated dump trucks, mechanics and working forepersons, and dispatchers. Five axle or more combination units.

Class 4. Low Boy and Oil Distributors.

Class 5. Drivers who require special protective clothing while employed on hazardous waste work.

TRUCK DRIVER - OIL AND CHIP

Encompasses following types of work when participating on public works projects involving oil and chip activities: Ready Mix, Gravel Truck Drivers, Asphalt Distributor Truck and Lowboy Drivers.

OPERATING ENGINEERS - BUILDING, HEAVY AND HIGHWAY CONSTRUCTION

Class 1. Power Cranes, Draglines, Derricks, Shovels, Gradalls, Mechanics, Tractor Highlift, Tournadozer, Concrete Mixers with Skip, Tournamixer, Two Drum Machine, One Drum Hoist with Tower or Boom, Cableways, Tower Machines, Motor Patrol, Boom Tractor, Boom or Winch Truck, Winch or Hydraulic Boom Truck, Truck Crane, Tournapull, Tractor Operating Scoops, Bulldozer, Push Tractor, Asphalt Planer, Finishing Machine on Asphalt, Large Rollers on Earth, Rollers on Asphalt Mix, Ross Carrier or similar Machine, Gravel Processing Machine, Asphalt Plant Engineer, Paver Operator, Dredging Equipment, or Dredge Engineer, or Dredge Operator, Central Mix Plant Engineer, CMI or similar type machine, Concrete Pump, Truck or Skid Mounted, Tower Crane, Engineer or Rock Crusher Plant, Concrete Plant Engineer, Ditching Machine with dual attachment, Tractor Mounted Loaders, Cherry Picker, Hydro Crane, Standard or Dinkey Locomotives, Scoopmobiles, Euclid Loader, Soil Cement Machine, Back Filler, Elevating Machine, Power Blade, Drilling Machine, including Well Testing, Caissons, Shaft or any similar type drilling machines, Motor Driven Paint Machine, Pipe Cleaning Machine, Pipe Wrapping Machine, Pipe Bending Machine, Apsco Paver, Boring Machine, (Head Equipment Greaser), Barber-Greene Loaders, Formless Paver, (Well Point System), Concrete Spreader, Hydra Ax, Span Saw, Marine Scoops, Brush Mulcher, Brush Burner, Mesh Placer, Tree Mover, Helicopter Crew (3), Piledriver-Skid or Crawler, Stump Remover, Root Rake, Tug Boat Operator, Refrigerating Machine, Freezing Operator, Chair Cart-Self-Propelled, Hydra Seeder, Straw Blower, Power Sub Grader, Bull Float, Finishing Machine, Self-Propelled Pavement Breaker, Lull (or similar type Machine), Two Air Compressors, Compressors hooked in Manifold, Overhead Crane, Chip Spreader, Mud Cat, Sull-Air, Fork Lifts (except when used for landscaping work), Soil Stabilizer (Seaman Tiller, Bo Mag, Rago Gator, and similar types of equipment), Tube Float, Spray Machine, Curing Machine, Concrete or Asphalt Milling Machine, Snooper Truck-Operator, Backhoe, Farm Tractors (with attachments), 4 Point Lift System (Power Lift or similar type), Skid-Steer (Bob Cat or similar type), Wrecking Shears, Water Blaster.



Class 2. Concrete Mixers without Skips, Rock Crusher, Ditching Machine under 6', Curbing Machine, One Drum Machines without Tower or Boom, Air Tugger, Self-Propelled Concrete Saw, Machine Mounted Post Hole Digger, two to four Generators, Water Pumps or Welding Machines, within 400 feet, Air Compressor 600 cu. ft. and under, Rollers on Aggregate and Seal Coat Surfaces, Fork Lift (when used for landscaping work), Concrete and Blacktop Curb Machine, One Water Pump, Oilers, Air Valves or Steam Valves, One Welding Machine, Truck Jack, Mud Jack, Gunnite Machine, House Elevators when used for hoisting material, Engine Tenders, Fireman, Wagon Drill, Flex Plane, Conveyor, Siphons and Pulsometer, Switchman, Fireman on Paint Pots, Fireman on Asphalt Plants, Distributor Operator on Trucks, Tampers, Self-Propelled Power Broom, Striping Machine (motor driven), Form Tamper, Bulk Cement Plant, Equipment Greaser, Deck Hands, Truck Crane Oiler-Driver, Cement Blimps, Form Grader, Temporary Heat, Throttle Valve, Super Sucker (and similar type of equipment).

#### OPERATING ENGINEER - OIL AND CHIP

Encompasses following types of work when participating on public works projects involving oil and chip activities: Spreading and compaction of seal coat aggregate on liquid asphalt or road oil and the preparation for such work for maintenance purposes.

#### Other Classifications of Work:

For definitions of classifications not otherwise set out, the Department generally has on file such definitions which are available. If a task to be performed is not subject to one of the classifications of pay set out, the Department will upon being contacted state which neighboring county has such a classification and provide such rate, such rate being deemed to exist by reference in this document. If no neighboring county rate applies to the task, the Department shall undertake a special determination, such special determination being then deemed to have existed under this determination. If a project requires these, or any classification not listed, please contact IDOL at 618/993-7271 for wage rates or clarifications.

#### LANDSCAPING

Landscaping work falls under the existing classifications for laborer, operating engineer and truck driver. The work performed by landscape plantsman and landscape laborer is covered by the existing classification of laborer. The work performed by landscape operators (regardless of equipment used or its size) is covered by the classifications of operating engineer. The work performed by landscape truck drivers (regardless of size of truck driven) is covered by the classifications of truck driver.

# Warren County Prevailing Wage for April 2007

Trade Name	RG	TYP	C	Base	FRMAN	*M-F>8	OSA	OSH	H/W	Pensn	Vac	Trng
=====	==	==	=	=====	=====	=====	==	==	=====	=====	=====	=====
ASBESTOS ABT-GEN		BLD		23.510	24.260	1.5	1.5	2.0	5.850	6.180	0.000	0.600
ASBESTOS ABT-GEN		HWY		22.940	23.440	1.5	1.5	2.0	5.850	5.850	0.000	0.700
ASBESTOS ABT-MEC		BLD		18.750	19.750	1.5	1.5	2.0	4.750	2.000	0.000	0.000
BOILERMAKER		BLD		30.970	33.970	2.0	2.0	2.0	8.270	7.740	0.000	0.300
BRICK MASON		BLD		27.020	28.520	1.5	1.5	2.0	5.500	6.350	0.000	0.390
CARPENTER		BLD		26.020	28.020	1.5	1.5	2.0	6.500	7.150	0.000	0.320
CARPENTER		HWY		25.910	27.910	1.5	1.5	2.0	6.500	8.100	0.000	0.320
CEMENT MASON		ALL		24.230	24.730	1.5	1.5	2.0	5.050	4.500	0.000	0.300
CERAMIC TILE FNSHER		BLD		24.910	0.000	1.5	1.5	2.0	5.500	6.350	0.000	0.380
ELECTRIC PWR EQMT OP		ALL		30.750	0.000	1.5	1.5	2.0	4.750	8.610	0.000	0.000
ELECTRIC PWR GRNDMAN		ALL		21.090	0.000	1.5	1.5	2.0	4.750	5.905	0.000	0.000
ELECTRIC PWR LINEMAN		ALL		34.160	36.350	1.5	1.5	2.0	4.750	9.560	0.000	0.000
ELECTRIC PWR TRK DRV		ALL		22.130	0.000	1.5	1.5	2.0	4.750	6.200	0.000	0.000
ELECTRICIAN		BLD		27.040	29.040	1.5	1.5	2.0	5.150	7.460	0.000	0.250
ELECTRONIC SYS TECH		BLD		23.850	25.350	1.5	1.5	2.0	5.150	5.625	0.000	0.250
ELEVATOR CONSTRUCTOR		BLD		34.190	38.460	2.0	2.0	2.0	8.275	6.060	2.050	0.000
GLAZIER		BLD		20.580	21.810	1.5	1.5	2.0	4.750	3.900	0.000	0.200
HT/FROST INSULATOR		BLD		25.860	27.060	1.5	1.5	2.0	4.800	7.500	0.000	0.000
IRON WORKER		ALL		21.500	22.750	1.5	1.5	2.0	5.760	6.790	0.000	0.260
LABORER		BLD		22.510	23.260	1.5	1.5	2.0	5.850	6.180	0.000	0.600
LABORER		HWY		21.940	22.440	1.5	1.5	2.0	5.850	5.850	0.000	0.600
LABORER, SKILLED		BLD		22.510	23.260	1.5	1.5	2.0	5.850	6.180	0.000	0.600
LABORER, SKILLED		HWY		22.240	22.740	1.5	1.5	2.0	5.850	5.850	0.000	0.600
LATHER		BLD		26.020	28.020	1.5	1.5	2.0	6.500	7.150	0.000	0.320
MACHINIST		BLD		36.890	38.890	2.0	2.0	2.0	4.380	5.650	2.550	0.000
MARBLE FINISHERS		BLD		24.910	0.000	1.5	1.5	2.0	5.500	6.350	0.000	0.380
MARBLE MASON		BLD		26.520	27.770	1.5	1.5	2.0	5.500	6.350	0.000	0.380
MILLWRIGHT		BLD		26.620	28.620	1.5	1.5	2.0	6.500	6.850	0.000	0.320
MILLWRIGHT		HWY		27.010	29.010	1.5	1.5	2.0	6.500	6.450	0.000	0.320
OPERATING ENGINEER		BLD	1	27.840	30.840	1.5	1.5	2.0	5.900	8.000	0.000	0.900
OPERATING ENGINEER		BLD	2	25.940	30.840	1.5	1.5	2.0	5.900	8.000	0.000	0.900
OPERATING ENGINEER		BLD	3	24.560	30.840	1.5	1.5	2.0	5.900	8.000	0.000	0.900
OPERATING ENGINEER		HWY	1	29.110	32.110	1.5	1.5	2.0	6.250	9.000	0.000	1.000
OPERATING ENGINEER		HWY	2	26.730	32.110	1.5	1.5	2.0	6.250	9.000	0.000	1.000
OPERATING ENGINEER		HWY	3	22.790	32.110	1.5	1.5	2.0	6.250	9.000	0.000	1.000
PAINTER		ALL		23.470	24.470	1.5	1.5	1.5	4.650	4.850	0.000	0.600
PAINTER OVER 30FT		ALL		24.720	25.720	1.5	1.5	1.5	4.650	4.850	0.000	0.600
PAINTER PWR EQMT		ALL		23.970	24.970	1.5	1.5	1.5	4.650	4.850	0.000	0.600
PILEDRIVER		BLD		26.520	28.520	1.5	1.5	2.0	6.500	7.150	0.000	0.320
PILEDRIVER		HWY		26.910	28.910	1.5	1.5	2.0	6.500	8.100	0.000	0.320
PIPEFITTER		ALL		30.520	33.570	1.5	1.5	2.0	4.800	7.960	0.000	0.530
PLASTERER		BLD		23.400	24.650	1.5	1.5	2.0	5.290	9.800	0.000	0.500
PLUMBER		ALL		30.520	33.570	1.5	1.5	2.0	4.800	7.960	0.000	0.530
ROOFER		BLD		22.850	24.100	1.5	1.5	2.0	5.840	4.870	0.000	0.190
SHEETMETAL WORKER		BLD		27.300	29.000	1.5	1.5	2.0	6.040	7.300	0.000	0.380
SPRINKLER FITTER		BLD		31.240	33.240	1.5	1.5	2.0	6.500	5.350	0.000	0.250
STONE MASON		BLD		27.020	28.520	1.5	1.5	2.0	5.500	6.350	0.000	0.390
TERRAZZO FINISHER		BLD		24.910	0.000	1.5	1.5	2.0	5.500	6.350	0.000	0.380
TERRAZZO MASON		BLD		26.520	27.770	1.5	1.5	2.0	5.500	6.350	0.000	0.380
TILE MASON		BLD		26.520	27.770	1.5	1.5	2.0	5.500	6.350	0.000	0.380
TRUCK DRIVER		ALL	1	25.787	0.000	1.5	1.5	2.0	7.250	3.317	0.000	0.000
TRUCK DRIVER		ALL	2	26.187	0.000	1.5	1.5	2.0	7.250	3.317	0.000	0.000
TRUCK DRIVER		ALL	3	26.387	0.000	1.5	1.5	2.0	7.250	3.317	0.000	0.000
TRUCK DRIVER		ALL	4	26.637	0.000	1.5	1.5	2.0	7.250	3.317	0.000	0.000
TRUCK DRIVER		ALL	5	27.387	0.000	1.5	1.5	2.0	7.250	3.317	0.000	0.000
TRUCK DRIVER		O&C	1	20.630	0.000	1.5	1.5	2.0	7.250	3.317	0.000	0.000
TRUCK DRIVER		O&C	2	20.950	0.000	1.5	1.5	2.0	7.250	3.317	0.000	0.000
TRUCK DRIVER		O&C	3	21.110	0.000	1.5	1.5	2.0	7.250	3.317	0.000	0.000

TRUCK DRIVER	O&C 4	21.310	0.000	1.5	1.5	2.0	7.250	3.317	0.000	0.000
TRUCK DRIVER	O&C 5	21.910	0.000	1.5	1.5	2.0	7.250	3.317	0.000	0.000
TUCKPOINTER	BLD	27.020	28.520	1.5	1.5	2.0	5.500	6.350	0.000	0.390

Legend:

M-F>8 (Overtime is required for any hour greater than 8 worked each day, Monday through Friday.)

OSA (Overtime is required for every hour worked on Saturday)

OSH (Overtime is required for every hour worked on Sunday and Holidays)

H/W (Health & Welfare Insurance)

Pensn (Pension)

Vac (Vacation)

Trng (Training)

## Explanations

### WARREN COUNTY

The following list is considered as those days for which holiday rates of wages for work performed apply: New Years Day, Memorial/Decoration Day, Fourth of July, Labor Day, Veterans Day, Thanksgiving Day, Christmas Day. Generally, any of these holidays which fall on a Sunday is celebrated on the following Monday. This then makes work performed on that Monday payable at the appropriate overtime rate for holiday pay. Common practice in a given local may alter certain days of celebration such as the day after Thanksgiving for Veterans Day. If in doubt, please check with IDOL.

Oil and chip resealing (O&C) means the application of road oils and liquid asphalt to coat an existing road surface, followed by application of aggregate chips or gravel to coated surface, and subsequent rolling of material to seal the surface.

### EXPLANATION OF CLASSES

ASBESTOS - GENERAL - removal of asbestos material/mold and hazardous materials from any place in a building, including mechanical systems where those mechanical systems are to be removed. This includes the removal of asbestos materials/mold and hazardous materials from ductwork or pipes in a building when the building is to be demolished at the time or at some close future date.

ASBESTOS - MECHANICAL - removal of asbestos material from mechanical systems, such as pipes, ducts, and boilers, where the mechanical systems are to remain.

### CERAMIC TILE FINISHER, MARBLE FINISHER, TERRAZZO FINISHER

Assisting, helping or supporting the tile, marble and terrazzo mechanic by performing their historic and traditional work assignments required to complete the proper installation of the work covered by said crafts. The term "Ceramic" is used for naming the classification only and is in no way a limitation of the product handled. Ceramic

takes into consideration most hard tiles.

#### ELECTRONIC SYSTEMS TECHNICIAN

Installation, service and maintenance of low-voltage systems which utilizes the transmission and/or transference of voice, sound, vision, or digital for commercial, education, security and entertainment purposes for the following: TV monitoring and surveillance, background/foreground music, intercom and telephone interconnect, field programming, inventory control systems, microwave transmission, multi-media, multiplex, radio page, school, intercom and sound burglar alarms and low voltage master clock systems.

Excluded from this classification are energy management systems, life safety systems, supervisory controls and data acquisition systems not intrinsic with the above listed systems, fire alarm systems, nurse call systems and raceways exceeding fifteen feet in length.

#### LABORER, SKILLED - BUILDING

The skilled laborer building (BLD) classification shall encompass the following types of work, irrespective of the site of the work: tending of carpenters in unloading, handling, stockpiling and distribution operations, also other building crafts, mixing, handling, and conveying of all materials used by masons, plasterers and other building construction crafts, whether done by hand or by any process. The drying of plastering when done by salamander heat, and the cleaning and clearing of all debris. All work pertaining to and in preparation of asbestos abatement and removal. The building of scaffolding and staging for masons and plasterers. The excavations for buildings and all other construction, digging, of trenches, piers, foundations and holes, digging, lagging, sheeting, cribbing, bracing and propping of foundations, holes, caissons, cofferdams, and dikes, the setting of all guidelines for machine or hand excavation and subgrading. The mixing, handling, conveying, pouring, vibrating, gunniting and otherwise applying of concrete, whether by hand or other method of concrete for any walls, foundations, floors, or for other construction concrete sealant men. The wrecking, stripping, dismantling, and handling of concrete forms and false work, and the building of centers for fireproofing purposes. Boring machine, gas, electric or air in preparation for shoving pipe, telephone cable, and so forth, under highways, roads, streets and alleys. All hand and power operating cross cut saws when used for clearing. All work in compressed air construction. All work on acetylene burners in salvaging. The blocking and tamping of concrete. The laying of sewer tile and conduit, and pre-cast materials. The assembling and dismantling of all jacks and sectional scaffolding, including elevator construction and running of slip form jacks. The work of drill running and blasting, including wagon drills. The wrecking, stripping, dismantling, cleaning, moving and oiling of forms. The cutting off of concrete piles. The loading, unloading, handling and carrying to place of installation of all rods, (and materials for use in reinforcing) concrete and the hoisting of same and all signaling where hoist is used in this type of construction coming under the jurisdiction of the Laborers' Union. And, all other labor work not awarded to any other craft. Mortar mixers, kettlemen and carrier of hot stuff, tool crib men, watchmen (Laborer), firemen or salamander tenders, flagmen, deck hands, installation and maintenance of temporary gas-fired heating units, gravel box men, dumpmen and spotters, fencing Laborers, cleaning lumber, pit men, material checkers, dispatchers, unloading explosives, asphalt plant laborers, writer of scale tickets, fireproofing laborers, janitors, asbestos abatement and removal laborers, handling of materials treated with

oil, creosote, chloride, asphalt, and/or foreign material harmful to skin or clothing, Laborers with de-watering systems, gunnite nozzle men, laborers tending masons with hot material or where foreign materials are used, Laborers handling masterplate or similar materials, laser beam operator, concrete burning machine operator, material selector men working with firebrick or combustible material, dynamite men, track laborers, cement handlers, chloride handlers, the unloading and laborers with steel workers and re-bars, concrete workers (wet), luteman, asphalt raker, curb asphalt machine operator, ready mix scalemen, permanent, portable or temporary plant drilling machine operator, plaster tenders, underpinning and shoring of buildings, fire watch, signaling of all power equipment, to include trucks excavating equipment, etc., tree topper or trimmer when in connection to construction, tunnel helpers in free air, batch dumpers, kettle and tar men, tank cleaners, plastic installers, scaffold workers, motorized buggies or motorized unit used for wet concrete or handling of building materials, sewer workers, rod and chain men, vibrator operators, mortar mixer operator, cement silica, clay, fly ash, lime and plasters, handlers (bulk or bag), cofferdam workers, on concrete paving, placing, cutting and tying of reinforcing, deck hand, dredge hand and shore laborers, bankmen on floating plant, asphalt workers with machine & layers, grade checker, power tools, caisson workers, lead man on sewer work, welders, cutters, burners and torch men, chain saw operators, paving breaker, jackhammer and drill operator, layout man and/or drainage tile layer, steel form setters -- street and highway, air tamping hammerman, signal man on crane, concrete saw operator, screen man on asphalt pavers, front end man on chip spreader, multiple concrete duct -- lead man.

#### LABORER, SKILLED - HIGHWAY

The skilled laborer heavy and highway (HWY) classification shall encompass the following types of work, irrespective of the site of the work: handling of materials treated with oil, creosote, asphalt and/or any foreign materials harmful to skin or clothing, track laborers, chloride handlers, the unloading and loading with steel workers and re-bars, concrete workers (wet), tunnel helpers in free air, batch dumpers, mason tenders, kettle and tar men, plastic installers, scaffold workers, motorized buggies or motorized unit used for wet concrete or handling of building materials, laborers with de-watering systems, sewer workers plus depth, rod and chainmen, vibrator operators, mortar mixer operators, cement silica, clay, fly ash, lime and plasters, handlers (bulk or bag), cofferdam workers plus depth, on concrete paving, placing, cutting and tying or reinforcing, deck hand, dredge hand shore laborers, bankmen on floating plant, asphalt workers with machine, and layers, grade checker, power tools, stripping of all concrete forms excluding paving forms, dumpmen and spotters, when necessary, caisson workers plus depth, gunnite nozzle men, welders, cutters, burners and torchmen, chain saw operators, paving breaker, jackhammer and drill operators, layout man and/or drainage tile layer, steel form setters - street and highway, air tamping hammerman, signal man on crane, concrete saw operator, screedman on asphalt pavers, front end man on chip spreader, multiple concrete duct, luteman, asphalt raker, curb asphalt machine operator, ready mix scalemen (portable or temporary plant), laser beam operator, concrete burning machine operator, and coring machine operator.

#### TRUCK DRIVER - BUILDING, HEAVY AND HIGHWAY CONSTRUCTION

Class 1. Drivers on 2 axle trucks hauling less than 9 ton. Air compressor and welding machines and brooms, including those pulled by separate units, truck driver helpers, warehouse employees, mechanic helpers, greasers and tiremen, pickup trucks when hauling materials, tools, or workers to and from and on-the-job site, and fork lifts up

to 6,000 lb. capacity.

Class 2. Two or three axle trucks hauling more than 9 ton but hauling less than 16 ton. A-frame winch trucks, hydrolift trucks, vactor trucks or similar equipment when used for transportation purposes. Fork lifts over 6,000 lb. capacity, winch trucks, four axle combination units, and ticket writers.

Class 3. Two, three or four axle trucks hauling 16 ton or more. Drivers on water pulls, articulated dump trucks, mechanics and working forepersons, and dispatchers. Five axle or more combination units.

Class 4. Low Boy and Oil Distributors.

Class 5. Drivers who require special protective clothing while employed on hazardous waste work.

#### TRUCK DRIVER - OIL AND CHIP RESEALING ONLY.

This shall encompass laborers, workers and mechanics who drive contractor or subcontractor owned, leased, or hired pickup, dump, service, or oil distributor trucks. The work includes transporting materials and equipment (including but not limited to, oils, aggregate supplies, parts, machinery and tools) to or from the job site; distributing oil or liquid asphalt and aggregate; stock piling material when in connection with the actual oil and chip contract. The Truck Driver (Oil & Chip Resealing) wage classification does not include supplier delivered materials.

#### OPERATING ENGINEERS - BUILDING

Class 1. Cranes; Overhead Cranes; Gradall; All Cherry Pickers; Mechanics; Central Concrete Mixing Plant Operator; Road Pavers (27E - Dual Drum - Tri Batchers); Blacktop Plant Operators and Plant Engineers; 3 Drum Hoist; Derricks; Hydro Cranes; Shovels; Skimmer Scoops; Koehring Scooper; Drag Lines; Backhoe; Derrick Boats; Pile Drivers and Skid Rigs; Clamshells; Locomotive Cranes; Dredge (all types) Motor Patrol; Power Blades - Dumore - Elevating and similar types; Tower Cranes (Crawler-Mobile) and Stationary; Crane-type Backfiller; Drott Yumbo and similar types considered as Cranes; Caisson Rigs; Dozer; Tournadozer; Work Boats; Ross Carrier; Helicopter; Tournapulls - all and similar types; Scoops (all sizes); Pushcats; Endloaders (all types); Asphalt Surfacing Machine; Slip Form Paver; Rock Crusher; Heavy Equipment Greaser; CMI, CMI Belt Placer, Auto Grade & 3 Track and similar types; Side Booms; Multiple Unit Earth Movers; Creter Crane; Trench Machine; Pump-crete-Belt Crete-Squeeze Cretes-Screw-type Pumps and Gypsum; Bulker & Pump - Operator will clean; Formless Finishing Machine; Flaherty Spreader or similar types; Screed Man on Laydown Machine; Wheel Tractors (industrial or Farm-type w/Dozer-Hoe-Endloader or other attachments); F.W.D. & Similar Types; Vermeer Concrete Saw.

Class 2. Dinkeys; Power Launches; PH One-pass Soil Cement Machine (and similar types); Pugmill with Pump; Backfillers; Euclid Loader; Forklifts; Jeeps w/Ditching Machine or other attachments; Tuneluger; Automatic Cement and Gravel Batching Plants; Mobile Drills (Soil Testing) and similar types; Gurries and Similar Types; (1) and (2) Drum Hoists (Buck Hoist and Similar Types); Chicago Boom; Boring Machine & Pipe Jacking Machine; Hydro Boom; Dewatering System; Straw Blower; Hydro Seeder; Assistant Heavy Equipment Greaser on Spread; Tractors (Track type) without Power Unit pulling Rollers; Rollers on Asphalt -- Brick Macadem; Concrete Breakers; Concrete Spreaders; Mule

Pulling Rollers; Center Stripper; Cement Finishing Machines & CMI Texture & Reel Curing Machines; Cement Finishing Machine; Barber Green or similar loaders; Vibro Tamper (All similar types) Self-propelled; Winch or Boom Truck; Mechanical Bull Floats; Mixers over 3 Bag to 27E; Tractor pulling Power Blade or Elevating Grader; Porter Rex Rail; Clary Screed; Truck Type Hoptoe Oilers; Fireman; Spray Machine on Paving; Curb Machines; Truck Crane Oilers; Oil Distributor; Truck-Mounted Saws.

Class 3. Air Compressor; Power Subgrader; Straight Tractor; Trac Air without attachments; Herman Nelson Heater, Dravo, Warner, Silent Glo, and similar types; Roller: Five (5) Ton and under on Earth or Gravel; Form Grader; Crawler Crane & Skid Rig Oilers; Freight Elevators - permanently installed; Pump; Light Plant; Generator; Conveyor (1) or (2) - Operator will clean; Welding Machine; Mixer (3) Bag and Under (Standard Capacity with skip); Bulk Cement Plant; Oiler on Central Concrete Mixing Plant.

#### OPERATING ENGINEERS - HEAVY AND HIGHWAY CONSTRUCTION

Class 1. Cranes; Hydro Crane; Shovels; Crane Type Backfiller; Tower Cranes - Mobile & Crawler & Stationary; Derricks & Hoists (3 Drum); Draglines; Drott Yumbo & similar types considered as Cranes; Back Hoe; Derrick Boats; Pile Driver and Skid Rigs; Clam Shell; Locomotive - Cranes; Road Pavers - Single Drum - Dual Drum - Tri Batcher; Motor Patrols & Power Blades - Dumore - Elevating & Similar Types; Mechanics; Central Concrete Mixing Plant Operator; Asphalt Batch Plant Operators and Plant Engineers; Gradall; Caisson Rigs; Skimmer Scoop - Koering Scooper; Dredges (all types); Hoptoe; All Cherry Pickers; Work Boat; Ross Carrier; Helicopter; Dozer; Tornadoizer; Tournapulls - all and similar types; Multiple Unit Earth Movers; Scoops (all sizes); Pushcats; Endloaders (all types); Asphalt Surfacing Machine; Slip Form Paver; Rock Crusher; Heavy Equipment Greaser (top greaser on spread); CMI, Auto Grade, CMI Belt Placer & 3 Track and similar types; Side Booms; Starting Engineer on Pipeline; Asphalt Heater & Planer Combination (used to plane streets); Wheel Tractors (with dozer, hoe or endloader attachments); F.W.D. and Similar types; Blaw Knox Spreader and Similar types; Trench Machines; Pump Crete - Belt Crete - Squeeze Crete - screw type pumps and gypsum (operator will clean); Formless Finishing Machines; Flaherty Spreader or similar types; Screed Man on Laydown Machine; Vermeer Concrete Saw.

Class 2. Bulker & Pump; Power Launches; Boring Machine & Pipe Jacking Machine; Dinkeys; P-H One Pass Soil Cement Machines and similar types; Wheel Tractors (Industry or farm type - other); Back Fillers; Euclid Loader; Fork Lifts; Jeep w/Ditching Machine or other attachments; Tunneluger; Automatic Cement & Gravel Batching Plants; Mobile Drills - Soil Testing and similar types; Pugmill with pump; All (1) and (2) Drum Hoists; Dewatering System; Straw Blower; Hydro-Seeder; Boring Machine; Hydro-Boom; Bump Grinders (self-propelled); Assistant Heavy Equipment Greaser; Apsco Spreader; Tractors (track-type) without Power Units Pulling Rollers on Asphalt - Brick or Macadam; Concrete Breakers; Concrete Spreaders; Cement Strippers; Cement Finishing Machines & CMI Texture & Reel Curing Machines; Vibro-Tampers (all similar types self-propelled); Mechanical Bull Floats; Self-propelled Concrete Saws; Mixers-over three (3) bags to 27E; Winch and Boom Trucks; Tractor Pulling Power Blade or Elevating Grader; Porter Rex Rail; Clary Screed; Mule Pulling Rollers; Pugmill without Pump; Barber Greene or similar Loaders; Track Type Tractor w/Power Unit attached (minimum); Fireman; Spray Machine on Paving; Curb Machines; Paved Ditch Machine; Power Broom; Self-Propelled Conveyors; Power Subgrader; Oil Distributor; Straight Tractor; Truck Crane Oiler; Truck Type Oilers; Directional boring

machine; Horizontal directional drill.

Class 3. Straight framed articulating end pump vehicles and Truck mounted vac unit (separately powered); Trac Air Machine (without attachments); Herman Nelson Heater, Dravo Warner, Silent Glo & similar types; Rollers - five ton and under on earth and gravel; Form Graders; Pumps; Light Plant; Generator; Air Compressor (1) or (2); Conveyor; Welding Machine; Mixer - 3 bags and under; Bulk Cement Plant; Oilers.

#### Other Classifications of Work:

For definitions of classifications not otherwise set out, the Department generally has on file such definitions which are available. If a task to be performed is not subject to one of the classifications of pay set out, the Department will upon being contacted state which neighboring county has such a classification and provide such rate, such rate being deemed to exist by reference in this document. If no neighboring county rate applies to the task, the Department shall undertake a special determination, such special determination being then deemed to have existed under this determination. If a project requires these, or any classification not listed, please contact IDOL at 618/993-7271 for wage rates or clarifications.

#### LANDSCAPING

Landscaping work falls under the existing classifications for laborer, operating engineer and truck driver. The work performed by landscape plantsman and landscape laborer is covered by the existing classification of laborer. The work performed by landscape operators (regardless of equipment used or its size) is covered by the classifications of operating engineer. The work performed by landscape truck drivers (regardless of size of truck driven) is covered by the classifications of truck driver.



# Washington County Prevailing Wage for April 2007

Trade Name	RG	TYP	C	Base	FRMAN	*M-F>8	OSA	OSH	H/W	Pensn	Vac	Trng
=====	==	==	=	=====	=====	=====	==	==	=====	=====	=====	=====
ASBESTOS ABT-GEN		ALL		22.600	23.100	1.5	1.5	2.0	5.250	8.200	0.000	0.600
ASBESTOS ABT-MEC		BLD		25.290	26.290	1.5	1.5	2.0	4.450	2.500	0.000	0.250
BOILERMAKER		BLD		28.500	31.000	1.5	1.5	2.0	6.820	11.03	0.000	0.300
BRICK MASON		BLD		26.400	28.100	1.5	1.5	5.0	4.750	8.250	2.000	0.390
CARPENTER		ALL		30.480	31.980	1.5	1.5	2.0	5.050	3.750	0.000	0.350
CEMENT MASON		BLD		23.500	24.500	1.5	1.5	2.0	5.200	3.550	0.000	0.100
CEMENT MASON		HWY		28.800	29.300	1.5	1.5	2.0	5.200	6.250	0.000	0.300
CERAMIC TILE FNSHER		BLD		22.610	0.000	1.5	1.5	2.0	5.000	4.300	0.000	0.400
ELECTRIC PWR EQMT OP		ALL		31.510	37.980	1.5	2.0	2.0	4.530	7.880	0.000	0.160
ELECTRIC PWR GRNDMAN		ALL		23.530	37.980	1.5	2.0	2.0	3.380	5.890	0.000	0.120
ELECTRIC PWR LINEMAN		ALL		36.220	37.980	1.5	2.0	2.0	5.210	9.060	0.000	0.180
ELECTRIC PWR TRK DRV		ALL		25.710	37.980	1.5	2.0	2.0	3.700	6.430	0.000	0.130
ELECTRICIAN	NW	ALL		32.590	34.550	1.5	1.5	2.0	5.210	6.360	0.000	0.490
ELECTRICIAN	SE	ALL		32.910	35.160	1.5	1.5	2.0	5.150	6.580	0.000	0.490
ELECTRONIC SYS TECH		BLD		25.700	27.200	1.5	1.5	2.0	5.150	3.340	0.000	0.250
ELEVATOR CONSTRUCTOR		BLD		37.115	41.750	2.0	2.0	2.0	8.275	4.460	2.227	0.000
FLOOR LAYER		BLD		26.930	27.680	1.5	1.5	2.0	5.000	3.750	0.000	0.350
GLAZIER		BLD		29.480	0.000	2.0	2.0	2.0	8.550	6.920	2.360	0.160
HT/FROST INSULATOR		BLD		30.440	31.440	1.5	1.5	2.0	4.850	8.360	0.000	0.450
IRON WORKER		ALL		26.350	27.850	1.5	1.5	2.0	6.360	8.250	0.000	0.420
LABORER		ALL		22.100	22.600	1.5	1.5	2.0	5.250	8.200	0.000	0.600
MACHINIST		BLD		36.890	38.890	2.0	2.0	2.0	4.380	5.650	2.550	0.000
MARBLE FINISHERS		BLD		22.610	0.000	1.5	1.5	2.0	5.000	4.300	0.000	0.400
MARBLE MASON		BLD		26.400	28.100	1.5	1.5	5.0	4.750	8.250	2.000	0.390
MILLWRIGHT		ALL		30.480	31.980	1.5	1.5	2.0	5.050	3.750	0.000	0.350
OPERATING ENGINEER		ALL	1	25.900	27.030	1.5	1.5	2.0	6.200	11.45	0.000	1.000
OPERATING ENGINEER		ALL	2	24.770	27.030	1.5	1.5	2.0	6.200	11.45	0.000	1.000
OPERATING ENGINEER		ALL	3	20.290	27.030	1.5	1.5	2.0	6.200	11.45	0.000	1.000
OPERATING ENGINEER		ALL	4	20.350	27.030	1.5	1.5	2.0	6.200	11.45	0.000	1.000
OPERATING ENGINEER		ALL	5	20.020	27.030	1.5	1.5	2.0	6.200	11.45	0.000	1.000
OPERATING ENGINEER		ALL	6	26.450	27.030	1.5	1.5	2.0	6.200	11.45	0.000	1.000
OPERATING ENGINEER		ALL	7	26.750	27.030	1.5	1.5	2.0	6.200	11.45	0.000	1.000
OPERATING ENGINEER		ALL	8	27.030	27.030	1.5	1.5	2.0	6.200	11.45	0.000	1.000
PAINTER		BLD		25.700	26.700	1.5	1.5	2.0	4.650	5.150	0.000	0.350
PAINTER		HWY		26.800	27.800	1.5	1.5	2.0	4.650	5.150	0.000	0.350
PAINTER OVER 30FT		BLD		26.700	27.700	1.5	1.5	2.0	4.650	5.150	0.000	0.350
PAINTER PWR EQMT		BLD		26.700	27.700	1.5	1.5	2.0	4.650	5.150	0.000	0.350
PAINTER PWR EQMT		HWY		27.800	28.800	1.5	1.5	2.0	4.650	5.150	0.000	0.350
PILEDRIVER		ALL		30.480	31.980	1.5	1.5	2.0	5.050	3.750	0.000	0.350
PIPEFITTER	E	BLD		29.500	31.500	1.5	1.5	2.0	5.000	4.850	0.000	0.800
PIPEFITTER	W	BLD		31.000	33.500	1.5	1.5	2.0	5.800	3.950	0.000	0.475
PLASTERER		BLD		23.500	24.500	1.5	1.5	2.0	5.200	3.550	0.000	0.100
PLUMBER	E	BLD		29.500	31.500	1.5	1.5	2.0	5.000	4.850	0.000	0.800
PLUMBER	W	BLD		31.000	33.500	1.5	1.5	2.0	5.800	3.950	0.000	0.475
ROOFER		BLD		26.250	28.250	1.5	1.5	2.0	6.100	5.950	0.000	0.200
SHEETMETAL WORKER		ALL		27.210	28.460	1.5	1.5	2.0	6.000	4.770	1.630	0.120
SPRINKLER FITTER		BLD		34.230	36.480	2.0	2.0	2.0	6.650	7.850	0.000	0.650
TERRAZZO FINISHER		BLD		31.240	0.000	1.5	1.5	2.0	0.000	0.000	0.000	0.000
TERRAZZO MASON		BLD		30.780	31.080	1.5	1.5	2.0	0.000	3.750	0.000	0.000
TRUCK DRIVER		ALL	1	25.930	0.000	1.5	1.5	2.0	7.250	3.425	0.000	0.000
TRUCK DRIVER		ALL	2	26.330	0.000	1.5	1.5	2.0	7.250	3.425	0.000	0.000
TRUCK DRIVER		ALL	3	26.530	0.000	1.5	1.5	2.0	7.250	3.425	0.000	0.000
TRUCK DRIVER		ALL	4	26.780	0.000	1.5	1.5	2.0	7.250	3.425	0.000	0.000
TRUCK DRIVER		ALL	5	27.530	0.000	1.5	1.5	2.0	7.250	3.425	0.000	0.000
TRUCK DRIVER		O&C	1	20.740	0.000	1.5	1.5	2.0	7.250	3.425	0.000	0.000
TRUCK DRIVER		O&C	2	21.060	0.000	1.5	1.5	2.0	7.250	3.425	0.000	0.000
TRUCK DRIVER		O&C	3	21.220	0.000	1.5	1.5	2.0	7.250	3.425	0.000	0.000
TRUCK DRIVER		O&C	4	21.420	0.000	1.5	1.5	2.0	7.250	3.425	0.000	0.000

TRUCK DRIVER O&C 5 22.020 0.000 1.5 1.5 2.0 7.250 3.425 0.000 0.000

Legend:

M-F>8 (Overtime is required for any hour greater than 8 worked each day, Monday through Friday.)

OSA (Overtime is required for every hour worked on Saturday)

OSH (Overtime is required for every hour worked on Sunday and Holidays)

H/W (Health & Welfare Insurance)

Pensn (Pension)

Vac (Vacation)

Trng (Training)

## Explanations

WASHINGTON COUNTY

ELECTRICIANS (NORTHWEST) - Township of Venedy.

PLUMBERS & PIPEFITTERS (WEST) - That part of the county West of a line 2.5 miles East of Rt. 127 including the towns of Posin, Beacoup and New Minden.

PLUMBERS & PIPEFITTERS (EAST) - That part of the county East of a North-South line 2.5 miles East of Rt. 127.

The following list is considered as those days for which holiday rates of wages for work performed apply: New Years Day, Memorial/Decoration Day, Fourth of July, Labor Day, Veterans Day, Thanksgiving Day, Christmas Day. Generally, any of these holidays which fall on a Sunday is celebrated on the following Monday. This then makes work performed on that Monday payable at the appropriate overtime rate for holiday pay. Common practice in a given local may alter certain days of celebration such as the day after Thanksgiving for Veterans Day. If in doubt, please check with IDOL.

Oil and chip resealing (O&C) means the application of road oils and liquid asphalt to coat an existing road surface, followed by application of aggregate chips or gravel to coated surface, and subsequent rolling of material to seal the surface.

EXPLANATION OF CLASSES

ASBESTOS - GENERAL - removal of asbestos material/mold and hazardous materials from any place in a building, including mechanical systems where those mechanical systems are to be removed. This includes the removal of asbestos materials/mold and hazardous materials from ductwork or pipes in a building when the building is to be demolished at the time or at some close future date.

ASBESTOS - MECHANICAL - removal of asbestos material from mechanical systems, such as pipes, ducts, and boilers, where the mechanical systems are to remain.

CERAMIC TILE FINISHER AND MARBLE FINISHER

The handling, at the building site, of all sand, cement, tile, marble or stone and all other materials that may be used and installed by [a] tile layer or marble mason. In addition, the grouting, cleaning, sealing, and mixing on the job site, and all other work as required in assisting the setter. The term "Ceramic" is used for naming the classification only and is in no way a limitation of the product handled. Ceramic takes into consideration most hard tiles.

#### ELECTRONIC SYSTEMS TECHNICIAN

Installation, service and maintenance of low-voltage systems which utilizes the transmission and/or transference of voice, sound, vision, or digital for commercial, education, security and entertainment purposes for the following: TV monitoring and surveillance, background/foreground music, intercom and telephone interconnect, field programming, inventory control systems, microwave transmission, multi-media, multiplex, radio page, school, intercom and sound burglar alarms and low voltage master clock systems.

Excluded from this classification are energy management systems, life safety systems, supervisory controls and data acquisition systems not intrinsic with the above listed systems, fire alarm systems, nurse call systems and raceways exceeding fifteen feet in length.

#### TRUCK DRIVER - BUILDING, HEAVY AND HIGHWAY CONSTRUCTION

Class 1. Drivers on 2 axle trucks hauling less than 9 ton. Air compressor and welding machines and brooms, including those pulled by separate units, truck driver helpers, warehouse employees, mechanic helpers, greasers and tiremen, pickup trucks when hauling materials, tools, or workers to and from and on-the-job site, and fork lifts up to 6,000 lb. capacity.

Class 2. Two or three axle trucks hauling more than 9 ton but hauling less than 16 ton. A-frame winch trucks, hydrolift trucks, vector trucks or similar equipment when used for transportation purposes. Fork lifts over 6,000 lb. capacity, winch trucks, four axle combination units, and ticket writers.

Class 3. Two, three or four axle trucks hauling 16 ton or more. Drivers on water pulls, articulated dump trucks, mechanics and working forepersons, and dispatchers. Five axle or more combination units.

Class 4. Low Boy and Oil Distributors.

Class 5. Drivers who require special protective clothing while employed on hazardous waste work. Jurisdiction in Bond, Calhoun, Clinton, Fayette, Greene, Jefferson, Jersey, Macoupin, Madison, Marion, Monroe, Montgomery, Perry, Randolph, St. Clair, and Washington.

#### TRUCK DRIVER - OIL AND CHIP RESEALING ONLY.

This shall encompass laborers, workers and mechanics who drive contractor or subcontractor owned, leased, or hired pickup, dump, service, or oil distributor trucks. The work includes transporting materials and equipment (including but not limited to, oils, aggregate supplies, parts, machinery and tools) to or from the job site; distributing oil or liquid asphalt and aggregate; stock piling material when in connection with the actual oil and chip contract. The Truck Driver (Oil & Chip Resealing) wage classification does not include supplier delivered materials.

## OPERATING ENGINEERS

GROUP I. Cranes, Dragline, Shovels, Skimmer Scoops, Clamshells or Derrick Boats, Pile Drivers, Crane-Type Backhoes, Asphalt Plant Operators, Concrete Plant Operators, Dredges, Asphalt Spreading Machines, All Locomotives, Cable Ways, or Tower Machines, Hoists, Hydraulic Backhoes, Ditching Machines or Backfiller, Cherrypickers, Overhead Cranes, Roller, Steam or Gas, Concrete Pavers, Excavators, Concrete Breakers, Concrete Pumps, Bulk Cement Plants, Cement Pumps, Derrick-Type Drills, Boat Operators, Motor Graders or Pushcats, Scoops or Tournapulls, Bulldozers, Endloaders or Fork Lifts, Power Blade or Elevating Graders, Winch Cats, Boom or Winch Trucks or Boom Tractors, Pipe Wrapping or Painting Machines, Asphalt Plant Engineer, Journeyman Lubricating Engineer, Drills (other than Derrick Type), Mud Jacks, or Well Drilling Machines, Boring Machines or Track Jacks, Mixers, Conveyors (Two), Air Compressors (Two), Water Pumps regardless of size (Two), Welding Machines (Two), Siphons or Jets (Two), Winch Heads or Apparatuses (Two), Light Plants (Two), Waterblasters (two), All Tractors regardless of size (straight tractor only), Fireman on Stationary Boilers, Automatic Elevators, Form Grading Machines, Finishing Machines, Power Sub-Grader or Ribbon Machines, Longitudinal Floats, Distributor Operators on Trucks, Winch Heads or Apparatuses (One), Mobil Track air and heaters (two to five), Heavy Equipment Greaser, Relief Operator, Assistant Master Mechanic and Heavy Duty Mechanic, all Operators (except those listed below).

GROUP II. Assistant Operators.

GROUP III. Air Compressors (One), Water Pumps, regardless of Size (One), Waterblasters (one), Welding Machine (One), Mixers (One Bag), Conveyor (One), Siphon or Jet (One), Light Plant (One), Heater (One), Immobile Track Air (One), and Self Propelled Walk-Behind Rollers.

GROUP IV. Asphalt Spreader Oilers, Fireman on Whirlies and Heavy Equipment Oilers, Truck Cranes, Dredges, Monigans, Large Cranes - (Over 65-ton rated capacity) Concrete Plant Oiler, Blacktop Plant Oiler, and Creter Crane Oiler (when required).

GROUP V. Oiler.

GROUP VI. Master Mechanics, Operators on equipment with Booms, including jibs, 100 feet and over, and less than 150 feet long.

GROUP VII. Operators on equipment with Booms, including jibs, 150 feet and over, and less than 200 feet long.

GROUP VIII. Operators on Equipment with Booms, including jibs, 200 feet and over; Tower Cranes; Whirlie Cranes; and Operator Foreman.

## TERRAZZO FINISHER

The handling of all materials used for Mosaic and Terrazzo work including preparing, mixing by hand, by mixing machine or transporting of pre-mixed materials and distributing with shovel, rake, hoe, or pail, all kinds of concrete foundations necessary for Mosaic and Terrazzo work, all cement terrazzo, magnesite terrazzo, Do-O-Tex terrazzo, epoxy matrix ter-razzo, exposed aggregate, rustic or rough washed for exterior or interior of buildings placed either by machine or by hand, and any other kind of mixture of plastics composed of chips or granules when mixed with cement, rubber, neoprene, vinyl, magnesium chloride or any other resinous or chemical substances used for seamless flooring systems, and all other building materials, all similar materials and all precast terrazzo work on jobs, all scratch

coat used for Mosaic and Terrazzo work and sub-bed, tar paper and wire mesh (2x2 etc.) or lath. The rubbing, grinding, cleaning and finishing of same either by hand or by machine or by terrazzo resurfacing equipment on new or existing floors. When necessary finishers shall be allowed to assist the mechanics to spread sand bed, lay tarpaper and wire mesh (2x2 etc.) or lath. The finishing of cement floors where additional aggregate of stone is added by spreading or sprinkling on top of the finished base, and troweled or rolled into the finish and then the surface is ground by grinding machines.

#### Other Classifications of Work:

For definitions of classifications not otherwise set out, the Department generally has on file such definitions which are available. If a task to be performed is not subject to one of the classifications of pay set out, the Department will upon being contacted state which neighboring county has such a classification and provide such rate, such rate being deemed to exist by reference in this document. If no neighboring county rate applies to the task, the Department shall undertake a special determination, such special determination being then deemed to have existed under this determination. If a project requires these, or any classification not listed, please contact IDOL at 618/993-7271 for wage rates or clarifications.

#### LANDSCAPING

Landscaping work falls under the existing classifications for laborer, operating engineer and truck driver. The work performed by landscape plantsman and landscape laborer is covered by the existing classification of laborer. The work performed by landscape operators (regardless of equipment used or its size) is covered by the classifications of operating engineer. The work performed by landscape truck drivers (regardless of size of truck driven) is covered by the classifications of truck driver.

# Wayne County Prevailing Wage for April 2007

Trade Name	RG	TYP	C	Base	FRMAN	*M-F>8	OSA	OSH	H/W	Pensn	Vac	Trng
ASBESTOS ABT-GEN		ALL		20.750	21.200	1.5	1.5	2.0	5.250	5.600	0.000	0.700
ASBESTOS ABT-MEC		BLD		20.800	0.000	2.0	2.0	2.0	5.000	3.400	0.000	0.000
BOILERMAKER		BLD		28.500	31.000	1.5	1.5	2.0	6.820	11.03	0.000	0.300
BRICK MASON		BLD		25.470	26.970	1.5	1.5	2.0	6.000	5.400	0.000	0.425
CARPENTER		BLD		27.780	29.280	1.5	1.5	2.0	5.050	3.750	0.000	0.350
CARPENTER		HWY		27.730	29.480	1.5	1.5	2.0	5.050	3.750	0.000	0.350
CEMENT MASON		BLD		23.500	24.500	1.5	1.5	2.0	5.200	3.550	0.000	0.100
CEMENT MASON		HWY		23.500	25.000	1.5	1.5	2.0	5.200	2.750	0.000	0.200
CERAMIC TILE FNSHER		BLD		24.990	0.000	1.5	1.5	2.0	6.000	5.400	0.000	0.425
ELECTRICIAN		ALL		32.910	35.160	1.5	1.5	2.0	5.150	6.580	0.000	0.490
ELECTRONIC SYS TECH		BLD		25.700	27.200	1.5	1.5	2.0	5.150	3.340	0.000	0.250
FLOOR LAYER		BLD		26.930	27.680	1.5	1.5	2.0	5.000	3.750	0.000	0.350
GLAZIER		BLD		22.930	0.000	1.5	1.5	2.0	4.320	3.800	0.000	0.300
HT/FROST INSULATOR		BLD		26.110	27.110	1.5	1.5	2.0	4.800	6.860	0.000	0.190
IRON WORKER		ALL		24.000	25.250	1.5	1.5	2.0	5.780	6.850	0.000	0.345
LABORER		BLD		20.750	21.200	1.5	1.5	2.0	5.250	5.600	0.000	0.600
LABORER		HWY		21.000	21.450	1.5	1.5	2.0	5.350	6.150	0.000	0.600
MACHINIST		BLD		36.890	38.890	2.0	2.0	2.0	4.380	5.650	2.550	0.000
MARBLE FINISHERS		BLD		24.990	0.000	1.5	1.5	2.0	6.000	5.400	0.000	0.425
MARBLE MASON		BLD		25.470	26.970	1.5	1.5	2.0	6.000	5.400	0.000	0.425
MILLWRIGHT		BLD		27.780	29.280	1.5	1.5	2.0	5.050	3.750	0.000	0.350
MILLWRIGHT		HWY		28.230	29.980	1.5	1.5	2.0	5.050	3.750	0.000	0.350
OPERATING ENGINEER		ALL	1	28.650	0.000	1.5	1.5	2.0	5.200	6.750	0.000	0.650
OPERATING ENGINEER		ALL	2	18.600	0.000	1.5	1.5	2.0	5.200	6.750	0.000	0.650
PAINTER		ALL		20.700	21.200	1.5	1.5	2.0	4.650	4.200	0.000	0.250
PAINTER OVER 30FT		ALL		23.800	24.300	1.5	1.5	2.0	4.650	4.200	0.000	0.250
PAINTER PWR EQMT		ALL		23.800	24.300	1.5	1.5	2.0	4.650	4.200	0.000	0.250
PILEDRIVER		BLD		27.780	29.280	1.5	1.5	2.0	5.050	3.750	0.000	0.350
PILEDRIVER		HWY		28.230	29.980	1.5	1.5	2.0	5.050	3.750	0.000	0.350
PIPEFITTER		BLD		28.750	31.620	1.5	1.5	2.0	6.000	7.500	0.000	0.400
PLASTERER		BLD		23.500	24.500	1.5	1.5	2.0	5.200	3.550	0.000	0.100
PLUMBER		BLD		29.500	32.450	1.5	1.5	2.0	6.600	7.500	0.000	0.550
ROOFER		BLD		19.700	20.500	1.5	1.5	2.0	5.700	3.800	0.000	0.000
SHEETMETAL WORKER		ALL		27.210	28.460	1.5	1.5	2.0	6.000	4.770	1.630	0.120
SPRINKLER FITTER		BLD		31.240	33.240	1.5	1.5	2.0	6.500	5.350	0.000	0.250
STONE MASON		BLD		25.470	26.970	1.5	1.5	2.0	6.000	5.400	0.000	0.425
TERRAZZO FINISHER		BLD		24.990	0.000	1.5	1.5	2.0	6.000	5.400	0.000	0.425
TERRAZZO MASON		BLD		28.500	28.800	1.5	1.5	2.0	0.000	2.950	0.000	0.000
TRUCK DRIVER		ALL	1	25.930	0.000	1.5	1.5	2.0	7.250	3.425	0.000	0.000
TRUCK DRIVER		ALL	2	26.330	0.000	1.5	1.5	2.0	7.250	3.425	0.000	0.000
TRUCK DRIVER		ALL	3	26.530	0.000	1.5	1.5	2.0	7.250	3.425	0.000	0.000
TRUCK DRIVER		ALL	4	26.780	0.000	1.5	1.5	2.0	7.250	3.425	0.000	0.000
TRUCK DRIVER		ALL	5	27.530	0.000	1.5	1.5	2.0	7.250	3.425	0.000	0.000
TUCKPOINTER		BLD		25.470	26.970	1.5	1.5	2.0	6.000	5.400	0.000	0.425

Legend :

M-F>8 (Overtime is required for any hour greater than 8 worked each day, Monday through Friday.)

OSA (Overtime is required for every hour worked on Saturday)

OSH (Overtime is required for every hour worked on Sunday and Holidays)

H/W (Health & Welfare Insurance)

Pensn (Pension)

Vac (Vacation)

Trng (Training)

## Explanations

### WAYNE COUNTY

The following list is considered as those days for which holiday rates of wages for work performed apply: New Years Day, Memorial/Decoration Day, Fourth of July, Labor Day, Veterans Day, Thanksgiving Day, Christmas Day. Generally, any of these holidays which fall on a Sunday is celebrated on the following Monday. This then makes work performed on that Monday payable at the appropriate overtime rate for holiday pay. Common practice in a given local may alter certain days of celebration such as the day after Thanksgiving for Veterans Day. If in doubt, please check with IDOL.

### EXPLANATION OF CLASSES

ASBESTOS - GENERAL - removal of asbestos material/mold and hazardous materials from any place in a building, including mechanical systems where those mechanical systems are to be removed. This includes the removal of asbestos materials/mold and hazardous materials from ductwork or pipes in a building when the building is to be demolished at the time or at some close future date.

ASBESTOS - MECHANICAL - removal of asbestos material from mechanical systems, such as pipes, ducts, and boilers, where the mechanical systems are to remain.

### CERAMIC TILE FINISHER, MARBLE FINISHER, TERRAZZO FINISHER

Assisting, helping or supporting the tile, marble and terrazzo mechanic by performing their historic and traditional work assignments required to complete the proper installation of the work covered by said crafts. The term "Ceramic" is used for naming the classification only, and is in no a limitation of the product handled. Ceramic takes into consideration most hard tiles.

### ELECTRONIC SYSTEMS TECHNICIAN

Installation, service and maintenance of low-voltage systems which utilizes the transmission and/or transference of voice, sound, vision, or digital for commercial, education, security and entertainment purposes for the following: TV monitoring and surveillance, background/foreground music, intercom and telephone interconnect, field programming, inventory control systems, microwave transmission, multi-media, multiplex, radio page, school, intercom and sound burglar alarms and low voltage master clock systems.

Excluded from this classification are energy management systems, life safety systems, supervisory controls and data acquisition systems not intrinsic with the above listed systems, fire alarm systems, nurse call systems and raceways exceeding fifteen feet in length.

### TRUCK DRIVER - BUILDING, HEAVY AND HIGHWAY CONSTRUCTION

Class 1. Drivers on 2 axle trucks hauling less than 9 ton. Air

compressor and welding machines and brooms, including those pulled by separate units, truck driver helpers, warehouse employees, mechanic helpers, greasers and tiremen, pickup trucks when hauling materials, tools, or workers to and from and on-the-job site, and fork lifts up to 6,000 lb. capacity.

Class 2. Two or three axle trucks hauling more than 9 ton but hauling less than 16 ton. A-frame winch trucks, hydrolift trucks, vactor trucks or similar equipment when used for transportation purposes. Fork lifts over 6,000 lb. capacity, winch trucks, four axle combination units, and ticket writers.

Class 3. Two, three or four axle trucks hauling 16 ton or more. Drivers on water pulls, articulated dump trucks, mechanics and working forepersons, and dispatchers. Five axle or more combination units.

Class 4. Low Boy and Oil Distributors.

Class 5. Drivers who require special protective clothing while employed on hazardous waste work.

#### OPERATING ENGINEERS - BUILDING, HEAVY AND HIGHWAY CONSTRUCTION

Class 1. Power Cranes, Draglines, Derricks, Shovels, Gradalls, Mechanics, Tractor Highlift, Tournadozer, Concrete Mixers with Skip, Tournamixer, Two Drum Machine, One Drum Hoist with Tower or Boom, Cableways, Tower Machines, Motor Patrol, Boom Tractor, Boom or Winch Truck, Winch or Hydraulic Boom Truck, Truck Crane, Tournapull, Tractor Operating Scoops, Bulldozer, Push Tractor, Asphalt Planer, Finishing Machine on Asphalt, Large Rollers on Earth, Rollers on Asphalt Mix, Ross Carrier or similar Machine, Gravel Processing Machine, Asphalt Plant Engineer, Paver Operator, Dredging Equipment, or Dredge Engineer, or Dredge Operator, Central Mix Plant Engineer, CMI or similar type machine, Concrete Pump, Truck or Skid Mounted, Tower Crane, Engineer or Rock Crusher Plant, Concrete Plant Engineer, Ditching Machine with dual attachment, Tractor Mounted Loaders, Cherry Picker, Hydro Crane, Standard or Dinkey Locomotives, Scoopmobiles, Euclid Loader, Soil Cement Machine, Back Filler, Elevating Machine, Power Blade, Drilling Machine, including Well Testing, Caissons, Shaft or any similar type drilling machines, Motor Driven Paint Machine, Pipe Cleaning Machine, Pipe Wrapping Machine, Pipe Bending Machine, Apsco Paver, Boring Machine, (Head Equipment Greaser), Barber-Greene Loaders, Formless Paver, (Well Point System), Concrete Spreader, Hydra Ax, Span Saw, Marine Scoops, Brush Mulcher, Brush Burner, Mesh Placer, Tree Mover, Helicopter Crew (3), Piledriver-Skid or Crawler, Stump Remover, Root Rake, Tug Boat Operator, Refrigerating Machine, Freezing Operator, Chair Cart-Self-Propelled, Hydra Seeder, Straw Blower, Power Sub Grader, Bull Float, Finishing Machine, Self-Propelled Pavement Breaker, Lull (or similar type Machine), Two Air Compressors, Compressors hooked in Manifold, Overhead Crane, Chip Spreader, Mud Cat, Sull-Air, Fork Lifts (except when used for landscaping work), Soil Stabilizer (Seaman Tiller, Bo Mag, Rago Gator, and similar types of equipment), Tube Float, Spray Machine, Curing Machine, Concrete or Asphalt Milling Machine, Snooper Truck-Operator, Backhoe, Farm Tractors (with attachments), 4 Point Lift System (Power Lift or similar type), Skid-Steer (Bob Cat or similar type), Wrecking Shears, Water Blaster.

Class 2. Concrete Mixers without Skips, Rock Crusher, Ditching Machine under 6', Curbing Machine, One Drum Machines without Tower or Boom, Air Tugger, Self-Propelled Concrete Saw, Machine Mounted Post Hole Digger, two to four Generators, Water Pumps or Welding Machines, within 400 feet, Air Compressor 600 cu. ft. and under, Rollers on



Aggregate and Seal Coat Surfaces, Fork Lift (when used for landscaping work), Concrete and Blacktop Curb Machine, One Water Pump, Oilers, Air Valves or Steam Valves, One Welding Machine, Truck Jack, Mud Jack, Gunnite Machine, House Elevators when used for hoisting material, Engine Tenders, Fireman, Wagon Drill, Flex Plane, Conveyor, Siphons and Pulsometer, Switchman, Fireman on Paint Pots, Fireman on Asphalt Plants, Distributor Operator on Trucks, Tampers, Self-Propelled Power Broom, Striping Machine (motor driven), Form Tamper, Bulk Cement Plant, Equipment Greaser, Deck Hands, Truck Crane Oiler-Driver, Cement Blimps, Form Grader, Temporary Heat, Throttle Valve, Super Sucker (and similar type of equipment).

#### Other Classifications of Work:

For definitions of classifications not otherwise set out, the Department generally has on file such definitions which are available. If a task to be performed is not subject to one of the classifications of pay set out, the Department will upon being contacted state which neighboring county has such a classification and provide such rate, such rate being deemed to exist by reference in this document. If no neighboring county rate applies to the task, the Department shall undertake a special determination, such special determination being then deemed to have existed under this determination. If a project requires these, or any classification not listed, please contact IDOL at 618/993-7271 for wage rates or clarifications.

#### LANDSCAPING

Landscaping work falls under the existing classifications for laborer, operating engineer and truck driver. The work performed by landscape plantsman and landscape laborer is covered by the existing classification of laborer. The work performed by landscape operators (regardless of equipment used or its size) is covered by the classifications of operating engineer. The work performed by landscape truck drivers (regardless of size of truck driven) is covered by the classifications of truck driver.

# White County Prevailing Wage for April 2007

Trade Name	RG	TYP	C	Base	FRMAN	*M-F>8	OSA	OSH	H/W	Pensn	Vac	Trng
=====	==	==	=	=====	=====	=====	==	==	=====	=====	=====	=====
ASBESTOS ABT-GEN		ALL		20.750	21.200	1.5	1.5	2.0	5.250	5.600	0.000	0.700
ASBESTOS ABT-MEC		BLD		20.800	0.000	2.0	2.0	2.0	5.000	3.400	0.000	0.000
BOILERMAKER		BLD		28.500	31.000	1.5	1.5	2.0	6.820	11.03	0.000	0.300
BRICK MASON		BLD		25.470	26.970	1.5	1.5	2.0	6.000	5.400	0.000	0.425
CARPENTER		BLD		27.780	29.280	1.5	1.5	2.0	5.050	3.750	0.000	0.350
CARPENTER		HWY		27.730	29.480	1.5	1.5	2.0	5.050	3.750	0.000	0.350
CEMENT MASON		BLD		23.500	24.500	1.5	1.5	2.0	5.200	3.550	0.000	0.100
CEMENT MASON		HWY		23.500	25.000	1.5	1.5	2.0	5.200	2.750	0.000	0.200
CERAMIC TILE FNSHER		BLD		24.990	0.000	1.5	1.5	2.0	6.000	5.400	0.000	0.425
ELECTRICIAN		ALL		32.910	35.160	1.5	1.5	2.0	5.150	6.580	0.000	0.490
ELECTRONIC SYS TECH		BLD		25.700	27.200	1.5	1.5	2.0	5.150	3.340	0.000	0.250
FLOOR LAYER		BLD		26.930	27.680	1.5	1.5	2.0	5.000	3.750	0.000	0.350
GLAZIER		BLD		22.930	0.000	1.5	1.5	2.0	4.320	3.800	0.000	0.300
HT/FROST INSULATOR		BLD		26.110	27.110	1.5	1.5	2.0	4.800	6.860	0.000	0.190
IRON WORKER		ALL		24.000	25.250	1.5	1.5	2.0	5.780	6.850	0.000	0.345
LABORER		BLD		20.750	21.200	1.5	1.5	2.0	5.250	5.600	0.000	0.600
LABORER		HWY		21.000	21.450	1.5	1.5	2.0	5.350	6.150	0.000	0.600
MACHINIST		BLD		36.890	38.890	2.0	2.0	2.0	4.380	5.650	2.550	0.000
MARBLE FINISHERS		BLD		24.990	0.000	1.5	1.5	2.0	6.000	5.400	0.000	0.425
MARBLE MASON		BLD		25.470	26.970	1.5	1.5	2.0	6.000	5.400	0.000	0.425
MILLWRIGHT		BLD		27.780	29.280	1.5	1.5	2.0	5.050	3.750	0.000	0.350
MILLWRIGHT		HWY		28.230	29.980	1.5	1.5	2.0	5.050	3.750	0.000	0.350
OE RIVER 1		RIV 1		26.900	0.000	1.5	1.5	2.0	5.650	6.100	0.000	1.100
OE RIVER 2		RIV 2		23.450	0.000	1.5	1.5	2.0	5.650	6.100	0.000	1.100
OPERATING ENGINEER		ALL 1		26.800	27.800	1.5	1.5	2.0	5.650	6.100	0.000	1.100
OPERATING ENGINEER		ALL 2		24.900	27.800	1.5	1.5	2.0	5.650	6.100	0.000	1.100
OPERATING ENGINEER		ALL 3		24.150	27.800	1.5	1.5	2.0	5.650	6.100	0.000	1.100
OPERATING ENGINEER		ALL 4		21.400	27.800	1.5	1.5	2.0	5.650	6.100	0.000	1.100
OPERATING ENGINEER		O&C 1		20.100	21.100	1.5	1.5	2.0	5.650	6.100	0.000	1.100
OPERATING ENGINEER		O&C 2		18.680	21.100	1.5	1.5	2.0	5.650	6.100	0.000	1.100
OPERATING ENGINEER		O&C 3		18.120	21.100	1.5	1.5	2.0	5.650	6.100	0.000	1.100
OPERATING ENGINEER		O&C 4		16.050	21.100	1.5	1.5	2.0	5.650	6.100	0.000	1.100
PAINTER		BLD		22.850	23.850	1.5	1.5	2.0	5.150	3.950	0.000	0.250
PAINTER		HWY		24.000	25.000	1.5	1.5	2.0	5.150	3.950	0.000	0.250
PAINTER OVER 30FT		BLD		23.600	24.600	1.5	1.5	2.0	5.150	3.950	0.000	0.250
PAINTER PWR EQMT		BLD		23.850	24.850	1.5	1.5	2.0	5.150	3.950	0.000	0.250
PAINTER PWR EQMT		HWY		25.000	26.000	1.5	1.5	2.0	5.150	3.950	0.000	0.250
PILEDRIVER		BLD		27.780	29.280	1.5	1.5	2.0	5.050	3.750	0.000	0.350
PILEDRIVER		HWY		28.230	29.980	1.5	1.5	2.0	5.050	3.750	0.000	0.350
PIPEFITTER		BLD		27.580	29.230	1.5	1.5	2.0	5.450	7.010	0.000	0.700
PLASTERER		BLD		23.500	24.500	1.5	1.5	2.0	5.200	3.550	0.000	0.100
PLUMBER		BLD		27.580	29.230	1.5	1.5	2.0	5.450	7.010	0.000	0.700
ROOFER		BLD		24.690	26.190	1.5	1.5	2.0	4.380	4.000	0.000	0.000
SHEETMETAL WORKER		ALL		27.210	28.460	1.5	1.5	2.0	6.000	4.770	1.630	0.120
SPRINKLER FITTER		BLD		31.240	33.240	1.5	1.5	2.0	6.500	5.350	0.000	0.250
STONE MASON		BLD		25.470	26.970	1.5	1.5	2.0	6.000	5.400	0.000	0.425
TERRAZZO FINISHER		BLD		24.990	0.000	1.5	1.5	2.0	6.000	5.400	0.000	0.425
TRUCK DRIVER		ALL 1		24.990	0.000	1.5	1.5	2.0	7.250	4.200	0.000	0.000
TRUCK DRIVER		ALL 2		25.390	0.000	1.5	1.5	2.0	7.250	4.200	0.000	0.000
TRUCK DRIVER		ALL 3		25.590	0.000	1.5	1.5	2.0	7.250	4.200	0.000	0.000
TRUCK DRIVER		ALL 4		25.840	0.000	1.5	1.5	2.0	7.250	4.200	0.000	0.000
TRUCK DRIVER		ALL 5		26.590	0.000	1.5	1.5	2.0	7.250	4.200	0.000	0.000
TUCKPOINTER		BLD		25.470	26.970	1.5	1.5	2.0	6.000	5.400	0.000	0.425

Legend:

M-F>8 (Overtime is required for any hour greater than 8 worked each day, Monday through Friday.)

OSA (Overtime is required for every hour worked on Saturday)

OSH (Overtime is required for every hour worked on Sunday and Holidays)

H/W (Health & Welfare Insurance)

Pensn (Pension)

Vac (Vacation)

Trng (Training)

## Explanations

### WHITE COUNTY

The following list is considered as those days for which holiday rates of wages for work performed apply: New Years Day, Memorial/Decoration Day, Fourth of July, Labor Day, Veterans Day, Thanksgiving Day, Christmas Day. Generally, any of these holidays which fall on a Sunday is celebrated on the following Monday. This then makes work performed on that Monday payable at the appropriate overtime rate for holiday pay. Common practice in a given local may alter certain days of celebration such as the day after Thanksgiving for Veterans Day. If in doubt, please check with IDOL.

### EXPLANATION OF CLASSES

ASBESTOS - GENERAL - removal of asbestos material/mold and hazardous materials from any place in a building, including mechanical systems where those mechanical systems are to be removed. This includes the removal of asbestos materials/mold and hazardous materials from ductwork or pipes in a building when the building is to be demolished at the time or at some close future date.

ASBESTOS - MECHANICAL - removal of asbestos material from mechanical systems, such as pipes, ducts, and boilers, where the mechanical systems are to remain.

### CERAMIC TILE FINISHER, MARBLE FINISHER, TERRAZZO FINISHER

Assisting, helping or supporting the tile, marble and terrazzo mechanic by performing their historic and traditional work assignments required to complete the proper installation of the work covered by said crafts. The term "Ceramic" is used for naming the classification only, and is in no a limitation of the product handled. Ceramic takes into consideration most hard tiles.

### ELECTRONIC SYSTEMS TECHNICIAN

Installation, service and maintenance of low-voltage systems which utilizes the transmission and/or transference of voice, sound, vision, or digital for commercial, education, security and entertainment purposes for the following: TV monitoring and surveillance, background/foreground music, intercom and telephone interconnect, field programming, inventory control systems, microwave transmission, multi-media, multiplex, radio page, school, intercom and sound burglar alarms and low voltage master clock systems.

Excluded from this classification are energy management systems, life safety systems, supervisory controls and data acquisition systems not intrinsic with the above listed systems, fire alarm systems, nurse call systems and raceways exceeding fifteen feet in length.

#### TRUCK DRIVER - BUILDING, HEAVY AND HIGHWAY CONSTRUCTION

Class 1. Drivers on 2 axle trucks hauling less than 9 ton. Air compressor and welding machines and brooms, including those pulled by separate units, truck driver helpers, warehouse employees, mechanic helpers, greasers and tiremen, pickup trucks when hauling materials, tools, or workers to and from and on-the-job site, and fork lifts up to 6,000 lb. capacity.

Class 2. Two or three axle trucks hauling more than 9 ton but hauling less than 16 ton. A-frame winch trucks, hydrolift trucks, vactor trucks or similar equipment when used for transportation purposes. Fork lifts over 6,000 lb. capacity, winch trucks, four axle combination units, and ticket writers.

Class 3. Two, three or four axle trucks hauling 16 ton or more. Drivers on water pulls, articulated dump trucks, mechanics and working forepersons, and dispatchers. Five axle or more combination units.

Class 4. Low Boy and Oil Distributors.

Class 5. Drivers who require special protective clothing while employed on hazardous waste work.

#### OPERATING ENGINEERS - BUILDING, HEAVY AND HIGHWAY CONSTRUCTION

Class 1. APSCO or Equal Spreading Machine, Backhoe, Backfiller, Boom or Winch Cat, Bituminous Mixplane Machine, Blacksmith, Bituminous Surfacing Machine, Bull-Dozer, Crane, Shovel, Dragline, Truck Crane, Pile Driver, Concrete Breaker, Concrete or Pumpcrete Pumps, Dinky or Standard Locomotives, Well or Caisson Drills, Elevating Grader, Fork Lifts, Flexplane, Gradeall, Hi-Lift Hoists, Guy-Derricks, Hysters, Mechanic Motor Patrol, Mixers-21 cu. ft. or over, Push Cats, Pulls and Scrapers, Two Well Point Pumps, Pulverizer or Tiller, PugMill, Rubber-Tired Farm Type Tractor with Bulldozer/Blade/Auger or hi-lift over 1/2 yd., Jersey Spreader, Tract-Air used with Drill or Hi-Lift, Trenching or Ditching Machines, Wood Chipper w/Tractor, Self-Propelled Roller w/Blade, Equipment Greaser, Self-Propelled Bump Grinder on Concrete pavement, Boat Operator, Skid-Loaders, Tuggers, Lazer Screed, and Self-Propelled Chip Spreader (when others run conveyors).

Class 2. Any type tractor pulling any type roller or disc, Two Air Compressors (220 cu. ft. capacity or over), Two AirTract Drills, Air-Track Drill w/Compressor, Automatic Bins or Scales w/Compressor or Generator, Pipeline Boring Machine, Bulk Cement Plant w/Separate Compressor, Power Operated Bull Float, Hydra-Lift w/Single Motor, Straw Mulcher Blower w/Spout, Self-Propelled Roller/Compactor, Back-End man on Bituminous Surfacing Machine, oiler on milling machine.

Class 3. Air Compressor w/Valve driving piling, Boom or Winch Type Truck, Two Conveyors, Self-Propelled Concrete Saw, Form Grader, Truck Crane Oiler, Self-Propelled Vibrator, Rubber Tired Farm Type Tractor w/Blade/Bulldozer/Auger/hi-lift - 1/2 yd. or less, Elevator Operator, Man Lift (scissor lift) when lifting materials.

Class 4. Air-Track Drill (one), Belt Drag Machine, Power Broom, Mechanical Plasterer Applicator, Trac-Air, Air Compressor (220 cu. ft. or over) One, Air Compressor (under 220 cu. ft) four, Automatic Bin, Bulk Cement Plant w/Built-in Compressor running off same motor or

electric motor, Fireman or Switchman, Self-Propelled Form Tamper, Light Plants (4), Welding Machines (4), Pumps (4), or Combination of four (4) Pumps, Light Plants, Welding Machines, Air-Compressors (under 220 cu. ft.), Mudjacks or Wood Chipper, Mixers - less than 21 cu. ft. Mortar Mixer w/Skip or Pump, Pipeline Tract Jack. One Operating Engineer may operate and maintain any combination of the following pieces of equipment, not to exceed four (4) which shall be within a reasonable distance, such combination may include any equipment in this classification: (Compressors, Light Plants, Generators, Welding Machines, Pumps or Conveyors), One Well- Point Pump, Two Motor Driven Heaters, One Air Compressor (under 220 cu. ft.), One Engine-Driven Conveyor, One Motor Driven Heater, One Light Plant, One Pump, One Welding Machine, One Ulmac or Equal Spreader, Oilers, and one Generator 10 kw or greater.

OPERATING ENGINEER RIVER WORK 1 - operate the following machines when working on River Work and Levee Work on the Mississippi and Ohio Rivers, Lakes and Tributaries: Crane, Shovel, Drageline, Scrapers, Dredge, Derrick, Pile-Driver, Push Boat, all power boat operators, Mechanic, Engineman on Dredge, Leverman on Dredge, All Bituminous Spreader machines, Backhoe, Backfiller, Boom, or Winch Cat, Bituminous Mixplane Machine, Blacksmith, Bituminous Surfacing Machine, Bulldozer, Truck Cranes, Hydraulic Truck Mounted Boom/Crane, Concrete Finishing Machine, or Spreader Machine, Concrete Breaker, Concrete or Pumpcrete Machines, Concrete Plant Operator, All Off Road Material Hauling Equipment, Dinky or Standard Locomotives, Well Drill, Elevating Grader, Fork-Lifts, Flexplane, Gradeall, Hi-Lift, Power Handblade Tugger type Hoist, Hoist Two Drum (or over one), Gyderrick, Hyster, Motor Patrol, Mixers - 21 Cu. Ft. or over, Push Cat, Pulls, & Scrapers, Pumps-Two Well Points, Equipment Greaser, P & H Pulverizer or Pulverizer equal to Pugmill, Pugmill, Rubber-Tired farm type tractor w/Bulldozer/Blade/Auger or Hi-Lift over ½ yard, Skimmer Scoops, Seaman Tiller, Jersey Spreader, Tract-Air used with Drill or Hi-Lift, Trenching or Ditching Machine, Wood Chipper w/Tractor, self-propelled roller w/Blade, Concrete Pumps and Small Equipment Operators.

OPERATING ENGINEER RIVER 2 - when working on River Work and Levee Work on the Mississippi and Ohio Rivers, Lakes and Tributaries shall be employed as the Oiler or Fireman on Crane, Dragline, Shovel, Dredge, Truck Crane, Pile Driver, Gradeall, Dinky or Standard Locomotive, Guy Derrick, Trenching Machine or Ditching Machine 80 H.P. and over, All Terrain (cherry-picker) with over 40 ton Lifting Capacity, Deck Oiler and Deckhands.

#### Other Classifications of Work:

For definitions of classifications not otherwise set out, the Department generally has on file such definitions which are available. If a task to be performed is not subject to one of the classifications of pay set out, the Department will upon being contacted state which neighboring county has such a classification and provide such rate, such rate being deemed to exist by reference in this document. If no neighboring county rate applies to the task, the Department shall undertake a special determination, such special determination being then deemed to have existed under this determination. If a project requires these, or any classification not listed, please contact IDOL at 618/993-7271 for wage rates or clarifications.

#### LANDSCAPING

Landscaping work falls under the existing classifications for laborer, operating engineer and truck driver. The work performed by landscape plantsman and landscape laborer is covered by the existing classification of laborer. The work performed by landscape operators (regardless of equipment used or its size) is covered by the classifications of operating engineer. The work performed by landscape truck drivers (regardless of size of truck driven) is covered by the classifications of truck driver.

# Whiteside County Prevailing Wage for April 2007

Trade Name	RG	TYP	C	Base	FRMAN	*M-F>8	OSA	OSH	H/W	Pensn	Vac	Trng
=====	==	==	=	=====	=====	=====	==	==	=====	=====	=====	=====
ASBESTOS ABT-GEN		BLD		23.760	24.760	1.5	1.5	2.0	5.850	8.730	0.000	0.600
ASBESTOS ABT-MEC		BLD		18.750	19.750	1.5	1.5	2.0	4.750	2.000	0.000	0.000
BOILERMAKER		BLD		30.970	33.970	2.0	2.0	2.0	8.270	7.740	0.000	0.300
BRICK MASON		BLD		30.000	32.500	1.5	1.5	2.0	5.500	8.680	0.000	0.420
CARPENTER		BLD		27.040	30.010	1.5	1.5	2.0	6.100	8.220	0.000	0.600
CARPENTER		HWY		27.440	29.190	1.5	1.5	2.0	6.300	7.680	0.000	0.400
CEMENT MASON		ALL		30.000	32.500	1.5	1.5	2.0	5.500	7.530	0.000	0.100
CERAMIC TILE FNSHER		BLD		24.860	0.000	1.5	1.5	2.0	5.500	4.000	0.000	0.360
COMMUNICATION TECH	E	BLD		28.700	30.700	1.5	1.5	2.0	8.200	8.340	0.000	0.570
ELECTRIC PWR EQMT OP		ALL		27.920	35.880	1.5	1.5	2.0	4.750	7.820	0.000	0.210
ELECTRIC PWR GRNDMAN		ALL		21.640	35.880	1.5	1.5	2.0	4.750	6.060	0.000	0.160
ELECTRIC PWR LINEMAN		ALL		33.220	35.880	1.5	1.5	2.0	4.750	9.310	0.000	0.250
ELECTRIC PWR TRK DRV		ALL		22.340	35.880	1.5	1.5	2.0	4.750	6.260	0.000	0.170
ELECTRICIAN	E	BLD		33.570	36.930	1.5	1.5	2.0	8.200	11.15	0.000	0.670
ELECTRICIAN	W	BLD		27.770	29.770	1.5	1.5	2.0	5.500	7.660	0.000	0.310
ELECTRONIC SYS TECH	W	BLD		19.800	21.400	1.5	1.5	2.0	5.880	4.040	0.000	0.310
ELEVATOR CONSTRUCTOR		BLD		33.140	37.280	2.0	2.0	2.0	8.275	6.060	1.990	0.000
GLAZIER		BLD		20.580	21.810	1.5	1.5	2.0	4.750	3.900	0.000	0.200
HT/FROST INSULATOR		BLD		25.860	27.060	1.5	1.5	2.0	4.800	7.500	0.000	0.000
IRON WORKER	E	ALL		30.760	32.300	2.0	2.0	2.0	6.950	16.62	0.000	0.550
IRON WORKER	W	ALL		23.100	24.950	1.5	1.5	2.0	8.040	7.990	0.000	0.420
LABORER		BLD		23.760	24.760	1.5	1.5	2.0	5.850	8.730	0.000	0.600
LABORER		HWY		23.310	24.060	1.5	1.5	2.0	5.850	8.330	0.000	0.600
LABORER, SKILLED		HWY		24.710	25.460	1.5	1.5	2.0	5.850	8.330	0.000	0.600
LATHER		BLD		27.040	30.010	1.5	1.5	2.0	6.100	8.220	0.000	0.600
MACHINIST		BLD		36.890	38.890	2.0	2.0	2.0	4.380	5.650	2.550	0.000
MARBLE FINISHERS		BLD		24.860	0.000	1.5	1.5	2.0	5.500	4.000	0.000	0.360
MARBLE MASON		BLD		28.140	28.390	1.5	1.5	2.0	5.500	5.220	0.000	0.380
MILLWRIGHT		BLD		32.000	35.200	1.5	1.5	2.0	6.100	9.250	0.000	0.560
OPERATING ENGINEER	E	BLD	1	37.050	41.050	2.0	2.0	2.0	6.850	6.150	1.900	0.700
OPERATING ENGINEER	E	BLD	2	36.350	41.050	2.0	2.0	2.0	6.850	6.150	1.900	0.700
OPERATING ENGINEER	E	BLD	3	33.900	41.050	2.0	2.0	2.0	6.850	6.150	1.900	0.700
OPERATING ENGINEER	E	BLD	4	31.900	41.050	2.0	2.0	2.0	6.850	6.150	1.900	0.700
OPERATING ENGINEER	E	HWY	1	36.900	40.900	1.5	1.5	2.0	6.850	6.150	1.900	0.700
OPERATING ENGINEER	E	HWY	2	36.350	40.900	1.5	1.5	2.0	6.850	6.150	1.900	0.700
OPERATING ENGINEER	E	HWY	3	35.050	40.900	1.5	1.5	2.0	6.850	6.150	1.900	0.700
OPERATING ENGINEER	E	HWY	4	33.600	40.900	1.5	1.5	2.0	6.850	6.150	1.900	0.700
OPERATING ENGINEER	E	HWY	5	32.150	40.900	1.5	1.5	2.0	6.850	6.150	1.900	0.700
OPERATING ENGINEER	W	BLD	1	26.150	0.000	1.5	1.5	2.0	6.850	5.800	1.500	0.550
OPERATING ENGINEER	W	BLD	2	23.500	0.000	1.5	1.5	2.0	6.850	5.800	1.500	0.550
OPERATING ENGINEER	W	BLD	3	22.450	0.000	1.5	1.5	2.0	6.850	5.800	1.500	0.550
OPERATING ENGINEER	W	HWY	1	26.150	27.150	1.5	1.5	2.0	6.850	5.800	1.500	0.550
OPERATING ENGINEER	W	HWY	2	24.550	27.150	1.5	1.5	2.0	6.850	5.800	1.500	0.550
OPERATING ENGINEER	W	HWY	3	23.400	27.150	1.5	1.5	2.0	6.850	5.800	1.500	0.550
PAINTER		ALL		23.470	24.470	1.5	1.5	1.5	4.650	4.850	0.000	0.600
PAINTER OVER 30FT		ALL		24.720	25.720	1.5	1.5	1.5	4.650	4.850	0.000	0.600
PAINTER PWR EQMT		ALL		23.970	24.970	1.5	1.5	1.5	4.650	4.850	0.000	0.600
PILEDRIVER		BLD		28.040	31.120	1.5	1.5	2.0	6.100	8.220	0.000	0.600
PILEDRIVER		HWY		27.440	29.190	1.5	1.5	2.0	6.300	7.680	0.000	0.400
PIPEFITTER		ALL		30.520	33.570	1.5	1.5	2.0	4.800	7.960	0.000	0.530
PLASTERER		BLD		29.540	32.490	2.0	2.0	2.0	5.500	7.350	0.000	0.100
PLUMBER		ALL		30.520	33.570	1.5	1.5	2.0	4.800	7.960	0.000	0.530
ROOFER		BLD		22.850	24.100	1.5	1.5	2.0	5.840	4.870	0.000	0.190
SHEETMETAL WORKER		BLD		31.690	33.620	1.5	1.5	2.0	4.850	10.29	0.520	0.290
SPRINKLER FITTER		BLD		31.240	33.240	1.5	1.5	2.0	6.500	5.350	0.000	0.250
STONE MASON		BLD		30.000	32.500	1.5	1.5	2.0	5.500	8.680	0.000	0.420
TERRAZZO FINISHER		BLD		24.860	0.000	1.5	1.5	2.0	5.500	4.000	0.000	0.360
TERRAZZO MASON		BLD		28.140	28.390	1.5	1.5	2.0	5.500	5.220	0.000	0.380

TILE LAYER	BLD	27.040	30.010	1.5	1.5	2.0	6.100	8.220	0.000	0.600
TILE MASON	BLD	28.140	28.390	1.5	1.5	2.0	5.500	5.220	0.000	0.380
TRUCK DRIVER	ALL 1	25.787	0.000	1.5	1.5	2.0	7.250	3.317	0.000	0.000
TRUCK DRIVER	ALL 2	26.187	0.000	1.5	1.5	2.0	7.250	3.317	0.000	0.000
TRUCK DRIVER	ALL 3	26.387	0.000	1.5	1.5	2.0	7.250	3.317	0.000	0.000
TRUCK DRIVER	ALL 4	26.637	0.000	1.5	1.5	2.0	7.250	3.317	0.000	0.000
TRUCK DRIVER	ALL 5	27.387	0.000	1.5	1.5	2.0	7.250	3.317	0.000	0.000
TRUCK DRIVER	O&C 1	20.630	0.000	1.5	1.5	2.0	7.250	3.317	0.000	0.000
TRUCK DRIVER	O&C 2	20.950	0.000	1.5	1.5	2.0	7.250	3.317	0.000	0.000
TRUCK DRIVER	O&C 3	21.110	0.000	1.5	1.5	2.0	7.250	3.317	0.000	0.000
TRUCK DRIVER	O&C 4	21.310	0.000	1.5	1.5	2.0	7.250	3.317	0.000	0.000
TRUCK DRIVER	O&C 5	21.910	0.000	1.5	1.5	2.0	7.250	3.317	0.000	0.000
TUCKPOINTER	BLD	30.000	32.500	1.5	1.5	2.0	5.500	8.680	0.000	0.420

Legend:

M-F>8 (Overtime is required for any hour greater than 8 worked each day, Monday through Friday.)

OSA (Overtime is required for every hour worked on Saturday)

OSH (Overtime is required for every hour worked on Sunday and Holidays)

H/W (Health & Welfare Insurance)

Pensn (Pension)

Vac (Vacation)

Trng (Training)

## Explanations

WHITESIDE COUNTY

ELECTRICIAN AND COMMUNICATION TECHNICIAN(EAST) - Townships of Genessee, Jordan, Hopkins, Sterling, Hume, Montmorency, Tampico, and Hahnaman.

ELECTRONIC SYSTEMS TECHNICIAN (WEST) - Portion west of Genessee, Hume, Mount Pleasant, and Tampico Townships.

IRONWORKERS (EAST) - That part county North and East of a line from Fair Haven (Carroll County) to Rt. 30, then to the East county line.

OPERATING ENGINEERS (WEST) - From the fifth sectional line east of Morrison, running directly north and south.

The following list is considered as those days for which holiday rates of wages for work performed apply: New Years Day, Memorial/Decoration Day, Fourth of July, Labor Day, Veterans Day, Thanksgiving Day, Christmas Day. Generally, any of these holidays which fall on a Sunday is celebrated on the following Monday. This then makes work performed on that Monday payable at the appropriate overtime rate for holiday pay. Common practice in a given local may alter certain days of celebration such as the day after Thanksgiving for Veterans Day. If in doubt, please check with IDOL.

Oil and chip resealing (O&C) means the application of road oils and



liquid asphalt to coat an existing road surface, followed by application of aggregate chips or gravel to coated surface, and subsequent rolling of material to seal the surface.

#### EXPLANATION OF CLASSES

ASBESTOS - GENERAL - removal of asbestos material/mold and hazardous materials from any place in a building, including mechanical systems where those mechanical systems are to be removed. This includes the removal of asbestos materials/mold and hazardous materials from ductwork or pipes in a building when the building is to be demolished at the time or at some close future date.

ASBESTOS - MECHANICAL - removal of asbestos material from mechanical systems, such as pipes, ducts, and boilers, where the mechanical systems are to remain.

#### CERAMIC TILE FINISHER, MARBLE FINISHER, TERRAZZO FINISHER

Assisting, helping or supporting the tile, marble and terrazzo mechanic by performing their historic and traditional work assignments required to complete the proper installation of the work covered by said crafts. The term "Ceramic" is used for naming the classification only and is in no way a limitation of the product handled. Ceramic takes into consideration most hard tiles.

#### COMMUNICATIONS TECHNICIAN - East

Installing, manufacturing, assembling and maintaining sound and intercom, protection alarm (security), fire alarm, master antenna television, closed circuit television, low voltage control for computers and/or door monitoring, school communications systems, telephones and servicing of nurse and emergency calls, and the installation and maintenance of transmit and receive antennas, transmitters, receivers, and associated apparatus which operates in conjunction with above systems. All work associated with these system installations will be included EXCEPT the installation of protective metallic conduit in new construction projects (excluding less than ten-foot runs strictly for protection of cable) and 120 volt AC (or higher) power wiring and associated hardware.

#### ELECTRONIC SYSTEMS TECHNICIAN - West

Installing, assembling and maintaining sound and intercom, protection alarm (security), master antenna television, closed circuit television, computer hardware and software programming and installation to the network's outlet and input (EXCLUDING all cabling, power and cable termination work historically performed by wiremen), door monitoring and control, nurse and emergency call programming and installation to the system's outlet and input (EXCLUDING all cabling, power and cable termination work historically performed by wiremen), clock and timing; and the installation and maintenance of transmit and receive antennas, transmitters, receivers, and associated apparatus which operates in conjunction with the above systems. All work associated with these system installations will be included EXCEPT (1) installation of protective metallic conduit, excluding less than ten-foot runs strictly for protection of cable, and (2) 120 volt AC (or higher) power wiring and associated hardware.

#### LABORER, SKILLED - HIGHWAY

Individuals engaged in the following types of work, irrespective of the site of the work: asbestos abatement worker, handling of any materials with any foreign matter harmful to skin or clothing, track

laborer, cement handlers, chloride handlers, the unloading and loading with steel workers and re-bars, concrete workers wet, tunnel helpers in free air, batch dumpers, mason tenders, kettle and tar men, tank cleaners, plastic installers, scaffold workers, motorized buggies or motorized unit used for wet concrete or handling of building materials, laborers with de-watering systems, sewer workers plus depth, rod and chainmen with technical engineers, rod and chainmen with land surveyors, rod and chainmen with surveyors, vibrator operators, cement silica, clay, fly ash, lime and plasters, handlers (bulk or bag), cofferdam workers plus depth, on concrete paving, placing, cutting and tying of reinforcing, deck hand, dredge hand, and shore laborers, bankmen on floating plant, grade checker, power tools, front end man on chip spreaders, cession workers plus depth, gunnite nozzle men, lead man on sewer work, welders, cutters, burners and torchmen, chainsaw operators, jackhammer and drill operators, layout man and/or drainage tile layer, steel form setter - street and highway, air tamping hammermen, signal man on crane, concrete saw operator, screedman on asphalt pavers, laborers tending masons with hot material or where foreign materials are used, mortar mixer operators, multiple concrete duct - leadsman, lumen, asphalt raker, curb asphalt machine operator, ready mix scalemen (permanent, portable or temporary plant), laborers handling masterplate or similar materials, laser beam operator, concrete burning machine operator, coring machine operator, plaster tender, underpinning and shoring of buildings, pump men, manhole and catch basin, dirt and stone tamper, hose men on concrete pumps, hazardous waste worker, lead base paint abatement worker, lining of pipe, refusing machine, assisting on direct boring machine, the work of laying watermain, fire hydrants, all mechanical joints to watermain work, sewer worker, and tapping water service and forced lift station mechanical worker.

#### TRUCK DRIVER - BUILDING, HEAVY AND HIGHWAY CONSTRUCTION

Class 1. Drivers on 2 axle trucks hauling less than 9 ton. Air compressor and welding machines and brooms, including those pulled by separate units, truck driver helpers, warehouse employees, mechanic helpers, greasers and tiremen, pickup trucks when hauling materials, tools, or workers to and from and on-the-job site, and fork lifts up to 6,000 lb. capacity.

Class 2. Two or three axle trucks hauling more than 9 ton but hauling less than 16 ton. A-frame winch trucks, hydrolift trucks, vector trucks or similar equipment when used for transportation purposes. Fork lifts over 6,000 lb. capacity, winch trucks, four axle combination units, and ticket writers.

Class 3. Two, three or four axle trucks hauling 16 ton or more. Drivers on water pulls, articulated dump trucks, mechanics and working forepersons, and dispatchers. Five axle or more combination units.

Class 4. Low Boy and Oil Distributors.

Class 5. Drivers who require special protective clothing while employed on hazardous waste work.

#### TRUCK DRIVER - OIL AND CHIP RESEALING ONLY.

This shall encompass laborers, workers and mechanics who drive contractor or subcontractor owned, leased, or hired pickup, dump, service, or oil distributor trucks. The work includes transporting materials and equipment (including but not limited to, oils, aggregate supplies, parts, machinery and tools) to or from the job site; distributing oil or liquid asphalt and aggregate; stock piling

material when in connection with the actual oil and chip contract. The Truck Driver (Oil & Chip Resealing) wage classification does not include supplier delivered materials.

#### OPERATING ENGINEERS - BUILDING - EAST

Class 1. Assistant Craft Foreman; Craft Foreman; Mechanic; Asphalt Plant; Asphalt Spreader; Autograde; Batch Plant; Benoto (requires Two Engineers); Boiler and Throttle Valve; Caisson Rigs; Central Redi-Mix Plant; Combination Back Hoe Front End-loader Machine; Compressor and Throttle Valve; Concrete Breaker (Truck Mounted); Concrete Conveyor; Concrete Paver; Concrete Placer; Concrete Pump (Truck Mounted); Concrete Tower, Cranes, All, Cranes, Hammerhead, Creter Crane; Crusher, Stone, etc.; Derricks, All; Derricks, Traveling; Formless Curb and Gutter Machine; Grader, Elevating; Grouting Machines; Highlift Shovels or Front Endloader 2-1/4 yd. and over; Hoists, Elevators, outside type rack and pinion and similar machines; Hoists, one, two and three Drum; Hoists, Two tigger One Floor; Hydraulic Backhoes; Hydraulic Boom Trucks; Locomotives, All; Motor Patrol; Pile Drivers and Skid Rig; Post Hole Digger; Pre-Stress Machine; Pump Cretes; Squeeze Cretes-screw Type Pumps; Gypsum Bulker and Pump; Raised and Blind Hole Drill; Rock Drill; Roto Mill Grinder; Scoops - Tractor Drawn; Slip-form Paver; Straddle Buggies; Tie Back Machine; Tractor with Book and Side Boom; Trenching Machines.

Class 2. Bobcat (over 3/4 cu. yd.); Boilers Brick Forklift; Broom, All Power Propelled; Bulldozers; Concrete Mixer (Two Bag and Over); Conveyor, Portable; Forklift Trucks; Greaser Engineer; Highlift Shovels or Front Endloaders under 2-1/4 yd.; Hoists, Automatic; Hoists, Sewer Dragging Machine; Hoists, Tigger Single Drum; Rollers, All; Steam Generators; Tractors, All; Tractor Drawn Vibratory Roller; Winch Trucks with "A" Frame.

Class 3. Air Compressor; Asphalt Spreader; Combination - Small Equipment Operator; Generators; Heaters, Mechanical; Hoists, Inside Elevators - (Rheostat Manual Controlled); Hydraulic Power Units (Pile Driving and Extracting); Pumps, over 3" (1 to 3 not to exceed a total of 300 ft.); Pumps, Well Points; Welding Machines (2 through 5); Winches, 4 small Electric Drill Winches; Bobcat (up to and including 3/4 cu. yd.).

Class 4. Hoists, Inside Elevators, Push Button with Automatic Doors; Oilers; Brick Forklift.

#### OPERATING ENGINEERS - HEAVY AND HIGHWAY CONSTRUCTION - EAST

Class 1. Craft Foreman; Asphalt Plant, Asphalt Heater and Planer Combination; Asphalt Heater Scarfire; Asphalt Silo Tender; Asphalt Spreader; Autograder; ABG Paver; Backhoes with Caisson attachment; Ballast Regulator, Belt Loader; Caisson Rigs; Car Dumper; Central Redi-Mix Plant; Backhoe w/shear attachments; Combination Backhoe Front Endloader Machine, (1 cu. yd. Backhoe Bucket or over or with attachments); Concrete Breaker (Truck Mounted); Concrete Conveyor; Concrete Paver over 27E cu. ft.; Concrete Placer; Concrete Tube Float; Cranes, all attachments; Cranes, Hammerhead, Linden, Peco & Machines of a like nature; Crete Crane; Crusher, Stone, etc.; Derricks, All; Derrick Boats; Derricks, Traveling; Directional Boring Machine over 12"; Dredges; Field Mechanic-Welder; Formless Curb and Gutter Machine; Gradall and Machines of a like nature; Grader, Elevating; Grader, Motor Grader, Motor Patrol, Auto Patrol, Form Grader, Pull Grader, Subgrader; Guard Rail Post Driver Mounted; Hoists, One, Two and Three Drum; Hydraulic Backhoes; Pile Drivers and Skid Rig; Pre-Stress Machine; Pump Cretes Dual Ram; Rock Drill - Crawler or

Skid Rig; Rock Drill - Truck Mounted; Rock/Track Tamper; Roto Mill Grinder; Slip-Form Paver; Soil Test Drill Rig (Truck Mounted); Straddle Buggies; GCI Crane; Hydraulic Telescoping form (Tunnel); Tie Back Machine; Tractor Drawn Belt Loader; Tractor with Boom; Tractor-aire with Attachments; Traffic Barrier conveyor machine; Raised or Blind Hole; Trenching Machine; Truck Mounted Concrete Pump with Boom; Truck Mounted Concrete Conveyor; Underground Boring and/or Mining Machines; Wheel Excavator; Widener (APSCO).

Class 2. Batch Plant; Bituminous Mixer; Boiler and Throttle Valve; Bulldozers; Car Loader Trailing Conveyors; Combination Backhoe Front Endloader Machine (less than 1 cu. yd. Backhoe Bucket or over or with attachments); Compressor and Throttle Valve; Compressor, Common Receiver (3); Concrete Breaker or Hydro Hammer; Concrete Grinding Machine; Concrete Mixer or Paver 7S Series to and including 27 cu. ft.; Concrete Spreader; Concrete Curing Machine, Burlap Machine, Belting Machine and Sealing Machine; Conveyor Muck Cars (Haglund or Similar Type); Drills, all; Finishing Machine - Concrete; Greaser Engineer; Highlift Shovels or Front Endloader; Hoist - Sewer Dragging Machine; Hydraulic Boom Trucks (All Attachments); Hydro Blaster; Laser Screed; All Locomotives, Dinky; Pump Cretes; Squeeze Cretes-Screw Type Pumps, Gypsum Bulker and Pump; Roller, Asphalt; Rotary Snow Plows; Rototiller, Seaman, etc., self-propelled; Scoops - Tractor Drawn; Self-Propelled Compactor; Spreader - Chip - Stone, etc.; Scraper; Scraper - Prime Mover in Tandem (Regardless of Size); Tank Car Heater; Tractors, Push, Pulling Sheeps Foot, Disc, Compactor, etc. Tug Boats.

Class 3. Boilers; Brooms, All Power Propelled; Cement Supply Tender; Compressor, Common Receiver (2); Concrete Mixer (Two Bag and Over); Conveyor, Portable; Farm-Type Tractors Used for Mowing, Seeding, etc.; Fireman on Boilers; Forklift Trucks; Grouting Machine; Hoists, Automatic; Hoists, All Elevators; Hoists, Tugger Single Drum; Jeep Diggers, Low Boys; Pipe Jacking Machines; Post-Hole Digger; Power Saw, Concrete Power Driven; Pug Mills; Rollers, other than asphalt; Seed and Straw Blower; Steam Generators; Stump Machine; Winch Trucks with "A" Frame; Work Boats; Tamper - Form-Motor Driven.

Class 4. Air Compressor - Small and Large; Asphalt Spreader, Backend Man; Bobcat (Skid Steer) all; Combination - Small Equipment Operator; Directional Boring Machine up to 12"; Generators - Small 50kw and Under; Generators - Large over 50kw; Heaters, Mechanical; Hydraulic Power Unit (Pile Driving, Extracting, or Drilling); Hydro-Blaster; Light Plants, All (1 through 5); Pumps, over 3" (1 to 3 not to exceed a total of 300 ft.); Pumps, Well Points; Tract-aire; Welding Machines (2 through 5); Winches, 4 Small Electric Drill Winches.

Class 5. Oilers and Directional Boring Machine Locator.

#### OPERATING ENGINEERS - BUILDING, HEAVY AND HIGHWAY CONSTRUCTION - WEST

Class 1. An engineer on Crane, Shovel, Clamshell, Dragline, Backhoe, Derrick, Tower Crane, Cable Way, Concrete Spreader (servicing two pavers), Asphalt Spreader, Asphalt Mixer, Plant Engineer, Dipper Dredge Operator, Dipper Dredge Craneman, Dual Purpose Truck (boom or winch), Leverman or Engineman (hydraulic dredge), Mechanic, Paving Mixer with tower attached, Pile Driver, Boom Tractor, Stationary, Portable or Floating Mixing Plant, Trenching Machine (over 40 H.P.), Building Hoist (two drums), Hot Paint Wrapping Machine, Cleaning and Priming Machine, Backfiller (throw bucket), Locomotive Engineer, Qualified Welder, Tow or Push Boat, Concrete Paver, Seaman Trav-L-Plant or similar machines, CMI Autograder or similar machines, Slip Form Paver, Caisson Augering Machine, Mucking Machine, Asphalt Heater-Planer Unit, Hydraulic Cranes, Mine Hoists. An engineer on

Athey, Barber-Green, Euclid or Haiss Loader, Asphalt Pug Mill, Fireman and Drier, Concrete Pump, Concrete Spreader (servicing one paver) Bulldozer, Endloader, Log Chippers or similar machines, Elevating Grader, Group Equipment Greaser, LeTourneaul and similar machines, off-road haul units, DW-10 Hyster Winch and similar machines, Motor Patrol, Power Blade, Push Cat, Tractor Pulling elevating Grader or Power Blade, Tractor Operating Scoop or Scraper, Tractor with Power Attachment, Roller on Asphalt or Blacktop, Single Drum Hoist, Jaeger Mix and Place Machine, Pipe Bending Machine, Flexaplane or similar machines, Automatic Curbing Machines, Automatic Cement and Gravel Batch Plants (one stop set-up), Seaman Pulvi-Mixer or similar machines, Blastholer Self-propelled Rotary Drill or similar machines, Work Boat, Combination Concrete Finishing Machine and Float, Self-propelled Sheep Foot Roller or Compactor (used in conjunction with a Grading Spread), Asphalt Spreader Screed Operator, Apsco spreader or similar machine, Slusher, Forklift (over 6000 lb. cap. or working at heights above 28 ft.) Concrete Conveyors, Chip Spreader, Underground Boring Machine (BUILDING ONLY), Straddle Carrier, Hydro-Hammer (BUILDING ONLY), Hydraulic Pumps or Power Units Driven by any power source (except manually), used to hoist or lift machinery or material.

Class 2. An engineer on Asphalt Booster, Fireman and Pump Operator at Asphalt Plant, Mud Jack, Underground Boring Machine (HIGHWAY ONLY), Concrete Finishing Machine, Form Grader with Roller on Earth, Mixers (3 bag to 16E), Power Operated Bull Float, Tractor without Power attachment, Dope Pot (agitating motor), Dope Chop Machine, Distributor (back end), Straddle Carrier, Portable Machine Fireman, Hydro-Hammer (HIGHWAY ONLY), Power Winch on Paving Work, Self-propelled Roller or Compactor (other than provided for above), Pump Operator (more than one well-point pump), Portable Crusher Operator, Trench Machine (under 40 H.P.), Power Subgrader (on forms) or similar machines, Forklift (6000 or less cap.) Gypsum Pump, Conveyor over 20 H.P., Fuller Kenyon Cement Pump or similar machines. An engineer on Air Compressor (400 c.f.m. or over HIGHWAY ONLY), Light Plant, Mixers (1 or 2 bag), Power Batching Machine (Cement Auger or Conveyor), Boiler (Engineer or Fireman), Water Pumps (HIGHWAY ONLY), Mechanical Broom, Automatic Cement and Gravel Batch Plants (two or three stop set-up), Small Rubber-tired Tractors (not including backhoes or endloaders), Self-propelled Curing Machine, Brush Chipper, Driver on Truck Crane or similar machines.

Class 3. Oiler, Mechanic's Helper, Mechanical Heater (other than steam boiler), Belt Machine, Small Outboard Motor Boats (Safety Boat and Life Boat), Engine Driven Welding Machine, and Small Tractors (used to unroll or roll wire mesh), Water pumps (BUILDING ONLY), Air Compressors (BUILDING ONLY), Permanent Automatic Elevators.

#### Other Classifications of Work:

For definitions of classifications not otherwise set out, the Department generally has on file such definitions which are available. If a task to be performed is not subject to one of the classifications of pay set out, the Department will upon being contacted state which neighboring county has such a classification and provide such rate, such rate being deemed to exist by reference in this document. If no neighboring county rate applies to the task, the Department shall undertake a special determination, such special determination being then deemed to have existed under this determination. If a project requires these, or any classification not listed, please contact IDOL at 618/993-7271 for wage rates or clarifications.

## LANDSCAPING

Landscaping work falls under the existing classifications for laborer, operating engineer and truck driver. The work performed by landscape plantsman and landscape laborer is covered by the existing classification of laborer. The work performed by landscape operators (regardless of equipment used or its size) is covered by the classifications of operating engineer. The work performed by landscape truck drivers (regardless of size of truck driven) is covered by the classifications of truck driver.

# Will County Prevailing Wage for April 2007

Trade Name	RG	TYP	C	Base	FRMAN	*M-F>8	OSA	OSH	H/W	Pensn	Vac	Trng
=====	==	==	=	=====	=====	=====	==	==	=====	=====	=====	=====
ASBESTOS ABT-GEN		ALL		31.550	32.300	1.5	1.5	2.0	7.460	4.840	0.000	0.170
ASBESTOS ABT-MEC		BLD		23.300	24.800	1.5	1.5	2.0	7.860	4.910	0.000	0.000
BOILERMAKER		BLD		38.540	42.000	2.0	2.0	2.0	6.720	7.440	0.000	0.300
BRICK MASON		BLD		34.850	38.340	1.5	1.5	2.0	7.050	7.870	0.000	0.380
CARPENTER		ALL		36.050	39.650	1.5	1.5	2.0	6.850	9.810	0.000	0.490
CEMENT MASON		ALL		35.500	37.500	2.0	2.0	2.0	6.400	8.830	0.000	0.100
CERAMIC TILE FNSHER		BLD		28.520	0.000	2.0	1.5	2.0	5.650	5.750	0.000	0.330
COMMUNICATION TECH		BLD		30.110	31.610	1.5	1.5	2.0	8.270	8.700	0.000	0.300
ELECTRIC PWR EQMT OP		ALL		36.050	42.000	1.5	1.5	2.0	7.870	9.730	0.000	0.270
ELECTRIC PWR GRNDMAN		ALL		28.120	42.000	1.5	1.5	2.0	6.140	7.600	0.000	0.210
ELECTRIC PWR LINEMAN		ALL		36.050	42.000	1.5	1.5	2.0	7.870	9.730	0.000	0.270
ELECTRICIAN		BLD		34.500	37.610	1.5	1.5	2.0	7.920	10.53	0.000	0.350
ELEVATOR CONSTRUCTOR		BLD		42.045	47.300	2.0	2.0	2.0	8.275	6.060	2.520	0.550
GLAZIER		BLD		31.400	32.400	1.5	2.0	2.0	6.490	9.050	0.000	0.500
HT/FROST INSULATOR		BLD		33.300	35.050	1.5	1.5	2.0	7.860	8.610	0.000	0.310
IRON WORKER		ALL		32.000	33.000	2.0	2.0	2.0	8.040	13.92	0.000	0.550
LABORER		ALL		31.550	32.300	1.5	1.5	2.0	7.460	4.840	0.000	0.170
LATHER		ALL		36.050	39.650	1.5	1.5	2.0	6.850	9.810	0.000	0.490
MACHINIST		BLD		36.890	38.890	2.0	2.0	2.0	4.380	5.650	2.550	0.000
MARBLE FINISHERS		ALL		25.750	0.000	1.5	1.5	2.0	6.070	7.020	0.000	0.580
MARBLE MASON		BLD		34.850	38.340	1.5	1.5	2.0	7.050	7.870	0.000	0.490
MATERIAL TESTER 1		ALL		21.550	0.000	1.5	1.5	2.0	7.460	4.840	0.000	0.170
MATERIALS TESTER II		ALL		26.550	0.000	1.5	1.5	2.0	7.460	4.840	0.000	0.170
MILLWRIGHT		ALL		36.050	39.650	1.5	1.5	2.0	6.850	9.810	0.000	0.490
OPERATING ENGINEER		BLD	1	41.550	45.550	2.0	2.0	2.0	6.850	5.600	1.900	0.700
OPERATING ENGINEER		BLD	2	40.250	45.550	2.0	2.0	2.0	6.850	5.600	1.900	0.700
OPERATING ENGINEER		BLD	3	37.700	45.550	2.0	2.0	2.0	6.850	5.600	1.900	0.700
OPERATING ENGINEER		BLD	4	35.950	45.550	2.0	2.0	2.0	6.850	5.600	1.900	0.700
OPERATING ENGINEER		FLT	1	47.250	47.250	1.5	1.5	2.0	6.850	5.600	1.900	0.000
OPERATING ENGINEER		FLT	2	45.750	47.250	1.5	1.5	2.0	6.850	5.600	1.900	0.000
OPERATING ENGINEER		FLT	3	40.700	47.250	1.5	1.5	2.0	6.850	5.600	1.900	0.000
OPERATING ENGINEER		FLT	4	33.850	47.250	1.5	1.5	2.0	6.850	5.600	1.900	0.000
OPERATING ENGINEER		HWY	1	39.750	43.750	1.5	1.5	2.0	6.850	5.600	1.900	0.700
OPERATING ENGINEER		HWY	2	39.200	43.750	1.5	1.5	2.0	6.850	5.600	1.900	0.700
OPERATING ENGINEER		HWY	3	37.150	43.750	1.5	1.5	2.0	6.850	5.600	1.900	0.700
OPERATING ENGINEER		HWY	4	35.750	43.750	1.5	1.5	2.0	6.850	5.600	1.900	0.700
OPERATING ENGINEER		HWY	5	34.550	43.750	1.5	1.5	2.0	6.850	5.600	1.900	0.700
PAINTER		ALL		34.400	38.700	1.5	1.5	2.0	6.200	6.400	0.000	0.390
PAINTER SIGNS		BLD		28.970	32.520	1.5	1.5	1.5	2.600	2.310	0.000	0.000
PILEDRIVER		ALL		36.050	39.650	1.5	1.5	2.0	6.850	9.810	0.000	0.490
PIPEFITTER		BLD		37.600	39.600	1.5	1.5	2.0	8.660	6.900	0.000	0.940
PLASTERER		BLD		33.850	35.350	1.5	1.5	2.0	6.740	7.100	0.000	0.400
PLUMBER		BLD		37.500	39.500	1.5	1.5	2.0	7.050	8.500	0.000	0.760
ROOFER		BLD		33.650	35.650	1.5	1.5	2.0	6.460	3.310	0.000	0.330
SHEETMETAL WORKER		BLD		36.510	38.510	1.5	1.5	2.0	6.890	8.020	0.000	0.640
SPRINKLER FITTER		BLD		38.500	40.500	1.5	1.5	2.0	8.250	6.100	0.000	0.500
STONE MASON		BLD		33.250	36.580	1.5	1.5	2.0	6.450	7.020	0.000	0.440
TERRAZZO FINISHER		BLD		29.290	0.000	1.5	1.5	2.0	5.650	6.940	0.000	0.270
TERRAZZO MASON		BLD		33.650	36.650	1.5	1.5	2.0	5.650	8.610	0.000	0.300
TILE MASON		BLD		34.600	38.600	2.0	1.5	2.0	5.650	7.000	0.000	0.460
TRAFFIC SAFETY WRKR		HWY		22.800	24.400	1.5	1.5	2.0	3.078	1.875	0.000	0.000
TRUCK DRIVER		ALL	1	33.040	33.590	1.5	1.5	2.0	5.500	3.875	0.000	0.000
TRUCK DRIVER		ALL	2	33.190	33.590	1.5	1.5	2.0	5.500	3.875	0.000	0.000
TRUCK DRIVER		ALL	3	33.390	33.590	1.5	1.5	2.0	5.500	3.875	0.000	0.000
TRUCK DRIVER		ALL	4	33.590	33.590	1.5	1.5	2.0	5.500	3.875	0.000	0.000
TUCKPOINTER		BLD		34.500	35.500	1.5	1.5	2.0	4.710	6.340	0.000	0.400

Legend:

M-F>8 (Overtime is required for any hour greater than 8 worked each day, Monday through Friday.)

OSA (Overtime is required for every hour worked on Saturday)

OSH (Overtime is required for every hour worked on Sunday and Holidays)

H/W (Health & Welfare Insurance)

Pensn (Pension)

Vac (Vacation)

Trng (Training)

## Explanations

### WILL COUNTY

IRONWORKERS (SOUTH) - That part of the county South of a diagonal line through Braidwood and Goodenow.

The following list is considered as those days for which holiday rates of wages for work performed apply: New Years Day, Memorial/Decoration Day, Fourth of July, Labor Day, Veterans Day, Thanksgiving Day, Christmas Day. Generally, any of these holidays which fall on a Sunday is celebrated on the following Monday. This then makes work performed on that Monday payable at the appropriate overtime rate for holiday pay. Common practice in a given local may alter certain days of celebration such as the day after Thanksgiving for Veterans Day. If in doubt, please check with IDOL.

### EXPLANATION OF CLASSES

ASBESTOS - GENERAL - removal of asbestos material/mold and hazardous materials from any place in a building, including mechanical systems where those mechanical systems are to be removed. This includes the removal of asbestos materials/mold and hazardous materials from ductwork or pipes in a building when the building is to be demolished at the time or at some close future date.

ASBESTOS - MECHANICAL - removal of asbestos material from mechanical systems, such as pipes, ducts, and boilers, where the mechanical systems are to remain.

### CERAMIC TILE FINISHER

The grouting, cleaning, and polishing of all classes of tile, whether for interior or exterior purposes, all burned, glazed or unglazed products; all composition materials, granite tiles, warning detectable tiles, cement tiles, epoxy composite materials, pavers, glass, mosaics, fiberglass, and all substitute materials, for tile made in tile-like units; all mixtures in tile like form of cement, metals, and other materials that are for and intended for use as a finished floor surface, stair treads, promenade roofs, walks, walls, ceilings, swimming pools, and all other places where tile is to form a finished interior or exterior. The mixing of all setting mortars including but not limited to thin-set mortars, epoxies, wall mud, and any other sand and cement mixtures or adhesives when used in the preparation,



installation, repair, or maintenance of tile and/or similar materials. The handling and unloading of all sand, cement, lime, tile, fixtures, equipment, adhesives, or any other materials to be used in the preparation, installation, repair, or maintenance of tile and/or similar materials. Ceramic Tile Finishers shall fill all joints and voids regardless of method on all tile work, particularly and especially after installation of said tile work. Application of any and all protective coverings to all types of tile installations including, but not be limited to, all soap compounds, paper products, tapes, and all polyethylene coverings, plywood, masonite, cardboard, and any new type of products that may be used to protect tile installations, Blastrac equipment, and all floor scarifying equipment used in preparing floors to receive tile. The clean up and removal of all waste and materials. All demolition of existing tile floors and walls to be re-tiled.

#### COMMUNICATIONS TECHNICIAN

Installation, operation, inspection, maintenance, repair and service of radio, television, recording, voice, sound and vision production and reproduction, telephone and telephone interconnect, facsimile, equipment and appliances used for domestic, commercial, educational and entertainment purposes, pulling of wire through conduit but not the installation of conduit.

#### MARBLE FINISHER

Loading and unloading trucks, distribution of all materials (all stone, sand, etc.), stocking of floors with material, performing all rigging for heavy work, the handling of all material that may be needed for the installation of such materials, building of scaffolding, polishing if needed, patching, waxing of material if damaged, pointing up, caulking, grouting and cleaning of marble, holding water on diamond or Carborundum blade or saw for setters cutting, use of tub saw or any other saw needed for preparation of material, drilling of holes for wires that anchor material set by setters, mixing up of molding plaster for installation of material, mixing up thin set for the installation of material, mixing up of sand to cement for the installation of material and such other work as may be required in helping a Marble Setter in the handling of all material in the erection or installation of interior marble, slate, travertine, art marble, serpentine, alberene stone, blue stone, granite and other stones (meaning as to stone any foreign or domestic materials as are specified and used in building interiors and exteriors and customarily known as stone in the trade), carrara, sanionyx, vitrolite and similar opaque glass and the laying of all marble tile, terrazzo tile, slate tile and precast tile, steps, risers treads, base, or any other materials that may be used as substitutes for any of the aforementioned materials and which are used on interior and exterior which are installed in a similar manner.

MATERIAL TESTER I: Hand coring and drilling for testing of materials; field inspection of uncured concrete and asphalt.

MATERIAL TESTER II: Field inspection of welds, structural steel, fireproofing, masonry, soil, facade, reinforcing steel, formwork, cured concrete, and concrete and asphalt batch plants; adjusting proportions of bituminous mixtures.

TRAFFIC SAFETY - work associated with barricades, horses and drums used to reduce lane usage on highway work, the installation and removal of temporary lane markings, and the installation and removal of temporary road signs.

#### TRUCK DRIVER - BUILDING, HEAVY AND HIGHWAY CONSTRUCTION

Class 1. Two or three Axle Trucks. A-frame Truck when used for transportation purposes; Air Compressors and Welding Machines, including those pulled by cars, pick-up trucks and tractors; Ambulances; Batch Gate Lockers; Batch Hopperman; Car and Truck Washers; Carry-alls; Fork Lifts and Hoisters; Helpers; Mechanics Helpers and Greasers; Oil Distributors 2-man operation; Pavement Breakers; Pole Trailer, up to 40 feet; Power Mower Tractors; Self-propelled Chip Spreader; Skipman; Slurry Trucks, 2-man operation; Slurry Truck Conveyor Operation, 2 or 3 man; Teamsters; Unskilled dumpman; and Truck Drivers hauling warning lights, barricades, and portable toilets on the job site.

Class 2. Four axle trucks; Dump Crets and Adgetors under 7 yards; Dumpsters, Track Trucks, Euclids, Hug Bottom Dump Turnapulls or Turnatrailers when pulling other than self-loading equipment or similar equipment under 16 cubic yards; Mixer Trucks under 7 yards; Ready-mix Plant Hopper Operator, and Winch Trucks, 2 Axles.

Class 3. Five axle trucks; Dump Crets and Adgetors 7 yards and over; Dumpsters, Track Trucks, Euclids, Hug Bottom Dump Turnatrailers or turnapulls when pulling other than self-loading equipment or similar equipment over 16 cubic yards; Explosives and/or Fission Material Trucks; Mixer Trucks 7 yards or over; Mobile Cranes while in transit; Oil Distributors, 1-man operation; Pole Trailer, over 40 feet; Pole and Expandable Trailers hauling material over 50 feet long; Slurry trucks, 1-man operation; Winch trucks, 3 axles or more; Mechanic--Truck Welder and Truck Painter.

Class 4. Six axle trucks; Dual-purpose vehicles, such as mounted crane trucks with hoist and accessories; Foreman; Master Mechanic; Self-loading equipment like P.B. and trucks with scoops on the front.

#### OPERATING ENGINEERS - BUILDING

Class 1. Mechanic; Asphalt Plant; Asphalt Spreader; Autograde; Backhoes with Caisson attachment; Batch Plant; Benoto; Boiler and Throttle Valve; Caisson Rigs; Central Redi-Mix Plant; Combination Back Hoe Front End-loader Machine; Compressor and Throttle Valve; Concrete Breaker (Truck Mounted); Concrete Conveyor; Concrete Paver; Concrete Placer; Concrete Placing Boom; Concrete Pump (Truck Mounted); Concrete Tower; Cranes, All; Cranes, Hammerhead; Cranes, (GCI and similar Type); Creter Crane; Crusher, Stone, etc.; Derricks, All; Derricks, Traveling; Formless Curb and Gutter Machine; Grader, Elevating; Grouting Machines; Highlift Shovels or Front Endloader 2-1/4 yd. and over; Hoists, Elevators, outside type rack and pinion and similar machines; Hoists, one, two and three Drum; Hoists, Two Tugger One Floor; Hydraulic Backhoes; Hydraulic Boom Trucks; Hydro Vac (and similar equipment); Locomotives, All; Motor Patrol; Pile Drivers and Skid Rig; Post Hole Digger; Pre-Stress Machine; Pump Cretes Dual Ram; Pump Cretes; Squeeze Cretes-screw Type Pumps; Raised and Blind Hole Drill; Roto Mill Grinder; Scoops - Tractor Drawn; Slip-form Paver; Straddle Buggies; Tournapull; Tractor with Boom and Side Boom; Trenching Machines.

Class 2. Boilers; Broom, All Power Propelled; Bulldozers; Concrete Mixer (Two Bag and Over); Conveyor, Portable; Forklist Trucks; Greaser Engineer; Highlift Shovels or Front Endloaders under 2-1/4 yd.; Hoists, Automatic; Hoists, inside Freight Elevators; Hoists, Sewer Dragging Machine; Hoists, Tugger Single Drum; Laser Screed; Rock Drill (self-propelled); Rock Drill (truck mounted); Rollers, All; Steam Generators; Tractors, All; Tractor Drawn Vibratory Roller;

Winch Trucks with "A" Frame.

Class 3. Air Compressor; Combination - Small Equipment Operator; Generators; Heaters, Mechanical; Hoists, Inside Elevators - (Rheostat Manual Controlled); Hydraulic Power Units (Pile Driving, Extracting, and Drilling); Pumps, over 3" (1 to 3 not to exceed a total of 300 ft.); Pumps, Well Points; Welding Machines (2 through 5); Winches, 4 small Electric Drill Winches; Bobcat (up to and including 3/4 cu. yd.).

Class 4. Bobcats and/or other Skid Steer Loaders; Oilers; and Brick Forklift.

#### OPERATING ENGINEERS - FLOATING

Class 1. Craft foreman (Master Mechanic), diver/wet tender, engineer (hydraulic dredge).

Class 2. Crane/backhoe operator, mechanic/welder, assistant engineer (hydraulic dredge), leverman (hydraulic dredge), and diver tender.

Class 3. Deck equipment operator (machineryman), maintenance of crane (over 50 ton capacity) or backhoe (96,000 pounds or more), tug/launch operator, loader, dozer and like equipment on barge, breakwater wall, slip/dock or scow, deck machinery, etc.

Class 4. Deck equipment operator (machineryman/fireman), (4 equipment units or more) and crane maintenance 50 ton capacity and under or backhoe weighing 96,000 pounds or less, assistant tug operator.

#### OPERATING ENGINEERS - HEAVY AND HIGHWAY CONSTRUCTION

Class 1. Craft Foreman; Asphalt Plant; Asphalt Heater and Planer Combination; Asphalt Heater Scarfire; Asphalt Spreader; Autograder/GOMACO or other similar type machines; ABG Paver; Backhoes with Caisson attachment; Ballast Regulator; Belt Loader; Caisson Rigs; Car Dumper; Central Redi-Mix Plant; Combination Backhoe Front Endloader Machine, (1 cu. yd. Backhoe Bucket or over or with attachments); Concrete Breaker (Truck Mounted); Concrete Conveyor; Concrete Paver over 27E cu. ft.; Concrete Placer; Concrete Tube Float; Cranes, all attachments; Cranes, Hammerhead, Linden, Peco & Machines of a like nature; Crete Crane; Crusher, Stone, etc.; Derricks, All; Derrick Boats; Derricks, Traveling; Dowell machine with Air Compressor; Dredges; Field Mechanic-Welder; Formless Curb and Gutter Machine; Gradall and Machines of a like nature; Grader, Elevating; Grader, Motor Grader, Motor Patrol, Auto Patrol, Form Grader, Pull Grader, Subgrader; Guard Rail Post Driver Mounted; Hoists, One, Two and Three Drum; Hydraulic Backhoes; Backhoes with shear attachments; Mucking Machine; Pile Drivers and Skid Rig; Pre-Stress Machine; Pump Cretes Dual Ram; Rock Drill - Crawler or Skid Rig; Rock Drill - Truck Mounted; Roto Mill Grinder; Slip-Form Paver; Soil Test Drill Rig (Truck Mounted); Straddle Buggies; Hydraulic Telescoping Form (Tunnel); Tractor Drawn Belt Loader (with attached pusher - two engineers); Tractor with Boom; Tractaire with Attachments; Trenching Machine; Truck Mounted Concrete Pump with Boom; Raised or Blind Hole; Drills (Tunnel Shaft); Underground Boring and/or Mining Machines; Wheel Excavator; Widener (APSCO).

Class 2. Batch Plant; Bituminous Mixer; Boiler and Throttle Valve; Bulldozers; Car Loader Trailing Conveyors; Combination Backhoe Front Endloader Machine (less than 1 cu. yd. Backhoe Bucket or over or with attachments); Compressor and Throttle Valve; Compressor, Common Receiver (3); Concrete Breaker or Hydro Hammer; Concrete Grinding Machine; Concrete Mixer or Paver 7S Series to and including 27 cu.

ft.; Concrete Spreader; Concrete Curing Machine, Burlap Machine, Belting Machine and Sealing Machine; Concrete Wheel Saw; Conveyor Muck Cars (Haglund or Similar Type); Drills, All; Finishing Machine - Concrete; Greaser Engineer; Highlift Shovels or Front Endloader; Hoist - Sewer Dragging Machine; Hydraulic Boom Trucks (All Attachments); Hydro-Blaster; All Locomotives, Dinky; Pump Cretes; Squeeze Cretes-Screw Type Pumps, Gypsum Bulker and Pump; Roller, Asphalt; Rotary Snow Plows; Rototiller, Seaman, etc., self-propelled; Scoops - Tractor Drawn; Self-Propelled Compactor; Spreader - Chip - Stone, etc.; Scraper; Scraper - Prime Mover in Tandem (Regardless of Size); Tank Car Heater; Tractors, Push, Pulling Sheeps Foot, Disc, Compactor, etc.; Tug Boats.

Class 3. Boilers; Brooms, All Power Propelled; Cement Supply Tender; Compressor, Common Receiver (2); Concrete Mixer (Two Bag and Over); Conveyor, Portable; Farm-Type Tractors Used for Mowing, Seeding, etc.; Fireman on Boilers; Forklift Trucks; Grouting Machine; Hoists, Automatic; Hoists, All Elevators; Hoists, Tugger Single Drum; Jeep Diggers; Pipe Jacking Machines; Post-Hole Digger; Power Saw, Concrete Power Driven; Pug Mills; Rollers, other than asphalt; Seed and Straw Blower; Steam Generators; Stump Machine; Winch Trucks with "A" Frame; Work Boats; Tamper - Form-Motor Driven.

Class 4. Air Compressor; Combination - Small Equipment Operator; Directional Boring Machine; Generators; Heaters, Mechanical; Hydraulic Power Unit (Pile Driving, Extracting, or Drilling); Hydro-Blaster; Light Plants, All (1 through 5); Pumps, over 3" (1 to 3 not to exceed a total of 300 ft.); Pumps, Well Points; Tractaire; Welding Machines (2 through 5); Winches, 4 Small Electric Drill Winches.

Class 5. Bobcats (all); Brick Forklifts; Oilers.

#### TERRAZZO FINISHER

The handling of sand, cement, marble chips, and all other materials that may be used by the Mosaic Terrazzo Mechanic, and the mixing, grinding, grouting, cleaning and sealing of all Marble, Mosaic, and Terrazzo work, floors, base, stairs, and wainscoting by hand or machine, and in addition, assisting and aiding Marble, Masonic, and Terrazzo Mechanics.

#### Other Classifications of Work:

For definitions of classifications not otherwise set out, the Department generally has on file such definitions which are available. If a task to be performed is not subject to one of the classifications of pay set out, the Department will upon being contacted state which neighboring county has such a classification and provide such rate, such rate being deemed to exist by reference in this document. If no neighboring county rate applies to the task, the Department shall undertake a special determination, such special determination being then deemed to have existed under this determination. If a project requires these, or any classification not listed, please contact IDOL at 618/993-7271 for wage rates or clarifications.

#### LANDSCAPING

Landscaping work falls under the existing classifications for laborer, operating engineer and truck driver. The work performed by landscape plantsman and landscape laborer is covered by the existing classification of laborer. The work performed by landscape operators (regardless of equipment used or its size) is covered by the

classifications of operating engineer. The work performed by landscape truck drivers (regardless of size of truck driven) is covered by the classifications of truck driver.

# Williamson County Prevailing Wage for April 2007

Trade Name	RG	TYP	C	Base	FRMAN	*M-F>8	OSA	OSH	H/W	Pensn	Vac	Trng
=====	==	==	=	=====	=====	=====	==	==	=====	=====	=====	=====
ASBESTOS ABT-GEN		ALL		20.750	21.200	1.5	1.5	2.0	5.250	5.600	0.000	0.700
ASBESTOS ABT-MEC		BLD		20.800	0.000	2.0	2.0	2.0	5.000	3.400	0.000	0.000
BOILERMAKER		BLD		28.500	31.000	1.5	1.5	2.0	6.820	11.03	0.000	0.300
BRICK MASON		BLD		25.470	26.970	1.5	1.5	2.0	6.000	5.400	0.000	0.425
CARPENTER		BLD		27.780	29.280	1.5	1.5	2.0	5.050	3.750	0.000	0.350
CARPENTER		HWY		27.730	29.230	1.5	1.5	2.0	5.050	3.750	0.000	0.350
CEMENT MASON		BLD		23.500	24.500	1.5	1.5	2.0	5.200	3.550	0.000	0.100
CEMENT MASON		HWY		23.750	24.750	1.5	1.5	2.0	5.300	3.700	0.000	0.300
CERAMIC TILE FNSHER		BLD		24.990	0.000	1.5	1.5	2.0	6.000	5.400	0.000	0.425
ELECTRICIAN		ALL		32.910	35.160	1.5	1.5	2.0	5.150	6.580	0.000	0.490
ELECTRONIC SYS TECH		BLD		25.700	27.200	1.5	1.5	2.0	5.150	3.340	0.000	0.250
FLOOR LAYER		BLD		26.930	27.680	1.5	1.5	2.0	5.000	3.750	0.000	0.350
GLAZIER		BLD		22.930	0.000	1.5	1.5	2.0	4.320	3.800	0.000	0.300
HT/FROST INSULATOR		BLD		26.110	27.110	1.5	1.5	2.0	4.800	6.860	0.000	0.190
IRON WORKER		ALL		22.650	23.650	1.5	1.5	2.0	5.760	6.450	0.000	0.310
LABORER		BLD		20.750	21.200	1.5	1.5	2.0	5.250	5.600	0.000	0.600
LABORER		HWY		21.000	21.450	1.5	1.5	2.0	5.350	6.150	0.000	0.600
LABORER		O&C		15.750	16.200	1.5	1.5	2.0	5.350	6.150	0.000	0.600
MACHINIST		BLD		36.890	38.890	2.0	2.0	2.0	4.380	5.650	2.550	0.000
MARBLE FINISHERS		BLD		24.990	0.000	1.5	1.5	2.0	6.000	5.400	0.000	0.425
MARBLE MASON		BLD		25.470	26.970	1.5	1.5	2.0	6.000	5.400	0.000	0.425
MILLWRIGHT		BLD		27.780	29.280	1.5	1.5	2.0	5.050	3.750	0.000	0.350
MILLWRIGHT		HWY		27.730	29.230	1.5	1.5	2.0	5.050	3.750	0.000	0.350
OE RIVER 1		RIV	1	26.900	0.000	1.5	1.5	2.0	5.650	6.100	0.000	1.100
OE RIVER 2		RIV	2	23.450	0.000	1.5	1.5	2.0	5.650	6.100	0.000	1.100
OPERATING ENGINEER		ALL	1	26.800	27.800	1.5	1.5	2.0	5.650	6.100	0.000	1.100
OPERATING ENGINEER		ALL	2	24.900	27.800	1.5	1.5	2.0	5.650	6.100	0.000	1.100
OPERATING ENGINEER		ALL	3	24.150	27.800	1.5	1.5	2.0	5.650	6.100	0.000	1.100
OPERATING ENGINEER		ALL	4	21.400	27.800	1.5	1.5	2.0	5.650	6.100	0.000	1.100
OPERATING ENGINEER		O&C	1	20.100	21.100	1.5	1.5	2.0	5.650	6.100	0.000	1.100
OPERATING ENGINEER		O&C	2	18.680	21.100	1.5	1.5	2.0	5.650	6.100	0.000	1.100
OPERATING ENGINEER		O&C	3	18.120	21.100	1.5	1.5	2.0	5.650	6.100	0.000	1.100
OPERATING ENGINEER		O&C	4	16.050	21.100	1.5	1.5	2.0	5.650	6.100	0.000	1.100
PAINTER		BLD		22.790	23.790	1.5	1.5	2.0	5.430	4.500	0.000	0.250
PAINTER		HWY		27.090	28.090	1.5	1.5	2.0	5.430	4.500	0.000	0.250
PAINTER OVER 30FT		BLD		23.790	24.790	1.5	1.5	2.0	5.430	4.500	0.000	0.250
PAINTER PWR EQMT		BLD		23.790	24.790	1.5	1.5	2.0	5.430	4.500	0.000	0.250
PAINTER PWR EQMT		HWY		28.090	29.090	1.5	1.5	2.0	5.430	4.500	0.000	0.250
PILEDRIVER		BLD		27.780	29.280	1.5	1.5	2.0	5.050	3.750	0.000	0.350
PILEDRIVER		HWY		27.730	29.230	1.5	1.5	2.0	5.050	3.750	0.000	0.350
PIPEFITTER		BLD		28.750	31.620	1.5	1.5	2.0	6.000	7.500	0.000	0.400
PLASTERER		BLD		23.500	24.500	1.5	1.5	2.0	5.200	3.550	0.000	0.100
PLUMBER		BLD		29.500	32.450	1.5	1.5	2.0	6.600	7.500	0.000	0.550
ROOFER		BLD		19.700	20.500	1.5	1.5	2.0	5.700	3.800	0.000	0.000
SHEETMETAL WORKER		ALL		27.210	28.460	1.5	1.5	2.0	6.000	4.770	1.630	0.120
SPRINKLER FITTER		BLD		31.240	33.240	1.5	1.5	2.0	6.500	5.350	0.000	0.250
STONE MASON		BLD		25.470	26.970	1.5	1.5	2.0	6.000	5.400	0.000	0.425
TERRAZZO FINISHER		BLD		24.990	0.000	1.5	1.5	2.0	6.000	5.400	0.000	0.425
TERRAZZO MASON		BLD		28.500	28.800	1.5	1.5	2.0	0.000	2.950	0.000	0.000
TRUCK DRIVER		ALL	1	24.990	0.000	1.5	1.5	2.0	7.250	4.200	0.000	0.000
TRUCK DRIVER		ALL	2	25.390	0.000	1.5	1.5	2.0	7.250	4.200	0.000	0.000
TRUCK DRIVER		ALL	3	25.590	0.000	1.5	1.5	2.0	7.250	4.200	0.000	0.000
TRUCK DRIVER		ALL	4	25.840	0.000	1.5	1.5	2.0	7.250	4.200	0.000	0.000
TRUCK DRIVER		ALL	5	26.590	0.000	1.5	1.5	2.0	7.250	4.200	0.000	0.000
TRUCK DRIVER		O&C	1	19.500	0.000	1.5	1.5	2.0	4.275	4.670	0.000	0.000
TRUCK DRIVER		O&C	2	15.900	0.000	1.5	1.5	2.0	4.275	4.670	0.000	0.000
TRUCK DRIVER		O&C	3	16.400	0.000	1.5	1.5	2.0	4.275	4.670	0.000	0.000
TUCKPOINTER		BLD		25.470	26.970	1.5	1.5	2.0	6.000	5.400	0.000	0.425

Legend:

M-F>8 (Overtime is required for any hour greater than 8 worked each day, Monday through Friday.)

OSA (Overtime is required for every hour worked on Saturday)

OSH (Overtime is required for every hour worked on Sunday and Holidays)

H/W (Health & Welfare Insurance)

Pensn (Pension)

Vac (Vacation)

Trng (Training)

## Explanations

### WILLIAMSON COUNTY

The following list is considered as those days for which holiday rates of wages for work performed apply: New Years Day, Memorial/Decoration Day, Fourth of July, Labor Day, Veterans Day, Thanksgiving Day, Christmas Day. Generally, any of these holidays which fall on a Sunday is celebrated on the following Monday. This then makes work performed on that Monday payable at the appropriate overtime rate for holiday pay. Common practice in a given local may alter certain days of celebration such as the day after Thanksgiving for Veterans Day. If in doubt, please check with IDOL.

Oil and chip resealing (O&C) means the application of road oils and liquid asphalt to coat an existing road surface, followed by application of aggregate chips or gravel to coated surface, and subsequent rolling of material to seal the surface.

### EXPLANATION OF CLASSES

ASBESTOS - GENERAL - removal of asbestos material/mold and hazardous materials from any place in a building, including mechanical systems where those mechanical systems are to be removed. This includes the removal of asbestos materials/mold and hazardous materials from ductwork or pipes in a building when the building is to be demolished at the time or at some close future date.

ASBESTOS - MECHANICAL - removal of asbestos material from mechanical systems, such as pipes, ducts, and boilers, where the mechanical systems are to remain.

### LABORER - OIL AND CHIP RESEALING ONLY

Hook and unhook chip box from aggregate truck; distribute material within chip box; perform flagging work related to oil and chip resealing; hand spray oil fluids; handle traffic control, including setting-up and maintaining barricades, drums, cones, delineators, signs and other such items, as well as laying-out and applying or removing temporary roadway markings used to control traffic in job

site related to oil and chip resealing; and perform clean-up related to oil and chip resealing.

#### CERAMIC TILE FINISHER, MARBLE FINISHER, TERRAZZO FINISHER

Assisting, helping or supporting the tile, marble and terrazzo mechanic by performing their historic and traditional work assignments required to complete the proper installation of the work covered by said crafts. The term "Ceramic" is used for naming the classification only, and is in no a limitation of the product handled. Ceramic takes into consideration most hard tiles.

#### ELECTRONIC SYSTEMS TECHNICIAN

Installation, service and maintenance of low-voltage systems which utilizes the transmission and/or transference of voice, sound, vision, or digital for commercial, education, security and entertainment purposes for the following: TV monitoring and surveillance, background/foreground music, intercom and telephone interconnect, field programming, inventory control systems, microwave transmission, multi-media, multiplex, radio page, school, intercom and sound burglar alarms and low voltage master clock systems.

Excluded from this classification are energy management systems, life safety systems, supervisory controls and data acquisition systems not intrinsic with the above listed systems, fire alarm systems, nurse call systems and raceways exceeding fifteen feet in length.

#### TRUCK DRIVER - BUILDING, HEAVY AND HIGHWAY CONSTRUCTION

Class 1. Drivers on 2 axle trucks hauling less than 9 ton. Air compressor and welding machines and brooms, including those pulled by separate units, truck driver helpers, warehouse employees, mechanic helpers, greasers and tiremen, pickup trucks when hauling materials, tools, or workers to and from and on-the-job site, and fork lifts up to 6,000 lb. capacity.

Class 2. Two or three axle trucks hauling more than 9 ton but hauling less than 16 ton. A-frame winch trucks, hydrolift trucks, vector trucks or similar equipment when used for transportation purposes. Fork lifts over 6,000 lb. capacity, winch trucks, four axle combination units, and ticket writers.

Class 3. Two, three or four axle trucks hauling 16 ton or more. Drivers on water pulls, articulated dump trucks, mechanics and working forepersons, and dispatchers. Five axle or more combination units.

Class 4. Low Boy and Oil Distributors.

Class 5. Drivers who require special protective clothing while employed on hazardous waste work.

#### TRUCK DRIVER - O & C (Oil and Chip Resealing ONLY)

It involves driving of contractor or subcontractor owned, leased, or hired pickup, dump, service, or oil distributor trucks. Includes transporting materials and equipment (including, but not limited to oils, aggregate supplies, parts, machinery and tools) to or from the job site; distributing oil or liquid asphalt and aggregate; stock piling material; and maintaining trucks at job site related to oil and chip resealing.

Class 1. Distributors, liquid asphalt hauling and hauling of asphalt rubber-tired rollers.



Class 2. Stockpiling.

Class 3. Tandem hauling to job site.

OPERATING ENGINEERS - BUILDING, HEAVY AND HIGHWAY CONSTRUCTION

Class 1. APSCO or Equal Spreading Machine, Backhoe, Backfiller, Boom or Winch Cat, Bituminous Mixplane Machine, Blacksmith, Bituminous Surfacing Machine, Bull-Dozer, Crane, Shovel, Dragline, Truck Crane, Pile Driver, Concrete Breaker, Concrete or Pumpcrete Pumps, Dinky or Standard Locomotives, Well or Caisson Drills, Elevating Grader, Fork Lifts, Flexplane, Gradeall, Hi-Lift Hoists, Guy-Derricks, Hysters, Mechanic Motor Patrol, Mixers-21 cu. ft. or over, Push Cats, Pulls and Scrapers, Two Well Point Pumps, Pulverizer or Tiller, PugMill, Rubber-Tired Farm Type Tractor with Bulldozer/Blade/Auger or hi-lift over 1/2 yd., Jersey Spreader, Tract-Air used with Drill or Hi-Lift, Trenching or Ditching Machines, Wood Chipper w/Tractor, Self-Propelled Roller w/Blade, Equipment Greaser, Self-Propelled Bump Grinder on Concrete pavement, Boat Operator, Skid-Loaders, Tuggers, Lazer Screed, and Self-Propelled Chip Spreader (when others run conveyors).

Class 2. Any type tractor pulling any type roller or disc, Two Air Compressors (220 cu. ft. capacity or over), Two AirTract Drills, Air-Track Drill w/Compressor, Automatic Bins or Scales w/Compressor or Generator, Pipeline Boring Machine, Bulk Cement Plant w/Separate Compressor, Power Operated Bull Float, Hydra-Lift w/Single Motor, Straw Mulcher Blower w/Spout, Self-Propelled Roller/Compactor, Back-End man on Bituminous Surfacing Machine, oiler on milling machine.

Class 3. Air Compressor w/Valve driving piling, Boom or Winch Type Truck, Two Conveyors, Self-Propelled Concrete Saw, Form Grader, Truck Crane Oiler, Self-Propelled Vibrator, Rubber Tired Farm Type Tractor w/Blade/Bulldozer/Auger/hi-lift - 1/2 yd. or less, Elevator Operator, Man Lift (scissor lift) when lifting materials.

Class 4. Air-Track Drill (one), Belt Drag Machine, Power Broom, Mechanical Plasterer Applicator, Trac-Air, Air Compressor (220 cu. ft. or over) One, Air Compressor (under 220 cu. ft) four, Automatic Bin, Bulk Cement Plant w/Built-in Compressor running off same motor or electric motor, Fireman or Switchman, Self-Propelled Form Tamper, Light Plants (4), Welding Machines (4), Pumps (4), or Combination of four (4) Pumps, Light Plants, Welding Machines, Air-Compressors (under 220 cu. ft.), Mudjacks or Wood Chipper, Mixers - less than 21 cu. ft. Mortar Mixer w/Skip or Pump, Pipeline Tract Jack. One Operating Engineer may operate and maintain any combination of the following pieces of equipment, not to exceed four (4) which shall be within a reasonable distance, such combination may include any equipment in this classification: (Compressors, Light Plants, Generators, Welding Machines, Pumps or Conveyors), One Well- Point Pump, Two Motor Driven Heaters, One Air Compressor (under 220 cu. ft.), One Engine-Driven Conveyor, One Motor Driven Heater, One Light Plant, One Pump, One Welding Machine, One Ulmac or Equal Spreader, Oilers, and one Generator 10 kw or greater.

OPERATING ENGINEER - O & C (Oil and Chip Resealing ONLY). Includes the operation of all motorized heavy equipment used in oil and chip rsealing, including but not limited to operating self-propelled chip spreaders, and all types of rollers (both hard and rubber tired); and other duties pertaining to the operation or maintenance of heavy equipment related to oil and chip resealing.

Class 1. See Class 1 above for types of equipment operated.

Class 2. See Class 2 above for types of equipment operated.  
Class 3. See Class 3 above for types of equipment operated.  
Class 4. See Class 4 above for types of equipment operated.

OPERATING ENGINEER RIVER WORK 1 - operate the following machines when working on River Work and Levee Work on the Mississippi and Ohio Rivers, Lakes and Tributaries: Crane, Shovel, Drageline, Scrapers, Dredge, Derrick, Pile-Driver, Push Boat, all power boat operators, Mechanic, Engineman on Dredge, Leverman on Dredge, All Bituminous Spreader machines, Backhoe, Backfiller, Boom, or Winch Cat, Bituminous Mixplane Machine, Blacksmith, Bituminous Surfacing Machine, Bulldozer, Truck Cranes, Hydraulic Truck Mounted Boom/Crane, Concrete Finishing Machine, or Spreader Machine, Concrete Breaker, Concrete or Pumpcrete Machines, Concrete Plant Operator, All Off Road Material Hauling Equipment, Dinky or Standard Locomotives, Well Drill, Elevating Grader, Fork-Lifts, Flexplane, Gradeall, Hi-Lift, Power Handblade Tugger type Hoist, Hoist Two Drum (or over one), Gyderrick, Hyster, Motor Patrol, Mixers - 21 Cu. Ft. or over, Push Cat, Pulls, & Scrapers, Pumps-Two Well Points, Equipment Greaser, P & H Pulverizer or Pulverizer equal to Pugmill, Pugmill, Rubber-Tired farm type tractor w/Bulldozer/Blade/Auger or Hi-Lift over ½ yard, Skimmer Scoops, Seaman Tiller, Jersey Spreader, Tract-Air used with Drill or Hi-Lift, Trenching or Ditching Machine, Wood Chipper w/Tractor, self-propelled roller w/Blade, Concrete Pumps and Small Equipment Operators.

OPERATING ENGINEER RIVER 2 - when working on River Work and Levee Work on the Mississippi and Ohio Rivers, Lakes and Tributaries shall be employed as the Oiler or Fireman on Crane, Dragline, Shovel, Dredge, Truck Crane, Pile Driver, Gradeall, Dinky or Standard Locomotive, Guy Derrick, Trenching Machine or Ditching Machine 80 H.P. and over, All Terrain (cherry-picker) with over 40 ton Lifting Capacity, Deck Oiler and Deckhands.

#### Other Classifications of Work:

For definitions of classifications not otherwise set out, the Department generally has on file such definitions which are available. If a task to be performed is not subject to one of the classifications of pay set out, the Department will upon being contacted state which neighboring county has such a classification and provide such rate, such rate being deemed to exist by reference in this document. If no neighboring county rate applies to the task, the Department shall undertake a special determination, such special determination being then deemed to have existed under this determination. If a project requires these, or any classification not listed, please contact IDOL at 618/993-7271 for wage rates or clarifications.

#### LANDSCAPING

Landscaping work falls under the existing classifications for laborer, operating engineer and truck driver. The work performed by landscape plantsman and landscape laborer is covered by the existing classification of laborer. The work performed by landscape operators (regardless of equipment used or its size) is covered by the classifications of operating engineer. The work performed by landscape truck drivers (regardless of size of truck driven) is covered by the classifications of truck driver.

# Winnebago County Prevailing Wage for April 2007

Trade Name	RG	TYP	C	Base	FRMAN	*M-F>8	OSA	OSH	H/W	Pensn	Vac	Trng
=====	==	==	=	=====	=====	=====	==	==	=====	=====	=====	=====
ASBESTOS ABT-GEN		BLD		24.120	25.120	1.5	1.5	2.0	5.850	8.330	0.000	0.600
ASBESTOS ABT-MEC		BLD		18.950	0.000	1.5	1.5	2.0	2.700	3.350	0.000	0.000
BOILERMAKER		BLD		38.540	42.000	2.0	2.0	2.0	6.720	7.440	0.000	0.300
BRICK MASON		BLD		30.000	32.500	1.5	1.5	2.0	5.500	8.680	0.000	0.420
CARPENTER		BLD		30.230	33.560	1.5	1.5	2.0	5.500	7.450	0.000	0.600
CARPENTER		HWY		28.010	29.760	1.5	1.5	2.0	5.500	8.000	0.000	0.310
CEMENT MASON		ALL		30.250	32.750	1.5	1.5	2.0	5.500	7.550	0.000	0.100
CERAMIC TILE FNSHER		BLD		24.860	0.000	1.5	1.5	2.0	5.500	4.000	0.000	0.360
COMMUNICATION TECH		BLD		28.700	30.700	1.5	1.5	2.0	8.200	8.340	0.000	0.570
ELECTRIC PWR EQMT OP		ALL		27.920	35.880	1.5	1.5	2.0	4.750	7.820	0.000	0.210
ELECTRIC PWR GRNDMAN		ALL		21.640	35.880	1.5	1.5	2.0	4.750	6.060	0.000	0.160
ELECTRIC PWR LINEMAN		ALL		33.220	35.880	1.5	1.5	2.0	4.750	9.310	0.000	0.250
ELECTRIC PWR TRK DRV		ALL		22.340	35.880	1.5	1.5	2.0	4.750	6.260	0.000	0.170
ELECTRICIAN		BLD		33.570	36.930	1.5	1.5	2.0	8.200	11.15	0.000	0.670
ELEVATOR CONSTRUCTOR		BLD		38.620	43.450	2.0	2.0	2.0	8.275	6.060	2.320	0.000
GLAZIER		BLD		27.680	28.680	1.5	1.5	2.0	6.400	6.500	0.000	0.500
HT/FROST INSULATOR		BLD		29.630	31.850	1.5	1.5	2.0	6.000	8.720	0.000	0.000
IRON WORKER		ALL		30.760	32.300	2.0	2.0	2.0	6.950	16.62	0.000	0.550
LABORER		BLD		24.120	25.120	1.5	1.5	2.0	5.850	8.330	0.000	0.600
LABORER		HWY		23.270	24.020	1.5	1.5	2.0	5.850	8.330	0.000	0.600
LABORER, SKILLED		HWY		24.670	25.420	1.5	1.5	2.0	5.850	8.330	0.000	0.600
LATHER		BLD		30.230	33.560	1.5	1.5	2.0	5.500	7.450	0.000	0.600
MACHINIST		BLD		36.890	38.890	2.0	2.0	2.0	4.380	5.650	2.550	0.000
MARBLE FINISHERS		BLD		24.860	0.000	1.5	1.5	2.0	5.500	4.000	0.000	0.360
MARBLE MASON		BLD		28.140	28.390	1.5	1.5	2.0	5.500	5.220	0.000	0.380
MATERIAL TESTER 1		ALL		21.550	0.000	1.5	1.5	2.0	7.460	4.840	0.000	0.170
MATERIALS TESTER II		ALL		26.550	0.000	1.5	1.5	2.0	7.460	4.840	0.000	0.170
MILLWRIGHT		BLD		32.150	35.370	1.5	1.5	2.0	5.150	9.450	0.000	0.560
OPERATING ENGINEER		BLD	1	37.050	41.050	2.0	2.0	2.0	6.850	6.150	1.900	0.700
OPERATING ENGINEER		BLD	2	36.350	41.050	2.0	2.0	2.0	6.850	6.150	1.900	0.700
OPERATING ENGINEER		BLD	3	33.900	41.050	2.0	2.0	2.0	6.850	6.150	1.900	0.700
OPERATING ENGINEER		BLD	4	31.900	41.050	2.0	2.0	2.0	6.850	6.150	1.900	0.700
OPERATING ENGINEER		HWY	1	36.900	40.900	1.5	1.5	2.0	6.850	6.150	1.900	0.700
OPERATING ENGINEER		HWY	2	36.350	40.900	1.5	1.5	2.0	6.850	6.150	1.900	0.700
OPERATING ENGINEER		HWY	3	35.050	40.900	1.5	1.5	2.0	6.850	6.150	1.900	0.700
OPERATING ENGINEER		HWY	4	33.600	40.900	1.5	1.5	2.0	6.850	6.150	1.900	0.700
OPERATING ENGINEER		HWY	5	32.150	40.900	1.5	1.5	2.0	6.850	6.150	1.900	0.700
PAINTER		ALL		29.650	30.650	1.5	1.5	1.5	5.650	5.750	0.000	0.350
PILEDRIVER		BLD		31.230	34.670	1.5	1.5	2.0	5.500	7.450	0.000	0.600
PILEDRIVER		HWY		28.010	29.760	1.5	1.5	2.0	5.500	8.000	0.000	0.310
PIPEFITTER		BLD		33.700	36.060	1.5	1.5	2.0	6.430	7.130	0.000	0.630
PLASTERER		BLD		29.540	32.490	1.5	1.5	2.0	5.500	7.350	0.000	0.100
PLUMBER		BLD		33.700	36.060	1.5	1.5	2.0	6.430	7.130	0.000	0.630
ROOFER		BLD		33.650	35.650	1.5	1.5	2.0	6.460	3.310	0.000	0.330
SHEETMETAL WORKER		BLD		31.690	33.620	1.5	1.5	2.0	4.850	10.29	0.520	0.290
SPRINKLER FITTER		BLD		31.240	33.240	1.5	1.5	2.0	6.500	5.350	0.000	0.250
STONE MASON		BLD		30.000	32.500	1.5	1.5	2.0	5.500	8.680	0.000	0.420
TERRAZZO FINISHER		BLD		24.860	0.000	1.5	1.5	2.0	5.500	4.000	0.000	0.360
TERRAZZO MASON		BLD		28.140	28.390	1.5	1.5	2.0	5.500	5.220	0.000	0.380
TILE LAYER		BLD		30.230	33.560	1.5	1.5	2.0	5.500	7.450	0.000	0.600
TILE MASON		BLD		28.140	28.390	1.5	1.5	2.0	5.500	5.220	0.000	0.380
TRUCK DRIVER		ALL	1	25.880	26.430	1.5	1.5	2.0	5.150	6.500	0.000	0.000
TRUCK DRIVER		ALL	2	26.030	26.430	1.5	1.5	2.0	5.150	6.500	0.000	0.000
TRUCK DRIVER		ALL	3	26.230	26.430	1.5	1.5	2.0	5.150	6.500	0.000	0.000
TRUCK DRIVER		ALL	4	26.430	26.430	1.5	1.5	2.0	5.150	6.500	0.000	0.000
TUCKPOINTER		BLD		30.000	32.500	1.5	1.5	2.0	5.500	8.680	0.000	0.420

Legend:

M-F>8 (Overtime is required for any hour greater than 8 worked each day, Monday through Friday.)

OSA (Overtime is required for every hour worked on Saturday)

OSH (Overtime is required for every hour worked on Sunday and Holidays)

H/W (Health & Welfare Insurance)

Pensn (Pension)

Vac (Vacation)

Trng (Training)

## Explanations

### WINNEBAGO COUNTY

The following list is considered as those days for which holiday rates of wages for work performed apply: New Years Day, Memorial/Decoration Day, Fourth of July, Labor Day, Veterans Day, Thanksgiving Day, Christmas Day. Generally, any of these holidays which fall on a Sunday is celebrated on the following Monday. This then makes work performed on that Monday payable at the appropriate overtime rate for holiday pay. Common practice in a given local may alter certain days of celebration such as the day after Thanksgiving for Veterans Day. If in doubt, please check with IDOL.

### EXPLANATION OF CLASSES

ASBESTOS - GENERAL - removal of asbestos material/mold and hazardous materials from any place in a building, including mechanical systems where those mechanical systems are to be removed. This includes the removal of asbestos materials/mold and hazardous materials from ductwork or pipes in a building when the building is to be demolished at the time or at some close future date.

ASBESTOS - MECHANICAL - removal of asbestos material from mechanical systems, such as pipes, ducts, and boilers, where the mechanical systems are to remain.

### CERAMIC TILE FINISHER, MARBLE FINISHER, TERRAZZO FINISHER

Assisting, helping or supporting the tile, marble and terrazzo mechanic by performing their historic and traditional work assignments required to complete the proper installation of the work covered by said crafts. The term "Ceramic" is used for naming the classification only and is in no way a limitation of the product handled. Ceramic takes into consideration most hard tiles.

### COMMUNICATIONS TECHNICIAN

Installing, manufacturing, assembling and maintaining sound and intercom, protection alarm (security), fire alarm, master antenna television, closed circuit television, low voltage control for computers and/or door monitoring, school communications systems, telephones and servicing of nurse and emergency calls, and the installation and maintenance of transmit and receive antennas,

transmitters, receivers, and associated apparatus which operates in conjunction with above systems. All work associated with these system installations will be included EXCEPT the installation of protective metallic conduit in new construction projects (excluding less than ten-foot, runs strictly for protection of cable) and 120 volt AC (or higher) power wiring and associated hardware.

#### LABORER, SKILLED - HIGHWAY

Individuals engaged in the following types of work, irrespective of the site of the work: asbestos abatement worker, handling of any materials with any foreign matter harmful to skin or clothing, track laborer, cement handlers, chloride handlers, the unloading and loading with steel workers and re-bars, concrete workers wet, tunnel helpers in free air, batch dumpers, mason tenders, kettle and tar men, tank cleaners, plastic installers, scaffold workers, motorized buggies or motorized unit used for wet concrete or handling of building materials, laborers with de-watering systems, sewer workers plus depth, rod and chainmen with technical engineers, rod and chainmen with land surveyors, rod and chainmen with surveyors, vibrator operators, cement silica, clay, fly ash, lime and plasters, handlers (bulk or bag), cofferdam workers plus depth, on concrete paving, placing, cutting and tying of reinforcing, deck hand, dredge hand, and shore laborers, bankmen on floating plant, grade checker, power tools, front end man on chip spreaders, cession workers plus depth, gunnite nozzle men, lead man on sewer work, welders, cutters, burners and torchmen, chainsaw operators, jackhammer and drill operators, layout man and/or drainage tile layer, steel form setter - street and highway, air tamping hammermen, signal man on crane, concrete saw operator, screedman on asphalt pavers, laborers tending masons with hot material or where foreign materials are used, mortar mixer operators, multiple concrete duct - leadsman, lumen, asphalt raker, curb asphalt machine operator, ready mix scalemen (permanent, portable or temporary plant), laborers handling masterplate or similar materials, laser beam operator, con-crete burning machine operator, coring machine operator, plaster ten-der, underpinning and shoring of buildings, pump men, manhole and catch basin, dirt and stone tamper, hose men on concrete pumps, haz-ardous waste worker, lead base paint abatement worker, lining of pipe, refusing machine, assisting on direct boring machine, the work of lay-ing watermain, fire hydrants, all mechanical joints to watermain work, sewer worker, and tapping water service and forced lift station mechanical worker.

MATERIAL TESTER I: Hand coring and drilling for testing of materials; field inspection of uncured concrete and asphalt.

MATERIAL TESTER II: Field inspection of welds, structural steel, fireproofing, masonry, soil, facade, reinforcing steel, formwork, cured concrete, and concrete and asphalt batch plants; adjusting proportions of bituminous mixtures.

#### TRUCK DRIVER - BUILDING, HEAVY AND HIGHWAY CONSTRUCTION

Class 1. Two or three Axle Trucks. A-frame Truck when used for transportation purposes; Air Compressors and Welding Machines, including those pulled by cars, pick-up trucks and tractors; Ambulances; Batch Gate Lockers; Batch Hopperman; Car and Truck Washers; Carry-alls; Fork Lifts and Hoisters; Helpers; Mechanics Helpers and Greasers; Oil Distributors 2-man operation; Pavement Breakers; Pole Trailer, up to 40 feet; Power Mower Tractors; Self-propelled Chip Spreader; Skipman; Slurry Trucks, 2-man operation; Slurry Truck Conveyor Operation, 2 or 3 man; TTeamsters Unskilled dumpman; and Truck Drivers hauling warning lights,

barricades, and portable toilets on the job site.

Class 2. Four axle trucks; Dump Crets and Adgetors under 7 yards; Dumpsters, Track Trucks, Euclids, Hug Bottom Dump Turnapulls or Turnatrailers when pulling other than self-loading equipment or similar equipment under 16 cubic yards; Mixer Trucks under 7 yards; Ready-mix Plant Hopper Operator, and Winch Trucks, 2 Axles.

Class 3. Five axle trucks; Dump Crets and Adgetors 7 yards and over; Dumpsters, Track Trucks, Euclids, Hug Bottom Dump Turnatrailers or turnapulls when pulling other than self-loading equipment or similar equipment over 16 cubic yards; Explosives and/or Fission Material Trucks; Mixer Trucks 7 yards or over; Mobile Cranes while in transit; Oil Distributors, 1-man operation; Pole Trailer, over 40 feet; Pole and Expandable Trailers hauling material over 50 feet long; Slurry trucks, 1-man operation; Winch trucks, 3 axles or more; Mechanic--Truck Welder and Truck Painter.

Class 4. Six axle trucks; Dual-purpose vehicles, such as mounted crane trucks with hoist and accessories; Foreman; Master Mechanic; Self-loading equipment like P.B. and trucks with scoops on the front.

#### OPERATING ENGINEERS - BUILDING

Class 1. Assistant Craft Foreman; Craft Foreman; Mechanic; Asphalt Plant; Asphalt Spreader; Autograde; Batch Plant; Benoto (requires Two Engineers); Boiler and Throttle Valve; Caisson Rigs; Central Redi-Mix Plant; Combination Back Hoe Front End-loader Machine; Compressor and Throttle Valve; Concrete Breaker (Truck Mounted); Concrete Conveyor; Concrete Paver; Concrete Placer; Concrete Pump (Truck Mounted); Concrete Tower, Cranes, All, Cranes, Hammerhead, Creter Crane; Crusher, Stone, etc.; Derricks, All; Derricks, Traveling; Formless Curb and Gutter Machine; Grader, Elevating; Grouting Machines; Highlift Shovels or Front Endloader 2-1/4 yd. and over; Hoists, Elevators, outside type rack and pinion and similar machines; Hoists, one, two and three Drum; Hoists, Two tuggers One Floor; Hydraulic Backhoes; Hydraulic Boom Trucks; Locomotives, All; Motor Patrol; Pile Drivers and Skid Rig; Post Hole Digger; Pre-Stress Machine; Pump Cretes; Squeeze Cretes-screw Type Pumps; Gypsum Bulker and Pump; Raised and Blind Hole Drill; Rock Drill; Roto Mill Grinder; Scoops - Tractor Drawn; Slip-form Paver; Straddle Buggies; Tie Back Machine; Tractor with Book and Side Boom; Trenching Machines.

Class 2. Bobcat (over 3/4 cu. yd.); Boilers Brick Forklift; Broom, All Power Propelled; Bulldozers; Concrete Mixer (Two Bag and Over); Conveyor, Portable; Forklift Trucks; Greaser Engineer; Highlift Shovels or Front Endloaders under 2-1/4 yd.; Hoists, Automatic; Hoists, Sewer Dragging Machine; Hoists, Tugger Single Drum; Rollers, All; Steam Generators; Tractors, All; Tractor Drawn Vibratory Roller; Winch Trucks with "A" Frame.

Class 3. Air Compressor; Asphalt Spreader; Combination - Small Equipment Operator; Generators; Heaters, Mechanical; Hoists, Inside Elevators - (Rheostat Manual Controlled); Hydraulic Power Units (Pile Driving and Extracting); Pumps, over 3" (1 to 3 not to exceed a total of 300 ft.); Pumps, Well Points; Welding Machines (2 through 5); Winches, 4 small Electric Drill Winches; Bobcat (up to and including 3/4 cu. yd.).

Class 4. Hoists, Inside Elevators, Push Button with Automatic Doors; Oilers; Brick Forklift.

#### OPERATING ENGINEERS - HEAVY AND HIGHWAY CONSTRUCTION

Class 1. Craft Foreman; Asphalt Plant, Asphalt Heater and Planer Combination; Asphalt Heater Scarfire; Asphalt Silo Tender; Asphalt Spreader; Autograder; ABG Paver; Backhoes with Caisson attachment; Ballast Regulator, Belt Loader; Caisson Rigs; Car Dumper; Central Redi-Mix Plant; Backhoe w/shear attachments; Combination Backhoe Front Endloader Machine, (1 cu. yd. Backhoe Bucket or over or with attachments); Concrete Breaker (Truck Mounted); Concrete Conveyor; Concrete Paver over 27E cu. ft.; Concrete Placer; Concrete Tube Float; Cranes, all attachments; Cranes, Hammerhead, Linden, Peco & Machines of a like nature; Crete Crane; Crusher, Stone, etc.; Derricks, All; Derrick Boats; Derricks, Traveling; Directional Boring Machine over 12"; Dredges; Field Mechanic-Welder; Formless Curb and Gutter Machine; Gradall and Machines of a like nature; Grader, Elevating; Grader, Motor Grader, Motor Patrol, Auto Patrol, Form Grader, Pull Grader, Subgrader; Guard Rail Post Driver Mounted; Hoists, One, Two and Three Drum; Hydraulic Backhoes; Pile Drivers and Skid Rig; Pre-Stress Machine; Pump Cretes Dual Ram; Rock Drill - Crawler or Skid Rig; Rock Drill - Truck Mounted; Rock/Track Tamper; Roto Mill Grinder; Slip-Form Paver; Soil Test Drill Rig (Truck Mounted); Straddle Buggies; GCI Crane; Hydraulic Telescoping form (Tunnel); Tie Back Machine; Tractor Drawn Belt Loader; Tractor with Boom; Tractor-aire with Attachments; Traffic Barrier conveyor machine; Raised or Blind Hole; Trenching Machine; Truck Mounted Concrete Pump with Boom; Truck Mounted Concrete Conveyor; Underground Boring and/or Mining Machines; Wheel Excavator; Widener (APSCO).

Class 2. Batch Plant; Bituminous Mixer; Boiler and Throttle Valve; Bulldozers; Car Loader Trailing Conveyors; Combination Backhoe Front Endloader Machine (less than 1 cu. yd. Backhoe Bucket or over or with attachments); Compressor and Throttle Valve; Compressor, Common Receiver (3); Concrete Breaker or Hydro Hammer; Concrete Grinding Machine; Concrete Mixer or Paver 7S Series to and including 27 cu. ft.; Concrete Spreader; Concrete Curing Machine, Burlap Machine, Belting Machine and Sealing Machine; Conveyor Muck Cars (Haglund or Similar Type); Drills, all; Finishing Machine - Concrete; Greaser Engineer; Highlift Shovels or Front Endloader; Hoist - Sewer Dragging Machine; Hydraulic Boom Trucks (All Attachments); Hydro Blaster; Laser Screed; All Locomotives, Dinky; Pump Cretes; Squeeze Cretes-Screw Type Pumps, Gypsum Bulker and Pump; Roller, Asphalt; Rotary Snow Plows; Rototiller, Seaman, etc., self-propelled; Scoops - Tractor Drawn; Self-Propelled Compactor; Spreader - Chip - Stone, etc.; Scraper; Scraper - Prime Mover in Tandem (Regardless of Size); Tank Car Heater; Tractors, Push, Pulling Sheeps Foot, Disc, Compactor, etc. Tug Boats.

Class 3. Boilers; Brooms, All Power Propelled; Cement Supply Tender; Compressor, Common Receiver (2); Concrete Mixer (Two Bag and Over); Conveyor, Portable; Farm-Type Tractors Used for Mowing, Seeding, etc.; Fireman on Boilers; Forklift Trucks; Grouting Machine; Hoists, Automatic; Hoists, All Elevators; Hoists, Tugger Single Drum; Jeep Diggers, Low Boys; Pipe Jacking Machines; Post-Hole Digger; Power Saw, Concrete Power Driven; Pug Mills; Rollers, other than asphalt; Seed and Straw Blower; Steam Generators; Stump Machine; Winch Trucks with "A" Frame; Work Boats; Tamper - Form-Motor Driven.

Class 4. Air Compressor - Small and Large; Asphalt Spreader, Backend Man; Bobcat (Skid Steer) all; Combination - Small Equipment Operator; Directional Boring Machine up to 12"; Generators - Small 50kw and Under; Generators - Large over 50kw; Heaters, Mechanical; Hydraulic Power Unit (Pile Driving, Extracting, or Drilling); Hydro-Blaster; Light Plants, All (1 through 5); Pumps, over 3" (1 to 3 not to exceed a total of 300 ft.); Pumps, Well Points; Tract-aire; Welding Machines (2 through 5); Winches, 4 Small Electric Drill Winches.

Class 5. Oilers and Directional Boring Machine Locator.  
Other Classifications of Work:

For definitions of classifications not otherwise set out, the Department generally has on file such definitions which are available. If a task to be performed is not subject to one of the classifications of pay set out, the Department will upon being contacted state which neighboring county has such a classification and provide such rate, such rate being deemed to exist by reference in this document. If no neighboring county rate applies to the task, the Department shall undertake a special determination, such special determination being then deemed to have existed under this determination. If a project requires these, or any classification not listed, please contact IDOL at 618/993-7271 for wage rates or clarifications.

#### LANDSCAPING

Landscaping work falls under the existing classifications for laborer, operating engineer and truck driver. The work performed by landscape plantsman and landscape laborer is covered by the existing classification of laborer. The work performed by landscape operators (regardless of equipment used or its size) is covered by the classifications of operating engineer. The work performed by landscape truck drivers (regardless of size of truck driven) is covered by the classifications of truck driver.



# Woodford County Prevailing Wage for April 2007

Trade Name	RG	TYP	C	Base	FRMAN	*M-F>8	OSA	OSH	H/W	Pensn	Vac	Trng
=====	==	==	=	=====	=====	=====	==	==	=====	=====	=====	=====
ASBESTOS ABT-GEN		BLD		25.090	25.840	1.5	1.5	2.0	5.850	5.250	0.000	0.600
ASBESTOS ABT-GEN		HWY		25.870	26.420	1.5	1.5	2.0	5.850	5.250	0.000	0.700
ASBESTOS ABT-MEC		BLD		23.300	24.800	1.5	1.5	2.0	7.860	4.910	0.000	0.000
BOILERMAKER		BLD		30.970	33.970	2.0	2.0	2.0	8.270	7.740	0.000	0.300
BRICK MASON		BLD		27.020	28.520	1.5	1.5	2.0	5.500	6.350	0.000	0.390
CARPENTER		BLD		25.980	27.980	1.5	1.5	2.0	6.500	7.150	0.000	0.320
CARPENTER		HWY		25.910	27.910	1.5	1.5	2.0	6.500	8.100	0.000	0.320
CEMENT MASON	NE	ALL		30.000	31.000	1.5	1.5	2.0	5.500	7.390	0.000	0.100
CEMENT MASON	SE	ALL		24.690	25.440	2.0	2.0	2.0	5.050	8.350	0.000	0.300
CEMENT MASON	W	BLD		23.120	24.870	1.5	1.5	2.0	5.290	10.00	0.000	0.500
CEMENT MASON	W	HWY		24.140	25.140	1.5	1.5	2.0	5.290	10.00	0.000	0.500
CERAMIC TILE FNSHER		BLD		24.910	0.000	1.5	1.5	2.0	5.500	6.350	0.000	0.380
ELECTRIC PWR EQMT OP		ALL		30.750	0.000	1.5	1.5	2.0	4.750	8.610	0.000	0.000
ELECTRIC PWR GRNDMAN		ALL		21.090	0.000	1.5	1.5	2.0	4.750	5.905	0.000	0.000
ELECTRIC PWR LINEMAN		ALL		34.160	36.350	1.5	1.5	2.0	4.750	9.560	0.000	0.000
ELECTRIC PWR TRK DRV		ALL		22.130	0.000	1.5	1.5	2.0	4.750	6.200	0.000	0.000
ELECTRICIAN	NE	BLD		32.010	34.010	1.5	1.5	2.0	5.150	5.410	0.000	0.480
ELECTRICIAN	SE	BLD		31.400	34.540	1.5	1.5	2.0	5.150	6.190	0.000	0.470
ELECTRICIAN	W	BLD		29.860	31.860	1.5	1.5	2.0	5.150	8.060	0.000	0.250
ELECTRONIC SYS TECH		BLD		23.850	25.350	1.5	1.5	2.0	5.150	5.625	0.000	0.250
ELEVATOR CONSTRUCTOR		BLD		34.190	38.460	2.0	2.0	2.0	8.275	6.060	2.050	0.000
GLAZIER		BLD		26.320	27.070	1.5	1.5	2.0	5.650	5.750	0.000	0.350
HT/FROST INSULATOR		BLD		34.750	36.500	1.5	1.5	2.0	8.260	9.110	0.000	0.310
IRON WORKER		BLD		24.960	26.710	1.5	1.5	2.0	8.040	7.410	0.000	0.400
IRON WORKER		HWY		25.920	27.420	1.5	1.5	2.0	8.040	7.410	0.000	0.350
LABORER		BLD		24.090	24.840	1.5	1.5	2.0	5.850	5.250	0.000	0.600
LABORER		HWY		24.870	25.420	1.5	1.5	2.0	5.850	5.250	0.000	0.600
LABORER, SKILLED		BLD		24.090	24.840	1.5	1.5	2.0	5.850	5.250	0.000	0.600
LABORER, SKILLED		HWY		24.870	25.420	1.5	1.5	2.0	5.850	5.250	0.000	0.600
LATHER		BLD		25.980	27.980	1.5	1.5	2.0	6.500	7.150	0.000	0.320
MACHINERY MOVER		HWY		25.920	27.420	1.5	1.5	2.0	8.040	7.410	0.000	0.350
MACHINIST		BLD		36.890	38.890	2.0	2.0	2.0	4.380	5.650	2.550	0.000
MARBLE FINISHERS		BLD		24.910	0.000	1.5	1.5	2.0	5.500	6.350	0.000	0.380
MARBLE MASON		BLD		26.520	27.770	1.5	1.5	2.0	5.500	6.350	0.000	0.380
MILLWRIGHT		BLD		26.620	28.620	1.5	1.5	2.0	6.500	6.850	0.000	0.320
MILLWRIGHT		HWY		27.010	29.010	1.5	1.5	2.0	6.500	6.450	0.000	0.320
OPERATING ENGINEER	BLD	1		27.840	30.840	1.5	1.5	2.0	5.900	8.000	0.000	0.900
OPERATING ENGINEER	BLD	2		25.940	30.840	1.5	1.5	2.0	5.900	8.000	0.000	0.900
OPERATING ENGINEER	BLD	3		24.560	30.840	1.5	1.5	2.0	5.900	8.000	0.000	0.900
OPERATING ENGINEER	HWY	1		29.110	32.110	1.5	1.5	2.0	6.250	9.000	0.000	1.000
OPERATING ENGINEER	HWY	2		26.730	32.110	1.5	1.5	2.0	6.250	9.000	0.000	1.000
OPERATING ENGINEER	HWY	3		22.790	32.110	1.5	1.5	2.0	6.250	9.000	0.000	1.000
PAINTER		ALL		26.850	27.850	1.5	1.5	1.5	5.650	5.750	0.000	0.350
PAINTER SIGNS		BLD		28.970	32.520	1.5	1.5	1.5	2.600	2.310	0.000	0.000
PILEDRIVER		BLD		26.480	28.480	1.5	1.5	2.0	6.500	7.150	0.000	0.320
PILEDRIVER		HWY		26.910	28.910	1.5	1.5	2.0	6.500	8.100	0.000	0.320
PIPEFITTER	NW	BLD		31.630	35.110	1.5	1.5	2.0	6.450	7.680	0.000	0.420
PIPEFITTER	SE	BLD		34.100	36.830	1.5	1.5	2.0	6.450	6.400	0.000	1.150
PLASTERER	SE	BLD		25.920	27.920	1.5	1.5	2.0	4.700	9.300	0.000	0.400
PLASTERER	W	BLD		23.400	24.650	1.5	1.5	2.0	5.290	9.800	0.000	0.500
PLUMBER	NW	BLD		28.390	30.950	1.5	1.5	2.0	6.450	8.990	0.000	0.800
PLUMBER	SE	BLD		34.100	36.830	1.5	1.5	2.0	6.450	6.400	0.000	1.150
ROOFER		BLD		24.200	25.200	1.5	1.5	2.0	5.350	6.550	0.000	0.150
SHEETMETAL WORKER		BLD		27.740	29.130	1.5	1.5	2.0	5.670	9.310	0.000	0.310
SIGN HANGER		HWY		25.920	27.420	1.5	1.5	2.0	8.040	7.410	0.000	0.350
SPRINKLER FITTER		BLD		31.240	33.240	1.5	1.5	2.0	6.500	5.350	0.000	0.250
STEEL ERECTOR		HWY		25.920	27.420	1.5	1.5	2.0	8.040	7.410	0.000	0.350
STONE MASON		BLD		27.020	28.520	1.5	1.5	2.0	5.500	6.350	0.000	0.390

TERRAZZO FINISHER	BLD	24.910	0.000	1.5	1.5	2.0	5.500	6.350	0.000	0.380
TERRAZZO MASON	BLD	26.520	27.770	1.5	1.5	2.0	5.500	6.350	0.000	0.380
TILE MASON	BLD	26.520	27.770	1.5	1.5	2.0	5.500	6.350	0.000	0.380
TRUCK DRIVER	O&C 1	20.630	0.000	1.5	1.5	2.0	7.250	3.317	0.000	0.000
TRUCK DRIVER	O&C 2	20.950	0.000	1.5	1.5	2.0	7.250	3.317	0.000	0.000
TRUCK DRIVER	O&C 3	21.110	0.000	1.5	1.5	2.0	7.250	3.317	0.000	0.000
TRUCK DRIVER	O&C 4	21.310	0.000	1.5	1.5	2.0	7.250	3.317	0.000	0.000
TRUCK DRIVER	O&C 5	21.910	0.000	1.5	1.5	2.0	7.250	3.317	0.000	0.000
TRUCK DRIVER	E ALL 1	32.040	32.590	1.5	1.5	2.0	5.830	3.680	0.000	0.000
TRUCK DRIVER	E ALL 2	32.190	32.590	1.5	1.5	2.0	5.830	3.680	0.000	0.000
TRUCK DRIVER	E ALL 3	32.390	32.590	1.5	1.5	2.0	5.830	3.680	0.000	0.000
TRUCK DRIVER	E ALL 4	32.590	32.590	1.5	1.5	2.0	5.830	3.680	0.000	0.000
TRUCK DRIVER	W ALL 1	25.787	0.000	1.5	1.5	2.0	7.250	3.317	0.000	0.000
TRUCK DRIVER	W ALL 2	26.187	0.000	1.5	1.5	2.0	7.250	3.317	0.000	0.000
TRUCK DRIVER	W ALL 3	26.387	0.000	1.5	1.5	2.0	7.250	3.317	0.000	0.000
TRUCK DRIVER	W ALL 4	26.637	0.000	1.5	1.5	2.0	7.250	3.317	0.000	0.000
TRUCK DRIVER	W ALL 5	27.387	0.000	1.5	1.5	2.0	7.250	3.317	0.000	0.000
TUCKPOINTER	BLD	27.020	28.520	1.5	1.5	2.0	5.500	6.350	0.000	0.390

Legend:

M-F>8 (Overtime is required for any hour greater than 8 worked each day, Monday through Friday.)

OSA (Overtime is required for every hour worked on Saturday)

OSH (Overtime is required for every hour worked on Sunday and Holidays)

H/W (Health & Welfare Insurance)

Pensn (Pension)

Vac (Vacation)

Trng (Training)

## Explanations

### WOODFORD COUNTY

CEMENT MASONS AND PLASTERERS (NORTHEAST) - That part of the county including the town of Minonk.

CEMENT MASONS AND PLASTERERS (SOUTHEAST) - Eastern part North to and including Benson and West to, but not including Roanoke.

CEMENT MASONS AND PLASTERERS (WEST) - That part of the county West of Rt. 116 and 116A including the towns of Benson, Roanoke and Congerville.

ELECTRICIANS (NORTHEAST) - Townships of Linn, Clayton, Minonk, Roanoke, Green and Panola.

ELECTRICIANS (SOUTHEAST) - Townships of Palestine, El Paso and Kansas.  
ELECTRICIANS (WEST) - Townships of Partridge, Cazenovia, Spring Bay, Worth, Metamora, Cruger, Olio, and Montgomery.

PLUMBERS & PIPEFITTERS (SOUTHEAST) - That part of the county South of Rt. 116 and East of Rte. 116A including Goodfield.

TRUCK DRIVERS (EAST) - That part of the county East of Route 51 and north of Route 24.

The following list is considered as those days for which holiday rates of wages for work performed apply: New Years Day, Memorial/Decoration Day, Fourth of July, Labor Day, Veterans Day, Thanksgiving Day, Christmas Day. Generally, any of these holidays which fall on a Sunday is celebrated on the following Monday. This then makes work performed on that Monday payable at the appropriate overtime rate for holiday pay. Common practice in a given local may alter certain days of celebration such as the day after Thanksgiving for Veterans Day. If in doubt, please check with IDOL.

Oil and chip resealing (O&C) means the application of road oils and liquid asphalt to coat an existing road surface, followed by application of aggregate chips or gravel to coated surface, and subsequent rolling of material to seal the surface.

#### EXPLANATION OF CLASSES

ASBESTOS - GENERAL - removal of asbestos material/mold and hazardous materials from any place in a building, including mechanical systems where those mechanical systems are to be removed. This includes the removal of asbestos materials/mold and hazardous materials from ductwork or pipes in a building when the building is to be demolished at the time or at some close future date.

ASBESTOS - MECHANICAL - removal of asbestos material from mechanical systems, such as pipes, ducts, and boilers, where the mechanical systems are to remain.

#### CERAMIC TILE FINISHER, MARBLE FINISHER, TERRAZZO FINISHER

Assisting, helping or supporting the tile, marble and terrazzo mechanic by performing their historic and traditional work assignments required to complete the proper installation of the work covered by said crafts. The term "Ceramic" is used for naming the classification only and is in no way a limitation of the product handled. Ceramic takes into consideration most hard tiles.

#### ELECTRONIC SYSTEMS TECHNICIAN

Installation, service and maintenance of low-voltage systems which utilizes the transmission and/or transference of voice, sound, vision, or digital for commercial, education, security and entertainment purposes for the following: TV monitoring and surveillance, background/foreground music, intercom and telephone interconnect, field programming, inventory control systems, microwave transmission, multi-media, multiplex, radio page, school, intercom and sound burglar alarms and low voltage master clock systems.

Excluded from this classification are energy management systems, life safety systems, supervisory controls and data acquisition systems not intrinsic with the above listed systems, fire alarm systems, nurse call systems and raceways exceeding fifteen feet in length.

#### LABORER, SKILLED - BUILDING

The skilled laborer building (BLD) classification shall encompass the following types of work, irrespective of the site of the work: tending of carpenters in unloading, handling, stockpiling and distribution operations, also other building crafts, mixing, handling, and conveying of all materials used by masons, plasterers and other

building construction crafts, whether done by hand or by any process. The drying of plastering when done by salamander heat, and the cleaning and clearing of all debris. All work pertaining to and in preparation of asbestos abatement and removal. The building of scaffolding and staging for masons and plasterers. The excavations for buildings and all other construction, digging, of trenches, piers, foundations and holes, digging, lagging, sheeting, cribbing, bracing and propping of foundations, holes, caissons, cofferdams, and dikes, the setting of all guidelines for machine or hand excavation and subgrading. The mixing, handling, conveying, pouring, vibrating, gunniting and otherwise applying of concrete, whether by hand or other method of concrete for any walls, foundations, floors, or for other construction concrete sealant men. The wrecking, stripping, dismantling, and handling of concrete forms and false work, and the building of centers for fireproofing purposes. Boring machine, gas, electric or air in preparation for shoving pipe, telephone cable, and so forth, under highways, roads, streets and alleys. All hand and power operating cross cut saws when used for clearing. All work in compressed air construction. All work on acetylene burners in salvaging. The blocking and tamping of concrete. The laying of sewer tile and conduit, and pre-cast materials. The assembling and dismantling of all jacks and sectional scaffolding, including elevator construction and running of slip form jacks. The work of drill running and blasting, including wagon drills. The wrecking, stripping, dismantling, cleaning, moving and oiling of forms. The cutting off of concrete piles. The loading, unloading, handling and carrying to place of installation of all rods, (and materials for use in reinforcing) concrete and the hoisting of same and all signaling where hoist is used in this type of construction coming under the jurisdiction of the Laborers' Union. And, all other labor work not awarded to any other craft. Mortar mixers, kettlemen and carrier of hot stuff, tool crib men, watchmen (Laborer), firemen or salamander tenders, flagmen, deck hands, installation and maintenance of temporary gas-fired heating units, gravel box men, dumpmen and spotters, fencing Laborers, cleaning lumber, pit men, material checkers, dispatchers, unloading explosives, asphalt plant laborers, writer of scale tickets, fireproofing laborers, janitors, asbestos abatement and removal laborers, handling of materials treated with oil, creosote, chloride, asphalt, and/or foreign material harmful to skin or clothing, Laborers with de-watering systems, gunnite nozzle men, laborers tending masons with hot material or where foreign materials are used, Laborers handling masterplate or similar materials, laser beam operator, concrete burning machine operator, material selector men working with firebrick or combustible material, dynamite men, track laborers, cement handlers, chloride handlers, the unloading and laborers with steel workers and re-bars, concrete workers (wet), luteman, asphalt raker, curb asphalt machine operator, ready mix scalemen, permanent, portable or temporary plant drilling machine operator, plaster tenders, underpinning and shoring of buildings, fire watch, signaling of all power equipment, to include trucks excavating equipment, etc., tree topper or trimmer when in connection to construction, tunnel helpers in free air, batch dumpers, kettle and tar men, tank cleaners, plastic installers, scaffold workers, motorized buggies or motorized unit used for wet concrete or handling of building materials, sewer workers, rod and chain men, vibrator operators, mortar mixer operator, cement silica, clay, fly ash, lime and plasters, handlers (bulk or bag), cofferdam workers, on concrete paving, placing, cutting and tying of reinforcing, deck hand, dredge hand and shore laborers, bankmen on floating plant, asphalt workers with machine & layers, grade checker, power tools, caisson workers, lead man on sewer work, welders, cutters, burners and torch men, chain saw operators, paving breaker, jackhammer and drill operator, layout man and/or drainage tile layer, steel form setters --

street and highway, air tamping hammerman, signal man on crane, concrete saw operator, screen man on asphalt pavers, front end man on chip spreader, multiple concrete duct -- lead man.

#### LABORER, SKILLED - HIGHWAY

The skilled laborer heavy and highway (HWY) classification shall encompass the following types of work, irrespective of the site of the work: handling of materials treated with oil, creosote, asphalt and/or any foreign materials harmful to skin or clothing, track laborers, chloride handlers, the unloading and loading with steel workers and re-bars, concrete workers (wet), tunnel helpers in free air, batch dumpers, mason tenders, kettle and tar men, plastic installers, scaffold workers, motorized buggies or motorized unit used for wet concrete or handling of building materials, laborers with de-watering systems, sewer workers plus depth, rod and chainmen, vibrator operators, mortar mixer operators, cement silica, clay, fly ash, lime and plasters, handlers (bulk or bag), cofferdam workers plus depth, on concrete paving, placing, cutting and tying or reinforcing, deck hand, dredge hand shore laborers, bankmen on floating plant, asphalt workers with machine, and layers, grade checker, power tools, stripping of all concrete forms excluding paving forms, dumpmen and spotters, when necessary, caisson workers plus depth, gunnite nozzle men, welders, cutters, burners and torchmen, chain saw operators, paving breaker, jackhammer and drill operators, layout man and/or drainage tile layer, steel form setters - street and highway, air tamping hammerman, signal man on crane, concrete saw operator, screedman on asphalt pavers, front end man on chip spreader, multiple concrete duct, luteman, asphalt raker, curb asphalt machine operator, ready mix scalemen (portable or temporary plant), laser beam operator, concrete burning machine operator, and coring machine operator.

#### TRUCK DRIVER - BUILDING, HEAVY AND HIGHWAY CONSTRUCTION - WEST

Class 1. Drivers on 2 axle trucks hauling less than 9 ton. Air compressor and welding machines and brooms, including those pulled by separate units, truck driver helpers, warehouse employees, mechanic helpers, greasers and tiremen, pickup trucks when hauling materials, tools, or workers to and from and on-the-job site, and fork lifts up to 6,000 lb. capacity.

Class 2. Two or three axle trucks hauling more than 9 ton but hauling less than 16 ton. A-frame winch trucks, hydrolift trucks, vector trucks or similar equipment when used for transportation purposes. Fork lifts over 6,000 lb. capacity, winch trucks, four axle combination units, and ticket writers.

Class 3. Two, three or four axle trucks hauling 16 ton or more. Drivers on water pulls, articulated dump trucks, mechanics and working forepersons, and dispatchers. Five axle or more combination units.

Class 4. Low Boy and Oil Distributors.

Class 5. Drivers who require special protective clothing while employed on hazardous waste work.

#### TRUCK DRIVER - BUILDING, HEAVY AND HIGHWAY CONSTRUCTION - EAST

Class 1. Two or three Axle Trucks. A-frame Truck when used for transportation purposes; Air Compressors and Welding Machines, including those pulled by cars, pick-up trucks and tractors; Ambulances; Batch Gate Lockers; Batch Hopperman; Car and Truck Washers; Carry-alls; Fork Lifts and Hoisters; Helpers; Mechanics

Helpers and Greasers; Oil Distributors 2-man operation; Pavement Breakers; Pole Trailer, up to 40 feet; Power Mower Tractors; Self-propelled Chip Spreader; Skipman; Slurry Trucks, 2-man operation; Slurry Truck Conveyor Operation, 2 or 3 man; Teamsters Unskilled dumpman; and Truck Drivers hauling warning lights, barricades, and portable toilets on the job site.

Class 2. Four axle trucks; Dump Crets and Adgetors under 7 yards; Dumpsters, Track Trucks, Euclids, Hug Bottom Dump Turnapulls or Turnatrailers when pulling other than self-loading equipment or similar equipment under 16 cubic yards; Mixer Trucks under 7 yards; Ready-mix Plant Hopper Operator, and Winch Trucks, 2 Axles.

Class 3. Five axle trucks; Dump Crets and Adgetors 7 yards and over; Dumpsters, Track Trucks, Euclids, Hug Bottom Dump Turnatrailers or turnapulls when pulling other than self-loading equipment or similar equipment over 16 cubic yards; Explosives and/or Fission Material Trucks; Mixer Trucks 7 yards or over; Mobile Cranes while in transit; Oil Distributors, 1-man operation; Pole Trailer, over 40 feet; Pole and Expandable Trailers hauling material over 50 feet long; Slurry trucks, 1-man operation; Winch trucks, 3 axles or more; Mechanic--Truck Welder and Truck Painter.

Class 4. Six axle trucks; Dual-purpose vehicles, such as mounted crane trucks with hoist and accessories; Foreman; Master Mechanic; Self-loading equipment like P.B. and trucks with scoops on the front.

#### TRUCK DRIVER - OIL AND CHIP RESEALING ONLY.

This shall encompass laborers, workers and mechanics who drive contractor or subcontractor owned, leased, or hired pickup, dump, service, or oil distributor trucks. The work includes transporting materials and equipment (including but not limited to, oils, aggregate supplies, parts, machinery and tools) to or from the job site; distributing oil or liquid asphalt and aggregate; stock piling material when in connection with the actual oil and chip contract. The Truck Driver (Oil & Chip Resealing) wage classification does not include supplier delivered materials.

#### OPERATING ENGINEERS - BUILDING

Class 1. Cranes; Overhead Cranes; Gradall; All Cherry Pickers; Mechanics; Central Concrete Mixing Plant Operator; Road Pavers (27E - Dual Drum - Tri Batchers); Blacktop Plant Operators and Plant Engineers; 3 Drum Hoist; Derricks; Hydro Cranes; Shovels; Skimmer Scoops; Koehring Scooper; Drag Lines; Backhoe; Derrick Boats; Pile Drivers and Skid Rigs; Clamshells; Locomotive Cranes; Dredge (all types) Motor Patrol; Power Blades - Dumore - Elevating and similar types; Tower Cranes (Crawler-Mobile) and Stationary; Crane-type Backfiller; Drott Yumbo and similar types considered as Cranes; Caisson Rigs; Dozer; Tournadozer; Work Boats; Ross Carrier; Helicopter; Tournapulls - all and similar types; Scoops (all sizes); Pushcats; Endloaders (all types); Asphalt Surfacing Machine; Slip Form Paver; Rock Crusher; Heavy Equipment Greaser; CMI, CMI Belt Placer, Auto Grade & 3 Track and similar types; Side Booms; Multiple Unit Earth Movers; Creter Crane; Trench Machine; Pump-crete-Belt Crete-Squeeze Cretes-Screw-type Pumps and Gypsum; Bulker & Pump - Operator will clean; Formless Finishing Machine; Flaherty Spreader or similar types; Screed Man on Laydown Machine; Wheel Tractors (industrial or Farm-type w/Dozer-Hoe-Endloader or other attachments); F.W.D. & Similar Types; Vermeer Concrete Saw.

Class 2. Dinkeys; Power Launches; PH One-pass Soil Cement Machine (and similar types); Pugmill with Pump; Backfillers; Euclid Loader; Forklifts; Jeeps w/Ditching Machine or other attachments; Tunneluger; Automatic Cement and Gravel Batching Plants; Mobile Drills (Soil Testing) and similar types; Gurries and Similar Types; (1) and (2) Drum Hoists (Buck Hoist and Similar Types); Chicago Boom; Boring Machine & Pipe Jacking Machine; Hydro Boom; Dewatering System; Straw Blower; Hydro Seeder; Assistant Heavy Equipment Greaser on Spread; Tractors (Track type) without Power Unit pulling Rollers; Rollers on Asphalt -- Brick Macadem; Concrete Breakers; Concrete Spreaders; Mule Pulling Rollers; Center Stripper; Cement Finishing Machines & CMI Texture & Reel Curing Machines; Cement Finishing Machine; Barber Green or similar loaders; Vibro Tamper (All similar types) Self-propelled; Winch or Boom Truck; Mechanical Bull Floats; Mixers over 3 Bag to 27E; Tractor pulling Power Blade or Elevating Grader; Porter Rex Rail; Clary Screed; Truck Type Hoptoe Oilers; Fireman; Spray Machine on Paving; Curb Machines; Truck Crane Oilers; Oil Distributor; Truck-Mounted Saws.

Class 3. Air Compressor; Power Subgrader; Straight Tractor; Trac Air without attachments; Herman Nelson Heater, Dravo, Warner, Silent Glo, and similar types; Roller: Five (5) Ton and under on Earth or Gravel; Form Grader; Crawler Crane & Skid Rig Oilers; Freight Elevators - permanently installed; Pump; Light Plant; Generator; Conveyor (1) or (2) - Operator will clean; Welding Machine; Mixer (3) Bag and Under (Standard Capacity with skip); Bulk Cement Plant; Oiler on Central Concrete Mixing Plant.

#### OPERATING ENGINEERS - HEAVY AND HIGHWAY CONSTRUCTION

Class 1. Cranes; Hydro Crane; Shovels; Crane Type Backfiller; Tower Cranes - Mobile & Crawler & Stationary; Derricks & Hoists (3 Drum); Draglines; Drott Yumbo & similar types considered as Cranes; Back Hoe; Derrick Boats; Pile Driver and Skid Rigs; Clam Shell; Locomotive - Cranes; Road Pavers - Single Drum - Dual Drum - Tri Batcher; Motor Patrols & Power Blades - Dumore - Elevating & Similar Types; Mechanics; Central Concrete Mixing Plant Operator; Asphalt Batch Plant Operators and Plant Engineers; Gradall; Caisson Rigs; Skimmer Scoop - Koering Scooper; Dredges (all types); Hoptoe; All Cherry Pickers; Work Boat; Ross Carrier; Helicopter; Dozer; Tournadozer; Tournapulls - all and similar types; Multiple Unit Earth Movers; Scoops (all sizes); Pushcats; Endloaders (all types); Asphalt Surfacing Machine; Slip Form Paver; Rock Crusher; Heavy Equipment Greaser (top greaser on spread); CMI, Auto Grade, CMI Belt Placer & 3 Track and similar types; Side Booms; Starting Engineer on Pipeline; Asphalt Heater & Planer Combination (used to plane streets); Wheel Tractors (with dozer, hoe or endloader attachments); F.W.D. and Similar types; Blaw Knox Spreader and Similar types; Trench Machines; Pump Crete - Belt Crete - Squeeze Crete - screw type pumps and gypsum (operator will clean); Formless Finishing Machines; Flaherty Spreader or similar types; Screed Man on Laydown Machine; Vermeer Concrete Saw.

Class 2. Bulker & Pump; Power Launches; Boring Machine & Pipe Jacking Machine; Dinkeys; P-H One Pass Soil Cement Machines and similar types; Wheel Tractors (Industry or farm type - other); Back Fillers; Euclid Loader; Fork Lifts; Jeep w/Ditching Machine or other attachments; Tunneluger; Automatic Cement & Gravel Batching Plants; Mobile Drills - Soil Testing and similar types; Pugmill with pump; All (1) and (2) Drum Hoists; Dewatering System; Straw Blower; Hydro-Seeder; Boring Machine; Hydro-Boom; Bump Grinders (self-propelled); Assistant Heavy Equipment Greaser; Apsco Spreader; Tractors (track-type) without Power Units Pulling Rollers on Asphalt - Brick or Macadam; Concrete Breakers; Concrete Spreaders; Cement

Strippers; Cement Finishing Machines & CMI Texture & Reel Curing Machines; Vibro-Tampers (all similar types self-propelled); Mechanical Bull Floats; Self-propelled Concrete Saws; Mixers-over three (3) bags to 27E; Winch and Boom Trucks; Tractor Pulling Power Blade or Elevating Grader; Porter Rex Rail; Clary Screed; Mule Pulling Rollers; Pugmill without Pump; Barber Greene or similar Loaders; Track Type Tractor w/Power Unit attached (minimum); Fireman; Spray Machine on Paving; Curb Machines; Paved Ditch Machine; Power Broom; Self-Propelled Conveyors; Power Subgrader; Oil Distributor; Straight Tractor; Truck Crane Oiler; Truck Type Oilers; Directional boring machine; Horizontal directional drill.

Class 3. Straight framed articulating end dump vehicles and Truck mounted vac unit (separately powered); Trac Air Machine (without attachments); Herman Nelson Heater, Dravo Warner, Silent Glo & similar types; Rollers - five ton and under on earth and gravel; Form Graders; Pumps; Light Plant; Generator; Air Compressor (1) or (2); Conveyor; Welding Machine; Mixer - 3 bags and under; Bulk Cement Plant; Oilers.

Other Classifications of Work:

For definitions of classifications not otherwise set out, the Department generally has on file such definitions which are available. If a task to be performed is not subject to one of the classifications of pay set out, the Department will upon being contacted state which neighboring county has such a classification and provide such rate, such rate being deemed to exist by reference in this document. If no neighboring county rate applies to the task, the Department shall undertake a special determination, such special determination being then deemed to have existed under this determination. If a project requires these, or any classification not listed, please contact IDOL at 618/993-7271 for wage rates or clarifications.

#### LANDSCAPING

Landscaping work falls under the existing classifications for laborer, operating engineer and truck driver. The work performed by landscape plantsman and landscape laborer is covered by the existing classification of laborer. The work performed by landscape operators (regardless of equipment used or its size) is covered by the classifications of operating engineer. The work performed by landscape truck drivers (regardless of size of truck driven) is covered by the classifications of truck driver.