

F.A. RYE	SECTION	COUNTY	TOTAL SHEETS	SHEET NO.
M5 6500	05-00012-00-FP	HENRY	75	56
STA.	TO STA.			
FED. ROAD DIST. NO.	ILLINOIS	FED. AID PROJECT		

ENTRANCE APPROACHES - URBAN AREA

TYPICAL APPLICATION OF ENTRANCES

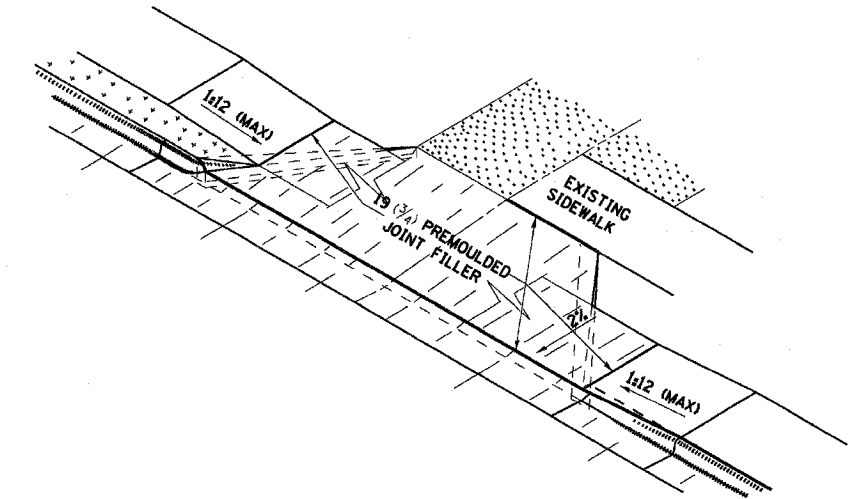
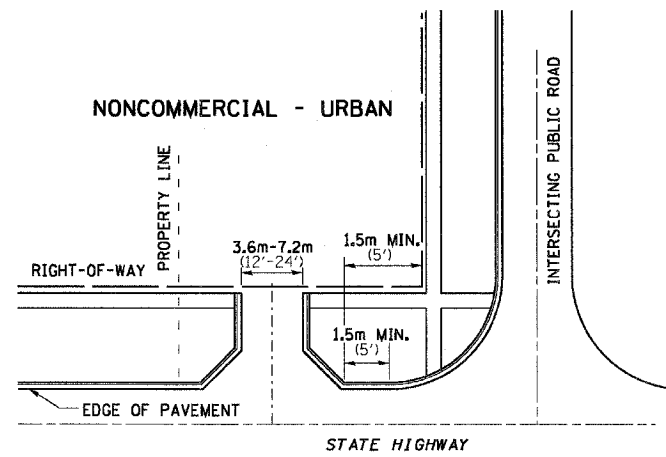
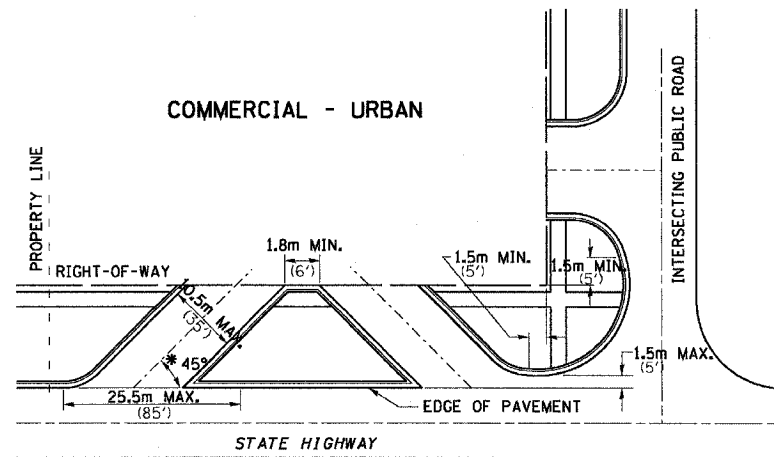

WHEN THE ISLAND BETWEEN DRIVES IS LESS THAN 7.5m (25') LONG OR LESS THAN 10 FEET WIDE, IT SHALL BE DEFINED BY CURBS, MASONRY, OR OTHER DEVICES.
 * 45° MIN. ANGLE PERMITTED ONLY FOR ONE-WAY DRIVEWAYS.
 60° MIN. ANGLE FOR TWO-WAY DRIVEWAYS.

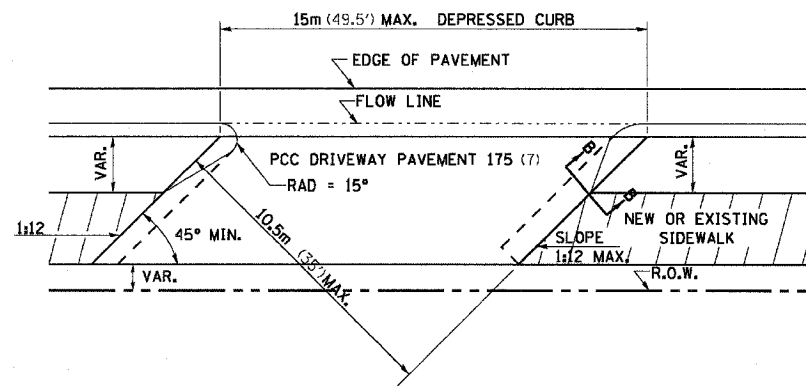

COMMERCIAL ENTRANCE

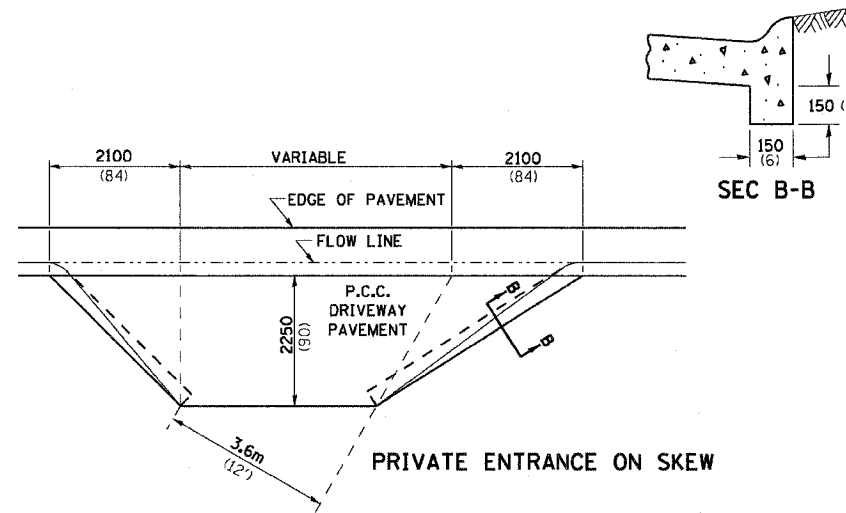

PRIVATE ENTRANCE ON SKEW

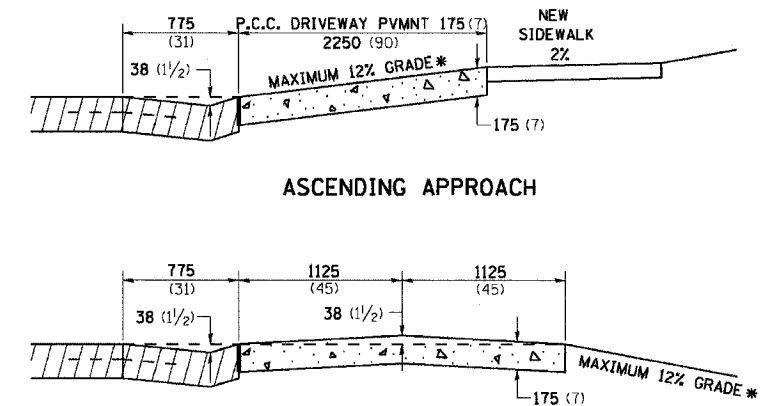

ASCENDING APPROACH

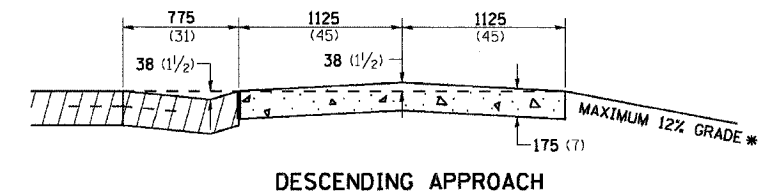

DESCENDING APPROACH

* IN CASES WHERE GRADE EXCEEDS 12%, THE RESIDENT ENGINEER SHALL CHECK WITH DISTRICT DESIGN OFFICE TO DETERMINE NEW APPROACH GRADE. PARTICULAR ATTENTION SHALL BE PAID TO THE NEGATIVE GRADE TO PREVENT DRAINAGE FROM OVER FLOWING INTO THE PRIVATE ENTRANCE.

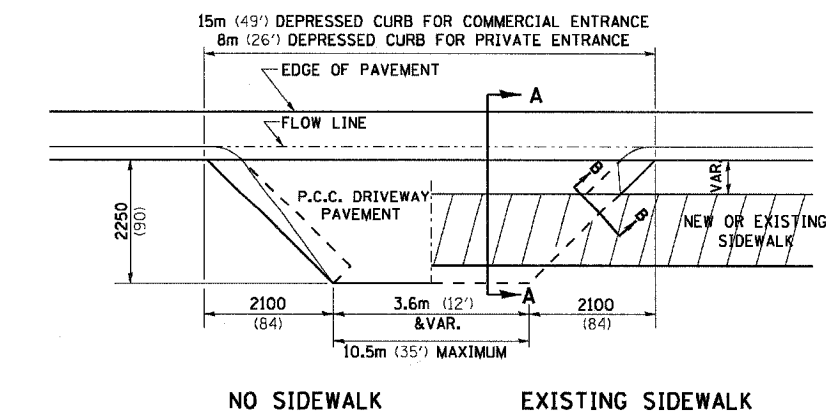

NO SIDEWALK

EXISTING SIDEWALK

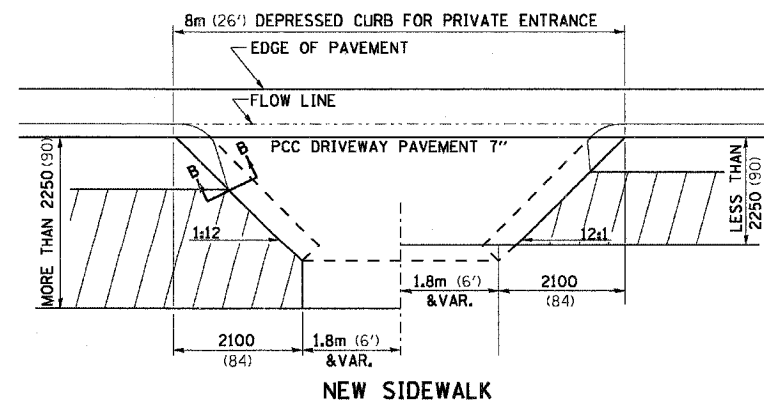

NEW SIDEWALK

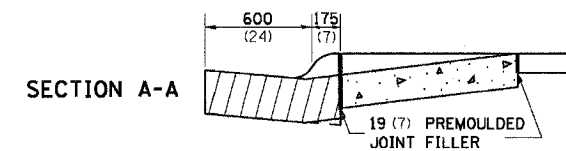

SECTION A-A

THE VARIABLE HEIGHT INTEGRAL CURB AND PREMOULDED JOINT FILLER WILL NOT BE PAID FOR SEPARATELY, BUT SHALL BE INCLUDED IN THE CONTRACT UNIT PRICE OF DRIVEWAY PAVEMENT OF THE THICKNESS SPECIFIED.

ALL DIMENSIONS ARE IN MILLIMETERS (INCHES) UNLESS OTHERWISE NOTED.

PLOT DATE = Nov. 23, 1981/05 2086
 FILE NAME = C:\p\projects\urban\urban\urban.dwg
 PLOT SCALE = 1:8000
 REFERENCE = #REF#