

RETURN WITH BIDLETTING DATE April 28, 2006ITEM NUMBER 2A

Proposal Submitted By

Name _____

Address _____

City/State _____

Zip Code _____ Telephone Number _____

FEIN Number _____ FAX Number _____

BIDDERS NEED NOT RETURN THE ENTIRE PROPOSAL
 (See instructions inside front cover)
NOTICE TO PROSPECTIVE BIDDERS

This proposal can be used for bidding purposes
 by only those companies that request and receive written
AUTHORIZATION TO BID from IDOT's Central Bureau of
 Construction.
 (SEE INSTRUCTIONS ON THE INSIDE OF COVER)

PROPOSAL COVER SHEET
Illinois Department of Transportation
DIVISION OF AERONAUTICS
AIRPORT GreenvilleMUNICIPAL DESIGNATION GreenvilleCOUNTY DESIGNATION BondILLINOIS PROJECT NO. GRE-3215FEDERAL PROJECT NO. 3-17-0049-B4

PLEASE MARK THE APPROPRIATE BOX BELOW:

- A Bid Bond is included.
- A Cashier's Check or a Certified Check is included.

INSTRUCTIONS

ABOUT IDOT PROPOSALS: All proposals issued by IDOT are potential bidding proposals. Each proposal contains all Certifications and Affidavits, a Proposal Signature Sheet and a Proposal Bid Bond required for Prime Contractors to submit a bid after written **Authorization to Bid** has been issued by IDOT’s Central Bureau of Construction.

HOW MANY PROPOSALS SHOULD PROSPECTIVE BIDDERS REQUEST?: Prospective bidders should, prior to submitting their initial request for plans and proposals, determine their needs and request the total number of plans and proposals needed for each item requested. There will be a nonrefundable charge of \$15 for each set of plans and specifications issued.

WHO CAN BID?: Bids will be accepted from only those companies that request and receive written **Authorization to Bid** from IDOT’s Central Bureau of Construction.

WHAT CONSTITUTES WRITTEN AUTHORIZATION TO BID?: When a prospective prime bidder submits a “Request for Proposal Forms and Plans” he/she must indicate at that time which items are being requested For Bidding purposes. Only those items requested For Bidding will be analyzed. After the request has been analyzed, the bidder will be issued a **Proposal Denial and/or Authorization Form**, approved by the Central Bureau of Construction, that indicates which items have been approved For Bidding. If **Authorization to Bid** cannot be approved, the **Proposal Denial and/or Authorization Form** will indicate the reason for denial. If a contractor has requested to bid but has not received a **Proposal Denial and/or Authorization Form**, they should contact the Central Bureau of Construction in advance of the letting date.

WHAT MUST BE INCLUDED WHEN BIDS ARE SUBMITTED?: Bidders need not return the entire proposal when bids are submitted. That portion of the proposal that must be returned includes the following:

1. All documents from the Proposal Cover Sheet through the Proposal Bid Bond
2. Other special documentation and/or information that may be required by the contract special provisions

All proposal documents, including Proposal Guaranty Checks or Proposal Bid Bonds, should be stapled together to prevent loss when bids are processed by IDOT personnel.

ABOUT SUBMITTING BIDS: It is recommended that bidders deliver bids in person to insure they arrive at the proper location prior to the time specified for the receipt of bids. Any bid received at the place of letting after the time specified will not be accepted.

WHO SHOULD BE CALLED IF ASSISTANCE IS NEEDED?

Questions Regarding	Call
Prequalification and/or Authorization to Bid	217/782-3413
Preparation and submittal of bids	217/782-7806
Mailing of plans and proposals	217/782-7806



1. Proposal of _____

Taxpayer Identification Number (Mandatory) _____

for the improvement officially known as:

(a) Greenville Airport

(b) The proposed improvement shown in detail on the plans issued by the Department schedule and detail sheets included herein, includes, in general, the following described work:

Rehabilitation and reconstruction of the general aviation apron and Taxiway A1.

TO THE DEPARTMENT OF TRANSPORTATION

2. The plans for the proposed work are those issued by the Department of Transportation to cover the work described above.

The specifications are those prepared by the Department of Transportation, Division of Aeronautics and designated as "Standard Specifications for Construction of Airports," adopted January, 1985, the "Supplemental Specifications and Recurring Special Provisions," adopted July 1, 2004 and the "Special Provisions" thereto, adopted and in effect on the date of invitation for bids.

3. **COMPLETION TIME/LIQUIDATED DAMAGES.** It being understood and agreed that the completion within the time limit is an essential part of the contract, the bidder agrees to complete the work within 94 calendar days, unless additional time is granted by the Engineer in accordance with the provisions of the specifications. In case of failure to complete the work on or before the time named herein, or within such extra time as may have been allowed by extensions, the bidder agrees that the Department of Transportation shall withhold from such sum as may be due him/her under the terms of this contract, the costs, as set forth below, which costs shall be considered and treated not as a penalty but as damages due to the State from the bidder by reason of the failure of the bidder to complete the work within the time specified in the contract. The following Schedule of Deductions supersedes the table given in Section 60-09 of the Division's Standard Specifications for Construction of Airports.

Schedule of Deductions for Each Day of Overrun in Contract Time

<u>Original Contract Amount</u>		<u>Daily Charge</u>
<u>From More Than</u>	<u>To and Including</u>	<u>Calendar Day</u>
\$ 0	\$ 25,000	\$ 300
25,000	100,000	375
100,000	500,000	550
500,000	1,000,000	725
1,000,000	2,000,000	900
2,000,000	3,000,000	1,100
3,000,000	5,000,000	1,300
5,000,000	7,500,000	1,450
7,500,000	10,000,000	1,650

A daily charge shall be made for every day shown on the calendar beyond the specified contract time in calendar days.

RETURN WITH BID

4. **ASSURANCE OF EXAMINATION AND INSPECTION/WAIVER.** The undersigned further declares that he/she has carefully examined the proposal, plans, specifications, supplemental and applicable recurring special provisions, form of contract and contract bonds, and special provisions, and that he/she has inspected in detail the site of the proposed work, and that he/she has familiarized themselves with all of the local conditions affecting the contract and the detailed requirements of construction, and understands that in making this proposal he/she waives all right to plead any misunderstanding regarding the same.

5. **EXECUTION OF CONTRACT AND CONTRACT BONDS.** The undersigned further agrees to execute a contract for this work and present the same to the department within fifteen (15) days after the contract has been mailed to him/her. The undersigned further agrees that he/she and his/her surety will execute and present within fifteen (15) days after the contract has been mailed to him/her contract bonds satisfactory to and in the form prescribed by the Department of Transportation, in the penal sum of the full amount of the contract, guaranteeing the faithful performance of the work in accordance with the terms of the contract and guaranteeing payment in full all bills and accounts for materials and labor used in the construction of the work.

6. **PROPOSAL GUARANTY.** Accompanying this proposal is either a bid bond on the department form, executed by a corporate surety company satisfactory to the department, or a proposal guaranty check consisting of a bank cashier's check or a properly certified check for not less than 5 per cent of the amount bid or for the amount specified in the following schedule:

<u>Amount of Bid</u>	<u>Proposal Guaranty</u>	<u>Amount of Bid</u>	<u>Proposal Guaranty</u>
Up to \$5,000	to \$5,000\$150	\$2,000,000	to \$3,000,000 \$100,000
\$5,000	to \$10,000\$300	\$3,000,000	to \$5,000,000 \$150,000
\$10,000	to \$50,000\$1,000	\$5,000,000	to \$7,500,000 \$250,000
\$50,000	to \$100,000\$3,000	\$7,500,000	to \$10,000,000 \$400,000
\$100,000	to \$150,000\$5,000	\$10,000,000	to \$15,000,000 \$500,000
\$150,000	to \$250,000\$7,500	\$15,000,000	to \$20,000,000 \$600,000
\$250,000	to \$500,000\$12,500	\$20,000,000	to \$25,000,000\$700,000
\$500,000	to \$1,000,000\$25,000	\$25,000,000	to \$30,000,000 \$800,000
\$1,000,000	to \$1,500,000\$50,000	\$30,000,000	to \$35,000,000 \$900,000
\$1,500,000	to \$2,000,000\$75,000	over	\$35,000,000 \$1,000,000

Bank cashier's checks or properly certified checks accompanying proposals shall be made payable to the Treasurer, State of Illinois, when the state is awarding authority; the county treasurer, when a county is the awarding authority; or the city, village, or town treasurer, when a city, village, or town is the awarding authority.

If a combination bid is submitted, the proposal guaranties which accompany the individual proposals making up the combination will be considered as also covering the combination bid.

The amount of the proposal guaranty check is _____ \$(). If this proposal is accepted and the undersigned shall fail to execute contract bonds as required herein, it is hereby agreed that the amount of the proposal guaranty shall become the property of the State of Illinois, and shall be considered as payment of damages due to delay and other causes suffered by the State because of the failure to execute said contract and contract bonds; otherwise, the bid bond shall become void or the proposal guaranty check shall be returned to the undersigned.

RETURN WITH BID

(e) The plans and Special Provisions for each separate contract shall be construed separately for all requirements, except as described in paragraphs (a) through (d) listed above.

When a combination bid is submitted, the schedule below must be completed in each proposal comprising the combination.

If alternate bids are submitted for one or more of the sections comprising the combination, a combination bid must be submitted for each alternate.

Schedule of Combination Bids

Combination No.	Sections Included in Combination	Combination Bid	
		Dollars	Cents

8. **SCHEDULE OF PRICES.** The undersigned submits herewith his/her schedule of prices covering the work to be performed under this contract; he/she understands that he/she must show in the schedule the unit prices (with no more than two decimal places, i.e. \$25.35, not \$25.348) for which he/she proposes to perform each item of work, that the extensions must be made by him/her, and that if not so done his/her proposal may be rejected as irregular.

The undersigned further agrees that the unit prices submitted herewith are for the purpose of obtaining a gross sum, and for use in computing the value of additions and deductions; that if there is a discrepancy between the gross sum bid and that resulting from the summation of the quantities multiplied by their respective unit prices, the latter shall govern.

STATE JOB #- - - -

ILLINOIS DEPARTMENT OF TRANSPORTATION
 SCHEDULE OF PRICES
 CONTRACT NUMBER - GR002

ECMS002 DTGECM03 ECMR003 PAGE 1
 RUN DATE - 03/31/06
 RUN TIME - 183427

COUNTY NAME	CODE	DIST	AIRPORT NAME	FED PROJECT	ILL PROJECT
BOND	005	08	GREENVILLE	3-17-0049-B4	GR-E - 3215

ITEM NUMBER	PAY ITEM DESCRIPTION	UNIT OF MEASURE	QUANTITY	UNIT PRICE		TOTAL PRICE	
				DOLLARS	CENTS	DOLLARS	CTS
AR150530	TRAFFIC MAINTENANCE	L.S.	1.000 X		=		
AR152480	SHOULDER ADJUSTMENT	S.Y.	1,310.000 X		=		
AR152540	SOIL STABILIZATION FABRIC	S.Y.	3,050.000 X		=		
AR156520	INLET PROTECTION	EACH	5.000 X		=		
AR201613	BIT. BASE CSE.-METHOD 1, SUPERPAV	TON	373.000 X		=		
AR201621	BIT. BASE CSE., LEVELING, SUPERPA	TON	740.000 X		=		
AR201663	SAND MIX CRACK REPAIR	L.F.	12,900.000 X		=		
AR201670	CRACK CONTROL FABRIC	S.Y.	7,750.000 X		=		
AR209604	CRUSHED AGG. BASE COURSE - 4"	S.Y.	2,903.000 X		=		
AR209951	PAVEMENT REMOVAL & RECONSTRUCTION	S.Y.	3,382.400 X		=		
AR401613	BIT. SURF. CSE.-METHOD I, SUPERPA	TON	792.000 X		=		
AR401650	BITUMINOUS PAVEMENT MILLING	S.Y.	7,044.000 X		=		
AR401655	BUTT JOINT CONSTRUCTION	S.Y.	547.200 X		=		
AR501530	PCC TEST BATCH	EACH	1.000 X		=		
AR501555	5 1/2" PCC PAVEMENT	S.Y.	1,498.400 X		=		

GREENVILLE
BOND

ILLINOIS DEPARTMENT OF TRANSPORTATION
SCHEDULE OF PRICES
CONTRACT NUMBER - GR002

ECMS002 DTGECM03 ECMR003 PAGE 2
RUN DATE - 03/31/06
RUN TIME - 183427

ITEM NUMBER	PAY ITEM DESCRIPTION	UNIT OF MEASURE	QUANTITY	UNIT PRICE		TOTAL PRICE	
				DOLLARS	CENTS	DOLLARS	CTS
AR602510	BITUMINOUS PRIME COAT	GAL.	500.000 X		=		
AR603510	BITUMINOUS TACK COAT	GAL.	45.000 X		=		
AR620520	PAVEMENT MARKING-WATERBORNE	S.F.	1,982.000 X		=		
AR701512	12" RCP, CLASS IV	L.F.	149.400 X		=		
AR701530	30" RCP, CLASS IV	L.F.	428.600 X		=		
AR701900	REMOVE PIPE	L.F.	459.000 X		=		
AR751411	INLET-TYPE A	EACH	1.000 X		=		
AR751415	INLET-SPECIAL	EACH	2.000 X		=		
AR751540	MANHOLE 4'	EACH	1.000 X		=		
AR751550	MANHOLE 5'	EACH	1.000 X		=		
AR751602	CATCH BASIN TYPE B	EACH	1.000 X		=		
AR751943	ADJUST MANHOLE	EACH	1.000 X		=		
AR901510	SEEDING	ACRE	0.300 X		=		
AR908510	MULCHING	ACRE	0.300 X		=		
				TOTAL \$			

NOTE:
*** PLEASE TURN PAGE FOR IMPORTANT NOTES ***

GREENVILLE
BOND

ILLINOIS DEPARTMENT OF TRANSPORTATION
SCHEDULE OF PRICES
CONTRACT NUMBER - GR002

ECMS002 DTGECM03 ECMR003 PAGE 3
RUN DATE - 03/31/06
RUN TIME - 183427

NOTE:

1. EACH PAY ITEM SHOULD HAVE A UNIT PRICE AND A TOTAL PRICE.
2. THE UNIT PRICE SHALL GOVERN IF NO TOTAL PRICE IS SHOWN OR IF THERE IS A DISCREPANCY BETWEEN THE PRODUCT OF THE UNIT PRICE MULTIPLIED BY THE QUANTITY.
3. IF A UNIT PRICE IS OMITTED, THE TOTAL PRICE WILL BE DIVIDED BY THE QUANTITY IN ORDER TO ESTABLISH A UNIT PRICE.
4. A BID MAY BE DECLARED UNACCEPTABLE IF NEITHER A UNIT PRICE NOR A TOTAL PRICE IS SHOWN.

RETURN WITH BID

THE PRECEDING SCHEDULE OF PRICES MUST BE

COMPLETED AND RETURNED.

RETURN WITH BID

**STATE REQUIRED ETHICAL
STANDARDS GOVERNING CONTRACT
PROCUREMENT: ASSURANCES, CERTIFICATIONS
AND DISCLOSURES**

I. GENERAL

A. Article 50 of the Illinois Procurement Code establishes the duty of all State chief procurement officers, State purchasing officers, and their designees to maximize the value of the expenditure of public moneys in procuring goods, services, and contracts for the State of Illinois and to act in a manner that maintains the integrity and public trust of State government. In discharging this duty, they are charged by law to use all available information, reasonable efforts, and reasonable actions to protect, safeguard, and maintain the procurement process of the State of Illinois.

B. In order to comply with the provisions of Article 50 and to carry out the duty established therein, all bidders are to adhere to ethical standards established for the procurement process, and to make such assurances, disclosures and certifications required by law. By execution of the Proposal Signature Sheet, the bidder indicates that each of the mandated assurances has been read and understood, that each certification is made and understood, and that each disclosure requirement has been understood and completed.

C. In addition to all other remedies provided by law, failure to comply with any assurance, failure to make any disclosure or the making of a false certification shall be grounds for termination of the contract and the suspension or debarment of the bidder.

II. ASSURANCES

A. The assurances hereinafter made by the bidder are each a material representation of fact upon which reliance is placed should the Department enter into the contract with the bidder. The Department may terminate the contract if it is later determined that the bidder rendered a false or erroneous assurance, and the surety providing the performance bond shall be responsible for the completion of the contract.

B. Felons

1. The Illinois Procurement Code provides:

Section 50-10. Felons. Unless otherwise provided, no person or business convicted of a felony shall do business with the State of Illinois or any state agency from the date of conviction until 5 years after the date of completion of the sentence for that felony, unless no person held responsible by a prosecutorial office for the facts upon which the conviction was based continues to have any involvement with the business.

2. The bidder assures the Department that the award and execution of the contract would not cause a violation of Section 50-10.

RETURN WITH BID

C. Conflicts of Interest

1. The Illinois Procurement Code provides in pertinent part:

Section 50-13. Conflicts of Interest.

(a) Prohibition. It is unlawful for any person holding an elective office in this State, holding a seat in the General Assembly, or appointed to or employed in any of the offices or agencies of state government and who receives compensation for such employment in excess of 60% of the salary of the Governor of the State of Illinois, or who is an officer or employee of the Capital Development Board or the Illinois Toll Highway Authority, or who is the spouse or minor child of any such person to have or acquire any contract, or any direct pecuniary interest in any contract therein, whether for stationery, printing, paper, or any services, materials, or supplies, that will be wholly or partially satisfied by the payment of funds appropriated by the General Assembly of the State of Illinois or in any contract of the Capital Development Board or the Illinois Toll Highway authority.

(b) Interests. It is unlawful for any firm, partnership, association or corporation, in which any person listed in subsection (a) is entitled to receive (i) more than 7 1/2% of the total distributable income or (ii) an amount in excess of the salary of the Governor, to have or acquire any such contract or direct pecuniary interest therein.

(c) Combined interests. It is unlawful for any firm, partnership, association, or corporation, in which any person listed in subsection (a) together with his or her spouse or minor children is entitled to receive (i) more than 15%, in the aggregate, of the total distributable income or (ii) an amount in excess of 2 times the salary of the Governor, to have or acquire any such contract or direct pecuniary interest therein.

(d) Securities. Nothing in this Section invalidates the provisions of any bond or other security previously offered or to be offered for sale or sold by or for the State of Illinois.

(e) Prior interests. This Section does not affect the validity of any contract made between the State and an officer or employee of the State or member of the General Assembly, his or her spouse, minor child or any combination of those persons if that contract was in existence before his or her election or employment as an officer, member, or employee. The contract is voidable, however, if it cannot be completed within 365 days after the officer, member, or employee takes office or is employed.

The current salary of the Governor is \$145,877.00. Sixty percent of the salary is \$87,526.20.

2. The bidder assures the Department that the award and execution of the contract would not cause a violation of Section 50-13, or that an effective exemption has been issued by the Board of Ethics to any individual subject to the Section 50-13 prohibitions pursuant to the provisions of Section 50-20 of the Code and Executive Order Number 3 (1998). Information concerning the exemption process is available from the Department upon request.

D. Negotiations

1. The Illinois Procurement Code provides in pertinent part:

Section 50-15. Negotiations.

(a) It is unlawful for any person employed in or on a continual contractual relationship with any of the offices or agencies of State government to participate in contract negotiations on behalf of that office or agency with any firm, partnership, association, or corporation with whom that person has a contract for future employment or is negotiating concerning possible future employment.

2. The bidder assures the Department that the award and execution of the contract would not cause a violation of Section 50-15, and that the bidder has no knowledge of any facts relevant to the kinds of acts prohibited therein.

RETURN WITH BID

E. Inducements

1. The Illinois Procurement Code provides:

Section 50-25. Inducement. Any person who offers or pays any money or other valuable thing to any person to induce him or her not to bid for a State contract or as recompense for not having bid on a State contract is guilty of a Class 4 felony. Any person who accepts any money or other valuable thing for not bidding for a State contract or who withholds a bid in consideration of the promise for the payment of money or other valuable thing is guilty of a Class 4 felony.

2. The bidder assures the Department that the award and execution of the contract would not cause a violation of Section 50-25, and that the bidder has no knowledge of any facts relevant to the kinds of acts prohibited therein.

F. Revolving Door Prohibition

1. The Illinois Procurement Code provides:

Section 50-30. Revolving door prohibition. Chief procurement officers, associate procurement officers, State purchasing officers, their designees whose principal duties are directly related to State procurement, and executive officers confirmed by the Senate are expressly prohibited for a period of 2 years after terminating an affected position from engaging in any procurement activity relating to the State agency most recently employing them in an affected position for a period of at least 6 months. The prohibition includes, but is not limited to: lobbying the procurement process; specifying; bidding; proposing bid, proposal, or contract documents; on their own behalf or on behalf of any firm, partnership, association, or corporation. This Section applies only to persons who terminate an affected position on or after January 15, 1999.

2. The bidder assures the Department that the award and execution of the contract would not cause a violation of Section 50-30, and that the bidder has no knowledge of any facts relevant to the kinds of acts prohibited therein.

G. Reporting Anticompetitive Practices

1. The Illinois Procurement Code provides:

Section 50-40. Reporting anticompetitive practices. When, for any reason, any vendor, bidder, contractor, chief procurement officer, State purchasing officer, designee, elected official, or State employee suspects collusion or other anticompetitive practice among any bidders, offers, contractors, proposers, or employees of the State, a notice of the relevant facts shall be transmitted to the Attorney General and the chief procurement officer.

2. The bidder assures the Department that it has not failed to report any relevant facts concerning the practices addressed in Section 50-40 which may involve the contract for which the bid is submitted.

H. Confidentiality

1. The Illinois Procurement Code provides:

Section 50-45. Confidentiality. Any chief procurement officer, State purchasing officer, designee, or executive officer who willfully uses or allows the use of specifications, competitive bid documents, proprietary competitive information, proposals, contracts, or selection information to compromise the fairness or integrity of the procurement, bidding, or contract process shall be subject to immediate dismissal, regardless of the Personnel code, any contract, or any collective bargaining agreement, and may in addition be subject to criminal prosecution.

2. The bidder assures the Department that it has no knowledge of any fact relevant to the practices addressed in Section 50-45 which may involve the contract for which the bid is submitted.

RETURN WITH BID

I. Insider Information

1. The Illinois Procurement Act provides:

Section 50-50. Insider information. It is unlawful for any current or former elected or appointed State official or State employee to knowingly use confidential information available only by virtue of that office or employment for actual or anticipated gain for themselves or another person.

2. The bidder assures the Department that it has no knowledge of any facts relevant to the practices addressed in Section 50-50 which may involve the contract for which the bid is submitted.

III. CERTIFICATIONS

A. The certifications hereinafter made by the bidder are each a material representation of fact upon which reliance is placed should the Department enter into the contract with the bidder. The Department may terminate the contract if it is later determined that the bidder rendered a false or erroneous certification, and the surety providing the performance bond shall be responsible for completion of the contract.

B. Bribery

1. The Illinois Procurement Code provides:

Section 50-5. Bribery.

(a) Prohibition. No person or business shall be awarded a contract or subcontract under this Code who:

(1) has been convicted under the laws of Illinois or any other state of bribery or attempting to bribe an officer or employee of the State of Illinois or any other state in that officer's or employee's official capacity; or

(2) has made an admission of guilt of that conduct that is a matter of record but has not been prosecuted for that conduct.

(b) Businesses. No business shall be barred from contracting with any unit of State or local government as a result of a conviction under this Section of any employee or agent of the business if the employee or agent is no longer employed by the business and:

(1) the business has been finally adjudicated not guilty; or

(2) the business demonstrates to the governmental entity with which it seeks to contract, and that entity finds that the commission of the offense was not authorized, requested, commanded, or performed by a director, officer, or high managerial agent on behalf of the business as provided in paragraph (2) of subsection (a) of Section 5-4 of the Criminal Code of 1961.

(c) Conduct on behalf of business. For purposes of this Section, when an official, agent, or employee of a business committed the bribery or attempted bribery on behalf of the business and in accordance with the direction or authorization of a responsible official of the business, the business shall be chargeable with the conduct.

(d) Certification. Every bid submitted to and contract executed by the State shall contain a certification by the contractor that the contractor is not barred from being awarded a contract or subcontract under this Section. A contractor who makes a false statement, material to the certification, commits a Class 3 felony.

2. The bidder certifies that it is not barred from being awarded a contract under Section 50.5.

RETURN WITH BID

C. Educational Loan

1. Section 3 of the Educational Loan Default Act provides:

§ 3. No State agency shall contract with an individual for goods or services if that individual is in default, as defined in Section 2 of this Act, on an educational loan. Any contract used by any State agency shall include a statement certifying that the individual is not in default on an educational loan as provided in this Section.

2. The bidder, if an individual as opposed to a corporation, partnership or other form of business organization, certifies that the bidder is not in default on an educational loan as provided in Section 3 of the Act.

D. Bid-Rigging/Bid Rotating

1. Section 33E-11 of the Criminal Code of 1961 provides:

§ 33E-11. (a) Every bid submitted to and public contract executed pursuant to such bid by the State or a unit of local government shall contain a certification by the prime contractor that the prime contractor is not barred from contracting with any unit of State or local government as a result of a violation of either Section 33E-3 or 33E-4 of this Article. The State and units of local government shall provide the appropriate forms for such certification.

(b) A contractor who makes a false statement, material to the certification, commits a Class 3 felony.

A violation of Section 33E-3 would be represented by a conviction of the crime of bid-rigging which, in addition to Class 3 felony sentencing, provides that any person convicted of this offense or any similar offense of any state or the United States which contains the same elements as this offense shall be barred for 5 years from the date of conviction from contracting with any unit of State or local government. No corporation shall be barred from contracting with any unit of State or local government as a result of a conviction under this Section of any employee or agent of such corporation if the employee so convicted is no longer employed by the corporation and: (1) it has been finally adjudicated not guilty or (2) if it demonstrates to the governmental entity with which it seeks to contract and that entity finds that the commission of the offense was neither authorized, requested, commanded, nor performed by a director, officer or a high managerial agent in behalf of the corporation.

A violation of Section 33E-4 would be represented by a conviction of the crime of bid-rotating which, in addition to Class 2 felony sentencing, provides that any person convicted of this offense or any similar offense of any state or the United States which contains the same elements as this offense shall be permanently barred from contracting with any unit of State or local government. No corporation shall be barred from contracting with any unit of State or local government as a result of a conviction under this Section of any employee or agent of such corporation if the employee so convicted is no longer employed by the corporation and: (1) it has been finally adjudicated not guilty or (2) if it demonstrates to the governmental entity with which it seeks to contract and that entity finds that the commission of the offense was neither authorized, requested, commanded, nor performed by a director, officer or a high managerial agent in behalf of the corporation.

2. The bidder certifies that it is not barred from contracting with the Department by reason of a violation of either Section 33E-3 or Section 33E-4.

E. International Anti-Boycott

1. Section 5 of the International Anti-Boycott Certification Act provides:

§ 5. State contracts. Every contract entered into by the State of Illinois for the manufacture, furnishing, or purchasing of supplies, material, or equipment or for the furnishing of work, labor, or services, in an amount exceeding the threshold for small purchases according to the purchasing laws of this State or \$10,000.00, whichever is less, shall contain certification, as a material condition of the contract, by which the contractor agrees that neither the contractor nor any substantially-owned affiliated company is participating or shall participate in an international boycott in violation of the provisions of the U.S. Export Administration Act of 1979 or the regulations of the U.S. Department of Commerce promulgated under that Act.

2. The bidder makes the certification set forth in Section 5 of the Act.

RETURN WITH BID

F. Drug Free Workplace

1. The Illinois “Drug Free Workplace Act” applies to this contract and it is necessary to comply with the provisions of the “Act” if the contractor is a corporation, partnership, or other entity (including a sole proprietorship) which has 25 or more employees.

2. The bidder certifies that if awarded a contract in excess of \$5,000 it will provide a drug free workplace by:

(a) Publishing a statement notifying employees that the unlawful manufacture, distribution, dispensation, possession or use of a controlled substance, including cannabis, is prohibited in the contractor’s workplace; specifying the actions that will be taken against employees for violations of such prohibition; and notifying the employee that, as a condition of employment on such contract, the employee shall abide by the terms of the statement, and notify the employer of any criminal drug statute conviction for a violation occurring in the workplace no later than five (5) days after such conviction.

(b) Establishing a drug free awareness program to inform employees about the dangers of drug abuse in the workplace; the contractor’s policy of maintaining a drug free workplace; any available drug counseling, rehabilitation, and employee assistance programs; and the penalties that may be imposed upon employees for drug violations.

(c) Providing a copy of the statement required by subparagraph (1) to each employee engaged in the performance of the contract and to post the statement in a prominent place in the workplace.

(d) Notifying the Department within ten (10) days after receiving notice from an employee or otherwise receiving actual notice of the conviction of an employee for a violation of any criminal drug statute occurring in the workplace.

(e) Imposing or requiring, within 30 days after receiving notice from an employee of a conviction or actual notice of such a conviction, an appropriate personnel action, up to and including termination, or the satisfactory participation in a drug abuse assistance or rehabilitation program approved by a federal, state or local health, law enforcement or other appropriate agency.

(f) Assisting employees in selecting a course of action in the event drug counseling, treatment, and rehabilitation is required and indicating that a trained referral team is in place.

(g) Making a good faith effort to continue to maintain a drug free workplace through implementation of the actions and efforts stated in this certification.

G. Debt Delinquency

1. The Illinois Procurement Code provides:

Section 50-11 and 50-12. Debt Delinquency.

The contractor or bidder certifies that it, or any affiliate, is not barred from being awarded a contract under 30 ILCS 500. Section 50-11 prohibits a person from entering into a contract with a State agency if it knows or should know that it, or any affiliate, is delinquent in the payment of any debt to the State as defined by the Debt Collection Board. Section 50-12 prohibits a person from entering into a contract with a State agency if it, or any affiliate, has failed to collect and remit Illinois Use Tax on all sales of tangible personal property into the State of Illinois in accordance with the provisions of the Illinois Use Tax Act. The contractor further acknowledges that the contracting State agency may declare the contract void if this certification is false or if the contractor, or any affiliate, is determined to be delinquent in the payment of any debt to the State during the term of the contract.

RETURN WITH BID

H. Sarbanes-Oxley Act of 2002

1. The Illinois Procurement Code provides:

Section 50-60(c).

The contractor certifies in accordance with 30 ILCS 500/50-10.5 that no officer, director, partner or other managerial agent of the contracting business has been convicted of a felony under the Sarbanes-Oxley Act of 2002 or a Class 3 or Class 2 felony under the Illinois Securities Law of 1953 for a period of five years prior to the date of the bid or contract. The contractor acknowledges that the contracting agency shall declare the contract void if this certification is false.

I. Section 42 of the Environmental Protection Act

The contractor certifies in accordance with 30 ILCS 500/50-12 that the bidder or contractor is not barred from being awarded a contract under this Section which prohibits the bidding on or entering into contracts with the State of Illinois or a State agency by a person or business found by a court or the Pollution Control Board to have committed a willful or knowing violation of Section 42 of the Environmental Protection Act for a period of five years from the date of the order. The contractor acknowledges that the contracting agency may declare the contract void if this certification is false.

RETURN WITH BID

IV. DISCLOSURES

A. The disclosures hereinafter made by the bidder are each a material representation of fact upon which reliance is placed should the Department enter into the contract with the bidder. The Department may terminate the contract if it is later determined that the bidder rendered a false or erroneous disclosure, and the surety providing the performance bond shall be responsible for completion of the contract.

B. Financial Interests and Conflicts of Interest

1. Section 50-35 of the Illinois Procurement Code provides that all bids of more than \$10,000 shall be accompanied by disclosure of the financial interests of the bidder. This disclosed information for the successful bidder, will be maintained as public information subject to release by request pursuant to the Freedom of Information Act.

The financial interests to be disclosed shall include ownership or distributive income share that is in excess of 5%, or an amount greater than 60% of the annual salary of the Governor, of the bidding entity or its parent entity, whichever is less, unless the contractor or bidder is a publicly traded entity subject to Federal 10K reporting, in which case it may submit its 10K disclosure in place of the prescribed disclosure. The disclosure shall include the names, addresses, and dollar or proportionate share of ownership of each person making the disclosure, their instrument of ownership or beneficial relationship, and notice of any potential conflict of interest resulting from the current ownership or beneficial interest of each person making the disclosure having any of the relationships identified in Section 50-35 and on the disclosure form.

In addition, all disclosures shall indicate any other current or pending contracts, proposals, leases, or other ongoing procurement relationships the bidding entity has with any other unit of state government and shall clearly identify the unit and the contract, proposal, lease, or other relationship.

2. Disclosure Forms. Disclosure Form A is attached for use concerning the individuals meeting the above ownership or distributive share requirements. Subject individuals should be covered each by one form. In addition, a second form (Disclosure Form B) provides for the disclosure of current or pending procurement relationships with other (non-IDOT) state agencies. **The forms must be included with each bid or incorporated by reference.**

C. Disclosure Form Instructions

Form A: For bidders that have previously submitted the information requested in Form A

The Department has retained the Form A disclosures submitted by all bidders responding to these requirements for the April 24, 1998 or any subsequent letting conducted by the Department. The bidder has the option of submitting the information again or the bidder may sign the following certification statement indicating that the information previously submitted by the bidder is, as of the date of signature, current and accurate. The Certification must be signed and dated by a person who is authorized to execute contracts for the bidding company. Before signing this certification, the bidder should carefully review its prior submissions to ensure the Certification is correct. If the Bidder signs the Certification, the Bidder should proceed to Form B instructions.

CERTIFICATION STATEMENT

I have determined that the Form A disclosure information previously submitted is current and accurate, and all forms are hereby incorporated by reference in this bid. Any necessary additional forms or amendments to previously submitted forms are attached to this bid.

(Bidding Company)

Name of Authorized Representative (type or print)

Title of Authorized Representative (type or print)

Signature of Authorized Representative

Date

Form A: For bidders who have NOT previously submitted the information requested in Form A

If the bidder is a publicly traded entity subject to Federal 10K reporting, the 10K Report may be submitted to meet the requirements of Form A. If a bidder is not subject to Federal 10K reporting, the bidder must determine if any individuals are required by law to complete a financial disclosure form. To do this, the bidder should answer each of the following questions. A "YES" answer indicates Form A must be completed. If the answer to each of the following questions is "NO", then the NOT APPLICABLE STATEMENT on the second page of Form A must be signed and dated by a person that is authorized to execute contracts for the bidding company. Note These questions are for assistance only and are not required to be completed.

1. Does anyone in your organization have a direct or beneficial ownership share of greater than 5% of the bidding entity or parent entity? YES _____ NO _____
2. Does anyone in your organization have a direct or beneficial ownership share of less than 5%, but which has a value greater than \$87,526.20? YES _____ NO _____
3. Does anyone in your organization receive more than \$87,526.20 of the bidding entity's or parent entity's distributive income? (Note: Distributive income is, for these purposes, any type of distribution of profits. An annual salary is not distributive income.) YES _____ NO _____
4. Does anyone in your organization receive greater than 5% of the bidding entity's or parent entity's total distributive income, but which is less than \$87,526.20? YES _____ NO _____

(Note: Only one set of forms needs to be completed per person per bid even if a specific individual would require a yes answer to more than one question.)

A "YES" answer to any of these questions requires the completion of Form A. The bidder must determine each individual in the bidding entity or the bidding entity's parent company that would cause the questions to be answered "Yes". Each form must be signed and dated by a person that is authorized to execute contracts for your organization. **Photocopied or stamped signatures are not acceptable.** The person signing can be, but does not have to be, the person for which the form is being completed. The bidder is responsible for the accuracy of any information provided.

If the answer to each of the above questions is "NO", then the NOT APPLICABLE STATEMENT on page 2 of Form A must be signed and dated by a person that is authorized to execute contracts for your company.

Form B: Identifying Other Contracts & Procurement Related Information Disclosure Form B must be completed for each bid submitted by the bidding entity. It must be signed by an individual who is authorized to execute contracts for the bidding entity. *Note: Signing the NOT APPLICABLE STATEMENT on Form A does not allow the bidder to ignore Form B. Form B must be completed, signed and dated or the bidder may be considered nonresponsive and the bid will not be accepted.*

The Bidder shall identify, by checking Yes or No on Form B, whether it has any pending contracts (including leases), bids, proposals, or other ongoing procurement relationship with any other (non-IDOT) State of Illinois agency. If "No" is checked, the bidder only needs to complete the signature box on the bottom of Form B. If "Yes" is checked, the bidder must do one of the following:

Option I: If the bidder did not submit an Affidavit of Availability to obtain authorization to bid, the bidder must list all non-IDOT State of Illinois agency pending contracts, leases, bids, proposals, and other ongoing procurement relationships. These items may be listed on Form B or on an attached sheet(s). Do not include IDOT contracts. Contracts with cities, counties, villages, etc. are not considered State of Illinois agency contracts and are not to be included. Contracts with other State of Illinois agencies such as the Department of Natural Resources or the Capital Development Board must be included. Bidders who submit Affidavits of Availability are suggested to use Option II.

Option II: If the bidder is required and has submitted an Affidavit of Availability in order to obtain authorization to bid, the bidder may write or type "See Affidavit of Availability" which indicates that the Affidavit of Availability is incorporated by reference and includes all non-IDOT State of Illinois agency pending contracts, leases, bids, proposals, and other ongoing procurement relationships. For any contracts that are not covered by the Affidavit of Availability, the bidder must identify them on Form B or on an attached sheet(s). These might be such things as leases.

D. Bidders Submitting More Than One Bid

Bidders submitting multiple bids may submit one set of forms consisting of all required Form A disclosures and one Form B for use with all bids. Please indicate in the space provided below the bid item that contains the original disclosure forms and the bid items which incorporate the forms by reference.

- The bid submitted for letting item _____ contains the Form A disclosures or Certification Statement and the Form B disclosures. The following letting items incorporate the said forms by reference:

**ILLINOIS DEPARTMENT
OF TRANSPORTATION**

**Form A
Financial Information &
Potential Conflicts of Interest
Disclosure**

Contractor Name		
Legal Address		
City, State, Zip		
Telephone Number		Fax Number (if available)

Disclosure of the information contained in this Form is required by the Section 50-35 of the Illinois Procurement Code (30 ILCS 500). Vendors desiring to enter into a contract with the State of Illinois must disclose the financial information and potential conflict of interest information as specified in this Disclosure Form. This information shall become part of the publicly available contract file. This Form A must be completed for bids in excess of \$10,000, and for all open-ended contracts. **A publicly traded company may submit a 10K disclosure in satisfaction of the requirements set forth in Form A. See Disclosure Form Instructions.**

DISCLOSURE OF FINANCIAL INFORMATION

1. Disclosure of Financial Information. The individual named below has an interest in the BIDDER (or its parent) in terms of ownership or distributive income share in excess of 5%, or an interest which has a value of more than \$87,526.20 (60% of the Governor’s salary as of 10/1/2000). **(Make copies of this form as necessary and attach a separate Disclosure Form A for each individual meeting these requirements)**

FOR INDIVIDUAL (type or print information)	
NAME:	_____
ADDRESS	_____
Type of ownership/distributable income share:	
stock _____	sole proprietorship _____
partnership _____	other: (explain on separate sheet): _____
% or \$ value of ownership/distributable income share: _____	

2. Disclosure of Potential Conflicts of Interest. Check “Yes” or “No” to indicate which, if any, of the following potential conflict of interest relationships apply. If the answer to any question is “Yes”, please attach additional pages and describe.

(a) State employment, currently or in the previous 3 years, including contractual employment of services.
Yes _____ No _____

(b) State employment of spouse, father, mother, son, or daughter, including contractual employment for services in the previous 2 years.
Yes _____ No _____

(c) Elective status; the holding of elective office of the State of Illinois, the government of the United States, any unit of local government authorized by the Constitution of the State of Illinois or the statutes of the State of Illinois currently or in the previous 3 years.
Yes _____ No _____

(d) Relationship to anyone holding elective office currently or in the previous 2 years; spouse, father, mother, son, or daughter
Yes _____ No _____

RETURN WITH BID/OFFER

(e) Appointive office; the holding of any appointive government office of the State of Illinois, the United States of America, or any unit of local government authorized by the Constitution of the State of Illinois or the statutes of the State of Illinois, which office entitles the holder to compensation in excess of the expenses incurred in the discharge of that office currently or in the previous 3 years.

Yes _____ No _____

(f) Relationship to anyone holding appointive office currently or in the previous 2 years; spouse, father, mother, son, or daughter.

Yes _____ No _____

(g) Employment, currently or in the previous 3 years, as or by any registered lobbyist of the State government.

Yes _____ No _____

(h) Relationship to anyone who is or was a registered lobbyist in the previous 2 years; spouse, father, mother, son, or daughter.

Yes _____ No _____

(i) Compensated employment, currently or in the previous 3 years, by any registered election or reelection committee registered with the Secretary of State or any county clerk of the State of Illinois, or any political action committee registered with either the Secretary of State or the Federal Board of Elections.

Yes _____ No _____

(j) Relationship to anyone; spouse, father, mother, son, or daughter; who was a compensated employee in the last 2 years by any registered election or re-election committee registered with the Secretary of State or any county clerk of the State of Illinois, or any political action committee registered with either the Secretary of State or the Federal Board of Elections.

Yes _____ No _____

APPLICABLE STATEMENT

This Disclosure Form A is submitted on behalf of the INDIVIDUAL named on previous page.

Completed by:

Name of Authorized Representative (type or print)

Completed by:

Title of Authorized Representative (type or print)

Completed by:

Signature of Individual or Authorized Representative

Date

NOT APPLICABLE STATEMENT

I have determined that no individuals associated with this organization meet the criteria that would require the completion of this Form A.

This Disclosure Form A is submitted on behalf of the CONTRACTOR listed on the previous page.

Name of Authorized Representative (type or print)

Title of Authorized Representative (type or print)

Signature of Authorized Representative

Date

**ILLINOIS DEPARTMENT
OF TRANSPORTATION**

**Form B
Other Contracts &
Procurement Related Information
Disclosure**

Contractor Name		
Legal Address		
City, State, Zip		
Telephone Number		Fax Number (if available)

Disclosure of the information contained in this Form is required by the Section 50-35 of the Illinois Procurement Act (30 ILCS 500). This information shall become part of the publicly available contract file. This Form B must be completed for bids in excess of \$10,000, and for all open-ended contracts.

DISCLOSURE OF OTHER CONTRACTS AND PROCUREMENT RELATED INFORMATION

1. Identifying Other Contracts & Procurement Related Information. The BIDDER shall identify whether it has any pending contracts (including leases), bids, proposals, or other ongoing procurement relationship with any other State of Illinois agency: Yes _____ No _____

If **“No”** is checked, the bidder only needs to complete the signature box on the bottom of this page.

2. If “Yes” is checked. Identify each such relationship by showing State of Illinois agency name and other descriptive information such as bid or project number (attach additional pages as necessary). SEE DISCLOSURE FORM INSTRUCTIONS:

THE FOLLOWING STATEMENT MUST BE SIGNED

Name of Authorized Representative (type or print)	

Title of Authorized Representative (type or print)	
_____	_____
Signature of Authorized Representative	Date

RETURN WITH BID

SPECIAL NOTICE TO CONTRACTORS

The following requirements of the Illinois Department of Human Rights' Rules and Regulations are applicable to bidders on all construction contracts advertised by the Illinois Department of Transportation:

CONSTRUCTION EMPLOYEE UTILIZATION PROJECTION

- (a) All bidders on construction contracts shall complete and submit, along with and as part of their bids, a Bidder's Employee Utilization Form (Form BC-1256) setting forth a projection and breakdown of the total workforce intended to be hired and/or allocated to such contract work by the bidder including a projection of minority and female employee utilization in all job classifications on the contract project.
- (b) The Department of Transportation shall review the Employee Utilization Form, and workforce projections contained therein, of the contract awardee to determine if such projections reflect an underutilization of minority persons and/or women in any job classification in accordance with the Equal Employment Opportunity Clause and Section 7.2 of the Illinois Department of Human Rights' Rules and Regulations for Public Contracts adopted as amended on September 17, 1980. If it is determined that the contract awardee's projections reflect an underutilization of minority persons and/or women in any job classification, it shall be advised in writing of the manner in which it is underutilizing and such awardee shall be considered to be in breach of the contract unless, prior to commencement of work on the contract project, it submits revised satisfactory projections or an acceptable written affirmative action plan to correct such underutilization including a specific timetable geared to the completion stages of the contract.
- (c) The Department of Transportation shall provide to the Department of Human Rights a copy of the contract awardee's Employee Utilization Form, a copy of any required written affirmative action plan, and any written correspondence related thereto. The Department of Human Rights may review and revise any action taken by the Department of Transportation with respect to these requirements.

RETURN WITH BID

PART II. WORKFORCE PROJECTION - continued

- B. Included in "Total Employees" under Table A is the total number of **new hires** that would be employed in the event the undersigned bidder is awarded this contract.

The undersigned bidder projects that: (number) _____ new hires would be recruited from the area in which the contract project is located; and/or (number) _____ new hires would be recruited from the area in which the bidder's principal office or base of operation is located.

- C. Included in "Total Employees" under Table A is a projection of numbers of persons to be employed directly by the undersigned bidder as well as a projection of numbers of persons to be employed by subcontractors.

The undersigned bidder estimates that (number) _____ persons will be directly employed by the prime contractor and that (number) _____ persons will be employed by subcontractors.

PART III. AFFIRMATIVE ACTION PLAN

- A. The undersigned bidder understands and agrees that in the event the foregoing minority and female employee utilization projection included under **PART II** is determined to be an underutilization of minority persons or women in any job category, and in the event that the undersigned bidder is awarded this contract, he/she will, prior to commencement of work, develop and submit a written Affirmative Action Plan including a specific timetable (geared to the completion stages of the contract) whereby deficiencies in minority and/or female employee utilization are corrected. Such Affirmative Action Plan will be subject to approval by the contracting agency and the **Department of Human Rights**.
- B. The undersigned bidder understands and agrees that the minority and female employee utilization projection submitted herein, and the goals and timetable included under an Affirmative Action Plan if required, are deemed to be part of the contract specifications.

Company _____ Telephone Number _____

 Address _____

NOTICE REGARDING SIGNATURE

The Bidder's signature on the Proposal Signature Sheet will constitute the signing of this form. The following signature block needs to be completed only if revisions are required.

Signature: _____ Title: _____ Date: _____

- Instructions: All tables must include subcontractor personnel in addition to prime contractor personnel.
- Table A - Include both the number of employees that would be hired to perform the contract work and the total number currently employed (Table B) that will be allocated to contract work, and include all apprentices and on-the-job trainees. The "Total Employees" column should include all employees including all minorities, apprentices and on-the-job trainees to be employed on the contract work.
 - Table B - Include all employees currently employed that will be allocated to the contract work including any apprentices and on-the-job trainees currently employed.
 - Table C - Indicate the racial breakdown of the total apprentices and on-the-job trainees shown in Table A.

RETURN WITH BID

CERTIFICATIONS REQUIRED BY STATE AND/OR FEDERAL LAW. The bidder is required by State and/or Federal law to make the below certifications and assurances as a part of the proposal and contract upon award. It is understood by the bidder that the certifications and assurances made herein are a part of the contract.

By signing the Proposal Signature Sheet, the bidder certifies that he/she has read and completed each of the following certifications and assurances, that required responses are true and correct and that the certified signature of the Proposal Signature Sheet constitutes an endorsement and execution of each certification and assurance as though each was individually signed:

A. By the execution of this proposal, the signing bidder certifies that the bidding entity has not, either directly or indirectly, entered into any agreement, participated in any collusion, or otherwise taken any action, in restraint of free competitive bidding in connection with the submitted bid. This statement made by the undersigned bidder is true and correct under penalty of perjury under the laws of the United States.

B. **CERTIFICATION, EQUAL EMPLOYMENT OPPORTUNITY:**

1. Have you participated in any previous contracts or subcontracts subject to the equal opportunity clause.
YES _____ NO _____

2. If answer to #1 is yes, have you filed with the Joint Reporting Committee, the Director of OFCC, any Federal agency, or the former President's Committee on Equal Employment Opportunity, all reports due under the applicable filing requirements of those organizations? YES _____ NO _____

C. **BUY AMERICAN - STEEL AND MANUFACTURED PRODUCTS FOR CONSTRUCTION CONTRACTS (JAN 1991)**

(a) The Aviation Safety and Capacity Expansion Act of 1990 provides that preference be given to steel and manufactured products produced in the United States when funds are expended pursuant to a grant issued under the Airport Improvement Program. The following terms apply:

1. Steel and manufactured products. As used in this clause, steel and manufactured products include (1) steel produced in the United States or (2) a manufactured product produced in the United States, if the cost of its components mined, produced or manufactured in the United States exceeds 60 percent of the cost of all its components and final assembly has taken place in the United States. Components of foreign origin of the same class or kind as the products referred to in subparagraphs (b)(1) or (2) shall be treated as domestic.

2. Components. As used in this clause, components means those articles, materials, and supplies incorporated directly into steel and manufactured products.

3. Cost of Components. This means the costs for production of the components, exclusive of final assembly labor costs.

(b) The successful bidder will be required to assure that only domestic steel and manufactured products will be used by the Contractor, subcontractors, materialmen, and suppliers in the performance of this contract, except those-

- (1) that the U.S. Department of Transportation has determined, under the Aviation Safety and Capacity Expansion Act of 1990, are not produced in the United States in sufficient and reasonably available quantities of a satisfactory quality;

- (2) that the U.S. Department of Transportation has determined, under the Aviation Safety and Capacity Expansion Act of 1990, that domestic preference would be inconsistent with the public interest; or

- (3) that inclusion of domestic material will increase the cost of the overall project contract by more than 25 percent.

(End of Clause)

RETURN WITH BID

D. BUY AMERICAN CERTIFICATE (JAN 1991)

By submitting a bid/proposal under this solicitation, except for those items listed by the offeror below or on a separate and clearly identified attachment to this bid/proposal, the offeror certifies that steel and each manufactured product, is produced in the United States (as defined in the clause Buy American - Steel and Manufactured Products or Buy American - Steel and Manufactured Products For Construction Contracts) and that components of unknown origin are considered to have been produced or manufactured outside the United States.

Offerors may obtain from (IDOT, Division of Aeronautics) lists of articles, materials, and supplies excepted from this provision.

PRODUCT

COUNTRY OF ORIGIN

E. NPDES CERTIFICATION

In accordance with the provisions of the Illinois Environmental Protection Act, the Illinois Pollution Control Board Rules and Regulations (35 Ill. Adm. Code, Subtitle C, Chapter I), and the Clean Water Act, and the regulations thereunder, this certification is required for all construction contracts that will result in the disturbance of five or more acres total land area.

The undersigned bidder certifies under penalty of law that he/she understands the terms and conditions of the general National Pollutant Discharge Elimination System (NPDES) permit (ILR100000) that authorizes the storm water discharges associated with industrial activity from the construction site identified as part of this certification.

The Airport Owner or its Agent will:

- 1) prepare, sign and submit the Notice of Intent (NOI)
- 2) conduct site inspections and complete and file the inspection reports
- 3) submit Incidence of Non-Compliance (ION) forms
- 4) submit Notice of Termination (NOT) form

Prior to the issuance of the Notice-to-Proceed, for each erosion control measure identified in the Storm Water Pollution Prevention Plan, the contractor or subcontractor responsible for the control measure(s) must sign the above certification (forms to be provided by the Department).

F. NON-APPROPRIATION CLAUSE

By submitting a bid/proposal under this solicitation the offeror certifies that he/she understands that obligations of the State will cease immediately without penalty or further payment being required in any fiscal year the Illinois General Assembly fails to appropriate or otherwise make available sufficient funds for this contract.

G. Contractor is not delinquent in the payment of any debt to the State (or if delinquent has entered into a deferred payment plan to pay the debt), and Contractor acknowledges the contracting state agency may declare the contract void if this certification is false (30 ILCS 500/50-11, effective July 1, 2002).

RETURN WITH BID

NOTICE TO BIDDERS

- 1. TIME AND PLACE OF OPENING BIDS.** Sealed proposals for the improvement described herein will be received by the Department of Transportation at the Harry R. Hanley Building, 2300 South Dirksen Parkway in Springfield, Illinois until 10:00 o'clock a.m., April 28, 2006. All bids will be gathered, sorted, publicly opened and read in the auditorium at the Department of Transportation's Harry R. Hanley Building shortly after the 10:00 a.m. cut off time.
- 2. DESCRIPTION OF WORK.** The proposed improvement, shown in detail on the plans issued by the Department includes, in general, the following described work:

Rehabilitation and reconstruction of the general aviation apron and Taxiway A1.

- 3. INSTRUCTIONS TO BIDDERS.** (a) This Notice, the invitation for bids, proposal and award shall, together with all other documents in accordance with Article 10-15 of the Illinois Standard Specifications for Construction of Airports, become part of the contract. Bidders are cautioned to read and examine carefully all documents, to make all required inspections, and to inquire or seek explanation of the same prior to submission of a bid.

(b) State law, and, if the work is to be paid wholly or in part with Federal-aid funds, Federal law requires the bidder to make various certifications as a part of the proposal and contract. By execution and submission of the proposal, the bidder makes the certification contained therein. A false or fraudulent certification shall, in addition to all other remedies provided by law, be a breach of contract and may result in termination of the contract.
- 4. AWARD CRITERIA AND REJECTION OF BIDS.** This contract will be awarded to the lowest responsive and responsible bidder considering conformity with the terms and conditions established by the Department in the proposal and contract documents. The issuance of plans and proposal forms for bidding based upon a prequalification rating shall not be the sole determinant of responsibility. The Department reserves the right to determine responsibility at the time of award, to reject any or all proposals, to readvertise the proposed improvement, and to waive technicalities.
- 5. PRE-BID CONFERENCE.** There will be a pre-bid conference held at N/A at the Greenville Airport administration building. For engineering information, contact Bob Hanneken of Henry Meisenheimer & Gende, Inc. at (618) 594-3711.
- 6. DISADVANTAGED BUSINESS POLICY.** The DBE goal for this contract is 12.0%.
- 7. SPECIFICATIONS AND DRAWINGS.** The work shall be done in accordance with the Illinois Standard Specifications for Construction of Airports, the Illinois Division of Aeronautics Supplemental Specifications and Recurring Special Provisions, the Special Provisions dated March 24, 2006 and the Construction Plans dated March 24, 2006 as approved by the Department of Transportation, Division of Aeronautics.

RETURN WITH BID

- 8. INSPECTION OF RECORDS.** The Contractor shall maintain an acceptable cost accounting system. The Sponsor, the FAA, and the Comptroller General of the United States shall have access to any books, documents, paper, and records of the Contractor which are directly pertinent to the specific contract for the purposes of making an audit, examination, excerpts, and transcriptions. The Contractor shall maintain all required records for three years after the Sponsor makes final payment and all other pending matters are closed.
- 9. RIGHTS TO INVENTIONS.** All rights to inventions and materials generated under this contract are subject to Illinois law and to regulations issued by the FAA and the Sponsor of the Federal grant under which this contract is executed. Information regarding these rights is available from the FAA and the Sponsor.
- 10. TERMINATION OF CONTRACT.**
1. The Sponsor may, by written notice, terminate this contract in whole or in part at any time, either for the Sponsor's convenience or because of failure to fulfill the contract obligations. Upon receipt of such notice services shall be immediately discontinued (unless the notice directs otherwise) and all materials as may have been accumulated in performing this contract, whether completed or in progress, delivered to the Sponsor.
 2. If the termination is for the convenience of the Sponsor, an equitable adjustment in the contract price shall be made, but no amount shall be allowed for anticipated profit on unperformed services.
 3. If the termination is due to failure to fulfill the Contractor's obligations, the Sponsor may take over the work and prosecute the same to completion by contract or otherwise. In such case, the Contractor shall be liable to the Sponsor for any additional cost occasioned to the Sponsor thereby.
 4. If, after notice of termination for failure to fulfill contract obligations, it is determined that the Contractor had not so failed, the termination shall be deemed to have been effected for the convenience of the Sponsor. In such event, adjustment in the contract price shall be made as provided in paragraph 2 of this clause.
 5. The rights and remedies of the sponsor provided in this clause are in addition to any other rights and remedies provided by law or under this contract.

RETURN WITH BID

11. BIDDING REQUIREMENTS AND BASIS OF AWARD. When alternates are included in the proposal, the following shall apply:

a. Additive Alternates

- (1) Bidders must submit a bid for the Base Bid and for all Additive Alternates.
- (2) Award of this contract will be made to the lowest responsible qualified bidder computed as follows:

The lowest aggregate amount of (i) the Base Bid plus (ii) any Additive Alternate(s) which the Department elects to award.

The Department may elect not to award any Additive Alternates. In that case, award will be to the lowest responsible qualified bidder of the Base Bid.

b. Optional Alternates

- (1) Bidders must submit a bid for the Base Bid and for either Alternate A or Alternate B or for both Alternate A and Alternate B.
- (2) Award of this contract will be made to the lowest responsible qualified bidder computed as follows:

The lower of the aggregate of either (i) the Base Bid plus Alternate A or (ii) the Base Bid plus Alternate B.

12. CONTRACT TIME. The Contractor shall complete all work within the specified contract time. Any calendar day extension beyond the specified contract time must be fully justified, requested by the Contractor in writing, and approved by the Engineer, or be subject to liquidated damages.

The contract time for this contract is 94 calendar days and is based on anticipated notice-to-proceed date of May 30, 2006.

13. INDEPENDENT WEIGHT CHECKS. The Department reserves the right to conduct random unannounced independent weight checks on any delivery for bituminous, aggregate or other pay item for which the method of measurement for payment is based on weight. The weight checks will be accomplished by selecting, at random, a loaded truck and obtaining a loaded and empty weight on an independent scale. In addition, the department may perform random weight checks by obtaining loaded and empty truck weights on portable scales operated by department personnel.

14. GOOD FAITH COMPLIANCE. The Illinois Department of Transportation has made a good faith effort to include all statements, requirements, and other language required by federal and state law and by various offices within federal and state governments whether that language is required by law or not. If anything of this nature has been left out or if additional language etc. is later required, the bidder/contractor shall cooperate fully with the Department to modify the contract or bid documents to correct the deficiency. If the change results in increased operational costs, the Department shall reimburse the contractor for such costs as it may find to be reasonable.

RETURN WITH BID

PROPOSAL SIGNATURE SHEET

The undersigned bidder hereby makes and submits this bid on the subject Proposal, thereby assuring the Department that all requirements of the Invitation for Bids and rules of the Department have been met, that there is no misunderstanding of the requirements of paragraph 4 of this Proposal, and that the contract will be executed in accordance with the rules of the Department if an award is made on this bid.

Firm Name _____

(IF AN INDIVIDUAL)

Signature of Owner _____

Business Address _____

Firm Name _____

By _____

(IF A CO-PARTNERSHIP)

Business Address _____

Name and Address of All Members of the Firm:

Corporate Name _____

Corporate Seal

By _____

President

(IF A CORPORATION)

Attest _____

Corporate Secretary

Business Address _____

Name of Corporate Officers:

President Corporate Secretary Treasurer

NOTARY CERTIFICATION

STATE OF ILLINOIS,

ALL SIGNATURES MUST BE NOTARIZED

COUNTY OF _____

I, _____, a Notary Public in and for said county, do hereby certify that _____

_____ AND _____

(Insert names of individual(s) signing on behalf of bidder)

who are each personally known to me to be the same persons whose names are subscribed to the foregoing instrument on behalf of the bidder, appeared before me this day in person and acknowledged that they signed, sealed, and delivered said instrument as their free and voluntary act for the uses and purposes therein set forth.

Given under my hand and notarial seal this _____ day of _____, A.D. _____

My commission expires _____ (Seal)

Notary Public



Return with Bid

Division of Aeronautics
Proposal Bid Bond
(Effective January 1, 2002)

Item No. 2A
Letting Date: April 28, 2006

Airport: Greenville Airport
Ill. Proj. No. GRE-3215
Fed. Proj. No. 3-17-0049-B4

KNOW ALL MEN BY THESE PRESENTS. that we, _____, as PRINCIPAL, and _____, as SURETY are held and firmly bound unto the, hereinafter called the SPONSOR, in the penal sum of 5 percent of the total bid price or of the amount specified in Section 6, PROPOSAL GUARANTEE of the Proposal Document, whichever is the lesser sum, well and truly to be paid unto the said SPONSOR, for the payment of which we bind ourselves, our heirs, executors, administrators, successors, and assigns.

THE CONDITION OF THIS OBLIGATION IS SUCH, that whereas the PRINCIPAL has submitted a Bid Proposal to the SPONSOR through its AGENT, the State of Illinois, Department of Transportation, Division of Aeronautics, for the improvement designated by the Transportation Bulletin Item Number and Letting Date indicated above;

NOW, THEREFORE, if the SPONSOR through its AGENT shall accept the Bid Proposal of the PRINCIPAL; and if PRINCIPAL shall within the time and as specified in the Bidding and Contract Documents, submit the DBE Utilization Plan that is acceptable and approved by the AGENT, and if after the award, the PRINCIPAL shall enter into a contract in accordance with the terms of the Bidding and Contract Documents including evidence of insurance coverage's and providing such bond as specified with good and sufficient surety for the faithful performance of such contract and for prompt payment of labor and material furnished in the prosecution thereof; or if, in the event of the failure of the PRINCIPAL to make the required DBE submission or to enter into such contract and to give the specified bond, the PRINCIPAL pays to the SPONSOR the difference not to exceed the penalty hereof between the amount in the Bid Proposal and such larger amount for which the SPONSOR may contract with another party to perform the work covered by said Proposal Document, then, this obligation to be void; otherwise to remain in full force and effect.

IN THE EVENT the SPONSOR acting through its AGENT determines the PRINCIPAL has failed to comply with any requirement as set forth in the preceding paragraph, then the SURETY shall pay the penal sum to the SPONSOR within fifteen (15) days of written demand therefor. If the SURETY does not make full payment within such period of time, the AGENT may bring an action to collect the amount owed. The SURETY is liable to the SPONSOR and to the AGENT for all its expenses, including attorney's fees, incurred in any litigation in which SPONSOR or AGENT prevail either in whole or in part.

IN WITNESS WHEREOF, the said PRINCIPAL and the said SURETY have caused this instrument to be signed by

their respective officers this _____ day of _____ A.D., 20 ____.

PRINCIPAL

SURETY

(Company Name)

(Company Name)

By: _____ (Signature & Title)

By: _____ (Signature of Attorney-in-Fact)

Notary Certification for Principal and Surety

State of Illinois)
) ss:
County of _____)

I, _____, a Notary Public in and for said County, do hereby certify that _____ and _____ (Insert names of individuals signing on behalf of PRINCIPAL & SURETY)

who are each personally known to me to be the same persons whose names are subscribed to the foregoing instrument on behalf of PRINCIPAL and SURETY, appeared before me this day in person and acknowledged respectively, that they signed and delivered said instrument as their free and voluntary act for uses and purposes therein set forth.

Given under my hand and notary seal this _____ day of _____ A.D., 20 ____

My commission expires _____ (Notary Public)

In lieu of completing the above section of the Proposal Bid Form, the PRINCIPAL may file an Electronic Bid Bond. By signing below, the PRINCIPAL is ensuring the identified electronic bid bond has been executed and the PRINCIPAL and SURETY are firmly bound to the SPONSOR through its AGENT under the conditions of the Bid Bond as shown above.

Electronic Bid Bond ID#

Company/Bidder Name

Signature and Title
Form D.E. (Rev. 12-2001)



PROPOSALS

for construction work advertised for bids by the
Illinois Department of Transportation

Item No.	Item No.	Item No.

Submitted By:

Name:
Address:
Phone No.

Bidders should affix this form to the front of a 10" x 13" envelope and use that envelope for the submittal of bids. If proposals are mailed, they should be enclosed in a second or outer envelope addressed to:

Engineer of Design and Environment - Room 323
Illinois Department of Transportation
2300 South Dirksen Parkway
Springfield, Illinois 62764

CONTRACTOR OFFICE COPY OF CONTRACT SPECIFICATIONS

NOTICE

None of the following material needs to be returned with the bid package unless the special provisions require documentation and/or other information to be submitted.



Illinois Department of Transportation

CONTRACT REQUIREMENTS

(1) Airport Improvement Program projects. The work in this contract is included in the federal Airport Improvement Program and is being undertaken and accomplished by the Illinois Department of Transportation, Division of Aeronautics and the Municipality, hereinafter called the Co-Sponsors, in accordance with the terms and conditions of a Grant Agreement between the Co-Sponsors and the United States, under the Airport and Airway Improvement Act of 1982 (Public Law 97-248; Title V, Section 501 et seq., September 3, 1982; 96 Stat. 671; codified at 49 U.S.C Section 2201 et seq.) and Part 152 of the Federal Aviation Regulations (14 CFR Part 152), pursuant to which the United States has agreed to pay a certain percentage of the costs of the Project that are determined to be allowable Project costs under the Act. The United States is not a party to this contract and no reference in this contract to FAA or representative thereof, or to any rights granted to the FAA or any representative thereof, or the United States, by the contract, makes the United States a party to this contract.

(2) Consent of Assignment. The Contractor shall obtain the prior written consent of the Co-Sponsors to any proposed assignment of any interest in or part of this contract.

(3) Convict Labor. No convict labor may be employed under this contract.

(4) Veterans Preference. In the employment of labor, except in executive, administrative, and supervisory positions, preference shall be given to veterans of the Vietnam era and disabled veterans as defined in Section 515(c) of the Airport and Airway Improvement Act of 1982. However, this preference shall apply only where the individuals are available and qualified to perform the work to which the employment relates.

(5) Withholding: Sponsor from Contractor. Whether or not payments or advances to the Co-Sponsors are withheld or suspended by the FAA, the Co-Sponsors may withhold or cause to be withheld from the Contractor so much of the accrued payments or advances as may be considered necessary to pay laborers and mechanics employed by the Contractor or any subcontractor on the work the full amount of wages required by this contract.

(6) Nonpayment of Wages. If the Contractor or subcontractor fails to pay any laborer or mechanic employed or working on the site of the work any of the wages required by this contract the Co-Sponsors may, after written notice to the Contractor, take such action as may be necessary to cause the suspension of any further payment or advance of funds until the violations cease.

(7) FAA Inspection and Review. The Contractor shall allow any authorized representative of the FAA to inspect and review any work or materials used in the performance of this contract.

(8) Subcontracts. The Contractor shall insert in each of his subcontracts the provisions contained in Paragraphs (1), (3), (4), (5), (6), and (7) above and also a clause requiring the subcontractors to include these provisions in any lower tier subcontracts which they may enter into, together with a clause requiring this insertion in any further subcontracts that may in turn be made.

(9) Contract Termination. A breach of Paragraph (6), (7), and (8) above may be grounds for termination of the contract.

PROVISIONS REQUIRED BY THE REGULATIONS OF THE SECRETARY OF LABOR 29 CFR 5.5

(a) Contract Provisions and Related Matters.

(1) Minimum Wages.

Revised 1/92

(i) All laborers and mechanics employed or working upon the site of the work will be paid unconditionally and not less often than once a week, and without subsequent deduction or rebate on any account (except such payroll deductions as are permitted by regulations issued by the Secretary of Labor under the Copeland Act (29 CFR Part 3)), the full amount of wages and bona fide fringe benefits (or cash equivalents thereof) due at time of payment computed at rates not less than those contained in the wage determination of the Secretary of Labor which is attached hereto and made a part hereof, regardless of any contractual relationship which may be alleged to exist between the Contractor and such laborers and mechanics. Contributions made or costs reasonably anticipated for bona fide fringe benefits under section 1(b)(2) of the Davis-Bacon Act on behalf of laborers or mechanics are considered wages paid to such laborers or mechanics, subject to the provision of paragraph (a)(1)(iv) of this section; also, regular contributions made or costs incurred for more than a weekly period (but not less often than quarterly) under plans, funds, or programs which cover the particular weekly period, are deemed to be constructively made or incurred during such weekly period. Such laborers and mechanics shall be paid the appropriate wage rate and fringe benefits on the wage determination for the classification of work actually performed, without regard to skill, except as provided in paragraph 5.5(a)(4). Laborers or mechanics performing work in more than one classification may be compensated at the rate specified for each classification for the time actually worked therein: provided, that the employer's payroll records accurately set forth the time spent in each classification in which work is performed. The wage determination (including any additional classification and wage rates conformed under paragraph (a)(1)(ii) of this section) and the Davis-Bacon poster (WH-1321) shall be posted at all times by the Contractor and its subcontractors at the site of the work in a prominent and accessible place where it can be easily seen by the workers.

(ii)(A) The contracting officer shall require that any class of laborers or mechanics which is not listed in the wage determination and which is to be employed under the contract shall be classified in conformance with the wage determination. The contracting officer shall approve an additional classification and wage rate and fringe benefits therefor only when the following criteria have been met:

- (1) The work to be performed by the classification requested is not performed by a classification in the wage determination; and
- (2) The classification is utilized in the area by the construction industry; and
- (3) The proposed wage rate, including any bona fide fringe benefits, bears a reasonable relationship to the wage rates contained in the wage determination.

(ii)(B) If the Contractor and the laborers and mechanics to be employed in the classification (if known), or their representatives, and the contracting officer agree on the classification and wage rate (including the amount designated for fringe benefits where appropriate), a report of the action taken shall be sent by the contracting officer to the Administrator of the Wage and Hour Division, Employment Standards Administration, U.S. Department of Labor, Washington, D.C. 20210. The Administrator, or an authorized representative, will approve, modify, or disapprove every additional classification action within 30 days of receipt and so advise the contracting officer or will notify the contracting officer within the 30-day period that additional time is necessary. (Approved by the Office of Management and Budget under OMB control number 1215-0140).

(ii)(C) In the event the Contractor, the laborers or mechanics to be employed in the classification or their representatives, and the contracting officer do not agree on the proposed classification and wage rate (including the amount designated for fringe benefits, where appropriate), the contracting officer shall refer the questions, including the views of all interested parties and the recommendation of the contracting officer, to the Administrator for determination. The Administrator, or an authorized representative, will issue a determination within 30 days of receipt and so advise the contracting officer or will notify the contracting officer within the 30-day period that additional time is necessary. (Approved by the Office of Management and Budget under OMB control number 1215-0140).

(ii)(D) The wage rate (including fringe benefits where appropriate) determined pursuant to subparagraphs (1)(B) or (C) of this paragraph, shall be paid to all workers performing work in the classification under this contract from the first day on which work is performed in the classification.

(iii) Whenever the minimum wage rate prescribed in the contract for a class of laborers or mechanics includes a fringe benefit which is not expressed as an hourly rate, the Contractor shall either pay the benefit as stated in the wage determination or shall pay another bona fide fringe benefit or an hourly cash equivalent thereof.

(iv) If the Contractor does not make payments to a trustee or other third person, the Contractor may consider as part of the wages of any laborer or mechanic the amount of any costs reasonably anticipated in providing bona fide fringe benefits under a plan or program, provided, that the Secretary of Labor has found, upon the written request of the Contractor, that the applicable standards of the Davis-Bacon Act have been met. The Secretary of Labor may require the Contractor to set aside in a separate account assets for the meeting of obligations under the plan or program. (Approved by the Office of Management and Budget under OMB control number 1215-0140).

(2) Withholding. The Federal Aviation Administration shall upon its own action or written request of an authorized representative of the Department of Labor withhold or cause to be withheld from the Contractor under this contract or any other Federal contract with the same prime Contractor, or any other Federally-assisted contract subject to Davis-Bacon prevailing wage requirements, which is held by the same prime Contractor, so much of the accrued payments or advances as may be considered necessary to pay laborers and mechanics, including apprentices, trainees, and helpers, employed by the Contractor or any subcontractor the full amount of wages required by the contract. In the event of failure to pay any laborer or mechanic, including any apprentice, trainee, or helper, employed or working on the site of the work, all or part of the wages required by the contract, the (Agency) may, after written notice to the Contractor, sponsor, applicant, or owner, take such action as may be necessary to cause the suspension of any further payment, advance, or guarantee of funds until such violations have ceased.

(3) Payrolls and basic records.

(i) Payrolls and basic records relating thereto shall be maintained by the Contractor during the course of the work and preserved for a period of three years thereafter for all laborers and mechanics working at the site of the work. Such records shall contain the name, address, and social security number of each such work, his or her correct classification, hourly rates of wages paid (including rates of contributions or costs anticipated for bona fide fringe benefits or cash equivalents thereof of the types described in section 1(b)(2)(B) of the Davis-Bacon Act), daily and weekly number of hours worked, deductions made and actual wages paid. Whenever the Secretary of Labor has found under 29 CFR 5.5(a)(1)(iv) that the wages of any laborer or mechanic include the amount of any costs reasonably anticipated in providing benefits under a plan or program described in section 1(b)(2)(B) of the Davis-Bacon Act, the Contractor shall maintain records which show that the commitment to provide such benefits is enforceable, that the plan or program is financially responsible, and that the plan or program has been communicated in writing to the laborers or mechanics affected, and records which show the costs anticipated or the actual cost incurred in providing such benefits. Contractors employing apprentices or trainees under approved programs shall maintain written evidence of the registration of apprenticeship programs and certification of trainee programs, the registration of the apprentices and trainees, and the ratios and wage rates prescribed in the applicable programs. (Approved by the Office Management and Budget under OMB control numbers 1215-0140 and 1215-0017).

(ii)(A) The Contractor shall submit weekly for each week in which any contract work is performed a copy of all payrolls to the Federal Aviation Administration if the agency is a party to the contract, but if the agency is not such a party, the Contractor will submit the payrolls to the applicant, sponsor, or owner, as the case may be, for transmission to the Federal Aviation Administration. The payrolls submitted shall set out accurately and completely all of the information required to be maintained under paragraph 5.5(a)(3)(i) of Regulations, 29 CFR Part 5. This information may be submitted in any form desired.

Optional Form WH-347 is available for this purpose and may be purchased from the Superintendent of Documents (Federal Stock Number 029-005-00014-1), U.S. Government Printing Office, Washington, D.C. 20402. The prime Contractor is responsible for the submission of copies of payrolls by all subcontractors. (Approved by the Office of Management and Budget under OMB control number 1215-0149).

(ii)(B) Each payroll submitted shall be accompanied by a "Statement of Compliance," signed by the Contractor, or subcontractor or his or her agent who pays or supervises the payment of the persons employed under the contract and shall certify the following:

(1) That the payroll for the payroll period contains the information required to be maintained under paragraph 5.5(a)(3)(i) of Regulations, 29 CFR Part 5 and that such information is correct and complete;

(2) That each laborer or mechanic (including each helper, apprentice, and trainee) employed on the contract during the payroll period has been paid the full weekly wages earned, without rebate, either directly or indirectly, and that no deductions have been made either directly or indirectly from the full wages earned, other than permissible deductions as set forth in Regulations, 29 CFR Part 3;

(3) That each laborer or mechanic has been paid not less than the applicable wage rates and fringe benefits or cash equivalents for the classification of work performed as specified in the applicable wage determination incorporated into the contract.

(ii)(C) The weekly submission of a properly executed certification set forth on the reverse side of Optional Form WH-347 shall satisfy the requirement for submission of the "Statement of Compliance" required by paragraph (a)(3)(ii)(B) of this section.

(ii)(D) The falsification of any of the above certifications may subject the Contractor or subcontractor to civil or criminal prosecution under Section 1001 of Title 18 and Section 231 of Title 31 of the United States Code.

(iii) The Contractor or subcontractor shall make the records required under paragraph (a)(3)(i) of this section available for inspection, copying, or transcription by authorized representatives of the (write the name of the agency) or the Department of Labor, and shall permit such representatives to interview employees during working hours on the job. If the Contractor or subcontractor fails to submit the required records or to make them available, the Federal agency may, after written notice to the Contractor, sponsor, applicant, or owner, take such action as may be necessary to cause the suspension of any further payment, advance, or guarantee of funds. Furthermore, failure to submit the required records upon request or to make such records available may be grounds for debarment action pursuant to 29 CFR 5.12.

(4) Apprentices and Trainees

(i) Apprentices. Apprentices will be permitted to work at less than the predetermined rate for the work they performed when they are employed pursuant to and individually registered in a bona fide apprenticeship program registered with the U.S. Department of Labor, Employment and Training Administration, Bureau of Apprenticeship and Training, or with a State Apprenticeship Agency recognized by the Bureau, or if a person is employed in his or her first 90 days of probationary employment as a apprentice in such an apprenticeship program, who is not individually registered in the program, but who has been certified by the Bureau of Apprenticeship and Training or a State Apprenticeship Agency (where appropriate) to be eligible for probationary employment as an apprentice. The allowable ratio of apprentices to journeymen on the job site in any craft classification shall not be greater than the ratio permitted to the Contractor as to the entire work force under the registered program. Any worker listed on a payroll at an apprentice wage rate, who is not registered or otherwise employed as stated above, shall be paid not less than the applicable wage rate on the wage determination for the classification of work actually performed. In addition, any apprentice performing work on the job site in excess of the ratio permitted under the registered program shall be paid not less than the applicable wage rate on the wage determination for the work actually performed. Where a Contractor is performing construction on a project in a locality other than that in which its program is registered, the ratios and wage rates (expressed in percentages of the journeyman's hourly rate) specified in the Contractor's or subcontractor's registered program shall be observed. Every apprentice must be paid at not less than the rate specified in the registered program for the apprentice's level of progress, expressed as a percentage of the journeymen hourly rate specified in the applicable wage determination. Apprentices shall be paid fringe benefits in accordance with the provisions of the apprenticeship program. If the apprenticeship program does not specify fringe benefits, apprentices must be paid the full amount of fringe benefits listed on the wage determination for the applicable classification. If the Administrator determines that a different practice prevails for the applicable apprentice classification, fringes shall be paid in accordance with that determination. In the event the Bureau of Apprenticeship and Training, or a State Apprenticeship Agency recognized by the Bureau, withdraws approval of an apprenticeship program, the Contractor will no longer be permitted to utilize apprentices at less than the applicable predetermined rate for the work performed until an acceptable program is approved.

(ii) Trainees. Except as provided in 29 CFR 5.16, trainees will not be permitted to work at less than the predetermined rate for the work performed unless they are employed pursuant to and individually registered in a program which has received prior approval, evidenced by formal certification by the U.S. Department of Labor, Employment and Training Administration. The ratio of trainees to journeymen on the job site shall not be greater than permitted under the plan approved by the Employment and Training Administration. Every trainee must be paid at not less than the rate specified in the approved program for the trainee's level of progress, expressed as a percentage of the journeyman hourly rate specified in the applicable wage determination. Trainees shall be paid fringe benefits in accordance with the provisions of the trainee program. If the trainee program does not mention fringe benefits, trainees shall be paid the full amount of fringe benefits listed on the wage determination unless the Administrator of the Wage and Hour Division determines that there is an apprenticeship program associated with the corresponding journeyman wage rate on the wage determination which provides for less than full fringe benefits for apprentices. Any employee listed on the payroll at a trainee rate who is not registered and participating in a training plan approved by the Employment and Training Administration shall be paid not less than the applicable wage rate on the wage determination for the classification of work actually performed. In addition, any trainee performing work on the job site in excess of the ration permitted under the registered program shall be paid not less than the applicable wage rate on the wage determination for the work actually performed. In the event the Employment and Training Administration withdraws approval of a training program, the contract will no longer be permitted to utilize trainees at less than the applicable predetermined rate for the work performed until an acceptable program is approved.

(iii) Equal employment opportunity. The utilization of apprentices, trainees and journeymen under this part shall be in conformity with the equal employment opportunity requirements of Executive Order 11246, as amended, and 29 CFR Part 30.

(5) Compliance with Copeland Act requirements. The Contractor shall comply with the requirements of 29 CFR Part 3, which are incorporated by reference in this contract.

(6) Subcontracts. The Contractor or subcontractor shall insert in any subcontracts the clauses contained in paragraph (a)(1) through (10) of this contract and such other clauses as the Federal Aviation Administration may by appropriate instructions require, and also a clause requiring the subcontractors to include these clauses in any lower tier subcontracts. The prime Contractor shall be responsible for the compliance by an subcontractor or lower tier subcontractor with all the contract clauses in 29 CFR 5.5.

(7) Contract determination: debarment. A breach of these contract clauses paragraphs (a)(1) through (10) and the 2nd clause (b)(1) through (5) below may be grounds for termination of the contract and for debarment as a Contractor and a subcontractor as provided in 29 CFR 5.12.

(8) Compliance with Davis-Bacon and Related Act requirements. All rulings and interpretations of the Davis-Bacon and Related Acts contained in 29 CFR Parts 1, 3, and 5 are herein incorporated by referenced in this contract.

(9) Disputes concerning labor standards. Disputes arising out of the labor standards provisions of this contract shall not be subject to the general disputes clause of this contract. Such disputes shall be resolved in accordance with the procedures of the Department of Labor set forth in 29 CFR Parts 5, 6, and 7. Disputes within the meaning of this clause include disputes between the Contractor (or any of its subcontractors) and the contracting agency, the U.S. Department of Labor, or the employees or their representatives.

(10) Certification of Eligibility.

(i) By entering into this contract, the Contractor certifies that neither it (nor he or she) nor any person or firm who has an interest in the Contractor's firm is a person or firm ineligible to be awarded Government contracts by virtue of section 3(a) of the Davis-Bacon Act or 29 CFR 5.12(a)(1).

(ii) No part of this contract shall be subcontracted to any person or firm ineligible for award of a Government contract by virtue of section 3(a) of the Davis-Bacon Act or 29 CFR 5.12(a)(1).

(iii) The penalty for making false statements is prescribed in the U.S. Criminal Code, 18 U.S.C. 1001.

(b) Contract Work Hours and Safety Standards Act. The Agency Head shall cause or require the contracting officer to insert the following clauses set forth in paragraphs (b)(1), (2), (3), (4) and (5) of this section in full in AIP construction contracts in excess of \$2,000. These clauses shall be inserted in addition to the clauses required by paragraph 5.5(a) or paragraph 4.6 of Part 4 of this title. As used in this paragraph, the terms "laborers" and "mechanics" include watchmen and guards.

(1) Overtime requirements: No Contractor or subcontractor contracting for any part of the contract work which may require or involve the employment of laborers, mechanics, watchmen or guards (including apprentices and trainees described in paragraphs 5 and 6 above) shall require or permit any laborer, mechanic, watchman or guard in any workweek in which he/she is employed on such work, to work in excess of 40 hours in such workweek unless such laborer, mechanic, watchman or guard receives compensation at a rate not less than one and one-half times his/her basic rate of pay for all hours worked in excess of 40 hours in such workweek.

(2) Violations: Liability for Unpaid Wages; Liquidated Damages: In the event of any violation of the clause set forth in subparagraph (1) of this paragraph, the Contractor and any subcontractor responsible therefore shall be liable to any affected employee for his/her unpaid wages. In addition, such Contractor and subcontractor shall be liable to the United States (in case of work done under contract for the District of Columbia or a territory, to such District or to such territory), for liquidated damages. Such liquidated damages shall be computed with respect to each individual laborer, mechanic, watchman or guard employed in violation of the clause set forth in subparagraph (1) of this paragraph, in the sum of \$10.00 for each calendar day on which such employee was required or permitted to work in excess of the standard workweek of 40 hours without payment of the overtime wages required by the clause set forth in subparagraph (1) of this paragraph.

(3) Withholding for unpaid wages and liquidated damages. The (write in the name of the Federal agency or the loan or grant recipient) shall upon its own action or upon written request of an authorized representative of the Department of Labor withhold or cause to be withheld, from any moneys payable on account of work performed by the Contractor or subcontractor under any such contract or any other Federal contract with the same prime Contractor, or any other Federally-assisted contract subject to the Contract Work Hours and Safety Standards Act, which is held by the same prime Contractor, such sums as may be determined to be necessary to satisfy any liabilities of such Contractor or subcontractor for unpaid wages and liquidated damages as provided in the clause set forth in subparagraph (2) of this paragraph.

(4) Subcontracts. The Contractor or subcontractor shall insert in any subcontracts the clauses set forth in subparagraph (1) through (4) of this paragraph and also a clause requiring the subcontractors to include these clauses in any lower tier subcontracts. The prime Contractor shall be responsible for compliance by any subcontractor or lower tier subcontractor with the clauses set forth in subparagraphs (1) through (4) of this paragraph.

(5) Working Conditions. No Contractor or subcontractor may require any laborer or mechanic employed in the performance of any contract to work in surroundings or under working conditions that are unsanitary, hazardous, or dangerous to his health or safety as determined under construction safety and health standards (29 CFR 1926) issued by Department of Labor.

(c) In addition to the clauses contained in paragraph (b), in any contract subject only to the Contract Work Hours and Safety Standards Act and not to any of the other statutes cited in paragraph 5.1, the Agency Head shall cause or require the contracting officer to insert a clause requiring that the Contractor or subcontractor shall maintain payrolls and basic payroll records during the course of the work and shall preserve them for a period of three years from the completion of the contract for all laborers and mechanics, including guards and watchmen, working on the contract. Such records shall contain the name and address of each such employee, social security number, correct classifications, hourly rates of wages paid, daily and weekly number of hours worked, deductions made, and actual wages paid. Further, the Agency Head shall cause or require the contracting officer to insert in any such contract a clause providing that the records to be maintained under this paragraph shall be made available by the Contractor or subcontractor for inspection, copying, or transcription by authorized representatives of the (write the name of agency) and the Department of Labor, and the Contractor or subcontractor will permit such representatives to interview employees during working hours on the job. (Approved by the Office of Management and Budget under OMB control numbers 1215-0140 and 1215-0017).

FEDERAL REGULATIONS VOL. 40, #74,
WEDNESDAY, APRIL 16, 1975, PAGE 17124,
ADMINISTRATION OF THE CLEAR AIR ACT
& WATER POLLUTION CONTROL ACT
(with respect to Federal Grants)

In connection with the administration of the Clean Air Act and the Water Pollution Control Act with respect to Federal Grants, specific requirements have been imposed of any contract which is not exempt under the provisions of 40 CFR 15.5.

(1) Any facility listed on the EPA List of Violating Facilities pursuant to Paragraph 15.20 of 40 CFR as of the date of the contract award will not be utilized in the performance of any non-exempt contract or subcontract.

(2) The Contractor shall comply with all the requirements of Section 114 of the Clean Air Act, as amended, 42 USC 1857 et seq. and Section 308 of the Federal Water Pollution Control Act, as amended, 33 USC 1251 et seq. relating to inspection, monitoring, entry, reports and information, as well as all other requirements specified in Section 114 and Section 308 of the Air Act and Water Act, respectively, and all regulations and guidelines issued thereunder after the award of the contract.

(3) Prompt notification shall be required prior to contract award to the awarding official by the Contractor who will receive the award of the receipt of any communication from the Director, Office of Federal Activities, U.S. Environmental Protection Agency, indicating that a facility to be utilized for the contract is under consideration to be listed on the EPA List of Violating Facilities.

(4) The Contractor shall include or cause to be included the criteria and requirements in paragraphs 1 through 4 in any non-exempt subcontract and will take such action as the Government may direct as a means of enforcing such provisions.

Attachment No. 1

During the performance of the contract, the Contractor agrees as follows:

- (1) The Contractor will not discriminate against any employee or applicant for employment because of race, color, religion, sex or national origin. The Contractor will take affirmative action to ensure that applicants are employed, and that employees are treated during employment without regard to their race, color, religion, sex or national origin. Such action shall include, but not be limited to the following: Employment, upgrading, demotion or transfer, recruitment or recruitment advertising, layoff or termination, rates of pay or other forms of compensation, and selection for training including apprenticeship. The Contractor agrees to post in conspicuous places, available to employees and applicants for employment, notices to be provided setting forth the provisions of this nondiscrimination clause.
- (2) The Contractor will, in all solicitations or advertisements for employees placed by or on the behalf of the Contractor, state that all qualified applicants will receive consideration for employment without regard to race, color, religion, sex or national origin.
- (3) The Contractor will send to each labor union or representative of workers with which he has a collective bargaining agreement or other contract or understanding, a notice to be provided advising the said labor union or worker's representatives of the Contractor's commitments under this section, and shall post copies of the notice in conspicuous places available to employees and applicants for employment.
- (4) The Contractor will comply with all provisions of Executive Order 11246 of September 24, 1965, and of the rules, regulations, and relevant orders of the Secretary of Labor.
- (5) The Contractor will furnish all information and reports required by Executive Order 11246 of September 24, 1965, and by rules, regulations and orders of the Secretary of Labor, or pursuant thereto, and will permit access to his books, records, and accounts by the administering agency and the Secretary of Labor for purposes of investigation to ascertain compliance with such rules, regulations, and orders.
- (6) In the event of the Contractor's noncompliance with the nondiscrimination clauses of this contract or with any of the said rules, regulations, or orders, this contract may be canceled, terminated, or suspended in whole or in part and the Contractor may be declared ineligible for further government contracts or federally assisted construction contracts in accordance with procedures authorized in Executive Order 11246 of 24 September 1965, and such other sanctions may be imposed and remedies invoked as provided in Executive Order 11246 of 24 September 1965, or by rule, regulation or order of the Secretary of Labor, or as otherwise provided by law.
- (7) The Contractor will include the portion of the sentence immediately preceding paragraph (1) and the provisions of paragraphs (1) through (7) in every subcontract or purchase order unless exempted by rules, regulations, or orders of the Secretary of Labor issued pursuant to Section 204 of Executive Order 11246 of 24 September 1965, so that such provisions will be binding upon each subcontractor or vendor. The Contractor will take such action with respect to any subcontract or purchase order as the administering agency may direct as means of enforcing such provisions, including sanctions for noncompliance; provided, however, that in the event a Contractor becomes involved in, or is threatened with, litigation with a subcontractor or vendor as a result of such direction by the administering agency, the Contractor may request the United States to enter into such litigation to protect the interests of the United States.

ATTACHMENT NO. 2

EACH PRIME CONTRACTOR SHALL INSERT IN EACH SUBCONTRACT THE CERTIFICATION IN APPENDIX B, AND FURTHER, SHALL REQUIRE ITS INCLUSION IN ANY LOWER TIER SUBCONTRACT, PURCHASE ORDER, OR TRANSACTION THAT MAY IN TURN BE MADE.

- Appendix B of 49 CFR Part 29 -

This certification applies to subcontractors, material suppliers, vendors and other lower tier participants.

Appendix B--Certification Regarding Debarment, Suspension, Ineligibility and Voluntary Exclusion--Lower Tier Covered Transactions

Instructions for Certification

1. By signing and submitting this proposal, the prospective lower tier participant is providing the certification set out below.

2. The certification in this clause is a material representation of fact upon which reliance was placed when this transaction was entered into. If it is later determined that the prospective lower tier participant knowingly rendered an erroneous certification, in addition to other remedies available to the Federal Government, the department or agency with which this transaction originated may pursue available remedies, including suspension and/or debarment.

3. The prospective lower tier participant shall provide immediate written notice to the person to which this proposal is submitted if at any time the prospective lower tier participant learns that its certification was erroneous when submitted or has become erroneous by reason of changed circumstances.

4. The terms "covered transaction," "debarred," "suspended," "ineligible," "lower tier covered transaction," "participant," "person," "primary covered transaction," "principal," "proposal," and "voluntarily excluded," as used in this clause sections of rules implementing Executive Order 12549. You may contact the person to which this proposal is submitted for assistance in obtaining a copy of those regulations.

5. The prospective lower tier participant agrees by submitting this proposal that, should the proposed covered transaction be entered into, it shall not knowingly enter into any lower tier covered transaction with a person who is debarred, suspended, declared ineligible, or voluntarily excluded from participation in this covered transaction, unless authorized by the department or agency with which this transaction originated.

6. The prospective lower tier participant further agrees by submitting this proposal that it will include this clause titled "Certification Regarding Debarment, Suspension, Ineligibility and Voluntary Exclusion--Lower Tier Covered Transaction," without modification, in all lower tier covered transactions and in all solicitations for lower tier covered transactions.

7. A participant in a covered transaction may rely upon a certification of a prospective participant in a lower tier covered transaction that it is not debarred, suspended, ineligible, or voluntarily excluded from the covered transaction, unless it knows that the certification is erroneous. A participant may decide the method and frequency by which it determines the eligibility of its principals. Each participant may, but is not required to, check the Nonprocurement List.

8. Nothing contained in the foregoing shall be construed to require establishment of a system of records in order to render in good faith the certification required by this clause. The knowledge and information of a participant is not required to exceed that which is normally possessed by a prudent person in the ordinary course of business dealings.

9. Except for transactions authorized under paragraph 5 of these instructions, if a participant in a covered transaction knowingly enters into a lower tier covered transaction with a person who is suspended, debarred, ineligible, or voluntarily excluded from participation in this transaction, in addition to other remedies available to the Federal Government, the department or agency with which this transaction originated may pursue available remedies, including suspension and/or debarment.

Certification Regarding Debarment, Suspension, Ineligibility and Voluntary Exclusion--Lower Tier Covered Transactions

(1) The prospective lower tier participant certifies, by submission of this proposal, that neither it nor its principals is presently debarred, suspended, proposed for debarment, declared ineligible, or voluntarily excluded from participation in this transaction by any Federal department or agency.

(2) Where the prospective lower tier participant is unable to certify to any of the statements in this certification, such prospective participant shall attach an explanation to this proposal.

STATE REQUIRED CONTRACT PROVISIONS
ALL FEDERAL-AID CONSTRUCTION CONTRACTS

Effective February 1, 1969
Revised January 2, 1973

The following provisions are State of Illinois requirements and are in addition to the Federal requirements.

"EQUAL EMPLOYMENT OPPORTUNITY"

In the event of the Contractor's noncompliance with any provisions of this Equal Employment Opportunity Clause, the Illinois Fair Employment Practices Act or the Fair Employment Practices Commission's Rules and Regulations for Public Contracts, the Contractor may be declared nonresponsible and therefore ineligible for future contracts or subcontracts with the State of Illinois or any of its political subdivisions or municipal corporations, and the contract may be canceled or avoided in whole or in part, and such other sanctions or penalties may be imposed or remedies invoked as provided by statute or regulation.

During the performance of this contract, the Contractor agrees as follows:

- (1) That it will not discriminate against any employee or applicant for employment because of race, color, religion, sex, national origin or ancestry; and further that it will examine all job classifications to determine if minority persons or women are underutilized and will take appropriate affirmative action to rectify any such underutilization.
- (2) That, if it hires additional employees in order to perform this contract or any portion hereof, it will determine the availability (in accordance with the Commission's Rules and Regulations for Public Contracts) of minorities and women in the area(s) from which it may reasonably recruit and it will hire for each job classification for which employees are hired in such a way that minorities and women are not underutilized.
- (3) That, in all solicitations or advertisements for employees placed by it or on its behalf, it will state that all applicants will be afforded equal opportunity without discrimination because of race, color, religion, sex, national origin or ancestry.
- (4) That it will send to each labor organization or representative of workers with which it has or is bound by a collective bargaining or other agreement or understanding, a notice advising such labor organization or representative of the Contractor's obligations under the Illinois Fair Employment Practices Act and the Commission's Rules and Regulations for Public Contracts. If any such labor organization or representative fails or refuses to cooperate with the Contractor in its efforts to comply with such Act and Rules and Regulations, the Contractor will promptly so notify the Illinois Fair Employment Practices Commission and the contracting agency and will recruit employees from other sources when necessary to fulfill its obligations thereunder.
- (5) That it will submit reports as required by the Illinois Fair Employment Practices Commission's Rules and Regulations for Public Contracts, furnish all relevant information as may from time to time be requested by the Commission or the contracting agency, and in all respects comply with the Illinois Fair Employment Practices Act and the Commission's Rules and Regulations for Public Contracts.
- (6) That it will permit access to all relevant books, records, accounts and work sites by personnel of the contracting agency and the Illinois Fair Employment Practices Commission for purposes of investigation to ascertain compliance with the Illinois Fair Employment Practices Act and the Commission's Rules and Regulations for Public Contracts.
- (7) That it will include verbatim or by reference the provisions of paragraphs 1 through 7 of this clause in every performance subcontract as defined in Section 2.10(b) of the Commission's Rules and Regulations for Public Contracts so that such provisions will be binding upon every subcontractor; and that it will also so include the provisions or paragraphs 1, 5, 6 and 7 in every supply subcontract as defined in Section 2.10(a) of the Commission's Rules and Regulations for Public Contracts so that such provisions will be binding upon every such subcontractor. In the same manner as with other provisions of this contract, the Contractor will be liable for compliance with applicable provisions of this clause by all its subcontractors; and further it will promptly notify the contracting agency and the Illinois Fair Employment Practices Commission in the event any subcontractor fails or refuses to comply therewith. In addition, no Contractor will utilize any subcontractor declared by the Commission to be nonresponsible and therefore ineligible for contracts or subcontracts with the State of Illinois or any of its political subdivisions or municipal corporations.

CONSTRUCTION CONTRACT PROCUREMENT POLICIES

TABLE OF CONTENTS

SECTION 1

Proposal Requirements and Conditions

SUB-SECTION

1-01 ADVERTISEMENT (Notice to Bidders).....	42
1-02 PREQUALIFICATION OF BIDDERS.....	42
1-03 CONTENTS OF PROPOSAL FORMS	43
1-04 ISSUANCE OF PROPOSAL FORMS.....	43
1-05 INTERPRETATION OF QUANTITIES IN BID SCHEDULE.....	43
1-06 EXAMINATION OF PLANS, SPECIFICATIONS, AND SITE.....	43
1-07 PREPARATION OF THE PROPOSAL	44
1-08 REJECTION OF PROPOSALS	44
1-09 PROPOSAL GUARANTY	44
1-10 DELIVERY OF PROPOSALS	45
1-11 WITHDRAWAL OF PROPOSALS.....	45
1-12 PUBLIC OPENING OF PROPOSALS.....	45
1-13 DISQUALIFICATION OF BIDDERS.....	45
1-14 WORKER'S COMPENSATION INSURANCE.....	45

SECTION 2

Award and Execution of Contract

SUB-SECTION

2-01 CONSIDERATION OF PROPOSALS	45
2-02 AWARD OF CONTRACT	46
2-03 CANCELLATION OF AWARD	46
2-04 RETURN OF PROPOSAL GUARANTY	46
2-05 REQUIREMENT OF PERFORMANCE AND PAYMENT BONDS.....	46
2-06 EXECUTION OF CONTRACT.....	46
2-07 APPROVAL OF CONTRACT	46
2-08 FAILURE TO EXECUTE CONTRACT	46

SECTION 1

PROPOSAL REQUIREMENTS AND CONDITIONS

1-01 ADVERTISEMENT (Notice to Bidders). The State of Illinois shall publish the advertisement at such places and at such times as are required by local law or ordinances. The published advertisement shall state the time and place for submitting sealed proposals; a description of the proposed work; instructions to bidders as to obtaining proposal forms, plans, and specifications; proposal guaranty required; and the Owner's right to reject any and all bids.

For Federally assisted contracts the advertisement shall conform to the requirements of local laws and ordinances pertaining to letting of contracts and, in addition, shall conform to the requirements of the appropriate parts of the Federal Aviation Regulations applicable to the particular contract being advertised.

1-02 PREQUALIFICATION OF BIDDERS.

- (a) When the awarding authority is the State of Illinois, each prospective bidder, prior to being considered for issuance of any proposal forms will be required to file, on forms furnished by the Department, an experience questionnaire and a confidential financial statement in accordance with the Department's Instructions for Prequalification of Contractors. The Statement shall include a complete report of the prospective bidder's financial resources and liabilities, equipment, past record and personnel, and must be submitted at least thirty (30) days prior to the scheduled opening of bids in which the Contractor is interested.

After the Department has analyzed the submitted "Contractor's Statement of Experience and Financial Condition" and related information and has determined appropriate ratings, the Department will issue to the Contractor a "Certificate of Eligibility". The Certificate will permit the Contractor to obtain proposal forms and plans for any Department of Transportation letting on work which is within the limits of the Contractor's potential as indicated on his "Certificate of Eligibility", subject to any limitations due to present work under contract or pending award as determined from the Contractor's submitted "Affidavit of Availability". Bidders intending to consistently submit proposals shall submit a "Contractor's Statement of Experience and Financial Condition" at least once a year. However, prequalification may be changed during that period upon the submission of additional favorable reports or upon reports of unsatisfactory performance.

Before a proposal is issued, the prospective bidder will be required to furnish an "Affidavit of Availability" indicating the location and amount of all uncompleted work under contract, or pending award, either as principal or subcontractor, as well as a listing of all subcontractors and value of work sublet to others. The prospective bidder may be requested to file a statement showing the amount and condition of equipment which will be available.

Before an award is made, the bidder may be required to furnish an outline of his plans for conducting the work.

- (b) When the awarding authority for contract construction work is the County Board of a county; the Council, the City Council, or the President and Board of Trustees of a city, village or town, each prospective bidder, in evidence of his competence, shall furnish the awarding authority as a prerequisite to the release of proposal forms by the awarding authority, a certified or photostatic copy of a "Certificate of Eligibility" issued by the Department of Transportation, in accordance with Section 1-02(a).

The two low bidders must file within 24 hours after the letting a sworn affidavit, in triplicate, showing all uncompleted contracts awarded to them and all low bids pending award for Federal, State, County, Municipal and private work, using the blank form made available for this affidavit. One copy shall be filed with the awarding authority and two copies with the District Highway Office.

1-03 CONTENTS OF PROPOSAL FORMS. Upon request, the Department will furnish the prequalified bidders a proposal form. This form will state the location and description of the contemplated construction and will show the estimate of the various quantities and kinds of work to be performed or materials to be furnished, and will have a schedule of items for which unit bid prices are invited. The proposal form will state the time in which work must be completed, the amount of the proposal guaranty, labor requirements, and date, time and place of the opening of proposals. The form will also include any special provisions or requirements which vary from or are not contained in these specifications.

All papers bound with or attached to the proposal form are considered a part thereof and must not be detached or altered when the proposal is submitted. Any addenda officially issued by the Department, will be considered a part of the proposal whether attached or not.

For Federally assisted contracts, the proposal shall conform to the requirements of local laws and ordinances pertaining to letting of contracts and, in addition, shall conform to the requirements of the appropriate parts of the Federal Aviation Regulations pertaining to the particular contract being let.

1-04 ISSUANCE OF PROPOSAL FORMS. The Department shall refuse to issue a proposal form for any of the following reasons:

- (a) Lack of competency and adequate machinery, plant and other equipment, as revealed by the financial statement and experience questionnaires required under Section 1-02(a).
- (b) Uncompleted work which, in the judgment of the Department, might hinder or prevent the prompt completion of additional work if awarded.
- (c) False information provided on a bidder's "Affidavit of Availability".
- (d) Failure to pay, or satisfactorily settle, all bills due for labor and material on former contracts in force at the time of issuance of proposal forms.
- (e) Failure to comply with any prequalification regulations of the Department.
- (f) Default under previous contracts.
- (g) Unsatisfactory performance record as shown by past work for the Department, judged from the standpoint of workmanship and progress.
- (h) When the Contractor is suspended from eligibility to bid at a public letting where the contract is awarded by, or require approval of, the Department.
- (i) When any agent, servant, or employee of the prospective bidder currently serves as a member, employee, or agent of a governmental body that is financially involved in the proposed work.
- (j) When any agent, servant, or employee of the prospective bidder has participated in the preparation of plans or specifications for the proposed work.

1-05 INTERPRETATION OF QUANTITIES IN BID SCHEDULE. An estimate of quantities of work to be done and materials to be furnished under these specifications is given in the proposal. It is the result of careful calculations and is believed to be correct. It is given only as a basis for comparison of proposals and the award of the contract. The Owner does not expressly or by implication agree that the actual quantities involved will correspond exactly therewith; nor shall the bidder plead misunderstanding or deception because of such estimates of quantities, or of the character, location, or other conditions pertaining to the work. Payment to the Contractor will be made only for the actual quantities of work performed or materials furnished in accordance with the plans and specifications. It is understood that the quantities may be increased or decreased as provided in the subsection titled ALTERATION OF WORK AND QUANTITIES of Section 20 of the Illinois Standard Specifications for Construction of Airports without in any way invalidating the unit bid prices.

1-06 EXAMINATION OF PLANS, SPECIFICATIONS, AND SITE. The bidder is expected to carefully examine the site of the proposed work, the proposal, plans, specifications, and contract forms. He shall satisfy himself as to the character, quality, and quantities of work to be performed, materials to be furnished, and as to the requirements of the proposed contract. The submission of a proposal shall be prima facie evidence that the bidder has made such examination and is satisfied as to the conditions to be encountered in performing the work and as to the requirements of the proposed contract, plans, and specifications.

Boring logs, underground utilities and other records of subsurface investigations and tests are available for inspection of bidders. It is understood and agreed that such subsurface information, whether included in the plans, specifications, or otherwise made available to the bidder, was obtained and is intended for the Owner's design and estimating purposes only. Such information has been made available for the convenience of all bidders. It is further understood and agreed that each bidder is solely responsible for all assumptions, deductions, or conclusions which he may make or obtain from his examination of the boring logs and other records of subsurface investigations and tests that are furnished by the Owner.

1-07 PREPARATION OF THE PROPOSAL. The bidder shall submit his proposal on the form furnished by the Department. The proposal shall be executed property, and bids shall be made for all items indicated in the proposal form, except that when alternate bids are asked, a bid on more than one alternate for each item is not required, unless otherwise provided. The bidder shall indicate, in figures, a unit price for each of the separate items called for in the proposal; he shall show the products of the respective quantities and unit prices in the column provided for that purpose, and the gross sum shown in the place indicated in the proposal shall be the summation of said products. All writing shall be with ink or typewriter, except the signature of the bidder which shall be written with ink.

If the proposal is made by an individual, his name and business address shall be shown. If made by a firm or partnership, the name and business address of each member of the firm or partnership shall be shown. If made by a corporation, the proposal shall show the names, titles, and business address of the president, secretary, and treasurer, and the seal of the corporation shall be affixed and attested by the secretary.

The proposal shall be issued to a prequalified bidder in the same name and style as the financial statement used for prequalification and shall be submitted in like manner.

1-08 REJECTION OF PROPOSALS. The Department reserves the right to reject proposals for any of the conditions in Article 1-04 or for any of the following reasons:

- (a) More than one proposal for the same work from an individual, firm, partnership, or corporation under the same or different names.
- (b) Evidence of collusion among bidders.
- (c) Unbalanced proposals in which the prices for some items are obviously out of proportion to the prices for other items.
- (d) If the proposal does not contain a unit price for each pay item listed except in the case of authorized alternate pay items or lump sum pay items.
- (e) If the proposal is other than that furnished by the Department; or if the form is altered or any part thereof is detached.
- (f) If there are omissions, erasures, alterations, unauthorized additions, conditional or alternate bids, or irregularities of any kind which may tend to make the proposal incomplete, indefinite, or ambiguous as to its meaning.
- (g) If the bidder adds any provisions reserving the right to accept or reject an award, or to enter into a contract pursuant to an award.
- (h) If the proposal is not accompanied by the proper proposal guaranty.
- (i) If the proposal is prepared with other than ink or typewriter.
- (j) If the proposal is submitted in any other name other than that to whom it was issued by the Department.

1-09 PROPOSAL GUARANTY. Each Proposal shall be accompanied by either a bid bond on the Department of Transportation, Division of Aeronautics form contained in the proposal, executed by a corporate surety company satisfactory to the Department or by a bank cashier's check or a properly certified check for not less than 5 percent of the amount bid.

Bank cashier's checks, or properly certified checks accompanying proposals shall be made payable to the Treasurer, State of Illinois.

1-10 DELIVERY OF PROPOSALS. Each proposal should be submitted in a special envelope furnished by the Department. The blank spaces on the envelope shall be filled in correctly to clearly indicate its contents. When an envelope other than the special one furnished by the Department is used, it shall be of the same general size and shape and be similarly marked to clearly indicate its contents. When sent by mail, the sealed proposal shall be addressed to the Department at the address and in care of the official in whose office the bids are to be received. All proposals shall be filed prior to the time and place specified in the Notice to Bidders. Proposals received after the time for opening of bids will be returned to the bidder unopened.

1-11 WITHDRAWAL OF PROPOSALS. Permission will be given a bidder to withdraw a proposal if he makes his request in writing or by telegram before the time for opening proposals. If a proposal is withdrawn, the bidder will not be permitted to resubmit this proposal at the same letting. With the approval of the Engineer, a bidder may withdraw a proposal and substitute a new proposal prior to the time of opening bids.

1-12 PUBLIC OPENING OF PROPOSALS. Proposals will be opened and read publicly at the time and place specified in the Notice to Bidders. Bidders, their authorized agents, and other interested parties are invited to be present.

1-13 DISQUALIFICATION OF BIDDERS. A bidder shall be considered disqualified for any of the following reasons:

- (a) Submitting more than one proposal from the same partnership, firm, or corporation under the same or different name.
- (b) Evidence of collusion among bidders. Bidders participating in such collusion shall be disqualified as bidders for any future work of the Owner.
- (c) If the bidder is considered to be in "default" for any reason specified in the Subsection 1-04 titled ISSUANCE OF PROPOSAL FORMS of this section.

1-14 WORKER'S COMPENSATION INSURANCE. Prior to the approval of his contract by the Division, the Contractor shall furnish to the Division certificates of insurance covering Worker's Compensation, or satisfactory evidence that this liability is otherwise taken care of in accordance with Section 4.(a) of the "Worker's Compensation Act of the State of Illinois" as amended.

SECTION 2

AWARD AND EXECUTION OF CONTRACT

2-01 CONSIDERATION OF PROPOSALS. After the proposals are publicly opened and read, they will be compared on the basis of the summation of the products obtained by multiplying the estimated quantities shown in the proposal by the unit bid prices. In the event of a discrepancy between unit bid prices and extensions, the unit bid price shall govern.

Until the award of a contract is made, the Owner reserves the right to reject a bidder's proposal for any of the following reasons:

- (a) If the proposal is irregular as specified in the subsection titled REJECTION OF PROPOSALS of Section 1.
- (b) If the bidder is disqualified for any of the reasons specified in the subsection titled DISQUALIFICATION OF BIDDERS of Section 1.

In addition, until the award of a contract is made, the Owner reserves the right to reject any or all proposals; waive technicalities, if such waiver is in the best interest of the Owner and is in conformance with applicable State and Local laws or regulations pertaining to the letting of construction contracts; advertise for new proposals; or proceed with the work otherwise.

2-02 AWARD OF CONTRACT. The award of contract will be made within 60 calendar days after the opening of proposals to the lowest responsible and qualified bidder whose proposal complies with all the requirements prescribed. The successful bidder will be notified by letter, that his bid has been accepted, and that he has been awarded the contract.

If a contract is not awarded within 60 days after the opening of proposals, a bidder may file a written request with the Division for the withdrawal of his bid and the Division will permit such withdrawal.

For Federally assisted contracts, unless otherwise specified in this subsection, no award shall be made until the FAA has concurred in the Owner's recommendation to make such award and has approved the Owner's proposal contract to the extent that such concurrence and approval are required by Federal Regulations.

2-03 CANCELLATION OF AWARD. The Division reserves the right to cancel the award without liability to the bidder at any time before a contract has been fully executed by all parties and is approved by the Owner in accordance with the subsection titled APPROVAL OF CONTRACT of this section. The Division at the time of cancellation will return the proposal guaranty.

2-04 RETURN OF PROPOSAL GUARANTY. The proposal guaranties of all except the two lowest bidders will be returned promptly after the proposals have been checked, tabulated, and the relation of the proposals established. Proposal guaranties of the two lowest bidders will be returned as soon as the Construction Contract, Performance Bonds, and Payment Bonds of the successful bidder have been properly executed and approved.

If any other form of proposal guaranty is used, other than a bid bond, a bid bond may be substituted at the Contractor's option.

2-05 REQUIREMENT OF PERFORMANCE AND PAYMENT BONDS. The successful bidder for a contract, at the time of the execution of the contract, shall deposit with the Division separate performance and payment bonds each for the full amount of the contract. The form of the bonds shall be that furnished by the Division, and the sureties shall be acceptable to the Division.

2-06 EXECUTION OF CONTRACT. The successful bidder shall sign (execute) the Contract and shall return the signed Contract to the Owner (Sponsor) for signature (execution) and subsequently return all copies to the Division. The fully executed surety bonds specified in the subsection title REQUIREMENTS OF PERFORMANCE AND PAYMENT BONDS of this section will be forwarded to the Division within 15 days of the date mailed or otherwise delivered to the successful bidder. If the Contract and Bonds are mailed, special handling is recommended.

If the bidder to whom award is to be made is a corporation organized under the laws of a State other than Illinois, the bidder shall furnish the Division a copy of the corporation's certificate of authority to do business in the State of Illinois with the return of the executed contract and bond. Failure to furnish such evidence of a certificate of authority within the time required will be considered as just cause for the annulment of the award and the forfeiture of the proposal guaranty to the State, not as a penalty, but in payment of liquidated damages sustained as a result of such failure.

2-07 APPROVAL OF CONTRACT. Upon receipt of the contract and bonds that have been executed by the successful bidder, the Owner shall complete the execution of the contract in accordance with local laws or ordinances, and return the contract to the Division for approval and execution by the Division. Delivery of the fully executed contract to the Contractor shall constitute the Department's approval to be bound by the successful bidder's proposal and the terms of the contract.

2-08 FAILURE TO EXECUTE CONTRACT. If the contract is not executed by the Division within 15 days following receipt from the bidder of the properly executed contracts and bonds, the bidder shall have the right to withdraw his bid without penalty.

Failure of the successful bidder to execute the contract and file acceptable bonds within 15 days after the contract has been mailed to him shall be just cause for the cancellation of the award and the forfeiture of the proposal guaranty which shall become the property of the State, not as a penalty, but as liquidation of damages sustained.

ILLINOIS DEPARTMENT OF TRANSPORTATION

DIVISION OF AERONAUTICS

The requirements of the following provisions written for Federally-assisted construction contracts, including all goals and timetables and affirmative action steps, shall also apply to all State-funded construction contracts awarded by the Illinois Department of Transportation.

NOTICE OF REQUIREMENT FOR AFFIRMATIVE ACTION TO ENSURE EQUAL EMPLOYMENT OPPORTUNITY (EXECUTIVE ORDER 11246)

1. The Offeror's or Bidder's attention is called to the "Equal Opportunity Clause" and the "Standard Federal Equal Employment Opportunity Construction Contract Specifications" set forth herein.

2. The goals and timetables for minority and female participation, expressed in percentage terms for the Contractor's aggregate workforce in each trade on all construction work in the covered area, are as follows:

APPENDIX A

The following goal for female utilization in each construction craft and trade shall apply to all Contractors holding Federal and federally assisted construction contracts and subcontracts in excess of \$10,000. The goal is applicable to the Contractor's total on-site construction workforce, regardless of whether or not part of that workforce is performing work on a Federal, federally assisted or nonfederally related construction contract or subcontract.

AREA COVERED (STATEWIDE)

Goals for Women apply nationwide.

GOAL

	Goal (percent)
Female Utilization.....	... 6.9

APPENDIX B

Until further notice, the following goals for minority utilization in each construction craft and trade shall apply to all Contractors holding Federal and federally-assisted construction contracts and subcontracts in excess of \$10,000. to be performed in the respective geographical areas. The goals are applicable to the Contractor's total on-site construction workforce, regardless of whether or not part of that workforce is performing work on a Federal, federally-assisted or nonfederally related construction contract or subcontract.

<u>Economic Area</u>	<u>Goal (percent)</u>
056 Paducah, KY:	
Non-SMSA Counties -	5.2
IL - Hardin, Massac, Pope	
KY - Ballard, Caldwell, Calloway, Carlisle, Crittenden,	
Fulton, Graves, Hickman, Livingston, Lyon, McCracken, Marshall	

Revised 08-31-83

<u>Economic Area</u>	<u>Goal (percent)</u>
080 Evansville, IN:	
Non-SMSA Counties -	3.5
IL - Edwards, Gallatin, Hamilton, Lawrence, Saline, Wabash, White	
IN - Dubois, Knox, Perry, Pike, Spencer	
KY - Hancock, Hopkins, McLean, Mublenberg, Ohio, Union, Webster	
081 Terre Haute, IN:	
Non-SMSA Counties -	2.5
IL - Clark, Crawford	
IN - Parke	
083 Chicago, IL:	
SMSA Counties:	19.6
1600 Chicago, IL -	
IL - Cook, DuPage, Kane, Lake, McHenry, Will	
3740 Kankakee, IL -	9.1
IL - Kankakee	
Non-SMSA Counties	18.4
IL - Bureau, DeKalb, Grundy, Iroquois, Kendall, LaSalle, Livingston, Putnam	
IN - Jasper, Laporte, Newton, Pulaski, Starke	
084 Champaign - Urbana, IL:	
SMSA Counties:	
1400 Champaign - Urbana - Rantoul, IL -	7.8
IL - Champaign	
Non-SMSA Counties -	4.8
IL - Coles, Cumberland, Douglas, Edgar, Ford, Piatt, Vermilion	
085 Springfield - Decatur, IL:	
SMSA Counties:	
2040 Decatur, IL -	7.6
IL - Macon	
7880 Springfield, IL -	4.5
IL - Mendard, Sangamon	
Non-SMSA Counties	4.0
IL - Cass, Christian, Dewitt, Logan, Morgan, Moultrie, Scott, Shelby	
086 Quincy, IL:	
Non-SMSA Counties	3.1
IL - Adams, Brown, Pike	
MO - Lewis, Marion, Pike, Ralls	
087 Peoria, IL:	
SMSA Counties:	
1040 Bloomington - Normal, IL -	2.5
IL - McLean	

Revised 08-31-83

APPENDIX B (CONTINUED)

<u>Economic Area</u>	<u>Goal (percent)</u>
6120 Peoria, IL - IL - Peoria, Tazewell, Woodford	4.4
Non-SMSA Counties - IL - Fulton, Knox, McDonough, Marshall, Mason, Schuyler, Stark, Warren	3.3
088 Rockford, IL: SMSA Counties: 6880 Rockford, IL - IL - Boone, Winnebago	6.3
Non-SMSA Counties - IL - Lee, Ogle, Stephenson	4.6
098 Dubuque, IA: Non-SMSA Counties - IL - JoDaviess IA - Atlamaakee, Clayton, Delaware, Jackson, Winnesheik WI - Crawford, Grant, Lafayette	0.5
099 Davenport, Rock Island, Moline, IA - IL: SMSA Counties: 1960 Davenport, Rock Island, Moline, IA - IL - IL - Henry, Rock Island IA - Scott	4.6
Non-SMSA Counties - IL - Carroll, Hancock, Henderson, Mercer, Whiteside IA - Clinton, DesMoines, Henry, Lee, Louisa, Muscatine MO - Clark	3.4
107 St. Louis, MO: SMSA Counties: 7040 St. Louis, MO - IL - IL - Clinton, Madison, Monroe, St. Clair MO - Franklin, Jefferson, St. Charles, St. Louis, St. Louis City	14.7
Non-SMSA Counties - IL - Alexander, Bond, Calhoun, Clay, Effingham, Fayette, Franklin, Greene, Jackson, Jasper, Jefferson, Jersey, Johnson, Macoupin, Marion, Montgomery, Perry, Pulaski, Randolph, Richland, Union, Washington, Wayne, Williamson MO - Bollinger, Butler, Cape Girardeau, Carter, Crawford, Dent, Gasconade, Iron, Lincoln, Madison, Maries, Mississippi, Montgomery, Perry, Phelps, Reynolds, Ripley, St. Francois, St. Genevieve, Scott, Stoddard, Warren, Washington, Wayne	11.4

Revised 08-31-83

These goals are applicable to all the Contractor's construction work (whether or not it is Federal or federally assisted) performed in the covered area. If the Contractor performs construction work in a geographical area located outside of the covered area, it shall apply the goals established for such geographical area where the work is actually performed. With regard to this second area, the Contractor also is subject to the goals for both its federally involved and nonfederally involved construction.

The Contractor's compliance with Executive Order and the regulations in 41 CFR Part 60-4 shall be based on its implementation of the Equal Opportunity Clause, specific affirmative action obligations required by the provisions and specifications set forth in its federally assisted contracts, and its efforts to meet the goals established for the geographical area where the contract resulting from this solicitation is to be performed. The hours of minority and female employment and training must be substantially uniform throughout the length of the contract, and in each trade, and the Contractor shall make a good faith effort to employ minorities and women evenly on each of its projects. The transfer of minority or female employees or trainees from Contractor to Contractor or from project to project for the sole purpose of meeting the Contractor's goals shall be a violation of the contract, the Executive Order and the regulations in 41 CFR Part 60-4. Compliance with the goals will be measured against the total work hours performed.

3. The Illinois Division of Aeronautics will provide written notification to the Director of the Office of Federal Contract Compliance Programs within 10 working days of award of any construction contract and/or subcontract in excess of \$10,000 at any tier for construction work under the contract resulting from this solicitation. This notification will list the name, address and telephone number of the subcontractor; employer identification number; estimated dollar amount of the subcontract; estimated starting and completion dates of the subcontract; and the geographical area in which the contract is to be performed.

4. As used in this Notice, and in the contract resulting from this solicitation, the "covered area" is the entire State of Illinois for the goal set forth in APPENDIX A and the county or counties in which the work is located for the goals set forth in APPENDIX B.

STANDARD FEDERAL EQUAL EMPLOYMENT
OPPORTUNITY CONSTRUCTION CONTRACT
SPECIFICATIONS (EXECUTIVE ORDER 11246)

1. As used in these specifications:
 - a) "Covered area" means the geographical area described in the solicitation from which this contract resulted;
 - b) "Director" means Director, Office of Federal Contract Compliance Programs, United States Department of Labor, or any person to whom the Director delegates authority;
 - c) "Employer identification number" means the Federal Social Security number used on the Employer's Quarterly Federal Tax Return, U.S. Treasury Department Form 941;
 - d) "Minority" includes:
 - (i) Black (all persons having origins in any of the Black African racial groups not of Hispanic origin);
 - (ii) Hispanic (all persons of Mexican, Puerto Rican, Cuban, Central or South American or other Spanish Culture or origin, regardless of race);
 - (iii) Asian and Pacific Islander (all persons having origins in any of the original peoples of the Far East, Southeast Asia, the Indian Subcontinent, or the Pacific Islands); and
 - (iv) American Indian or Alaskan Native (all persons having origins in any of the original peoples of North America and maintaining identifiable tribal affiliations through membership and participation or community identification).
2. Whenever the Contractor, or any Subcontractor at any tier, subcontracts a portion of the work involving any construction trade, it shall physically include in each subcontract in excess of \$10,000. the provisions of these specifications and the Notice which contains the applicable goals for minority and female participation and which is set forth in the solicitations from which this contract resulted.

Revised 08-31-83

3. If the Contractor is participating (pursuant to 41 CFR 60-4.5) in a Hometown Plan approved by the U.S. Department of Labor in the covered area either individually or through an association, its affirmative action obligations on all work in the plan area (including goals and timetables) shall be in accordance with that Plan for those trades which have unions participating in the Plan. Contractors must be able to demonstrate their participation in and compliance with the provisions of any such Hometown Plan. Each Contractor or Subcontractor participating in an approved Plan is individually required to comply with its obligations under the EEO clause, and to make a good faith effort to achieve each goal under the Plan in each trade in which it has employees. The overall good faith performance by other Contractors or Subcontractors toward a goal in an approved Plan does not excuse any covered Contractor's or Subcontractor's failure to take good faith efforts to achieve the Plan goals and timetables.
4. The Contractor shall implement the specific affirmative action standards provided in paragraphs 7a through p of these specifications. The goals set forth in the solicitation from which this contract resulted are expressed as percentages of the total hours of employment and training of minority and female utilization the Contractor should reasonably be able to achieve in each construction trade in which it has employees in the covered area. Covered Construction Contractors performing construction work in geographical areas where they do not have a Federal or federally assisted construction contract shall apply the minority and female goals established for the geographical area where the work is being performed. Goals are published periodically in the Federal Register in notice form, and such notices may be obtained from any Office of Federal Contract Compliance Programs office or from Federal procurement contracting officers. The Contractor is expected to make substantially uniform progress toward its goals in each craft during the period specified.
5. Neither the provisions of any collective bargaining agreement, nor the failure by a union with whom the Contractor has a collective bargaining agreement, to refer either minorities or women shall excuse the Contractor's obligations under these specifications, Executive Order 11246, or the regulations promulgated pursuant thereto.
6. In order for the nonworking training hours of apprentices and trainees to be counted in meeting the goals, such apprentices and trainees must be employed by the Contractor during the training period, and the Contractor must have made a commitment to employ the apprentices and trainees at the completion of their training, subject to the availability of employment opportunities. Trainees must be trained pursuant to training programs approved by the U.S. Department of Labor.
7. The Contractor shall take specific affirmative actions to ensure equal employment opportunity. The evaluation of the Contractor's compliance with these specifications shall be based upon its effort to achieve maximum results from its actions. The Contractor shall document these efforts fully, and shall implement affirmative action steps at least as extensive as the following:
 - a) Ensure and maintain a working environment free of harassment, intimidation, and coercion at all sites, and in all facilities at which the Contractor's employees are assigned to work. The Contractor, where possible, will assign two or more women to each construction project. The Contractor shall specifically ensure that all foremen, superintendents, and other on-site supervisory personnel are aware of and carry out the Contractor's obligation to maintain such a working environment, with specific attention to minority or female individuals working as such sites or in such facilities.
 - b) Establish and maintain a current list of minority and female recruitment sources, provide written notification to minority and female recruitment sources and to community organizations when the Contractor or its unions have employment opportunities available, and maintain a record of the organizations' responses.
 - c) Maintain a current file of the names, addresses and telephone numbers of each minority and female off-the-street applicant and minority or female referral from a union, a recruitment source or community organization and of what action was taken with respect to each such individual. If such individual was sent to the union hiring hall for referral and was not referred back to the Contractor by the union or, if referred, not employed by the Contractor, this shall be documented in the file with the reason therefor, along with whatever additional actions the Contractors may have taken.

Revised 08-31-83

- d) Provide immediate written notification to the Director when the union or unions with which the Contractor has a collective bargaining agreement has not referred to the Contractor a minority person or woman sent by the Contractor, or when the Contractor has other information that the union referral process has impeded the Contractor's efforts to meet its obligations.
- e) Develop on-the-job training opportunities and/or participate in training programs for the area which expressly include minorities and women, including upgrading programs and apprenticeship and trainee programs relevant to the Contractor's employment needs, especially those programs funded or approved by the Department of Labor. The Contractor shall provide notice of these programs to the sources compiled under 7b above.
- f) Disseminate the Contractor's EEO policy by providing notice of the policy to unions and training programs and requesting their cooperation in assisting the Contractor in meeting its EEO obligations; by including it in any policy manual and collective bargaining agreements; by publicizing it in the company newspaper, annual report, etc.; by specific review of the policy with all management personnel and with all minority and female employees at least once a year; and by posting the company EEO policy on bulletin boards accessible to all employees at each location where construction work is performed.
- g) Review, at least annually, the company's EEO policy and affirmative action obligations under these specifications with all employees having any responsibility for hiring, assignment, layoff, termination or other employment decisions including specific review of these items with onsite supervisory personnel such as Superintendents, General Foreman, etc., prior to the initiation of construction work at any job site. A written record shall be made and maintained identifying the time and place of these meetings, persons attending, subject matter discussed, and disposition of the subject matter.
- h) Disseminate the Contractor's EEO policy externally by including it in any advertising in the news media, specifically including minority and female news media, and providing written notification to and discussing the Contractor's EEO policy with other Contractors and Subcontractors with whom the Contractor does or anticipates doing business.
- i) Direct its recruitment efforts, both oral and written, to minority, female and community organizations, to schools with minority and female students and to minority and female recruitment and training organizations serving the Contractor's recruitment area and employment needs. Not later than one month prior to the date for the acceptance of applications for apprenticeship or other training by any recruitment source, the Contractor shall send written notification to organizations such as the above, describing the openings, screening procedures, and tests to be used in the selection process.
- j) Encourage present minority and female employees to recruit other minority persons and women and, where reasonable, provide after school, summer and vacation employment to minority and female youth both on the site and in other areas of a Contractor's workforce.
- k) Validate all tests and other selection requirements where there is an obligation to do so under 41 CFR Part 60-3.
- l) Conduct, at least annually, an inventory and evaluation at least of all minority and female personnel for promotional opportunities and encourage these employees to seek or to prepare for, through appropriate training, etc., such opportunities.
- m) Ensure that seniority practices, job classifications, work assignments and other personnel practices, do not have a discriminatory effect by continually monitoring all personnel and employment related activities to ensure that the EEO policy and the Contractor's obligations under these specifications are being carried out.
- n) Ensure that all facilities and company activities are nonsegregated except that separate or single-user toilet and necessary changing facilities shall be provided to assure privacy between the sexes.
- o) Document and maintain a record of all solicitations of offers for subcontracts from minority and female construction Contractors and suppliers, including circulation of solicitations to minority and female Contractor associations and other business associations.

Revised 08-31-83

- p) Conduct a review, at least annually, of all supervisors' adherence to and performance under the Contractor's EEO policies and affirmative action obligations.
8. Contractors are encouraged to participate in voluntary associations which assist in fulfilling one or more of their affirmative action obligations (7a through p). The efforts of a Contractor association, joint Contractor-union, Contractor-community, or other similar group of which the Contractor is a member and participant, may be asserted as fulfilling any one or more of its obligations under 7a through p of these Specifications provided that the Contractor actively participates in the group, makes every effort to assure that the group has a positive impact on the employment of minorities and women in the industry, ensures that the concrete benefits of the program are reflected in the Contractor's minority and female workforce participation makes a good faith effort to meet its individual goals and timetables, and can provide access to documentation which demonstrates the effectiveness of actions taken on behalf of the Contractor. The obligation to comply, however, is the Contractor's and failure of such a group to fulfill an obligation shall not be a defense for the Contractor's noncompliance.
9. A single goal for minorities and a separate single goal for women have been established. The Contractor, however, is required to provide equal employment opportunity and to take affirmative action for all minority groups, both male and female, and all women, both minority and non-minority. Consequently, the Contractor may be in violation of the Executive Order if a particular group is employed in a substantially disparate manner (for example, even though the Contractor has achieved its goals for women generally, the Contractor may be in violation of the Executive Order if a specified minority group of women is underutilized).
10. The Contractor shall not use the goals and timetables or affirmative action standards to discriminate against any person because of race, color, religion, sex, or national origin.
11. The Contractor shall not enter into any Subcontract with any person or firm debarred from Government contracts pursuant to Executive Order 11246.
12. The Contractor shall carry out such sanctions and penalties for violation of these specifications and of the Equal Opportunity Clause, including suspension, termination and cancellation of existing subcontracts as may be imposed or ordered pursuant to Executive Order 11246, as amended, and its implementing regulations, by the Office of Federal Contract Compliance Programs. Any Contractor who fails to carry out such sanctions and penalties shall be in violation of these specifications and Executive Order 11246, as amended.
13. The Contractor, in fulfilling its obligations under these specifications, shall implement specific affirmative action steps, at least as extensive as those standards prescribed in paragraph 7 of these specifications, so as to achieve maximum results from its efforts to ensure equal opportunity. If the Contractor fails to comply with the requirements of the Executive Order, the implementing regulations, or these specifications, the Director shall proceed in accordance with 41 CFR 60-4.8.
14. The Contractor shall designate a responsible official to monitor all employment related activity to ensure that the company EEO policy is being carried out, to submit reports relating to the provisions hereof as may be required by the Government and to keep records. Records shall at least include for each employee the name, address, telephone numbers, construction trade, union affiliation if any, employee identification number when assigned, social security number, race, sex, status (e.g., mechanic, apprentice, trainee, helper, or laborer), dates of changes in status, hours worked per week in the indicated trade, rate of pay, and locations at which the work was performed. Records shall be maintained in an easily understandable and retrievable form; however, to the degree that existing records satisfy his requirement, Contractors shall not be required to maintain separate records.
15. Nothing herein provided shall be construed as a limitation upon the application of other laws which establish different standards of compliance or upon the application of requirements for the hiring of local or other area residents (e.g., those under the Public Works Employment Act of 1977 and the Community Development Block Grant Program).

Revised 08-31-83

ANNUAL EEO-1 REPORT TO JOINT REPORTING COMMITTEE AS REQUIRED AT

41 CFR 60-1.7(a)

Any Contractor having a Federal contract of \$50,000 or more and 50 or more employees is required to file annual compliance reports on Standard Form 100 (EEO-1) with the Joint Reporting Committee in accordance with the instructions provided with the form. The Contractor will provide a copy of such a report to the contracting agency within 30 days after the award of a contract.

The Contractor shall require its subcontractors to file an SF 100 within 30 days after award of the subcontract if (1) it is not exempt from the provisions of these regulations in accordance with 60-1.5, (2) has 50 or more employees, (3) first tier subcontractor, and (4) has a subcontract amounting to \$50,000 or more.

Subcontractors below the first tier which perform construction work at the site of construction shall be required to file such a report if (1) it is not exempt from the provisions of these regulations in accordance with 60-1.5, (2) has 50 or more employees and has a subcontract amounting to \$50,000 or more.

The SF 100 is available at the following address:

Joint Reports Committee
EEOC - Survey Division
1801 "L" Street N.W.
Washington, D.C. 20750

Phone (202) 663-4968

DISADVANTAGED BUSINESS POLICY

I. NOTICE

This proposal contains the special provision entitled "Required Disadvantaged Business Participation." Inclusion of this Special Provision in this contract satisfies the obligations of the Department of Transportation under federal law as implemented by 49 CFR 23 and under the Illinois "Minority and Female Business Enterprise Act."

II. POLICY

It is public policy that the businesses defined in 49 CFR Part 23 shall have the maximum opportunity to participate in the performance of contracts financed in whole or in part with State or Federal funds. Consequently, the requirements of 49 CFR Part 23 apply to this contract.

III. OBLIGATION

The Contractor agrees to ensure that the businesses defined in 49 CFR Part 23 have the maximum opportunity to participate in the performance of this contract. In this regard, the Contractor shall take all necessary and reasonable steps, in accordance with 49 CFR Part 23, to ensure that the said businesses have the maximum opportunity to compete for and perform portions of this contract. The Contractor shall not discriminate on the basis of race, color, national origin, or sex in the selection and retention of subcontractors, including procurement of materials and leases of equipment.

The Contractor shall include the above Policy and Obligation statements of this Special Provision in every subcontract, including procurement of materials and leases of equipment.

IV. DBE/WBE CONTRACTOR FINANCE PROGRAM

On contracts where a loan has been obtained through the DBE/WBE Contractor Finance Program, the Contractor shall cooperate with the Department by making all payments due to the DBE/WBE Contractor by means of a two-payee check payable to the Lender (Bank) and the Borrower (DBE/WBE Contractor).

V. BREACH OF CONTRACT

Failure to carry out the requirements set forth above and in the Special Provision shall constitute a breach of contract and may result in termination of the contract or liquidated damages as provided in the special provision.

(Rev. 9/21/92)

State of Illinois
Department of Transportation

SPECIAL PROVISION
FOR
DISADVANTAGED BUSINESS ENTERPRISE PARTICIPATION

- I. FEDERAL OBLIGATION: The Department of Transportation, as a recipient of federal financial assistance, is required to take all necessary and reasonable steps to ensure nondiscrimination in the award and administration of contracts. Consequently, the federal regulatory provisions of 49 CFR part 26 apply to this contract concerning the utilization of disadvantaged business enterprises. This Special Provision will also be used by the Department to satisfy the requirements of the Business Enterprise for Minorities, Females, and Persons with Disabilities Act, 30 ILCS 575. For the purposes of this Special Provision, a disadvantaged business enterprise (DBE) means a business certified by the Department in accordance with the requirements of 49 CFR part 26 and listed in the DBE Directory or most recent addendum.
- II. CONTRACTOR ASSURANCE: The Contractor makes the following assurance and agrees to include the assurance in each subcontract that the Contractor signs with a subcontractor:
- The contractor, subrecipient or subcontractor shall not discriminate on the basis of race, color, national origin, or sex in the performance of this contract. The contractor shall carry out applicable requirements of 49 CFR part 26 in the award and administration of federally-assisted contracts. Failure by the contractor to carry out these requirements is a material breach of this contract, which may result in the termination of this contract or such other remedy as the recipient deems appropriate.
- III. OVERALL GOAL SET FOR THE DEPARTMENT: As a requirement of compliance with 49 CFR part 26, the Department has set an overall goal for DBE participation in its federally assisted contracts. That goal is 22.77% of all federal-aid funds the Department will expend in its federally assisted contracts for the subject reporting fiscal year. The Department is required to make a good faith effort to achieve this goal. The dollar amount paid to all approved DBE firms performing work called for in this contract is eligible to be credited toward fulfillment of the Department's overall goal.
- IV. CONTRACT GOAL TO BE ACHIEVED BY THE CONTRACTOR: This contract includes a specific DBE utilization goal established by the Department. The goal has been included because the Department has determined that the work of this contract has subcontracting opportunities that may be suitable for performance by DBE companies. This determination is based on an assessment of the type of work, the location of the work, and the availability of DBE companies to do a part of the work. The assessment indicates that, in the absence of unlawful discrimination, and in an arena of fair and open competition, DBE companies can be expected to perform 12.0% of the work. This percentage is set as the DBE participation goal for this contract. Consequently, in addition to the other award criteria established for this contract, the Department will award this contract to a bidder who makes a good faith effort to meet this goal of DBE participation in the performance of the work. A bidder makes a good faith effort for award consideration if either of the following is done in accordance with the procedures set forth in this Special Provision:
- A. The bidder documents that firmly committed DBE participation has been obtained to meet the goal; or
- B. The bidder documents that a good faith effort has been made to meet the goal, even though the effort did not succeed in obtaining enough DBE participation to meet the goal.

- V. DBE LOCATOR REFERENCES: Bidders may consult the DBE Directory as a reference source for DBE companies certified by the Department. In addition, the Department maintains a letting and item specific DBE locator information system whereby DBE companies can register their interest in providing quotes on particular bid items advertised for letting. Information concerning DBE companies willing to quote work for particular contracts may be obtained by contacting the Department's Bureau of Small Business Enterprises at telephone number (217)785-4611, or by visiting the Department's web site at www.dot.state.il.us.
- VI. BIDDING PROCEDURES: Compliance with the bidding procedures of this Special Provision is required prior to the award of the contract and the failure of the as-read low bidder to comply will render the bid nonresponsive.
- A. In order to assure the timely award of the contract, the as-read low bidder must submit a Disadvantaged Business Utilization Plan on Department form SBE 2026 within seven (7) working days after the date of letting. To meet the seven (7) day requirement, the bidder may send the Plan by certified mail or delivery service within the seven (7) working day period. If a question arises concerning the mailing date of a Plan, the mailing date will be established by the U.S. Postal Service postmark on the original certified mail receipt from the U.S. Postal Service or the receipt issued by a delivery service. It is the responsibility of the as-read low bidder to ensure that the postmark or receipt date is affixed within the seven (7) working days if the bidder intends to rely upon mailing or delivery to satisfy the submission day requirement. The Plan is to be submitted to the Department of Transportation, Bureau of Small Business Enterprises, Contract Compliance Section, 2300 South Dirksen Parkway, Room 319, Springfield, Illinois 62764 (Telefax: (217) 785-1524). It is the responsibility of the bidder to obtain confirmation of telefax delivery. The Department will not accept a Utilization Plan if it does not meet the seven (7) day submittal requirement, and the bid will be declared nonresponsive. In the event the bid is declared nonresponsive due to a failure to submit a Plan or failure to comply with the bidding procedures set forth herein, the Department may elect to cause the forfeiture of the penal sum of the bidder's proposal guaranty, and may deny authorization to bid the project if re-advertised for bids. The Department reserves the right to invite any other bidder to submit a Utilization Plan at any time for award consideration or to extend the time for award.
- B. The Utilization Plan shall indicate that the bidder either has obtained sufficient DBE participation commitments to meet the contract goal or has not obtained enough DBE participation commitments in spite of a good faith effort to meet the goal. The Utilization Plan shall further provide the name, telephone number and telefax number of a responsible official of the bidder designated for purposes of notification of plan approval or disapproval under the procedures of this Special Provision.
- C. The Utilization Plan shall include a DBE Participation Commitment Statement, Department form SBE 2025, for each DBE proposed for the performance of work to achieve the contract goal. The signatures on these forms must be original signatures. All elements of information indicated on the said form shall be provided, including but not limited to the following:
1. The name and address of each DBE to be used;
 2. A description, including pay item numbers, of the commercially useful work to be done by each DBE;
 3. The price to be paid to each DBE for the identified work specifically stating the quantity, unit price and total subcontract price for the work to be completed by the DBE. If partial pay items are to be performed by the DBE, indicate the portion of each item, a unit price where appropriate and the subcontract price amount;
 4. A commitment statement signed by the bidder and each DBE evidencing availability and intent to perform commercially useful work on the project; and
 5. If the bidder is a joint venture comprised of DBE firms and non-DBE firms, the plan must also include a clear identification of the portion of the work to be performed by the DBE partner(s).

D. The contract will not be awarded until the Utilization Plan submitted by the bidder is approved. The Utilization Plan will be approved by the Department if the Plan commits sufficient commercially useful DBE work performance to meet the contract goal. The Utilization Plan will not be approved by the Department if the Plan does not commit sufficient DBE performance to meet the contract goal unless the bidder documents that it made a good faith effort to meet the goal. The good faith procedures of Section VIII of this special provision apply. If the Utilization Plan is not approved because it is deficient in a technical matter, unless waived by the Department, the bidder will be notified and will be allowed no less than a five (5) working day period in order to cure the deficiency.

VII. CALCULATING DBE PARTICIPATION: The Utilization Plan values represent work anticipated to be performed and paid for upon satisfactory completion. The Department is only able to count toward the achievement of the overall goal and the contract goal the value of payments made for the work actually performed by DBE companies. In addition, a DBE must perform a commercially useful function on the contract to be counted. A commercially useful function is generally performed when the DBE is responsible for the work and is carrying out its responsibilities by actually performing, managing, and supervising the work involved. The Department and Contractor are governed by the provisions of 49 CFR part 26.55(c) on questions of commercially useful functions as it affects the work. Specific counting guidelines are provided in 49 CFR part 26.55, the provisions of which govern over the summary contained herein.

A. DBE as the Contractor: 100% goal credit for that portion of the work performed by the DBE's own forces, including the cost of materials and supplies. Work that a DBE subcontracts to a non-DBE firm does not count toward the DBE goals.

B. DBE as a joint venture Contractor: 100% goal credit for that portion of the total dollar value of the contract equal to the distinct, clearly defined portion of the work performed by the DBE's own forces.

C. DBE as a subcontractor: 100% goal credit for the work of the subcontract performed by the DBE's own forces, including the cost of materials and supplies. Work that a DBE subcontractor in turn subcontracts to a non-DBE firm does not count toward the DBE goal.

D. DBE as a trucker: 100% goal credit for trucking participation provided the DBE is responsible for the management and supervision of the entire trucking operation for which it is responsible. At least one truck owned, operated, licensed and insured by the DBE must be used on the contract. Credit will be given for the full value of all such DBE trucks operated using DBE employed drivers. Goal credit will be limited to the value of the reasonable fee or commission received by the DBE if trucks are leased from a non-DBE company.

E. DBE as a material supplier:

1. 60% goal credit for the cost of the materials or supplies purchased from a DBE regular dealer.
2. 100% goal credit for the cost of materials or supplies obtained from a DBE manufacturer.
3. 100% credit for the value of reasonable fees and commissions for the procurement of materials and supplies if not a regular dealer or manufacturer.

VIII. GOOD FAITH EFFORT PROCEDURES: If the bidder cannot obtain sufficient DBE commitments to meet the contract goal, the bidder must document in the Utilization Plan the good faith efforts made in the attempt to meet the goal. This means that the bidder must show that all necessary and reasonable steps were taken to achieve the contract goal. Necessary and reasonable steps are those which could reasonably be expected to obtain sufficient DBE participation. The Department will consider the quality, quantity and intensity of the kinds of efforts that the bidder has made. Mere *pro forma* efforts are not good faith efforts; rather, the bidder is expected to have taken those efforts that would be reasonably expected of a bidder actively and aggressively trying to obtain DBE participation sufficient to meet the contract goal.

- A. The following is a list of types of action that the Department will consider as part of the evaluation of the bidder's good faith efforts to obtain participation. These listed factors are not intended to be a mandatory checklist and are not intended to be exhaustive. Other factors or efforts brought to the attention of the Department may be relevant in appropriate cases, and will be considered by the Department.
1. Soliciting through all reasonable and available means (e.g. attendance at pre-bid meetings, advertising and/or written notices) the interest of all certified DBE companies that have the capability to perform the work of the contract. The bidder must solicit this interest within sufficient time to allow the DBE companies to respond to the solicitation. The bidder must determine with certainty if the DBE companies are interested by taking appropriate steps to follow up initial solicitations.
 2. Selecting portions of the work to be performed by DBE companies in order to increase the likelihood that the DBE goals will be achieved. This includes, where appropriate, breaking out contract work items into economically feasible units to facilitate DBE participation, even when the prime contractor might otherwise prefer to perform these work items with its own forces.
 3. Providing interested DBE companies with adequate information about the plans, specifications, and requirements of the contract in a timely manner to assist them in responding to a solicitation.
 4. (a) Negotiating in good faith with interested DBE companies. It is the bidder's responsibility to make a portion of the work available to DBE subcontractors and suppliers and to select those portions of the work or material needs consistent with the available DBE subcontractors and suppliers, so as to facilitate DBE participation. Evidence of such negotiation includes the names, addresses, and telephone numbers of DBE companies that were considered; a description of the information provided regarding the plans and specifications for the work selected for subcontracting; and evidence as to why additional agreements could not be reached for DBE companies to perform the work.

(b) A bidder using good business judgment would consider a number of factors in negotiating with subcontractors, including DBE subcontractors, and would take a firm's price and capabilities as well as contract goals into consideration. However, the fact that there may be some additional costs involved in finding and using DBE companies is not in itself sufficient reason for a bidder's failure to meet the contract DBE goal, as long as such costs are reasonable. Also, the ability or desire of a prime contractor to perform the work of a contract with its own organization does not relieve the bidder of the responsibility to make good faith efforts. Prime contractors are not, however, required to accept higher quotes from DBE companies if the price difference is excessive or unreasonable.
 5. Not rejecting DBE companies as being unqualified without sound reasons based on a thorough investigation of their capabilities. The contractor's standing within its industry, membership in specific groups, organizations, or associations and political or social affiliations (for example union vs. non-union employee status) are not legitimate causes for the rejection or non-solicitation of bids in the contractor's efforts to meet the project goal.
 6. Making efforts to assist interested DBE companies in obtaining bonding, lines of credit, or insurance as required by the recipient or contractor.
 7. Making efforts to assist interested DBE companies in obtaining necessary equipment, supplies, materials, or related assistance or services.
 8. Effectively using the services of available minority/women community organizations; minority/women contractors' groups; local, state, and Federal minority/women business assistance offices; and other organizations as allowed on a case-by-case basis to provide assistance in the recruitment and placement of DBE companies.
- B. If the Department determines that the Contractor has made a good faith effort to secure the work commitment of DBE companies to meet the contract goal, the Department will award the contract provided that it is otherwise eligible for award. If the Department determines that a good faith effort has not been made, the Department will notify the bidder of that preliminary determination by contacting the responsible company official designated in the Utilization Plan. The preliminary determination shall include a statement of reasons why good faith efforts have not been found, and may include additional good faith efforts that the bidder could take. The notification will

designate a five (5) working day period during which the bidder shall take additional efforts. The bidder is not limited by a statement of additional efforts, but may take other action beyond any stated additional efforts in order to obtain additional DBE commitments. The bidder shall submit an amended Utilization Plan if additional DBE commitments to meet the contract goal are secured. If additional DBE commitments sufficient to meet the contract goal are not secured, the bidder shall report the final good faith efforts made in the time allotted. All additional efforts taken by the bidder will be considered as part of the bidder's good faith efforts. If the bidder is not able to meet the goal after taking additional efforts, the Department will make a pre-final determination of the good faith efforts of the bidder and will notify the designated responsible company official of the reasons for an adverse determination.

- C. The bidder may request administrative reconsideration of a pre-final determination adverse to the bidder within the five (5) working days after the notification date of the determination by delivering the request to the Department of Transportation, Division of Aeronautics, 1 Langhorne Bond Drive, Capital Airport, Springfield, IL 62707-8415 (Telefax: 217-785-4533). Deposit of the request in the United States mail on or before the fifth business day shall not be deemed delivery. The pre-final determination shall become final if a request is not made and delivered. A request may provide additional written documentation and/or argument concerning the issue of whether an adequate good faith effort was made to meet the contract goal. In addition, the request shall be considered a consent by the bidder to extend the time for award. The request will be forwarded to the Department's Reconsideration Officer. The Reconsideration Officer will extend an opportunity to the bidder to meet in person in order to consider all issues of whether the bidder made a good faith effort to meet the goal. After the review by the Reconsideration Officer, the bidder will be sent a written decision within ten (10) working days after receipt of the request for reconsideration, explaining the basis for finding that the bidder did or did not meet the goal or make adequate good faith efforts to do so. A final decision by the Reconsideration Officer that a good faith effort was made shall approve the Utilization Plan submitted by the bidder and shall clear the contract for award. A final decision that a good faith effort was not made shall render the bid nonresponsive.

IX. CONTRACT COMPLIANCE: Compliance with this Special Provision is an essential part of the contract. The Department is prohibited by federal regulations from crediting the participation of a DBE included in the Utilization Plan toward either the contract goal or the Department's overall goal until the amount to be applied toward the goals has been paid to the DBE. The following administrative procedures and remedies govern the compliance by the Contractor with the contractual obligations established by the Utilization Plan. After approval of the Plan and award of the contract, the Utilization Plan and individual DBE Participation Statements become part of the contract. If the contractor did not succeed in obtaining enough DBE participation to achieve the advertised contract goal, and the Utilization Plan was approved and contract awarded based upon a determination of good faith, the total dollar value of DBE work calculated in the approved Utilization Plan as a percentage of the awarded contract value shall become the amended contract goal.

- A. No amendment to the Utilization Plan may be made without prior written approval from the Division of Aeronautics. All requests for amendment to the Utilization Plan shall be submitted to the Department of Transportation, Division of Aeronautics, 1 Langhorne Bond Drive, Capital Airport, Springfield, IL 62707-8415. Telephone number (217) 785-8514. Telefax number (217) 785-4533.
- B. All work indicated for performance by an approved DBE shall be performed, managed and supervised by the DBE executing the Participation Statement. The Contractor shall not terminate for convenience a DBE listed in the Utilization Plan and then perform the work of the terminated DBE with its own forces, those of an affiliate or those of another subcontractor, whether DBE or not, without first obtaining the written consent of the Bureau of Small Business Enterprises to amend the Utilization Plan. If a DBE listed in the Utilization Plan is terminated for reasons other than convenience, or fails to complete its work on the contract for any reason, the Contractor shall make good faith efforts to find another DBE to substitute for the terminated DBE. The good faith efforts shall be directed at finding another DBE to perform at least the same amount of work under the contract as the DBE that was terminated, but only to the extent needed to meet the contract goal or the amended contract goal. The Contractor shall notify the Division of Aeronautics of any termination for reasons other than convenience, and shall obtain approval for inclusion of the substitute DBE in the Utilization Plan. If good faith efforts following a termination of a DBE for cause are not successful, the Contractor shall contact the Division and provide a full accounting of the efforts undertaken to obtain substitute DBE participation. The Division will evaluate the good faith efforts in light of all circumstances surrounding the performance status of the contract, and determine whether the contract goal should be amended.

- C. The Contractor shall maintain a record of payments for work performed to the DBE participants. The records shall be made available to the Department for inspection upon request. After the performance of the final item of work or delivery of material by a DBE and final payment therefor to the DBE by the Contractor, but not later than thirty (30) calendar days after payment has been made by the Department to the Contractor for such work or material without regard to any retainage withheld by the Department, the Contractor shall submit a DBE Payment Report on Department form SBE 2115 to the Division's Chief Engineer. If full and final payment has not been made to the DBE, the Report shall indicate whether a disagreement as to the payment required exists between the Contractor and the DBE or if the Contractor believes that the work has not been satisfactorily completed. If the Contractor does not have the full amount of work indicated in the Utilization Plan performed by the DBE companies indicated in the Plan, the Department will deduct from contract payments to the Contractor the amount of the goal not achieved as liquidated and ascertained damages.

- D. The Department reserves the right to withhold payment to the Contractor to enforce the provisions of this Special Provision. Final payment shall not be made on the contract until such time as the Contractor submits sufficient documentation demonstrating achievement of the goal in accordance with this Special Provision or after liquidated damages have been determined and collected.

Certification of Nonsegregated Facilities - as Required by 41 CFR 60-1.8

(Applicable to (1) contracts, (2) subcontracts, and (3) agreements with applicants who are themselves performing federally assisted construction contracts, exceeding \$10,000.00 which are not exempt from the provisions of the Equal Opportunity clause).

By the submission of this bid, the bidder, offeror, applicant, or subcontractor certifies that he does not maintain or provide for his employees any segregated facilities at any of his establishments and that that he does not permit his employees to perform their services at any location, under his control, where segregated facilities are maintained. He certifies further that he will not maintain or provide for his employees any segregated facilities at any of his establishments and that he will not permit his employees to perform their services at any location, under his control, where segregated facilities are maintained. The bidder, offeror, applicant, or subcontractor agrees that a breach of his certification is a violation of the Equal opportunity clause in this contract. As used in this certification, the term "segregated facilities" means any waiting rooms, work areas, rest rooms and wash rooms, restaurants and other eating areas, time clocks, locker rooms and other storage or dressing areas, parking lots, drinking fountains, recreation or entertainment areas, transportation, and housing facilities provided for employees which are segregated by explicit directive or are in fact segregated on the basis of race, color, religion, or national origin, because of habit, local custom, or otherwise. He further agrees that (except where he has obtained identical certifications from proposed subcontractors for specific time periods) he will obtain identical certifications from proposed subcontractors prior to the award of subcontracts exceeding \$10,000.00 which are not exempt from the provisions of the Equal Opportunity clause; that he will retain such certifications in his files and that he will forward the following notice to such proposed subcontractors (except where the proposed subcontractors have submitted identical certifications for specific time periods):

**NOTICE TO PROSPECTIVE SUBCONTRACTORS OF REQUIREMENT FOR
CERTIFICATIONS OF NONSEGREGATED FACILITIES**

A certification of Nonsegregated Facilities must be submitted prior to the award of a subcontract exceeding \$10,000.00 which is not exempt from the provisions of the Equal Opportunity clause. The certification may be submitted either for each subcontract or for all subcontracts during a period (i.e., quarterly, semiannually or annually).

NOTE: The penalty for making false statements in offers is prescribed in 18 U.S.C 1001.

CERTIFICATION REGARDING DEBARMENT, SUSPENSION, AND OTHER RESPONSIBILITY MATTERS
Instructions for Certification

1. By signing and submitting this proposal, the prospective primary participant is providing the certification set out below.
2. The inability of a person to provide the certification required below will not necessarily result in denial of participation in this covered transaction. The prospective participant shall submit an explanation of why it cannot provide the certification set out below. The certification or explanation will be considered in connection with the department or agency's determination whether to enter into this transaction. However, failure of the prospective primary participant to furnish a certification or an explanation shall disqualify such person from participation in this transaction.
3. The certification in this clause is a material representation of fact upon which reliance was placed when the department or agency determined to enter into this transaction. If it is later determined that the prospective primary participant knowingly rendered an erroneous certification in addition to other remedies available to the Federal Government, the department or agency may terminate this transaction for cause of default.
4. The prospective primary participant shall provide immediate written notice to the department or agency to whom this proposal is submitted if at any time the prospective primary participant learns that its certification was erroneous when submitted or has become erroneous by reason of changed circumstances.
5. The terms "covered transaction" "debarred" "suspended" "ineligible" "lower tier covered transaction" "participant" "person" "primary covered transaction" "principal" "proposal" and "voluntarily excluded" as used in this clause have the meaning set out in the Definitions and Coverage sections of the rules implementing Executive Order 12540. You may contact the department or agency to which this proposal is being submitted for assistance in obtaining a copy of those regulations.
6. The prospective primary participant agrees by submitting this proposal that should the proposed covered transaction be entered into, it shall not knowingly enter into any lower tier covered transaction with a person who is debarred, suspended, declared ineligible, or voluntarily excluded from participation in this covered transaction unless authorized by the department or agency entering into this transaction.
7. The prospective primary participant further agrees by submitting this proposal that it will include the clause titled "Certification Regarding Debarment, Suspension, Ineligibility and Voluntary Exclusion - Lower Tier Transaction", provided by the department or agency entering into this covered transaction without modification in all lower covered transactions and in all solicitations for lower covered transactions.
8. A participant in a covered transaction may rely upon a certification of a prospective participant in a lower tier covered transaction that it is not debarred, suspended, ineligible, or voluntarily excluded from the covered transaction unless it knows that the certification is erroneous. A participant may decide the method and frequency by which it determines the eligibility of its principals. Each participant may, but is not required to check the Nonprocurement List (Tel. #).
9. Nothing contained in the foregoing shall be construed to require establishment of a system of records in order to render in good faith the certification required by this clause. The knowledge and information of a participant is not required to exceed that which is normally possessed by a prudent person in the ordinary course of business dealings.
10. Except for transactions authorized under paragraph 8 of these instructions, if a participant in a covered transaction knowingly enters into a lower tier covered transaction with a person who is suspended, debarred, ineligible, or voluntarily excluded from participation in this transaction, in addition to other remedies available to the Federal Government, the department or agency may terminate this transaction for cause or default.

Certification Regarding Debarment, Suspension, and
Other Responsibility Matters - Primary Covered Transactions

1. The prospective primary participant certifies to the best of its knowledge and belief that it and its principals:
 - a. Are not presently debarred, suspended, proposed for debarment, declared ineligible, or voluntarily excluded from covered transactions by an Federal department or agency;
 - b. Have not within a three-year period preceding this proposal been convicted of or had a civil judgment rendered against them for commission of fraud or a criminal offense in connection with obtaining, attempting to obtain or performing a public (Federal, State or Local) transaction or contract under a public transaction: violation of Federal or State antitrust statutes or commission of embezzlement, theft, forgery, bribery, falsification or destruction or destruction of records, making false statements, or receiving stolen property;
 - c. Are not presently indicted for or otherwise criminally or civilly charged by a governmental entity (Federal, State or local) with commission of any of the offenses enumerated in paragraph (1)(b) of this certification; and
 - d. Have not within a three-period preceding this application/proposal had one or more public transactions (Federal, State or local) terminated for cause or default.
2. Where the prospective primary participant is unable to certify to any of the statements in this certification, such prospective participant shall attach an explanation to this proposal.

CERTIFICATION REGARDING LOBBYING (Applicable to contracts in excess of \$100,000):

Certification for Contracts, Grants, Loans and Cooperative Agreements.

The undersigned bidder certifies, to the best of his or her knowledge and belief, that:

- (1) No Federal appropriated funds have paid or will be paid, by or behalf of the undersigned, to any person for influencing or attempting to influence an officer or employee of any agency, a Member of Congress, an Officer or employee of Congress, or an employee of a Member of Congress in connection with the awarding of any Federal contract, the making of any Federal grant, the making of any Federal loan, the entering into of any cooperative agreement, and the extension, continuation, renewal, amendment, or modification of any Federal contract, grant, loan, or cooperative agreement.
- (2) If any funds other than Federal appropriated funds have been paid or will be paid to any person for influencing or attempting to influence an officer or employee of any agency, a Member of Congress, an officer or employee of Congress, or an employee of a Member of Congress in connection with this Federal contract, grant, loan, or cooperative agreement, the undersigned shall complete and submit Standard Form-LLL, "Disclosure Form to Report Lobbying", in accordance with its instructions.
- (3) The undersigned shall require that the language of this certification be included in the award documents for all subawards at all tiers (including subcontracts, subgrants, and contracts under grants, loans, and cooperative agreements) and that all subrecipients shall certify and disclose accordingly.

This certification is a material representation of fact upon which reliance was placed when this transaction was made or entered into. Submission of this certification is a prerequisite for making or entering into this transaction imposed by Section 1352, title 31, U.S. Code. Any person who fails to file the required certification shall be subject to a civil penalty of not less than \$10,000 and not more than \$100,000 for each such failure.

WORKERS' COMPENSATION INSURANCE

Prior to the execution of his construction contract by the Illinois Department of Transportation, Division of Aeronautics, hereinafter referred to as "Division", the Contractor shall furnish to the Division certificates of insurance covering Workers' Compensation, or satisfactory evidence that this liability is otherwise taken care of in accordance with Section 4.(a) of the "Workers' Compensation Act of the State of Illinois" as amended.

Such insurance, or other means of protection as herein provided, shall be kept in force until all work to be performed under the terms of the contract has been completed and accepted in accordance with the specifications, and it is hereby understood and agreed that the maintenance of such insurance or other protection, until acceptance of the work by the Division is a part of the contract. Failure to maintain such insurance, cancellation by the Industrial Commission of its approval of such other means of protection as might have been elected, or any other act which results in lack of protection under the said "Workers' Compensation Act" may be considered as a breach of the contract.

SPECIAL PROVISION FOR DOMESTIC SOURCE FOR STEEL

Control of Materials: All steel products, as defined by the Illinois Steel Products Procurement Act, incorporated into this project shall be manufactured or produced in the United States and, in addition, shall be domestically fabricated. The Contractor shall obtain from the steel producer and/or fabricator, in addition to the mill analysis, a certification that all steel products meet these domestic source requirements.

CLAUSE TO BE INCLUDED IN ALL SOLICITATIONS,
CONTRACTS, AND SUBCONTRACTS RESULTING FROM PROJECTS FUNDED UNDER THE AIP

The Contractor or subcontractor, by submission of an offer and/or execution of a contract, certifies that it:

- a. is not owned or controlled by one or more citizens or nationals of a foreign country included in the list of countries that discriminate against U.S. firms published by the Office of the United States Trade Representative (USTR);
- b. has not knowingly entered into any contract or subcontract for this project with a Contractor that is a citizen or national of a foreign country on said list, or is owned or controlled directly or indirectly by one or more citizens or nationals of a foreign country on said list.
- c. has not procured any product nor subcontracted for the supply of any product for use on the project that is produced in a foreign country on said list.

Unless the restrictions of this clause are waived by the Secretary of Transportation in accordance with 49 CFR 30.17, no contract shall be awarded to a Contractor or subcontractor who is unable to certify to the above. If the Contractor knowingly procures or subcontracts for the supply of any product or service of a foreign country on the said list for use on the project, the Federal Aviation Administration may direct, through the sponsor, cancellation of the contract at no cost to the Government.

Further, the Contractor agrees that, if awarded a contract resulting from this solicitation, it will incorporate this provision for certification without modification in each contract and in all lower tier subcontracts. The Contractor may rely upon the certification of a prospective subcontractor unless it has knowledge that the certification is erroneous.

The Contractor shall provide immediate written notice to the sponsor if the Contractor learns that its certification or that of a subcontractor was erroneous when submitted or has become erroneous by reason of changed circumstances. The subcontractor agrees to provide immediate written notice to the Contractor, if at any time it learns that its certification was erroneous by reason of changed circumstances.

This certification is a material representation of fact upon which reliance was placed when making the award. If it is later determined that the Contractor or subcontractor knowingly rendered an erroneous certification, the Federal Aviation Administration may direct, through this sponsor, cancellation of the contract or subcontract for default at no cost to the Government.

Nothing contained in the foregoing shall be construed to require establishment of a system of records in order to render, in good faith, the certification required by this provision. The knowledge and information of a Contractor is not required to exceed that which is normally possessed by a prudent person in the ordinary course of business dealings.

This certification concerns a matter within the jurisdiction of an agency of the United States of America and the making of false, fictitious, or fraudulent certification may render the maker subject to prosecution under Title 18, United States Code, Section 1001.

SECTION III

REHABILITATION AND RECONSTRUCTION OF THE GENERAL AVIATION APRON AND TAXIWAY A1

GREENVILLE AIRPORT
GREENVILLE, BOND COUNTY, ILLINOIS

A.I.P. PROJECT NO. 3-17-0049-B4
I.D.O.T. PROJECT NO. GRE-3215

MARCH 24, 2006



ENGINEERS

HENRY, MEISENHEIMER & GENDE, INC.
1075 Lake Road, P.O. Box 70
Carlyle, Illinois 62231

www.hmgengineers.com Phone (618) 594-3711 Fax (618) 594-8217



Illinois Department of Transportation

Division of Aeronautics
#1 Langhorne Bond Drive
Springfield, Illinois 62707

SPECIAL PROVISIONS - TABLE OF CONTENTS

<u>Item No.</u>	<u>Pay Item</u>	<u>Page</u>
	Table of Contents	i
	Index of Supplemental Specifications	ii
	Index of Recurring Special Provisions	iv
	Introduction & Scope of Work.....	1
	Division I Special Provisions	1
AR150530	Traffic Maintenance.....	5
AR156520	Erosion Control.....	6
AR201003	Bituminous Base Course – Method I, Superpave	20
AR201663	Sand Mix Crack Repair	21
AR201670	Crack Control Fabric	23
AR209604	Crushed Aggregate Base Course	26
AR209951	Pavement Removal & Reconstruction.....	27
AR401613	Bituminous Surface Course – Method I, Superpave	28
AR401650	Bituminous Pavement Milling.....	29
AR501001	Portland Cement Concrete Pavement – Method I.....	30
AR620520	Pavement Marking	34
AR701	Pipe for Storm Sewers and Culverts	35
AR751	Manholes, Catch Basins, Inlets and Inspection Holes	37
 <u>Appendix</u>		
1.	Policy Memorandum 04-03	A-1
2.	Policy Memorandum 87-2	A-2
3.	Policy Memorandum 87-3	A-3
4.	Policy Memorandum 87-4	A-4
5.	Policy Memorandum 90-1	A-5
6.	Policy Memorandum 95-1	A-6
7.	Policy Memorandum 96-3	A-7
8.	Policy Memorandum 97-2	A-8
9.	Policy Memorandum 2001-1	A-9
10.	Policy Memorandum 2003-1	A-10

SUPPLEMENTAL SPECIFICATIONS
 AND RECURRING SPECIAL PROVISIONS

Adopted July 1, 2004

This sheet contains a listing of SUPPLEMENTAL SPECIFICATIONS and frequently used RECURRING SPECIAL PROVISIONS.

SUPPLEMENTAL SPECIFICATIONS

<u>Std. Spec. Sec.</u>	<u>Page No.</u>
DIVISION I – GENERAL PROVISIONS	
10 Definition of Terms	1
20 Scope of Work	2
30 Control of Work	4
40 Control of Materials	12
50 Legal Relations and Responsibility to Public	14
60 Prosecution and Progress	17
70 Measurement and Payment	19

<u>Std. Spec. Item No.</u>	<u>Page No.</u>
DIVISION II – PAVING CONSTRUCTION DETAILS	
EARTHWORK	
151 Clearing & Grubbing	21
152 Excavation & Embankment	25
155 Lime Treated Subgrade	32
FLEXIBLE BASE COURSES	
208 Aggregate Base Course	40
209 Crushed Aggregate Base Course	45
217 Aggregate-Turf Pavement (Not Included)	49
RIGID BASE COURSE	
304 Cement Treated Base Course (Not Included)	50
FLEXIBLE SURFACE COURSES	
402 Porous Friction Course	51

<u>Std. Spec. Item No.</u>		<u>Page No.</u>
MISCELLANEOUS		
602	Bituminous Prime Coat	58
603	Bituminous Tack Coat	62
605	Joint Sealing Filler	68
609	Seal Coats & Bituminous Surface Treatments (Not included)	71
610	Structural Portland Cement Concrete	72
620	Pavement Marking	77
625	Tar Emulsion Protective Seal Coat	88
DIVISION III - FENCING		
161	Wire Fence with Steel Posts	95
162	Chain-Link Fences	99
DIVISION IV – DRAINAGE PIPE		
701	Pipe for Storm Sewers and Culverts	105
705	Pipe Underdrains for Airports	109
751	Manholes, Catch Basins, Inlets, & Inspection Holes	114
752	Concrete Culverts, Headwalls, & Misc. Drainage Structures	117
754	Concrete Gutters, Ditches and Flumes	118
DIVISION V - TURFING		
901	Seeding	120
904	Sodding	123
905	Topsoiling	125
908	Mulching	127
DIVISION VI – LIGHTING INSTALLATION		
101	Installation of Airport Rotating Beacons	130
103	Installation of Airport Beacon Towers	132
107	Installation of Airport 8-Foot & 12-Foot Wind Cones	133
108	Installation of Underground Cable for Airports	134
109	Installation of Airport Transformer Vault & Vault Equip.	145
110	Installation of Airport Underground Electrical Duct	148
125	Installation of Airport Lighting Systems	151

RECURRING SPECIAL PROVISIONS

The following RECURRING SPECIAL PROVISIONS indicated by an "X" are Applicable to this contract and are included by reference:

<u>Check</u>	<u>Sheet No.</u>	<u>Item No.</u>		<u>Page No.</u>
		AR101580	Refurbish 36" Beacon	155
		AR106000	Apron Lighting	160
		AR119000	Airport Obstruction Lighting (Not Included)	166
		AR127000	Airport Navaid Installation (Not Included)	167
		AR150510	Engineer's Field Office	168
		AR150560	Temporary Threshold	170
	X	AR152540	Soil Stabilization Fabric	173
		AR156000	Erosion Control	175
		AR156513	Separation Fabric	180
		AR156540	Riprap	182
		AR201001	Bituminous Base Course - Method I	185
		AR201002	Bituminous Base Course - Method II	193
	X	AR201003	Bituminous Base Course - Method I, Superpave	209
		AR201004	Bituminous Base Course - Method II, Superpave	217
		AR201661	Clean & Seal Bituminous Cracks	230
	X	AR201663	Sand Mix Crack Repair	233
	X	AR201671	Crack Control Fabric	235
		AR302000	Asphalt Treated Permeable Subbase	237
		AR401001	Bituminous Surface Course - Method I	245
		AR401002	Bituminous Surface Course - Method II	253
	X	AR401001	Bituminous Surface Course - Method I, Superpave	269
		AR401002	Bituminous Surface Course - Method II, Superpave	277
		AR401640	Bituminous Pavement Grooving	290
	X	AR401650	Bituminous Pavement Milling	293
	X	AR401655	Butt Joint Construction	295
		AR401900	Remove Bituminous Pavement	297
	X	AR501001	Portland Cement Concrete - Pavement Method I	299
		AR501002	Portland Cement Concrete - Pavement Method II	316
		AR501003	Portland Cement Concrete - Pavement Method III	338
		AR501115	Crack and Seal Pavement	362
		AR501540	PCC Pavement Grooving	365
		AR501550	PCC Pavement Milling	368
		AR501900	Remove PCC Pavement	370
		AR510500	Tie-down/Ground Rod	372
	X	AR605000	Silicone Joint Sealing Filler	373



Greenville Airport
Special Provisions
A.I.P. Project No. 3-17-0049-B4
I.D.O.T. Project No. GRE-3215

INTRODUCTION

These Special Provisions together with the “Standard Specifications for Construction of Airports” adopted January 1, 1985; the “Supplemental Specifications and Recurring Special Provisions” adopted July 1, 2004; Contract Requirements for Airport Improvement Projects; Payroll Requirements; and Minimum Wage Rates which are hereto attached or which by reference are herein incorporated, cover the requirements of the State of Illinois, Department of Transportation (IDOT), Division of Aeronautics (Division) for the improvement project at Greenville Airport, Greenville, Illinois.

GOVERNING SPECIFICATIONS AND RULES AND REGULATIONS

The Illinois Department of Transportation (IDOT), Division of Aeronautics (Division), “Standard Specifications for Construction of Airports” adopted January 1, 1985, and the “Supplemental Specifications and Recurring Special Provisions” adopted July 1, 2004, shall govern the project except as otherwise revised or noted in these Special Provisions. In case of conflict with any part, or parts of the Standard Specifications, Supplemental Specifications, or Recurring Special Provisions (SSRSP) and the Special Provisions, the said Special Provisions shall take precedence and shall govern. The Contractor will maintain a minimum of one printed copy of the SSRSP on the project site at all times.

SCOPE OF WORK

This project shall consist of rehabilitating and reconstructing (as needed) the main general aviation apron and Taxiway A1. The majority of the apron and taxiway will be rehabilitated by milling off a minimum of ½” and as much as 2” of the existing bituminous surface, routing and crack-filling as needed and then placing a bituminous overlay. Portions of project area will be removed and reconstructed to provide for a smooth transition to the existing surrounding pavement and to provide positive drainage away from buildings. A portion of the reconstructed area that is by the fuel farm and maintenance hangar will be replaced with 5½” of PCC pavement.

DIVISION I

Section 10 – Definition of Terms.

10-54 Resident Engineer Revise the first sentence as follows.

The representative of the Owner, whether employed directly by the Owner or employed by an engineering firm retained by the Owner, to observe, document, and test the work and acting under the supervision of the Project Engineer.

Section 20 – Scope of Work.

No Changes.

Section 30 – Control of Work.

30-06 Construction Layout

Responsibility of the Resident Engineer

Delete Paragraphs A. and B. and replace as follows.

- A. The Resident Engineer will locate and reference four (4) control points within the limits of the project.
- B. A benchmark has been established along the project outside of the construction lines.

Add Paragraph M. as follows.

- M. It is not the responsibility of the Resident Engineer to check the correctness of the Contractor's stakes and/or forms, except as provided herein; however any errors that are apparent shall be immediately called to the Contractor's attention, and he shall be required to make the necessary correction before the stakes/forms are used for construction purposes.

30-08 Authority and Duties of the Resident Engineer Revise section as follows.

As the direct representative of the Owner, the Resident Engineer has immediate charge of observing and monitoring the construction project. The Resident Engineer is authorized to observe and/or perform tests to all or any part of the work and to the materials or the manufacturer of materials to be used. The Resident Engineer is not authorized to revoke, alter, or waive any provision to the Contract. The Resident Engineer is not authorized to issue instructions contrary to the plans and specifications. The Resident Engineer is not authorized to direct or supervise the Contractor or his Subcontractors.

The Resident Engineer is authorized to notify the Contractor or his representative of any failure of the work or materials to conform to the requirements of the contract documents, and to recommend to the Project Engineer or Owner that nonconforming materials or work be rejected, and to recommend to the Engineer or Owner suspension of any work in question until the Engineer can make a decision on its acceptability.

30-09 Duties of the Inspector Revise section as follows.

The Resident Engineer and his staff will be authorized to inspect all work being performed and materials being incorporated into the project. Such inspection may extend to all or any part of the work and to the preparation, fabrication, or manufacture of materials to be used. The Resident Engineer and his staff will not be authorized to alter or waiver the provisions of the Contract nor will they be authorized to issue instructions contrary to the Plans and Specifications or to direct the Contractors work.

30-10 Inspection of the Work Revise the third paragraph to read as follows.

Any work performed or materials incorporated without inspection by an authorized representative of the Engineer may be ordered removed and replaced by the Engineer at the Contractor's own expense.

Section 40 – Control of Materials.

40-04 Plant Inspection Add the following.

On projects where proportioning Engineers/Technicians are required, the Contractor shall provide adequate laboratory/office space for testing and observation of the production of the bituminous or concrete mixes.

The proportioning Engineers/Technicians shall also have full access to those areas of the plant concerned with production for the purpose of observing the mixing cycles, obtaining sample materials and recording weights and volumes. The proportioning Engineer/Technician shall have full access to the Contractor's QC/QA laboratory and testing facilities for purpose of inspection of the manufacturing operation and quality control testing. For a project that includes the manufacture of concrete, the Engineer shall have use of the Contractor's laboratory for acceptance testing of the materials.

40-11 Required Submittals Add this section.

The contractor shall certify all materials contained in the contract. Certification documentation shall be submitted to the Resident Engineer. As a guide to the certification process and requirements, the Contractor shall use the Illinois Department of Transportation/Division of Aeronautics MANUAL FOR DOCUMENTATION OF AIRPORT MATERIALS (latest edition). Copies of this manual are available from the Illinois Division of Aeronautics. This manual defines the Resident Engineer's/Contractor's responsibilities (Sections 300/400). The Contractor shall have the sole responsibility to provide the Engineer with appropriate documentation to satisfy the contract certification requirements prior to the delivery of materials. Materials incorporated into this project without the prior approval of the Resident Engineer will not be recommended for payment.

All sheets of all submittals shall contain the following information:

- Greenville Municipal Airport
- Rehabilitation/Reconstruction of GA Apron & Taxiway A-1
- IL Project No. GRE-3215
- AIP Project No. 3-17-0049-B4
- Pay Item No. and Description
- Quantity
- Date

Section 50 – Legal Relations and Responsibility to the Public.

50-26 Contractor's Responsibility for Safety During Construction Add this section.

The Contractor shall be responsible for safety during construction. He shall comply with all parts of the Safety Plan and all provisions noted herein. His responsibilities shall include but are not limited to the following:

- (1) Possess a copy of the project safety plan.
- (2) Comply with the safety plan associated with the construction project and ensure that construction personnel are familiar with safety procedures and regulations on the Airport.
- (3) Provide a point of contact that will coordinate an immediate response to correct any construction-related activity that may adversely affect the operational safety of the Airport.

- (4) Provide a safety officer/construction inspector trained in airport safety to monitor construction activities.
- (5) Restrict movement of construction vehicles to construction areas as flagging and barricading, erecting temporary fencing, or providing escorts, as appropriate or as shown in plans.
- (6) Ensure that no construction employees, employees of subcontractors or suppliers, or other persons enter any part of the aircraft operations area from construction site unless authorized.
- (7) Contractor will provide a self-propelled, vacuum or regenerative (recirculating) air pavement sweeper utilizing a dust/refuse separator, with a debris hopper mounted on an engine driven truck or vehicle. This will be used on all airfield pavements to be opened to aircraft traffic. No separate payment will be made for the sweeper but shall be considered incidental to the contract.

Section 60 – Prosecution and Progress.

60-14 Employee's Parking Area Add this section.

The location of an area for parking by the Contractor's employees shall be as shown on the plans or as agreed to at the preconstruction meeting. Use of personal vehicles beyond the staging area will not be allowed.

60-15 Security During Construction Add this section.

The Contractor shall be responsible for security during construction as follows:

- (1) Possess a copy of the Airport's project security plan.
- (2) Visibly delineate his construction zone by placing a line of barricades around the entire work zone during each phase of the contract.
- (3) Comply with the Airport's security plan associated with the construction project and ensure that construction personnel are familiar with security procedures and regulations on the Airport.
- (4) Provide a point of contact that will coordinate an immediate response to correct any construction-related activity that may adversely affect the operational security of the Airport.
- (5) Restrict movement of construction vehicles to construction areas as flagging and barricading, erecting temporary fencing, or providing escorts, as appropriate or as shown in plans.
- (6) Ensure that no construction employees, employees of subcontractors or suppliers, or other persons enter any part of the aircraft operations area from construction site unless authorized.

The Contractor shall comply with Federal Aviation Regulations Part 107 (Airport Security), Federal Air Regulation 139 (Airport Certification), and with all rules and regulations of the Airport, including, but not limited to, control and access to the ramp by Contractor's, employees and agents. In the event the Authority is assessed a fine by the Federal Aviation Administration or Transportation Security Administration for breach of security resulting from actions of Contractor's employees and agents, the Contractor shall fully reimburse the Authority for the amount of such fine.

Section 70 – Measurement and Payment.

No Changes.

DIVISION II

ITEM AR150530 – TRAFFIC MAINTENANCE.

DESCRIPTION

150-1.1 This item of work shall consist of the furnishing, installation, maintenance, relocation and removal of all traffic control devices and any other work required to comply with the Construction Safety Plan and the Phasing Plan Requirements of the Safety Plan.

CONSTRUCTION METHODS

150-2.1 Traffic Maintenance Requirements

Aviation safety is the primary consideration at airports, especially during construction. Hazardous practices and marginal conditions created by construction activities can decrease or jeopardize operational safety on the airport. The purpose of the Safety Plan shown in the plans is to minimize disruption of normal aircraft operations and to avoid situations that compromise the airports operational safety. The Construction Safety Plan and the Phasing Plan have been prepared to comply with the provisions of Advisory Circular No. 150/5370-2E "Operational Safety on Airports During Construction" which sets forth guidelines for operational safety on the airport during the length of construction on this Project. The plan was established and included in the plans to direct the Contractor in the placement of temporary traffic control systems and to provide a plan for compliance under FAA policies. The Contractor shall abide with all requirements of the plan as part of the Contract. Certain traffic maintenance items shall be placed as shown or as described in the plan. Other items shall be placed as directed by the Engineer based on situations resulting from type of activities, time of year, and weather conditions. If the Contractor fails to comply with the safety and phasing plans or the SSRSP concerning traffic control, the Engineer shall execute such work as may be deemed necessary to correct deficiencies and the cost thereof shall be deducted from compensation due or which may become due the Contractor under the Contract.

METHOD OF MEASUREMENT

150-3.1 All work associated with complying with the requirements of the safety plan and phasing requirements of the project including but not limited to the furnishing, installation, maintenance, relocation, and removal of traffic control devices; the maintenance, repair and restoration of all haul routes and staging/parking areas; FOD management; waste and spill prevention controls; or other work as directed by the Engineer shall be paid for in a lump sum for traffic maintenance which is for the duration of the Project.

BASIS OF PAYMENT

150-4.1 Payment shall be made at the contract unit price per lump sum for traffic maintenance which shall be full compensation for furnishing all materials, labor, equipment, tools, and incidentals necessary to complete the item.

Payment will be made under:

Item AR150530 Traffic Maintenance - per lump sum.

ITEM AR156520 – EROSION CONTROL.

DESCRIPTION

156-1.1 This item of work shall consist of constructing temporary erosion control systems as shown on the plans or as ordered by the Resident Engineer during the life of the contract to control erosion and sediment damage to pavements, adjacent properties and water resources through the use of ditch checks, basins, inlet sedimentation control, silt filter fences, temporary seeding and other erosion control devices or methods as is acceptable.

As part of this item, the Contractor shall be required to comply with the requirements of the National Pollutant Discharge Elimination System (NPDES) Storm Water Permit for construction site activities.

Information on the above-referenced permits may be obtained from:

Illinois Environmental Protection Agency
Division of Water Pollution Control
1021 North Grand Avenue East
Springfield, Illinois 62702

MATERIALS

156-2.1 Silt Fence

This fence shall conform to the requirements contained in Item 161 for 39" woven wire fence with metal "T" posts except that no special corner posts, bracing or P.C.C. will be required and a 36" width of filter fabric shall be secured to the bottom of the fence on its upstream side as shown in the plans.

Geotextile fabric for silt fence shall consist of woven or nonwoven filaments of polypropylene, polyester or polyethylene. Nonwoven fabric may be needle punched heat-bonded, resin-bonded or combination thereof. The filaments in the Silt Filter Fence Fabric must be dimensionally stable (i.e., to each other), resistant to delamination, and must be free from any chemical treatment or coating that might significantly reduce porosity and permeability. Both fabrics shall be resistant to ultraviolet radiation. If stored on the jobsite prior to its use, it shall be protected from exposure to direct sunlight. The fabrics shall comply with the following physical properties:

Properties	Dimension	
Width, m (ft.)	1 (3.5) min.	
Weight [g/m ² (oz./sq.yd.)]	135 (4.0) min.	ASTM D 3776
Grab Tensile Strength, N (lbs.)	900 (200) min. ^{1/}	ASTM D 4632
Grab Elongation @ Break (%)	15 min. ^{1/}	ADTM D 4632
Burst Strength, kPa (psi)	1725 (250) min. ^{2/}	ASTM D 3786

Properties	Dimension	
Equivalent Opening Size	600 um (30) min. (nonwoven) ^{2/}	COE CW-02215
(EOS) Sieve No.	300 um (50) min. (woven) ^{2/}	

- 1/ The fabric shall be tested wet in both warp and fill directions in accordance with ASTM D1682, Grab Test, G using a 100 mm (4-inch) by 200-mm (8 inch) sample, 75-mm (3 inch) gage length, 300-mm (12 inch) per minute in a CRE testing machine. The average of 5 tests in each direction shall meet the minimum value given above.
- 2/ Manufacturer's certification that the fabric meets the minimum value.

156-2.2 Bale Stakes

Shall be four feet minimum in length each and be either of sound wood 1" square (minimum) or #4 rebar.

156-2.3 Hay or Straw Bales

Shall be either hay or straw compacted and adequately bound to an approximate size of 12"x18"x36".

156-2.6 Urethane Foam/Geotextile

Urethane foam/geotextile ditch checks shall be triangular shaped having a minimum height of 8 to 10 inches in the center with equal sides and a 16 to 20 inch base. The triangular shaped inner material shall be a low density urethane foam. The outer cover shall be a woven geotextile fabric placed around the inner material and allowed to extend beyond both sides of the triangle 2 to 3 feet. Standard lengths of each dike shall be 7 feet. The fabrics shall comply with the following physical properties:

Properties	Dimension	
Grab Tensile Strength, N (lbs.)	450 (100) min. ^{1/}	ASTM D 4632
Grab Elongation @ Break (%)	15 min. ^{1/}	ADTM D 4632
Burst Strength, kPa (psi)	1380 (200) min. ^{2/}	ASTM D 751
Weight g/sq m (oz/sq yd)	135 (4.0) min.	ADTM D 3776
Equivalent Opening Size	600 um (30) min. (nonwoven) ^{2/}	
(EOS) Sieve No.	300 um (50) min. (woven) ^{2/}	COE CS-02215

- 1/ For woven fabric, test results shall be referenced to orientation with warp or weave, whichever the case may be. Both woven and nonwoven fabric shall be tested wet.
- 2/ Manufacturer's certification that the fabric meets the minimum value.

The urethane foam shall have the following properties:

Properties	Dimension	
Density, kg/cu m (lbs/cu ft)	16.0±1.6 (1.0±0.1) min.	ASTM D 3574
Filler Content (%) by weight	0%	ADTM D 297
Tensile Strength, kPa (psi)	70 (10) min.	ASTM D 3574
Elongation (%)	125 min.	ASTM D 3574
Tear Resistance N/mm (lb/in)	0.22 (1.25)	ASTM D 3574

- 1/ Manufacturer's certification that the fabric meets the minimum value.

CONSTRUCTION METHODS

156-3.1 General

The Contractor shall conduct his construction operations in accordance with the latest revision of the Illinois Environmental Protection Agency publication "Standards and Specifications for Soil Erosion and Sediment Control".

Erosion control must be considered by the Contractor prior to exposing any erodible material. Erosion protection for Contractor furnished borrow pits, equipment storage sites, plant sites and haul roads shall be provided by the Contractor.

The Resident Engineer has the authority to limit the surface area of erodible earth material exposed by clearing and grubbing, excavation, borrow and embankment operations and to direct the Contractor to provide immediate permanent or temporary pollution control measures. Cut slopes shall be permanently seeded and mulched as the excavation proceeds to the extent considered desirable and practical.

Slopes that erode easily shall be temporarily seeded as the work progresses with a cereal grain of wheat, rye or oats obtained from a local supplier or seed store. The cereal grains may be planted by a hand seeder or other acceptable method and covered by a drag or harrow to provide a quick cover crop. Inspection of the cereal grain seed will not be required. The intent of using cereal grains as temporary erosion control is to permit the Contractor to quickly seed potential areas as the need arises with on-site personnel and equipment.

156-3.2 Temporary Erosion Control

The installation and maintenance of silt fence or bales shall be at the locations shown on the plans, or as directed by the Resident Engineer. Refer to details provided herein.

156-3.4 Silt Fence

The installation and maintenance of silt fence shall be at the locations shown on the plans, or as directed by the Resident Engineer. The Contractor shall maintain the alignment and condition of the silt fence, as necessary, throughout its use on the project. Upon completion and/or as directed, the Contractor shall remove the silt fence from the project. Refer to details provided herein.

156-3.5 Straw Bale Barrier

The installation and control of straw bale barriers shall be at the location shown in the plans, or as directed by the Resident Engineer. Refer to details provided herein.

156-3.6 Inlet and Pipe Protection

This system consists of placement of protection surrounding inlets, pipe inlets or outfalls, and in similar locations as required to intercept water borne silt and sediment and prevent it from entering the drainage system or exiting the construction area. The protection shall be constructed according to the manufacturers' specifications where appropriate. Refer to details provided herein.

156-3.7 Dust Control

The Contractor shall employ construction methods and means that will keep flying dust to the minimum as directed by the Resident Engineer. The Contractor shall provide for the laying of water on the project, and on roads, streets,

aprons and other areas immediately adjacent to the project limits, wherever traffic, or buildings that are occupied or in use, are affected by such dust caused by hauling or other operations. The cost of carrying out the foregoing provisions shall be incidental to the contract.

156-3.9 Maintenance and Removal of Temporary Erosion Control System

The temporary erosion control systems installed by the Contractor shall be properly maintained as directed by the Resident Engineer to control siltation at all times during the life of the contract. Any additional material and work required by the Resident Engineer will be measured and paid as herein specified. If the Contractor fails to maintain the temporary erosion control systems as directed by the Resident Engineer, the Resident Engineer may at the expiration of a period of 48 hours, after having given the Contractor written notice, proceed to maintain the systems as deemed necessary, and the cost thereof shall be deducted from any compensation due, or which may become due the Contractor under this contract.

156-3.10 Removal of Erosion Control

The Contractor shall remove temporary erosion control structures when ordered to do so by the Resident Engineer. The costs associated with the removals shall be incidental to this item. In the event that temporary erosion and pollution control measures are ordered by the Resident Engineer due to the Contractor's negligence or carelessness, the work shall be performed by the Contractor at his own expense.

METHOD OF MEASUREMENT

156-4.3 The number of inlet and pipe protections paid for shall be the number of inlets or pipe openings shown in the plans to be protected or as ordered by the Resident Engineer used to control erosion.

BASIS OF PAYMENT

156-5.1 Payment will be made at the contract unit price per each for Inlet and Pipe Protection. This price shall be full compensation for furnishing all materials for all preparation and installation of these materials, including excavation, placement, tie-down stakes, staples, maintenance and removal and for all labor, equipment, tools, and incidentals necessary to complete this item.

Payment will be made under:

Item AR156520 Inlet and Pipe Protection - per each.

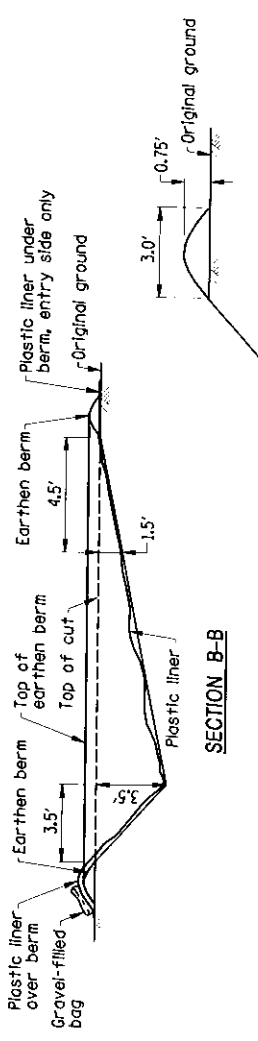

SECTION B-B

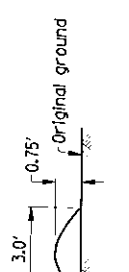

EARTHEN BERM TYP. SECTION

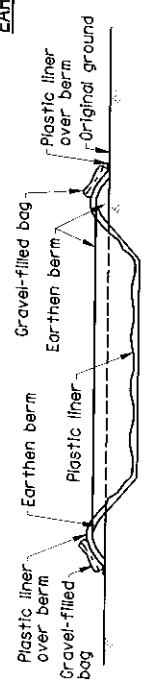

SECTION A-A

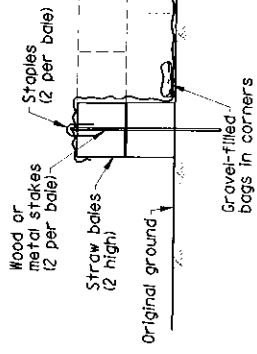

SECTION C-C

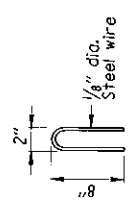

STAPLE DETAIL

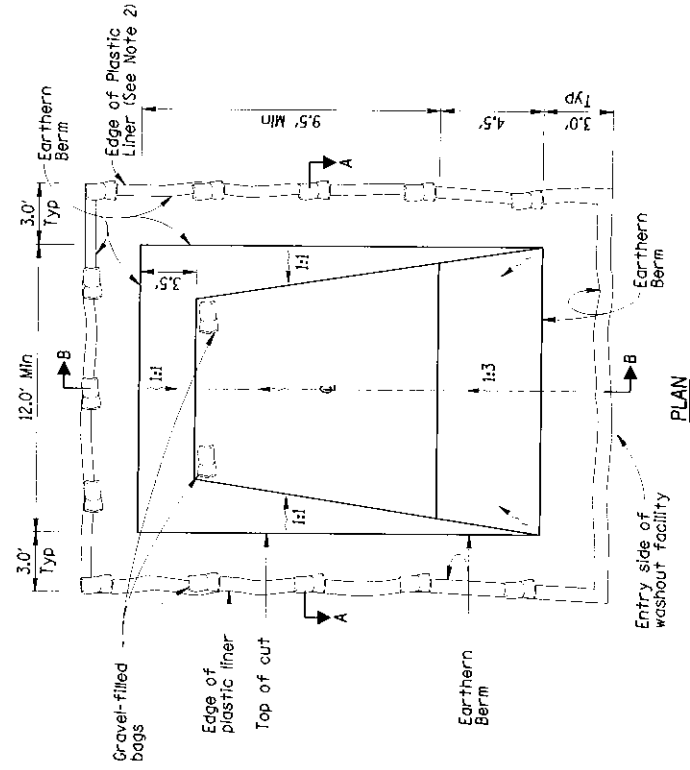

PLAN

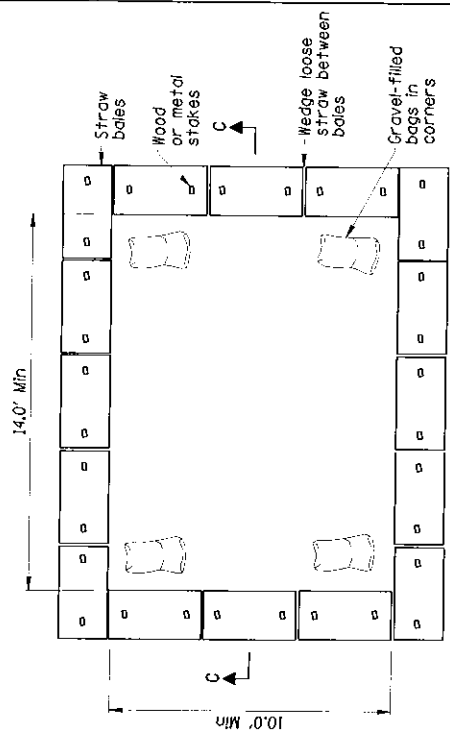

PLAN

TEMPORARY CONCRETE WASHOUT FACILITY

(10n Grade)

TEMPORARY CONCRETE WASHOUT FACILITY

(Below Grade)

ENGINEERS
HENRY, MEISENHEIMER & GENDE, INC.
ENGINEERS
CARLYLE, ILLINOIS 62231
www.hmgengineers.com
(618) 594-3711 Fax (618) 594-8217

SECTION _____
COUNTY _____
FILE NAME _____
CONC. WASHOUT _____
SHEET NO. _____

STORM WATER POLLUTION CONTROL DETAILS
TEMPORARY CONCRETE WASHOUT FACILITY

INLET PROTECTION - BLOCK AND GRAVEL PLAN

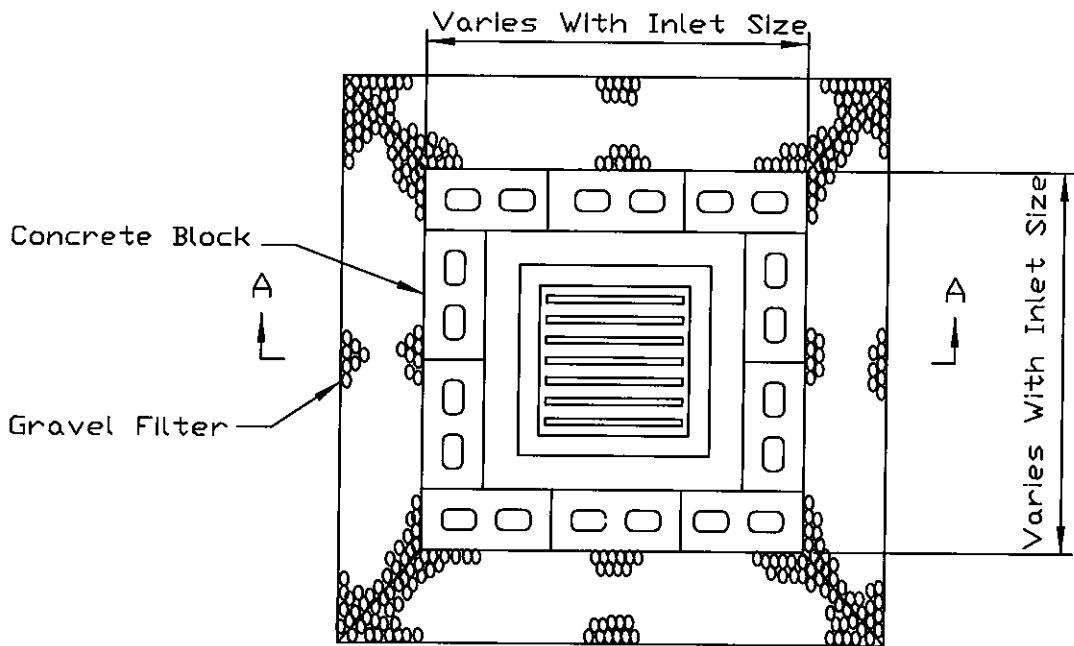

PLAN VIEW

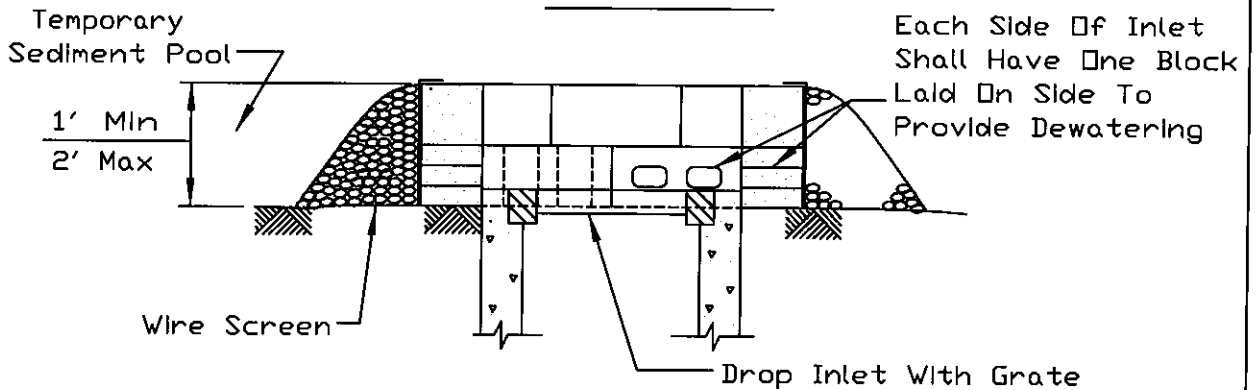

SECTION A-A

NOTES:

1. Sediment shall be removed and the trap restored to its original dimensions when the sediment has accumulated to 1/2 the design depth. Removed sediment shall be deposited in a suitable area and in such a manner that it will not erode.
2. The sediment trap shall be removed and the area stabilized when the constructed drainage area has been properly stabilized.
3. The wire screen shall be hardware cloth or comparable wire mesh with 1/2 inch openings.
4. The gravel shall meet requirements for coarse aggregate with IDOT gradations of CA-1, CA-2 or CA-3.

REFERENCE

Project _____
 Designed _____ Date _____
 Checked _____ Date _____
 Approved _____ Date _____



NRCS

Natural Resources Conservation Service

STANDARD DWG. NO.

IL-550

SHEET 1 OF 1

DATE 8-17-94

INLET PROTECTION - EXCAVATED DRAIN PLAN

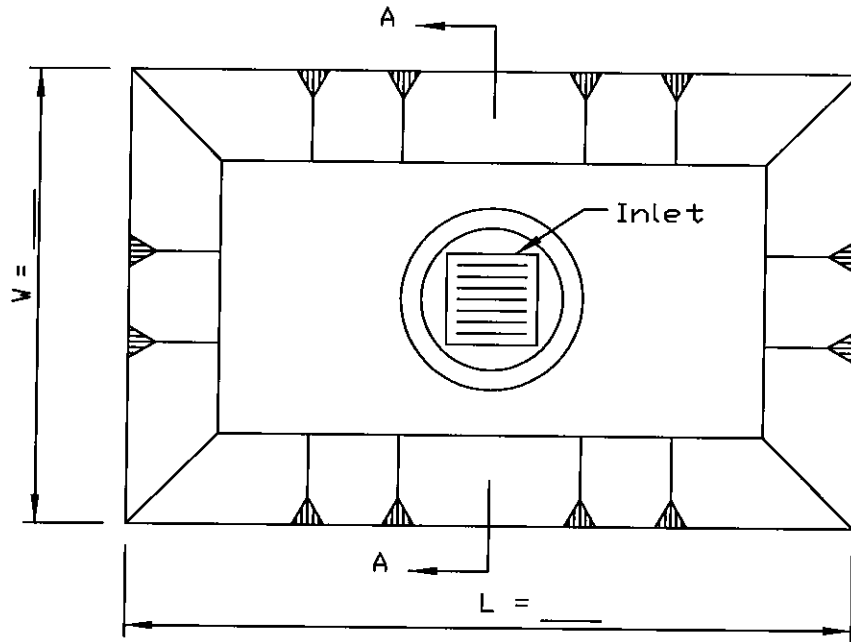

PLAN VIEW

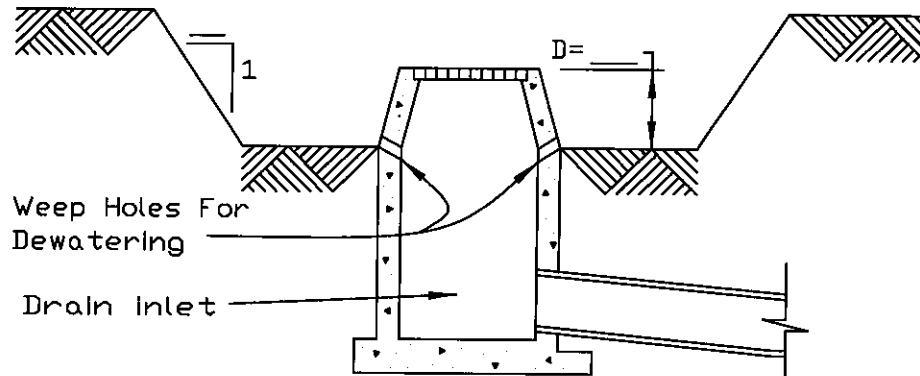

TYPICAL SECTION A-A

NOTES:

1. Sediment shall be removed and the trap restored to its original dimensions when the sediment has accumulated to 1/2 the design depth of the trap. Removed sediment shall be deposited in a suitable area and in such a manner that it will not erode.
2. The sediment trap shall be removed and the area stabilized when the constructed drainage area has been properly stabilized.
3. All cut slopes shall be 2:1 or flatter.

REFERENCE		
Project		
Designed		Date
Checked		Date
Approved		Date



NRCS

Natural Resources Conservation Service

STANDARD DWG. NO.

IL-555

SHEET 1 OF 1

DATE 3-11-93

INLET PROTECTION - FABRIC DROP PLAN

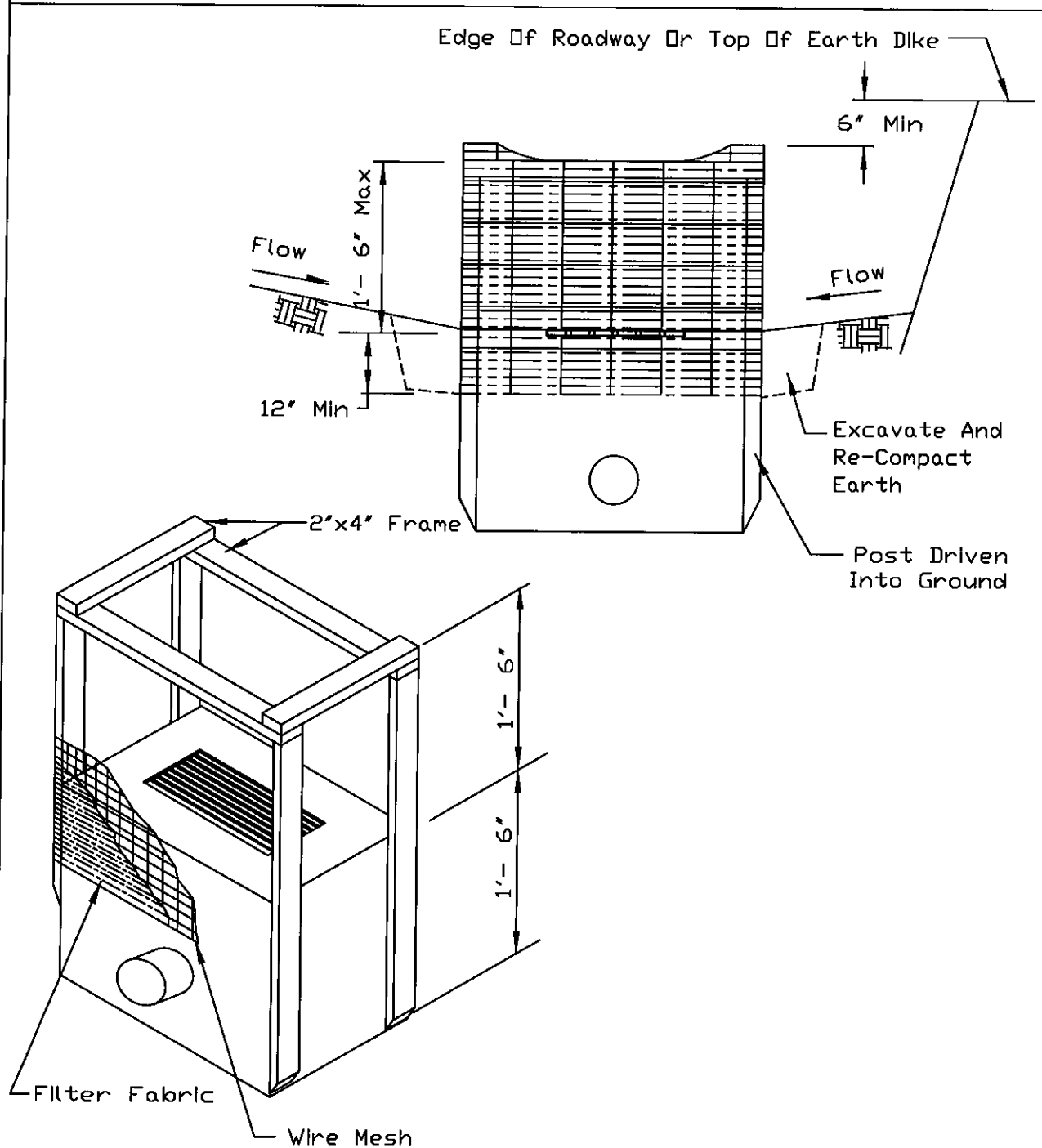

NOTES:

1. Filter fabric shall meet the requirement of material specification 592 GEOTEXTILE table 1 or 2, class I, with an EDS of at least 30 for nonwoven and 50 for woven.
2. The wire mesh shall have a maximum opening of at least 6 inches.
3. Limit drainage area to the inlet protection to 1 acre.

REFERENCE	Project	_____
	Designed	_____ Date _____
	Checked	_____ Date _____
	Approved	_____ Date _____



STANDARD DWG. NO.
 IL-560
 SHEET 1 OF 1
 DATE 6-29-93

INLET PROTECTION GRAVEL AND WIRE MESH PLAN

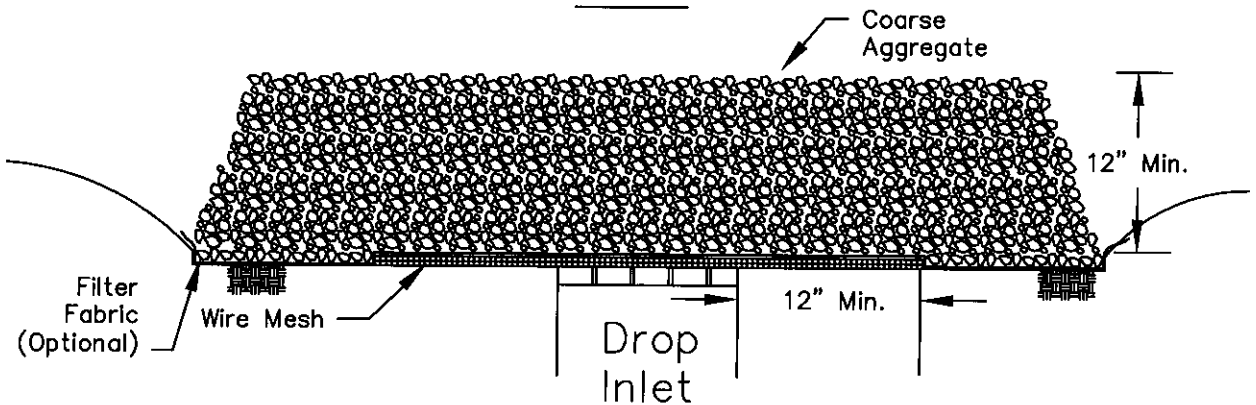
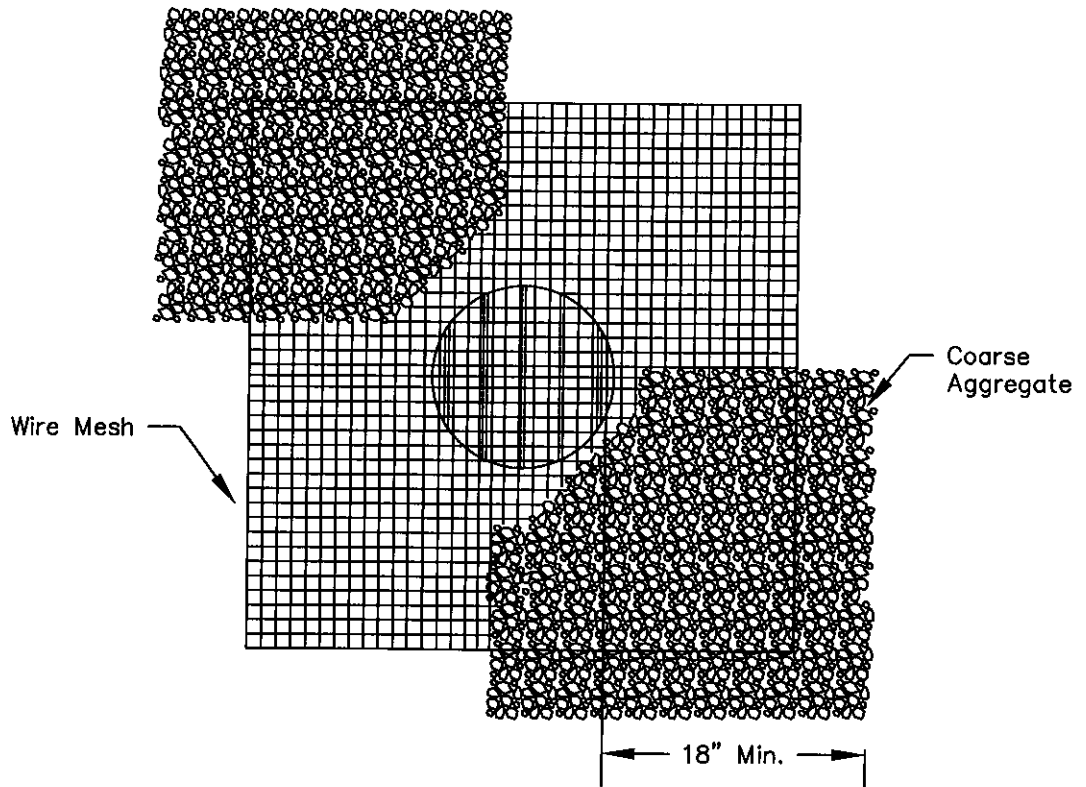

NOTES:

1. Hardware cloth or comparable wire mesh must have a maximum of 1/2 inch openings.
2. Hardware cloth or wire mesh must extend a minimum of 12 inches beyond each side of the inlet opening; if more than one strip of mesh is necessary, strips shall be overlapped a minimum of 6 inches.
3. Coarse aggregate shall meet one of the IDOT gradations CA-1 or CA-3. CA-2 can be used when filter fabric is used.
4. Filter fabric shall meet the requirements of material specification 592 GEOTEXTILE Table 1 or 2, Class 1 with AOS of at least 30 for nonwoven and 50 for woven.

REFERENCE		
Project	_____	
Designed	_____	Date _____
Checked	_____	Date _____
Approved	_____	Date _____



NRCS

Natural Resources Conservation Service

STANDARD DWG. NO.

IL-561

SHEET 1 OF 1

DATE 10/28/01

INLET PROTECTION SOD FILTER PLAN

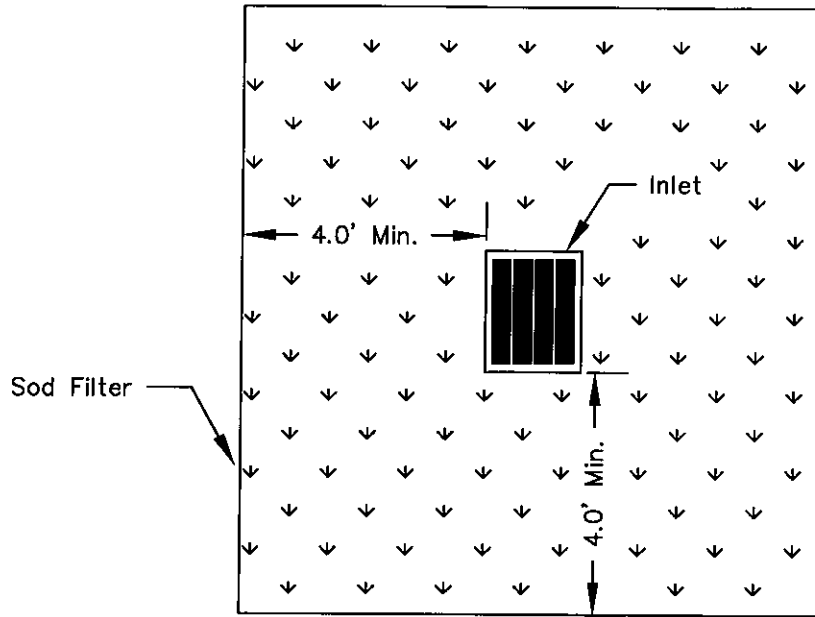

PLAN

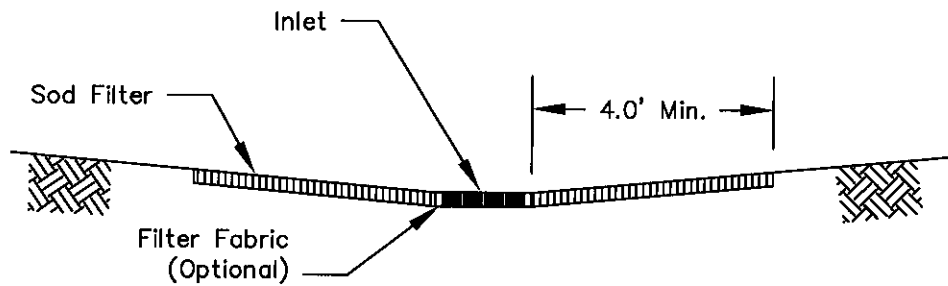

SECTION

NOTES:

1. The sod should be flush with surrounding ground surface.
2. If used, filter fabric shall meet the requirements of material specification 592 GEOTEXTILE Table 1 or 2, Class 1 with AOS of at least 30 for nonwoven and 50 for woven.

REFERENCE	
Project	_____
Designed	_____ Date _____
Checked	_____ Date _____
Approved	_____ Date _____



NRCS

Natural Resources Conservation Service

STANDARD DWG. NO.

IL-562

SHEET 1 OF 1

DATE 11-23-01

INLET PROTECTION STRAW BALE BARRIER PLAN

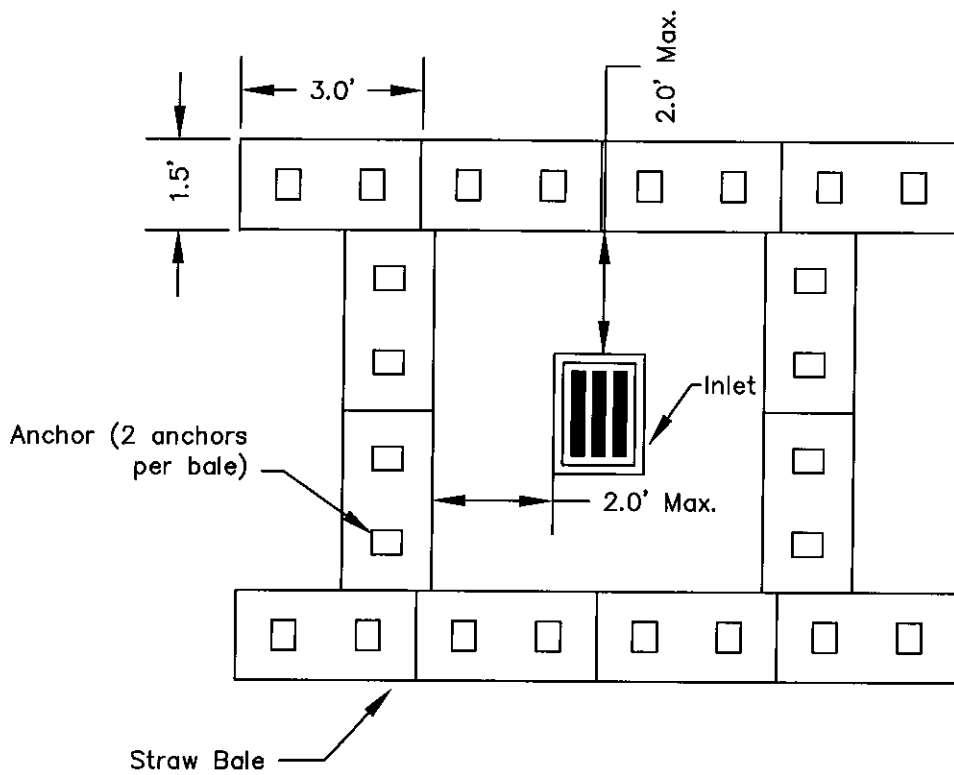

PLAN

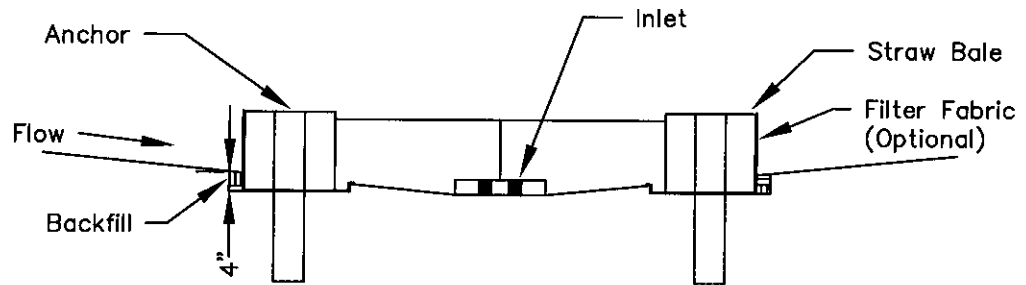

SECTION

NOTES:

1. The immediate land area around the inlet should be relatively flat (less than 1% slope) and located so that the accumulated sediment can be easily removed.
2. The inside edge of the bales shall be a maximum of 2 feet from the edge of the inlet.
3. Filter fabric shall meet the requirements of material specification 592 GEOTEXTILE Table 1 or 2, Class 1 with AOS of at least 30 for nonwoven and 50 for woven.
4. Anchors shall be rebar, steel pickets or 2" x 2" stakes, and shall be long enough to extend at least 1.5 to 2.0 feet into the ground when the top is flush with the bale.

REFERENCE	
Project	_____
Designed	_____ Date _____
Checked	_____ Date _____
Approved	_____ Date _____



STANDARD DWG. NO.	IL-563
SHEET	1 OF 1
DATE	11-23-01

STABILIZED CONSTRUCTION ENTRANCE PLAN

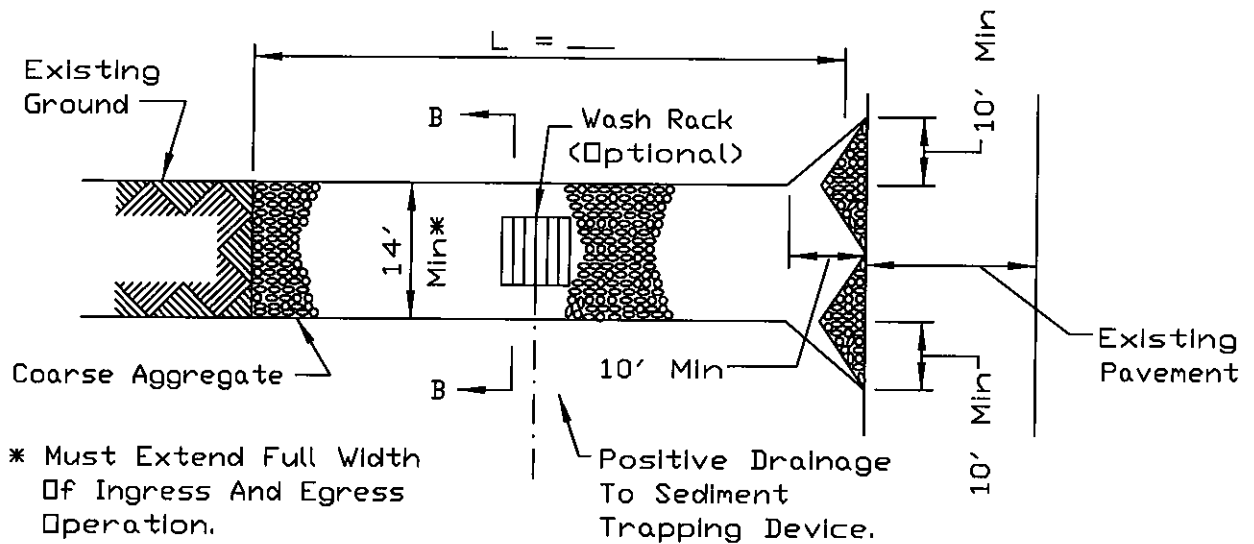

* Must Extend Full Width Of Ingress And Egress Operation.

PLAN VIEW

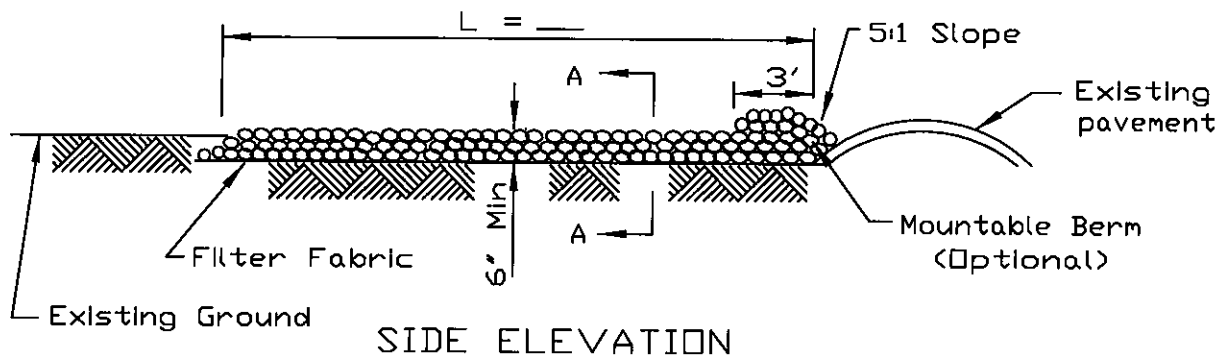

SIDE ELEVATION

NOTES:

1. Filter fabric shall meet the requirements of material specification 592 GEOTEXTILE, Table I or 2, Class I, II or IV and shall be placed over the cleared area prior to the placing of rock.
2. Rock or reclaimed concrete shall meet one of the following IDOT coarse aggregate gradation, CA-1, CA-2, CA-3 or CA-4 and be placed according to construction specification 25 ROCKFILL using placement Method 1 and Class III compaction.
3. Any drainage facilities required because of washing shall be constructed according to manufacturers specifications.
4. If wash racks are used they shall be installed according to the manufacturer's specifications.

REFERENCE	
Project	_____
Designed	_____ Date _____
Checked	_____ Date _____
Approved	_____ Date _____



NRCS

Natural Resources Conservation Service

STANDARD DWG. NO.
 IL-630
 SHEET 1 OF 2
 DATE 8-18-94

STABILIZED CONSTRUCTION ENTRANCE PLAN

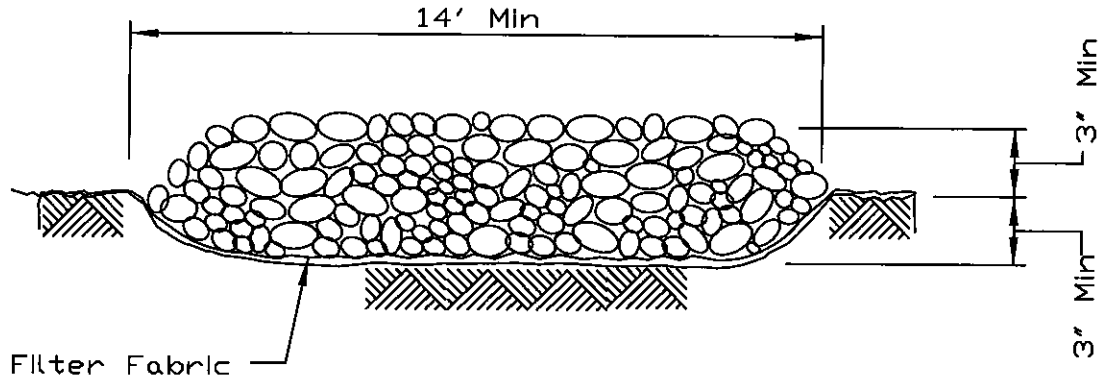

SECTION A-A

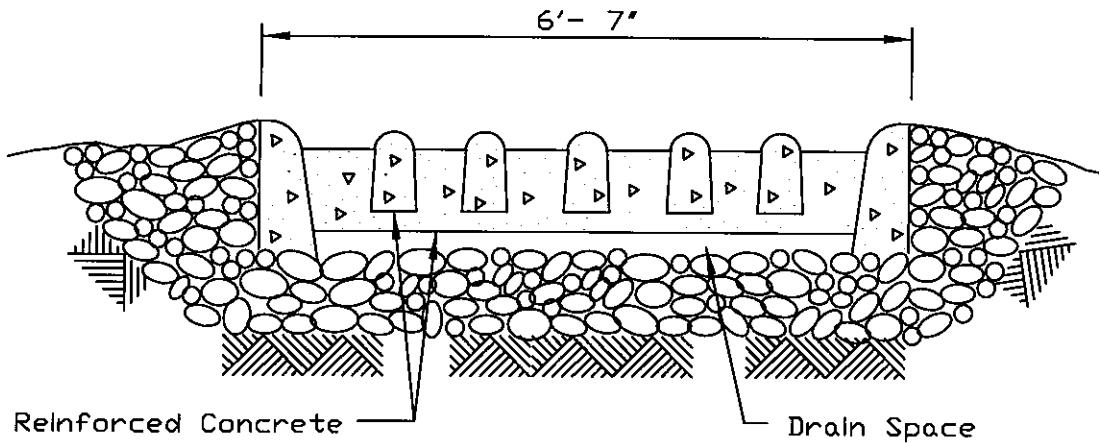

SECTION B-B

REFERENCE
Project _____
Designed _____ Date _____
Checked _____ Date _____
Approved _____ Date _____



NRCS

Natural Resources Conservation Service

STANDARD DWG. NO.

IL-630

SHEET 2 OF 2

DATE 8-18-94

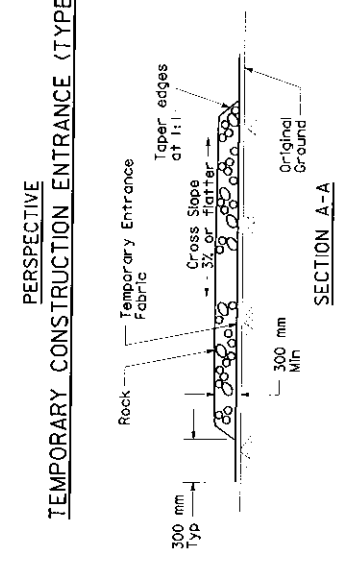
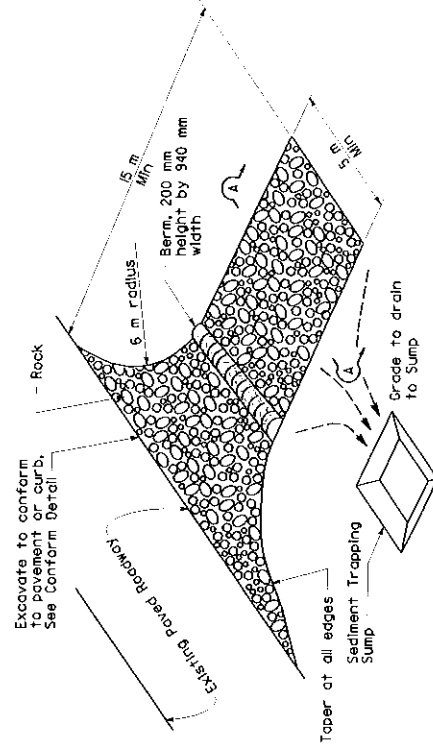
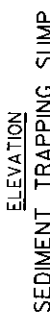
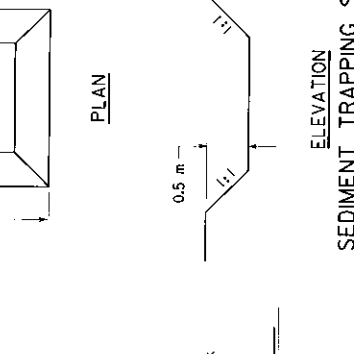
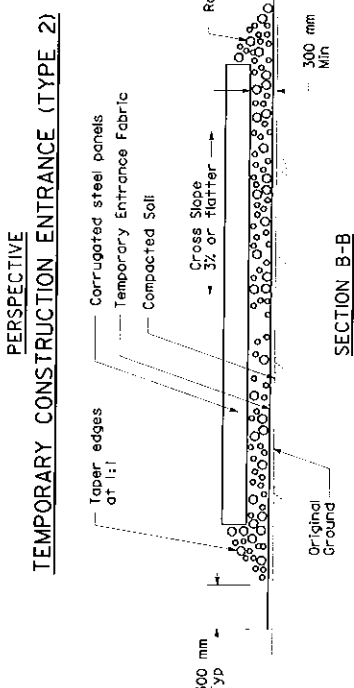
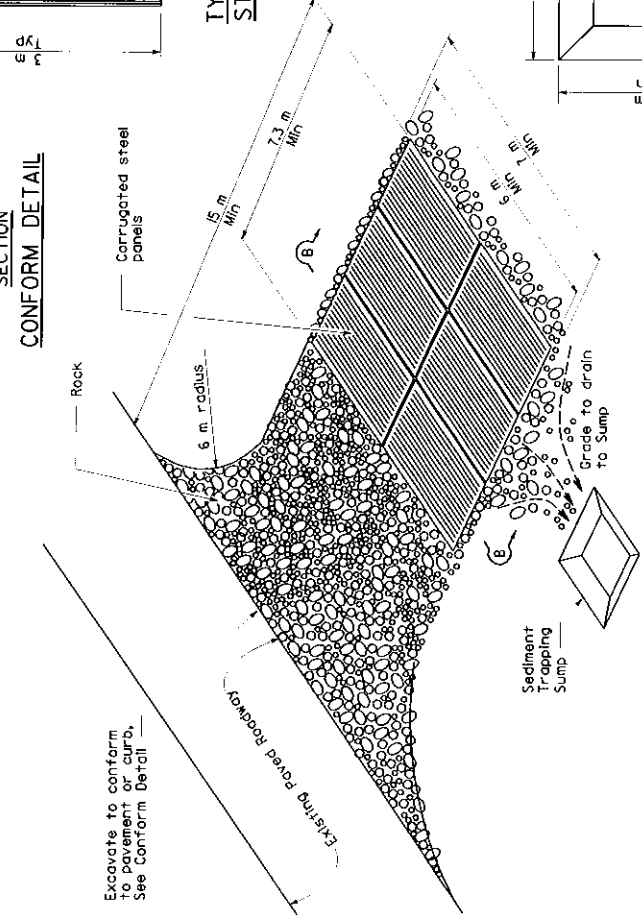
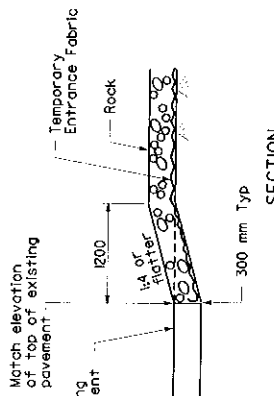
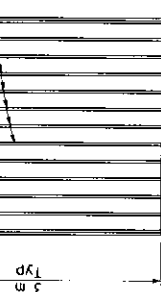
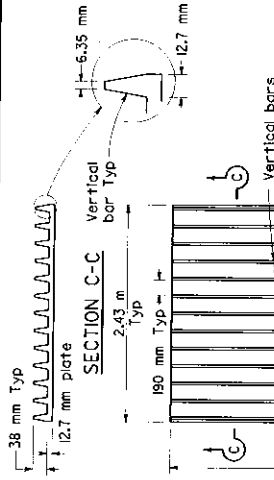

TEMPORARY WATER POLLUTION CONTROL DETAILS (TEMPORARY CONSTRUCTION ENTRANCE)

NO SCALE
ALL DIMENSIONS ARE IN MILLIMETERS UNLESS OTHERWISE SHOWN

ITEM AR201003 – BITUMINOUS BASE COURSE – METHOD I, SUPERPAVE.

Check Sheet #13 - "Bituminous Base Course – Method I, Superpave" is modified as outlined below.

COMPOSITION

201-3.2 Job Mix Formula Revise Table 2 as follows:

Design Parameter	Taxiway	Apron Areas
$N_{ini}^{(2)}$	5	5
$N_{des}^{(3)}$	30	30
N_{max}	42	42
Percent (%) Air Voids, V_a	2 - 4	2 - 4
VFA (min %)	75 - 90	75 - 90

In lieu of a JMF developed by the Division of Aeronautics, the Contractor may submit his or her own JMF for the Division to review and approve. The Contractor's JMF shall meet all the applicable material and testing requirements stated herein.

CONSTRUCTION METHODS

201-4.11 Joints Add to this section:

At any time during the bituminous paving operation it becomes necessary to end a paving lane at a location other than the proposed finished pavement edge because of ending a days paving, machinery breakdown, etc.; the lane will be sawed back a sufficient distance to provide a smooth, neat appearing joint from which to resume paving. A tack coat will be applied to the sawed face before resuming paving. This work shall not be paid for separately, but shall be considered incidental to Item 201.

METHOD OF MEASUREMENT

201-5.1 Add this section:

Measurement for payment will not be made for any bituminous base course in excess of 103 percent of the quantity specified by the Engineer.

BASIS OF PAYMENT

Payment will be made under:

Item AR201613	Bituminous Base Course – Method I, Superpave	-	per ton
Item AR201621	Bituminous Base Course, Leveling, Superpave	-	per ton

ITEM AR201663 – SAND MIX CRACK REPAIR.

Check Sheet #16 - "Sand Mix Crack Repair" is modified as outlined below.

DESCRIPTION

1.1 Delete this section and replace with the following:

This item of work shall consist of cleaning, routing if necessary, and placement and compaction of a bituminous sand mix in designated joints and cracks in existing bituminous pavements. All cracks for the sand mix bituminous crack repair shall be marked by the Resident Engineer after bituminous pavement milling is completed. Wherever the word "cracks" is used, it shall be construed to mean the cracks or joints to be sealed.

MATERIALS

2.1 Crack/Joint Filler Revise section as follows.

Bituminous sand mix shall conform to the following requirements:

Sieve Size	Percent Passing
No. 4	100
No. 8	90 - 100
No. 16	45 - 85
No. 50	10 - 30
No. 100	0 - 10
(IDOT FA-2)	
Asphalt	4 - 7

Up to 3% cement can be added to accelerate the set time. The mixture shall not contain more than 20% natural sand without approval in writing from the Engineer. The proportions of asphalt emulsion and aggregate shall be determined in the field and may be varied to facilitate construction requirements. Normally, these proportions will be approximately one part asphalt emulsion to five parts aggregate by volume. The ingredients shall be heated and combined in such a manner as to produce a bituminous mixture which when discharged from the mixer shall not be more than 350°F.

EQUIPMENT

3.2 Crack Routing Machine Add this section.

The crack routing machine shall be portable and capable of routing existing bituminous surfaces along and adjacent to the crack. The unit shall be capable of following random cracks. The unit shall have an adjustable depth control and be capable of cutting with modification. The machine shall be capable of routing cracks to sufficient widths and depths for installation of the bituminous sand mix.

CONSTRUCTION METHODS

4.1 Preparation Of Cracks Delete this section and replace with the following:

The cracks shall be routed and/or cleaned to provide a sealant reservoir of a width to depth ratio of 1:1 with a minimum crack width of $\frac{3}{8}$ ". No crack filler material shall be placed until the cracks have been cleaned of all loose dirt, joint material, debris and vegetation. If vegetation is a problem a soil sterilant shall be applied.

Existing cracks larger than $\frac{3}{8}$ " wide shall be cleaned of all dirt, joint material, debris and vegetation. Routing shall only be as necessary to provide an adequate sealant reservoir. Routing for these cracks shall be done as required by the Resident Engineer.

Existing cracks less than $\frac{3}{8}$ " wide shall be routed to a minimum of $\frac{3}{8}$ " wide and to a sufficient depth to provide the minimum ratio of 1:1. The routed shall be cleaned before joint sealant is applied.

Final cleaning will not proceed in advance of sealing by more than one (1) working day, except as otherwise approved by the Resident Engineer.

A tack coat shall be applied to the cleaned joint prior to installation of the sand mix.

The material shall be poured into the joints or cracks or shall be placed in the joint or crack and compacted with a self-propelled vibratory "pup" roller to form a voidless mass. The joint or crack shall be filled within 0 to 1/8 inch of the surface.

BASIS OF PAYMENT

Payment will be made under:

Item AR201663 Sand Mix Crack Repair - per lineal foot.

ITEM AR201670 – CRACK CONTROL FABRIC.

Check Sheet #17 - "Crack Control Fabric" is modified as outlined below.

DESCRIPTION

1.1 Revise the first sentence to read as follows:

This work shall consist of furnishing and installing reflective crack control material as shown on the plans that consists of a fiberglass/polyester interlayer-paving mat.

MATERIALS

2.1 Delete this section.

2.2 Delete this section.

2.3 Paving Mat Add this section.

The paving mat shall be TruPave by Owens Corning, or approved equivalent. The paving mat shall be constructed of a wet-formed non-woven material consisting of at least 60% fiberglass (by weight), the remainder comprised of polyester and binder. The material shall have a minimum average roll value (MARV) unit weight of 3.69 oz/yd² (125 g/m²). The material shall be resistant to chemicals, mildew and rot, and shall not have any tears or holes that will adversely affect the in-situ performance and physical properties of the installed material. The paving mat shall meet the following physical requirements as follows:

Property	Test Method	Units	Typical Value
Mass per unit area	ASTM D5261	g/m ² (oz/ yd ²)	136(4.0)
Tensile strength, MD	ASTM D5035	N/50 mm (lb/2 in)	> 200 (45)
Tensile strength, MD	ASTM D5035	N/50 mm (lb/2 in)	> 200 (45)
Elongation at maximum load, MD	ASTM D5035	percent	< 5
Elongation at maximum load, CD	ASTM D5035	percent	< 5
Melting point	ASTM D276	C (F)	> 230 (> 446)

The mat manufacturer shall furnish a letter of certification covering the physical and engineering properties of the mat. A letter of certification shall be furnished with each shipment stating that the paving mat complies with the specification requirements.

CONSTRUCTION METHODS

3.1 Add to this section:

Installation. Installation of paving mat interlayer shall be performed or supervised during start-up by a trained and experienced installer certified by the manufacturer or their agent(s).

Surface to be overlaid with the paving mat shall be cleaned, dry and free and clear of all dirt and debris. All surface cracks over 1/4 inch, shall be filled and brought to the level of the existing pavement surface. At the direction of the

Engineer, any and all irregular surface conditions shall be leveled by the use of a bituminous wedge or scratch course installed by hand or with the use of a mechanically powered asphalt-paving machine.

The mat shall be installed to the surface using mechanically powered installation equipment or by hand installed means. Mechanical equipment shall be capable of installing full width rolls of up to 12.5 feet in width. The installation by hand may also be used in situations where areas require specially cut sections, and/or where mechanically installed methods can not be accomplished. Brooms or squeegees shall be used to remove any air bubbles and ensure paving mat is completely in contact with the tack-coated surface. If wrinkles occur, any wrinkle one (1) inch and larger shall be slit and lapped in the direction of paving and seated into the tack coat to insure adhesion.

Paving mat shall be overlapped to provide a minimum of two (2) inches longitudinally and a minimum of four (4) inches transversely. Overlaps on the transverse roll ends shall be in the direction of the paving operation to avoid paving mat pick-up during asphalt installation. All overlapping of paving mat shall be tack coated to ensure proper adhesion.

Tack Coat Application. The asphalt tack coat shall be hot applied asphalt cement meeting grade requirements of AC or PG specifications. Every effort should be made in order to install paving mat over hot asphalt tack coat. It is recommended that an AC-20 or a 60-80 penetration grade of asphalt be applied for normal installations and temperatures. For extremely high summertime temperatures higher viscosity asphalt should be used. AC-30 or a 40-60 penetration grade of asphalt is appropriate.

An optimum, tack coat application rate shall be 0.20 g/yd². At the discretion and direction of the Engineer, the application rate may be increased to 0.25 g/yd² for heavily aged and/or deteriorated pavements. In the event that the contractor has applied less and/or more tack coat than is required, the engineer shall direct the contractor to make the necessary adjustments to the equipment to achieve the desired results. The use of cutbacks, emulsion or materials containing solvents shall not be permitted for use as tack coat.

Application Procedures. The tack coat application shall be applied using a mechanically operated distributor truck, calibrated to meet the specified application rate as called for in the plans and specifications. The tack coat application temperatures shall be sufficiently hot so as to ensure proper coverage and proper adhesion of the paving mat to the pavement surface. The use of hand sprayers, squeegee and or brush-applied tack coat may be used in locations where the distributor truck cannot reach. Every effort shall be made to minimize the application of tack coat by hand-applied means. The tack coat shall be applied in a uniform application to sufficiently cover the surface prior to the installation of the paving mat. The surface shall be dry and free and clear of all debris and loose materials prior to the installation of the tack coat. Any and all pavement repairs to be made shall be made at the direction of the Engineer prior to the installation of the tack coat.

The application width of tack coat shall be sufficiently wide to cover the entire width of the paving mat, plus any additional width required for overlapping joints. The tack coat shall be applied only as far in advance of the mat installation to ensure a tacky surface at the time of the mat installation. Traffic shall not be permitted to drive on the tack coat at any time.

Excess tack coat shall be cleaned from the pavement. In the event that installation operations must be curtailed, best practice is to barricade the affected area where the tack coat and mat have been installed, preventing vehicular traffic from driving on the prepared surface. In instances where the best practice is not feasible, the pavement may be opened to traffic after installation of engineered paving mat at the Engineers discretion.

Blotting the sealant, spreading sand or broadcasting bituminous asphalt mix over the paving mat shall be utilized to minimize and prevent construction and or paving tires/tracks from adhering to the tack coat and pulling up the mat. In the event that the paving mat has been displaced from the surface, additional rolling and or hand-brushing will be required to restore the bond between the surface and paving mat. An additional application of tack may be required

to ensure adhesion. Additional tack coat or labor shall not be paid for as an extra and shall be considered incidental to the installation of the paving mat.

METHOD OF MEASUREMENT

4.1 Add to this section:

The fiberglass/polyester interlayer-paving mat shall be paid for in accordance with these plans and specifications. The unit of measurement shall be paid for at the contract unit price per square yard installed in place. Overlaps in the paving mat will not be measured and included in the payment quantities.

BASIS OF PAYMENT

5.1 Add to this section:

Payment will be made at the contract unit price per square yard for Crack Control Fabric. This price shall be full compensation for furnishing all labor, materials (including asphalt tack coat), tools, equipment, and incidentals for performing the required work necessary to complete this item.

Payment will be made under:

Item AR201670	Crack Control Fabric -	per square yard.
---------------	------------------------	------------------

ITEM AR209604 – CRUSHED AGGREGATE BASE COURSE.

Item 209 “Crushed Aggregate Base Course” is modified as outlined below.

MATERIALS

209-2.3 Gradation Delete Gradation “C” in Table 1.

CONSTRUCTION METHODS

209-3.6 Finishing and Compacting Add to this section:

The base shall be compacted to not less than 100% of maximum density at optimum moisture as determined by compaction control tests specified in Division VII for aircraft with gross weights of less than 60,000 lbs. (Modified Proctor ASTM D 698).

BASIS OF PAYMENT

Payment will be made under:

Item AR209604 Crushed Aggregate Base Course – 4” - per square yard.

ITEM AR209951 – PAVEMENT REMOVAL & RECONSTRUCTION.

DESCRIPTION

This item of work shall consist of the removal, stockpiling, and reconstruction of the pavement subbase to the lines and grades shown on the plans.

CONSTRUCTION METHODS

This work shall consist of removal of all existing bituminous ($\pm 2\frac{1}{2}$ " - ± 6 ") pavement material and aggregate ($\pm 8\frac{1}{2}$ " - ± 10 ") base material, subbase material, subgrade material, or other appurtenances to the lines and grades shown on the plans. The materials resulting from the removal shall be stockpiled on airport property as shown on the plans or as directed by the Engineer. The Contractor shall separate the bituminous and aggregate material that can pass a $2\frac{1}{2}$ " sieve and reuse that material as subbase material in the proposed pavement sections. The subbase material will be placed to the subbase elevations shown in the plans and compacted to the satisfaction of the Engineer. The stockpiled material which is not used in the reconstruction of the pavement will be disposed of on the airport site at a location designated by the Airport Manager.

METHOD OF MEASUREMENT

The quantity of pavement removal and reconstruction to be paid for shall be the number of square yards of material shown to be removed on the plans and accepted by the Resident Engineer. No measurements or other allowances shall be made for the reconstruction areas or the multiple handling of the materials.

BASIS OF PAYMENT

Payment shall be made at the contract unit price per square yard of pavement removal and reconstruction which shall be full compensation for pavement removal, stockpiling, separation of materials, reconstruction of the subbase, hauling of the waste materials away, and for furnishing all materials, labor, equipment, tools, and incidentals necessary to complete the item.

Payment will be made under:

Item AR209951 Pavement Removal & Reconstruction - per square yard.

ITEM AR401613 – BITUMINOUS SURFACE COURSE – METHOD I, SUPERPAVE.

Check Sheet #21 - "Bituminous Surface Course – Method I, Superpave" is modified as outlined below.

COMPOSITION

401-3.2 Job Mix Formula Revise Table 2 as follows:

Design Parameter	Taxiway	Apron Areas
N _{ini} (2)	5	5
N _{des} (3)	30	30
N _{max}	42	42
Percent (%) Air Voids, V _a	2 - 4	2 - 4
VFA (min %)	75 - 90	75 - 90

In lieu of a JMF developed by the Division of Aeronautics, the Contractor may submit his or her own JMF for the Division to review and approve. The Contractor's JMF shall meet all the applicable material and testing requirements stated herein.

CONSTRUCTION METHODS

401-4.11 Joints Add to this section:

At any time during the bituminous paving operation it becomes necessary to end a paving lane at a location other than the proposed finished pavement edge because of ending a days paving, machinery breakdown, etc.; the lane will be sawed back a sufficient distance to provide a smooth, neat appearing joint from which to resume paving. A tack coat will be applied to the sawed face before resuming paving. This work shall not be paid for separately, but shall be considered incidental to Item 401.

401-4.12 Shaping Edges Add to this section:

All pavement edges, including the pavement ends, must be left in proper alignment as shown on the plans. This may be accomplished by a trimming method or at the Contractor's option by sawing after the paving has been completed. No additional compensation will be made if the sawing method is used.

METHOD OF MEASUREMENT

401-5.1 Add this section:

Measurement for payment will not be made for any bituminous surface course in excess of 103 percent of the quantity specified by the Engineer.

BASIS OF PAYMENT

Payment will be made under:

Item AR401613 Bituminous Surface Course – Method I, Superpave - per ton

ITEM AR401650 – BITUMINOUS PAVEMENT MILLING.

Check Sheet #24 - "Bituminous Pavement Milling" is modified as outlined below.

CONSTRUCTION METHODS

3-1 Rewrite the second sentence of the first paragraph to read:

The material removed that can pass a 2½" sieve may be reused as subbase material and shall be stockpiled on airport property as shown on the Safety plan or as directed by the Engineer. This material will be placed to the subbase elevations shown in the plans and compacted to the satisfaction of the Engineer. Any excess suitable aggregate material which is not used in the construction of the subbase will be disposed of on the airport site at a location designated by the Airport Manager. This work shall be considered incidental to this item and no additional compensation will be allowed.

BASIS OF PAYMENT

Payment will be made under:

Item AR401650 Bituminous Pavement Milling - per square yard

ITEM AR501001 – PORTLAND CEMENT CONCRETE PAVEMENT – METHOD I.

Check Sheet #27 - "Portland Cement Concrete Pavement – Method I" is modified as outlined below.

MATERIALS

501-2.4 Premolded Joint Filler Rewrite the first sentence to read:

Premolded joint filler for expansion joints shall conform to the requirements of ASTM D-1752 with compression requirement modified to 10 psi minimum and 25 psi maximum and shall be Ceramar by W.R. Meadows, or approved equivalent.

501-2.6 Steel Reinforcement Delete this section and add the following:

Reinforcement of odd-shaped panels, if required by the Engineer in the field, shall be panels of welded wire fabric of the size and dimensions shown in the plans conforming to ASTM A-185.

501 - 2.7 Dowel and Tie Bars Add to this section:

All dowel bars shall be fastened firmly in position with an approved contraction joint dowel bar assembly prior to the start of paving operations or mechanically inserted per article 420.10 of the IDOT Standard Specifications for Road and Bridge Construction. Loose dowel bars will not be accepted.

Contraction Joint Assembly. The contraction joint assembly shall be an approved welded assembly possessing the rigidity to hold the dowels during the placing and compacting of the concrete to the degree of alignment specified hereinafter. The assembly shall have 4 parallel spacer bars and 2 subgrade-bearing members. An upright support at each end of dowel shall be welded to both the outside spacer bar and the bearing member at appropriate points to hold the dowels at the design height. The two inside spacer bars shall be spaced approximately 2 inches on each side of center.

The dowels shall be spaced as shown on the plans and alternate ends shall be welded to the outside spacer bars. One weld is permitted per bar. The end of each dowel not welded to a spacer bar shall be securely held in place by means of wire loops or metal tubes welded to the other outside spacer bar. Suitable ties shall be provided to hold the assembly in normal position during shipping, handling and installation. Wire sized shall not be less than W7 for the outside spacer bars, bearing members and upright supports and W5 wire for the 2 inside spacer bars. The tie wires used for securing the spacer bars shall not be less than W3 wires.

The assembly shall be provided with 2 continuous bearing plates of not less than 2-inch width and not less than 0.0359 inches thickness sheet steel. The bearing plates shall be attached by welding to the subgrade members or by suitable clips and shall be punched to receive the protruding ends of the upright supports and stakes. The stakes shall be driven parallel to and next to the upright supports. The subgrade bearing members may be omitted if suitable subgrade plates are shop welded to the assembly and provide equivalent rigidity. Bearing plates will not be required on stabilized subbase.

The welds in the assembly shall be securely made. A broken weld will be sufficient cause for rejection of the length or section of the assembly in which it occurs.

501 - 2.9 Cover Material for Curing Delete sections (b), (c), (d) and revise section (a) as follows:

Curing materials shall be liquid membrane-forming compounds conforming to the requirements of ASTM C-309, Type 2 (White Pigmented).

CONSTRUCTION METHODS

501 - 3.1 Equipment

(d) Concrete Saw Add to this section:

Only self-propelled, water-cooled and lubricated saws with diamond blades shall be used on this project.

(e) Forms Add to this section:

All radii and tapers shall be formed with flexible forms.

(f) Slip-Form Pavers Add to this section:

The guide wires for pavers shall be set with steel standards (pins) driven into the subbase. An alternate method will be standards set with weighted bases.

(g) Drilling Machine Add to this section:

The machine used for drilling the holes for dowel bars in the face of the pavement shall be capable of drilling the size and depth of holes as shown on the plans. A drill support system using the pavement surface as a reference shall be required to assure hole alignment at the specified depth of the PCC pavement. Hand-held tools will not be allowed. The Contractor shall be required to place rubber mats (or other approved material) along the pavement edge prior to drilling dowel bar holes. Any damage to the pavement cause by the drilling operation shall be repaired to the satisfaction of the Engineer at no additional cost to the contract.

501 - 3.2 Form Setting Add to this section:

In the event that the pavement is constructed utilizing the formed paving technique, the paving lane forms supported by the subbase shall be anchored by steel pins. No formed areas shall be poured until the Engineer has checked and accepted the formwork for both alignment and elevation.

501 - 3.3 Conditioning of Underlying Course, Slip-Form Construction Delete the first sentence and add the following:

The existing grade along the outer edges of the new pavement shall be improved, if necessary, to support the paver without noticeable displacement. Any grading, compacting, or furnishing and installing materials shall be considered incidental to the unit prices for paving and no separate payment will be made.

All areas shall be constructed true to grade and acceptable to the Engineer prior to paving.

During placement of the concrete pavement, the subbase shall be maintained in a moist condition without accumulation of pools of water.

In the event that the underlying course has become over-saturated or unstable, paving operations shall stop until corrected unless otherwise approved by the Engineer.

501 - 3.4 Conditioning of Underlying Course, Side-Form Construction Add to this section:

All areas shall be constructed true to grade and acceptable to the Engineer prior to paving.

During placement of the concrete pavement, the subbase shall be maintained in a moist condition without accumulation of pools of water.

In the event that the underlying course has become over-saturated or unstable, paving operations shall stop until corrected unless otherwise approved by the Engineer.

501 - 3.6(b) Proportions Delete this section.

501 - 3.7 Field Test Specimens Add to this section:

The Contractor shall provide a system of marking and tracking samples taken in the field. The system shall be provided at the Preconstruction conference and shall, at a minimum, provide location of sample, lot number and curing and reporting of all test specimens manufactured by the Contractor's personnel.

The Contractor shall provide the forms or molds used to make compressive test cylinders or flexural beam specimens.

501 - 3.10 Placing Concrete

(a) Side-Form Method Delete the second paragraph and add the following:

When concrete is to be placed adjoining a previously constructed lane of pavement and when mechanical equipment will be operated upon the existing lane of pavement, the concrete shall have a minimum flexural strength of 550 psi or compressive strength of 3500 psi. If only finishing equipment is carried on the existing lane, paving in adjoining lanes may be permitted after 3 days, if approved by the Engineer.

(b) Slip-Form Method Add to this section:

In addition to the requirements of this section, the concrete shall be placed as described in the applicable sections of Section 501 - 3.10 (a). Any equipment used for transporting concrete shall be capable of discharging the material at a minimum specified slump. Concrete that is transported in vehicles not capable of discharging concrete at a minimum specified slump is subject to rejection by the Engineer.

501 - 3.17 Curing Add to this section:

(a) Impervious Membrane Method shall be utilized for this project.

For slip-form paving, the approved curing media shall be applied uniformly to all surfaces of the pavement, including exposed edges. Membrane curing compounds shall be applied on all concrete surfaces from a suitable self-propelled mechanical application device, which bridges the fresh concrete, designed to provide a uniform application. Other curing systems will not be permitted.

Care shall be taken when this method of curing is used. Should conditions prevail such that curing material is being blown toward buildings or aircraft, appropriate measures shall be taken to eliminate the problems to the satisfaction of the Engineer. Two (2) separate applications, applied at least five minutes apart, each at the rate of not less than one (1) gallon per 250 square feet will be required upon surfaces and edges of the concrete. Another application shall be necessary to cover any deficient areas less than one (1) gallon per 125 square feet. The curing membrane shall be sprayed as soon as possible without

damage to the pavement surface. Excessive delays in application of the membrane resulting in shrinkage cracking will be cause for rejection of the affected pavement necessitating removal.

501 - 3.23 Protection of Pavement against Rain

In order that the concrete may be properly protected against the effects of rain before the concrete is sufficiently hardened, the Contractor will be required to have available at all times materials for the protection of the edges and surface of the unhardened concrete. Such protective materials shall consist of standard metal forms or wood plank having a nominal thickness of the pavement at its edge for the protection of the pavement edges, and covering material such as curing paper or polyethylene sheeting material for the protection of the surface of the pavement. The metal forms, wood planks and curing paper shall be kept on trucks or towable vehicles, within reasonable hauling distance, at a site shown on the plans, or as designated by the Engineer. Or, as an alternate, rolled polyethylene sheeting of sufficient length and width may be used without the temporary side forms and if properly anchored, to cover the plastic concrete slab and exposed edge. The sheeting may be mounted on either the paver or a separate moveable bridge from which it can be unrolled without dragging over the plastic concrete surface. When rain appears imminent, all paving operations shall stop and all available personnel shall begin covering the surface of the unhardened concrete with the protective covering. All pavement damaged shall be removed and replaced at no additional cost to the contract.

501 - 3.24 Removal of Defective Work

At locations determined by the Engineer, the contractor shall be required to remove any pavement which is classified as defective. This includes any area where non-controlled (random) cracking occurs, unacceptable surface texturing or any other defect determined unacceptable by the Engineer. The pavement shall be removed to the nearest joint and replaced at the expense of the contractor. Prior to replacement, dowels and tie bars will be provided as directed by the Engineer.

BASIS OF PAYMENT

Payment will be made under:

Item AR501530	PCC Test Batch	-	per each
Item AR501555	5½" PCC Pavement	-	per square yard

ITEM AR620 – PAVEMENT MARKING.

Item 620 "Pavement Marking" is modified as outlined below.

DESCRIPTION

620-1.1 Add to this section:

This item of work shall also consist of the painting of a compass calibration checkpoint in accordance with the details herein at a location shown on the plans or as directed by the Airport Manager.

METHOD OF MEASUREMENT

620-4.1 Add to this section:

No distinction will be made between colors of paint for payment purposes.

The quantity of permanent markings to be paid for shall be the number of square feet of painting with the specified material measured only once for the application of two coats in conformance with the specifications and accepted by the Resident Engineer. Mobilization will not be measured for payment.

BASIS OF PAYMENT

Payment will be made under:

Item AR620520	Pavement Marking - Waterborne	-	per square foot.
---------------	-------------------------------	---	------------------

ITEM AR701 – PIPE FOR STORM SEWERS AND CULVERTS.

Item 701 "Pipe for Storm Sewers and Culverts" is modified as outlined below.

DESCRIPTION

701-1.1 Add to this section:

This item of work shall also consist of the removal of existing pipes, manholes, inlets, culvert ends, headwalls and other drainage structures of various types and sizes shown on the plans.

MATERIALS

701-2.5 Delete the first sentence and add the following:

Rubber gaskets for rigid pipe shall be O-Ring rubber gasket joints conforming to the requirements of ASTM C 361.

CONSTRUCTION METHODS

701-3.4 Laying and Installing Pipe Add to this section:

When sewer installation requires tapping into an existing manhole or structure, the hole shall be cored to allow for appropriate pipe sizing. This work shall be considered incidental to the installation of the pipe and no additional compensation will be allowed.

701-3.11 Pipe Removal Add to this section:

This work shall consist of removal of existing pipes of various types and sizes. This work shall also consist of removal of existing manholes, inlets, culvert ends, headwalls and other drainage structures of various types and sizes shown on the plans. Trenches, holes or pits resulting from the various types of removals shall be backfilled and compacted in accordance with Section 701-3.7. Openings due to pipe removals at existing drainage structures to remain in place shall be patched with brick and mortar as directed by the Resident Engineer. Pipe and other structures removed under this item shall be disposed of by the Contractor off airport property.

METHOD OF MEASUREMENT

701-4.1 Add this section:

The quantity of pipe removal to be paid for shall be the number of lineal feet of pipe removed and accepted by the Resident Engineer. No measurements or other allowances shall be made for the removal of existing manholes, inlets, culvert ends, headwalls and other drainage structures of various types and sizes shown to be removed on the plans.

BASIS OF PAYMENT

701-5.1 Add to this section:

Payment shall be made at the contract unit price per lineal foot of pipe removal which shall be full compensation for pipe removal, manhole removal, inlet removal, culvert end removal, headwall removal and removal of other drainage structures shown on the plans. This shall include removal, hauling the item away, and backfilling and for furnishing all materials, labor, equipment, tools, and incidentals necessary to complete the item.

Payment will be made under:

Item AR701512	12" RCP, Class IV	-	per lineal foot.
Item AR701530	30" RCP, Class IV	-	per lineal foot.
Item AR701900	Remove Pipe	-	per lineal foot.

ITEM AR751 – MANHOLES, CATCH BASINS, INLETS AND INSPECTION HOLES.

Item 751 "Manholes, Catch Basins, Inlets and Inspection Holes" is modified as outlined below.

DESCRIPTION

751-1.1 Add to this section:

This item of work shall also consist of adjusting the frame, with grates or lids, to grade, of existing catch basins, manholes, inlets, or valve vaults and other drainage structures of various types and sizes shown on the plans.

MATERIALS

751-2.9 Add this section:

Manholes 4' and 5' in diameter shall conform to IDOT Standard Detail 602401. They shall be constructed with the alternate precast reinforced concrete flat slab tops according to IDOT Standard Detail 602601. The flat slab tops shall be considered incidental to the manholes and no additional compensation will be allowed. Closed manhole lids shall be stamped "STORM".

751-2.10 Add this section:

The Type B Catch Basin shall conform to IDOT Standard Detail 602006 except that the baffles called for in the detail are optional. The shop drawings the Contractor submits shall be specific in detail as to whether the baffles will be included or not.

CONSTRUCTION METHODS

751-3.11 Adjusting Add this section:

Adjusting or replacing castings.

- (a) Placing for Rigid Pavements. Castings placed on concrete or masonry surfaces shall be set in full mortar beds. Castings shall be set to the finished pavement elevation so no subsequent adjustment will be necessary. Lifting devices will be approved by the Engineer.
- (c) Placing for Flexible Pavements. The structures shall be constructed or adjusted to an elevation which will match the cross section of the subgrade. After the base course and binder course have been placed, and prior to placing the surface course where there is no binder course, the structures shall be adjusted to grade by removing the binder and base course adjacent to and for a distance not exceeding 12" outside the base of the castings. After the structures have been adjusted, the castings shall be set in full mortar beds. Castings shall be set to the finished pavement elevation so that no subsequent adjustment will be necessary, and the space around the casting shall be filled with Class SI Concrete, or a bituminous concrete surface or binder course material to the elevation of the surface of the base course or binder course. If Class SI Concrete is used, it shall be cured for a period of 72 hours. If surface or binder course material is used, it shall be placed in 75 mm (3 in.) layers at the temperature requirements for the placing of surface or binder course and compacted with a pneumatic tamper.

751-3.12 Adjusting Rings Add this section:

Adjustment of frames and grates may be accomplished through the use of approved adjusting rings. Adjusting rings shall be gray, ductile iron or structural steel. Structural steel rings shall be prefabricated as a one piece assembly. The adjusting rings shall be designed to provide a structural capacity equal to or greater than the existing or specified frame and shall not affect the opening size or surface appearance. The rings shall have a device for positively positioning and securely fastening the ring to the existing frame so as to match and maintain the surface grade and slope and prevent movement under traffic loadings.

METHOD OF MEASUREMENT

751-4.2 Add this section:

The number drainage structures adjusted to be paid for shall be the number of structures shown in the plans to be adjusted or as ordered by the Resident Engineer.

BASIS OF PAYMENT

751-5.2 Add this section:

Payment will be made at the contract unit price per each for adjusting manholes. This price shall be full compensation for furnishing all materials for all preparation and installation of these materials, including all frames, grates, lids, adjusting rings, concrete and bituminous material and for all labor, equipment, tools, and incidentals necessary to complete this item.

Payment will be made under:

Item AR751411	Inlet – Type A	-	per each.
Item AR751415	Inlet - Special	-	per each.
Item AR751540	Manhole 4'	-	per each.
Item AR751550	Manhole 5'	-	per each.
Item AR751602	Catch Basin, Type B	-	per each.
Item AR751943	Adjust Manhole	-	per each.

APPENDIX 1

Policy Memorandum 04-03

*Acceptance Procedure for Finely Divided Minerals Used
In Portland Cement Concrete and Other Applications*

12 Pages

**State of Illinois
Department of Transportation
Bureau of Materials and Physical Research**

POLICY MEMORANDUM

January 15, 2004

Springfield

04-03

TO: DISTRICT ENGINEERS, HIGHWAY BUREAU CHIEFS, AND
MANUFACTURERS AND SUPPLIERS OF FINELY DIVIDED MINERALS

SUBJECT: ACCEPTANCE PROCEDURE FOR FINELY DIVIDED MINERALS USED
IN PORTLAND CEMENT CONCRETE AND OTHER APPLICATIONS

DEFINITIONS

Department - Illinois Department of Transportation.

Bureau - Bureau of Materials and Physical Research, at 126 East Ash Street, Springfield, Illinois 62704-4766.

Finely Divided Mineral - A finely divided material which has cementitious or pozzolanic properties. Examples are fly ash, microsilica (silica fume), ground granulated blast-furnace (GGBF) slag, and high-reactivity metakaolin (HRM).

Manufacturer - A company that manufactures a finely divided mineral. The term Producer is also used.

Supplier - A company that supplies a finely divided mineral which it does not manufacture.

Source - The name and location of the manufacturing process from which the finely divided mineral is obtained.

Approved Source - A source that is approved by the Bureau to ship a finely divided mineral for immediate use on Department projects.

Unapproved Source - A source that ships a finely divided mineral which must be sampled, tested, and approved by the Bureau before it is used on Department projects.

Cement - Portland cement.

Fly Ash - A finely divided residue that results from the combustion of ground or powdered coal, transported from the combustion chamber by exhaust gas, collected by mechanical or electrical means, and stored in stockpiles or bins.

Microsilica - An amorphous silica of high silica content and purity possessing high pozzolanic activity.

Ground Granulated Blast-Furnace (GGBF) Slag - A glassy granular material, formed when molten blast-furnace slag is rapidly chilled, and then finely ground.

High-Reactivity Metakaolin (HRM) - A reactive aluminosilicate pozzolan formed by calcining purified kaolinite at a specific temperature range.

Reference Material - A portland cement used for the control mortar and corresponding test mortars, of a finely divided mineral, to determine its strength activity index.

Preliminary (PRE) Sample - A sample used to determine, in advance, if the finely divided mineral will comply with Department specifications.

Process Control (PRO) Sample - A sample used for the purpose of controlling production of finely divided minerals proposed for incorporation into Department projects.

Acceptance (ACC) Sample - A sample used for accepting/rejecting finely divided minerals prior to its use on Department projects and/or unassigned stock for future use on projects. The quantity represented by acceptance samples must be given.

Independent Assurance (IND) Sample - A sample used to provide an independent check on the reliability of the manufacturer's quality control program.

Investigation (INV) Sample - A destination sample used to verify the acceptability of a finely divided mineral from a source.

Grab Sample - A sample secured from a conveyor, from bulk storage, or from a bulk shipment in one operation.

Composite Sample - Combined grab samples taken at prescribed intervals over a period of time.

NIST - National Institute of Standards and Technology.

CCRL - Cement and Concrete Reference Laboratory.

ISO 9000 Series - A program of international quality management system standards developed by the International Organization for Standardization (ISO).

1.0 PURPOSE

To establish procedures whereby materials of mineral origin, furnished by a **Manufacturer** or **Supplier**, will be accepted for use on **Department** projects.

2.0 SCOPE

This procedure is available to all **Manufacturers** or **Suppliers** of domestic and foreign **Finely Divided Minerals**. **Sources** in North America may be **Approved** or **Unapproved**. **Sources** located outside of North American will not be given **Approved Source** status, and the procedures in Sections 5.1 and 5.3 shall apply.

3.0 SPECIFICATION REQUIREMENTS, SAMPLING, AND TEST PROCEDURES

- 3.1 **Finely Divided Minerals** used on **Department** projects shall meet the material requirements of the **Department's** "Standard Specifications for Road and Bridge Construction", dated January 1, 1997, and current special provisions.
- 3.2 **Fly Ash** used on **Department** projects shall meet the standard physical and chemical requirements of AASHTO M 295, "Fly Ash and Raw or Calcined Natural Pozzolan for Use as a Mineral Admixture in Portland Cement Concrete," for Class C or Class F. A limitation of available alkalis, as Na₂O, of 1.5%, shall apply to fly ashes used in portland cement concrete mixtures and cement aggregate mixture II containing alkali-sensitive aggregates or admixtures.
- 3.3 **GGBF Slag** used on **Department** projects shall meet the standard physical and chemical requirements of AASHTO M 302, "Ground Iron Blast-Furnace Slag for Use in Concrete and Mortars," for a Grade 100 or a Grade 120 material.
- 3.4 **Microsilica** used on **Department** projects shall meet the standard physical and chemical requirements of AASHTO M 307, "Microsilica for Use in Concrete and Mortar," except that the Strength Activity Index requirement shall not apply. The **Microsilica** shall meet the "Accelerated pozzolanic activity index: With portland cement at 7 days," as specified by ASTM C 1240, "Standard Specification for Silica Fume for Use as a Mineral Admixture in Hydraulic-Cement Concrete, Mortar, and Grout." A limitation of available alkalis, as Na₂O, of 1.5% shall apply to **Microsilica** used in mixtures containing alkali-sensitive aggregates or admixtures.

- 3.5 **High-Reactivity Metakaolin (HRM)** used on **Department** projects shall meet the standard physical and chemical requirements of AASHTO M 295, "Fly Ash and Raw or Calcined Natural Pozzolan for Use as a Mineral Admixture in Portland Cement Concrete," for Mineral Admixture Class N, except that the Strength Activity Index requirement shall not apply. The **HRM** shall meet the "Accelerated pozzolanic activity index: With portland cement at 7 days," as specified by ASTM C 1240, "Standard Specification for Silica Fume for Use as a Mineral Admixture in Hydraulic Cement Concrete, Mortar, and Grout." A limitation of available alkalis, as Na₂O, of 1.5%, shall apply to **HRM** used in mixtures containing alkali-sensitive aggregates or admixtures.

4.0 APPROVED SOURCE PROCEDURE

- 4.1 A **Manufacturer** or **Supplier** requesting **Source** approval of a **Finely Divided Mineral** shall provide the following to the **Bureau**:

- (1) The **Manufacturer's** or **Supplier's** name and location.
- (2) The **Source** name, location (station), and number of generating units.
- (3) The name of the **Finely Divided Mineral** and its class or grade.
- (4) A certification that the **Finely Divided Mineral** meets the applicable requirements of Section 3.0.
- (5) A 6-month testing history.
- (6) A copy of the **Manufacturer's** or **Supplier's** quality control program.
- (7) A copy of the last **CCRL** inspection report of the testing laboratory used by the **Manufacturer** or **Supplier** of the **Finely Divided Mineral**, with documentation of resolution of any discrepancies noted therein. The **Manufacturer** or **Supplier** of **HRM** or **Microsilica** shall provide a copy of the testing laboratory's **CCRL** inspection report and/or an **ISO 9000 Series** certificate.
- (8) A copy of the Material Safety Data Sheet (MSDS) for the **Finely Divided Mineral**.

At the time of application, the **Manufacturer** or **Supplier** shall obtain a **Preliminary (PRE) Grab Sample** of the **Finely Divided Mineral** from current production. The **Manufacturer** or **Supplier** shall split the **PRE Sample** and place one portion in an airtight container and deliver it to the **Bureau**. A sample of the **Reference Material** used by the **Manufacturer** or **Supplier** for testing shall be included. The **Manufacturer** or **Supplier** shall assume the cost to deliver the samples to the **Bureau**. The size of the **Bureau's** portion of the **PRE Sample**, and the **Reference Material**, shall not be less than 3 kg (6 lb.) each and the samples shall be properly identified as required in Attachment 1. The **Manufacturer** or **Supplier** shall test the retained portion of the **PRE Sample** for

the standard physical and chemical properties listed in the applicable specification in Section 3.0 and deliver a copy of the test results to the **Bureau** for comparison.

The **Bureau** will test its portion of the **PRE Grab Sample** for conformance to Section 3.0. The **Bureau** will compare the results obtained by both laboratories to determine compliance with the allowable difference between two laboratories set forth in the precision statement of each test method. Additional split sample testing will be required if the test results obtained on the **PRE Grab Sample** do not comply with the specification requirements of this policy memorandum.

An inspector from the **Bureau** may conduct a scheduled visit to inspect the laboratory facilities designated by the **Manufacturer** or **Supplier** to test the **Finely Divided Mineral**; the **Source** manufacturing process, the **Source** storage facilities; and the quality control policies, procedures, and practices used by the **Manufacturer** or **Supplier**. The **Manufacturer** or **Supplier** shall be responsible for payment of transportation, per diem (meals), lodging, and incidental travel costs incurred by the **Department**.

The **Bureau** will notify the **Manufacturer** or **Supplier**, in writing, if the request for **Approved Source** status is granted or denied. A request may be denied if the **Manufacturer** or **Supplier** fails to meet the requirements of this policy memorandum, or for other reasons determined by the **Department**.

4.2 Quality Control Requirements For **Approved Sources**:

The **Manufacturer** or **Supplier** shall establish and maintain quality control policies and procedures for sampling and testing that are approved by the **Bureau**. The **Bureau** shall be notified of any changes in the **Manufacturer's** or **Supplier's** quality control program.

Testing laboratories used by the **Manufacturers** or **Suppliers** of **Fly Ash** or **GGBF Slag** shall participate in the **CCRL** pozzolan program of the **NIST**, which includes inspection of facilities and testing of comparative samples. Testing laboratories used by the **Manufacturers** or **Suppliers** of **Microsilica** or **HRM** shall participate in the **CCRL** pozzolan program of the **NIST** and/or shall have implemented a quality management system based on the **ISO 9000 Series** standards.

4.3 Reporting Requirements For **Approved Sources**:

The **Manufacturer** or **Supplier** shall deliver a test report to the **Bureau** each month listing the results of all **Grab** and **Composite Samples** taken and tested for the month. Sampling, testing, and reporting shall be done according to the applicable specification in Section 3.0.

4.4 Record Requirements For **Approved Sources**:

Records of production control tests shall be maintained by the **Manufacturer** or **Supplier** for a minimum period of 5 years, and shall be made available to the **Bureau** upon request.

Copies of bills of lading of quantities of **Finely Divided Minerals** shipped shall be maintained by the **Manufacturer** or **Supplier** for a minimum period of 3 years, and shall be made available to the **Bureau** upon request.

4.5 Sampling and Test Requirements for **Approved Sources**:

Each January, April, July, and October (unless otherwise specified by the **Bureau**) the **Manufacturer** or **Supplier** shall obtain a **Process Control (PRO) Grab Sample** of the **Finely Divided Mineral**, which shall be split for testing by the **Manufacturer** or **Supplier** and the **Bureau**. At this time, a sample of the current **Reference Material** used by the **Manufacturer** or **Supplier** for testing shall also be split. The **Bureau** samples shall be placed in airtight containers, properly identified as required in Attachment 2, and immediately delivered to the **Bureau**. Each **Finely Divided Mineral** sample and **Reference Material** sample shall not be less than 3 kg (6 lb).

The **Manufacturer** or **Supplier** shall test the retained portion of each **PRO Sample**, using the retained portion of the **Reference Material**, for the standard physical and chemical properties listed in the applicable specification in Section 3.0. When all tests are completed, the **Manufacturer** or **Supplier** shall record the test results on a report form that identifies the sample as a **PRO Sample**, and promptly deliver the report to the **Bureau**.

The test results obtained by the **Manufacturer** or **Supplier** and the **Bureau** on all split samples will be compared for compliance with the allowable differences for two laboratories set forth in the precision statement of each test method and for compliance with Section 3.0. If significant differences exist in the split sample test results, the **Department** will investigate sampling and test procedures, or require additional comparative sampling to determine the cause of the variation.

4.6 **Department** Inspections of **Approved Sources**:

An inspector from the **Bureau** may conduct unscheduled visits, at **Department** expense, to each **Approved Source** or one of its terminals. During this visit, the inspector will either take or witness the taking of a random **Independent Assurance (IND) Grab Sample**. The inspector will split the sample and deliver an equal portion to the **Manufacturer** or **Supplier**. The **Manufacturer** or **Supplier** shall test the retained portion of the split sample for the standard physical and chemical properties listed in the applicable specification and deliver the test results to the **Bureau**, as specified in Section 4.5, for comparison and compliance with Section 3.0.

Random **Investigation (INV) Samples** of the **Finely Divided Minerals** and the project **Cement** will be obtained at final destination by a representative of the **Department**. The representative will either take or witness the taking of the **INV Samples**. **INV Samples** will be **Grab Samples** and shall not be less than 3 kg (6 lb). (Note: **Cement** samples will be taken according to ASTM C 183). The sampling location and frequency for obtaining **INV Samples** will be determined by the **Bureau** in consultation with the district offices.

The **Bureau** will test **INV Samples** to ascertain the results of **Finely Divided Mineral-project Cement** combinations. To verify that **Finely Divided Minerals** shipped from **Approved Sources** meet the requirements of Section 3.0, the **Bureau** will test **INV Samples** with the appropriate **Reference Material**.

4.7 Revocation of **Approved Source** Status:

Failure of a **Manufacturer** or **Supplier** to meet the requirements of Sections 3.0 and 4.0 of this policy memorandum will be sufficient cause to revoke **Approved Source** status.

Failure to resolve significant differences in testing, as indicated by the test results obtained on **PRO** or **IND Samples** split with the **Manufacturer** or **Supplier** will be sufficient cause to revoke **Approved Source** status.

Failure of the testing laboratory, used by the **Manufacturer** or **Supplier** of a **Finely Divided Material**, to satisfactorily resolve the discrepancies noted in the **CCRL** inspection report and/or to maintain a quality management system based on the **ISO 9000 Series** will be sufficient cause to revoke **Approved Source** status.

Revocation of **Approved Source** status will be reported to the **Manufacturer** or **Supplier** in writing. The **Manufacturer** or **Supplier** may not re-apply for **Approved Source** status until 30 days have elapsed from the date of the written notice of revocation.

5.0 UNAPPROVED SOURCE PROCEDURE

5.1 A **Manufacturer** or **Supplier** requesting approval of a **Finely Divided Mineral** from an **Unapproved Source** shall provide the following to the **Bureau**:

- (1) The **Manufacturer's** or **Supplier's** name and location.
- (2) The **Source** name, location (station), and number of generating units.
- (3) The name of the **Finely Divided Mineral** and its class or grade.

- (4) A current test report, in English, which indicates the standard physical and chemical composition of the **Finely Divided Mineral** as per Section 3.0.
- (5) The transportation method and location at which an inspector from the **Bureau** will be able to obtain **Acceptance (ACC) Samples**.
- (6) If requested by the **Bureau**, the **Manufacturer** or **Supplier** shall deliver to the **Bureau** a 24-hr **Composite Preliminary (PRE) Sample** of the **Finely Divided Mineral** from current shipments. The **Manufacturer** or **Supplier** shall assume the cost to deliver it to the **Bureau**. The size of the **PRE Sample** shall not be less than 3 kg (6 lb) and the sample shall be properly identified as required in Attachment 1.

5.2 Sampling and Test Requirements for **Unapproved Sources** in North America:

- (1) **Finely Divided Minerals** from an **Unapproved Source** will be sampled, tested, and approved by the **Bureau** before use on **Department** projects. The **Bureau** has the option to affix a seal to secure **Finely Divided Minerals** in storage (e.g. silo, truck, railroad car, or barge) until the **Bureau's** testing is completed.
- (2) Upon arrival of the **Finely Divided Mineral** to Illinois, an inspector from the **Bureau** will obtain **Acceptance (ACC) Grab Samples** according to the applicable specifications. The **Bureau** will determine the number of representative samples required.
- (3) The **Manufacturer** or **Supplier** may request the **Bureau** to sample the **Finely Divided Mineral** prior to arrival in Illinois. In the event the request is approved, the **Manufacturer** or **Supplier** shall be responsible for payment of transportation, per diem (meals), lodging, and incidental travel costs incurred by the **Department** inspector. If the **Department** determines that it lacks the resources to accomplish out-of-state inspection, the **Finely Divided Mineral** may be sampled and tested according to the procedures in Section 5.3.
- (4) **Acceptance (ACC) Samples** will be tested by the **Bureau** for conformance to Section 3.0, and to approve the **Finely Divided Mineral** for use on **Department** projects.
- (5) **Random Investigation (INV) Samples** of **Finely Divided Minerals** may be obtained at final destination by a representative of the **Department**. The representative will either take or witness the taking of the **INV Samples**. **INV Samples** will be **Grab Samples** and will be taken according to the applicable specification. The sampling location and frequency for obtaining **INV Samples** will be determined by the **Bureau** in consultation with the district offices. The **Bureau** will use **INV Samples** to verify that the **Finely Divided Mineral** shipped meets the requirements of Section 3.0.

5.3 Sampling and Test Requirements for **Unapproved Sources** Located Outside North America:

An agent of the importer shall obtain an **Independent Assurance (IND) Grab Sample** from each barge of foreign **Finely Divided Mineral** loaded at the port of entry and destined for Illinois.

The agent shall split each barge **Grab Sample** and mail one portion to the **Bureau**. The other portion shall be mailed to the importer's testing laboratory that is approved by the **Department**. The importer of the **Finely Divided Mineral** shall be responsible for all sampling and mailing costs.

The importer's laboratory shall test its portion of each barge **Grab Sample** for the standard physical requirements of the applicable specifications. One random barge **Grab Sample**, representing the **Finely Divided Mineral** in each hold of the vessel shall be tested for chemical composition.

Upon completion of the tests, the importer shall deliver to the **Bureau** a certification that states the **Finely Divided Mineral** in the vessel unloaded at the port of entry has been tested by the importer, and complies with the applicable specifications. Attached to the certification shall be a test report of all barge samples. The report shall include the name of the vessel, the source of the **Finely Divided Mineral**, the barge number, the hold number, the date the sample was taken, the quantity of **Finely Divided Mineral** in the barge, and the physical and chemical test results obtained on the samples.

The importer shall immediately notify the **Bureau** if a barge sample fails to meet the applicable specification requirements.

The **Bureau** will review the certification and compare the importer's test data to the test data obtained by the **Bureau** on its portion of each split sample.

When the certification and the accompanying test report are examined and determined to be correct, the **Bureau** will notify the importer and the district offices that the **Finely Divided Mineral** is approved for state projects.

Random Investigation (INV) Samples, from one or more barges, may be taken by a **Department** inspector when the barges arrive at the Illinois terminal(s).

The **Department** will reject any foreign **Finely Divided Mineral** tested by the **Bureau**, or the importer, that does not meet the specification requirements. The **Department** may reject any barge of **Finely Divided Mineral** wherein the differences in test values, obtained by the **Department** and the importer on the split sample, exceeds the multilaboratory precision of the test method, but the **Finely Divided Mineral** is within specifications.

Alternative proposals to the sampling and test requirements stated in this section will be considered for **Finely Divided Minerals** which have an acceptable quality history, and which have previously been approved by the **Department**. Requests shall be directed to the **Bureau of Materials and Physical Research** for approval.

6.0 ACCEPTANCE OF FINELY DIVIDED MINERALS

- 6.1 **Finely Divided Minerals** will be accepted according to the **Department's** current "Standard Specifications for Road and Bridge Construction," current special provisions, and this policy memorandum.
- 6.2 The **Bureau** will maintain and circulate a current list of **Approved Sources of Finely Divided Minerals** which meet the requirements of this policy memorandum. This list will include the name, location, and Producer/Supplier Number of each approved **Manufacturer** or **Supplier** of **Finely Divided Minerals**. These **Manufacturers** or **Suppliers** may ship **Finely Divided Minerals** for immediate use on **Department** projects.
- 6.3 **Finely Divided Minerals** from **Unapproved Sources** will be approved by the **Bureau** before use on **Department** projects.

7.0 REJECTION OF FINELY DIVIDED MINERALS

- 7.1 A **Finely Divided Mineral** that fails to conform to the requirements of Section 3.0 of this policy memorandum shall be rejected for use on **Department** projects.
- 7.2 The **Bureau** will notify the **Manufacturer** or **Supplier** when a **Finely Divided Mineral** is rejected for use on **Department** projects.

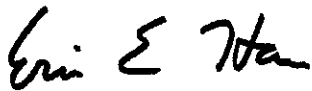

Eric E. Harm, P.E.
Engineer of Materials
and Physical Research

Attachments

This policy memorandum supersedes Policy Memorandum 99-5 dated April 1, 1999.

DAD/dsg

PRE SAMPLE IDENTIFICATION

MEMO TO: Illinois Department of Transportation
Bureau of Materials and Physical Research

SUBJECT: Preliminary (PRE) Sample

DATE: _____

The enclosed Preliminary (PRE) Sample is submitted to the Bureau of Materials and Physical Research for testing:

This PRE Sample is identified as follows:

1. Manufacturer/Supplier Name: _____
2. Material Name (i.e. Fly Ash, GGBF Slag, etc.): _____
3. Material Class or Grade: _____
4. Name and Location of Source of Material: _____

5. Date Sample Was Taken: _____
6. Identification Number (If Used): _____
7. Sample Taken From (i.e. Truck, Silo, etc.): _____
8. Remarks: _____

Instructions: Include this sample identification sheet with each PRE Sample and mail to:

Illinois Department of Transportation
Bureau of Materials and Physical Research
126 East Ash Street
Springfield, Illinois 62704-4766
ATTN: J. R. Oglesby, Cement Technology Engineer

PRO SAMPLE IDENTIFICATION

MEMO TO: Illinois Department of Transportation
Bureau of Materials and Physical Research

SUBJECT: Process Control (PRO) Sample

DATE: _____

The enclosed Process Control (PRO) Sample is submitted to the Bureau of Materials and Physical Research for testing:

This PRO Sample is identified as follows:

1. Manufacturer/Supplier Name: _____
2. Material Name (i.e. Fly Ash, GGBF Slag, etc.): _____
3. Material Class or Grade: _____
4. Name and Location of Source of Material: _____

5. Date Sample Was Taken: _____
6. Identification Number (If Used): _____
7. Sample Taken From (i.e. Truck, Silo, etc.): _____
8. Remarks: _____

Instructions: Include this sample identification sheet with each PRO Sample and mail to:

Illinois Department of Transportation
Bureau of Materials and Physical Research
126 East Ash Street
Springfield, Illinois 62704-4766
ATTN: J. R. Oglesby, Cement Technology Engineer

APPENDIX 2
Policy Memorandum 87-2
Density Acceptance of Bituminous Pavements
4 Pages

State of Illinois
Department of Transportation
Division of Aeronautics

POLICY MEMORANDUM

January 1, 2004

Springfield

Number: 87-2

TO: CONSULTING ENGINEERS

SUBJECT: DENSITY ACCEPTANCE OF BITUMINOUS PAVEMENTS

1. Introduction

This Policy Memorandum deals with the implementation of the Bituminous Density Quality Assurance specifications as a revision to the Standard Specification for Construction of Airports, January 1985. These revisions are to Item 201 Bituminous Base Course, and Item 401 Bituminous Surface Course.

II. Sampling

After completion of compaction and the pavement has reached ambient temperature, the paved area shall be divided into Sublots of 500 tons per type of mix. One core sample (2 cores per sample) shall be taken from each Sublot. The longitudinal and transverse location for each sample shall be determined by use of a random number "Deck" provided by the Division. No core shall be taken closer than two (2) feet from the edge of the mat. A core extraction device as illustrated by the attachment is recommended. All cores are to be taken by the contractor under the supervision and remain in the possession of the engineer. It is imperative that the Engineer and the contractor realize that the cores are "Money" and that improper coring, extraction, shipping and/or testing can be costly.

One mix sample per 1000 tons of mix laid shall be taken for Extraction, Maximum Specific Gravity (G_{mm}) and Air Void tests. The mix samples shall be sampled by the contractor and split in half.

The Resident Engineer shall randomly designate and send the split samples to an independent laboratory for testing. The laboratory will be designated by the Division of Aeronautics. The frequency of testing split samples shall be 1 per 5000 tons. Higher frequencies may be necessary if the contractor's tests, and/or mix quality control are inconsistent.

III. Testing

All cores shall be tested for Bulk Specific Gravity (G_{sb}) in accordance with ASTM D2726 using Procedure 9.1, "For Specimens That Contain Moisture". The Theoretical Maximum Gravity (G_{mm}) shall be determined according to ASTM D2041, Procedure 7. From these tests the in-place air voids of the compacted pavement are calculated according to ASTM D3203 for "dense bituminous paving mixtures". Selection of the proper G_{mm} shall be based on a running average of four (4) tests per Lot.

Eg. Lot 1 - Use the average of the two (2) tests for Lot 1.

Lot 2 - Use the average of the four (4) tests from Lots 1 and 2.

Lot 3 - Use the average of the four (4) tests from Lots 2 and 3.

NOTE: When more than four (4) Sublots are used, still use a running average of four (4) tests per Lot.

IV. Acceptance Calculations

The first step in calculating the quantities for pay is to calculate the Mean (\bar{x}) and the Standard Deviation (S) of the Sublot tests. From this data the Lot samples should first be tested for outliers. After consideration for outliers, the Percent Within Tolerance (PWT) and the Percent Within Limits (PWL) are calculated to determine the final pay quantities for the Lot.

EXAMPLE

1. Test Data

Lot Quantity = 2000 tons
Sublot Test 1 = 4.35 % Air
Sublot Test 2 = 3.96 % Air
Sublot Test 3 = 6.75 % Air
Sublot Test 4 = 6.25 % Air

2. Calculating the Mean and Standard Deviation

Sublot	\underline{x}	$(x - \bar{x})$	$(x - \bar{x})^2$
1	4.35	- 0.978	0.956
2	3.96	- 1.368	1.871
3	6.75	1.422	2.022
4	<u>6.25</u>	0.922	<u>0.850</u>
Sum =	21.31		5.699

$$N = 4$$

$$\text{Mean}(\bar{x}) = 5.328$$

$$\text{Variance } (S)^2 = \frac{\text{Sum}(x - \bar{x})^2}{3} = \frac{5.699}{3} = 1.900$$

$$\text{Standard Deviation } S = \sqrt{1.900} = 1.378$$

3. Test For Outliers

Check for Critical "T" Values

$$T = \frac{|(x_1 - \bar{x})|}{S} = \frac{|3.96 - 5.328|}{1.378} = 0.99$$

* Difference between the suspect test value (x_1) and the Mean (\bar{x}).

If the T value exceeds the critical "T" Value in the table below and no assignable cause can be determined for the outlier, discard the suspected test measurement and obtain another random sample from the Lot in question. If the new test exceeds the Mean (\bar{x}) in the same direction from the Mean as the suspected test, recalculate the T value including all tests (original test, suspected test, and new test) for an outlier and for computing final payment.

TABLE OF CRITICAL "T" VALUES

Number of observations (N)	Critical "T" Value 5% Significance Level
3	1.15
4	1.46
5	1.67
6	1.82
7	1.94
8	2.03
9	2.11
10	2.18
11	2.23
12	2.29

Based on the above table, the "T" value of 0.99 does not exceed the Critical "T" Value of 1.46 for N = 4. Therefore, the value (3.96) is not an outlier and shall be used in calculating the Lot payment.

4. Calculation of Lot Payment

To calculate the Lot Payment use the Acceptance Criteria as outlined under Item 201-4.13(c) or Item 401-4.13(c).

$$Q_L = \frac{(\bar{x} - 1)}{S} = \frac{5.328 - 1}{1.378} = 3.141$$

$$Q_u = \frac{(7 - \bar{X})}{S} = \frac{7 - 5.328}{1.378} = 1.213$$

From this data the Percentage Within Tolerance (PWT) for both the lower and upper tolerance limits is determined by Table 8 of the specifications for the number (N) of samples tested.

$$\begin{aligned} \text{Eq. PWT (lower)} &= 99.0\% \\ \text{PWT (upper)} &= 90.4\% \end{aligned}$$

We now calculate the Percent Within Limits (PWL) for the Lot.

$$\begin{aligned} \text{PWL} &= [\text{PWT (lower)}] + [\text{PWT (upper)}] - 100 \\ \text{PWL} &= (99.0 + 90.4) - 100 = 89.4\% \end{aligned}$$

Using Table 7, the % Adjustment in Lot Quantity is:

$$\begin{aligned} \% \text{ Adjustment} &= 0.5 \text{ PWL} + 55.0 \\ \% \text{ Adjustment} &= 0.5 (89.4) + 55.0 \\ \% \text{ Adjustment} &= 99.7 \end{aligned}$$

$$\begin{aligned} \text{Adjusted Quantities} &= \% \text{ Adjustment} \times \text{Lot Quantities} \\ \text{Adjusted Quantities} &= .997 \times 2000 \text{ tons} \\ \text{Adjusted Quantities} &= 1994 \text{ tons} \end{aligned}$$

5. Resampling and Retesting

Under the specifications the contractor has the right to request the resampling and retesting of a complete Lot. This privilege is only allowed once for each Lot and must be requested in writing by the contractor within 48 hours of receiving the official report from the Engineer.

6. Reporting

After completion of the tests for each Lot, the Engineer shall complete the necessary calculations for final adjustment in quantities on the Form AER M-1 and have both the Engineer and the Contractor sign the report for copying to both the FAA and IDOA.

Steven J. Long, P.E.
Acting Chief Engineer

Supersedes Policy Memorandum 87-2, dated January 1, 1999.

APPENDIX 3

Policy Memorandum 87-3
*Mix Design, Test Batch, Quality Control and
Acceptance Testing of PCC Pavement Mixture*
4 Pages

State of Illinois
Department of Transportation
Division of Aeronautics

POLICY MEMORANDUM

July 31, 2004

Springfield

Number: **87-3**

TO: CONSULTING ENGINEERS

SUBJECT: MIX DESIGN, TEST BATCH, QUALITY CONTROL, AND ACCEPTANCE
TESTING OF PCC PAVEMENT MIXTURE

I. SCOPE

This Policy Memorandum addresses the Mix Design, Test Batch, Quality Control and Acceptance Testing of PCC pavement mixtures specified by Item 501, Portland Cement Concrete Pavement, in accordance with the Standard Specifications for Construction of Airports, effective January 1985, Special Provisions, and policies of the Division of Aeronautics.

II. MIX DESIGN

Prior to the start of paving operations and after approval by the Division of Aeronautics (IDOA) of all materials to be used in the manufacture of the concrete, the contractor shall provide a preliminary mix design(s) for evaluation at the Test Batch. The mix design shall indicate saturated surface dry batch weights per cubic yard for each material component. In addition, each material component, including chemical admixtures, shall be identified by the IDOT material code number, the IDOT producer code number, and the producer name and location. Saturated surface dry and oven dry specific gravities, as well as absorption values, for each proposed aggregate to be used in the mix shall be indicated on the mix design. When requested in writing by the contractor, the Engineer will recommend a preliminary mix design for evaluation at the Test Batch.

The Mix Design and the contractor's approved Job Mix Formula (JMF) will be issued by our office subject to verification of the mix by strength tests obtained from mix prepared from a Test Batch(es) according to the approved JMF. The water-cementitious ratio established from the approved test batch is the maximum water-cementitious ratio allowed during production paving. Whether the contractor selects his own mix design or chooses to use the mix design recommended by the Division, the contractor is responsible for the mix design, as well as the manufacture and placement of the mix.

III. TEST BATCH

At least 28 days prior to the start of production, the contractor and/or producer shall prepare a Test Batch under the direction of the Engineer. The Test Batch shall be prepared at the concrete plant proposed for use in the production of the concrete mix for the project and shall be in accordance with the approved Job Mix Formula (JMF). When approved by the Engineer, the Test Batch may be prepared at a different plant provided that the same materials specified in the JMF are used. The plant shall have been

surveyed and approved by the Engineer prior to preparation of the Test Batch. As required by these Special Provisions, the contractor shall provide Quality Control for production of the concrete. The contractor shall have his Quality Control Manager and a representative of the contractor familiar with the paving operation, present at the Test Batch preparation. The Test Batch shall be prepared as follows:

A. Proportioning

Prior to preparation of the mix, the Proportioning Technician shall perform a minimum of two (2) gradation analysis and two (2) moisture tests on each aggregate used. The gradation analysis shall be reported on form AER M-12, Side 1. From this data, the JMF shall be adjusted for moisture, in accordance with form AER M-12, Side 2. A microwave type moisture probe (or equal) may be allowed to adjust proportions for sand moisture when approved by the Engineer.

B. Preparation of the Mix:

- 1.) Prepare a Test Batch that is at least one-half (1/2) the manufacturer's rated capacity of the mixing drum (in cubic yards). The Test Batch shall be prepared with the approved JMF, adjusted for moisture.
- 2.) Mixing requirements shall be:
 - a.) Central Mix Plant: Mixing time shall be a minimum of 90 seconds. If transit mixer trucks are used to transport the mix, the mix shall be agitated, after mixing, at 2-5 RPM for the approximate time anticipated between batching at the plant and deposit of the concrete in the forms. If non-mixing trucks are used to transport the mix, the mix shall remain in the central mixer with no mixing or agitation for the approximate time anticipated from when the water contacts the cement and deposit of the concrete in the forms.
 - b.) Transit Mix Plant: Mixing shall consist of 70-100 Revolutions @ 5-16 RPM. After initial mixing, agitate mix at 2-5 RPM for the approximate time anticipated between batching at the plant and deposit of the concrete in the forms.
- 3.) Slump and Air: If the air content after aging is $6.0\% \pm 1.5\%$ and provides the required workability for paving, the contractor will make cylinders for testing at 3, 7, 14 and 28 days. If the slump is below that required for placement, the contractor may add additional water to increase the slump as necessary up to the maximum water/cement ratio (or water/cementitious material) ratio listed herein. Additional mixing of at least 40 Revolutions will be required with each addition of water. Cylinders and/or beams will be made for testing at 3, 7, 14 and 28 days when the slump is obtained, at $6.0\% \pm 1.5\%$ air content. The water/cement ratio (or water/cementitious material) ratio cannot exceed 0.44 based on actual batch weights when 501-3.6(A) proportions is specified, and 0.42 when 501-3.6(B) proportions is specified.
- 4.) The Proportioning Technician shall complete Form AER M-7, Plastic Concrete Air, Slump and Quantity and Form AER M-6, Concrete Moisture Determination

(Adjusted Oven Dry Method), to be given to the Resident Engineer after completion of the Test Batch. The Flask Method, Dunagan Method, and Pycnometer Jar Method are also acceptable test methods for the determination of aggregate moisture.

- 5.) The Resident Engineer and contractor shall complete Form AER M-4, Concrete Plant Production, Mix Verification.
- 6.) The concrete test cylinders and/or beams shall be tested at 3, 7, 14 and 28 days to establish a growth curve of concrete strength vs. age. The compressive strength shall be at least 800 psi, over the specified strength, at 28 days. Flexural strength concrete shall have at least 100 psi over the specified strength at 28 days.

IV. QUALITY CONTROL

Quality control testing is the responsibility of the contractor and must be performed by qualified testing personnel approved by the Engineer. The proportioning technician shall be PCC Level II certified by the testing firm must perform his or her duties on a full time basis whenever concrete is produced for an IDOA project.

The proportioning technician shall perform the duties as outlined in the Division of Highways latest Manual of Instructions for Concrete Proportioning and Testing and as outlined as follows. These duties as outlined are not necessarily all inclusive and may include other duties as required by the specifications, special provisions, etc.

If a QC or QA test for slump, air content, or mix temperature fails to meet the requirements of the specifications the contractor shall reject the batch. In the case of a failing test of the air content, the contractor may make adjustments to the concrete to bring the air content into compliance with the specification. Adjustments are subject to the time limitations of 1 hour from time of batching when the concrete is transported in mixer trucks. Time limitations shall be increased by 30 minutes when the concrete mixture contains a retarding admixture. When concrete has been rejected due to failing test results, the contractor shall continue to run tests for the failed test parameter until at least 3 consecutive passing tests are achieved. This testing is in addition to the normal QC and QA testing.

A. Duties of the Proportioning Technician:

- 1.) Check and maintain shipment tickets of each material used in the manufacture of the concrete. These tickets are to be given to the Resident Engineer for each day's production of concrete. The aggregates shall indicate the quality on the ticket and a statement that the coarse aggregate is a non "D" cracking (freeze-thaw rated by IDOT) aggregate. In lieu of having these statements on each ticket, the contractor may use the Division's Aggregate Certification of Compliance form, or supply the Resident Engineer with a certification letter indicating the stone quality and statement of non "D" cracking compliance.
- 2.) Inspect and maintain proper storage of all aggregates and materials daily.
- 3.) Perform at least one (1) sieve analysis for each aggregate daily.
- 4.) Inspect all weighing or measuring devices daily.

- 5.) Twice daily check the actual weighing or measuring of aggregates, cement, water, and admixtures for conformance to adjusted batch proportions. Record data on Form AER M-4, Concrete Plant Production, Mix Verification, and calculate the water/cement (or water/cementitious material) ratio.
- 6.) See that the volume of the batch does not exceed the allowable capacity of the mixer and that the proper mixing time is used.
- 7.) Make at least two (2) moisture tests of each aggregate daily and correct batch weights as required.
- 8.) Adjust the dosage rates of the admixtures as required to meet concrete temperature changes and paving conditions.
- 9.) Complete AER M-7, Concrete Air, Slump and Quantity, and Form AER M-4, Concrete Plant Production, Mix Verification for each day's production and deliver same to the Resident Engineer at the end of the day for which the data pertains. Provide to the Resident Engineer load tickets for all aggregates, cement, and admixtures used in the mix.

The Resident Engineer will also be required to visit the plant twice daily on a random basis to record actual batch weights and complete Form AER M-4, Concrete Plant Production, Mix Verification. Forms AER M-4, M-7, and M-12 shall be submitted to the R.E. on a daily basis and then faxed by the R.E. to the Division of Aeronautics daily. (FAX is (217) 785-4533.)

V. ACCEPTANCE TESTING

As required by Item 501-5.3 of the Standard Specifications, acceptance and payment of the final pavement is based on the strength of either cylinders or beams taken at random during the time of construction. The pavement shall be divided into Lots of 1200 cubic yards with sublots of 300 cubic yards each. One random sample (two cylinders or one beam) shall be obtained from each subplot for testing at 28 days to calculate final payment. At the time a subplot sample is taken, one (1) slump and one (1) air test shall be taken.

In addition to the above described sample frequency, three (3), seven (7) and fourteen (14) day tests shall be taken. The Engineer may require additional tests to maintain Quality Control.

Steven J. Long, P.E.
Acting Chief Engineer

Supersedes Policy Memorandum 87-3, dated January 1, 2004.

APPENDIX 4
Policy Memorandum 87-4
Determination of Bulk Specific Gravity (d)
Of Compacted Bituminous Mixes
3 Pages

State of Illinois
Department of Transportation
Division of Aeronautics

POLICY MEMORANDUM

January 1, 2004

Springfield

Number: 87-4

TO: CONSULTING ENGINEERS

SUBJECT: DETERMINATION OF BULK SPECIFIC GRAVITY (d)
OF COMPACTED BITUMINOUS MIXES

- A. SCOPE. This method of test covers the determination of the bulk specific gravity and the percent air, of core samples from compacted bituminous mixtures using a saturated surface-dry procedure.
- B. DEFINITIONS.
1. Bulk Specific Gravity (G_{sb}) or density is the weight per unit volume (gms/cc) of a mixture in its existing state of consolidation. The volume measurement for this specific gravity will include the volume of all the aggregate, asphalt, and air spaces (voids) in the aggregate particles and between the aggregate particles.
 2. Theoretical Maximum Specific Gravity (G_{mm}) ASTM 2041 is the weight per unit volume (grams/cc) of a mixture assuming complete consolidation; i.e., all the air spaces (voids) between the aggregate particles are eliminated.
 3. Percent Density is a measure of the degree of compaction in relation to the Theoretical Maximum Specific Gravity.
 4. Percent Air is a measure of the air voids in the compacted pavement.
- C. APPARATUS.
1. Balance - The balance shall be accurate to 0.1 gm throughout the operating range. It may be mechanical or electrical and shall be equipped with a suitable suspension apparatus and holder to permit weighing of the core in water while suspended from the balance. If the balance is a beam type, it shall be set up so that the core is placed in the basket that is suspended from the zero (0) end of the balance arm.
 2. Water bath - The container for immersing the core in water while suspended from the balance shall be equipped with an overflow outlet for maintaining a constant water level. This water bath should be large enough to handle full-depth cores. When testing several cores at the same time, a dish-pan, sink or suitable container may be used for soaking.

D. PROCEDURE.

1. Prior to testing, cores shall be sorted on a flat surface in a cool place. The sample(s) shall be brushed with a wire brush and/or other suitable means, to remove all loose and/or foreign materials, such as seal coat, tack coat, foundation material, soil, paper, and foil, prior to testing.
2. If a core contains binder and surface or multiple lifts, the lifts shall be separated. This may be done in the following manner:
 - a. Mark the separation line between the two lifts.
 - b. Place the core in a freezer for 20-25 minutes.
 - c. Place a 2 or 3-inch wide chisel on the separation line and tap with a hammer. Rotate the core and continue this process until the core separates. Brush loose pieces with a wire brush if needed.
 - d. Allow 2-3 hours for the core to return to ambient temperature before proceeding.
3. Prepare the water baths for soaking and weighing with water at 77° F. Water baths should be maintained at this temperature throughout testing. Saturate the cores by submerging in the water for a minimum of 20 minutes.
4. With the balance and water bath properly assembled and zeroed, suspend the sample from the balance and submerge it in the water bath. The core must be placed with the original top and bottom in a vertical position. If necessary, add sufficient water to bring the water level up to the overflow outlet. Permit any excess to overflow. Read and record the Saturated Submerged Weight. Designate this weight as (C).
5. Remove the core from the water bath and blot the excess water from the surface of the core with an absorbent cloth or other suitable material. This must be done quickly to prevent the internal water from escaping.
6. Place the core on the balance and read and record the Saturated Surface-dry Weight in air. Designate this weight as (B).
7. Place the core in a tared pan and dry in an oven. When the core is dry, (less than 0.5 gm loss in one hour) record the weight and subtract the pan weight. Designate this weight as (A).

8. The following calculation is used to determine the Bulk Specific Gravity of the core.

$$G_{sb} = \frac{A}{B-C}$$

G_{sb} = Bulk Specific Gravity
A = Oven dry weight
B = Saturated surface-dry weight
C = Saturated submerged weight

- E. PERCENT DENSITY. The following calculation is used to determine the percent density of the core:

$$\% \text{ Density} = 100 \times \frac{G_{sb}}{G_{mm}}$$

G_{sb} = Bulk Specific Gravity
 G_{mm} = Theoretical Maximum Gravity*

Note: The Theoretical Maximum Gravity (G_{mm}) is determined from the mix design until current Vacuum Pycnometer test are available.

- F. PERCENT AIR. To calculate the percent air, use the following formula:

$$\% \text{ Air} = 100 - \% \text{ Density}$$

- G. WEIGHT PER SQUARE YARD OF COMPACTED MIXTURE. The actual weight per square yard of a compacted mixture can be calculated by using the Bulk Specific Gravity (G_{sb}). The volume of a square yard of pavement one (1) inch thick is 0.75 cubic foot. Taking the weight of a cubic foot of water as 62.37 pounds, one square yard of compacted material, one (1) inch thick weighs:

$$\text{Pounds Per Sq. Yd. (1" thick)} = 0.75 \times 62.37 \times G_{sb}$$

Steven J. Long, P.E.
Acting Chief Engineer

Supersedes Policy Memorandum 87-4 effective January 1, 1994.

APPENDIX 5
Policy Memorandum 90-1
Resampling and Retesting of PCC Pavement
2 Pages

State of Illinois
Department of Transportation
Division of Aeronautics

POLICY MEMORANDUM

January 1, 2004

Springfield

Number: 90-1

TO: CONSULTING ENGINEERS

SUBJECT: Resampling and Retesting of PCC Pavement

I. PURPOSE

1. This Policy Memorandum outlines the procedure for resampling and retesting of individual Lots of PCC Pavement for the determination of final Price Adjustment as permitted by the Special Provisions for Item 501 Portland Cement Concrete Pavement (Plain and Reinforced).

II. RESAMPLING AND RETESTING.

1. If the contractor should request the resampling and retesting of a LOT, he must notify the Engineer in writing within 24 hours of receiving the written test results and payment results for the LOT in question. The entire LOT must be resampled (no selective resampling of individual sublots will be allowed) and the contractor is not allowed to take additional cores. Once approval to resample has been granted, the Engineer will select random locations from each SUBLOT of the LOT in question and direct the contractor to drill two (2) 4 inch or 6 inch diameter cores from each location. The cores shall be obtained, cured and tested in accordance with ASTM C 42, Obtaining and Testing Drilled Cores and Sawed Beams of Concrete. The Engineer will take possession of the cores once they have been cut by the contractor.

III. CALCULATION FOR PRICE ADJUSTMENT

1. When Compressive Test Specification (501-3.6(A) Proportions) is specified. The two (2) specimens from each SUBLOT shall be averaged to constitute one SUBLOT sample. The Percent Within Limits (PWL) for the LOT shall then be calculated in accordance with Item 501-5.3, Price Adjustment, of the Special Provisions using the sampled core compressive strengths and the Compressive Test formula. The final Price Adjustment shall be based on the PWL calculated using the sampled core compressive strengths. The test results of the resampled pavement are final. All costs associated with resampling, including, but not limited to testing, curing, and coring the concrete samples shall be borne by the contractor, regardless as to whether the test results increase or decrease calculated payment quantity of concrete pavement.
2. When Flexural Test Specification (501-3.6(B) Proportions) is specified. The two (2) specimens from each SUBLOT shall be averaged to constitute one SUBLOT sample. The SUBLOT samples shall then be averaged to obtain a LOT average. In order for the contractor to increase concrete payment quantity back to 100%, the LOT average shall

be at least 6500 psi, and no individual SUBLOT sample shall be less than 6000 psi. Both the LOT average and SUBLOT sample strength requirements must be met in order for the concrete payment quantity to change back to 100%. If both requirements are not met, then the original concrete payment quantity calculated based on the Percent Within Limits (PWL) as outlined in 501-5.3, Price Adjustment, of the Special Provisions shall still apply. The test results of the resampled pavement are final. All costs associated with resampling, including, but not limited to testing, curing, and coring the concrete samples shall be borne by the contractor, regardless as to whether the test results increase or decrease calculated payment quantity of concrete pavement.

Steven J. Long, P.E.
Acting Chief Engineer

Supersedes Policy Memorandum 90-1, dated January 1, 2001

APPENDIX 6
Policy Memorandum 95-1
*Field Test Procedures for Mixer
Performance and Concrete Uniformity Tests*
4 Pages

**Illinois Department of Transportation
Division of Aeronautics
Materials Section**

POLICY MEMORANDUM

January 1, 2004

Springfield

Number 95-1

TO: CONSULTING ENGINEERS

SUBJECT: FIELD TEST PROCEDURES FOR MIXER PERFORMANCE AND CONCRETE
UNIFORMITY TESTS

I. SCOPE

These methods describe the procedures for obtaining and testing representative samples of fresh concrete in the field to determine the consistency and mixer efficiency of stationary mixers at different mixing time periods.

The concrete produced during the mixing time investigation and not used in the test program may be incorporated in the project provided it conforms to the Standard Specifications for Construction of Airports.

A maximum of two mixing times shall be considered by the Department.

The contractor shall provide all of the necessary equipment and personnel to perform the tests and the Department will observe the testing.

II. APPARATUS REQUIRED

- a. Three (3) air meters conforming to the requirements of ASTM C231 or ASTM C173.
- b. Three (3) slump cone kits conforming to ASTM C143.
- c. One (1) No. 4 sieve having a minimum screen area of 2 sq. ft. The sieve shall conform to the requirements of AASHTO M92.
- d. One (1) platform scale graduated in tenths of a pound having a capacity sufficient to perform tests herein after specified.
- e. One (1) hydraulic or mechanical testing machine conforming to the requirements of the specified testing method for the project (ASTM C39 or ASTM C78).

- f. Flexural strength specimen forms as required. The forms shall be nominally 6x6x30 inch. Means shall be provided for securing the base plate firmly to the mold. The inside surfaces of the mold shall be smooth and free from holes, indentations, or ridges. The sides, bottom, and ends shall be at right angles and shall be straight and true so that the specimens will not be warped. Maximum variation from the nominal cross-section shall not exceed 1/8 inch. The assembled mold and base plate shall be lightly coated with mineral oil or other approved form release oil before use. Compressive strength specimens shall be 6x12 inch and prepared in accordance with ASTM C31.
- g. Sufficient water tanks for curing specimens as required by ASTM C31.
- h. Small tools such as shovels, scoops, buckets, etc., and water shall be furnished, as required.

III. MIXER

The mixer for which the mixing time is to be evaluated shall conform to the applicable sections of the Standard Specifications for Construction of Airports.

IV. MIXING TIME REQUIREMENTS

The minimum mixing time to be evaluated shall be specified in the Standard Specifications for Construction of Airports.

V. PROCEDURE

A minimum of ten (10) batches per drum shall be tested and evaluated for each original reduced mixing time request. Check tests shall consist of three (3) batches.

If the request is for a new, twin drum mixer, ten (10) batches shall be tested for the first drum and three (3) for the second drum.

Check tests are required if the mixer is moved, major maintenance performed, or if the source or type of aggregate has changed. A minimum frequency of check tests shall be one (1) per year.

a. Mixing Time

The mixing time and batch size to be evaluated shall be proposed by the contractor. The mixing time shall begin when all solid materials are in the mixing drum. The mixer timer shall register or indicate accurately the mixing time and a tolerance of two (2) seconds will be permitted.

If approved by the Engineer, minor adjustments in admixture dosage and water content will be allowed to account for weather conditions, provided that the maximum w/c ratio is not exceeded.

b. Sampling

At the conclusion of the mixing cycle, the mixer shall be discharged and appropriate samples obtained from the first, middle, and last third portions of the batch. Any appropriate method may be used, provided the samples are representative of the respective portions and not the very ends of the batch.

As an alternative, the mixer may be stopped, and the samples removed by any suitable means at equally spaced points from the front to the back of the drum.

c. Testing.

1. Each third portion of the batch shall be tested simultaneously. The Contractor shall provide sufficient personnel to meet this requirement. The Contractor personnel performing the testing shall be Level I PCC Technicians or Concrete Testers. However, a Level I PCC Technician shall be provided to supervise the Concrete Tester.
2. From each third portion of the batch the mass (weight) of the concrete in one air meter measuring bowl shall be determined.
3. The air content of each third portion of the batch shall be determined according to ASTM C231 or ASTM C173. The air content shall be the arithmetic average of two (2) tests from each third portion of the batch.
4. The slump of each third portion of the batch shall be determined according to ASTM C143. The slump shall be the arithmetic average of two (2) tests from each third portion of the batch.
5. Flexural strength specimen(s) (two (2) breaks required) or two (2) compressive strength specimens shall be prepared from each third portion of the batch according to ASTM C31. Flexural strength specimen(s) (two (2) breaks required) shall be tested according to ASTM C78 at seven (7) days of age. Compressive strength specimens shall be tested according to ASTM C39 at seven (7) days of age.
6. The contents from the weighed air meter measuring bowl shall be washed over a No. 4 sieve. Shake as much water as possible from the material retained on the sieve and then weigh the material. The coarse aggregate content (portion of mass (weight) of sample retained on a No. 4 sieve), expressed as a percent, shall be calculated.

VI. CONCRETE UNIFORMITY REQUIREMENTS

- a. Test results from each third portion of the batch shall be compared to one another according to Table 1. Each batch shall be evaluated individually.
- b. Mixer performance tests consisting of ten (10) batches: If more than seven (7) tests out of the total or more than three (3) in any one criteria are not in compliance with the uniformity requirements (air content, slump, coarse aggregate content, and strength), a reduced mixing time will not be granted.
- c. Mixer performance tests consisting of three (3) batches: If more than three (3) tests out of the total are not in compliance with the uniformity requirements, a full ten (10) batch investigation shall be required.

Table 1. Requirements for Uniformity of Concrete

Test	Requirement (Note 1)
Air Content, percent by volume of concrete	1.0 (Note 2)
Slump, inch	1.0 (Note 3)
Coarse aggregate content, portion by weight of each sample retained on the No. 4 sieve, percent	6.0
Average flexural or compressive strength at 7 days for each sample based on average strength of all comparative test specimens, percent	7.5 (Note 4)

Note 1. Expressed as maximum permissible difference in results of tests of samples taken from three locations in the concrete batch.

Note 2. The average air content sample shall be the arithmetic average of two (2) tests.

Note 3. The average slump sample shall be the arithmetic average of two (2) tests.

Note 4. The average flexural strength of each sample shall be the arithmetic average of two (2) beam breaks. The average compressive strength of each sample shall be the arithmetic average of two (2) cylinder breaks.

Steven J. Long, P.E.
Acting Chief Engineer

Supersedes Policy Memorandum 95-1 dated January 1, 1995

APPENDIX 7
Policy Memorandum 96-3
*Requirements for Quality Assurance on Projects
With Bituminous Concrete Paving*
3 Pages

State of Illinois
Department of Transportation
Division of Aeronautics

POLICY MEMORANDUM

January 1, 2004

Springfield, Illinois

Number 96-3

TO: CONSULTING ENGINEERS

SUBJECT: REQUIREMENTS FOR QUALITY ASSURANCE ON PROJECTS
WITH BITUMINOUS CONCRETE PAVING

I. SCOPE

The purpose of this policy memorandum is to define to the Consulting Engineer the requirements concerning Quality Assurance on bituminous concrete paving projects. Specifically, this memo applies whenever the Contractor is required to comply with the requirements set forth in Policy Memorandum 96-2, *"Requirements for Laboratory, Testing, Quality Control, and Paving of Bituminous Concrete Mixtures"*.

II. LABORATORY APPROVAL

The Resident Engineer shall review and approve the Contractor's plant laboratory to assure that it meets the requirements set forth in the contract specifications and Policy Memorandum 96-2. This review and approval shall be completed prior to utilization of the plant for the production of any mix.

III. QUALITY ASSURANCE DURING PRODUCTION PAVING

- A. At the option of the Engineer, independent assurance tests may be performed on split samples taken by the Contractor for Quality Control testing. In addition, the Resident Engineer shall witness the sampling and splitting of these samples at the start of production and as needed throughout mix production. The Engineer may select any or all split samples for assurance testing. These tests may be performed at any time after sampling. The test results will be made available to the Contractor as soon as they become available.

B. The Resident Engineer may witness the sampling and testing being performed by the Contractor. If the Resident Engineer determines that the sampling and Quality Control tests are not being performed according to the applicable test procedures, the Engineer may stop production until corrective action is taken. The Resident Engineer will promptly notify the Contractor, both verbally and in writing, of observed deficiencies. The Resident Engineer will document all witnessed samples and tests. The Resident Engineer may elect to obtain samples for testing, separate from the Contractor's Quality Control process, to verify specification compliance.

1. Differences between the Contractor's and the Engineer's split sample test results will be considered acceptable if within the following limits:

<u>Test Parameter</u>	<u>Acceptable Limits of Precision</u>
% Passing	
1/2 in.	5.0 %
No. 4	5.0 %
No. 8	3.0 %
No. 30	2.0 %
No. 200	2.2 %
Asphalt Content	0.3 %
Maximum Specific Gravity of Mixture	0.026
Bulk Specific Gravity of Marshall Sample	0.045

2. In the event a comparison of the required plant test results is outside the above acceptable limits of precision, split or independent samples fail the control limits, an extraction indicates non-specification mix, or a continual trend of difference between Contractor and Engineer test results is identified, the Engineer will immediately investigate. The Engineer may suspend production while the investigation is in progress. The investigation may include testing by the Engineer of any remaining split samples or a comparison of split sample test results on the mix currently being produced. The investigation may also include review and observation of the Contractor's technician performance, testing procedure, and equipment. If a problem is identified with the mix, the Contractor shall take immediate corrective action. After corrective action, both the Contractor and the Engineer shall immediately resample and retest.

- C. The Contractor shall be responsible for documenting all observations, records of inspection, adjustments to the mixture, test results, retest results, and corrective actions in a bound hardback field book or bound diary which will become the property of IDA upon completion and acceptance of the project. The Contractor shall be responsible for the maintenance of all permanent records whether obtained by the Contractor, the Contractor's Consultants, or the producer of bituminous mix material. The Contractor shall provide the Engineer full access to all documentation throughout the progress of the work.

Results of adjustments to mixture production and tests shall be recorded in duplicate and sent to the Engineer.

IV. ACCEPTANCE BY ENGINEER

Density acceptance shall be performed according to Policy Memorandum 87-2, or according to the acceptance procedure outlined in the Special Provisions.

Steven J. Long, P.E.
Acting Chief Engineer

Supersedes Policy Memorandum 96-3 dated January 1, 1997

APPENDIX 8
Policy Memorandum 97-2
Pavement Marking Paint Acceptance
2 Pages

State of Illinois
Department of Transportation
Division of Aeronautics

POLICY MEMORANDUM

January 1, 2004

Springfield, Illinois

Number 97-2

TO: CONSULTING ENGINEERS

SUBJECT: PAVEMENT MARKING PAINT ACCEPTANCE

I. SCOPE

The purpose of this policy memorandum is to define the procedure for acceptance of pavement marking paint.

II. RESIDENT ENGINEER'S DUTIES

The Resident Engineer shall follow the acceptance procedure outlined as follows:

- A. Require the painting contractor to furnish the name of the paint manufacturer and the batch number proposed for use prior to beginning work. Notify the I.D.A. Materials Certification Engineer when this information is available.
- B. Require the manufacturer's certification before painting begins. Check the certification for compliance to the contract specifications.
 1. The certification shall be issued from the manufacturer and shall include the specification and the batch number.
 2. The paint containers shall have the manufacturer's name, the specification and the batch number matching the certification.
- C. If no batch number is indicated on the certification or containers, sample the paint according to the procedure for the corresponding paint type.
- D. If the I.D.A. Engineer of Materials indicates that batch number has not been previously sampled and tested, sample the paint according to the procedure for the corresponding paint type. The Division of Aeronautics will provide paint cans upon request by the Resident Engineer. Samples will only be taken in new epoxy lined cans so that the paint will not be contaminated. It is important to seal the sample container immediately with a tight cover to prevent the loss of volatile solvents.

Mark the sample cans with the paint color, manufacturer's name, and batch number. The paint samples and manufacturer's certification shall be placed in the mail within 24 hours after sampling. Address the samples to the Materials Certification Engineer at:

Illinois Department of Transportation
Division of Aeronautics
One Langhorne Bond Drive
Springfield, Illinois 62707

Sampling Procedures for Each Paint Type:

1. Waterborne or Solvent Base Paints
 - a. Take the paint sample from the spray nozzle when the contractor begins marking. A sample consists of two one-pint cans taken per batch number.
 - b. Be sure to indicate to the contractor that acceptance of material is based upon a passing test of the paint material.

2. Epoxy Paint
 - a. Take separate one-pint samples of each paint component prior to marking. Before drawing samples, the contents of each component's container must be thoroughly mixed to make certain that any settled portion is fully dispersed. **Do not combine the two components or sample from the spray nozzle.**
 - b. Be sure to indicate to the contractor that acceptance of material is based upon a passing test of the paint material.

III. TESTING

The paint will be tested for acceptance by the IDOT Bureau of Materials and Physical Research for conformance to the contract specifications.

Steven J. Long, P.E.
Acting Chief Engineer

Supersedes policy memorandum 97-2 dated February 27, 2002

APPENDIX 9
Policy Memorandum 2001-1
Requirements for Cold Weather Concreting
4 Pages

State of Illinois
Department of Transportation
Division of Aeronautics

POLICY MEMORANDUM

January 1, 2004

Springfield, Illinois

Number: 2001-1

TO: CONTRACTORS

SUBJECT: REQUIREMENTS FOR COLD WEATHER CONCRETING

I. PURPOSE

- A. This policy memorandum outlines the minimum requirements for cold weather concreting. Cold weather is defined as whenever the average ambient air temperature during day or night drops below 40°F.

II. COLD WEATHER CONCRETING PLAN

- A. The contractor shall submit a cold weather concreting plan to the Engineer for approval. Cold weather concreting operations are not allowed to proceed until the contractor's cold weather concreting plan has been approved by the Engineer.
- B. The contractor's plan shall be in compliance with this memorandum and shall address, as a minimum, the following:
1. Concrete Mix Manufacturing
 2. Concrete Mix Temperature Monitoring
 3. Base Preparation
 4. Concrete Curing and Protection
 5. In Place Concrete Temperature Monitoring
 6. Strength Test Specimens

III. MINIMUM REQUIREMENTS

A. Concrete Mix Manufacturing

1. The contractor must make the necessary adjustments so that the concrete temperature is maintained from 50°F to 90°F for placement. Acceptable methods include:
 - a) Heating the mixing water Note: If the mixing water is to be heated to a temperature above 100°F, the contractor must include a mixing sequence plan to indicate the order that each component of the mix is to be charged into the mixer.

- b) Heating the aggregates Note: The exact method of heating the aggregates shall be included as part of the cold weather concreting plan. Aggregates must be free of ice and frozen lumps. To avoid the possibility of a quick or flash set of the concrete, when either the water or aggregates are heated to above 100°F, they should be combined in the mixer first before the cement is added.

B. Concrete Mix Temperature

1. The contractor shall monitor the mix temperature at the plant and prior to placement in the forms. Mix that does not meet the temperature requirement of 50°F to 90°F shall be rejected for use on the project.

C. Base Preparation

1. Paving or placing concrete on a frozen base, subbase, or subgrade is prohibited.
2. The base, subbase, or subgrade on which the concrete is to be placed shall be thawed and heated to at least 40°F. The method by which the base subbase or subgrade is to be heated shall be indicated in the contractor's cold weather concreting plan. Insulating blankets or heated enclosures may be required.

D. Concrete Protection and Curing

1. In addition to the curing options available in article 501-3.17 (a) (b), (c), and (d) of the Standard Specifications for Construction of Airports, the contractor shall protect the concrete in such a manner as to maintain a concrete temperature of at least 50°F for 10 days.
2. The method of concrete protection shall be by use of insulating layer or heated enclosure around the concrete. The method of protection shall be indicated in the contractor's cold weather concreting plan. When insulating layers are to be used, the thermal resistance to heat transfer (R Value in °F*hr*ft²/BTU) of the insulation material selected, shall be appropriate for the slab thickness being constructed and shall be indicated in the cold weather concreting plan.
3. Appendix A shows a chart and table taken from the American Concrete Institute specification, ACI 306 R Cold Weather Concreting, which may be used by the contractor in selecting the proper insulation (R Value) and insulating material which may be used.

E. In-Place Concrete Temperature Monitoring

1. Once the concrete is in place, the protection method used, must ensure that the concrete temperature does not fall below 50°F for the time period specified in Section (D. 1.) of this Policy Memorandum (10 days).
2. The concrete temperature on the surface and below the surface must be monitored and recorded by the contractor for the duration of the protection period in Section (D. 1.).
3. After the concrete has hardened, surface temperature can be checked with special surface thermometers or with an ordinary thermometer that is kept covered with insulating blankets. The high and low values for each 24-hour period of protection must be measured and recorded.
4. One acceptable method of checking temperature below the concrete surface is given in the Portland Cement Association (PCA) book entitled "Design and Control of Concrete Mixtures" latest edition. The method is indicated below and it should be noted that the thermometer should be capable of recording high and low values for a given 24-hour period.

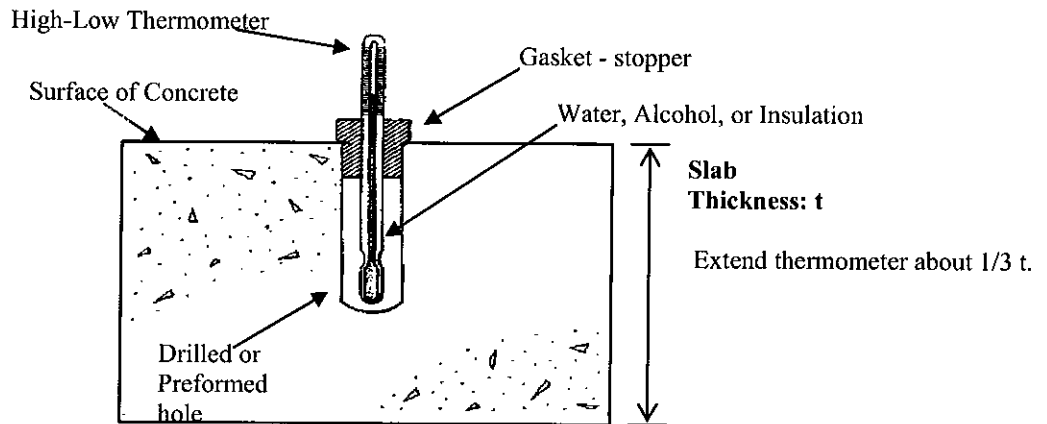

Scheme for measuring concrete temperature below the surface.

5. The exact method for surface and sub-surface concrete temperature monitoring shall be indicated in the contractor's cold weather concreting plan. The maximum permissible difference between the interior and surface temperature is 35 °F. Adjustments in protection method shall be implemented if the maximum permissible difference is exceeded.

F. Strength specimen handling

1. The Contractor is responsible for making, transporting, and curing all samples (beams or cylinders)
2. The Contractor is required to load the testing machine and dispose of the broken pieces.
3. Onsite, indoor curing facilities, meeting the requirements of ASTM C-31, shall be required for cold weather concreting operations.

4. Sampling for strength specimens shall be according to the Contract Special Provisions. Sampled concrete shall be transported to the indoor curing facilities for the casting of strength specimens.
5. The exact location and description of the curing facilities shall be indicated in the contractor's cold weather concreting plan.
6. The method of transporting concrete sampled from the grade to the curing facilities for casting shall be indicated in the contractor's cold weather concreting plan.

Steven J. Long, P.E.
Acting Chief Engineer

Supersedes Policy Memorandum 2001-1 dated January 1, 2001

APPENDIX 10
Policy Memorandum 2003-1
*Requirements for Laboratory, Testing, Quality Control, and
Paving of Superpave Bituminous Concrete Mixtures for Airports*
16 Pages

State of Illinois
Department of Transportation
Division of Aeronautics

POLICY MEMORANDUM

January 1, 2004

Springfield, Illinois

Number 2003-1

TO: CONTRACTORS

SUBJECT: REQUIREMENTS FOR LABORATORY, TESTING, QUALITY CONTROL, AND PAVING OF SUPERPAVE BITUMINOUS CONCRETE MIXTURES FOR AIRPORTS

I. SCOPE

The purpose of this policy memorandum is to define to the Contractor the requirements concerning the laboratory, testing, Quality Control, and paving of bituminous concrete mixtures utilizing Superpave technology. References are made to the most recent issue of the Standard Specifications for Construction of Airports and to American Society for Testing and Materials (ASTM) testing methods. The Quality Assurance and acceptance responsibilities of the Engineer are described in Policy Memorandum 96-3.

II. LABORATORY

The Contractor shall provide a laboratory located at the plant and approved by the Illinois Division of Aeronautics (IDA). The laboratory shall be of sufficient size and be furnished with the necessary equipment and supplies for adequately and safely performing the Contractor's Quality Control testing as well as the Engineer's acceptance testing as described in Policy Memorandum 96-3.

The effective working area of the laboratory shall be a minimum of 600 square feet with a ceiling height of not less than 7.5 feet. Lighting shall be adequate to illuminate all working areas. It shall be equipped with heating and air conditioning units to maintain a temperature of 70° F ±5°F.

The laboratory shall have equipment that is in good working order and that meets the requirements set forth in the following ASTM test standards:

ASTM D 70	Test Method for Specific Gravity and Density of Semi-Solid Materials
ASTM C 117	Test Method for Materials Finer than 75 µm (No. 200) Sieve in Mineral Aggregates by Washing
ASTM C 136	Sieve or Screen Analysis of Fine and Coarse Aggregate
ASTM C 566	Total Moisture Content of Aggregate by Drying
ASTM D 75	Sampling Aggregates
ASTM D 2041	Theoretical Maximum Specific Gravity and Density of Bituminous Paving Mixtures
ASTM D 2172	Quantitative Extraction of Bitumen from Bituminous Paving Mixtures
IDOT	Ignition Method for Determining Asphalt Content
ASTM D 2726	Bulk Specific Gravity of Compacted Bituminous Mixtures using Saturated Surface Dry Specimens

ASTM D 3203	Percent Air Voids in Compacted Dense and Open Bituminous Paving Mixtures
ASTM D 2950	Density of Bituminous Concrete in Place by Nuclear Method
ASTM D 4125	Asphalt Content of Bituminous Mixtures by Nuclear Method
ASTM C 127	Standard Test Method for Specific Gravity and Absorption of Coarse Aggregate
ASTM C 128	Standard Test Method for Specific Gravity and Absorption of Fine Aggregate

The Asphalt Institute's *Superpave Mix Design, Superpave Series No. 2 (SP-2)*

The laboratory and equipment furnished by the Contractor shall be properly calibrated and maintained. The Contractor shall maintain a record of calibration results at the laboratory. The Engineer may inspect measuring and testing devices at any time to confirm both calibration and condition. If the Resident Engineer determines that the equipment is not within the limits of dimensions or calibration described in the appropriate test method, the Engineer may stop production until corrective action is taken. If laboratory equipment becomes inoperable or insufficient to keep up with mix production testing, the Contractor shall cease mix production until adequate and/or sufficient equipment is provided.

III. MIX DESIGN TESTING

The Mix Design letter with accompanying approved Job Mix Formula (JMF) will be issued by the IDA Engineer of Materials. The Contractor will be required to perform the sampling and laboratory testing for the mix design according to the following guidelines: [Note: A testing summary chart can be found in Appendix B.]

- A. Material sources meeting the requirements of the contract shall be submitted in writing at or before the preconstruction conference in the following format:
1. To: Steve Long, Acting Chief Engineer
Attn: Mike Wilhelm, Engineer of Materials
Division of Aeronautics
One Langhorne Bond Drive
Springfield, Illinois 62707
 2. Producer name and location of each aggregate
 3. Producer number for each aggregate (producers are assigned this number by IDOT Central Bureau of Materials)
 4. Material code for each aggregate
 5. Gradation and Quality designation for each aggregate (i.e. 022CA-11, etc.)
 6. Producer, producer number, and specific gravities of asphalt cement
 7. Performance Graded binder (typically PG 64-22) shall be used unless otherwise approved by the IDA Engineer of Materials.
- B. The Contractor shall obtain representative samples of each aggregate. The individual obtaining samples shall have successfully completed the IDOT Aggregate Technician Course under the IDOT Division of Highways, QC/QA program. The sample size shall be approximately 280 lb. for each coarse aggregate, 150 lb. for each fine aggregate, 15 lb. for the mineral filler or collected dust, and 1 gallon of asphalt cement.

- C. The Contractor shall split the aggregate samples down and run gradation tests according to the testing methods referenced in Appendix B of this memorandum. The remaining aggregates shall be set aside for further Mix Design testing. The results of the gradation tests, along with the most recent stockpile gradations, shall be reported by fax to the IDA Engineer of Materials for engineering evaluation. If the gradation results are deemed non-representative or in any way unacceptable, new representative samples may be required at the direction of the IDA Engineer of Materials. Only composite gradations are required under this procedure.
- D. Based on the accepted gradation results, the IDA Engineer of Materials will return blend percentages for each aggregate to be used in determining the Job Mix Formula. In addition, the Engineer of Materials shall specify directions for mix temperature and asphalt content(s), and number of Gyration (N_{des}) for preparation of the Superpave Mix Design.
- E. After receipt of the information from step D., the Contractor shall make specimens and perform the following tests for each asphalt content specified by the Engineer. [Note: Actual test designation is referenced in Appendix B of this memorandum.]

Marshall Tests

Maximum Specific Gravity -- G_{mm}

Bulk Specific Gravity -- G_{mb}

% air voids -- V_a

- F. All technicians who will be performing mix design testing and plant sampling/testing shall have successfully completed the IDOT Division of Highways Bituminous Concrete Level 1 Technician Course "Bituminous Concrete Testing". The Contractor may also provide a Gradation who has successfully completed the Department's "Gradation Technician Course" to run gradation tests only under the supervision of a Bituminous Concrete Level 2 Technician.
- G. The mix design testing results shall be reported to the IDA Engineer of Materials.
- H. The IDA Engineer of Materials shall generate and issue the approved Mix Design with the Job Mix Formula (JMF) for the manufacture of bituminous mixtures using the Contractor's testing results.
- I. The above procedure, III. MIX DESIGN TESTING, shall be repeated for each change in source or gradation of materials, and if the IDA Engineer of Materials has determined it to be necessary to obtain an acceptable mix

IV. MIX PRODUCTION TESTING

The Quality Control of the manufacture and placement of bituminous mixtures is the responsibility of the Contractor. The Contractor shall perform or have performed the inspection and tests required to assure conformance to contract requirements. Quality Control includes the recognition of defects and their immediate correction. This may require increased testing, communication of test results to the plant or the job site, modification of operations, suspension of bituminous mix production, rejection of material, or other actions as appropriate. The Resident Engineer shall be immediately notified of any failing tests and subsequent remedial action. Form AER M-14 shall be reported to the Engineer and Resident Engineer no later than the start of the next work day. In addition, AER M-9 and M-11 shall be given to the Resident Engineer daily (Appendix A). The Contractor shall provide a Quality Control (QC) Manager who will have overall responsibility and authority for Quality Control. This individual shall have successfully completed the IDOT Division of Highways Bituminous Concrete Level II Technician Course "Bituminous Concrete Proportioning and Mixture Evaluation." In addition to the QC Manager, the Contractor shall provide sufficient and qualified personnel to perform the required visual inspections, sampling, testing, and documentation in a timely manner. The following plant tests and documentation shall be required: [Note: A summary chart of testing can be found in Appendix B.]

- A. Minimum of one (1) complete hot bin or combined belt analysis per day of production or every 1,000 tons, whichever is more frequent.
- B. Minimum one (1) stockpile gradation for each aggregate and/or mineral filler per week when a batch plant is utilized. Minimum of one (1) gradation for each aggregate per day of production or every 1,000 tons when a drum plant is used, and one (1) gradation per week for mineral filler when a drum plant is used.
- C. A certification from the quarry for the total quantity of aggregate listing the source, gradation type, and quality designation of aggregate shipped. In lieu of a certification, the contractor may complete and submit an "Aggregate Certification of Compliance" form which may be obtained from IDA.
- D. Original asphalt shipping tickets listing the source and type of asphalt shipped.
- E. One mix sample per 1,000 tons of mix. The sample shall be split in half. One half shall be reserved for testing by the Engineer. The other half shall be split and tested by the Contractor for Extraction, Gradation, Maximum Specific Gravity, and Air Void tests in accordance with the appropriate ASTM standard referenced herein. [See Appendix B.]
 - 1. In place of the extraction test, the Contractor may provide the asphalt content by a calibrated ignition oven test using the IDOT Division of Highways' latest procedure. The correction (calibration) factor for aggregate type shall be clearly indicated in the reported test results.

From these tests, the Contractor shall interpret the test data and make necessary adjustments to the production process in order to comply with the approved JMF.

V. QUALITY CONTROL

A. Control Limits

Target values shall be determined from the approved JMF. The target values shall be plotted on the control charts within the following control limits:

<u>Parameter</u>	<u>Control Limits</u>	
	<u>Individual Test</u>	<u>Moving Avg. of 4</u>
% Passing		
1/2 in.	± 7 %	±4 %
No. 4	±7 %	±4 %
No. 8	±5 %	±3 %
No. 30	±4 %	±2.5 %
No. 200 *	±2.0 % *	±1.0 % *
Asphalt Content	±0.45 %	±0.2 %

* No. 200 material percents shall be based on washed samples. Dry sieve gradations (-200) shall be adjusted based on anticipated degradation in the mixing process.

B. Control Charts

Standardized control charts shall be maintained by the Contractor at the field laboratory. The control charts shall be displayed and be accessible at the field laboratory at all times for review by the Engineer. The individual required test results obtained by the Contractor shall be recorded on the control chart immediately upon completion of a test, but no later than 24 hours after sampling. Only the required plant tests and resamples shall be recorded on the control chart. Any additional testing of check samples may be used for controlling the Contractor's processes, but shall be documented in the plant diary.

The results of assurance tests performed by the Engineer will be posted as soon as available.

The following parameters shall be recorded on control charts:

1. Combined Gradation of Hot-Bin (Batch Plant) or Combined Belt Aggregate Samples (Drier Drum Plant). (% Passing 1/2 in., No. 4., No. 8, No. 30, and No. 200 Sieves)
2. Asphalt Content
3. Bulk Specific Gravity (G_{mb})
4. Maximum Specific Gravity of Mixture (G_{mm})

C. Corrective Action for Required Plant Tests

Control Limits for each required parameter, both individual tests and the average of four tests, shall be exhibited on control charts. Test results shall be posted within the time limits previously outlined.

1. Individual Test Result. When an individual test result exceeds its control limit, the Contractor shall immediately resample and retest. If at the end of the day no material remains from which to resample, the first sample taken the following day shall serve as the resample as well as the first sample of the day. This result shall be recorded as a retest. If the retest passes, the Contractor may continue the required plant test frequency. Additional check samples should be taken to verify mix compliance.
2. Asphalt Content. If the retest for asphalt content exceeds control limits, mix production shall cease and immediate corrective action shall be instituted by the Contractor. After corrective action, mix production shall be restarted, the mix production shall be stabilized, and the Contractor shall immediately resample and retest. Mix production may continue when approved by the Engineer. The corrective action shall be documented.

Inability to control mix production is cause for the Engineer to stop the operation until the Contractor completes the investigation identifying the problems causing failing test results.

3. Combined Aggregate/Hot-Bin. For combined aggregate/hot-bin retest failures, immediate corrective action shall be instituted by the Contractor. After corrective action, the Contractor shall immediately resample and retest. The corrective action shall be documented.
 - a. Moving Average. When the moving average values trend toward the moving average control limits, the Contractor shall take corrective action and increase the sampling and testing frequency. The corrective action shall be documented.

The Contractor shall notify the Engineer whenever the moving average values exceed the moving average control limits. If two consecutive moving average values fall outside the moving average control limits, the Contractor shall cease operations. Corrective action shall be immediately instituted by the Contractor. Operations shall not be reinstated without the approval of the Engineer. Failure to cease operations shall subject all subsequently produced material to be considered unacceptable.

- b. Mix Production Control. If the Contractor is not controlling the production process and is making no effort to take corrective action, the operation shall stop.

VI. TEST SECTION AND DENSITY ACCEPTANCE (Note: Applies only when specified.)

- A. The purpose of the test section is to determine if the mix is acceptable and can be compacted to a consistent passing density.

A quick way to determine the compactibility of the mix is by the use of a nuclear density gauge in the construction of a growth curve. An easy way to construct a growth curve is to use a good vibratory roller. To construct the curve, an area the width of the roller in the middle of the mat is chosen and the roller is allowed to make one compactive pass. With the roller stopped some 30 feet away, a nuclear reading is taken and the outline of the gauge is marked on the pavement. The roller then makes a compaction pass in the opposite direction and another reading is taken. This scenario is continued until at least two (2) passes are made past the maximum density obtained.

The maximum laboratory density potential of a given mix is a direct function of the mix design air voids. Whereas, the actual maximum field density is a function of the type of coarse aggregates, natural or manufactured sands, lift thickness, roller type (static or vibratory), roller and paver speed, base condition, mix variation, etc. All of these items are taken into consideration with the growth curve.

1. High Density in the Growth Curve. If the growth curve indicates a maximum achievable field density of between 95 to 98 percent of the Theoretical Maximum Density (D), you can proceed with the Rolling Pattern. On the other hand, if the maximum achievable density is greater than 98 percent, a quick evaluation (by use of an extractor, hot bin gradations, nuclear asphalt determinator, etc.) must be made of the mix. When adjustments are made in the mix, a new growth curve shall be constructed.
2. Low Density in the Growth Curve. If the growth curve indicates the maximum achievable density is below 94 percent, a thorough evaluation of the mix, rollers, and laydown operations should be made. After a thorough evaluation of all factors (mix, rollers, etc.), asphalt or gradation changes may be in order as directed by the Engineer. Again, any changes in the mix will require a new growth curve. Note that the nuclear density test is a quality control tool and not an acceptance test. All acceptance testing is to be conducted by the use of cores, unless otherwise specified.
3. Acceptance of Test Section. The Contractor may proceed with paving the day after the test section provided the following criteria have been met:
 - a. Four random locations (2 cores per location cut longitudinally and cored by the Contractor) will be selected by the Engineer within the test strip. The cores must show a minimum of 94% density.
 - b. All Superpave and extraction test results from mix produced for the test section must be within the tolerances required by specification.
 - c. The Contractor shall correlate his nuclear gauge to the cores taken in the test section. Additional cores may be taken at the Contractor's expense for this purpose within the test section area, when approved by the Engineer.
4. Density Acceptance under Production Paving. The responsibility for obtaining the specified density lies with the Contractor. Therefore, it is important that the nuclear density gauge operator communicate with the roller operators to maintain the specified density requirements. The Contractor shall provide a Bituminous Concrete Density Tester who has successfully completed the Department's "Bituminous Concrete Nuclear Density Testing Course" to run all required density tests on the job site. Density acceptance testing, unless otherwise specified, is described as follows:

- a. The Contractor shall cut cores at random locations within 500 ton sublots as directed by the Resident Engineer.
- b. The cores should be extracted so as not to damage them, since they are used to calculate the Contractor's pay.
- c. The Engineer will run preliminary G_{mb} tests on the cores to give the Contractor an indication of how compaction is running for the next day's paving.
- e. d. A running average of four (4) Maximum Theoretical Gravities (G_{mm}) will be used for calculating percent compaction. Final core density tests and pay calculations will be performed by the Resident Engineer and delivered to the Contractor.
- f. Should the contractor wish to resample the pavement as a result of pay calculations resulting in less than 100% payment, the request must be made within 48 hours of receipt of the original payment calculations.

Steven J. Long, P.E.
Acting Chief Engineer

Supersedes Policy Memorandum 2003-1 dated January 1, 2003

APPENDIX A

BITUMINOUS WORKSHEET

Airport: _____ Project No.: _____ AIP No.: _____

Mix Design # : _____ Material Code: _____ Producer: _____
Prod. #: _____

AGGREGATE

Mat'l. Code: _____

Producer #: _____

Prod. Name _____

Location: _____

Percent Passing

Sieve Size

1 inch	_____	_____	_____	_____	_____
3/4 inch	_____	_____	_____	_____	_____
1/2 inch	_____	_____	_____	_____	_____
3/8 inch	_____	_____	_____	_____	_____
No. 4	_____	_____	_____	_____	_____
No. 8	_____	_____	_____	_____	_____
No. 16	_____	_____	_____	_____	_____
No. 30	_____	_____	_____	_____	_____
No. 50	_____	_____	_____	_____	_____
No. 100	_____	_____	_____	_____	_____
No. 200	_____	_____	_____	_____	_____
Washed (y/n)	_____	_____	_____	_____	_____
O.D. Gravity	_____	_____	_____	_____	_____
App. Gravity	_____	_____	_____	_____	_____
Absorption	_____	_____	_____	_____	_____
Asphalt Gravity	_____	Asphalt Source	_____	Asphalt Producer No.	_____

MARSHALL DATA

% Asphalt _____

M. Stability _____

Flow _____

D _____

0 _____

% Air Voids _____

Q.C. Manager Name: _____ Phone number: _____

Laboratory Location: _____ Fax Number: _____

Remarks: _____

Bituminous Mixtures Extraction

Airport: _____ Consultant: _____ Date: _____

Illinois Project: _____ Contractor: _____

AIP Project No.: _____ Producer: _____

Mix #: _____ Dry Time: _____ Lot: _____ Sublot: _____

Type: _____ Washed: _____

Sieve	Wt.	Accum. Wt.	% Passing	Mix Formula	Tolerance	Spec Range
1.5						
1						
3/4						
1/2						
3/8						
4						
8						
16						
30						
50						
100						
200						
Tot Agg						
Bit						

Extraction Data		
Pan & New Filter & Sample		g
Pan & New Filter		g
Sample		g
Pan & Used Filter, Aggregate		g
Pan & New Filter		g
Aggregate		g
Pan & Used Filter		g
Pan & New Filter		g
Dustpan Filter		g
Sample		g
Aggregate		g
Bitumen		g

New Bit:	Marshall Stab:	Blows:	Gyro:	Flow:	TSR:
Bulk SPGR:	Max SPGR:	% Voids:	DEN (PCF):		

Remarks: _____

CC: _____ Tested by: _____

APPENDIX B

QUALITY CONTROL TESTING (PLANT)

PARAMETER	FREQUENCY	SAMPLE SIZE	TEST METHOD	REPORT FORM
Aggregate Gradations: Hot bins for batch and continuous plants--- Individual cold-feeds or combined belt-feeds for drier drum plants.	Minimum 1 per day of production and at least 1 per 1000 tons.	CA07/11: 5000 gm CA13: 2000 gm CA16: 1500 gm Fine agg: 500 gm 1 gallon asphalt cement	ASTM C 136	AER M-9
Aggregate gradations: Stockpiles	Minimum 1 per aggregate per week per stockpile.	CA07/11: 5000 gm CA13: 2000 gm CA16: 1500 gm Fine agg: 500 gm *Note: The above test sample sizes are to be obtained from splitting down a larger sample from the stockpiles.	ASTM C 136	AER M-9
Maximum Specific Gravity	Minimum 1 per 1000 tons	1200 gm per test	ASTM D 2041	AER M-11 and AERM-14
Bulk Specific Gravity	Minimum 1 per 1000 tons	1250 gm per briquette	ASTM D 2726	AER M-11 and AERM-14
Marshall Stability and Flow	Minimum 1 per 1000 tons	1250 gm per briquette	ASTM D 1559	AER M-11 and AERM-14
% Air Voids	Minimum 1 per 1000 tons		ASTM D 3203	AER M-11 and AERM-14
Extraction	Minimum 1 per 1000 tons	1000 gm (surface) 1500 gm (base)	ASTM D 2172	AER M-11 and AERM-14
Ignition Oven Test	Minimum 1 per 1000 tons	1500 gm		AER M-14
Nuclear Asphalt Gauge	Minimum 1 per 1000 tons	1000-1100 gm	ASTM D 2145	AER M-14
Gyratory Brix	Minimum 1 per 1000 tons	4700-4800 gm 115 mm +/- 5 mm	AASHTO TP4-99	

MIX DESIGN TESTING

PARAMETER	FREQUENCY	SAMPLE SIZE	TEST METHOD	REPORT FORM
Representative samples of each aggregate and asphalt cement.	1 per aggregate and 1 asphalt cement.	280 lb. (coarse) 150 lb. (fine) 15 lb. (min. filler) 1 gallon asphalt cement	ASTM D 75	N/A
Aggregate Gradation	1 per aggregate	CA07/11: 5000 gm CA13: 2000 gm CA16: 1500 gm Fine agg: 500 gm	ASTM C 136	Bituminous Worksheet (Appendix A)
Maximum Specific Gravity	2 per specified asphalt content	1200 gm per test	ASTM D 2041	Bituminous Worksheet (Appendix A)
Bulk Specific Gravity	3 briquettes per specified asphalt content	1250 gm per briquette	ASTM D 2726	Bituminous Worksheet (Appendix A)
Marshall Stability and Flow	3 briquettes	1250 gm per briquette	ASTM D 1559	Bituminous Worksheet (Appendix A)
% Air Voids	1 per specified asphalt content (Avg. of G_{sb}/G_{mm})		ASTM D 3203	Bituminous Worksheet (Appendix A)
Gyratory Brix	Minimum 1 per 1000 tons	4700-4800 gm 115 mm +/- 5 mm	AASHTO TP4-99	

QUALITY CONTROL TESTING (PAVER)

PARAMETER	FREQUENCY	SAMPLE SIZE	TEST METHOD	REPORT FORM
Nuclear Density Test	As required by the Contractor to maintain consistent passing density	Various locations	ASTM D 2950	

**MINIMUM WAGES FOR FEDERAL AND FEDERALLY
ASSISTED CONSTRUCTION CONTRACTS**

This project is funded, in part, with Federal-aid funds and, as such, is subject to the provisions of the Davis-Bacon Act of March 3, 1931, as amended (46 Sta. 1494, as amended, 40 U.S.C. 276a) and of other Federal statutes referred to in a 29 CFR Part 1, Appendix A, as well as such additional statutes as may from time to time be enacted containing provisions for the payment of wages determined to be prevailing by the Secretary of Labor in accordance with the Davis-Bacon Act and pursuant to the provisions of 29 CFR Part 1. The prevailing rates and fringe benefits shown in the General Wage Determination Decisions issued by the U.S. Department of Labor shall, in accordance with the provisions of the foregoing statutes, constitute the minimum wages payable on Federal and federally assisted construction projects to laborers and mechanics of the specified classes engaged on contract work of the character and in the localities described therein.

General Wage Determination Decisions, modifications and supersedes decisions thereto are to be used in accordance with the provisions of 29 CFR Parts 1 and 5. Accordingly, the applicable decision, together with any modifications issued, must be made a part of every contract for performance of the described work within the geographic area indicated as required by an applicable DBRA Federal prevailing wage law and 29 CFR Part 5. The wage rates and fringe benefits contained in the General Wage Determination Decision shall be the minimum paid by contractors and subcontractors to laborers and mechanics.

NOTICE

The most current **General Wage Determination Decisions** (wage rates) are available on the IDOT web site. They are located on the Letting and Bidding page at <http://www.dot.state.il.us/desenv/delett.html>.

In addition, ten (10) days prior to the letting, the applicable Federal wage rates will be e-mailed to subscribers. It is recommended that all contractors subscribe to the Federal Wage Rates List or the Contractor's Packet through IDOT's subscription service.

PLEASE NOTE: if you have already subscribed to the Contractor's Packet you will automatically receive the Federal Wage Rates.

The instructions for subscribing are at <http://www.dot.state.il.us/desenv/subsc.html>.

If you have any questions concerning the wage rates, please contact IDOT's Chief Contract Official at 217-782-7806.