

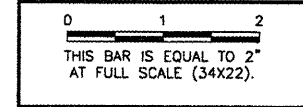

CA006

REVISIONS		
NUMBER	BY	DATE



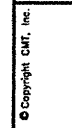

SPRINGFIELD AIRPORT AUTHORITY
ABRAHAM LINCOLN CAPITAL AIRPORT
SPRINGFIELD, IL

TTY G WIDENING-PHASE 1 REALIGN NORTH PERIMETER ROAD
ROADWAY SIGNAGE / MARKING DETAILS

CMT
 CHAWFORD, MURPHY & TILLY, INC.
 CONSULTING ENGINEERS
 License No. 184-000613

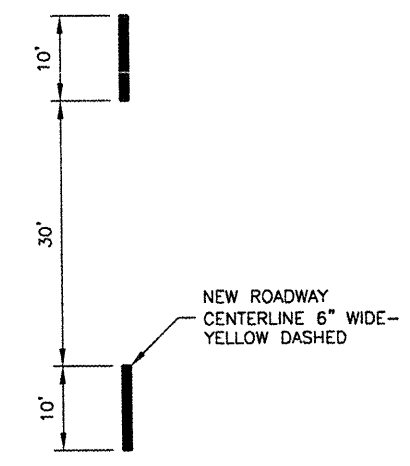
DESIGN BY:	CBG
DRAWN BY:	DPA/JLR
CHECKED BY:	CBG
APPROVED BY:	RW
DATE:	APRIL 25, 2008
JOB No:	07035-09-00
IL PROJ. NO.	SPI-3789
AIP PROJ. NO.	3-17-0096-XX
SHEET	13 OF 22 SHEETS



ROADWAY CENTERLINE - DASHED
N.T.S.

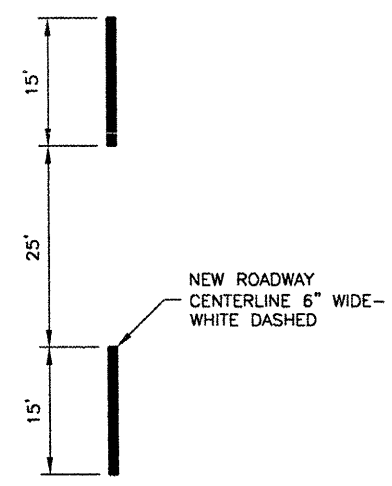

ROADWAY CENTERLINE ADJACENT TO APRON - DASHED
N.T.S.

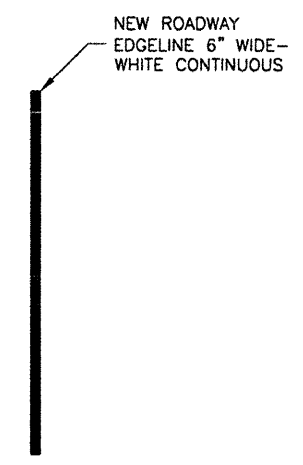

ROADWAY EDGELINES ADJACENT TO APRON - CONTINUOUS
N.T.S.



NEW ROADWAY STOPLINE
N.T.S.

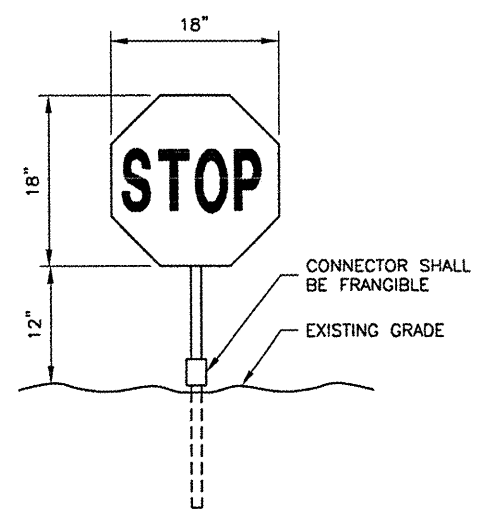

STOP SIGN DETAIL
N.T.S.

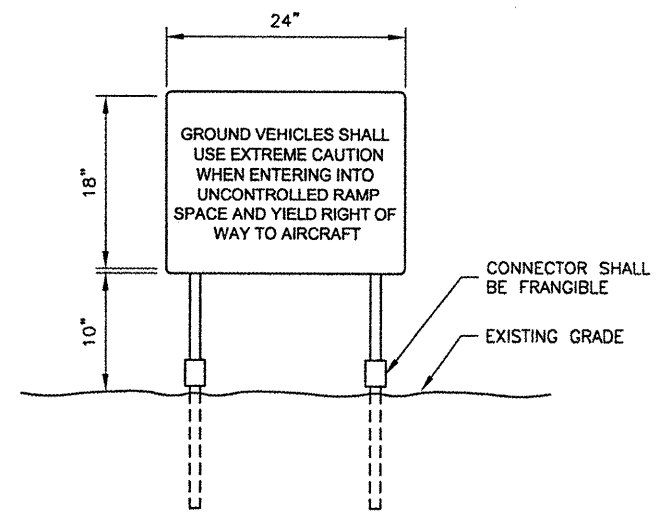

INFORMATION SIGN LEGEND
N.T.S.

- INFORMATION SIGN NOTE**
1. FINAL SIGN FACE LEGEND SHALL BE DETERMINED BY THE AIRPORT.
 2. SIGN LEGEND SHALL BE BLACK LETTERING ON WHITE BACKGROUND.