

If you plan to submit a bid directly to the Department of Transportation

PREQUALIFICATION

Any contractor who desires to become pre-qualified to bid on work advertised by IDOT must submit the properly completed pre-qualification forms to the Bureau of Construction no later than 4:30 p.m. prevailing time twenty-one days prior to the letting of interest. This pre-qualification requirement applies to first time contractors, contractors renewing expired ratings, contractors maintaining continuous pre-qualification or contractors requesting revised ratings. To be eligible to bid, existing pre-qualification ratings must be effective through the date of letting.

REQUESTS FOR AUTHORIZATION TO BID

Contractors wanting to bid on items included in a particular letting must submit the properly completed "Request for Authorization to Bid/or Not For Bid Status" (BDE 124INT) and the ORIGINAL "Affidavit of Availability" (BC 57) to the proper office no later than 4:30 p.m. prevailing time, three (3) days prior to the letting date.

WHO CAN BID ?

Bids will be accepted from only those companies that request and receive written **Authorization to Bid** from IDOT's Central Bureau of Construction.

WHAT CONSTITUTES WRITTEN AUTHORIZATION TO BID?: When a prospective prime bidder submits a "Request for Authorization to Bid/or Not For Bid Status"(BDE 124INT) he/she must indicate at that time which items are being requested For Bidding purposes. Only those items requested For Bidding will be analyzed. After the request has been analyzed, the bidder will be issued an **Authorization to Bid or Not for Bid Report**, approved by the Central Bureau of Construction that indicates which items have been approved For Bidding. If **Authorization to Bid** cannot be approved, the **Authorization to Bid or Not for Bid Report** will indicate the reason for denial.

ABOUT AUTHORIZATION TO BID: Firms that have not received an authorization form within a reasonable time of complete and correct original document submittal should contact the department as to status. This is critical in the week before the letting. These documents must be received three days before the letting date. Firms unsure as to authorization status should call the Prequalification Section of the Bureau of Construction at the number listed at the end of these instructions.

ADDENDA AND REVISIONS: It is the contractor's responsibility to determine which, if any, addenda or revisions pertain to any project they may be bidding. Failure to incorporate all relevant addenda or revisions may cause the bid to be declared unacceptable.

Each addendum will be placed with the contract number. Addenda and revisions will also be placed on the Addendum/Revision Checklist and each subscription service subscriber will be notified by e-mail of each addendum and revision issued.

The Internet is the Department's primary way of doing business. The subscription server e-mails are an added courtesy the Department provides. It is suggested that bidders check IDOT's website at <http://www.dot.il.gov/desenv/delett.html> before submitting final bid information.

IDOT IS NOT RESPONSIBLE FOR ANY E-MAIL FAILURES.

Addenda Questions may be directed to the Contracts Office at (217)782-7806 or D&Econtracts@dot.il.gov

Technical Questions about downloading these files may be directed to Tim Garman (217)524-1642 or Timothy.Garman@illinois.gov.

WHAT MUST BE INCLUDED WHEN BIDS ARE SUBMITTED?: Bidders need not return the entire proposal when bids are submitted. That portion of the proposal that must be returned includes the following:

1. All documents from the Proposal Cover Sheet through the Proposal Bid Bond
2. Other special documentation and/or information that may be required by the contract special provisions

All proposal documents, including Proposal Guaranty Checks or Proposal Bid Bonds, should be stapled together to prevent loss when bids are processed by IDOT personnel.

ABOUT SUBMITTING BIDS: It is recommended that bidders deliver bids in person to insure they arrive at the proper location prior to the time specified for the receipt of bids. Any bid received at the place of letting after the time specified will not be accepted.

WHO SHOULD BE CALLED IF ASSISTANCE IS NEEDED?

Questions Regarding	Call
Prequalification and/or Authorization to Bid	217/782-3413
Preparation and submittal of bids	217/782-7806
Mailing of plans and proposals	217/782-7806

ADDENDUMS AND REVISIONS TO THE PROPOSAL FORMS

Planholders should verify that they have received and incorporated any addendum and/or revision prior to submitting their bid. Failure by the bidder to include an addendum or revision could result in a bid being rejected as irregular.

83

RETURN WITH BID

Proposal Submitted By
Name
Address
City

Letting June 11, 2010

BIDDERS NEED NOT RETURN THE ENTIRE PROPOSAL
(See instructions inside front cover)

NOTICE TO PROSPECTIVE BIDDERS
 This proposal can be used for bidding purposes by only those companies that request and receive written AUTHORIZATION TO BID from IDOT's Central Bureau of Construction.
 (SEE INSTRUCTIONS ON THE INSIDE OF COVER)

Notice to Bidders, Specifications, Proposal, Contract and Contract Bond



**Illinois Department
of Transportation**

Springfield, Illinois 62764

**Contract No. 68948
PEORIA County
Section 45RS-4
District 4 Construction Funds
Route SBI 9A**

PLEASE MARK THE APPROPRIATE BOX BELOW:

A Bid Bond is included.

A Cashier's Check or a Certified Check is included.

Plans Included
Herein

Prepared by	
Checked by	S

(Printed by authority of the State of Illinois)

INSTRUCTIONS

ABOUT IDOT PROPOSALS: All proposals issued by IDOT are potential bidding proposals. Each proposal contains all Certifications and Affidavits, a Proposal Signature Sheet and a Proposal Bid Bond required for Prime Contractors to submit a bid after written **Authorization to Bid** has been issued by IDOT's Central Bureau of Construction. In addition, this proposal contains new statutory requirements applicable to the use of subcontractors and, in particular, includes the State Required Ethical Standards Governing Subcontractors to be signed and incorporated into all subcontracts.

WHO CAN BID?: Bids will be accepted from only those companies that request and receive written **Authorization to Bid** from IDOT's Central Bureau of Construction. To request authorization, a potential bidder must complete and submit Part B of the Request for Authorization to Bid/or Not For Bid Status form (BDE 124 INT) and submit an original Affidavit of Availability (BC 57).

WHAT CONSTITUTES WRITTEN AUTHORIZATION TO BID?: When a prospective prime bidder submits a "**Authorization to Bid or Not for Bid**" form, he/she must indicate at that time which items are being requested For Bidding purposes. Only those items requested For Bidding will be analyzed. After the request has been analyzed, the bidder will be issued a **Authorization to Bid or Not for Bid Report**, approved by the Central Bureau of Construction, that indicates which items have been approved For Bidding. If **Authorization to Bid** cannot be approved, the **Authorization to Bid or Not for Bid Report** will indicate the reason for denial. If a contractor has requested to bid but has not received a **Authorization to Bid or Not for Bid Report**, they should contact the Central Bureau of Construction in advance of the letting date.

WHAT MUST BE INCLUDED WHEN BIDS ARE SUBMITTED?: Bidders need not return the entire proposal when bids are submitted. That portion of the proposal that must be returned includes the following:

1. All documents from the Proposal Cover Sheet through the Proposal Bid Bond
2. Other special documentation and/or information that may be required by the contract special provisions

All proposal documents, including Proposal Guaranty Checks or Proposal Bid Bonds, should be stapled together to prevent loss when bids are processed by IDOT personnel.

ABOUT SUBMITTING BIDS: It is recommended that bidders deliver bids in person to insure they arrive at the proper location prior to the time specified for the receipt of bids. Any bid received at the place of letting after the time specified will not be accepted.

WHO SHOULD BE CALLED IF ASSISTANCE IS NEEDED?

Questions Regarding	Call
Prequalification and/or Authorization to Bid	217/782-3413
Preparation and submittal of bids	217/782-7806

RETURN WITH BID



PROPOSAL

TO THE DEPARTMENT OF TRANSPORTATION

1. Proposal of _____

Taxpayer Identification Number (Mandatory) _____ a

for the improvement identified and advertised for bids in the Invitation for Bids as:

**Contract No. 68948
PEORIA County
Section 45RS-4
Route SBI 9A
District 4 Construction Funds**

3.1 miles of resurfacing on Old U.S. Route 24 (Wheeler Road) from Glasford Road to just south of Reed City Road near Kingston Mines.

2. The undersigned bidder will furnish all labor, material and equipment to complete the above described project in a good and workmanlike manner as provided in the contract documents provided by the Department of Transportation. This proposal will become part of the contract and the terms and conditions contained in the contract documents shall govern performance and payments.

RETURN WITH BID

3. **ASSURANCE OF EXAMINATION AND INSPECTION/WAIVER.** The undersigned further declares that he/she has carefully examined the proposal, plans, specifications, addenda, form of contract and contract bond, and special provisions, and that he/she has inspected in detail the site of the proposed work, and that he/she has familiarized themselves with all of the local conditions affecting the contract and the detailed requirements of construction, and understands that in making this proposal he/she waives all right to plead any misunderstanding regarding the same.
4. **EXECUTION OF CONTRACT AND CONTRACT BOND.** The undersigned further agrees to execute a contract for this work and present the same to the department within fifteen (15) days after the contract has been mailed to him/her. The undersigned further agrees that he/she and his/her surety will execute and present within fifteen (15) days after the contract has been mailed to him/her contract bond satisfactory to and in the form prescribed by the Department of Transportation, in the penal sum of the full amount of the contract, guaranteeing the faithful performance of the work in accordance with the terms of the contract.
5. **PROPOSAL GUARANTY.** Accompanying this proposal is either a bid bond on the department form, executed by a corporate surety company satisfactory to the department, or a proposal guaranty check consisting of a bank cashier's check or a properly certified check for not less than 5 per cent of the amount bid or for the amount specified in the following schedule:

<u>Amount of Bid</u>		<u>Proposal Guaranty</u>	<u>Amount of Bid</u>		<u>Proposal Guaranty</u>	
Up to	\$5,000	\$150	\$2,000,000	to	\$3,000,000	\$100,000
\$5,000	to \$10,000	\$300	\$3,000,000	to	\$5,000,000	\$150,000
\$10,000	to \$50,000	\$1,000	\$5,000,000	to	\$7,500,000	\$250,000
\$50,000	to \$100,000	\$3,000	\$7,500,000	to	\$10,000,000	\$400,000
\$100,000	to \$150,000	\$5,000	\$10,000,000	to	\$15,000,000	\$500,000
\$150,000	to \$250,000	\$7,500	\$15,000,000	to	\$20,000,000	\$600,000
\$250,000	to \$500,000	\$12,500	\$20,000,000	to	\$25,000,000	\$700,000
\$500,000	to \$1,000,000	\$25,000	\$25,000,000	to	\$30,000,000	\$800,000
\$1,000,000	to \$1,500,000	\$50,000	\$30,000,000	to	\$35,000,000	\$900,000
\$1,500,000	to \$2,000,000	\$75,000	over		\$35,000,000	\$1,000,000

Bank cashier's checks or properly certified checks accompanying proposals shall be made payable to the Treasurer, State of Illinois, when the state is awarding authority; the county treasurer, when a county is the awarding authority; or the city, village, or town treasurer, when a city, village, or town is the awarding authority.

If a combination bid is submitted, the proposal guaranties which accompany the individual proposals making up the combination will be considered as also covering the combination bid.

The amount of the proposal guaranty check is _____ \$(_____). If this proposal is accepted and the undersigned shall fail to execute a contract bond as required herein, it is hereby agreed that the amount of the proposal guaranty shall become the property of the State of Illinois, and shall be considered as payment of damages due to delay and other causes suffered by the State because of the failure to execute said contract and contract bond; otherwise, the bid bond shall become void or the proposal guaranty check shall be returned to the undersigned.

Attach Cashier's Check or Certified Check Here

In the event that one proposal guaranty check is intended to cover two or more proposals, the amount must be equal to the sum of the proposal guaranties which would be required for each individual proposal. If the guaranty check is placed in another proposal, state below where it may be found.

The proposal guaranty check will be found in the proposal for:

Item _____

Section No. _____

County _____

Mark the proposal cover sheet as to the type of proposal guaranty submitted.

RETURN WITH BID

6. **COMBINATION BIDS.** The undersigned further agrees that if awarded the contract for the sections contained in the following combination, he/she will perform the work in accordance with the requirements of each individual proposal comprising the combination bid specified in the schedule below, and that the combination bid shall be prorated against each section in proportion to the bid submitted for the same. If an error is found to exist in the gross sum bid for one or more of the individual sections included in a combination, the combination bid shall be corrected as provided in the specifications.

When a combination bid is submitted, the schedule below must be completed in each proposal comprising the combination.

If alternate bids are submitted for one or more of the sections comprising the combination, a combination bid must be submitted for each alternate.

Schedule of Combination Bids

Combination No.	Sections Included in Combination	Combination Bid	
		Dollars	Cents

7. **SCHEDULE OF PRICES.** The undersigned bidder submits herewith, in accordance with the rules and instructions, a schedule of prices for the items of work for which bids are sought. The unit prices bid are in U.S. dollars and cents, and all extensions and summations have been made. The bidder understands that the quantities appearing in the bid schedule are approximate and are provided for the purpose of obtaining a gross sum for the comparison of bids. If there is an error in the extension of the unit prices, the unit prices shall govern. Payment to the contractor awarded the contract will be made only for actual quantities of work performed and accepted or materials furnished according to the contract. The scheduled quantities of work to be done and materials to be furnished may be increased, decreased or omitted as provided elsewhere in the contract.
8. **AUTHORITY TO DO BUSINESS IN ILLINOIS.** Section 20-43 of the Illinois Procurement Code (30 ILCS 500/20-43) provides that a person (other than an individual acting as a sole proprietor) must be a legal entity authorized to do business in the State of Illinois prior to submitting the bid.

ILLINOIS DEPARTMENT OF TRANSPORTATION
 SCHEDULE OF PRICES
 CONTRACT
 NUMBER - 68948

State Job # - C-94-040-10
 PPS NBR - 4-01970-0000
 County Name - PEORIA- -
 Code - 143 - -
 District - 4 - -
 Section Number - 45 RS-4

Project Number

Route
 SBI 9A

Item Number	Pay Item Description	Unit of Measure	Quantity	x	Unit Price	=	Total Price
X0322729	MATL TRANSFER DEVICE	TON	2,850.000				
X0323660	DROP BOX NO.1	EACH	1.000				
X2503100	MOWING	UNIT	339.000				
20201006	GRADING & SHAP SHLDS	UNIT	339.000				
20201200	REM & DISP UNS MATL	CU YD	67.000				
20800150	TRENCH BACKFILL	CU YD	9.000				
21001000	GEOTECH FAB F/GR STAB	SQ YD	204.000				
21400100	GRADING & SHAP DITCH	FOOT	1,540.000				
28000305	TEMP DITCH CHECKS	FOOT	60.000				
28000500	INLET & PIPE PROTECT	EACH	4.000				
31101100	SUB GRAN MAT B	CU YD	33.300				
31102000	SUB GRAN MAT C	CU YD	40.000				
35501320	HMA BASE CSE 9	SQ YD	100.000				
40200800	AGG SURF CSE B	TON	86.000				
40600215	P BIT MATLS PR CT	TON	11.000				

ILLINOIS DEPARTMENT OF TRANSPORTATION
 SCHEDULE OF PRICES
 CONTRACT
 NUMBER - 68948

State Job # - C-94-040-10
 PPS NBR - 4-01970-0000
 County Name - PEORIA- -
 Code - 143 - -
 District - 4 - -
 Section Number - 45 RS-4

Project Number

Route
 SBI 9A

Item Number	Pay Item Description	Unit of Measure	Quantity	x	Unit Price	=	Total Price
40600895	CONSTRUC TEST STRIP	EACH	1.000				
40600982	HMA SURF REM BUTT JT	SQ YD	381.000				
40600990	TEMPORARY RAMP	SQ YD	280.000				
40603000	HMA BC IL-12.5 N50	TON	5,772.000				
40603335	HMA SC "D" N50	TON	2,850.000				
40800050	INCIDENTAL HMA SURF	TON	219.000				
44000100	PAVEMENT REM	SQ YD	100.000				
44000400	GUTTER REM	FOOT	100.000				
44201821	CL D PATCH T4 14	SQ YD	50.000				
48101200	AGGREGATE SHLDS B	TON	1,184.000				
542A1069	P CUL CL A 2 24	FOOT	54.000				
54213669	PRC FLAR END SEC 24	EACH	1.000				
60100060	CONC HDWL FOR P DRAIN	EACH	1.000				
60107600	PIPE UNDERDRAINS 4	FOOT	18.000				
60108100	PIPE UNDERDRAIN 4 SP	FOOT	20.000				

ILLINOIS DEPARTMENT OF TRANSPORTATION
 SCHEDULE OF PRICES
 CONTRACT
 NUMBER - 68948

State Job # - C-94-040-10
 PPS NBR - 4-01970-0000
 County Name - PEORIA- -
 Code - 143 - -
 District - 4 - -
 Section Number - 45 RS-4

Project Number

Route
 SBI 9A

Item Number	Pay Item Description	Unit of Measure	Quantity	x	Unit Price	=	Total Price
60406500	FR & LIDS SPEC	EACH	1.000				
60602600	CONC GUTTER TA MOD	FOOT	100.000				
67000400	ENGR FIELD OFFICE A	CAL MO	2.000				
67100100	MOBILIZATION	L SUM	1.000				
70100460	TRAF CONT-PROT 701306	L SUM	1.000				
70101835	TRAF CONT-PROT BLR 22	L SUM	1.000				
70300100	SHORT-TERM PAVT MKING	FOOT	6,531.000				
70300220	TEMP PVT MK LINE 4	FOOT	44,751.000				
70300280	TEMP PVT MK LINE 24	FOOT	66.000				
70301000	WORK ZONE PAVT MK REM	SQ FT	702.000				
78001110	PAINT PVT MK LINE 4	FOOT	44,751.000				
78001180	PAINT PVT MK LINE 24	FOOT	66.000				

CONTRACT NUMBER 68948

THIS IS THE TOTAL BID \$ _____

NOTES:

- 1. Each PAY ITEM should have a UNIT PRICE and a TOTAL PRICE.**
- 2. The UNIT PRICE shall govern if no TOTAL PRICE is shown or if there is a discrepancy between the product of the UNIT PRICE multiplied by the QUANTITY.**
- 3. If a UNIT PRICE is omitted, the TOTAL PRICE will be divided by the QUANTITY in order to establish a UNIT PRICE.**
- 4. A bid may be declared UNACCEPTABLE if neither a unit price nor a total price is shown.**

RETURN WITH BID

STATE REQUIRED ETHICAL STANDARDS GOVERNING CONTRACT PROCUREMENT: ASSURANCES, CERTIFICATIONS AND DISCLOSURES

I. GENERAL

A. Article 50 of the Illinois Procurement Code establishes the duty of all State chief procurement officers, State purchasing officers, and their designees to maximize the value of the expenditure of public moneys in procuring goods, services, and contracts for the State of Illinois and to act in a manner that maintains the integrity and public trust of State government. In discharging this duty, they are charged by law to use all available information, reasonable efforts, and reasonable actions to protect, safeguard, and maintain the procurement process of the State of Illinois.

B. In order to comply with the provisions of Article 50 and to carry out the duty established therein, all bidders are to adhere to ethical standards established for the procurement process, and to make such assurances, disclosures and certifications required by law. Except as otherwise required in subsection III, paragraphs J-N, by execution of the Proposal Signature Sheet, the bidder indicates that each of the mandated assurances have been read and understood, that each certification is made and understood, and that each disclosure requirement has been understood and completed.

C. In addition to all other remedies provided by law, failure to comply with any assurance, failure to make any disclosure or the making of a false certification shall be grounds for the chief procurement officer to void the contract, or subcontract, and may result in the suspension or debarment of the bidder or subcontractor.

II. ASSURANCES

The assurances hereinafter made by the bidder are each a material representation of fact upon which reliance is placed should the Department enter into the contract with the bidder.

A. Conflicts of Interest

1. The Illinois Procurement Code provides in pertinent part:

Section 50-13. Conflicts of Interest.

(a) Prohibition. It is unlawful for any person holding an elective office in this State, holding a seat in the General Assembly, or appointed to or employed in any of the offices or agencies of state government and who receives compensation for such employment in excess of 60% of the salary of the Governor of the State of Illinois, or who is an officer or employee of the Capital Development Board or the Illinois Toll Highway Authority, or who is the spouse or minor child of any such person to have or acquire any contract, or any direct pecuniary interest in any contract therein, whether for stationery, printing, paper, or any services, materials, or supplies, that will be wholly or partially satisfied by the payment of funds appropriated by the General Assembly of the State of Illinois or in any contract of the Capital Development Board or the Illinois Toll Highway authority.

(b) Interests. It is unlawful for any firm, partnership, association or corporation, in which any person listed in subsection (a) is entitled to receive (i) more than 7 1/2% of the total distributable income or (ii) an amount in excess of the salary of the Governor, to have or acquire any such contract or direct pecuniary interest therein.

(c) Combined interests. It is unlawful for any firm, partnership, association, or corporation, in which any person listed in subsection (a) together with his or her spouse or minor children is entitled to receive (i) more than 15%, in the aggregate, of the total distributable income or (ii) an amount in excess of 2 times the salary of the Governor, to have or acquire any such contract or direct pecuniary interest therein.

(d) Securities. Nothing in this Section invalidates the provisions of any bond or other security previously offered or to be offered for sale or sold by or for the State of Illinois.

(e) Prior interests. This Section does not affect the validity of any contract made between the State and an officer or employee of the State or member of the General Assembly, his or her spouse, minor child or any combination of those persons if that contract was in existence before his or her election or employment as an officer, member, or employee. The contract is voidable, however, if it cannot be completed within 365 days after the officer, member, or employee takes office or is employed.

The current salary of the Governor is \$177,412.00. Sixty percent of the salary is \$106,447.20.

RETURN WITH BID

2. The bidder assures the Department that the award and execution of the contract would not cause a violation of Section 50-13, or that an effective exemption has been issued by the Board of Ethics to any individual subject to the Section 50-13 prohibitions pursuant to the provisions of Section 50-20 of the Code and Executive Order Number 3 (1998). Information concerning the exemption process is available from the Department upon request.

B. Negotiations

1. The Illinois Procurement Code provides in pertinent part:

Section 50-15. Negotiations.

(a) It is unlawful for any person employed in or on a continual contractual relationship with any of the offices or agencies of State government to participate in contract negotiations on behalf of that office or agency with any firm, partnership, association, or corporation with whom that person has a contract for future employment or is negotiating concerning possible future employment.

2. The bidder assures the Department that the award and execution of the contract would not cause a violation of Section 50-15, and that the bidder has no knowledge of any facts relevant to the kinds of acts prohibited therein.

C. Inducements

1. The Illinois Procurement Code provides:

Section 50-25. Inducement. Any person who offers or pays any money or other valuable thing to any person to induce him or her not to bid for a State contract or as recompense for not having bid on a State contract is guilty of a Class 4 felony. Any person who accepts any money or other valuable thing for not bidding for a State contract or who withholds a bid in consideration of the promise for the payment of money or other valuable thing is guilty of a Class 4 felony.

2. The bidder assures the Department that the award and execution of the contract would not cause a violation of Section 50-25, and that the bidder has no knowledge of any facts relevant to the kinds of acts prohibited therein.

D. Revolving Door Prohibition

1. The Illinois Procurement Code provides:

Section 50-30. Revolving door prohibition. Chief procurement officers, State purchasing officers, procurement compliance monitors, their designees whose principal duties are directly related to State procurement, and executive officers confirmed by the Senate are expressly prohibited for a period of 2 years after terminating an affected position from engaging in any procurement activity relating to the State agency most recently employing them in an affected position for a period of at least 6 months. The prohibition includes, but is not limited to: lobbying the procurement process; specifying; bidding; proposing bid, proposal, or contract documents; on their own behalf or on behalf of any firm, partnership, association, or corporation. This Section applies only to persons who terminate an affected position on or after January 15, 1999.

2. The bidder assures the Department that the award and execution of the contract would not cause a violation of Section 50-30, and that the bidder has no knowledge of any facts relevant to the kinds of acts prohibited therein.

E. Reporting Anticompetitive Practices

1. The Illinois Procurement Code provides:

Section 50-40. Reporting anticompetitive practices. When, for any reason, any vendor, bidder, contractor, chief procurement officer, State purchasing officer, designee, elected official, or State employee suspects collusion or other anticompetitive practice among any bidders, offerors, contractors, proposers, or employees of the State, a notice of the relevant facts shall be transmitted to the Attorney General and the chief procurement officer.

2. The bidder assures the Department that it has not failed to report any relevant facts concerning the practices addressed in Section 50-40 which may involve the contract for which the bid is submitted.

F. Confidentiality

1. The Illinois Procurement Code provides:

Section 50-45. Confidentiality. Any chief procurement officer, State purchasing officer, designee, or executive officer who willfully uses or allows the use of specifications, competitive bid documents, proprietary competitive information, proposals, contracts, or selection information to compromise the fairness or integrity of the procurement, bidding, or contract process shall be subject to immediate dismissal, regardless of the Personnel code, any contract, or any collective bargaining agreement, and may in addition be subject to criminal prosecution.

2. The bidder assures the Department that it has no knowledge of any fact relevant to the practices addressed in Section 50-45 which may involve the contract for which the bid is submitted.

RETURN WITH BID

G. Insider Information

1. The Illinois Procurement Act provides:

Section 50-50. Insider information. It is unlawful for any current or former elected or appointed State official or State employee to knowingly use confidential information available only by virtue of that office or employment for actual or anticipated gain for themselves or another person.

2. The bidder assures the Department that it has no knowledge of any facts relevant to the practices addressed in Section 50-50 which may involve the contract for which the bid is submitted.

III. CERTIFICATIONS

The certifications hereinafter made by the bidder are each a material representation of fact upon which reliance is placed should the Department enter into the contract with the bidder. Section 50-2 of the Illinois Procurement Code provides that every person that has entered into a multi-year contract and every subcontractor with a multi-year subcontract shall certify, by July 1 of each fiscal year covered by the contract after the initial fiscal year, to the responsible chief procurement officer whether it continues to satisfy the requirements of Article 50 pertaining to the eligibility for a contract award. If a contractor or subcontractor is not able to truthfully certify that it continues to meet all requirements, it shall provide with its certification a detailed explanation of the circumstances leading to the change in certification status. A contractor or subcontractor that makes a false statement material to any given certification required under Article 50 is, in addition to any other penalties or consequences prescribed by law, subject to liability under the Whistleblower Reward and Protection Act for submission of a false claim.

A. Bribery

1. The Illinois Procurement Code provides:

Section 50-5. Bribery.

(a) Prohibition. No person or business shall be awarded a contract or subcontract under this Code who:

(1) has been convicted under the laws of Illinois or any other state of bribery or attempting to bribe an officer or employee of the State of Illinois or any other state in that officer's or employee's official capacity; or

(2) has made an admission of guilt of that conduct that is a matter of record but has not been prosecuted for that conduct.

(b) Businesses. No business shall be barred from contracting with any unit of State or local government, or subcontracting under such a contract, as a result of a conviction under this Section of any employee or agent of the business if the employee or agent is no longer employed by the business and:

(1) the business has been finally adjudicated not guilty; or

(2) the business demonstrates to the governmental entity with which it seeks to contract, or which is signatory to the contract which the subcontract relates, and that entity finds that the commission of the offense was not authorized, requested, commanded, or performed by a director, officer, or high managerial agent on behalf of the business as provided in paragraph (2) of subsection (a) of Section 5-4 of the Criminal Code of 1961.

(c) Conduct on behalf of business. For purposes of this Section, when an official, agent, or employee of a business committed the bribery or attempted bribery on behalf of the business and in accordance with the direction or authorization of a responsible official of the business, the business shall be chargeable with the conduct.

(d) Certification. Every bid submitted to and contract executed by the State, and every subcontract subject to Section 20-120 of the Procurement Code shall contain a certification by the contractor or the subcontractor, respectively, that the contractor or subcontractor is not barred from being awarded a contract or subcontract under this Section and acknowledges that the chief procurement officer may declare the related contract void if any certifications required by this Section are false. A contractor who makes a false statement, material to the certification, commits a Class 3 felony.

2. The contractor or subcontractor certifies that it is not barred from being awarded a contract under Section 50.5.

B. Felons

1. The Illinois Procurement Code provides:

Section 50-10. Felons. Unless otherwise provided, no person or business convicted of a felony shall do business with the State of Illinois or any State agency, or enter into a subcontract, from the date of conviction until 5 years after the date of completion of the sentence for that felony, unless no person held responsible by a prosecutorial office for the facts upon which the conviction was based continues to have any involvement with the business.

2. Certification. Every bid submitted to and contract executed by the State and every subcontract subject to Section 20-120 of the Procurement Code shall contain a certification by the bidder or contractor or subcontractor, respectively, that the bidder, contractor, or subcontractor is not barred from being awarded a contract or subcontract under this Section and acknowledges that the chief procurement officer may declare the related contract void if any of the certifications required by this Section are false.

RETURN WITH BID

C. Debt Delinquency

1. The Illinois Procurement Code provides:

Section 50-11 and 50-12. Debt Delinquency.

The contractor or bidder or subcontractor, respectively, certifies that it, or any affiliate, is not barred from being awarded a contract or subcontract under the Procurement Code. Section 50-11 prohibits a person from entering into a contract with a State agency, or entering into a subcontract, if it knows or should know that it, or any affiliate, is delinquent in the payment of any debt to the State as defined by the Debt Collection Board. Section 50-12 prohibits a person from entering into a contract with a State agency, or entering into a subcontract, if it, or any affiliate, has failed to collect and remit Illinois Use Tax on all sales of tangible personal property into the State of Illinois in accordance with the provisions of the Illinois Use Tax Act. The bidder or contractor or subcontractor, respectively, further acknowledges that the chief procurement officer may declare the related contract void if this certification is false or if the bidder, contractor, or subcontractor, or any affiliate, is determined to be delinquent in the payment of any debt to the State during the term of the contract.

D. Prohibited Bidders, Contractors and Subcontractors

1. The Illinois Procurement Code provides:

Section 50-10.5 and 50-60(c). Prohibited bidders, contractors and subcontractors.

The bidder or contractor or subcontractor, respectively, certifies in accordance with 30 ILCS 500/50-10.5 that no officer, director, partner or other managerial agent of the contracting business has been convicted of a felony under the Sarbanes-Oxley Act of 2002 or a Class 3 or Class 2 felony under the Illinois Securities Law of 1953 or if in violation of Subsection (c) for a period of five years from the date of conviction. Every bid submitted to and contract executed by the State and every subcontract subject to Section 20-120 of the Procurement Code shall contain a certification by the bidder, contractor, or subcontractor, respectively, that the bidder, contractor, or subcontractor is not barred from being awarded a contract or subcontract under this Section and acknowledges that the chief procurement officer shall declare the related contract void if any of the certifications completed pursuant to this Section are false.

E. Section 42 of the Environmental Protection Act

The bidder or contractor or subcontractor, respectively, certifies in accordance with 30 ILCS 500/50-12 that the bidder, contractor, or subcontractor, is not barred from being awarded a contract or entering into a subcontract under this Section which prohibits the bidding on or entering into contracts with the State of Illinois or a State agency, or entering into any subcontract, that is subject to the Procurement Code by a person or business found by a court or the Pollution Control Board to have committed a willful or knowing violation of Section 42 of the Environmental Protection Act for a period of five years from the date of the order. The bidder or contractor or subcontractor, respectively, acknowledges that the chief procurement officer may declare the contract void if this certification is false.

F. Educational Loan

1. Section 3 of the Educational Loan Default Act provides:

§ 3. No State agency shall contract with an individual for goods or services if that individual is in default, as defined in Section 2 of this Act, on an educational loan. Any contract used by any State agency shall include a statement certifying that the individual is not in default on an educational loan as provided in this Section.

2. The bidder, if an individual as opposed to a corporation, partnership or other form of business organization, certifies that the bidder is not in default on an educational loan as provided in Section 3 of the Act.

G. Bid-Rigging/Bid Rotating

1. Section 33E-11 of the Criminal Code of 1961 provides:

§ 33E-11. (a) Every bid submitted to and public contract executed pursuant to such bid by the State or a unit of local government shall contain a certification by the prime contractor that the prime contractor is not barred from contracting with any unit of State or local government as a result of a violation of either Section 33E-3 or 33E-4 of this Article. The State and units of local government shall provide the appropriate forms for such certification.

- (b) A contractor who makes a false statement, material to the certification, commits a Class 3 felony.

A violation of Section 33E-3 would be represented by a conviction of the crime of bid-rigging which, in addition to Class 3 felony sentencing, provides that any person convicted of this offense or any similar offense of any state or the United States which contains the same elements as this offense shall be barred for 5 years from the date of conviction from contracting with any unit of State or local government. No corporation shall be barred from contracting with any unit of State or local government as a result of a conviction under this Section of any employee or agent of such corporation if the employee so convicted is no longer employed by the corporation and: (1) it has been finally adjudicated not guilty or (2) if it demonstrates to the governmental entity with which it seeks to contract and that entity finds that the commission of the offense was neither authorized, requested, commanded, nor performed by a director, officer or a high managerial agent in behalf of the corporation.

RETURN WITH BID

A violation of Section 33E-4 would be represented by a conviction of the crime of bid-rotating which, in addition to Class 2 felony sentencing, provides that any person convicted of this offense or any similar offense of any state or the United States which contains the same elements as this offense shall be permanently barred from contracting with any unit of State or local government. No corporation shall be barred from contracting with any unit of State or local government as a result of a conviction under this Section of any employee or agent of such corporation if the employee so convicted is no longer employed by the corporation and: (1) it has been finally adjudicated not guilty or (2) if it demonstrates to the governmental entity with which it seeks to contract and that entity finds that the commission of the offense was neither authorized, requested, commanded, nor performed by a director, officer or a high managerial agent in behalf of the corporation.

2. The bidder certifies that it is not barred from contracting with the Department by reason of a violation of either Section 33E-3 or Section 33E-4.

H. International Anti-Boycott

1. Section 5 of the International Anti-Boycott Certification Act provides:

§ 5. State contracts. Every contract entered into by the State of Illinois for the manufacture, furnishing, or purchasing of supplies, material, or equipment or for the furnishing of work, labor, or services, in an amount exceeding the threshold for small purchases according to the purchasing laws of this State or \$10,000.00, whichever is less, shall contain certification, as a material condition of the contract, by which the contractor agrees that neither the contractor nor any substantially-owned affiliated company is participating or shall participate in an international boycott in violation of the provisions of the U.S. Export Administration Act of 1979 or the regulations of the U.S. Department of Commerce promulgated under that Act.

2. The bidder makes the certification set forth in Section 5 of the Act.

I. Drug Free Workplace

1. The Illinois "Drug Free Workplace Act" applies to this contract and it is necessary to comply with the provisions of the "Act" if the contractor is a corporation, partnership, or other entity (including a sole proprietorship) which has 25 or more employees.

2. The bidder certifies that if awarded a contract in excess of \$5,000 it will provide a drug free workplace by:

(a) Publishing a statement notifying employees that the unlawful manufacture, distribution, dispensation, possession or use of a controlled substance, including cannabis, is prohibited in the contractor's workplace; specifying the actions that will be taken against employees for violations of such prohibition; and notifying the employee that, as a condition of employment on such contract, the employee shall abide by the terms of the statement, and notify the employer of any criminal drug statute conviction for a violation occurring in the workplace no later than five (5) days after such conviction.

(b) Establishing a drug free awareness program to inform employees about the dangers of drug abuse in the workplace; the contractor's policy of maintaining a drug free workplace; any available drug counseling, rehabilitation, and employee assistance programs; and the penalties that may be imposed upon employees for drug violations.

(c) Providing a copy of the statement required by subparagraph (1) to each employee engaged in the performance of the contract and to post the statement in a prominent place in the workplace.

(d) Notifying the Department within ten (10) days after receiving notice from an employee or otherwise receiving actual notice of the conviction of an employee for a violation of any criminal drug statute occurring in the workplace.

(e) Imposing or requiring, within 30 days after receiving notice from an employee of a conviction or actual notice of such a conviction, an appropriate personnel action, up to and including termination, or the satisfactory participation in a drug abuse assistance or rehabilitation program approved by a federal, state or local health, law enforcement or other appropriate agency.

(f) Assisting employees in selecting a course of action in the event drug counseling, treatment, and rehabilitation is required and indicating that a trained referral team is in place.

(g) Making a good faith effort to continue to maintain a drug free workplace through implementation of the actions and efforts stated in this certification.

RETURN WITH BID

J. Disclosure of Business Operations in Iran

Section 50-36 of the Illinois Procurement Code, 30ILCS 500/50-36 provides that each bid, offer, or proposal submitted for a State contract shall include a disclosure of whether or not the Company acting as the bidder, offeror, or proposing entity, or any of its corporate parents or subsidiaries, within the 24 months before submission of the bid, offer, or proposal had business operations that involved contracts with or provision of supplies or services to the Government of Iran, companies in which the Government of Iran has any direct or indirect equity share, consortiums or projects commissioned by the Government of Iran, or companies involved in consortiums or projects commissioned by the Government of Iran and either of the following conditions apply:

- (1) More than 10% of the Company's revenues produced in or assets located in Iran involve oil-related activities or mineral-extraction activities; less than 75% of the Company's revenues produced in or assets located in Iran involve contracts with or provision of oil-related or mineral-extraction products or services to the Government of Iran or a project or consortium created exclusively by that government; and the Company has failed to take substantial action.
- (2) The Company has, on or after August 5, 1996, made an investment of \$20 million or more, or any combination of investments of at least \$10 million each that in the aggregate equals or exceeds \$20 million in any 12-month period, which directly or significantly contributes to the enhancement of Iran's ability to develop petroleum resources of Iran.

The terms "Business operations", "Company", "Mineral-extraction activities", "Oil-related activities", "Petroleum resources", and "Substantial action" are all defined in the Code.

Failure to make the disclosure required by the Code shall cause the bid, offer or proposal to be considered not responsive. The disclosure will be considered when evaluating the bid, offer, or proposal or awarding the contract. The name of each Company disclosed as doing business or having done business in Iran will be provided to the State Comptroller.

Check the appropriate statement:

Company has no business operations in Iran to disclose.

Company has business operations in Iran as disclosed the attached document.

K. Apprenticeship and Training Certification (Does not apply to federal aid projects)

In accordance with the provisions of Section 30-22 (6) of the Illinois Procurement Code, the bidder certifies that it is a participant, either as an individual or as part of a group program, in the approved apprenticeship and training programs applicable to each type of work or craft that the bidder will perform with its own forces. The bidder further certifies for work that will be performed by subcontract that each of its subcontractors submitted for approval either (a) is, at the time of such bid, participating in an approved, applicable apprenticeship and training program; or (b) will, prior to commencement of performance of work pursuant to this contract, begin participation in an approved apprenticeship and training program applicable to the work of the subcontract. The Department, at any time before or after award, may require the production of a copy of each applicable Certificate of Registration issued by the United States Department of Labor evidencing such participation by the contractor and any or all of its subcontractors. Applicable apprenticeship and training programs are those that have been approved and registered with the United States Department of Labor. The bidder shall list in the space below, the official name of the program sponsor holding the Certificate of Registration for all of the types of work or crafts in which the bidder is a participant and that will be performed with the bidder's forces. Types of work or craft work that will be subcontracted shall be included and listed as subcontract work. The list shall also indicate any type of work or craft job category that does not have an applicable apprenticeship or training program. **The bidder is responsible for making a complete report and shall make certain that each type of work or craft job category that will be utilized on the project as reported on the Construction Employee Workforce Projection (Form BC-1256) and returned with the bid is accounted for and listed.**

The requirements of this certification and disclosure are a material part of the contract, and the contractor shall require this certification provision to be included in all approved subcontracts. In order to fulfill this requirement, it shall not be necessary that an applicable program sponsor be currently taking or that it will take applications for apprenticeship, training or employment during the performance of the work of this contract.

TO BE RETURNED WITH BID

L. Political Contributions and Registration with the State Board of Elections

Sections 20-160 and 50-37 of the Illinois Procurement Code regulate political contributions from business entities and any affiliated entities or affiliated persons bidding on or contracting with the state. Generally under Section 50-37, any business entity, and any affiliated entity or affiliated person of the business entity, whose current year contracts with all state agencies exceed an awarded value of \$50,000, are prohibited from making any contributions to any political committees established to promote the candidacy of the officeholder responsible for the awarding of the contracts or any other declared candidate for that office for the duration of the term of office of the incumbent officeholder or a period 2 years after the termination of the contract, whichever is longer. Any business entity and affiliated entities or affiliated persons whose state contracts in the current year do not exceed an awarded value of \$50,000, but whose aggregate pending bids and proposals on state contracts exceed \$50,000, either alone or in combination with contracts not exceeding \$50,000, are prohibited from making any political contributions to any political committee established to promote the candidacy of the officeholder responsible for awarding the pending contract during the period beginning on the date the invitation for bids or request for proposals is issued and ending on the day after the date of award or selection if the entity was not awarded or selected. Section 20-160 requires certification of registration of affected business entities in accordance with procedures found in Section 9-35 of The Election Code.

By submission of a bid, the contractor business entity acknowledges and agrees that it has read and understands Sections 20-160 and 50-37 of the Illinois Procurement Code, and that it makes the following certification:

The undersigned business entity certifies that it has registered as a business with the State Board of Elections and acknowledges a continuing duty to update the registration in accordance with the above referenced statutes. A copy of the certificate of registration shall be submitted with the bid. The bidder is cautioned that the Department will not award a contract without submission of the certificate of registration.

These requirements and compliance with the above referenced statutory sections are a material part of the contract, and any breach thereof shall be cause to void the contract under Section 50-60 of the Illinois Procurement Code. This provision does not apply to Federal-aid contracts.

M. Lobbyist Disclosure

Section 50-38 of the Illinois Procurement Code requires that any bidder or offeror on a State contract that hires a person required to register under the Lobbyist Registration Act to assist in obtaining a contract shall:

- (i) Disclose all costs, fees, compensation, reimbursements, and other remunerations paid or to be paid to the lobbyist related to the contract,
- (ii) Not bill or otherwise cause the State of Illinois to pay for any of the lobbyist's costs, fees, compensation, reimbursements, or other remuneration, and
- (iii) Sign a verification certifying that none of the lobbyist's costs, fees, compensation, reimbursements, or other remuneration were billed to the State.

This information, along with all supporting documents, shall be filed with the agency awarding the contract and with the Secretary of State. The chief procurement officer shall post this information, together with the contract award notice, in the online Procurement Bulletin.

Pursuant to Subsection (c) of this Section, no person or entity shall retain a person or entity to attempt to influence the outcome of a procurement decision made under the Procurement Code for compensation contingent in whole or in part upon the decision or procurement. Any person who violates this subsection is guilty of a business offense and shall be fined not more than \$10,000.

Bidder acknowledges that it is required to disclose the hiring of any person required to register pursuant to the Illinois Lobbyist Registration Act (25 ILCS 170) in connection with this contract.

Bidder has not hired any person required to register pursuant to the Illinois Lobbyist Registration Act in connection with this contract.

Or

Bidder has hired the following persons required to register pursuant to the Illinois Lobbyist Registration Act in connection with the contract:

Name and address of person: _____
All costs, fees, compensation, reimbursements and other remuneration paid to said person: _____

RETURN WITH BID

IV. DISCLOSURES

- A. The disclosures hereinafter made by the bidder are each a material representation of fact upon which reliance is placed should the Department enter into the contract with the bidder. The bidder further certifies that the Department has received the disclosure forms for each bid.

The chief procurement officer may void the bid, contract, or subcontract, respectively, if it is later determined that the bidder or subcontractor rendered a false or erroneous disclosure. A contractor or subcontractor may be suspended or debarred for violations of the Procurement Code. Furthermore, the chief procurement officer may void the contract and the surety providing the performance bond shall be responsible for completion of the contract.

B. Financial Interests and Conflicts of Interest

1. Section 50-35 of the Illinois Procurement Code provides that all bids of more than \$10,000 shall be accompanied by disclosure of the financial interests of the bidder. This disclosed information for the successful bidder, will be maintained as public information subject to release by request pursuant to the Freedom of Information Act, filed with the Procurement Policy Board, and shall be incorporated as a material term of the contract. Furthermore, pursuant to Section 5-5, the Procurement Policy Board may review a proposal, bid, or contract and issue a recommendation to void a contract or reject a proposal or bid based on any violation of the Procurement Code or the existence of a conflict of interest as provided in subsections (b) and (d) of Section 50-35.

The financial interests to be disclosed shall include ownership or distributive income share that is in excess of 5%, or an amount greater than 60% of the annual salary of the Governor, of the bidding entity or its parent entity, whichever is less, unless the contractor or bidder is a publicly traded entity subject to Federal 10K reporting, in which case it may submit its 10K disclosure in place of the prescribed disclosure. If a bidder is a privately held entity that is exempt from Federal 10K reporting, but has more than 400 shareholders, it may submit the information that Federal 10K companies are required to report, and list the names of any person or entity holding any ownership share that is in excess of 5%. The disclosure shall include the names, addresses, and dollar or proportionate share of ownership of each person making the disclosure, their instrument of ownership or beneficial relationship, and notice of any potential conflict of interest resulting from the current ownership or beneficial interest of each person making the disclosure having any of the relationships identified in Section 50-35 and on the disclosure form.

In addition, all disclosures shall indicate any other current or pending contracts, proposals, leases, or other ongoing procurement relationships the bidding entity has with any other unit of state government and shall clearly identify the unit and the contract, proposal, lease, or other relationship.

2. Disclosure Forms. Disclosure Form A is attached for use concerning the individuals meeting the above ownership or distributive share requirements. Subject individuals should be covered each by one form. In addition, a second form (Disclosure Form B) provides for the disclosure of current or pending procurement relationships with other (non-IDOT) state agencies. **The forms must be included with each bid or incorporated by reference.**

C. Disclosure Form Instructions

Form A Instructions for Financial Information & Potential Conflicts of Interest

If the bidder is a publicly traded entity subject to Federal 10K reporting, the 10K Report may be submitted to meet the requirements of Form A. If a bidder is a privately held entity that is exempt from Federal 10K reporting, but has more than 400 shareholders, it may submit the information that Federal 10K companies are required to report, and list the names of any person or entity holding any ownership share that is in excess of 5%. If a bidder is not subject to Federal 10K reporting, the bidder must determine if any individuals are required by law to complete a financial disclosure form. To do this, the bidder should answer each of the following questions. A "YES" answer indicates Form A must be completed. If the answer to each of the following questions is "NO", then the NOT APPLICABLE STATEMENT on Form A must be signed and dated by a person that is authorized to execute contracts for the bidding company. Note: These questions are for assistance only and are not required to be completed.

1. Does anyone in your organization have a direct or beneficial ownership share of greater than 5% of the bidding entity or parent entity? YES ___ NO ___
2. Does anyone in your organization have a direct or beneficial ownership share of less than 5%, but which has a value greater than \$106,447.20? YES ___ NO ___
3. Does anyone in your organization receive more than \$106,447.20 of the bidding entity's or parent entity's distributive income? (Note: Distributive income is, for these purposes, any type of distribution of profits. An annual salary is not distributive income.) YES ___ NO ___
4. Does anyone in your organization receive greater than 5% of the bidding entity's or parent entity's total distributive income, but which is less than \$106,447.20? YES ___ NO ___

(Note: Only one set of forms needs to be completed per person per bid even if a specific individual would require a yes answer to more than one question.)

A "YES" answer to any of these questions requires the completion of Form A. The bidder must determine each individual in the bidding entity or the bidding entity's parent company that would cause the questions to be answered "Yes". Each form must be signed and dated by a person that is authorized to execute contracts for your organization. **Photocopied or stamped signatures are not acceptable.** The person signing can be, but does not have to be, the person for which the form is being completed. The bidder is responsible for the accuracy of any information provided.

If the answer to each of the above questions is "NO", then the NOT APPLICABLE STATEMENT of Form A must be signed and dated by a person that is authorized to execute contracts for your company.

RETURN WITH BID

Form B: Instructions for Identifying Other Contracts & Procurement Related Information

Disclosure Form B must be completed for each bid submitted by the bidding entity. *Note: Checking the NOT APPLICABLE STATEMENT on Form A does not allow the bidder to ignore Form B. Form B must be completed, checked, and dated or the bidder may be considered nonresponsive and the bid will not be accepted.*

The Bidder shall identify, by checking Yes or No on Form B, whether it has any pending contracts (including leases), bids, proposals, or other ongoing procurement relationship with any other (non-IDOT) State of Illinois agency. If "No" is checked, the bidder only needs to complete the check box on the bottom of Form B. If "Yes" is checked, the bidder must do one of the following:

Option I: If the bidder did not submit an Affidavit of Availability to obtain authorization to bid, the bidder must list all non-IDOT State of Illinois agency pending contracts, leases, bids, proposals, and other ongoing procurement relationships. These items may be listed on Form B or on an attached sheet(s). Do not include IDOT contracts. Contracts with cities, counties, villages, etc. are not considered State of Illinois agency contracts and are not to be included. Contracts with other State of Illinois agencies such as the Department of Natural Resources or the Capital Development Board must be included. Bidders who submit Affidavits of Availability are suggested to use Option II.

Option II: If the bidder is required and has submitted an Affidavit of Availability in order to obtain authorization to bid, the bidder may write or type "See Affidavit of Availability" which indicates that the Affidavit of Availability is incorporated by reference and includes all non-IDOT State of Illinois agency pending contracts, leases, bids, proposals, and other ongoing procurement relationships. For any contracts that are not covered by the Affidavit of Availability, the bidder must identify them on Form B or on an attached sheet(s). These might be such things as leases.

**ILLINOIS DEPARTMENT
OF TRANSPORTATION**

**Form A
Financial Information &
Potential Conflicts of Interest
Disclosure**

Contractor Name		
Legal Address		
City, State, Zip		
Telephone Number	Email Address	Fax Number (if available)

Disclosure of the information contained in this Form is required by the Section 50-35 of the Illinois Procurement Code (30 ILCS 500). Vendors desiring to enter into a contract with the State of Illinois must disclose the financial information and potential conflict of interest information as specified in this Disclosure Form. This information shall become part of the publicly available contract file. This Form A must be completed for bids in excess of \$10,000, and for all open-ended contracts. **A publicly traded company may submit a 10K disclosure (or equivalent if applicable) in satisfaction of the requirements set forth in Form A. See Disclosure Form Instructions.**

DISCLOSURE OF FINANCIAL INFORMATION

1. Disclosure of Financial Information. The individual named below has an interest in the BIDDER (or its parent) in terms of ownership or distributive income share in excess of 5%, or an interest which has a value of more than \$106,447.20 (60% of the Governor's salary as of 7/1/07). **(Make copies of this form as necessary and attach a separate Disclosure Form A for each individual meeting these requirements)**

FOR INDIVIDUAL (type or print information)	
NAME:	_____
ADDRESS	_____
Type of ownership/distributable income share:	
stock _____ sole proprietorship _____ Partnership _____ other: (explain on separate sheet):	
% or \$ value of ownership/distributable income share:	_____

2. Disclosure of Potential Conflicts of Interest. Check "Yes" or "No" to indicate which, if any, of the following potential conflict of interest relationships apply. If the answer to any question is "Yes", please attach additional pages and describe.

(a) State employment, currently or in the previous 3 years, including contractual employment of services. Yes ___ No ___

If your answer is yes, please answer each of the following questions.

1. Are you currently an officer or employee of either the Capitol Development Board or the Illinois Toll Highway Authority? Yes ___ No ___

2. Are you currently appointed to or employed by any agency of the State of Illinois? If you are currently appointed to or employed by any agency of the State of Illinois, and your annual salary exceeds \$106,447.20, (60% of the Governor's salary as of 7/1/07) provide the name the State agency for which you are employed and your annual salary. _____

RETURN WITH BID/OFFER

- 3. If you are currently appointed to or employed by any agency of the State of Illinois, and your annual salary exceeds \$106,447.20, (60% of the Governor's salary as of 7/1/07) are you entitled to receive (i) more than 7 1/2% of the total distributable income of your firm, partnership, association or corporation, or (ii) an amount in excess of the salary of the Governor? Yes ___ No ___

- 4. If you are currently appointed to or employed by any agency of the State of Illinois, and your annual salary exceeds \$106,447.20, (60% of the Governor's salary as of 7/1/07) are you and your spouse or minor children entitled to receive (i) more than 15 % in the aggregate of the total distributable income of your firm, partnership, association or corporation, or (ii) an amount in excess of 2 times the salary of the Governor? Yes ___ No ___

(b) State employment of spouse, father, mother, son, or daughter, including contractual employment services in the previous 2 years.

Yes ___ No ___

If your answer is yes, please answer each of the following questions.

- 1. Is your spouse or any minor children currently an officer or employee of the Capitol Development Board or the Illinois Toll Highway Authority? Yes ___ No ___

- 2. Is your spouse or any minor children currently appointed to or employed by any agency of the State of Illinois? If your spouse or minor children is/are currently appointed to or employed by any agency of the State of Illinois, and his/her annual salary exceeds \$106,447.20, (60 % of the Governor's salary as of 7/1/07) provide the name of your spouse and/or minor children, the name of the State agency for which he/she is employed and his/her annual salary. _____

- 3. If your spouse or any minor children is/are currently appointed to or employed by any agency of the State of Illinois, and his/her annual salary exceeds \$106,447.20, (60% of the salary of the Governor as of 7/1/07) are you entitled to receive (i) more then 71/2% of the total distributable income of your firm, partnership, association or corporation, or (ii) an amount in excess of the salary of the Governor? Yes ___ No ___

- 4. If your spouse or any minor children are currently appointed to or employed by any agency of the State of Illinois, and his/her annual salary exceeds \$106,447.20, (60% of the Governor's salary as of 7/1/07) are you and your spouse or minor children entitled to receive (i) more than 15 % in the aggregate of the total distributable income of your firm, partnership, association or corporation, or (ii) an amount in excess of 2 times the salary of the Governor? Yes ___ No ___

(c) Elective status; the holding of elective office of the State of Illinois, the government of the United States, any unit of local government authorized by the Constitution of the State of Illinois or the statutes of the State of Illinois currently or in the previous 3 years. Yes ___ No ___

(d) Relationship to anyone holding elective office currently or in the previous 2 years; spouse, father, mother, son, or daughter. Yes ___ No ___

(e) Appointive office; the holding of any appointive government office of the State of Illinois, the United States of America, or any unit of local government authorized by the Constitution of the State of Illinois or the statutes of the State of Illinois, which office entitles the holder to compensation in excess of the expenses incurred in the discharge of that office currently or in the previous 3 years. Yes ___ No ___

(f) Relationship to anyone holding appointive office currently or in the previous 2 years; spouse, father, mother, son, or daughter. Yes ___ No ___

(g) Employment, currently or in the previous 3 years, as or by any registered lobbyist of the State government. Yes ___ No ___

RETURN WITH BID/OFFER

(h) Relationship to anyone who is or was a registered lobbyist in the previous 2 years; spouse, father, mother, son, or daughter. Yes ___ No ___

(i) Compensated employment, currently or in the previous 3 years, by any registered election or reelection committee registered with the Secretary of State or any county clerk of the State of Illinois, or any political action committee registered with either the Secretary of State or the Federal Board of Elections. Yes ___ No ___

(j) Relationship to anyone; spouse, father, mother, son, or daughter; who was a compensated employee in the last 2 years by any registered election or re-election committee registered with the Secretary of State or any county clerk of the State of Illinois, or any political action committee registered with either the Secretary of State or the Federal Board of Elections. Yes ___ No ___

2. Communication Disclosure.

Disclose the name and address of each lobbyist and other agent of the bidder or offeror who is not identified in Section 2 of this form, who is has communicated, is communicating, or may communicate with any State officer or employee concerning the bid or offer. This disclosure is a continuing obligation and must be promptly supplemented for accuracy throughout the process and throughout the term of the contract. If no person is identified, enter "None" on the line below:

Name and address of person(s): _____

4. Debarment Disclosure. For each of the persons identified under Sections 2 and 3 of this form, disclose whether any of the following has occurred within the previous 10 years: debarment from contracting with any governmental entity; professional licensure discipline; bankruptcies; adverse civil judgments and administrative findings; and criminal felony convictions. This disclosure is a continuing obligation and must be promptly supplemented for accuracy throughout the procurement process and term of the contract. If no person is identified, enter "None" on the line below:

Name of person(s): _____

Nature of disclosure: _____

APPLICABLE STATEMENT

This Disclosure Form A is submitted on behalf of the INDIVIDUAL named on previous page. Under penalty of perjury, I certify the contents of this disclosure to be true and accurate to the best of my knowledge.

Completed by: _____ Date _____
Signature of Individual or Authorized Representative

NOT APPLICABLE STATEMENT

Under penalty of perjury, I have determined that no individuals associated with this organization meet the criteria that would require the completion of this Form A.

This Disclosure Form A is submitted on behalf of the CONTRACTOR listed on the previous page.

_____ Date _____
Signature of Authorized Representative

The bidder has a continuing obligation to supplement these disclosures under Sec. 50-35 of the Procurement Code.

RETURN WITH BID

ILLINOIS DEPARTMENT OF TRANSPORTATION

Form B Other Contracts & Procurement Related Information Disclosure

Contractor Name, Legal Address, City, State, Zip, Telephone Number, Email Address, Fax Number (if available)

Disclosure of the information contained in this Form is required by the Section 50-35 of the Illinois Procurement Act (30 ILCS 500). This information shall become part of the publicly available contract file. This Form B must be completed for bids in excess of \$10,000, and for all open-ended contracts.

DISCLOSURE OF OTHER CONTRACTS AND PROCUREMENT RELATED INFORMATION

1. Identifying Other Contracts & Procurement Related Information. The BIDDER shall identify whether it has any pending contracts (including leases), bids, proposals, or other ongoing procurement relationship with any other State of Illinois agency: Yes ___ No ___

If "No" is checked, the bidder only needs to complete the signature box on the bottom of this page.

2. If "Yes" is checked. Identify each such relationship by showing State of Illinois agency name and other descriptive information such as bid or project number (attach additional pages as necessary). SEE DISCLOSURE FORM INSTRUCTIONS:

THE FOLLOWING STATEMENT MUST BE CHECKED

Signature of Authorized Representative, Date

RETURN WITH BID

SPECIAL NOTICE TO CONTRACTORS

The following requirements of the Illinois Department of Human Rights' Rules and Regulations are applicable to bidders on all construction contracts advertised by the Illinois Department of Transportation:

CONSTRUCTION EMPLOYEE UTILIZATION PROJECTION

- (a) All bidders on construction contracts shall complete and submit, along with and as part of their bids, a Bidder's Employee Utilization Form (Form BC-1256) setting forth a projection and breakdown of the total workforce intended to be hired and/or allocated to such contract work by the bidder including a projection of minority and female employee utilization in all job classifications on the contract project.
- (b) The Department of Transportation shall review the Employee Utilization Form, and workforce projections contained therein, of the contract awardee to determine if such projections reflect an underutilization of minority persons and/or women in any job classification in accordance with the Equal Employment Opportunity Clause and Section 7.2 of the Illinois Department of Human Rights' Rules and Regulations for Public Contracts adopted as amended on September 17, 1980. If it is determined that the contract awardee's projections reflect an underutilization of minority persons and/or women in any job classification, it shall be advised in writing of the manner in which it is underutilizing and such awardee shall be considered to be in breach of the contract unless, prior to commencement of work on the contract project, it submits revised satisfactory projections or an acceptable written affirmative action plan to correct such underutilization including a specific timetable geared to the completion stages of the contract.
- (c) The Department of Transportation shall provide to the Department of Human Rights a copy of the contract awardee's Employee Utilization Form, a copy of any required written affirmative action plan, and any written correspondence related thereto. The Department of Human Rights may review and revise any action taken by the Department of Transportation with respect to these requirements.

RETURN WITH BID

**Contract No. 68948
PEORIA County
Section 45RS-4
Route SBI 9A
District 4 Construction Funds**

PART II. WORKFORCE PROJECTION - continued

- B. Included in "Total Employees" under Table A is the total number of **new hires** that would be employed in the event the undersigned bidder is awarded this contract.

The undersigned bidder projects that: (number) _____ new hires would be recruited from the area in which the contract project is located; and/or (number) _____ new hires would be recruited from the area in which the bidder's principal office or base of operation is located.

- C. Included in "Total Employees" under Table A is a projection of numbers of persons to be employed directly by the undersigned bidder as well as a projection of numbers of persons to be employed by subcontractors.

The undersigned bidder estimates that (number) _____ persons will be directly employed by the prime contractor and that (number) _____ persons will be employed by subcontractors.

PART III. AFFIRMATIVE ACTION PLAN

- A. The undersigned bidder understands and agrees that in the event the foregoing minority and female employee utilization projection included under **PART II** is determined to be an underutilization of minority persons or women in any job category, and in the event that the undersigned bidder is awarded this contract, he/she will, prior to commencement of work, develop and submit a written Affirmative Action Plan including a specific timetable (geared to the completion stages of the contract) whereby deficiencies in minority and/or female employee utilization are corrected. Such Affirmative Action Plan will be subject to approval by the contracting agency and the **Department of Human Rights**.
- B. The undersigned bidder understands and agrees that the minority and female employee utilization projection submitted herein, and the goals and timetable included under an Affirmative Action Plan if required, are deemed to be part of the contract specifications.

Company _____ Telephone Number _____

Address _____

NOTICE REGARDING SIGNATURE

The Bidder's signature on the Proposal Signature Sheet will constitute the signing of this form. The following signature block needs to be completed if revisions are required.

Signature: _____ Title: _____ Date: _____

- Instructions: All tables must include subcontractor personnel in addition to prime contractor personnel.
- Table A - Include both the number of employees that would be hired to perform the contract work and the total number currently employed (Table B) that will be allocated to contract work, and include all apprentices and on-the-job trainees. The "Total Employees" column should include all employees including all minorities, apprentices and on-the-job trainees to be employed on the contract work.
 - Table B - Include all employees currently employed that will be allocated to the contract work including any apprentices and on-the-job trainees currently employed.
 - Table C - Indicate the racial breakdown of the total apprentices and on-the-job trainees shown in Table A.

RETURN WITH BID

Contract No. 68948

PEORIA County

Section 45RS-4

Route SBI 9A

District 4 Construction Funds

PROPOSAL SIGNATURE SHEET

The undersigned bidder hereby makes and submits this bid on the subject Proposal, thereby assuring the Department that all requirements of the Invitation for Bids and rules of the Department have been met, that there is no misunderstanding of the requirements of paragraph 3 of this Proposal, and that the contract will be executed in accordance with the rules of the Department if an award is made on this bid.

(IF AN INDIVIDUAL) Firm Name _____
Signature of Owner _____
Business Address _____

(IF A CO-PARTNERSHIP) Firm Name _____
By _____
Business Address _____
Name and Address of All Members of the Firm:

(IF A CORPORATION)
(IF A JOINT VENTURE, USE THIS SECTION FOR THE MANAGING PARTY AND THE SECOND PARTY SHOULD SIGN BELOW) Corporate Name _____
By _____ Signature of Authorized Representative
Typed or printed name and title of Authorized Representative _____
Attest _____ Signature
Business Address _____

(IF A JOINT VENTURE) Corporate Name _____
By _____ Signature of Authorized Representative
Typed or printed name and title of Authorized Representative _____
Attest _____ Signature
Business Address _____

If more than two parties are in the joint venture, please attach an additional signature sheet.



Return with Bid

Division of Highways
Proposal Bid Bond
(Effective November 1, 1992)

Item No. _____

Letting Date _____

KNOW ALL MEN BY THESE PRESENTS, That We _____

as PRINCIPAL, and _____

_____ as SURETY, are held jointly, severally and firmly bound unto the STATE OF ILLINOIS in the penal sum of 5 percent of the total bid price, or for the amount specified in Article 102.09 of the "Standard Specifications for Road and Bridge Construction" in effect on the date of invitation for bids, whichever is the lesser sum, well and truly to be paid unto said STATE OF ILLINOIS, for the payment of which we bind ourselves, our heirs, executors, administrators, successors and assigns.

THE CONDITION OF THE FOREGOING OBLIGATION IS SUCH, that whereas, the PRINCIPAL has submitted a bid proposal to the STATE OF ILLINOIS, acting through the Department of Transportation, for the improvement designated by the Transportation Bulletin Item Number and Letting Date indicated above.

NOW, THEREFORE, if the Department shall accept the bid proposal of the PRINCIPAL; and if the PRINCIPAL shall, within the time and as specified in the bidding and contract documents, submit a DBE Utilization Plan that is accepted and approved by the Department; and if, after award by the Department, the PRINCIPAL shall enter into a contract in accordance with the terms of the bidding and contract documents including evidence of the required insurance coverages and providing such bond as specified with good and sufficient surety for the faithful performance of such contract and for the prompt payment of labor and material furnished in the prosecution thereof; or if, in the event of the failure of the PRINCIPAL to make the required DBE submission or to enter into such contract and to give the specified bond, the PRINCIPAL pays to the Department the difference not to exceed the penalty hereof between the amount specified in the bid proposal and such larger amount for which the Department may contract with another party to perform the work covered by said bid proposal, then this obligation shall be null and void, otherwise, it shall remain in full force and effect.

IN THE EVENT the Department determines the PRINCIPAL has failed to comply with any requirement as set forth in the preceding paragraph, then Surety shall pay the penal sum to the Department within fifteen (15) days of written demand therefor. If Surety does not make full payment within such period of time, the Department may bring an action to collect the amount owed. Surety is liable to the Department for all its expenses, including attorney's fees, incurred in any litigation in which it prevails either in whole or in part.

In TESTIMONY WHEREOF, the said PRINCIPAL and the said SURETY have caused this instrument to be signed by

their respective officers this _____ day of _____ A.D., _____ .

PRINCIPAL

SURETY

(Company Name)

(Company Name)

By _____
(Signature & Title)

By: _____
(Signature of Attorney-in-Fact)

Notary Certification for Principal and Surety

STATE OF ILLINOIS,
County of _____

I, _____, a Notary Public in and for said County, do hereby certify that

_____ and _____
(Insert names of individuals signing on behalf of PRINCIPAL & SURETY)

who are each personally known to me to be the same persons whose names are subscribed to the foregoing instrument on behalf of PRINCIPAL and SURETY, appeared before me this day in person and acknowledged respectively, that they signed and delivered said instrument as their free and voluntary act for the uses and purposes therein set forth.

Given under my hand and notarial seal this _____ day of _____ A.D. _____

My commission expires _____

Notary Public

In lieu of completing the above section of the Proposal Bid Form, the Principal may file an Electronic Bid Bond. By signing the proposal and marking the check box next to the Signature and Title line below, the Principal is ensuring the identified electronic bid bond has been executed and the Principal and Surety are firmly bound unto the State of Illinois under the conditions of the bid bond as shown above.

Electronic Bid Bond ID#

Company / Bidder Name

Signature and Title

PROPOSAL ENVELOPE



PROPOSALS

for construction work advertised for bids by the
Illinois Department of Transportation

Item No.	Item No.	Item No.

Submitted By:

Name:
Address:
Phone No.

Bidders should use an IDOT proposal envelope or affix this form to the front of a 10" x 13" envelope for the submittal of bids. If proposals are mailed, they should be enclosed in a second or outer envelope addressed to:

Engineer of Design and Environment - Room 326
Illinois Department of Transportation
2300 South Dirksen Parkway
Springfield, Illinois 62764

NOTICE

Individual bids, including Bid Bond and/or supplemental information if required, should be securely stapled.

CONTRACTOR OFFICE COPY OF CONTRACT SPECIFICATIONS

NOTICE

None of the following material needs to be returned with the bid package unless the special provisions require documentation and/or other information to be submitted.

**Contract No. 68948
PEORIA County
Section 45RS-4
Route SBI 9A
District 4 Construction Funds**



Illinois Department of Transportation

SUBCONTRACTOR DOCUMENTATION

P.A. 96-0795, effective July 1, 2010, enacted substantial changes to the provisions of the Illinois Procurement Code (30 ILCS 500). Among the changes are provisions affecting subcontractors. The Contractor awarded this contract will be required as a material condition of the contract to implement and enforce the contract requirements applicable to subcontractors approved in accordance with article 108.01 of the Standard Specifications for Road and Bridge Construction.

If the Contractor seeks approval of subcontractors to perform a portion of the work, and approval is granted by the Department, the Contractor shall provide a copy of the subcontract to the Chief Procurement Officer within 20 calendar days after execution of the subcontract.

The subcontract shall contain the certifications required to be made by subcontractors pursuant to Article 50 of the Illinois Procurement Code. This Notice to Bidders includes a document incorporating all required subcontractor certifications and disclosures for use by the Contractor in compliance with this mandate. The document is entitled State Required Ethical Standards Governing Subcontractors.

RETURN WITH SUBCONTRACT

STATE ETHICAL STANDARDS GOVERNING SUBCONTRACTORS

Article 50 of the Illinois Procurement Code establishes the duty of all State chief procurement officers, State purchasing officers, and their designees to maximize the value of the expenditure of public moneys in procuring goods, services, and contracts for the State of Illinois and to act in a manner that maintains the integrity and public trust of State government. In discharging this duty, they are charged by law to use all available information, reasonable efforts, and reasonable actions to protect, safeguard, and maintain the procurement process of the State of Illinois.

The certifications hereinafter made by the subcontractor are each a material representation of fact upon which reliance is placed should the Department approve the subcontractor. The chief procurement officer may terminate or void the subcontract approval if it is later determined that the bidder or subcontractor rendered a false or erroneous certification.

Section 50-2 of the Illinois Procurement Code provides that every person that has entered into a multi-year contract and every subcontractor with a multi-year subcontract shall certify, by July 1 of each fiscal year covered by the contract after the initial fiscal year, to the responsible chief procurement officer whether it continues to satisfy the requirements of Article 50 pertaining to the eligibility for a contract award. If a contractor or subcontractor is not able to truthfully certify that it continues to meet all requirements, it shall provide with its certification a detailed explanation of the circumstances leading to the change in certification status. A contractor or subcontractor that makes a false statement material to any given certification required under Article 50 is, in addition to any other penalties or consequences prescribed by law, subject to liability under the Whistleblower Reward and Protection Act for submission of a false claim.

A. Bribery

1. The Illinois Procurement Code provides:

Section 50-5. Bribery.

(a) Prohibition. No person or business shall be awarded a contract or subcontract under this Code who:

(1) has been convicted under the laws of Illinois or any other state of bribery or attempting to bribe an officer or employee of the State of Illinois or any other state in that officer's or employee's official capacity; or

(2) has made an admission of guilt of that conduct that is a matter of record but has not been prosecuted for that conduct.

(b) Businesses. No business shall be barred from contracting with any unit of State or local government, or subcontracting under such a contract, as a result of a conviction under this Section of any employee or agent of the business if the employee or agent is no longer employed by the business and:

(1) the business has been finally adjudicated not guilty; or

(2) the business demonstrates to the governmental entity with which it seeks to contract, or which is signatory to the contract to which the subcontract relates, and that entity finds that the commission of the offense was not authorized, requested, commanded, or performed by a director, officer, or high managerial agent on behalf of the business as provided in paragraph (2) of subsection (a) of Section 5-4 of the Criminal Code of 1961.

(c) Conduct on behalf of business. For purposes of this Section, when an official, agent, or employee of a business committed the bribery or attempted bribery on behalf of the business and in accordance with the direction or authorization of a responsible official of the business, the business shall be chargeable with the conduct.

(d) Certification. Every bid submitted to and contract executed by the State, and every subcontract subject to Section 20-120 of the Procurement Code shall contain a certification by the contractor or the subcontractor, respectively, that the contractor or subcontractor is not barred from being awarded a contract or subcontract under this Section and acknowledges that the chief procurement officer may declare the related contract void if any certifications required by this Section are false. A contractor who makes a false statement, material to the certification, commits a Class 3 felony.

2. The contractor or subcontractor certifies that it is not barred from being awarded a contract under Section 50.5.

B. Felons

1. The Illinois Procurement Code provides:

Section 50-10. Felons. Unless otherwise provided, no person or business convicted of a felony shall do business with the State of Illinois or any State agency, or enter into a subcontract, from the date of conviction until 5 years after the date of completion of the sentence for that felony, unless no person held responsible by a prosecutorial office for the facts upon which the conviction was based continues to have any involvement with the business.

2. Certification. Every bid submitted to and contract executed by the State and every subcontract subject to Section 20-120 of the Procurement Code shall contain a certification by the bidder or contractor or subcontractor, respectively, that the bidder, contractor, or subcontractor is not barred from being awarded a contract or subcontract under this Section and acknowledges that the chief procurement officer may declare the related contract void if any of the certifications required by this Section are false.

RETURN WITH SUBCONTRACT

C. Debt Delinquency

1. The Illinois Procurement Code provides:

Section 50-11 and 50-12. Debt Delinquency.

The contractor or bidder or subcontractor, respectively, certifies that it, or any affiliate, is not barred from being awarded a contract or subcontract under the Procurement Code. Section 50-11 prohibits a person from entering into a contract with a State agency, or entering into a subcontract, if it knows or should know that it, or any affiliate, is delinquent in the payment of any debt to the State as defined by the Debt Collection Board. Section 50-12 prohibits a person from entering into a contract with a State agency, or entering into a subcontract, if it, or any affiliate, has failed to collect and remit Illinois Use Tax on all sales of tangible personal property into the State of Illinois in accordance with the provisions of the Illinois Use Tax Act. The bidder or contractor or subcontractor, respectively, further acknowledges that the chief procurement officer may declare the related contract void if this certification is false or if the bidder, contractor, or subcontractor, or any affiliate, is determined to be delinquent in the payment of any debt to the State during the term of the contract.

D. Prohibited Bidders, Contractors and Subcontractors

1. The Illinois Procurement Code provides:

Section 50-10.5 and 50-60(c). Prohibited bidders, contractors and subcontractors.

The bidder or contractor or subcontractor, respectively, certifies in accordance with 30 ILCS 500/50-10.5 that no officer, director, partner or other managerial agent of the contracting business has been convicted of a felony under the Sarbanes-Oxley Act of 2002 or a Class 3 or Class 2 felony under the Illinois Securities Law of 1953 or if in violation of Subsection (c) for a period of five years from the date of conviction.. Every bid submitted to and contract executed by the State and every subcontract subject to Section 20-120 of the Procurement Code shall contain a certification by the bidder, contractor, or subcontractor, respectively, that the bidder, contractor, or subcontractor is not barred from being awarded a contract or subcontract under this Section and acknowledges that the chief procurement officer shall declare the related contract void if any of the certifications completed pursuant to this Section are false.

E. Section 42 of the Environmental Protection Act

The bidder or contractor or subcontractor, respectively, certifies in accordance with 30 ILCS 500/50-12 that the bidder, contractor, or subcontractor, is not barred from being awarded a contract or entering into a subcontract under this Section which prohibits the bidding on or entering into contracts with the State of Illinois or a State agency, or entering into any subcontract, that is subject to the Procurement Code by a person or business found by a court or the Pollution Control Board to have committed a willful or knowing violation of Section 42 of the Environmental Protection Act for a period of five years from the date of the order. The bidder or contractor or subcontractor, respectively, acknowledges that the chief procurement officer may declare the contract void if this certification is false.

The undersigned, on behalf of the subcontracting company, has read and understands the above certifications and makes the certifications as required by law.

<hr style="width: 80%; margin: 0 auto;"/> <p style="text-align: center;">Name of Subcontracting Company</p>
<hr style="width: 80%; margin: 0 auto;"/> <div style="display: flex; justify-content: space-between; width: 80%; margin: 0 auto;"> Authorized Officer Date </div>

RETURN WITH SUBCONTRACT

SUBCONTRACTOR DISCLOSURES

I. DISCLOSURES

- A. The disclosures hereinafter made by the subcontractor are each a material representation of fact upon which reliance is placed. The subcontractor further certifies that the Department has received the disclosure forms for each subcontract.

The chief procurement officer may void the bid, contract, or subcontract, respectively, if it is later determined that the bidder or subcontractor rendered a false or erroneous disclosure. A contractor or subcontractor may be suspended or debarred for violations of the Procurement Code. Furthermore, the chief procurement officer may void the contract or subcontract.

B. Financial Interests and Conflicts of Interest

1. Section 50-35 of the Illinois Procurement Code provides that all subcontracts of more than \$10,000 shall be accompanied by disclosure of the financial interests of the subcontractor. This disclosed information for the subcontractor, will be maintained as public information subject to release by request pursuant to the Freedom of Information Act, filed with the Procurement Policy Board, and shall be incorporated as a material term of the Prime Contractor's contract. Furthermore, pursuant to this Section, the Procurement Policy Board may recommend to allow or void a contract or subcontract based on a potential conflict of interest.

The financial interests to be disclosed shall include ownership or distributive income share that is in excess of 5%, or an amount greater than 60% of the annual salary of the Governor, of the subcontracting entity or its parent entity, whichever is less, unless the subcontractor is a publicly traded entity subject to Federal 10K reporting, in which case it may submit its 10K disclosure in place of the prescribed disclosure. If a subcontractor is a privately held entity that is exempt from Federal 10K reporting, but has more than 400 shareholders, it may submit the information that Federal 10K companies are required to report, and list the names of any person or entity holding any ownership share that is in excess of 5%. The disclosure shall include the names, addresses, and dollar or proportionate share of ownership of each person making the disclosure, their instrument of ownership or beneficial relationship, and notice of any potential conflict of interest resulting from the current ownership or beneficial interest of each person making the disclosure having any of the relationships identified in Section 50-35 and on the disclosure form.

In addition, all disclosures shall indicate any other current or pending contracts, subcontracts, proposals, leases, or other ongoing procurement relationships the subcontracting entity has with any other unit of state government and shall clearly identify the unit and the contract, subcontract, proposal, lease, or other relationship.

2. Disclosure Forms. Disclosure Form A is attached for use concerning the individuals meeting the above ownership or distributive share requirements. Subject individuals should be covered each by one form. In addition, a second form (Disclosure Form B) provides for the disclosure of current or pending procurement relationships with other (non-IDOT) state agencies. **The forms must be included with each bid or incorporated by reference.**

C. Disclosure Form Instructions

Form A Instructions for Financial Information & Potential Conflicts of Interest

If the subcontractor is a publicly traded entity subject to Federal 10K reporting, the 10K Report may be submitted to meet the requirements of Form A. If a subcontractor is a privately held entity that is exempt from Federal 10K reporting, but has more than 400 shareholders, it may submit the information that Federal 10K companies are required to report, and list the names of any person or entity holding any ownership share that is in excess of 5%. If a subcontractor is not subject to Federal 10K reporting, the subcontractor must determine if any individuals are required by law to complete a financial disclosure form. To do this, the subcontractor should answer each of the following questions. A "YES" answer indicates Form A must be completed. If the answer to each of the following questions is "NO", then the NOT APPLICABLE STATEMENT on the second page of Form A must be signed and dated by a person that is authorized to execute contracts for the subcontracting company. Note: These questions are for assistance only and are not required to be completed.

1. Does anyone in your organization have a direct or beneficial ownership share of greater than 5% of the bidding entity or parent entity? YES ___ NO ___
2. Does anyone in your organization have a direct or beneficial ownership share of less than 5%, but which has a value greater than \$106,447.20? YES ___ NO ___
3. Does anyone in your organization receive more than \$106,447.20 of the subcontracting entity's or parent entity's distributive income? (Note: Distributive income is, for these purposes, any type of distribution of profits. An annual salary is not distributive income.) YES ___ NO ___
4. Does anyone in your organization receive greater than 5% of the subcontracting entity's or parent entity's total distributive income, but which is less than \$106,447.20? YES ___ NO ___

(Note: Only one set of forms needs to be completed per person per subcontract even if a specific individual would require a yes answer to more than one question.)

A "YES" answer to any of these questions requires the completion of Form A. The subcontractor must determine each individual in the subcontracting entity or the subcontracting entity's parent company that would cause the questions to be answered "Yes". Each form must be signed and dated by a person that is authorized to execute contracts for your organization. **Photocopied or stamped signatures are not acceptable.** The person signing can be, but does not have to be, the person for which the form is being completed. The subcontractor is responsible for the accuracy of any information provided.

If the answer to each of the above questions is "NO", then the NOT APPLICABLE STATEMENT on page 2 of Form A must be signed and dated by a person that is authorized to execute contracts for your company.

RETURN WITH SUBCONTRACT

Form B: Instructions for Identifying Other Contracts & Procurement Related Information

Disclosure Form B must be completed for each subcontract submitted by the subcontracting entity. *Note: Checking the NOT APPLICABLE STATEMENT on Form A does not allow the subcontractor to ignore Form B. Form B must be completed, checked, and dated or the subcontract will not be approved.*

The Subcontractor shall identify, by checking Yes or No on Form B, whether it has any pending contracts, subcontracts, leases, bids, proposals, or other ongoing procurement relationship with any other (non-IDOT) State of Illinois agency. If "No" is checked, the subcontractor only needs to complete the check box on the bottom of Form B. If "Yes" is checked, the subcontractor must list all non-IDOT State of Illinois agency pending contracts, subcontracts, leases, bids, proposals, and other ongoing procurement relationships. These items may be listed on Form B or on an attached sheet(s). Contracts with cities, counties, villages, etc. are not considered State of Illinois agency contracts and are not to be included. Contracts or subcontracts with other State of Illinois agencies such as the Department of Natural Resources or the Capital Development Board must be included.

ILLINOIS DEPARTMENT OF TRANSPORTATION

Form A Subcontractor: Financial Information & Potential Conflicts of Interest Disclosure

Subcontractor Name, Legal Address, City, State, Zip, Telephone Number, Email Address, Fax Number (if available)

Disclosure of the information contained in this Form is required by the Section 50-35 of the Illinois Procurement Code (30 ILCS 500). Subcontractors desiring to enter into a subcontract of a State of Illinois contract must disclose the financial information and potential conflict of interest information as specified in this Disclosure Form. This information shall become part of the publicly available contract file. This Form A must be completed for bids in excess of \$10,000, and for all open-ended contracts. A publicly traded company may submit a 10K disclosure (or equivalent if applicable) in satisfaction of the requirements set forth in Form A. See Disclosure Form Instructions.

DISCLOSURE OF FINANCIAL INFORMATION

1. Disclosure of Financial Information. The individual named below has an interest in the SUBCONTRACTOR (or its parent) in terms of ownership or distributive income share in excess of 5%, or an interest which has a value of more than \$106,447.20 (60% of the Governor's salary as of 7/1/07). (Make copies of this form as necessary and attach a separate Disclosure Form A for each individual meeting these requirements)

FOR INDIVIDUAL (type or print information) NAME: ADDRESS Type of ownership/distributable income share: stock sole proprietorship Partnership other: (explain on separate sheet): % or \$ value of ownership/distributable income share:

2. Disclosure of Potential Conflicts of Interest. Check "Yes" or "No" to indicate which, if any, of the following potential conflict of interest relationships apply. If the answer to any question is "Yes", please attach additional pages and describe.

(a) State employment, currently or in the previous 3 years, including contractual employment of services. Yes ___ No ___

If your answer is yes, please answer each of the following questions.

1. Are you currently an officer or employee of either the Capitol Development Board or the Illinois Toll Highway Authority? Yes ___ No ___

2. Are you currently appointed to or employed by any agency of the State of Illinois? If you are currently appointed to or employed by any agency of the State of Illinois, and your annual salary exceeds \$106,447.20, (60% of the Governor's salary as of 7/1/07) provide the name the State agency for which you are employed and your annual salary.

RETURN WITH SUBCONTRACT

3. If you are currently appointed to or employed by any agency of the State of Illinois, and your annual salary exceeds \$106,447.20, (60% of the Governor's salary as of 7/1/07) are you entitled to receive (i) more than 7 1/2% of the total distributable income of your firm, partnership, association or corporation, or (ii) an amount in excess of the salary of the Governor? Yes ___ No ___
4. If you are currently appointed to or employed by any agency of the State of Illinois, and your annual salary exceeds \$106,447.20, (60% of the Governor's salary as of 7/1/07) are you and your spouse or minor children entitled to receive (i) more than 15 % in the aggregate of the total distributable income of your firm, partnership, association or corporation, or (ii) an amount in excess of 2 times the salary of the Governor? Yes ___ No ___

(b) State employment of spouse, father, mother, son, or daughter, including contractual employment services in the previous 2 years.

Yes ___ No ___

If your answer is yes, please answer each of the following questions.

1. Is your spouse or any minor children currently an officer or employee of the Capitol Development Board or the Illinois Toll Highway Authority? Yes ___ No ___
2. Is your spouse or any minor children currently appointed to or employed by any agency of the State of Illinois? If your spouse or minor children is/are currently appointed to or employed by any agency of the State of Illinois, and his/her annual salary exceeds \$106,447.20, (60 % of the Governor's salary as of 7/1/07) provide the name of your spouse and/or minor children, the name of the State agency for which he/she is employed and his/her annual salary. _____
-
3. If your spouse or any minor children is/are currently appointed to or employed by any agency of the State of Illinois, and his/her annual salary exceeds \$106,447.20, (60% of the salary of the Governor as of 7/1/07) are you entitled to receive (i) more then 71/2% of the total distributable income of your firm, partnership, association or corporation, or (ii) an amount in excess of the salary of the Governor? Yes ___ No ___
4. If your spouse or any minor children are currently appointed to or employed by any agency of the State of Illinois, and his/her annual salary exceeds \$106,447.20, (60% of the Governor's salary as of 7/1/07) are you and your spouse or minor children entitled to receive (i) more than 15 % in the aggregate of the total distributable income of your firm, partnership, association or corporation, or (ii) an amount in excess of 2 times the salary of the Governor? Yes ___ No ___

(c) Elective status; the holding of elective office of the State of Illinois, the government of the United States, any unit of local government authorized by the Constitution of the State of Illinois or the statutes of the State of Illinois currently or in the previous 3 years. Yes ___ No ___

(d) Relationship to anyone holding elective office currently or in the previous 2 years; spouse, father, mother, son, or daughter. Yes ___ No ___

(e) Appointive office; the holding of any appointive government office of the State of Illinois, the United States of America, or any unit of local government authorized by the Constitution of the State of Illinois or the statutes of the State of Illinois, which office entitles the holder to compensation in excess of the expenses incurred in the discharge of that office currently or in the previous 3 years. Yes ___ No ___

(f) Relationship to anyone holding appointive office currently or in the previous 2 years; spouse, father, mother, son, or daughter. Yes ___ No ___

(g) Employment, currently or in the previous 3 years, as or by any registered lobbyist of the State government. Yes ___ No ___

RETURN WITH SUBCONTRACT

(h) Relationship to anyone who is or was a registered lobbyist in the previous 2 years; spouse, father, mother, son, or daughter. Yes ___ No ___

(i) Compensated employment, currently or in the previous 3 years, by any registered election or reelection committee registered with the Secretary of State or any county clerk of the State of Illinois, or any political action committee registered with either the Secretary of State or the Federal Board of Elections. Yes ___ No ___

(j) Relationship to anyone; spouse, father, mother, son, or daughter; who was a compensated employee in the last 2 years by any registered election or re-election committee registered with the Secretary of State or any county clerk of the State of Illinois, or any political action committee registered with either the Secretary of State or the Federal Board of Elections. Yes ___ No ___

APPLICABLE STATEMENT

This Disclosure Form A is submitted on behalf of the INDIVIDUAL named on previous page. Under penalty of perjury, I certify the contents of this disclosure to be true and accurate to the best of my knowledge.

Completed by: _____ Date _____
Signature of Individual or Authorized Officer

NOT APPLICABLE STATEMENT

Under penalty of perjury, I have determined that no individuals associated with this organization meet the criteria that would require the completion of this Form A.

This Disclosure Form A is submitted on behalf of the SUBCONTRACTOR listed on the previous page.

_____ Date _____
Signature of Authorized Officer

RETURN WITH SUBCONTRACT

ILLINOIS DEPARTMENT
OF TRANSPORTATION

Form B
Subcontractor: Other Contracts &
Procurement Related Information
Disclosure

Subcontractor Name		
Legal Address		
City, State, Zip		
Telephone Number	Email Address	Fax Number (if available)

Disclosure of the information contained in this Form is required by the Section 50-35 of the Illinois Procurement Act (30 ILCS 500). This information shall become part of the publicly available contract file. This Form B must be completed for bids in excess of \$10,000, and for all open-ended contracts.

DISCLOSURE OF OTHER CONTRACTS, SUBCONTRACTS, AND PROCUREMENT RELATED INFORMATION

1. Identifying Other Contracts & Procurement Related Information. The SUBCONTRACTOR shall identify whether it has any pending contracts, subcontracts, including leases, bids, proposals, or other ongoing procurement relationship with any other State of Illinois agency: Yes ___ No ___

If "No" is checked, the subcontractor only needs to complete the signature box on the bottom of this page.

2. If "Yes" is checked. Identify each such relationship by showing State of Illinois agency name and other descriptive information such as bid or project number (attach additional pages as necessary). SEE DISCLOSURE FORM INSTRUCTIONS:

THE FOLLOWING STATEMENT MUST BE CHECKED

<input type="checkbox"/>	_____	_____
	Signature of Authorized Officer	Date



NOTICE TO BIDDERS

- 1. TIME AND PLACE OF OPENING BIDS.** Sealed proposals for the improvement described herein will be received by the Department of Transportation at the Harry R. Hanley Building, 2300 South Dirksen Parkway, in Springfield, Illinois until 10:00 o'clock a.m., June 11, 2010. All bids will be gathered, sorted, publicly opened and read in the auditorium at the Department of Transportation's Harry R. Hanley Building shortly after the 10:00 a.m. cut off time.
- 2. DESCRIPTION OF WORK.** The proposed improvement is identified and advertised for bids in the Invitation for Bids as:

**Contract No. 68948
PEORIA County
Section 45RS-4
Route SBI 9A
District 4 Construction Funds**

3.1 miles of resurfacing on Old U.S. Route 24 (Wheeler Road) from Glasford Road to just south of Reed City Road near Kingston Mines.

- 3. INSTRUCTIONS TO BIDDERS.** (a) This Notice, the invitation for bids, proposal and letter of award shall, together with all other documents in accordance with Article 101.09 of the Standard Specifications for Road and Bridge Construction, become part of the contract. Bidders are cautioned to read and examine carefully all documents, to make all required inspections, and to inquire or seek explanation of the same prior to submission of a bid.

(b) State law, and, if the work is to be paid wholly or in part with Federal-aid funds, Federal law requires the bidder to make various certifications as a part of the proposal and contract. By execution and submission of the proposal, the bidder makes the certification contained therein. A false or fraudulent certification shall, in addition to all other remedies provided by law, be a breach of contract and may result in termination of the contract.
- 4. AWARD CRITERIA AND REJECTION OF BIDS.** This contract will be awarded to the lowest responsive and responsible bidder considering conformity with the terms and conditions established by the Department in the rules, Invitation for Bids and contract documents. The issuance of plans and proposal forms for bidding based upon a prequalification rating shall not be the sole determinant of responsibility. The Department reserves the right to determine responsibility at the time of award, to reject any or all proposals, to readvertise the proposed improvement, and to waive technicalities.

By Order of the
Illinois Department of Transportation

Gary Hannig,
Secretary

INDEX
FOR
SUPPLEMENTAL SPECIFICATIONS
AND RECURRING SPECIAL PROVISIONS

Adopted January 1, 2010

This index contains a listing of SUPPLEMENTAL SPECIFICATIONS and frequently used RECURRING SPECIAL PROVISIONS.
ERRATA Standard Specifications for Road and Bridge Construction (Adopted 1-1-07) (Revised 1-1-10)

SUPPLEMENTAL SPECIFICATIONS

<u>Std. Spec. Sec.</u>		<u>Page No.</u>
201	Clearing, Tree Removal and Protection	1
205	Embankment	2
251	Mulch	3
253	Planting Woody Plants	4
280	Temporary Erosion Control	6
406	Hot-Mix Asphalt Binder and Surface Course	7
443	Reflective Crack Control Treatment	12
502	Excavation for Structures	15
503	Concrete Structures	16
504	Precast Concrete Structures	17
505	Steel Structures	18
540	Box Culverts	19
581	Waterproofing Membrane System	20
630	Steel Plate Beam Guardrail	21
633	Removing and Reerecting Guardrail and Terminals	22
637	Concrete Barrier	23
669	Removal and Disposal of Regulated Substances	24
672	Sealing Abandoned Water Wells	25
701	Work Zone Traffic Control and Protection	26
720	Sign Panels and Appurtenances	27
721	Sign Panel Overlay	28
722	Demountable Sign Legend Characters and Arrows	29
726	Mile Post Marker Assembly	30
733	Overhead Sign Structures	31
783	Pavement Marking and Marker Removal	32
801	Electrical Requirements	33
805	Electrical Service Installation – Traffic Signals	34
836	Pole Foundation	35
838	Breakaway Devices	36
862	Uninterruptable Power Supply	37
873	Electric Cable	39
878	Traffic Signal Concrete Foundation	41
1003	Fine Aggregates	42
1004	Coarse Aggregates	43
1005	Stone and Broken Concrete	44
1006	Metals	45
1008	Structural Steel Coatings	47
1010	Finely Divided Materials	48
1020	Portland Cement Concrete	49
1022	Concrete Curing Materials	58
1024	Nonshrink Grout	59
1030	Hot-Mix Asphalt	60
1032	Bituminous Materials	65
1042	Precast Concrete Products	68
1062	Reflective Crack Control System	70
1069	Pole and Tower	72
1074	Control Equipment	75
1076	Wire and Cable	80
1080	Fabric Materials	81
1081	Materials for Planting	82
1083	Elastomeric Bearings	84
1090	Sign Base	85
1091	Sign Face	87
1092	Sign Legend and Supplemental Panels	95
1093	Sign Supports	96
1094	Overhead Sign Structures	98
1095	Pavement Markings	104
1101	General Equipment	106
1102	Hot-Mix Asphalt Equipment	107
1103	Portland Cement Concrete Equipment	109
1106	Work Zone Traffic Control Devices	110

RECURRING SPECIAL PROVISIONS

The following RECURRING SPECIAL PROVISIONS indicated by an "X" are applicable to this contract and are included by reference:

<u>CHECK SHEET #</u>	<u>PAGE</u>
<u>NO.</u>	
1	111
	114
3 X	115
4 X	125
5 X	130
6	135
7	136
8	137
9	138
10	141
11	144
12	146
13	150
14	152
15	153
16	155
17	156
18	158
19	159
20	160
21	164
22	166
23	168
24	170
25	171
26	172
27	173
28	174
29	175
30	176
31	184
32	196
33	197

TABLE OF CONTENTS

LOCATION OF PROJECT 1
DESCRIPTION OF PROJECT 1
LOCATION OF UNDERGROUND STATE MAINTAINED FACILITIES..... 1
SEEDING, MINOR AREAS..... 2
MOWING..... 2
SUBBASE GRANULAR MATERIAL 3
PLACEMENT OF HOT-MIX ASPHALT SURFACE COURSES 3
HOT-MIX ASPHALT SURFACE COURSE SURFACE TESTS..... 3
HOT-MIX ASPHALT – PRIME COAT (BMPR) 3
PAYMENT FOR USE OF MATERIAL TRANSFER DEVICE..... 4
BACKFILL - PIPE CULVERTS..... 4
TRAFFIC CONTROL PLAN 5
TRAFFIC CONTROL AND PROTECTION BLR 22 AND BLR 22 (SPECIAL) 5
PLACEMENT OF HMA BINDER, 2¼" 6
GRADING AND SHAPING DITCHES..... 6
GRADING AND SHAPING SHOULDERS 6
MATERIAL TRANSFER DEVICE (BDE) 7
ALKALI-SILICA REACTION FOR PRECAST AND PRECAST PRESTRESSED CONCRETE (BDE)..... 8
APPROVAL OF PROPOSED BORROW AREAS, USE AREAS, AND/OR WASTE AREAS INSIDE ILLINOIS STATE BORDERS (BDE)..... 10
AUTOMATED FLAGGER ASSISTANCE DEVICES (BDE)..... 11
CONSTRUCTION AIR QUALITY - DIESEL VEHICLE EMISSIONS CONTROL (BDE) 12
CONSTRUCTION AIR QUALITY - IDLING RESTRICTIONS (BDE)..... 13
DETERMINATION OF THICKNESS (BDE)..... 14
DISADVANTAGED BUSINESS ENTERPRISE PARTICIPATION (BDE) 25
ENGINEER’S FIELD OFFICE TYPE A (BDE) 32
EQUIPMENT RENTAL RATES (BDE)..... 34
FLAGGER AT SIDE ROADS AND ENTRANCES (BDE) 35
HOT-MIX ASPHALT – ANTI-STRIPPING ADDITIVE (BDE)..... 36
HOT-MIX ASPHALT - DENSITY TESTING OF LONGITUDINAL JOINTS (BDE) 36
HOT-MIX ASPHALT – DROP-OFFS (BDE) 37
HOT-MIX ASPHALT - FINE AGGREGATE (BDE) 37
HOT-MIX ASPHALT – PLANT TEST FREQUENCY (BDE)..... 39
HOT-MIX ASPHALT – QC/QA ACCEPTANCE CRITERIA (BDE) 40
HOT-MIX ASPHALT – TRANSPORTATION (BDE) 40
IMPROVED SUBGRADE (BDE)..... 41
LIQUIDATED DAMAGES (BDE)..... 43

NATIONAL POLLUTANT DISCHARGE ELIMINATION SYSTEM / EROSION AND SEDIMENT CONTROL DEFICIENCY DEDUCTION (BDE)	43
PAVEMENT PATCHING (BDE).....	44
PAYMENTS TO SUBCONTRACTORS (BDE).....	44
PERSONAL PROTECTIVE EQUIPMENT (BDE).....	45
PRECAST CONCRETE HANDLING HOLES (BDE).....	46
RECLAIMED ASPHALT PAVEMENT (RAP) (BDE).....	47
REFLECTIVE SHEETING ON CHANNELIZING DEVICES (BDE).....	54
SELF-CONSOLIDATING CONCRETE FOR PRECAST PRODUCTS (BDE).....	55
SUBCONTRACTOR MOBILIZATION PAYMENTS (BDE).....	56
TEMPORARY EROSION CONTROL (BDE).....	56
TRUCK MOUNTED/TRAILER MOUNTED ATTENUATORS (BDE).....	58
WORKING DAYS (BDE).....	58
BITUMINOUS MATERIALS COST ADJUSTMENTS (BDE) (RETURN FORM WITH BID).....	59
FUEL COST ADJUSTMENT (BDE) (RETURN FORM WITH BID).....	62

STATE OF ILLINOIS

SPECIAL PROVISIONS

The following Special Provisions supplement the "Standard Specifications for Road and Bridge Construction," adopted January 1, 2007, the latest edition of the "Manual on Uniform Traffic Control Devices for Streets and Highways," and the "Manual of Test Procedures for Materials" in effect on the date of invitation for bids, and the Supplemental Specifications and Recurring Special Provisions indicated on the Check Sheet included herein which apply to and govern the construction of SBI Route 9A (Wheeler Rd.), Section 45RS-4 in Peoria County, Contract No. 68948 and in case of conflict with any part or parts of said Specifications, the said Special Provisions shall take precedence and shall govern.

LOCATION OF PROJECT

This project is located on Wheeler Road (Old US Route 24) beginning at Glasford Road and terminating at approximately 3.1 miles to the east (Station 170+50) in Peoria County.

DESCRIPTION OF PROJECT

This project is approximately 3.1 miles long and consists of hot-mix asphalt binder, resurfacing, drainage improvements and other related collateral work necessary to complete the project.

LOCATION OF UNDERGROUND STATE MAINTAINED FACILITIES

Effective August 3, 2007

Revised July 31, 2009

The Contractor shall be responsible for locating existing and proposed IDOT electrical facilities (traffic signal, overhead lighting, Intelligent Transportation System, etc.) prior to performing any work at his/her own expense if required. The Contractor shall also be liable for any damage to IDOT facilities resulting from inaccurate locating.

The Contractor may obtain, on request, plans for existing electrical facilities from the Department.

The Contractor shall also be responsible for locating and providing protection for IDOT facilities during all phases of construction. If at any time the facilities are damaged, the Contractor shall immediately notify the Department and make all necessary arrangements for repair to the satisfaction of the Engineer. This work will not be paid for separately, but shall be included in the contract bid price.

SEEDING, MINOR AREAS

Effective July 1, 1990

Revised January 1, 2007

Seeding, fertilizing, and mulching shall be done in accordance with Article 250 of the Standard Specifications except for the following revisions:

All areas disturbed by the work performed shall be seeded, fertilized, and mulched in accordance with Article 251.03(a). The materials may be purchased locally and placed as directed by the engineer.

The estimated area is approximately 0.20 acres. The seed mixture shall be applied at 100 pounds/acre (110 kg/ha). The mixture shall be one that contains a high percentage of Kentucky Blue Grass. All seeds shall meet the purity and noxious weed requirements of Article 1081.04 of the Standard Specifications, and be approved by the engineer.

The fertilizer nutrients shall be applied at a rate of 270 lbs. (300 kg) of actual nutrients per acre (hectare). The fertilizer furnished shall be ready mixed material having a ratio of (1-1-1).

The contractor shall provide the engineer with the test results from the seed container and the chemical analysis of the fertilizer nutrients.

The seed, fertilizer, and mulch will not be measured for payment but will be considered included in the cost of GRADING AND SHAPING DITCHES.

MOWING

Effective December 11, 2001

Revised January 1, 2007

This work shall consist of mowing the roadway foreslopes to the ditchline or for a width of 15' (4.572 meters) from both edges of pavement or paved shoulder, whichever is less. At intersecting roadways, the mowing shall extend to the proposed right of way for a distance of 150' (45 m) on either side of the intersection. The height of the mowing shall not be more than 6" (150 mm). Equipment used shall be capable of completely severing all growth at the cutting height and distributing it evenly over the mowed area. The Contractor will not be required to mow continuously wet ditches and drainage ways, slopes greater than 1:3 (V:H), or areas which may be designated by the Engineer as not mowable. Mowing shall be done within the project limits during the construction of the project as directed by the Engineer and prior to the final inspection of the project. Any subsequent mowing required to disperse mowed material shall be considered as included in the cost of the mowing. Debris encountered during mowing, which interferes with the mowing operation or is visible from the roadway shall be removed and disposed of according to Article 250.05.

Method of Measurement: Mowing will be measured for payment in units of 100' (30 m) in horizontal distances along the roadway centerline. For purposes of measurement, the quantity of units to be paid for each individual mowing is defined as the net length of the project as shown on the cover sheet of the construction plans divided by 100' (30 m) which includes the left and right sides of the roadway. No allowances will be made for variations in width of mowing.

Basis of Payment: This work will be paid for at the contract unit price per unit for MOWING.

SUBBASE GRANULAR MATERIAL

Effective: November 5, 2004

This work shall be in accordance with Section 311 of the Standard Specifications and as specified herein.

All Subbase Granular Material shall have a minimum IBR of 40.

PLACEMENT OF HOT-MIX ASPHALT SURFACE COURSES

Effective: March 22, 2001

Revised: January 1, 2007

Placement of hot-mix asphalt surface courses shall not be allowed after October 15th of any calendar year. The contractor is responsible for scheduling construction activities to complete placement of surface courses prior to October 15th. If surface courses are not in place by October 15th, the contractor is responsible for implementing any measures needed to make the roadway suitable for winter traffic and snow plowing activities. Any additional costs associated with this provision shall be considered included in the cost of the unit prices bid for hot-mix asphalt surface course items.

HOT-MIX ASPHALT SURFACE COURSE SURFACE TESTS

Effective: November 1, 2003

Revised January 1, 2007

The Contractor shall provide a person to operate the straight edge in accordance with Article 406.11 of the Standard Specifications and communicate with IDOT personnel to minimize the surface course bumps. If surface course bumps cannot be removed at this time, IDOT personnel will record the locations and provide deductions as stated in Article 406.11.

HOT-MIX ASPHALT – PRIME COAT (BMPR)

Effective: April 23, 2010

Remove the first sentence of the second paragraph of Article 406.02 of the Standard Specifications: "When emulsified asphalts are used, they shall be diluted with an equal volume of potable water."

Revise the first paragraph of Article 406.05(b) of the Standard Specifications to read:

"Prime Coat. The base, or base and gutter shall be clean and dry. The bituminous priming material shall be prepared according to Article 403.05 and applied according to Article 403.10. "

Revise the first paragraph of Article 406.05(b)(1) of the Standard Specifications to read:

“(1) Brick, Concrete or HMA Bases. The prime shall be applied uniformly at a residual asphalt rate of 0.02 to 0.06 gal/sq yd (0.1 to 0.3 L/sq m). The exact residual asphalt rate will be specified by the Engineer, typically 0.04 gal/sq yd for milled surfaces and 0.025 gal/sq yd for smooth surfaces. Prior to priming, the residual asphalt rate shall be verified by passing the applicator truck over a 1 ft x 1 ft pre-weighed, non-woven fabric, oven drying the fabric and prime to a constant mass in an oven at 230° F (110° C), and determining the final oven dry weight. The difference between the two weights will be the residual asphalt weight per square foot. The residual asphalt weight per square foot shall be converted to gallons per square yard using a residual asphalt specific gravity of 1.03.”

Add the following to the second paragraph of Article 406.05(b)(1):

“When prime coat is applied on two lane roadways, the pavement shall be primed one lane at a time. The primed lane shall remain closed for a minimum of one hour and shall remain closed until the prime does not pickup under traffic. On multi-lane pavements, traffic will not be allowed on the primed surface until it is fully cured, such that it does not pickup under traffic.”

Replace the last sentence of the third paragraph of Article 406.05(b)(1) with the following:

“Prime coat shall be fully cured prior to placement of HMA to prevent pickup by haul trucks or paving equipment. If pickup occurs, paving shall cease in order to provide additional cure time, or an approved release agent may be applied to the tires of the haul trucks or paving equipment as needed to prevent pickup of the prime coat.”

PAYMENT FOR USE OF MATERIAL TRANSFER DEVICE

Effective April 23, 2010

This work shall be performed as specified in the plans and specifications herein.

No payment will be made for tonnages of HMA items required to be placed with a material transfer device, but were not able to be placed with a material transfer device.

The maximum tonnage eligible for payment when placed with the material transfer device will be limited to the final pay quantity of the pay items placed.

BACKFILL - PIPE CULVERTS

Effective October 15, 1995

Revised January 1, 2007

When trenches or excavation are made across existing pavement to remain in place, revise Article 542.04(f) 4th paragraph as follows:

“The remainder of the trench and excavation shall be backfilled with trench backfill. All backfill material shall be deposited in the trench or excavation in such a manner as not to damage the culvert. Trench backfill above the center of the pipe shall be compacted by either Method 2 or Method 3 specified in Article 550.07, or in accordance with Method 1 specified in Article 550.07, except that the compacted lifts shall not exceed 8" (200 mm) in thickness.

When the trench has been widened for the removal and replacement of unstable or unsuitable material, the backfilling with trench backfill and impervious material will be required for the entire width of the trench or excavation. Each 8" (200 mm) layer for the entire trench width shall be completed before beginning the placement of the next layer.”

Basis of Payment: This work will not be paid for separately but shall be included in the contract unit price per foot (meter) for PIPE CULVERTS, of the type and diameter specified. Trench backfill will be paid for as specified in Article 208.04.

TRAFFIC CONTROL PLAN

Effective March 19, 2010

Traffic control shall be in accordance with the applicable sections of the “Standard Specifications for Road and Bridge Construction,” the applicable guidelines contained in the “Illinois Manual on Uniform Traffic Control Devices for Streets and Highways,” these Special Provisions, and any special details and Highway Standards contained herein and in the plans.

Special attention is called to Section 701 and Articles 107.09 and 107.14 of the “Standard Specifications for Road and Bridge Construction” and the following Highway Standards relating to traffic control:

- 701301 701306 701311 701901 BLR 22

The Traffic Control and Protection Standards and details listed above are to serve as a guide for minimum traffic control and protection for the various situations encountered during the construction of this improvement. They may be modified to improve their effectiveness, to better fit certain situations and applications that may arise, including reasonable adjustment spacing of signs, etc. to fit field conditions. In some instances, one or more Traffic Control and Protection Standards may be used within the same overall area of construction covered by another standard. Modifications of these standards are subject to the approval of the Engineer.

The contractor shall notify the Resident in writing seven calendar days prior to activities that involve road closures or staging shifts. The contractor shall also notify local residents and municipalities seven calendar days prior to closing the road.

TRAFFIC CONTROL AND PROTECTION BLR 22 AND BLR 22 (SPECIAL)

Effective April 25, 2008 Revised July 31, 2009

This work shall be in accordance with Section 701 of the Standard Specifications and shall include all material, equipment, and labor necessary to install the traffic control items as shown on the Highway Standard BLR 22 or as shown and described in the plans and specifications.

Add the following to the first paragraph of Article 701.20(a):

“Traffic Control and Protection Standard BLR 22 and Traffic Control and Protection Standard BLR 22(Special).”

Add the following to the first paragraph of Article 701.20(b):

“Traffic Control and Protection Standard BLR 22 and Traffic Control and Protection Standard BLR 22(Special).”

PLACEMENT OF HMA BINDER, 2¼"

This work shall consist of place 2¼" of HMA Binder at the edge of pavement and running a cross slope of 1.5% with the depth at centerline not exceeding 3¼" . If the depth at centerline exceeds 3¼", the Contractor shall adjust the cross slope to a minimum of 1.0% and/or decrease the thickness at the edge of pavement to not less than 1¾".

Basis of Payment: This work shall not be paid for separately, but shall be considered included in the contract unit price per foot for HMA BINDER COURSE, IL-12.5, N50.

GRADING AND SHAPING DITCHES

This work shall consist of cutting and shaping ditches at the locations shown in the schedule of quantities and cross sections, and the removal of any waste material from the jobsite according to Article 202.03 of the Standard Specifications. The removal of all trees and brush in these areas shall not be measured for payment, but shall include the cost of the GRADING AND SHAPING DITCHES. The Engineer shall verify locations as shown in the plans and may adjust them accordingly.

Basis of Payment: This work shall not be paid for separately, but shall be considered included in the contract unit price per foot for GRADNING AND SHAPING DITCHES.

GRADING AND SHAPING SHOULDERS

This work shall consist of grading the earth shoulder to an elevation lower than the edge of pavement, and the removal of any waste material from the jobsite according to Article 202.03 of the Standard Specifications. The removal shall be to a depth deep enough to allow for a minimum of 1.5" of aggregate shoulder. The Engineer shall verify locations as shown in the plans and may adjust them accordingly.

Basis of Payment: This work shall not be paid for separately, but shall be considered included in the contract unit price per foot for GRADING AND SHAPING SHOULDERS.

MATERIAL TRANSFER DEVICE (BDE)

Effective Date: June 15, 1999

Revised Date: January 1, 2009

Description. This work shall consist of placing hot-mix asphalt binder course, IL 12.5, N50 and hot-mix asphalt surface course, Mix D, N50, except that these materials shall be placed using a material transfer device.

Materials and Equipment. The material transfer device shall have a minimum surge capacity of 15 tons (13.5 metric tons), shall be self-propelled and capable of moving independent of the paver, and shall be equipped with the following:

- (a) Front-Dump Hopper and Conveyor. The conveyor shall provide a positive restraint along the sides of the conveyor to prevent material spillage. Material Transfer devices having paver style hoppers shall have a horizontal bar restraint placed across the foldable wings which prevents the wings from being folded.
- (b) Paver Hopper Insert. The paver hopper insert shall have a minimum capacity of 14 tons (12.7 metric tons).
- (c) Mixer/Agitator Mechanism. This re-mixing mechanism shall consist of a segmented, anti-segregation, re-mixing auger or two full-length longitudinal paddle mixers designed for the purpose of re-mixing the hot-mix asphalt (HMA). The longitudinal paddle mixers shall be located in the paver hopper insert.

CONSTRUCTION REQUIREMENTS

General. The material transfer device shall be used for the placement of hot-mix asphalt binder course, IL 12.5, N50 and hot-mix asphalt surface course, Mix D, N50. The material transfer device speed shall be adjusted to the speed of the paver to maintain a continuous, non-stop paving operation.

Use of a material transfer device with a roadway contact pressure exceeding 20 psi (138 kPa) will be limited to partially completed segments of full-depth HMA pavement where the thickness of binder in place is 10 in. (250 mm) or greater.

Structures. The material transfer device may be allowed to travel over structures under the following conditions:

- (a) Approval will be given by the Engineer.
- (b) The vehicle shall be emptied of HMA material prior to crossing the structure and shall travel at crawl speed across the structure.
- (c) The tires of the vehicle shall travel on or in close proximity and parallel to the beam and/or girder lines of the structure.

Method of Measurement. This work will be measured for payment in tons (metric tons) for hot-mix asphalt binder course, IL 12.5, N50 and hot-mix asphalt surface course, Mix D, N50 materials placed with a material transfer device.

Basis of Payment. This work will be paid for at the contract unit price per ton (metric ton) for MATERIAL TRANSFER DEVICE.

The various HMA mixtures placed with the material transfer device will be paid for as specified in their respective specifications. The Contractor may choose to use the material transfer device for other applications on this project; however, no additional compensation will be allowed.

ALKALI-SILICA REACTION FOR PRECAST AND PRECAST PRESTRESSED CONCRETE (BDE)

Effective: January 1, 2009

Description. This special provision is intended to reduce the risk of a deleterious alkali-silica reaction in precast and precast prestressed concrete exposed to humid or wet conditions. The special provision is not intended or adequate for concrete exposed to potassium acetate, potassium formate, sodium acetate or sodium formate. The special provision shall not apply to the dry environment (humidity less than 60 percent) found inside buildings for residential or commercial occupancy. The special provision shall also not apply to cast-in-place concrete.

Aggregate Expansion Values. Each coarse and fine aggregate will be tested by the Department for alkali reaction according to ASTM C 1260. The test will be performed with Type I or II cement having a total equivalent alkali content ($Na_2O + 0.658K_2O$) of 0.90 percent or greater. The Engineer will determine the assigned expansion value for each aggregate, and these values will be made available on the Department’s Alkali-Silica Potential Reactivity Rating List. The Engineer may differentiate aggregate based on ledge, production method, gradation number, or other factors. An expansion value of 0.05 percent will be assigned to limestone or dolomite coarse aggregates and 0.03 percent to limestone or dolomite fine aggregates (manufactured stone sand); however the Department reserves the right to perform the ASTM C 1260 test.

Aggregate Groups. Each combination of aggregates used in a mixture will be assigned to an aggregate group. The point at which the coarse aggregate and fine aggregate expansion values intersect in the following table will determine the group.

AGGREGATE GROUPS			
Coarse Aggregate or Coarse Aggregate Blend ASTM C 1260 Expansion	Fine Aggregate or Fine Aggregate Blend ASTM C 1260 Expansion		
	≤ 0.16%	> 0.16% - 0.27%	> 0.27%
	≤ 0.16%	Group I	Group II
> 0.16% - 0.27%	Group II	Group II	Group III
> 0.27%	Group III	Group III	Group IV

Mixture Options. Based upon the aggregate group, the following mixture options shall be used; however, the Department may prohibit a mixture option if field performance shows a deleterious alkali-silica reaction or Department testing indicates the mixture may experience a deleterious alkali-silica reaction.

- Group I - Mixture options are not applicable. Use any cement or finely divided mineral.
- Group II - Mixture options 1, 2, 3, 4, or 5 shall be used.
- Group III - Mixture options 1, 2 and 3 combined, 4, or 5 shall be used.
- Group IV - Mixture options 1, 2 and 4 combined, or 5 shall be used.

- a) Mixture Option 1. The coarse or fine aggregates shall be blended to place the material in a group that will allow the selected cement or finely divided mineral to be used.

When a coarse or fine aggregate is blended, the weighted expansion value shall be calculated separately for the coarse and fine aggregate as follows:

$$\text{Weighted Expansion Value} = (a/100 \times A) + (b/100 \times B) + (c/100 \times C) + \dots$$

Where: a, b, c... = percentage of aggregate in the blend;
A, B, C... = expansion value for that aggregate.

- b) Mixture Option 2. A finely divided mineral shall be used as described in 1), 2), 3), or 4) that follow. The replacement ratio is defined as "finely divided mineral:portland cement".
 - 1) Class F Fly Ash. For Class PC concrete, precast products, and PS concrete, Class F fly ash shall replace 15 percent of the portland cement at a minimum replacement ratio of 1.5:1.
 - 2) Class C Fly Ash. For Class PC Concrete, precast products, and Class PS concrete, Class C fly ash with 18 percent to less than 26.5 percent calcium oxide content, and less than 2.0 percent loss on ignition, shall replace 20 percent of the portland cement at a minimum replacement ratio of 1:1; or at a minimum replacement ratio of 1.25:1 if the loss on ignition is 2.0 percent or greater. Class C fly ash with less than 18 percent calcium oxide content shall replace 20 percent of the portland cement at a minimum replacement ratio of 1.25:1.
 - 3) Ground Granulated Blast-Furnace Slag. For Class PC concrete, precast products, and Class PS concrete, ground granulated blast-furnace slag shall replace 25 percent of the portland cement at a minimum replacement ratio of 1:1.
 - 4) Microsilica or High Reactivity Metakaolin. Microsilica solids or high reactivity metakaolin shall be added to the mixture at a minimum 25 lb/cu yd (15 kg/cu m) or 27 lb/cu yd (16 kg/cu m) respectively.
- c) Mixture Option 3. The cement used shall have a maximum total equivalent alkali content ($\text{Na}_2\text{O} + 0.658\text{K}_2\text{O}$) of 0.60 percent. When aggregate in Group II is involved, any finely divided mineral may be used with a portland cement.
- d) Mixture Option 4. The cement used shall have a maximum total equivalent alkali content ($\text{Na}_2\text{O} + 0.658\text{K}_2\text{O}$) of 0.45 percent. When aggregate in Group II or III is involved, any finely divided mineral may be used with a portland cement.

- e) Mixture Option 5. The proposed cement or finely divided mineral may be used if the ASTM C 1567 expansion value is ≤ 0.16 percent when performed on the aggregate in the concrete mixture with the highest ASTM C 1260 test result. The ASTM C 1567 test will be valid for two years, unless the Engineer determines the materials have changed significantly. The 0.20 percent autoclave expansion limit in ASTM C 1567 shall not apply.

If during the two year time period the Contractor needs to replace the cement, and the replacement cement has an equal or lower total equivalent alkali content ($\text{Na}_2\text{O} + 0.658\text{K}_2\text{O}$), a new ASTM C 1567 test will not be required.

Testing. If an individual aggregate has an ASTM C 1260 expansion value > 0.16 percent, an ASTM C 1293 test may be performed by the Contractor to evaluate the Department's ASTM C 1260 test result. The ASTM C 1293 test shall be performed with Type I or II cement having a total equivalent alkali content ($\text{Na}_2\text{O} + 0.658\text{K}_2\text{O}$) of 0.80 percent or greater. The interior vertical wall of the ASTM C 1293 recommended container (pail) shall be half covered with a wick of absorbent material consisting of blotting paper. If the testing laboratory desires to use an alternate container or wick of absorbent material, ASTM C 1293 test results with an alkali-reactive aggregate of known expansion characteristics shall be provided to the Engineer for review and approval. If the expansion is less than 0.040 percent after one year, the aggregate will be assigned an ASTM C 1260 expansion value of 0.08 percent that will be valid for two years, unless the Engineer determines the aggregate has changed significantly.

The Engineer reserves the right to verify a Contractor's ASTM C 1293 or 1567 test result. The Engineer will not accept the result if the precision and bias for the test methods are not met.

The laboratory performing the ASTM C 1567 test shall either be accredited by the AASHTO Materials Reference Laboratory (AMRL) for ASTM C 227 under Portland Cement or Aggregate; or shall be inspected for Hydraulic Cement - Physical Tests by the Cement and Concrete Reference Laboratory (CCRL) and shall be approved by the Department. The laboratory performing the ASTM C 1293 test shall be inspected for Portland Cement Concrete by CCRL and shall be approved by the Department.

APPROVAL OF PROPOSED BORROW AREAS, USE AREAS, AND/OR WASTE AREAS INSIDE ILLINOIS STATE BORDERS (BDE)

Effective: November 1, 2008

Revise the title of Article 107.22 of the Standard Specifications to read:

"107.22 Approval of Proposed Borrow Areas, Use Areas, and/or Waste Areas Inside Illinois State Borders."

Add the following sentence to the end of the first paragraph of Article 107.22 of the Standard Specifications:

"Proposed borrow areas, use areas, and/or waste areas outside of Illinois shall comply with Article 107.01."

AUTOMATED FLAGGER ASSISTANCE DEVICES (BDE)

Effective: January 1, 2008

Description. This work shall consist of furnishing and operating automated flagger assistance devices (AFADs) as part of the work zone traffic control and protection for two-lane highways where two-way traffic is maintained over one lane of pavement. Use of these devices shall be at the option of the Contractor.

Equipment. AFADs shall be according to the FHWA memorandum, "MUTCD - Revised Interim Approval for the use of Automated Flagger Assistance Devices in Temporary Traffic Control Zones (IA-4R)", dated January 28, 2005. The devices shall be mounted on a trailer or a moveable cart and shall meet the requirements of NCHRP 350, Category 4.

The AFAD shall be the Stop/Slow type. This device uses remotely controlled "STOP" and "SLOW" signs to alternately control right-of-way.

Signs for the AFAD shall be according to Article 701.03 of the Standard Specifications and the MUTCD. The signs shall be 24 x 24 in. (600 x 600 mm) having an octagon shaped "STOP" sign on one side and a diamond shaped "SLOW" sign on the opposite side. The letters on the signs shall be 8 in. (200 mm) high. If the "STOP" sign has louvers, the full sign face shall be visible at a distance of 50 ft (15 m) and greater.

The signs shall be supplemented with one of the following types of lights.

- (a) Flashing Lights. When flashing lights are used, white or red flashing lights shall be mounted within the "STOP" sign face and white or yellow flashing lights within the "SLOW" sign face.
- (b) Stop and Warning Beacons. When beacons are used, a stop beacon shall be mounted 24 in. (600 mm) or less above the "STOP" sign face and a warning beacon mounted 24 in. (600 mm) or less above, below, or to the side of the "SLOW" sign face. As an option, a Type B warning light may be used in lieu of the warning beacon.

A "WAIT ON STOP" sign shall be placed on the right hand side of the roadway at a point where drivers are expected to stop. The sign shall be 24 x 30 in. (600 x 750 mm) with a black legend and border on a white background. The letters shall be at least 6 in. (150 mm) high.

This device may include a gate arm or mast arm that descends to a horizontal position when the "STOP" sign is displayed and rises to a vertical position when the "SLOW" sign is displayed. When included, the end of the arm shall reach at least to the center of the lane being controlled. The arm shall have alternating red and white retroreflective stripes, on both sides, sloping downward at 45 degrees toward the side on which traffic will pass. The stripes shall be 6 in. (150 mm) in width and at least 2 in. (50 mm) in height.

Flagging Requirements. Flaggers and flagging requirements shall be according to Article 701.13 of the Standard Specifications and the following.

AFADs shall be placed at each end of the traffic control, where a flagger is shown on the plans. The flaggers shall be able to view the face of the AFAD and approaching traffic during operation.

To stop traffic, the "STOP" sign shall be displayed, the corresponding lights/beacon shall flash, and when included, the gate arm shall descend to a horizontal position. To permit traffic to move, the "SLOW" sign shall be displayed, the corresponding lights/beacon shall flash, and when included, the gate arm shall rise to a vertical position.

If used at night, the AFAD location shall be illuminated according to Section 701 of the Standard Specifications.

When not in use, AFADs will be considered nonoperating equipment and shall be stored according to Article 701.11 of the Standard Specifications.

Basis of Payment. This work will not be paid for separately but shall be considered as included in the cost of the various traffic control items included in the contract.

CONSTRUCTION AIR QUALITY - DIESEL VEHICLE EMISSIONS CONTROL (BDE)

Effective: April 1, 2009

Revised: July 1, 2009

Diesel Vehicle Emissions Control. The reduction of construction air emissions shall be accomplished by using cleaner burning diesel fuel. The term "equipment" refers to any and all diesel fuel powered devices rated at 50 hp and above, to be used on the project site in excess of seven calendar days over the course of the construction period on the project site (including any "rental" equipment).

All equipment on the jobsite, with engine ratings of 50 hp and above, shall be required to: use Ultra Low Sulfur Diesel fuel (ULSD) exclusively (15 ppm sulfur content or less).

Diesel powered equipment in non-compliance will not be allowed to be used on the project site, and is also subject to a notice of non-compliance as outlined below.

The Contractor shall submit copies of monthly summary reports and include certified copies of the ULSD diesel fuel delivery slips for diesel fuel delivered to the jobsite for the reporting time period, noting the quantity of diesel fuel used.

If any diesel powered equipment is found to be in non-compliance with any portion of this specification, the Engineer will issue the Contractor a notice of non-compliance and identify an appropriate period of time, as outlined below under environmental deficiency deduction, in which to bring the equipment into compliance or remove it from the project site.

Any costs associated with bringing any diesel powered equipment into compliance with these diesel vehicle emissions controls shall be considered as included in the contract unit prices bid for the various items of work involved and no additional compensation will be allowed. The Contractor's compliance with this notice and any associated regulations shall also not be grounds for a claim.

Environmental Deficiency Deduction. When the Engineer is notified, or determines that an environmental control deficiency exists, he/she will notify the Contractor in writing, and direct the Contractor to correct the deficiency within a specified time period. The specified time-period, which begins upon Contractor notification, will be from 1/2 hour to 24 hours long, based on the urgency of the situation and the nature of the deficiency. The Engineer shall be the sole judge regarding the time period.

The deficiency will be based on lack of repair, maintenance and diesel vehicle emissions control.

If the Contractor fails to correct the deficiency within the specified time frame, a daily monetary deduction will be imposed for each calendar day or fraction thereof the deficiency continues to exist. The calendar day(s) will begin when the time period for correction is exceeded and end with the Engineer's written acceptance of the correction. The daily monetary deduction will be \$1,000.00 for each deficiency identified.

If a Contractor or subcontractor accumulates three environmental deficiency deductions in a contract period, the Contractor will be shutdown until the deficiency is corrected. Such a shutdown will not be grounds for any extension of contract time, waiver of penalties, or be grounds for any claim.

CONSTRUCTION AIR QUALITY - IDLING RESTRICTIONS (BDE)

Effective: April 1, 2009

Idling Restrictions. The Contractor shall establish truck-staging areas for all diesel powered vehicles that are waiting to load or unload material at the jobsite. Staging areas shall be located where the diesel emissions from the equipment will have a minimum impact on adjacent sensitive receptors. The Department will review the selection of staging areas, whether within or outside the existing highway right-of-way, to avoid locations near sensitive areas or populations to the extent possible. Sensitive receptors include, but are not limited to, hospitals, schools, residences, motels, hotels, daycare facilities, elderly housing and convalescent facilities. Diesel powered engines shall also be located as far away as possible from fresh air intakes, air conditioners, and windows. The Engineer will approve staging areas before implementation.

Diesel powered vehicle operators may not cause or allow the motor vehicle, when it is not in motion, to idle for more than a total of 10 minutes within any 60 minute period, except under any of the following circumstances:

- 1) The motor vehicle has a gross vehicle weight rating of less than 8000 lb (3630 kg).
- 2) The motor vehicle idles while forced to remain motionless because of on-highway traffic, an official traffic control device or signal, or at the direction of a law enforcement official.
- 3) The motor vehicle idles when operating defrosters, heaters, air conditioners, or other equipment solely to prevent a safety or health emergency.
- 4) A police, fire, ambulance, public safety, other emergency or law enforcement motor vehicle, or any motor vehicle used in an emergency capacity, idles while in an emergency or training mode and not for the convenience of the vehicle operator.
- 5) The primary propulsion engine idles for maintenance, servicing, repairing, or diagnostic purposes if idling is necessary for such activity.
- 6) A motor vehicle idles as part of a government inspection to verify that all equipment is in good working order, provided idling is required as part of the inspection.

- 7) When idling of the motor vehicle is required to operate auxiliary equipment to accomplish the intended use of the vehicle (such as loading, unloading, mixing, or processing cargo; controlling cargo temperature; construction operations, lumbering operations; oil or gas well servicing; or farming operations), provided that this exemption does not apply when the vehicle is idling solely for cabin comfort or to operate non-essential equipment such as air conditioning, heating, microwave ovens, or televisions.
- 8) When the motor vehicle idles due to mechanical difficulties over which the operator has no control.
- 9) The outdoor temperature is less than 32 °F (0 °C) or greater than 80 °F (26 °C).

When the outdoor temperature is greater than or equal to 32 °F (0 °C) or less than or equal to 80 °F (26 °C), a person who operates a motor vehicle operating on diesel fuel shall not cause or allow the motor vehicle to idle for a period greater than 30 minutes in any 60 minute period while waiting to weigh, load, or unload cargo or freight, unless the vehicle is in a line of vehicles that regularly and periodically moves forward.

The above requirements do not prohibit the operation of an auxiliary power unit or generator set as an alternative to idling the main engine of a motor vehicle operating on diesel fuel.

Environmental Deficiency Deduction. When the Engineer is notified, or determines that an environmental control deficiency exists based on non-compliance with the idling restrictions, he/she will notify the Contractor, and direct the Contractor to correct the deficiency.

If the Contractor fails to correct the deficiency a monetary deduction will be imposed. The monetary deduction will be \$1,000.00 for each deficiency identified.

DETERMINATION OF THICKNESS (BDE)

Effective: April 1, 2009

Revise Articles 353.12 and 353.13 of the Standard Specifications to Articles 353.13 and 353.14 respectively.

Add the following Article to the Standard Specifications:

“353.12 Tolerance in Thickness. The thickness of base course pay items that individually contain at least 1000 sq yd (840 sq m) of contiguous area, except for temporary construction, bike paths, and individual locations less than 500 ft (150 m) long, will be evaluated. Temporary construction is defined as those areas constructed and removed under the same contract. If the base course cannot be cored for thickness prior to placement of the cover layer(s), the Engineer will determine the thickness of the cover layer(s), and subtract them from the measured core thickness to determine the base course thickness.

The procedure described in Article 407.10(b) will be followed, except the option of correcting deficient pavement with additional lift(s) shall not apply.”

Revise Article 354.09 of the Standard Specifications to read:

“354.09 Tolerance in Thickness. The thickness of base course widening pay items that individually contain at least 1000 sq yd (840 sq m) of contiguous area, except for temporary construction; bike paths and individual locations less than 3 ft (1 m) wide or 1000 ft (300 m) long, will be evaluated. Temporary construction is defined as those areas constructed and removed under the same contract. If the base course widening cannot be cored for thickness prior to placement of the cover layer(s), the Engineer will determine the thickness of the cover layer(s), and subtract them from the measured core thickness to determine the base course widening thickness.

The procedure described in Article 407.10(b) will be followed, except:

- (a) The width of a unit shall be the width of the widening along one edge of the pavement.
- (b) The length of the unit shall be 1000 ft (300 m).
- (c) The option of correcting deficient pavement with additional lift(s) shall not apply.”

Revise Article 355.09 of the Standard Specifications to read:

“355.09 Tolerance in Thickness. The thickness of HMA base course pay items that individually contain at least 1000 sq yd (840 sq m) of contiguous area, except for temporary construction; bike paths and individual locations less than 500 ft (150 m) long, will be evaluated according to Article 407.10(b). Temporary construction is defined as those areas constructed and removed under the same contract. If the base course cannot be cored for thickness prior to placement of the cover layer(s), the Engineer will determine the thickness of the cover layer(s), and subtract them from the measured core thickness to determine the base course thickness.”

Revise Article 356.07 of the Standard Specifications to read:

“356.07 Tolerance in Thickness. The thickness of HMA base course widening pay items that individually contain at least 1000 sq yd (840 sq m) of contiguous area, except for temporary construction; bike paths and individual locations less than 3 ft (1 m) wide or 1000 ft (300 m) long, will be evaluated according to Article 407.10(b) except, the width of a unit shall be the width of the widening along one edge of the pavement and the length of a unit shall be 1000 ft (300 m). Temporary locations are defined as those constructed and removed under the same contract. If the base course widening cannot be cored for thickness prior to placement of the cover layer(s), the Engineer will determine the thickness of the cover layer(s) and subtract them from the measured core thickness to determine the base course widening thickness.”

Revise Article 407.10 of the Standard Specifications to read:

“407.10 Tolerance in Thickness. Determination of pavement thickness shall be performed after the pavement surface tests and corrective action have been completed according to Article 407.09. Pay adjustments made for pavement thickness will be in addition to and independent of those made for pavement smoothness. Pavement pay items that individually contain at least 1000 sq yd (840 sq m) of contiguous pavement shall be evaluated with the following exclusions: temporary pavements; variable width pavements; radius returns; short lengths of contiguous pavements less than 500 ft (125 m) in length; and constant width portions of turn lanes less than 500 ft (125 m) in length. Temporary pavements are defined as pavements constructed and removed under the same contract.

The method described in Article 407.10(a), shall be used except for those pavements constructed in areas where access to side streets and entrances necessitates construction in segments less than 1000 ft (300 m). The method described in Article 407.10(b) shall be used in areas where access to side streets and entrances necessitates construction in segments less than 1000 ft (300 m).

(a) Percent Within Limits. The percent within limits (PWL) method shall be as follows.

- (1) Lots and Sublots. The pavement will be divided into approximately equal lots of not more than 5000 ft (1500 m) in length. When the length of a continuous strip of pavement is 500 ft (150 m) or greater but less than 5000 ft (1500 m), these short lengths of pavement, ramps, turn lanes, and other short sections of continuous pavement will be grouped together to form lots approximately 5000 ft (1500 m) in length. Short segments between structures will be measured continuously with the structure segments omitted. Each lot will be subdivided into ten equal sublots. The width of a subplot and lot will be the width from the pavement edge to the adjacent lane line, from one lane line to the next, or between pavement edges for single-lane pavements.
- (2) Cores. Cores 2 in. (50 mm) in diameter shall be taken from the pavement by the Contractor, at locations selected by the Engineer. The exact location for each core will be selected at random, but will result in one core per subplot. Core locations will be specified prior to beginning the coring operations.

The Contractor and the Engineer shall witness the coring operations, as well as the measuring and recording of the core lengths. The cores will be measured with a device supplied by the Department immediately upon removal from the core bit and prior to moving to the next core location. Upon concurrence of the length, the core samples shall be disposed of according to Article 202.03.

Upon completion of each core, all water shall be removed from the hole and the hole then filled with a rapid hardening mortar or concrete. The material shall be mixed in a separate container, placed in the hole, consolidated by rodding, and struck-off flush with the adjacent pavement.

- (3) Deficient Sublot. When the length of the core in a subplot is deficient by more than ten percent of plan thickness, the Contractor may take three additional cores within that subplot at locations selected at random by the Engineer. If the Contractor chooses not to take additional cores, the pavement in that subplot shall be removed and replaced.

When the three additional cores are taken, the length of those cores will be averaged with the original core length. If the average shows the subplot to be deficient by ten percent or less, no additional action is necessary. If the average shows the subplot to be deficient by more than ten percent, the pavement in that subplot shall be removed and replaced; however, when requested in writing by the Contractor, the Engineer may permit in writing such deficient sublots to remain in place. For deficient sublots allowed to remain in place, additional lift(s) may be placed, at no additional cost to the Department, to bring the deficient pavement to plan thickness when the Engineer determines grade control conditions will permit such lift(s).

The area(s) to be overlaid, material to be used, thickness(es) of the lift(s), and method of placement will be approved by the Engineer.

When a deficient subplot is removed and replaced, or additional lifts are placed, the corrected subplot shall be retested for thickness. The length of the new core taken in the subplot will be used in determining the PWL for the lot.

When a deficient subplot is left in place, and no additional lift(s) are placed, no payment will be made for the deficient subplot. The length of the original core taken in the subplot will be used in determining the PWL for the lot.

- (4) Deficient Lot. After addressing deficient sublots, the PWL for each lot will be determined. When the PWL of a lot is 60 percent or less, the pavement in that lot shall be removed and replaced; however, when requested in writing by the Contractor, the Engineer may permit in writing such deficient lots to remain in place. For deficient lots allowed to remain in place, additional lift(s) may be placed, at no additional cost to the Department, to bring the deficient pavement to plan thickness when the Engineer determines grade control conditions will permit such lift(s). The area(s) to be overlaid, material to be used, thickness(es) of the lift(s), and method of placement will be approved by the Engineer.

When a deficient lot is removed and replaced, or additional lifts are placed, the corrected lot shall be retested for thickness. The PWL for the lot will then be recalculated based upon the new cores; however, the pay factor for the lot shall be a maximum of 100 percent.

When a deficient lot is left in place, and no additional lift(s) are placed, the PWL for the lot will not be recalculated.

- (5) Right of Discovery. When the Engineer has reason to believe the random core selection process will not accurately represent the true conditions of the work, he/she may order additional cores. The additional cores shall be taken at specific locations determined by the Engineer. The Engineer will provide notice to the Contractor containing an explanation of the reasons for his/her action. The need for, and location of, additional cores will be determined prior to commencement of coring operations.

When the additional cores show the pavement to be deficient by more than ten percent of plan thickness, more additional cores shall be taken to determine the limits of the deficient pavement and that area shall be removed and replaced; however, when requested in writing by the Contractor, the Engineer may permit in writing such areas of deficient pavement to remain in place. The area of deficient pavement will be defined using the length between two acceptable cores and the full width of the subplot. An acceptable core is a core with a length of at least 90 percent of plan thickness.

For deficient areas allowed to remain in place, additional lift(s) may be placed, at no additional cost to the Department, to bring the deficient pavement to plan thickness when the Engineer determines grade control conditions will permit such lift(s). The area(s) to be overlaid, material to be used, thickness(es) of the lift(s), and method of placement will be approved by the Engineer.

When an area of deficient pavement is removed and replaced, or additional lifts are placed, the corrected pavement shall be retested for thickness.

When an area of deficient pavement is left in place, and no additional lift(s) are placed, no payment will be made for the deficient pavement.

When the additional cores show the pavement to be at least 90 percent of plan thickness, the additional cores will be paid for according to Article 109.04.

(6) Profile Index Adjustment. After any area of pavement is removed and replaced or any additional lifts are placed, the corrected areas shall be retested for pavement smoothness and any necessary profile index adjustments and/or corrections will be made based on these final profile readings prior to retesting for thickness.

(7) Determination of PWL. The PWL for each lot will be determined as follows.

Definitions:

- x_i = Individual values (core lengths) under consideration
- n = Number of individual values under consideration (10 per lot)
- \bar{x} = Average of the values under consideration
- LSL = Lower Specification Limit (98% of plan thickness)
- Q_L = Lower Quality Index
- s = Sample Standard Deviation
- PWL = Percent Within Limits

Determine \bar{x} for the lot to the nearest two decimal places.

Determine s for the lot to the nearest three decimal places using:

$$s = \sqrt{\frac{\sum(x_i - \bar{x})^2}{n - 1}} \quad \text{where} \quad \sum(x_i - \bar{x})^2 = (x_1 - \bar{x})^2 + (x_2 - \bar{x})^2 + \dots + (x_{10} - \bar{x})^2$$

Determine Q_L for the lot to the nearest two decimal places using:

$$Q_L = \frac{(\bar{x} - LSL)}{s}$$

Determine PWL for the lot using the Q_L and the following table. For Q_L values less than zero the value shown in the table must be subtracted from 100 to obtain PWL.

(8) Pay Factors. The pay factor (PF) for each lot will be determined, to the nearest two decimal places, using:

$$PF \text{ (in percent)} = 55 + 0.5 (PWL)$$

If \bar{x} for a lot is less than the plan thickness, the maximum PF for that lot shall be 100 percent.

- (9) Payment. Payment of incentive or disincentive for pay items subject to the PWL method will be calculated using:

$$\text{Payment} = (((\text{TPF}/100)-1) \times \text{CUP}) \times (\text{TOTPAVT} - \text{DEFP AVT})$$

TPF = Total Pay Factor

CUP = Contract Unit Price

TOTPAVT = Area of Pavement Subject to Coring

DEFP AVT = Area of Deficient Pavement

The TPF for the pavement shall be the average of the PF for all the lots; however, the TPF shall not exceed 102 percent.

Area of Deficient pavement (DEFP AVT) is defined as an area of pavement represented by a subplot deficient by more than ten percent which is left in place with no additional thickness added.

Area of Pavement Subject to Coring (TOTPAVT) is defined as those pavement areas included in lots for pavement thickness determination.

PERCENT WITHIN LIMITS							
Quality Index (Q _L)*	Percent Within Limits (PWL)	Quality Index (Q _L)*	Percent Within Limits (PWL)	Quality Index (Q _L)*	Percent Within Limits (PWL)	Quality Index (Q _L)*	Percent Within Limits (PWL)
0.00	50.00	0.40	65.07	0.80	78.43	1.20	88.76
0.01	50.38	0.41	65.43	0.81	78.72	1.21	88.97
0.02	50.77	0.42	65.79	0.82	79.02	1.22	89.17
0.03	51.15	0.43	66.15	0.83	79.31	1.23	89.38
0.04	51.54	0.44	66.51	0.84	79.61	1.24	89.58
0.05	51.92	0.45	66.87	0.85	79.90	1.25	89.79
0.06	52.30	0.46	67.22	0.86	80.19	1.26	89.99
0.07	52.69	0.47	67.57	0.87	80.47	1.27	90.19
0.08	53.07	0.48	67.93	0.88	80.76	1.28	90.38
0.09	53.46	0.49	68.28	0.89	81.04	1.29	90.58
0.10	53.84	0.50	68.63	0.90	81.33	1.30	90.78
0.11	54.22	0.51	68.98	0.91	81.61	1.31	90.96
0.12	54.60	0.52	69.32	0.92	81.88	1.32	91.15
0.13	54.99	0.53	69.67	0.93	82.16	1.33	91.33
0.14	55.37	0.54	70.01	0.94	82.43	1.34	91.52
0.15	55.75	0.55	70.36	0.95	82.71	1.35	91.70
0.16	56.13	0.56	70.70	0.96	82.97	1.36	91.87
0.17	56.51	0.57	71.04	0.97	83.24	1.37	92.04
0.18	56.89	0.58	71.38	0.98	83.50	1.38	92.22
0.19	57.27	0.59	71.72	0.99	83.77	1.39	92.39
0.20	57.65	0.60	72.06	1.00	84.03	1.40	92.56
0.21	58.03	0.61	72.39	1.01	84.28	1.41	92.72
0.22	58.40	0.62	72.72	1.02	84.53	1.42	92.88
0.23	58.78	0.63	73.06	1.03	84.79	1.43	93.05
0.24	59.15	0.64	73.39	1.04	85.04	1.44	93.21
0.25	59.53	0.65	73.72	1.05	85.29	1.45	93.37
0.26	59.90	0.66	74.04	1.06	85.53	1.46	93.52
0.27	60.28	0.67	74.36	1.07	85.77	1.47	93.67
0.28	60.65	0.68	74.69	1.08	86.02	1.48	93.83
0.29	61.03	0.69	75.01	1.09	86.26	1.49	93.98
0.30	61.40	0.70	75.33	1.10	86.50	1.50	94.13
0.31	61.77	0.71	75.64	1.11	86.73	1.51	94.27
0.32	62.14	0.72	75.96	1.12	86.96	1.52	94.41
0.33	62.51	0.73	76.27	1.13	87.20	1.53	94.54
0.34	62.88	0.74	76.59	1.14	87.43	1.54	94.68
0.35	63.25	0.75	76.90	1.15	87.66	1.55	94.82
0.36	63.61	0.76	77.21	1.16	87.88	1.56	94.95
0.37	63.98	0.77	77.51	1.17	88.10	1.57	95.08
0.38	64.34	0.78	77.82	1.18	88.32	1.58	95.20
0.39	64.71	0.79	78.12	1.19	88.54	1.59	95.33

*For Q_L values less than zero, subtract the table value from 100 to obtain PWL

PERCENT WITHIN LIMITS (continued)					
Quality Index (Q _L)*	Percent Within Limits (PWL)	Quality Index (Q _L)*	Percent Within Limits (PWL)	Quality Index (Q _L)*	Percent Within Limits (PWL)
1.60	95.46	2.00	98.83	2.40	99.89
1.61	95.58	2.01	98.88	2.41	99.90
1.62	95.70	2.02	98.92	2.42	99.91
1.63	95.81	2.03	98.97	2.43	99.91
1.64	95.93	2.04	99.01	2.44	99.92
1.65	96.05	2.05	99.06	2.45	99.93
1.66	96.16	2.06	99.10	2.46	99.94
1.67	96.27	2.07	99.14	2.47	99.94
1.68	96.37	2.08	99.18	2.48	99.95
1.69	96.48	2.09	99.22	2.49	99.95
1.70	96.59	2.10	99.26	2.50	99.96
1.71	96.69	2.11	99.29	2.51	99.96
1.72	96.78	2.12	99.32	2.52	99.97
1.73	96.88	2.13	99.36	2.53	99.97
1.74	96.97	2.14	99.39	2.54	99.98
1.75	97.07	2.15	99.42	2.55	99.98
1.76	97.16	2.16	99.45	2.56	99.98
1.77	97.25	2.17	99.48	2.57	99.98
1.78	97.33	2.18	99.50	2.58	99.99
1.79	97.42	2.19	99.53	2.59	99.99
1.80	97.51	2.20	99.56	2.60	99.99
1.81	97.59	2.21	99.58	2.61	99.99
1.82	97.67	2.22	99.61	2.62	99.99
1.83	97.75	2.23	99.63	2.63	100.00
1.84	97.83	2.22	99.66	2.64	100.00
1.85	97.91	2.25	99.68	≥ 2.65	100.00
1.86	97.98	2.26	99.70		
1.87	98.05	2.27	99.72		
1.88	98.11	2.28	99.73		
1.89	98.18	2.29	99.75		
1.90	98.25	2.30	99.77		
1.91	98.31	2.31	99.78		
1.92	98.37	2.32	99.80		
1.93	98.44	2.33	99.81		
1.94	98.50	2.34	99.83		
1.95	98.56	2.35	99.84		
1.96	98.61	2.36	99.85		
1.97	98.67	2.37	99.86		
1.98	98.72	2.38	99.87		
1.99	98.78	2.39	99.88		

*For Q_L values less than zero, subtract the table value from 100 to obtain PWL

(b) Minimum Thickness. The minimum thickness method shall be as follows.

- (1) Length of Units. The length of a unit will be a continuous strip of pavement 500 ft (150 m) in length.
- (2) Width of Units. The width of a unit will be the width from the pavement edge to the adjacent lane line, from one lane line to the next, or between pavement edges for single-lane pavements.
- (3) Thickness Measurements. Pavement thickness will be based on 2 in. (50 mm) diameter cores.

Cores shall be taken from the pavement by the Contractor at locations selected by the Engineer. When determining the thickness of a unit, one core shall be taken in each unit.

The Contractor and the Engineer shall witness the coring operations, as well as the measuring and recording of the cores. Core measurements will be determined immediately upon removal from the core bit and prior to moving to the next core location. Upon concurrence of the length, the core samples may be disposed of according to Article 202.03.

Upon completion of each core, all water shall be removed from the hole and the hole then filled with a rapid hardening mortar or concrete. The material shall be mixed in a separate container, placed in the hole, consolidated by rodding, and struck-off flush with the adjacent pavement.

- (4) Unit Deficient in Thickness. In considering any portion of the pavement that is deficient, the entire limits of the unit will be used in computing the deficiency or determining the remedial action required.
- (5) Thickness Equals or Exceeds Specified Thickness. When the thickness of a unit equals or exceeds the specified plan thickness, payment will be made at the contract unit price per square yard (square meter) for the specified thickness.
- (6) Thickness Deficient by Ten Percent or Less. When the thickness of a unit is less than the specified plan thickness by ten percent or less, a deficiency deduction will be assessed against payment for the item involved. The deficiency will be a percentage of the contract unit price as given in the following table.

Percent Deficiency (of Plan Thickness)	Percent Deduction (of Contract Unit Price)
0.0 to 2.0	0
2.1 to 3.0	20
3.1 to 4.0	28
4.1 to 5.0	32
5.1 to 7.5	43
7.6 to 10.0	50

- (7) Thickness Deficient by More than Ten Percent. When a core shows the pavement to be deficient by more than ten percent of plan thickness, additional cores shall be taken on each side of the deficient core, at stations selected by the Contractor and offsets selected by the Engineer, to determine the limits of the deficient pavement. No core shall be located within 5 ft (1.5 m) of a previous core obtained for thickness determination. The first acceptable core obtained on each side of a deficient core will be used to determine the length of the deficient pavement. An acceptable core is a core with a thickness of at least 90 percent of plan thickness. The area of deficient pavement will be defined using the length between two acceptable cores and the full width of the unit. The area of deficient pavement shall be removed and replaced; however, when requested in writing by the Contractor, the Engineer may permit in writing such areas of deficient pavement to remain in place. For deficient areas allowed to remain in place, additional lift(s) may be placed, at no additional cost to the Department, to bring the deficient pavement to plan thickness when the Engineer determines grade control conditions will permit such lift(s). The area(s) to be overlaid, material to be used, thickness(es) of the lift(s), and method of placement will be approved by the Engineer.

When an area of deficient pavement is removed and replaced, or additional lifts are placed, the corrected pavement shall be retested for thickness. The thickness of the new core will be used to determine the pay factor for the corrected area.

When an area of deficient pavement is left in place, and no additional lift(s) are placed, no payment will be made for the deficient pavement. In addition, an amount equal to two times the contract cost of the deficient pavement will be deducted from the compensation due the Contractor.

The thickness of the first acceptable core on each side of the core more than ten percent deficient will be used to determine any needed pay adjustments for the remaining areas on each side of the area deficient by more than ten percent. The pay adjustment will be determined according to Article 407.10(b)(6).

- (8) Right of Discovery. When the Engineer has reason to believe any core location does not accurately represent the true conditions of the work, he/she may order additional cores. These additional cores shall be taken at specific locations determined by the Engineer. The Engineer will provide notice to the Contractor containing an explanation of the reasons for his/her action.

When the additional cores show the pavement to be deficient by more than ten percent of plan thickness, the procedures outlined in Article 407.10(b)(7) shall be followed, except the Engineer will determine the additional core locations.

When the additional cores, ordered by the Engineer, show the pavement to be at least 90 percent of plan thickness, the additional cores will be paid for according to Article 109.04.

- (9) Profile Index Adjustment. After any area of pavement is removed and replaced or any additional lifts are added, the corrected areas shall be retested for pavement smoothness and any necessary profile index adjustments and/or corrections will be made based on these final profile readings prior to retesting for thickness.”

Revise Article 482.06 of the Standard Specifications to read:

“482.06 Tolerance in Thickness. The shoulder shall be constructed to the thickness shown on the plans. When the contract includes square yards (square meters) as the unit of measurement for HMA shoulder, thickness determinations shall be made according to Article 407.10(b)(3) and the following.

- (a) Length of the Units. The length of a unit shall be a continuous strip of shoulder 2500 ft (750 m) long.
- (b) Width of the Units. The width of the unit shall be the full width of the shoulder.
- (c) Thickness Deficient by More than Ten Percent. When a core shows the shoulder to be deficient by more than ten percent of plan thickness, additional cores shall be taken on each side of the deficient core, at stations selected by the Contractor and offsets selected by the Engineer, to determine the limits of the deficient shoulder. No core shall be located within 5 ft (1.5 m) of a previous core obtained for thickness determination. The first acceptable core obtained on each side of a deficient core will be used to determine the length of the deficient shoulder. An acceptable core is a core with a thickness of at least 90 percent of plan thickness. The area of deficient shoulder will be defined using the length between two acceptable cores and the full width of the unit. The area of deficient shoulder shall be brought to specified thickness by the addition of the applicable mixture, at no additional cost to the Department and subject to the lift thickness requirements of Article 312.05, or by removal and replacement with a new mixture. However, the surface elevation of the completed shoulder shall not exceed by more than 1/8 in. (3 mm) the surface elevation of the adjacent pavement. When requested in writing by the Contractor, the Engineer may permit in writing such thin shoulder to remain in place. When an area of thin shoulder is left in place, and no additional lift(s) are placed, no payment will be made for the thin shoulder. In addition, an amount equal to two times the contract unit price of the shoulder will be deducted from the compensation due the Contractor.

When an area of deficient shoulder is removed and replaced, or additional lifts are placed, the corrected pavement shall be retested for thickness.

- (d) Right of Discovery. When the Engineer has reason to believe any core location does not accurately represent the true conditions of the work, he/she may order additional cores. When the additional cores, ordered by the Engineer, show the shoulder to be at least 90 percent of plan thickness, the additional cores will be paid for according to Article 109.04. When the additional core shows the shoulder to be less than 90 percent of plan thickness, the procedure in (c), above shall be followed.”

Revise Article 483.07 of the Standard Specifications to read:

“483.07 Tolerance in Thickness. The shoulder shall be constructed to the thickness shown on the plans. Thickness determinations shall be made according to Article 482.06 except the option of correcting deficient pavement with additional lift(s) shall not apply.”

DISADVANTAGED BUSINESS ENTERPRISE PARTICIPATION (BDE)

Effective: September 1, 2000

Revised: January 1, 2010

FEDERAL OBLIGATION. The Department of Transportation, as a recipient of federal financial assistance, is required to take all necessary and reasonable steps to ensure nondiscrimination in the award and administration of contracts. Consequently, the federal regulatory provisions of 49 CFR part 26 apply to this contract concerning the utilization of disadvantaged business enterprises. For the purposes of this Special Provision, a disadvantaged business enterprise (DBE) means a business certified by the Department in accordance with the requirements of 49 CFR part 26 and listed in the Illinois Unified Certification Program (IL UCP) DBE Directory.

STATE OBLIGATION. This Special Provision will also be used by the Department to satisfy the requirements of the Business Enterprise for Minorities, Females, and Persons with Disabilities Act, 30 ILCS 575. When this Special Provision is used to satisfy state law requirements on 100 percent state-funded contracts, the federal government has no involvement in such contracts (not a federal-aid contract) and no responsibility to oversee the implementation of this Special Provision by the Department on those contracts. DBE participation on 100 percent state-funded contracts will not be credited toward fulfilling the Department's annual overall DBE goal required by the US Department of Transportation to comply with the federal DBE program requirements.

CONTRACTOR ASSURANCE. The Contractor makes the following assurance and agrees to include the assurance in each subcontract that the Contractor signs with a subcontractor:

The Contractor, subrecipient, or subcontractor shall not discriminate on the basis of race, color, national origin, or sex in the performance of this contract. The Contractor shall carry out applicable requirements of 49 CFR part 26 in the award and administration of contracts funded in whole or in part with federal or state funds. Failure by the Contractor to carry out these requirements is a material breach of this contract, which may result in the termination of this contract or such other remedy as the recipient deems appropriate.

OVERALL GOAL SET FOR THE DEPARTMENT. As a requirement of compliance with 49 CFR part 26, the Department has set an overall goal for DBE participation in its federally assisted contracts. That goal applies to all federal-aid funds the Department will expend in its federally assisted contracts for the subject reporting fiscal year. The Department is required to make a good faith effort to achieve the overall goal. The dollar amount paid to all approved DBE companies performing work called for in this contract is eligible to be credited toward fulfillment of the Department's overall goal.

CONTRACT GOAL TO BE ACHIEVED BY THE CONTRACTOR. This contract includes a specific DBE utilization goal established by the Department. The goal has been included because the Department has determined that the work of this contract has subcontracting opportunities that may be suitable for performance by DBE companies. This determination is based on an assessment of the type of work, the location of the work, and the availability of DBE companies to do a part of the work. The assessment indicates that, in the absence of unlawful discrimination, and in an arena of fair and open competition, DBE companies can be expected to perform 1.0% of the work. This percentage is set as the DBE participation goal for this contract. Consequently, in addition to the other award criteria established for this contract, the Department will only award this contract to a bidder who makes a good faith effort to meet this goal of DBE participation in the performance of the work.

A bidder makes a good faith effort for award consideration if either of the following is done in accordance with the procedures set forth in this Special Provision:

- (a) The bidder documents that enough DBE participation has been obtained to meet the goal; or
- (b) The bidder documents that a good faith effort has been made to meet the goal, even though the effort did not succeed in obtaining enough DBE participation to meet the goal.

DBE LOCATOR REFERENCES. Bidders may consult the IL UCP DBE Directory as a reference source for DBE-certified companies. In addition, the Department maintains a letting and item specific DBE locator information system whereby DBE companies can register their interest in providing quotes on particular bid items advertised for letting. Information concerning DBE companies willing to quote work for particular contracts may be obtained by contacting the Department's Bureau of Small Business Enterprises at telephone number (217)785-4611, or by visiting the Department's web site at www.dot.il.gov.

BIDDING PROCEDURES. Compliance with this Special Provision is a material bidding requirement. The failure of the bidder to comply will render the bid not responsive.

(a) The bidder shall submit a Disadvantaged Business Utilization Plan on Department forms SBE 2025 and 2026 with the bid.

(b) The Utilization Plan shall indicate that the bidder either has obtained sufficient DBE participation commitments to meet the contract goal or has not obtained enough DBE participation commitments in spite of a good faith effort to meet the goal. The Utilization Plan shall further provide the name, telephone number, and telefax number of a responsible official of the bidder designated for purposes of notification of plan approval or disapproval under the procedures of this Special Provision.

(c) The Utilization Plan shall include a DBE Participation Commitment Statement, Department form SBE 2025, for each DBE proposed for the performance of work to achieve the contract goal. For bidding purposes, submission of the completed SBE 2025 forms, signed by the DBEs and faxed to the bidder will be acceptable as long as the original is available and provided upon request. All elements of information indicated on the said form shall be provided, including but not limited to the following:

- (1) The names and addresses of DBE firms that will participate in the contract;
- (2) A description, including pay item numbers, of the work each DBE will perform;
- (3) The dollar amount of the participation of each DBE firm participating. The dollar amount of participation for identified work shall specifically state the quantity, unit price, and total subcontract price for the work to be completed by the DBE. If partial pay items are to be performed by the DBE, indicate the portion of each item, a unit price where appropriate and the subcontract price amount;
- (4) DBE Participation Commitment Statements, form SBE 2025, signed by the bidder and each participating DBE firm documenting the commitment to use the DBE subcontractors whose participation is submitted to meet the contract goal;

(5) If the bidder is a joint venture comprised of DBE companies and non-DBE companies, the plan must also include a clear identification of the portion of the work to be performed by the DBE partner(s); and,

(6) If the contract goal is not met, evidence of good faith efforts.

GOOD FAITH EFFORT PROCEDURES. The contract will not be awarded until the Utilization Plan submitted by the apparent successful bidder is approved. All information submitted by the bidder must be complete, accurate and adequately document the good faith efforts of the bidder before the Department will commit to the performance of the contract by the bidder. The Utilization Plan will be approved by the Department if the Utilization Plan commits sufficient commercially useful DBE work performance to meet the contract goal or the bidder submits sufficient documentation of a good faith effort to meet the contract goal pursuant to 49 CFR part 26, Appendix A. The Utilization Plan will not be approved by the Department if the Utilization Plan does not commit sufficient DBE participation to meet the contract goal unless the apparent successful bidder documented in the Utilization Plan that it made a good faith effort to meet the goal. This means that the bidder must show that all necessary and reasonable steps were taken to achieve the contract goal. Necessary and reasonable steps are those which, by their scope, intensity and appropriateness to the objective, could reasonably be expected to obtain sufficient DBE participation, even if they were not successful. The Department will consider the quality, quantity, and intensity of the kinds of efforts that the bidder has made. Mere *pro forma* efforts, in other words, efforts done as a matter of form, are not good faith efforts; rather, the bidder is expected to have taken genuine efforts that would be reasonably expected of a bidder actively and aggressively trying to obtain DBE participation sufficient to meet the contract goal.

(a) The following is a list of types of action that the Department will consider as part of the evaluation of the bidder's good faith efforts to obtain participation. These listed factors are not intended to be a mandatory checklist and are not intended to be exhaustive. Other factors or efforts brought to the attention of the Department may be relevant in appropriate cases, and will be considered by the Department.

(1) Soliciting through all reasonable and available means (e.g. attendance at pre-bid meetings, advertising and/or written notices) the interest of all certified DBE companies that have the capability to perform the work of the contract. The bidder must solicit this interest within sufficient time to allow the DBE companies to respond to the solicitation. The bidder must determine with certainty if the DBE companies are interested by taking appropriate steps to follow up initial solicitations.

(2) Selecting portions of the work to be performed by DBE companies in order to increase the likelihood that the DBE goals will be achieved. This includes, where appropriate, breaking out contract work items into economically feasible units to facilitate DBE participation, even when the prime Contractor might otherwise prefer to perform these work items with its own forces.

(3) Providing interested DBE companies with adequate information about the plans, specifications, and requirements of the contract in a timely manner to assist them in responding to a solicitation.

(4) a. Negotiating in good faith with interested DBE companies. It is the bidder's responsibility to make a portion of the work available to DBE subcontractors and suppliers and to select those portions of the work or material needs consistent with the available DBE subcontractors and suppliers, so as to facilitate DBE participation. Evidence of such negotiation includes the names, addresses, and telephone numbers of DBE companies that were considered; a description of the information provided regarding the plans and specifications for the work selected for subcontracting; and evidence as to why additional agreements could not be reached for DBE companies to perform the work.

b. A bidder using good business judgment would consider a number of factors in negotiating with subcontractors, including DBE subcontractors, and would take a firm's price and capabilities as well as contract goals into consideration. However, the fact that there may be some additional costs involved in finding and using DBE companies is not in itself sufficient reason for a bidder's failure to meet the contract DBE goal, as long as such costs are reasonable. Also, the ability or desire of a bidder to perform the work of a contract with its own organization does not relieve the bidder of the responsibility to make good faith efforts. Bidders are not, however, required to accept higher quotes from DBE companies if the price difference is excessive or unreasonable.

(5) Not rejecting DBE companies as being unqualified without sound reasons based on a thorough investigation of their capabilities. The bidder's standing within its industry, membership in specific groups, organizations, or associations and political or social affiliations (for example union vs. non-union employee status) are not legitimate causes for the rejection or non-solicitation of bids in the bidder's efforts to meet the project goal.

(6) Making efforts to assist interested DBE companies in obtaining bonding, lines of credit, or insurance as required by the recipient or Contractor.

(7) Making efforts to assist interested DBE companies in obtaining necessary equipment, supplies, materials, or related assistance or services.

(8) Effectively using the services of available minority/women community organizations; minority/women contractors' groups; local, state, and federal minority/women business assistance offices; and other organizations as allowed on a case-by-case basis to provide assistance in the recruitment and placement of DBE companies.

(b) If the Department determines that the apparent successful bidder has made a good faith effort to secure the work commitment of DBE companies to meet the contract goal, the Department will award the contract provided that it is otherwise eligible for award. If the Department determines that the bidder has failed to meet the requirements of this Special Provision and that a good faith effort has not been made, the Department will notify the responsible company official designated in the Utilization Plan that the bid is not responsive. The notification shall include a statement of reasons why good faith efforts have not been found.

(c) The bidder may request administrative reconsideration of a determination adverse to the bidder within the five working days after receipt of the notification date of the determination by delivering the request to the Department of Transportation, Bureau of Small Business Enterprises, Contract Compliance Section, 2300 South Dirksen Parkway, Room 319, Springfield, Illinois 62764 (Telefax: (217)785-1524). Deposit of the request in the United States mail on or before the fifth business day shall not be deemed delivery. The determination shall become final if a request is not made and delivered. A request may provide additional written documentation and/or argument concerning the issue of whether an adequate good faith effort was made to meet the contract goal. The request will be forwarded to the Department's Reconsideration Officer. The Reconsideration Officer will extend an opportunity to the bidder to meet in person in order to consider all issues of whether the bidder made a good faith effort to meet the goal. After the review by the Reconsideration Officer, the bidder will be sent a written decision within ten working days after receipt of the request for reconsideration, explaining the basis for finding that the bidder did or did not meet the goal or make adequate good faith efforts to do so. A final decision by the Reconsideration Officer that a good faith effort was made shall approve the Utilization Plan submitted by the bidder and shall clear the contract for award. A final decision that a good faith effort was not made shall render the bid not responsive.

CALCULATING DBE PARTICIPATION. The Utilization Plan values represent work anticipated to be performed and paid for upon satisfactory completion. The Department is only able to count toward the achievement of the overall goal and the contract goal the value of payments made for the work actually performed by DBE companies. In addition, a DBE must perform a commercially useful function on the contract to be counted. A commercially useful function is generally performed when the DBE is responsible for the work and is carrying out its responsibilities by actually performing, managing, and supervising the work involved. The Department and Contractor are governed by the provisions of 49 CFR part 26.55(c) on questions of commercially useful functions as it affects the work. Specific counting guidelines are provided in 49 CFR part 26.55, the provisions of which govern over the summary contained herein.

(a) DBE as the Contractor: 100 percent goal credit for that portion of the work performed by the DBE's own forces, including the cost of materials and supplies. Work that a DBE subcontracts to a non-DBE does not count toward the DBE goals.

(b) DBE as a joint venture Contractor: 100 percent goal credit for that portion of the total dollar value of the contract equal to the distinct, clearly defined portion of the work performed by the DBE's own forces.

(c) DBE as a subcontractor: 100 percent goal credit for the work of the subcontract performed by the DBE's own forces, including the cost of materials and supplies, excluding the purchase of materials and supplies or the lease of equipment by the DBE subcontractor from the prime Contractor or its affiliates. Work that a DBE subcontractor in turn subcontracts to a non-DBE does not count toward the DBE goal.

(d) DBE as a trucker: 100 percent goal credit for trucking participation provided the DBE is responsible for the management and supervision of the entire trucking operation for which it is responsible. At least one truck owned, operated, licensed, and insured by the DBE must be used on the contract. Credit will be given for the following:

- (1) The DBE may lease trucks from another DBE firm, including an owner-operator who is certified as a DBE. The DBE who leases trucks from another DBE receives credit for the total value of the transportation services the lessee DBE provides on the contract.
- (2) The DBE may also lease trucks from a non-DBE firm, including from an owner-operator. The DBE who leases trucks from a non-DBE is entitled to credit only for the fee or commission it receives as a result of the lease arrangement.
- (e) DBE as a material supplier:
 - (1) 60 percent goal credit for the cost of the materials or supplies purchased from a DBE regular dealer.
 - (2) 100 percent goal credit for the cost of materials or supplies obtained from a DBE manufacturer.
 - (3) 100 percent credit for the value of reasonable fees and commissions for the procurement of materials and supplies if not a regular dealer or manufacturer.

CONTRACT COMPLIANCE. Compliance with this Special Provision is an essential part of the contract. The Department is prohibited by federal regulations from crediting the participation of a DBE included in the Utilization Plan toward either the contract goal or the Department's overall goal until the amount to be applied toward the goals has been paid to the DBE. The following administrative procedures and remedies govern the compliance by the Contractor with the contractual obligations established by the Utilization Plan. After approval of the Utilization Plan and award of the contract, the Utilization Plan and individual DBE Participation Statements become part of the contract. If the Contractor did not succeed in obtaining enough DBE participation to achieve the advertised contract goal, and the Utilization Plan was approved and contract awarded based upon a determination of good faith, the total dollar value of DBE work calculated in the approved Utilization Plan as a percentage of the awarded contract value shall become the amended contract goal.

(a) No amendment to the Utilization Plan may be made without prior written approval from the Department's Bureau of Small Business Enterprises. All requests for amendment to the Utilization Plan shall be submitted to the Department of Transportation, Bureau of Small Business Enterprises, Contract Compliance Section, 2300 South Dirksen Parkway, Room 319, Springfield, Illinois 62764. Telephone number (217) 785-4611. Telefax number (217) 785-1524.

(b) The Contractor must notify and obtain written approval from the Department's Bureau of Small Business Enterprises prior to replacing a DBE or making any change in the participation of a DBE. Approval for replacement will be granted only if it is demonstrated that the DBE is unable or unwilling to perform. The Contractor must make every good faith effort to find another certified DBE subcontractor to substitute for the original DBE. The good faith efforts shall be directed at finding another DBE to perform at least the same amount of work under the contract as the original DBE, to the extent needed to meet the contract goal.

(c) Any deviation from the DBE condition-of-award or contract specifications must be approved, in writing, by the Department. The Contractor shall notify affected DBEs in writing of any changes in the scope of work which result in a reduction in the dollar amount condition-of-award to the contract.

(d) In addition to the above requirements for reductions in the condition of award, additional requirements apply to the two cases of Contractor-initiated work substitution proposals. Where the contract allows alternate work methods which serve to delete or create underruns in condition of award DBE work, and the Contractor selects that alternate method or, where the Contractor proposes a substitute work method or material that serves to diminish or delete work committed to a DBE and replace it with other work, then the Contractor must demonstrate one of the following:

- (1) That the replacement work will be performed by the same DBE (as long as the DBE is certified in the respective item of work) in a modification of the condition of award; or
- (2) That the DBE is aware that its work will be deleted or will experience underruns and has agreed in writing to the change. If this occurs, the Contractor shall substitute other work of equivalent value to a certified DBE or provide documentation of good faith efforts to do so; or
- (3) That the DBE is not capable of performing the replacement work or has declined to perform the work at a reasonably competitive price. If this occurs, the Contractor shall substitute other work of equivalent value to a certified DBE or provide documentation of good faith efforts to do so.

(e) Where the revision includes work committed to a new DBE subcontractor, not previously involved in the project, then a Request for Approval of Subcontractor, Department form BC 260A, must be signed and submitted.

(f) If the commitment of work is in the form of additional tasks assigned to an existing subcontract, then a new Request for Approval of Subcontractor shall not be required. However, the Contractor must document efforts to assure that the existing DBE subcontractor is capable of performing the additional work and has agreed in writing to the change.

(g) All work indicated for performance by an approved DBE shall be performed, managed, and supervised by the DBE executing the Participation Statement. The Contractor shall not terminate for convenience a DBE listed in the Utilization Plan and then perform the work of the terminated DBE with its own forces, those of an affiliate or those of another subcontractor, whether DBE or not, without first obtaining the written consent of the Bureau of Small Business Enterprises to amend the Utilization Plan. The Contractor shall notify the Bureau of Small Business Enterprises of any termination for reasons other than convenience, and shall obtain approval for inclusion of the substitute DBE in the Utilization Plan. If good faith efforts following a termination of a DBE for cause are not successful, the Contractor shall contact the Bureau of Small Business Enterprises and provide a full accounting of the efforts undertaken to obtain substitute DBE participation. The Bureau of Small Business Enterprises will evaluate the good faith efforts in light of all circumstances surrounding the performance status of the contract, and determine whether the contract goal should be amended.

(h) The Contractor shall maintain a record of payments for work performed to the DBE participants. The records shall be made available to the Department for inspection upon request. After the performance of the final item of work or delivery of material by a DBE and final payment therefore to the DBE by the Contractor, but not later than thirty calendar days after payment has been made by the Department to the Contractor for such work or material, the Contractor shall submit a DBE Payment Agreement on Department form SBE 2115 to the Regional Engineer. If full and final payment has not been made to the DBE, the DBE Payment Agreement shall indicate whether a disagreement as to the payment required exists between the Contractor and the DBE or if the Contractor believes that the work has not been satisfactorily completed. If the Contractor does not have the full amount of work indicated in the Utilization Plan performed by the DBE companies indicated in the Utilization Plan and after good faith efforts are reviewed, the Department may deduct from contract payments to the Contractor the amount of the goal not achieved as liquidated and ascertained damages. The Contractor may request an administrative reconsideration of any amount deducted as damages pursuant to subsection (j) of this part.

(i) The Department reserves the right to withhold payment to the Contractor to enforce the provisions of this Special Provision. Final payment shall not be made on the contract until such time as the Contractor submits sufficient documentation demonstrating achievement of the goal in accordance with this Special Provision or after liquidated damages have been determined and collected.

(j) Notwithstanding any other provision of the contract, including but not limited to Article 109.09 of the Standard Specifications, the Contractor may request administrative reconsideration of a decision to deduct the amount of the goal not achieved as liquidated damages. A request to reconsider shall be delivered to the Contract Compliance Section and shall be handled and considered in the same manner as set forth in paragraph (c) of "Good Faith Effort Procedures" of this Special Provision, except a final decision that a good faith effort was not made during contract performance to achieve the goal agreed to in the Utilization Plan shall be the final administrative decision of the Department.

ENGINEER'S FIELD OFFICE TYPE A (BDE)

Effective: April 1, 2007

Revised: August 1, 2008

Revise Article 670.02 of the Standard Specifications to read:

"670.02 Engineer's Field Office Type A. Type A field offices shall have a minimum ceiling height of 7 ft (2 m) and a minimum floor space 450 sq ft (42 sq m). The office shall be provided with sufficient heat, natural and artificial light, and air conditioning.

The office shall have an electronic security system that will respond to any breach of exterior doors and windows. Doors and windows shall be equipped with locks. Doors shall also be equipped with dead bolt locks or other secondary locking device.

Windows shall be equipped with exterior screens to allow adequate ventilation. All windows shall be equipped with interior shades, curtains, or blinds. Adequate all-weather parking space shall be available to accommodate a minimum of ten vehicles.

Suitable on-site sanitary facilities meeting Federal, State, and local health department requirements shall be provided, maintained clean and in good working condition, and shall be stocked with lavatory and sanitary supplies at all times.

Sanitary facilities shall include hot and cold potable running water, lavatory and toilet as an integral part of the office where available. Solid waste disposal consisting of two waste baskets and an outside trash container of sufficient size to accommodate a weekly provided pick-up service.

In addition, the following furniture and equipment shall be furnished.

- (a) Four desks with minimum working surface 42 x 30 in. (1.1 m x 750 mm) each and five non-folding chairs with upholstered seats and backs.
- (b) One desk with minimum working surface 48 x 72 in. (1.2 x 1.8 m) with height adjustment of 23 to 30 in. (585 to 750 mm).
- (c) One four-post drafting table with minimum top size of 37 1/2 x 48 in. (950 mm x 1.2 m). The top shall be basswood or equivalent and capable of being tilted through an angle of 50 degrees. An adjustable height drafting stool with upholstered seat and back shall also be provided.
- (d) Two free standing four drawer legal size file cabinet with lock and an underwriters' laboratories insulated file device 350 degrees one hour rating.
- (e) One 6 ft (1.8 m) folding table with six folding chairs.
- (f) One equipment cabinet of minimum inside dimension of 44 in. (1100 mm) high x 24 in. (600 mm) wide x 30 in. (750 mm) deep with lock. The walls shall be of steel with a 3/32 in. (2 mm) minimum thickness with concealed hinges and enclosed lock constructed in such a manner as to prevent entry by force. The cabinet assembly shall be permanently attached to a structural element of the field office in a manner to prevent theft of the entire cabinet.
- (g) One refrigerator with a minimum size of 16 cu ft (0.45 cu m) with a freezer unit.
- (h) One electric desk type tape printing calculator.
- (i) A minimum of two communication paths. The configuration shall include:
 - (1) Internet Connection. An internet service connection using telephone DSL, cable broadband, or CDMA wireless technology. Additionally, an 802.11g/N wireless router shall be provided, which will allow connection by the Engineer and up to four Department staff.
 - (2) Telephone Lines. Three separate telephone lines.
- (j) One plain paper copy machine capable of reproducing prints up to 11 x 17 in. (280 x 432 mm) with an automatic feed tray capable of storing 30 sheets of paper. Letter size and 11 x 17 in. (280 x 432 mm) paper shall be provided.

- (k) One plain paper fax machine with paper.
- (l) Two telephones, with touch tone, where available, and a digital telephone answering machine, for exclusive use by the Engineer.
- (m) One electric water cooler dispenser.
- (n) One first-aid cabinet fully equipped.
- (o) One microwave oven, 1 cu ft (0.03 cu m) minimum capacity.
- (p) One fire-proof safe, 0.5 cu ft (0.01 cu m) minimum capacity.
- (q) One electric paper shredder.
- (r) One post mounted rain gauge, located on the project site for each 5 miles (8 km) of project length.”

Revise the first sentence of the first paragraph of Article 670.07 of the Standard Specifications to read:

“The building or buildings fully equipped as specified will be paid for on a monthly basis until the building or buildings are released by the Engineer.”

Revise the last sentence of the first paragraph of Article 670.07 of the Standard Specifications to read:

“This price shall include all utility costs and shall reflect the salvage value of the building or buildings, equipment, and furniture which become the property of the Contractor after release by the Engineer, except that the Department will pay that portion of the monthly long distance telephone bills that, when combined, exceed \$150.”

EQUIPMENT RENTAL RATES (BDE)

Effective: August 2, 2007

Revised: January 2, 2008

Replace the second and third paragraphs of Article 105.07(b)(4)a. of the Standard Specifications with the following:

“Equipment idled which cannot be used on other work, and which is authorized to standby on the project site by the Engineer, will be paid for according to Article 109.04(b)(4).”

Replace Article 109.04(b)(4) of the Standard Specifications with the following:

- “(4) Equipment. Equipment used for extra work shall be authorized by the Engineer. The equipment shall be specifically described, be of suitable size and capacity for the work to be performed, and be in good operating condition. For such equipment, the Contractor will be paid as follows.

- a. Contractor Owned Equipment. Contractor owned equipment will be paid for by the hour using the applicable FHWA hourly rate from the "Equipment Watch Rental Rate Blue Book" (Blue Book) in effect when the force account work begins. The FHWA hourly rate is calculated as follows.

FHWA hourly rate = (monthly rate/176) x (model year adj.) x (Illinois adj.) + EOC

Where: EOC = Estimated Operating Costs per hour (from the Blue Book)

The time allowed will be the actual time the equipment is operating on the extra work. For the time required to move the equipment to and from the site of the extra work and any authorized idle (standby) time, payment will be made at the following hourly rate: 0.5 x (FHWA hourly rate - EOC).

All time allowed shall fall within the working hours authorized for the extra work.

The rates above include the cost of fuel, oil, lubrication, supplies, small tools, necessary attachments, repairs, overhaul and maintenance of any kind, depreciation, storage, overhead, profits, insurance, and all incidentals. The rates do not include labor.

The Contractor shall submit to the Engineer sufficient information for each piece of equipment and its attachments to enable the Engineer to determine the proper equipment category. If a rate is not established in the Blue Book for a particular piece of equipment, the Engineer will establish a rate for that piece of equipment that is consistent with its cost and use in the industry.

- b. Rented Equipment. Whenever it is necessary for the Contractor to rent equipment to perform extra work, the rental and transportation costs of the equipment plus five percent for overhead will be paid. In no case shall the rental rates exceed those of established distributors or equipment rental agencies.

All prices shall be agreed to in writing before the equipment is used."

FLAGGER AT SIDE ROADS AND ENTRANCES (BDE)

Effective: April 1, 2009

Revise the second paragraph of Article 701.13(a) of the Standard Specifications to read:

"The Engineer will determine when a side road or entrance shall be closed to traffic. A flagger will be required at each side road or entrance remaining open to traffic within the operation where two-way traffic is maintained on one lane of pavement. The flagger shall be positioned as shown on the plans or as directed by the Engineer."

Revise the first and second paragraph of Article 701.20(i) of the Standard Specifications to read:

“Signs, barricades, or other traffic control devices required by the Engineer over and above those specified will be paid for according to Article 109.04. All flaggers required at side roads and entrances remaining open to traffic including those that are shown on the Highway Standards and/or additional barricades required by the Engineer to close side roads and entrances will be paid for according to Article 109.04.”

HOT-MIX ASPHALT – ANTI-STRIPPING ADDITIVE (BDE)

Effective: November 1, 2009

Revise the first and second paragraphs of Article 1030.04(c) of the Standard Specifications to read:

“(c) Determination of Need for Anti-Stripping Additive. The mixture designer shall determine if an additive is needed in the mix to prevent stripping. The determination will be made on the basis of tests performed according to Illinois Modified AASHTO T 283. To be considered acceptable by the Department as a mixture not susceptible to stripping, the conditioned to unconditioned split tensile strength ratio (TSR) shall be equal to or greater than 0.85 for 6 in. (150 mm) specimens. Mixtures, either with or without an additive, with TSRs less than 0.85 for 6 in. (150 mm) specimens will be considered unacceptable. Also, the conditioned tensile strength for mixtures containing an anti-strip additive shall not be lower than the original conditioned tensile strength determined for the same mixture without the anti-strip additive.

If it is determined that an additive is required, the additive may be hydrated lime, slaked quicklime, or a liquid additive, at the Contractor's option.”

HOT-MIX ASPHALT - DENSITY TESTING OF LONGITUDINAL JOINTS (BDE)

Effective: January 1, 2010

Description. This work shall consist of testing the density of longitudinal joints as part of the quality control/quality assurance (QC/QA) of hot-mix asphalt (HMA). Work shall be according to Section 1030 of the Standard Specifications except as follows.

Quality Control/Quality Assurance (QC/QA). Delete the second and third sentence of the third paragraph of Article 1030.05(d)(3) of the Standard Specifications.

Add the following paragraphs to the end of Article 1030.05(d)(3) of the Standard Specifications:

“Longitudinal joint density testing shall be performed at each random density test location. Longitudinal joint testing shall be located at a distance equal to the lift thickness or a minimum of 2 in. (50 mm), from each pavement edge. (i.e. for a 4 in. (100 mm) lift the near edge of the density gauge or core barrel shall be within 4 in. (100 mm) from the edge of pavement.) Longitudinal joint density testing shall be performed using either a correlated nuclear gauge or cores.

- a. Confined Edge. Each confined edge density shall be represented by a one-minute nuclear density reading or a core density and shall be included in the average of density readings or core densities taken across the mat which represents the Individual Test.

- b. Unconfined Edge. Each unconfined edge joint density shall be represented by an average of three one-minute density readings or a single core density at the given density test location and shall meet the density requirements specified herein. The three one-minute readings shall be spaced ten feet apart longitudinally along the unconfined pavement edge and centered at the random density test location.”

Revise the Density Control Limits table in Article 1030.05(d)(4) of the Standard Specifications to read:

“Mixture Composition	Parameter	Individual Test (includes confined edges)	Unconfined Edge Joint Density Minimum
IL-9.5, IL-12.5	N _{design} ≥ 90	92.0 – 96.0%	90.0%
IL-9.5,IL-9.5L, IL-12.5	N _{design} < 90	92.5 – 97.4%	90.0%
IL-19.0, IL-25.0	N _{design} ≥ 90	93.0 – 96.0%	90.0%
IL-19.0, IL-19.0L, IL-25.0	N _{design} < 90	93.0 – 97.4%	90.0%
SMA	N _{design} = 50 & 80	93.5 – 97.4%	91.0%
All Other	N _{design} = 30	93.0 - 97.4%	90.0%”

HOT-MIX ASPHALT – DROP-OFFS (BDE)

Effective: January 1, 2010

Revise the third paragraph of Article 701.07 of the Standard Specifications to read:

“At locations where construction operations result in a differential in elevation exceeding 3 in. (75 mm) between the edge of pavement or edge of shoulder within 3 ft (900 mm) of the edge of the pavement and the earth or aggregate shoulders, Type I or II barricades or vertical panels shall be placed at 100 ft (30 m) centers on roadways where the posted speed limit is 45 mph or greater and at 50 ft (15 m) centers on roadways where the posted speed limit is less than 45 mph.”

HOT-MIX ASPHALT - FINE AGGREGATE (BDE)

Effective: April 1, 2010

Add the following to the gradation tables of Article 1003.01(c) of the Standard Specifications:

“FINE AGGREGATE GRADATIONS					
Grad No.	Sieve Size and Percent Passing				
	3/8	No. 4	No. 8	No. 16	No. 200
FA 22	100	6/	6/	8±8	2±2

FINE AGGREGATE GRADATIONS (Metric)					
Grad No.	Sieve Size and Percent Passing				
	9.5 mm	4.75 mm	2.36 mm	1.18 mm	75 μm
FA 22	100	6/	6/	8±8	2±2

- 6/ For the fine aggregate gradation FA 22, the aggregate producer shall set the midpoint percent passing, and the Department will apply a range of \pm ten percent. The midpoint shall not be changed without Department approval.”

Revise Article 1003.03(a) of the Standard Specifications to read:

- “(a) Description. Fine aggregate for HMA shall consist of sand, stone sand, chats, slag sand, or steel slag sand. For gradation FA 22, uncrushed material will not be permitted.”

Revise Article 1003.03(c) of the Standard Specifications to read:

- “(c) Gradation. The fine aggregate gradation for all HMA shall be FA 1, FA 2, FA 20, FA 21, or FA 22.

Gradation FA 1, FA 2, or FA 3 shall be used when required for prime coat aggregate application for HMA.”

HOT-MIX ASPHALT – PLANT TEST FREQUENCY (BDE)

Effective: April 1, 2008

Revised: January 1, 2010

Revise the table in Article 1030.05(d)(2)a. of the Standard Specifications to read:

"Parameter	Frequency of Tests		Frequency of Tests All Other Mixtures	Test Method See Manual of Test Procedures for Materials
	High ESAL Mixture	Low ESAL Mixture		
Aggregate Gradation % passing sieves: 1/2 in. (12.5 mm), No. 4 (4.75 mm), No. 8 (2.36 mm), No. 30 (600 μm) No. 200 (75 μm) Note 1.	1 washed ignition oven test on the mix per half day of production Note 4.		1 washed ignition oven test on the mix per day of production Note 4.	Illinois Procedure
Asphalt Binder Content by Ignition Oven Note 2.	1 per half day of production		1 per day	Illinois-Modified AASHTO T 308
VMA Note 3.	Day's production ≥ 1200 tons: 1 per half day of production		N/A	Illinois Modified AASHTO R 35
	Day's production < 1200 tons: 1 per half day of production for first 2 days and 1 per day thereafter (first sample of the day)			
Air Voids Bulk Specific Gravity of Gyratory Sample	Day's production ≥ 1200 tons: 1 per half day of production		1 per day	Illinois-Modified AASHTO T 312
	Day's production < 1200 tons: 1 per half day of production for first 2 days and 1 per day thereafter (first sample of the day)			
Maximum Specific Gravity of Mixture	Day's production ≥ 1200 tons: 1 per half day of production		1 per day	Illinois-Modified AASHTO T 209
	Day's production < 1200 tons: 1 per half day of production for first 2 days and 1 per day thereafter (first sample of the day)			

Note 1. The No. 8 (2.36 mm) and No. 30 (600 μm) sieves are not required for All Other Mixtures.

Note 2. The Engineer may waive the ignition oven requirement for asphalt binder content if the aggregates to be used are known to have ignition asphalt binder content calibration factors which exceed 1.5 percent. If the ignition oven requirement is waived, other Department approved methods shall be used to determine the asphalt binder content.

Note 3. The G_{sb} used in the voids in the mineral aggregate (VMA) calculation shall be the same average G_{sb} value listed in the mix design.

Note 4. The Engineer reserves the right to require additional hot bin gradations for batch plants if control problems are evident.”

HOT-MIX ASPHALT – QC/QA ACCEPTANCE CRITERIA (BDE)

Effective: January 1, 2010

Revise Article 1030.05(f)(3) of the Standard Specifications to read:

“(3) Department assurance tests for voids, field VMA, and density.”

HOT-MIX ASPHALT – TRANSPORTATION (BDE)

Effective: April 1, 2008

Revise Article 1030.08 of the Standard Specifications to read:

“**1030.08 Transportation.** Vehicles used in transporting HMA shall have clean and tight beds. The beds shall be sprayed with asphalt release agents from the Department’s approved list. In lieu of a release agent, the Contractor may use a light spray of water with a light scatter of manufactured sand (FA 20 or FA 21) evenly distributed over the bed of the vehicle. After spraying, the bed of the vehicle shall be in a completely raised position and it shall remain in this position until all excess asphalt release agent or water has been drained.

When the air temperature is below 60 °F (15 °C), the bed, including the end, endgate, sides and bottom shall be insulated with fiberboard, plywood or other approved insulating material and shall have a thickness of not less than 3/4 in (20 mm). When the insulation is placed inside the bed, the insulation shall be covered with sheet steel approved by the Engineer. Each vehicle shall be equipped with a cover of canvas or other suitable material meeting the approval of the Engineer which shall be used if any one of the following conditions is present.

- (a) Ambient air temperature is below 60 °F (15 °C).
- (b) The weather is inclement.
- (c) The temperature of the HMA immediately behind the paver screed is below 250 °F (120 °C).

The cover shall extend down over the sides and ends of the bed for a distance of approximately 12 in. (300 mm) and shall be fastened securely. The covering shall be rolled back before the load is dumped into the finishing machine.”

IMPROVED SUBGRADE (BDE)

Effective: January 1, 2010

Revise the second paragraph of Article 302.04 of the Standard Specifications to read:

“The quantity of modified soil constructed shall be limited to that which can be covered by the full thickness of portland cement concrete pavement or HMA binder during the same construction season.”

Revise the first paragraph of Article 302.07 of the Standard Specifications to read:

“**302.07 Application of Modifier.** The modifier shall be applied uniformly on the soil. The application of modifier shall be limited to that amount which can be mixed with the soil within the same working day.”

Revise the first paragraph of Article 302.08 of the Standard Specifications to read:

“**302.08 Mixing.** The modifier, soil, and water shall be thoroughly mixed. Mixing shall continue until a homogenous layer of the required thickness has been obtained and a minimum of 75 percent of the mixture is smaller than 1 in. (25 mm). The moisture content of the modified soil shall be above optimum moisture content with a maximum of three percent above optimum.”

Revise Article 302.10 of the Standard Specifications to read:

“ **302.10 Finishing and Curing.** When multiple lifts are used to construct the modified soil layer, the top lift shall be a minimum of 6 in. (150 mm) thick when compacted.

Construction of pipe underdrains shall follow the requirements of Article 407.07. The surface of the modified soil shall be kept drained according to Article 301.09 and shall maintain moisture content not exceeding three percent above optimum prior to pavement construction.

When compaction of the modified soil is nearing completion, the surface shall be shaped to the required lines, grades, and cross section shown on the plans. For HMA base course and pavement (full-depth) and portland cement concrete base course and pavement, the surface of the modified soil shall be brought to true shape and correct elevation according to Article 301.07, except well compacted earth shall not be used to fill low areas.

The modified soil shall be cured for a minimum of 24 hours. The ambient air temperature shall be above 45 °F (7 °C) during curing.

During the curing period, the moisture content of the modified soil shall be maintained at optimum by sprinkling with water, use of plastic sheeting, or applying bituminous materials according to Article 312.14. During this period, no equipment or traffic will be permitted on the completed work beyond that required for maintenance of curing.

Equipment of such weight, or used in such a way as to cause a rut depth of 1/2 in. (13 mm) or more in the finished modified soil, shall be removed, or the rutting otherwise prevented, as directed by the Engineer.”

Revise the first paragraph of Article 302.11 of the Standard Specifications to read:

“302.11 Subgrade Stability. Following curing, the Engineer will determine the stability of the modified soil in terms of the immediate bearing value (IBV), according to Illinois Test Procedure 501. The IBV shall be a minimum of 10.0 measured within 10 calendar days prior to pavement construction.”

Revise the second paragraph of Article 310.04 of the Standard Specifications to read:

“The quantity of lime stabilized soil mixture constructed shall be limited to that which can be covered by the full thickness of portland cement concrete pavement or HMA binder during the same construction season.”

Revise the first paragraph of Article 310.08(a) of the Standard Specifications to read:

“(a) Initial Mixing. The lime, soil, and water shall be thoroughly mixed until a uniform mixture throughout the required depth and width is obtained. All clods and lumps shall be reduced to a maximum size of 2 in. (50 mm). The moisture content of the stabilized soil shall be above optimum moisture content with a maximum of three percent above optimum.”

Insert the following paragraph after the first paragraph of Article 310.10 of the Standard Specifications:

“Construction of pipe underdrains shall follow the requirements of Article 407.07. The surface of the lime stabilized soil shall be kept drained according to Article 301.09 and shall maintain a maximum moisture content of three percent above optimum prior to pavement construction.”

Revise the first paragraph of Article 310.11 of the Standard Specifications to read:

“310.11 Subgrade Stability. Following curing, the Engineer will determine the stability of the lime stabilized soil mixture in terms of the immediate bearing value (IBV) according to Illinois Test Procedure 501. The IBV shall be a minimum of 23.0 measured within 10 calendar days prior to pavement construction.”

Revise the second paragraph of Article 311.05 of the Standard Specifications to read:

“The granular material shall be placed and compacted at least three days prior to the placement of pavement or base course. Except where required for temporary access, the quantity of subbase granular material Types A or B to be placed shall be limited to that which can be covered by the full thickness of PCC pavement or HMA binder during the same construction season.”

LIQUIDATED DAMAGES (BDE)

Effective: April 1, 2009

Revise the table in Article 108.09 of the Standard Specifications to read:

"Schedule of Deductions for Each Day of Overrun in Contract Time			
Original Contract Amount		Daily Charges	
From More Than	To and Including	Calendar Day	Work Day
\$ 0	\$ 100,000	\$ 375	\$ 500
100,000	500,000	625	875
500,000	1,000,000	1,025	1,425
1,000,000	3,000,000	1,125	1,550
3,000,000	5,000,000	1,425	1,950
5,000,000	10,000,000	1,700	2,350
10,000,000	And over	3,325	4,650"

NATIONAL POLLUTANT DISCHARGE ELIMINATION SYSTEM / EROSION AND SEDIMENT CONTROL DEFICIENCY DEDUCTION (BDE)

Effective: April 1, 2007

Revised: November 1, 2009

Revise Article 105.03(a) of the Standard Specifications to read:

“(a) National Pollutant Discharge Elimination System (NPDES) / Erosion and Sediment Control Deficiency Deduction When the Engineer is notified or determines an erosion and/or sediment control deficiency(s) exists, or the Contractor’s activities represents a violation of the Department’s NPDES permits, the Engineer will notify and direct the Contractor to correct the deficiency within a specified time. The specified time, which begins upon notification to the Contractor, will be from 1/2 hour to 1 week based on the urgency of the situation and the nature of the work effort required. The Engineer will be the sole judge.

A deficiency may be any lack of repair, maintenance, or implementation of erosion and/or sediment control devices included in the contract, or any failure to comply with the conditions of the Department’s NPDES permits. A deficiency may also be applied to situations where corrective action is not an option such as the failure to participate in a jobsite inspection of the project, failure to install required measures prior to initiating earth moving operations, disregard of concrete washout requirements, or other disregard of the NPDES permit.

If the Contractor fails to correct a deficiency within the specified time, a daily monetary deduction will be imposed for each calendar day or portion of a calendar day until the deficiency is corrected to the satisfaction of the Engineer. The calendar day(s) will begin with notification to the Contractor and end with the Engineer’s acceptance of the correction. The base value of the daily monetary deduction is \$1000.00 and will be applied to each location for which a deficiency exists.

The value of the deficiency deduction assessed for each infraction will be determined by multiplying the base value by a Gravity Adjustment Factor provided in Table A. Except for failure to participate in a required jobsite inspection of the project prior to initiating earthmoving operations which will be based on the total acreage of planned disturbance at the following multipliers: <5 Acres: 1; 5-10 Acres: 2; >10-25 Acres: 3; >25 Acres: 5. For those deficiencies where corrective action was not an option, the monetary deduction will be immediate and will be valued at one calendar day multiplied by a Gravity Adjustment Factor.

Table A Deficiency Deduction Gravity Adjustment Factors				
Types of Violations	Soil Disturbed and Not Permanently Stabilized At Time of Violation			
	< 5 Acres	5 - 10 Acres	>10 - 25 Acres	> 25 Acres
Failure to Install or Properly Maintain BMP	0.1 - 0.5	0.2 - 1.0	0.5 - 2.5	1.0 - 5
Careless Destruction of BMP	0.2 - 1	0.5 - 2.5	1.0 - 5.	1.0 - 5
Intrusion into Protected Resource	1.0 - 5	1.0 - 5	2.0 - 10	2.0 - 10
Failure to properly manage Chemicals, Concrete Washouts or Residuals, Litter or other Wastes	0.2 - 1	0.2 - 1	0.5 - 2.5	1.0 - 5
Improper Vehicle and Equipment Maintenance, Fueling or Cleaning	0.1 - 0.5	0.2 - 1	0.2 - 1	0.5 - 2.5
Failure to Provide or Update Written or Graphic Plans Required by SWPPP	0.2 - 1	0.5 - 2.5	1.0 - 5	1.0 - 5
Failure to comply with Other Provisions of the NPDES Permit	0.1 - 0.5	0.2 - 1	0.2 - 1	0.5 - 2.5"

PAVEMENT PATCHING (BDE)

Effective: January 1, 2010

Revise the first sentence of the second paragraph of Article 701.17(e)(1) of the Standard Specifications to read:

“In addition to the traffic control and protection shown elsewhere in the contract for pavement, two devices shall be placed immediately in front of each open patch, open hole, and broken pavement where temporary concrete barriers are not used to separate traffic from the work area.”

PAYMENTS TO SUBCONTRACTORS (BDE)

Effective: June 1, 2000

Revised: January 1, 2006

Federal regulations found at 49 CFR §26.29 mandate the Department to establish a contract clause to require Contractors to pay subcontractors for satisfactory performance of their subcontracts and to set the time for such payments.

State law also addresses the timing of payments to be made to subcontractors and material suppliers. Section 7 of the Prompt Payment Act, 30 ILCS 540/7, requires that when a Contractor receives any payment from the Department, the Contractor shall make corresponding, proportional payments to each subcontractor and material supplier performing work or supplying material within 15 calendar days after receipt of the Department payment. Section 7 of the Act further provides that interest in the amount of two percent per month, in addition to the payment due, shall be paid to any subcontractor or material supplier by the Contractor if the payment required by the Act is withheld or delayed without reasonable cause. The Act also provides that the time for payment required and the calculation of any interest due applies to transactions between subcontractors and lower-tier subcontractors and material suppliers throughout the contracting chain.

This Special Provision establishes the required federal contract clause, and adopts the 15 calendar day requirement of the State Prompt Payment Act for purposes of compliance with the federal regulation regarding payments to subcontractors. This contract is subject to the following payment obligations.

When progress payments are made to the Contractor according to Article 109.07 of the Standard Specifications, the Contractor shall make a corresponding payment to each subcontractor and material supplier in proportion to the work satisfactorily completed by each subcontractor and for the material supplied to perform any work of the contract. The proportionate amount of partial payment due to each subcontractor and material supplier throughout the contracting chain shall be determined by the quantities measured or otherwise determined as eligible for payment by the Department and included in the progress payment to the Contractor. Subcontractors and material suppliers shall be paid by the Contractor within 15 calendar days after the receipt of payment from the Department. The Contractor shall not hold retainage from the subcontractors. These obligations shall also apply to any payments made by subcontractors and material suppliers to their subcontractors and material suppliers; and to all payments made to lower tier subcontractors and material suppliers throughout the contracting chain. Any payment or portion of a payment subject to this provision may only be withheld from the subcontractor or material supplier to whom it is due for reasonable cause.

This Special Provision does not create any rights in favor of any subcontractor or material supplier against the State or authorize any cause of action against the State on account of any payment, nonpayment, delayed payment, or interest claimed by application of the State Prompt Payment Act. The Department will not approve any delay or postponement of the 15 day requirement except for reasonable cause shown after notice and hearing pursuant to Section 7(b) of the State Prompt Payment Act. State law creates other and additional remedies available to any subcontractor or material supplier, regardless of tier, who has not been paid for work properly performed or material furnished. These remedies are a lien against public funds set forth in Section 23(c) of the Mechanics Lien Act, 770 ILCS 60/23(c), and a recovery on the Contractor's payment bond according to the Public Construction Bond Act, 30 ILCS 550.

PERSONAL PROTECTIVE EQUIPMENT (BDE)

Effective: November 1, 2008

Revise the first sentence of Article 701.12 of the Standard Specifications to read:

“All personnel on foot, excluding flaggers, within the highway right-of-way shall wear a fluorescent orange, fluorescent yellow/green, or a combination of fluorescent orange and fluorescent yellow/green vest meeting the requirements of ANSI/ISEA 107-2004 for Conspicuity Class 2 garments.”

PRECAST CONCRETE HANDLING HOLES (BDE)

Effective: January 1, 2007

Add the following to Article 540.02 of the Standard Specifications:

“(g) Handling Hole Plugs 1042.16”

Add the following paragraph after the sixth paragraph of Article 540.06 of the Standard Specifications:

“Handling holes shall be filled with a precast concrete plug and sealed with mastic or mortar, or filled with a polyethylene plug. The plug shall not project beyond the inside surface after installation. When metal lifting inserts are used, their sockets shall be filled with mastic or mortar.”

Add the following to Article 542.02 of the Standard Specifications:

“(ee) Handling Hole Plugs 1042.16”

Revise the fifth paragraph of Article 542.04(d) of the Standard Specifications to read:

“Handling holes in concrete pipe shall be filled with a precast concrete plug and sealed with mastic or mortar; or filled with a polyethylene plug. The plug shall not project beyond the inside surface after installation.”

Add the following to Article 550.02 of the Standard Specifications:

“(o) Handling Hole Plugs 1042.16”

Replace the fourth sentence of the fifth paragraph of Article 550.06 of the Standard Specifications with the following:

“Handling holes in concrete pipe shall be filled with a precast concrete plug and sealed with mastic or mortar; or filled with a polyethylene plug. The plug shall not project beyond the inside surface after installation.”

Add the following to Article 602.02 of the Standard Specifications:

“(p) Handling Hole Plugs 1042.16(a)”

Replace the fifth sentence of the first paragraph of Article 602.07 of the Standard Specifications with the following:

“Handling holes shall be filled with a precast concrete plug and sealed with mastic or mortar. The plug shall not project beyond the inside surface after installation. When metal lifting inserts are used, their sockets shall be filled with mastic or mortar.”

Add the following to Section 1042 of the Standard Specifications:

“**1042.16 Handling Hole Plugs.** Plugs for handling holes in precast concrete products shall be as follows.

- (a) Precast Concrete Plug. The precast concrete plug shall have a tapered shape and shall have a minimum compressive strength of 3000 psi (20,700 kPa) at 28 days.
- (b) Polyethylene Plug. The polyethylene plug shall have a “mushroom” shape with a flat round top and a stem with three different size ribs. The plug shall fit snugly and cover the handling hole.

The plug shall be according to the following.

Mechanical Properties	Test Method	Value (min.)
Flexural Modulus	ASTM D 790	3300 psi (22,750 kPa)
Tensile Strength (Break)	ASTM D 638	1600 psi (11,030 kPa)
Tensile Strength (Yield)	ASTM D 638	1200 psi (8270 kPa)

Thermal Properties	Test Method	Value (min.)
Brittle Temperature	ASTM D 746	-49 °F (-45 °C)
Vicat Softening Point	ASTM D 1525	194 °F (90 °C)”

RECLAIMED ASPHALT PAVEMENT (RAP) (BDE)

Effective: January 1, 2007

Revised: January 1, 2010

In Article 1030.02(g), delete the last sentence of the first paragraph in (Note 2).

Revise Section 1031 of the Standard Specifications to read:

“SECTION 1031. RECLAIMED ASPHALT PAVEMENT

1031.01 Description. Reclaimed asphalt pavement (RAP) is reclaimed asphalt pavement resulting from cold milling or crushing of an existing dense graded hot-mix asphalt (HMA) pavement. The Contractor shall supply written documentation that the RAP originated from routes or airfields under federal, state, or local agency jurisdiction.

1031.02 Stockpiles. The Contractor shall construct individual, sealed RAP stockpiles meeting one of the following definitions. No additional RAP shall be added to the pile after the pile has been sealed. Stockpiles shall be sufficiently separated to prevent intermingling at the base. Stockpiles shall be identified by signs indicating the type as listed below (i.e. “Homogeneous Surface”).

Prior to milling, the Contractor shall request the District to provide verification of the quality of the RAP to clarify appropriate stockpile.

- (a) Fractionated RAP (FRAP). FRAP shall consist of RAP from Class I, Superpave (High ESAL), HMA (High ESAL), or equivalent mixtures. The coarse aggregate in FRAP shall be crushed aggregate and may represent more than one aggregate type and/or quality but shall be at least C quality. All FRAP shall be fractionated prior to testing by screening into a minimum of two size fractions with the separation occurring on or between the #4 (4.75 mm) and 1/2 in. (12.5 mm) sieves. Agglomerations shall be minimized such that 100 percent of the RAP in the coarse fraction shall pass one sieve size larger than the maximum sieve size specified for the mix the RAP will be used in.
- (b) Homogeneous. Homogeneous RAP stockpiles shall consist of RAP from Class I, Superpave (High ESAL), HMA (High ESAL), or equivalent mixtures and represent: 1) the same aggregate quality, but shall be at least C quality; 2) the same type of crushed aggregate (either crushed natural aggregate, ACBF slag, or steel slag); 3) similar gradation; and 4) similar asphalt binder content. If approved by the Engineer, combined single pass surface/binder millings may be considered "homogenous" with a quality rating dictated by the lowest coarse aggregate quality present in the mixture.
- (c) Conglomerate. Conglomerate RAP stockpiles shall consist of RAP from Class I, Superpave (High ESAL), HMA (High ESAL), or equivalent mixtures. The coarse aggregate in this RAP shall be crushed aggregate and may represent more than one aggregate type and/or quality but shall be at least C quality. This RAP may have an inconsistent gradation and/or asphalt binder content prior to processing. All conglomerate RAP shall be processed prior to testing by crushing to where all RAP shall pass the 5/8 in. (16 mm) or smaller screen. Conglomerate RAP stockpiles shall not contain steel slag or other expansive material as determined by the Department.
- (d) Conglomerate "D" Quality (DQ). Conglomerate DQ RAP stockpiles shall consist of RAP from Class I, Superpave (High or Low ESAL), HMA (High or Low ESAL), or equivalent mixtures. The coarse aggregate in this RAP may be crushed or round but shall be at least D quality. This RAP may have an inconsistent gradation and/or asphalt binder content. Conglomerate DQ RAP stockpiles shall not contain steel slag or other expansive material as determined by the Department.
- (e) Non-Quality. RAP stockpiles that do not meet the requirements of the stockpile categories listed above shall be classified as "Non-Quality".

RAP/FRAP containing contaminants, such as earth, brick, sand, concrete, sheet asphalt, bituminous surface treatment (i.e. chip seal), pavement fabric, joint sealants, etc., will be unacceptable unless the contaminants are removed to the satisfaction of the Engineer. Sheet asphalt shall be stockpiled separately.

1031.03 Testing. When used in HMA, the RAP/FRAP shall be sampled and tested either during or after stockpiling.

For testing during stockpiling, washed extraction samples shall be run at the minimum frequency of one sample per 500 tons (450 metric tons) for the first 2000 tons (1800 metric tons) and one sample per 2000 tons (1800 metric tons) thereafter. A minimum of five tests shall be required for stockpiles less than 4000 tons (3600 metric tons).

For testing after stockpiling, the Contractor shall submit a plan for approval to the District proposing a satisfactory method of sampling and testing the RAP/FRAP pile either in-situ or by restockpiling. The sampling plan shall meet the minimum frequency required above and detail the procedure used to obtain representative samples throughout the pile for testing.

Before extraction, each field sample shall be split to obtain two samples of test sample size. One of the two test samples from the final split shall be labeled and stored for Department use. The Contractor shall extract the other test sample according to Department procedure. The Engineer reserves the right to test any sample (split or Department-taken) to verify Contractor test results.

Evaluation of Test Results. All of the extraction results shall be compiled and averaged for asphalt binder content and gradation and, when applicable G_{mm} . Individual extraction test results, when compared to the averages, will be accepted if within the tolerances listed below.

Parameter	FRAP/Homogeneous /Conglomerate	Conglomerate "D" Quality
1 in. (25 mm)		± 5 %
1/2 in. (12.5 mm)	± 8 %	± 15 %
No. 4 (4.75 mm)	± 6 %	± 13 %
No. 8 (2.36 mm)	± 5 %	
No. 16 (1.18 mm)		± 15 %
No. 30 (600 μm)	± 5 %	
No. 200 (75 μm)	± 2.0 %	± 4.0 %
Asphalt Binder	± 0.4 % ^{1/}	± 0.5 %
G_{mm}	± 0.03	

1/ The tolerance for FRAP shall be ± 0.3 %.

If more than 20 percent of the individual sieves are out of the gradation tolerances, or if more than 20 percent of the asphalt binder content test results fall outside the appropriate tolerances, the RAP/FRAP shall not be used in HMA unless the RAP/FRAP representing the failing tests is removed from the stockpile. All test data and acceptance ranges shall be sent to the District for evaluation.

With the approval of the Engineer, the ignition oven may be substituted for extractions according to the Illinois Test Procedure, "Calibration of the Ignition Oven for the Purpose of Characterizing Reclaimed Asphalt Pavement (RAP)".

1031.04 Quality Designation of Aggregate in RAP/FRAP.

(a) The aggregate quality of the RAP for homogenous, conglomerate, and conglomerate "D" quality stockpiles shall be set by the lowest quality of coarse aggregate in the RAP stockpile and are designated as follows.

(1) RAP from Class I, Superpave (High ESAL)/HMA (High ESAL), or HMA (Low ESAL) IL-9.5L surface mixtures are designated as containing Class B quality coarse aggregate.

- (2) RAP from Superpave (Low ESAL)/HMA (Low ESAL) IL-19.0L binder mixture is designated as Class D quality coarse aggregate.
- (3) RAP from Class I, Superpave (High ESAL), or HMA (High ESAL) binder mixtures, bituminous base course mixtures, and bituminous base course widening mixtures are designated as containing Class C quality coarse aggregate.
- (4) RAP from bituminous stabilized subbase and BAM shoulders are designated as containing Class D quality coarse aggregate.

(b) The aggregate quality of FRAP shall be determined as follows.

Fractionated stockpiles containing plus #4 (4.75 mm) sieve coarse aggregate shall have a maximum tonnage of 5000 tons (4500 metric tons). The Contractor shall obtain a representative sample witnessed by the Engineer. The sample shall be a minimum of 50 lb (25 kg). The sample shall be extracted according to Illinois Modified AASHTO T 164 by a consultant prequalified by the Department for the specified testing. The consultant shall submit the test results along with the recovered aggregate to the District Office. The cost for this testing shall be paid by the Contractor. The District will forward the sample to the BMPR Aggregate Lab for MicroDeval Testing, according to Illinois Modified AASHTO T 327. A maximum loss of 15.0 percent will be applied for all HMA applications.”

1031.05 Use of RAP/FRAP in HMA. The use of RAP/FRAP shall be a Contractor’s option when constructing HMA in all contracts. The use of RAP/FRAP in HMA shall be as follows.

- (a) Coarse Aggregate Size. The coarse aggregate in all RAP shall be equal to or less than the nominal maximum size requirement for the HMA mixture to be produced.
- (b) Steel Slag Stockpiles. RAP stockpiles containing steel slag or other expansive material, as determined by the Department, shall be homogeneous and will be approved for use in HMA (High ESAL and Low ESAL) surface mixtures only.
- (c) Use in HMA Surface Mixtures (High and Low ESAL). RAP/FRAP stockpiles for use in HMA surface mixtures (High and Low ESAL) shall be FRAP or homogeneous in which the coarse aggregate is Class B quality or better.
- (d) Use in HMA Binder Mixtures (High and Low ESAL), HMA Base Course, and HMA Base Course Widening. RAP/FRAP stockpiles for use in HMA binder mixtures (High and Low ESAL), HMA base course, and HMA base course widening shall be FRAP, homogeneous, or conglomerate, in which the coarse aggregate is Class C quality or better.
- (e) Use in Shoulders and Subbase. RAP/FRAP stockpiles for use in HMA shoulders and stabilized subbase (HMA) shall be FRAP, homogeneous, conglomerate, or conglomerate DQ.
- (f) When the Contractor chooses the RAP option, the percentage of RAP shall not exceed the amounts indicated in the table below for a given N Design.

Max RAP Percentage

HMA Mixtures ^{1/, 3/}	Maximum % RAP		
	Binder/Leveling Binder	Surface	Polymer Modified
Ndesign			
30	30	30	10
50	25	15	10
70	15 / 25 ^{2/}	10 / 15 ^{2/}	10
90	10	10	10
105	10	10	10

- 1/ For HMA shoulder and stabilized subbase (HMA) N-30, the amount of RAP shall not exceed 50% of the mixture.
- 2/ Value of Max % RAP if homogeneous RAP stockpile of IL-9.5 RAP is utilized.
- 3/ When RAP exceeds 20 percent, the high and low virgin asphalt binder grades shall each be reduced by one grade (i.e. 25 percent RAP would require a virgin asphalt binder grade of PG64-22 to be reduced to a PG58-28). If warm mix asphalt (WMA) technology is utilized, and production temperatures do not exceed 275°F (135 °C) the grades shall be reduced as follows:

Overlays:

When WMA contains between 20 and 30 percent RAP the high temperature shall be reduced by one grade (i.e. 25 percent RAP would require a virgin asphalt binder grade of PG64-22 to be reduced to a PG58-22). When WMA contains 30 percent or more RAP the high and low temperature grades shall each be reduced by one grade (i.e. 35 percent RAP would require a virgin asphalt binder grade of PG64-22 to be reduced to a PG58-28).

Full Depth:

When WMA contains between 20 and 30 percent RAP, the low temperature shall be reduced by one grade (i.e. 25 percent RAP would require a virgin asphalt binder grade of PG64-22 to be reduced to a PG64-28). When the WMA contains 30 percent or more RAP the high and low temperature grades shall each be reduced by one grade (i.e. 35 percent RAP would require a virgin asphalt binder grade of PG64-22 to be reduced to a PG58-28).

- (g) When the Contractor chooses the FRAP option, the percentage of FRAP shall not exceed the amounts indicated in the table below for a given N Design.

Max FRAP Percentage

HMA Mixtures ^{1/, 2/}	Maximum % FRAP		
	Ndesign	Binder/Leveling Binder	Surface
30	35	35	10
50	30	25	10
70	25	20	10
90	20	15	10
105	10	10	10

- 1/ For HMA shoulder and stabilized subbase (HMA) N30, the amount of FRAP shall not exceed 50 percent of the mixture.
- 2/ When FRAP exceeds 20 percent, the high and low virgin asphalt binder grades shall each be reduced by one grade (i.e. 25 percent FRAP would require a virgin asphalt binder grade of PG64-22 to be reduced to a PG58-28). If warm mix asphalt (WMA) technology is utilized, and production temperatures do not exceed 275°F (135 °C) the grades shall be reduced as follows:

Overlays:

When WMA contains between 20 and 30 percent FRAP the high temperature shall be reduced by one grade (i.e. 25 percent FRAP would require a virgin asphalt binder grade of PG64-22 to be reduced to a PG58-22). When WMA contains 30 percent or more FRAP the high and low temperature grades shall each be reduced by one grade (i.e. 35 percent FRAP would require a virgin asphalt binder grade of PG64-22 to be reduced to a PG58-28).

Full Depth:

When WMA contains between 20 and 30 percent FRAP, the low temperature shall be reduced by one grade (i.e. 25 percent FRAP would require a virgin asphalt binder grade of PG64-22 to be reduced to a PG64-28). When the WMA contains 30 percent or more FRAP the high and low temperature grades shall each be reduced by one grade (i.e. 35 percent FRAP would require a virgin asphalt binder grade of PG64-22 to be reduced to a PG58-28).

1031.06 HMA Mix Designs. At the Contractor's option, HMA mixtures may be constructed utilizing RAP/FRAP material meeting the above detailed requirements.

RAP/FRAP designs shall be submitted for volumetric verification. If additional RAP/FRAP stockpiles are tested and found that no more than 20 percent of the results, as defined under "Testing" herein, are outside of the control tolerances set for the original RAP/FRAP stockpile and HMA mix design, and meets all of the requirements herein, the additional RAP/FRAP stockpiles may be used in the original mix design at the percent previously verified.

1031.07 HMA Production. The coarse aggregate in all RAP used shall be equal to or less than the nominal maximum size requirement for the HMA mixture being produced.

To remove or reduce agglomerated material, a scalping screen, gator, crushing unit, or comparable sizing device approved by the Engineer shall be used in the RAP feed system to remove or reduce oversized material. If material passing the sizing device adversely affects the mix production or quality of the mix, the sizing device shall be set at a size specified by the Engineer.

If the RAP/FRAP control tolerances or QC/QA test results require corrective action, the Contractor shall cease production of the mixture containing RAP/FRAP and either switch to the virgin aggregate design or submit a new RAP/FRAP design.

HMA plants utilizing RAP/FRAP shall be capable of automatically recording and printing the following information.

(a) Dryer Drum Plants.

- (1) Date, month, year, and time to the nearest minute for each print.
- (2) HMA mix number assigned by the Department.
- (3) Accumulated weight of dry aggregate (combined or individual) in tons (metric tons) to the nearest 0.1 ton (0.1 metric ton).
- (4) Accumulated dry weight of RAP/FRAP in tons (metric tons) to the nearest 0.1 ton (0.1 metric ton).
- (5) Accumulated mineral filler in revolutions, tons (metric tons), etc. to the nearest 0.1 unit.
- (6) Accumulated asphalt binder in gallons (liters), tons (metric tons), etc. to the nearest 0.1 unit.
- (7) Residual asphalt binder in the RAP/FRAP material as a percent of the total mix to the nearest 0.1 percent.
- (8) Aggregate and RAP/FRAP moisture compensators in percent as set on the control panel. (Required when accumulated or individual aggregate and RAP/FRAP are printed in wet condition.)

(b) Batch Plants.

- (1) Date, month, year, and time to the nearest minute for each print.
- (2) HMA mix number assigned by the Department.
- (3) Individual virgin aggregate hot bin batch weights to the nearest pound (kilogram).
- (4) Mineral filler weight to the nearest pound (kilogram).
- (5) RAP/FRAP weight to the nearest pound (kilogram).
- (6) Virgin asphalt binder weight to the nearest pound (kilogram).

- (7) Residual asphalt binder in the RAP/FRAP material as a percent of the total mix to the nearest 0.1 percent.

The printouts shall be maintained in a file at the plant for a minimum of one year or as directed by the Engineer and shall be made available upon request. The printing system will be inspected by the Engineer prior to production and verified at the beginning of each construction season thereafter.

1031.08 RAP in Aggregate Surface Course and Aggregate Shoulders. The use of RAP in aggregate surface course and aggregate shoulders shall be as follows.

- (a) Stockpiles and Testing. RAP stockpiles may be any of those listed in Article 1031.02, except “Non-Quality” and “FRAP”. The testing requirements of Article 1031.03 shall not apply.
- (b) Gradation. One hundred percent of the RAP material shall pass the 1 1/2 in. (37.5 mm) sieve. The RAP material shall be reasonably well graded from coarse to fine. RAP material that is gap-graded or single sized will not be accepted.”

REFLECTIVE SHEETING ON CHANNELIZING DEVICES (BDE)

Effective: April 1, 2007

Revised: November 1, 2008

Revise the seventh paragraph of Article 1106.02 of the Standard Specifications to read:

“At the time of manufacturing, the retroreflective prismatic sheeting used on channelizing devices shall meet or exceed the initial minimum coefficient of retroreflection as specified in the following table. Measurements shall be conducted according to ASTM E 810, without averaging. Sheeting used on cones, drums and flexible delineators shall be reboundable as tested according to ASTM D 4956. Prestriped sheeting for rigid substrates on barricades shall be white and orange. The sheeting shall be uniform in color and devoid of streaks throughout the length of each roll. The color shall conform to the latest appropriate standard color tolerance chart issued by the U.S. Department of Transportation, Federal Highway Administration, and to the daytime and nighttime color requirements of ASTM D 4956.

Initial Minimum Coefficient of Retroreflection candelas/foot candle/sq ft (candelas/lux/sq m) of material				
Observation Angle (deg.)	Entrance Angle (deg.)	White	Orange	Fluorescent Orange
0.2	-4	365	160	150
0.2	+30	175	80	70
0.5	-4	245	100	95
0.5	+30	100	50	40”

Revise the first sentence of the first paragraph of Article 1106.02(c) of the Standard Specifications to read:

“Barricades and vertical panels shall have alternating white and orange stripes sloping downward at 45 degrees toward the side on which traffic will pass.”

Revise the third sentence of the first paragraph of Article 1106.02(d) of the Standard Specifications to read:

“The bottom panels shall be 8 x 24 in. (200 x 600 mm) with alternating white and orange stripes sloping downward at 45 degrees toward the side on which traffic will pass.”

SELF-CONSOLIDATING CONCRETE FOR PRECAST PRODUCTS (BDE)

Effective: July 1, 2004

Revised: January 1, 2007

Definition. Self-consolidating concrete is a flowable mixture that does not require mechanical vibration for consolidation.

Usage. Self-consolidating concrete may be used for precast concrete products.

Materials. Materials shall be according to Section 1021 of the Standard Specifications.

Mix Design Criteria. The mix design criteria shall be as follows:

- (a) The minimum cement factor shall be according to Article 1020.04 of the Standard Specifications. If the maximum cement factor is not specified, it shall not exceed 7.05 cwt/cu yd (418 kg/cu m).
- (b) The maximum allowable water/cement ratio shall be according to Article 1020.04 of the Standard Specifications or 0.44, whichever is lower.
- (c) The slump requirements of Article 1020.04 of the Standard Specifications shall not apply.
- (d) The coarse aggregate gradations shall be CA 13, CA 14, CA 16, or a blend of these gradations. CA 11 may be used when the Contractor provides satisfactory evidence to the Engineer that the mix will not segregate. The fine aggregate proportion shall be a maximum 50 percent by weight (mass) of the total aggregate used.
- (e) The slump flow range shall be ± 2 in. (± 50 mm) of the Contractor target value, and within the overall Department range of 20 in. (510 mm) minimum to 28 in. (710 mm) maximum.
- (f) The visual stability index shall be a maximum of 1.
- (g) The J-ring value shall be a maximum of 4 in. (100 mm). The Contractor may specify a lower maximum in the mix design.
- (h) The L-box blocking ratio shall be a minimum of 60 percent. The Contractor may specify a higher minimum in the mix design.
- (i) The column segregation index shall be a maximum 15 percent.
- (j) The hardened visual stability index shall be a maximum of 1.

Placing and Consolidating. The maximum distance of horizontal flow from the point of deposit shall be 25 ft (7.6 m), unless approved otherwise by the Engineer.

Concrete shall be rodded with a piece of lumber, conduit, or vibrator if the material has lost its fluidity prior to placement of additional concrete. The vibrator shall be the pencil head type with a maximum diameter or width of 1 in. (25 mm). Any other method for restoring the fluidity of the concrete shall be approved by the Engineer.

Mix Design Approval. The Contractor shall obtain mix design approval according to the Department's Policy Memorandum "Quality Control/Quality Assurance Program for Precast Concrete Products".

SUBCONTRACTOR MOBILIZATION PAYMENTS (BDE)
Effective: April 2, 2005

To account for the preparatory work and operations necessary for the movement of subcontractor personnel, equipment, supplies, and incidentals to the project site and for all other work or operations that must be performed or costs incurred when beginning work approved for subcontracting in accordance with Article 108.01 of the Standard Specifications, the Contractor shall make a mobilization payment to each subcontractor.

This mobilization payment shall be made at least 14 days prior to the subcontractor starting work. The amount paid shall be equal to 3 percent of the amount of the subcontract reported on form BC 260A submitted for the approval of the subcontractor's work.

This provision shall be incorporated directly or by reference into each subcontract approved by the Department.

TEMPORARY EROSION CONTROL (BDE)
Effective: November 1, 2002

Revised: January 1, 2010

Add the following to Article 280.02 of the Standard Specifications to read:

"(k) Filter Fabric 1080.03"

Revise the third paragraph of Article 280.03 of the Standard Specifications to read:

"Erosion control systems shall be installed prior to beginning any activities which will potentially create erodible conditions. Erosion control systems for areas outside the limits of construction such as storage sites, plant sites, waste sites, haul roads, and Contractor furnished borrow sites shall be installed prior to beginning soil disturbing activities at each area. These offsite systems shall be designed by the Contractor and be subject to the approval of the Engineer."

Add the following paragraph after the third paragraph of Article 280.03 of the Standard Specifications:

“The temporary erosion and sediment control systems shown on the plans represent the minimum systems anticipated for the project. Conditions created by the Contractor’s operations, or for the Contractor’s convenience, which are not covered by the plans, shall be protected as directed by the Engineer at no additional cost to the Department. Revisions or modifications of the erosion and sediment control systems shall have the Engineer’s written approval.”

Revise Article 280.04(a) of the Standard Specifications to read:

“(a) Temporary Ditch Checks. This system consists of the construction of temporary ditch checks to prevent siltation, erosion, or scour of ditches and drainage ways. Temporary ditch checks shall be constructed with rolled excelsior, products from the Department’s approved list, or with aggregate placed on filter fabric when specified. Filter fabric shall be installed according to the requirements of Section 282. Riprap shall be placed according to Article 281.04. Manufactured ditch checks shall be installed according to the manufacturer’s specifications. Spacing of ditch checks shall be such that the low point in the center of one ditch check is at the same elevation as the base of the ditch check immediately upstream. Temporary ditch checks shall be sufficiently long enough that the top of the device in the middle of the ditch is lower than the bottom of the terminating ends of the ditch side slopes.”

Revise the last sentence of the first paragraph of Article 280.04(g) of the Standard Specifications to read:

“The temporary mulch cover shall be according to either Article 251.03 or 251.04 except for any reference to seeding.”

Revise Article 280.07(b) of the Standard Specifications to read:

“(b) Temporary Ditch Checks. This work will be measured for payment along the long axis of the device in place in feet (meters) except for aggregate ditch checks which will be measured for payment in tons (metric tons). Payment will not be made for aggregate in excess of 108 percent of the amount specified by the Engineer.”

Revise Article 280.07(f) of the Standard Specifications to read:

“(f) Temporary Mulch. This work will be measured for payment according to Article 251.05(b).”

Add the following paragraph after the ninth paragraph of Article 280.07 of the Standard Specifications:

“Temporary or permanent erosion control systems required for areas outside the limits of construction will not be measured for payment.”

Revise Article 280.08(b) of the Standard Specifications to read:

“(b) Temporary Ditch Checks. This work will be paid for at the contract unit price per foot (meter) for TEMPORARY DITCH CHECKS except for aggregate ditch checks which will be paid for at the contract unit price per ton (metric ton) for AGGREGATE DITCH CHECKS.”

Revise Article 280.08(f) of the Standard Specifications to read:

“(f) Temporary Mulch. Temporary Mulch will be paid for according to Article 251.06.”

Delete the tenth (last) paragraph of Article 280.08 of the Standard Specifications.

Revise the second sentence of the first paragraph of Article 1081.015(e) of the Standard Specifications to read:

“The upstream facing of the aggregate ditch check shall be constructed of gradation CA 3. The remainder of the ditch check shall be constructed of gradation RR 3.”

TRUCK MOUNTED/TRAILER MOUNTED ATTENUATORS (BDE)

Effective: January 1, 2010

Revise Article 701.03(k) of the Standard Specifications to read:

“(k) Truck Mounted/Trailer Mounted Attenuators 1106.02”

Revise Article 701.15(h) of the Standard Specifications to read:

“(h) Truck Mounted/Trailer Mounted Attenuators (TMA). TMA units shall have a roll ahead distance in the event of an impact. The TMA shall be between 100 and 200 ft (30 and 60 m) behind the vehicle ahead or the workers. This distance may be extended by the Engineer.

TMA host vehicles shall have the parking brake engaged when stationary.

The driver and passengers of the TMA host vehicle should exit the vehicle if the TMA is to remain stationary for 15 minutes or more in duration.”

Revise Article 1106.02(g) of the Standard Specifications to read:

“(g) Truck Mounted/Trailer Mounted Attenuators. The attenuator shall be a NCHRP 350 approved unit for Test Level 3. Test Level 2 may be used as directed by the Engineer for normal posted speeds less than or equal to 45 mph.”

WORKING DAYS (BDE)

Effective: January 1, 2002

The Contractor shall complete the work within 25 working days.

BITUMINOUS MATERIALS COST ADJUSTMENTS (BDE) (RETURN FORM WITH BID)

Effective: November 2, 2006

Revised: April 1, 2009

Description. Bituminous material cost adjustments will be made to provide additional compensation to the Contractor, or credit to the Department, for fluctuations in the cost of bituminous materials when optioned by the Contractor. The adjustments shall apply to permanent and temporary hot-mix asphalt (HMA) mixtures, bituminous surface treatments (cover and seal coats), and pavement preservation type surface treatments. The adjustments shall not apply to bituminous prime coats, tack coats, crack filling/sealing, or joint filling/sealing.

The bidder shall indicate on the attached form whether or not this special provision will be part of the contract and submit the completed form with his/her bid. Failure to submit the form, or failure to fill out the form completely, shall make this contract exempt of bituminous materials cost adjustments.

Method of Adjustment. Bituminous materials cost adjustments will be computed as follows.

$$CA = (BPI_P - BPI_L) \times (\%AC_V / 100) \times Q$$

- Where: CA = Cost Adjustment, \$.
BPI_P = Bituminous Price Index, as published by the Department for the month the work is performed, \$/ton (\$/metric ton).
BPI_L = Bituminous Price Index, as published by the Department for the month prior to the letting, \$/ton (\$/metric ton).
%AC_V = Percent of virgin Asphalt Cement in the Quantity being adjusted. For HMA mixtures, the % AC_V will be determined from the adjusted job mix formula. For bituminous materials applied, a performance graded or cutback asphalt will be considered to be 100% AC_V and undiluted emulsified asphalt will be considered to be 65% AC_V.
Q = Authorized construction Quantity, tons (metric tons) (see below).

For HMA mixtures measured in square yards: $Q, \text{ tons} = A \times D \times (G_{mb} \times 46.8) / 2000$. For HMA mixtures measured in square meters: $Q, \text{ metric tons} = A \times D \times (G_{mb} \times 24.99) / 1000$. When computing adjustments for full-depth HMA pavement, separate calculations will be made for the binder and surface courses to account for their different G_{mb} and % AC_V.

For bituminous materials measured in gallons: $Q, \text{ tons} = V \times 8.33 \text{ lb/gal} \times SG / 2000$
For bituminous materials measured in liters: $Q, \text{ metric tons} = V \times 1.0 \text{ kg/L} \times SG / 1000$

- Where: A = Area of the HMA mixture, sq yd (sq m).
D = Depth of the HMA mixture, in. (mm).
G_{mb} = Average bulk specific gravity of the mixture, from the approved mix design.
V = Volume of the bituminous material, gal (L).
SG = Specific Gravity of bituminous material as shown on the bill of lading.

Basis of Payment. Bituminous materials cost adjustments may be positive or negative but will only be made when there is a difference between the BPI_L and BPI_P in excess of five percent, as calculated by:

$$\text{Percent Difference} = \{(BPI_L - BPI_P) \div BPI_L\} \times 100$$

Bituminous materials cost adjustments will be calculated for each calendar month in which applicable bituminous material is placed; and will be paid or deducted when all other contract requirements for the work placed during the month are satisfied. The adjustments shall not apply during contract time subject to liquidated damages for completion of the entire contract.

RETURN WITH BID

**ILLINOIS DEPARTMENT
OF TRANSPORTATION**

**OPTION FOR
BITUMINOUS MATERIALS COST ADJUSTMENTS**

The bidder shall submit this completed form with his/her bid. Failure to submit the form, or failure to fill out the form completely, shall make this contract exempt of bituminous materials cost adjustments. After award, this form, when submitted, shall become part of the contract.

Contract No.: _____

Company Name: _____

Contractor's Option:

Is your company opting to include this special provision as part of the contract?

Yes No

Signature: _____ **Date:** _____

FUEL COST ADJUSTMENT (BDE) (RETURN FORM WITH BID)

Effective: April 1, 2009

Revised: July 1, 2009

Description. Fuel cost adjustments will be made to provide additional compensation to the Contractor, or a credit to the Department, for fluctuations in fuel prices when optioned by the Contractor. The bidder shall indicate on the attached form whether or not this special provision will be part of the contract and submit the completed form with his/her bid. Failure to submit the form or failure to indicate contract number, company name and sign and date the form shall make this contract exempt of fuel cost adjustments for all categories of work. Failure to indicate "Yes" for any category of work will make that category of work exempt from fuel cost adjustment.

General. The fuel cost adjustment shall apply to contract pay items as grouped by category. The adjustment shall only apply to those categories of work checked "Yes", and only when the cumulative plan quantities for a category exceed the required threshold. Adjustments to work items in a category, either up or down, and work added by adjusted unit price will be subject to fuel cost adjustment only when the category representing the added work was subject to the fuel cost adjustment. Added work paid for by time and materials will not be subject to fuel cost adjustment. Category descriptions and thresholds for application and the fuel usage factors which are applicable to each are as follows:

(a) Categories of Work.

- (1) Category A: Earthwork. Contract pay items performed under Sections 202, 204, and 206 including any modified standard or nonstandard items where the character of the work to be performed is considered earthwork. The cumulative total of all applicable item plan quantities shall exceed 25,000 cu yd (20,000 cu m). Included in the fuel usage factor is a weighted average 0.10 gal/cu yd (0.50 liters/cu m) factor for trucking.
- (2) Category B: Subbases and Aggregate Base Courses. Contract pay items constructed under Sections 311, 312 and 351 including any modified standard or nonstandard items where the character of the work to be performed is considered construction of a subbase or aggregate, stabilized or modified base course. The cumulative total of all applicable item plan quantities shall exceed 5000 tons (4500 metric tons). Included in the fuel usage factor is a 0.60 gal/ton (2.50 liters/metric ton) factor for trucking.
- (3) Category C: Hot-Mix Asphalt (HMA) Bases, Pavements and Shoulders. Contract pay items constructed under Sections 355, 406, 407 and 482 including any modified standard or nonstandard items where the character of the work to be performed is considered HMA bases, pavements and shoulders. The cumulative total of all applicable item plan quantities shall exceed 5000 tons (4500 metric tons). Included in the fuel usage factor is 0.60 gal/ton (2.50 liters/metric ton) factor for trucking.
- (4) Category D: Portland Cement Concrete (PCC) Bases, Pavements and Shoulders. Contract pay items constructed under Sections 353, 420, 421 and 483 including any modified standard or nonstandard items where the character of the work to be performed is considered PCC base, pavement or shoulder. The cumulative total of all applicable item plan quantities shall exceed 7500 sq yd (6000 sq m). Included in the fuel usage factor is 1.20 gal/cu yd (5.94 liters/cu m) factor for trucking.

(5) Category E: Structures. Structure items having a cumulative bid price that exceeds \$250,000 for pay items constructed under Sections 502, 503, 504, 505, 512, 516 and 540 including any modified standard or nonstandard items where the character of the work to be performed is considered structure work when similar to that performed under these sections and not included in categories A through D.

(b) Fuel Usage Factors.

English Units		
Category	Factor	Units
A - Earthwork	0.34	gal / cu yd
B – Subbase and Aggregate Base courses	0.62	gal / ton
C – HMA Bases, Pavements and Shoulders	1.05	gal / ton
D – PCC Bases, Pavements and Shoulders	2.53	gal / cu yd
E – Structures	8.00	gal / \$1000

Metric Units		
Category	Factor	Units
A - Earthwork	1.68	liters / cu m
B – Subbase and Aggregate Base courses	2.58	liters / metric ton
C – HMA Bases, Pavements and Shoulders	4.37	liters / metric ton
D – PCC Bases, Pavements and Shoulders	12.52	liters / cu m
E – Structures	30.28	liters / \$1000

(c) Quantity Conversion Factors.

Category	Conversion	Factor
B	sq yd to ton	0.057 ton / sq yd / in depth
	sq m to metric ton	0.00243 metric ton / sq m / mm depth
C	sq yd to ton	0.056 ton / sq yd / in depth
	sq m to metric ton	0.00239 m ton / sq m / mm depth
D	sq yd to cu yd	0.028 cu yd / sq yd / in depth
	sq m to cu m	0.001 cu m / sq m / mm depth

Method of Adjustment. Fuel cost adjustments will be computed as follows.

$$CA = (FPI_P - FPI_L) \times FUF \times Q$$

- Where: CA = Cost Adjustment, \$
 FPI_P = Fuel Price Index, as published by the Department for the month the work is performed, \$/gal (\$/liter)
 FPI_L = Fuel Price Index, as published by the Department for the month prior to the letting, \$/gal (\$/liter)
 FUF = Fuel Usage Factor in the pay item(s) being adjusted
 Q = Authorized construction Quantity, tons (metric tons) or cu yd (cu m)

The entire FUF indicated in paragraph (b) will be used regardless of use of trucking to perform the work.

Progress Payments. Fuel cost adjustments will be calculated for each calendar month in which applicable work is performed; and will be paid or deducted when all other contract requirements for the items of work are satisfied. The adjustments shall not apply during contract time subject to liquidated damages for completion of the entire contract.

Final Quantities. Upon completion of the work and determination of final pay quantities, an adjustment will be prepared to reconcile any differences between estimated quantities previously paid and the final quantities. The value for the balancing adjustment will be based on a weighted average of FPI_P and Q only for those months requiring the cost adjustment. The cost adjustment will be applicable to the final measured quantities of all applicable pay items.

Basis of Payment. Fuel cost adjustments may be positive or negative but will only be made when there is a difference between the FPI_L and FPI_P in excess of five percent, as calculated by:

$$\text{Percent Difference} = \{(FPI_L - FPI_P) \div FPI_L\} \times 100$$

Return With Bid

**ILLINOIS DEPARTMENT
OF TRANSPORTATION**

**OPTION FOR
FUEL COST ADJUSTMENT**

The bidder shall submit this completed form with his/her bid. Failure to submit the form or properly complete contract number, company name, and sign and date the form shall make this contract exempt of fuel cost adjustments in all categories. Failure to indicate "Yes" for any category of work at the time of bid will make that category of work exempt from fuel cost adjustment. After award, this form, when submitted shall become part of the contract.

Contract No.: _____

Company Name: _____

Contractor's Option:

Is your company opting to include this special provision as part of the contract plans for the following categories of work?

- Category A Earthwork. Yes
- Category B Subbases and Aggregate Base Courses Yes
- Category C HMA Bases, Pavements and Shoulders Yes
- Category D PCC Bases, Pavements and Shoulders Yes
- Category E Structures Yes

Signature: _____ **Date:** _____

**STATE OF ILLINOIS
DEPARTMENT OF TRANSPORTATION
DIVISION OF HIGHWAYS
SBI 9A(ROUTE OLD US 24)
WHEELER ROAD
SECTION 45RS-4
PEORIA COUNTY
C-94-040-10**

SHEET 1 OF 25
D-94-014-10



- INDEX OF SHEETS
- 1. COVER SHEET
 - 2-3. GENERAL NOTES
 - 4-8. SUMMARY OF QUANTITIES
 - 9-10. TYPICAL SECTIONS
 - 11-14. SCHEDULE OF QUANTITIES
 - 15-16. DROP STRUCTURE DETAILS
 - 17. PIPE UNDERDRAIN DETAIL
 - 18. LINE DIAGRAM
 - 19. PROPOSED PLAN AND PROFILE
 - 20-22. CROSS SECTIONS
 - 23-25. DISTRICT CADD STANDARDS

STANDARDS

- 280001-05 701301-03
- 442201-03 701306-02
- 542301-02 701311-03
- 542546-01 701901-01
- 601101-01 **BRZZ-6**



IMPROVEMENT ENDS
STA. 170+50

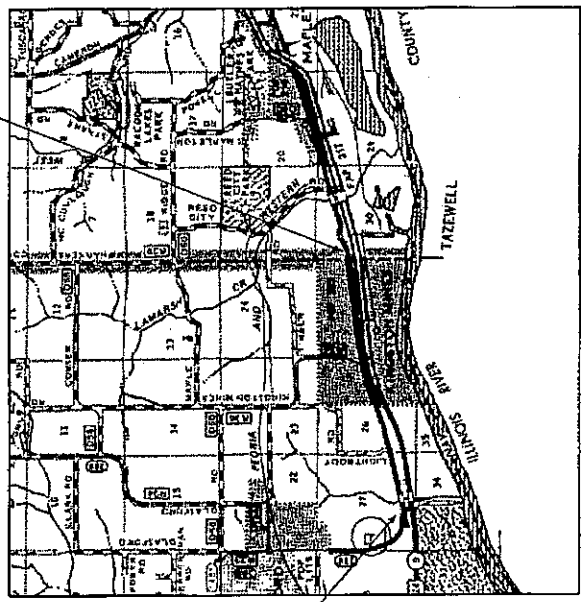

IMPROVEMENT BEGINS

STA. 0+00

ADT = 38
MU = 0%

CONTRACT NO. 68948
CATALOG NO. 034371-000

PROJECT DESCRIPTION

This project is approximately 3.1 miles long and consists of HMA binder, resurfacing, drainage improvements and other collateral work.

JULIE
JOINT UTILITY LOCATION INFORMATION FOR EXCAVATION
1-800-492-0123

STATE OF ILLINOIS
DEPARTMENT OF TRANSPORTATION
DIVISION OF HIGHWAYS

SUBMITTED *3/26/20* TO *19/20*

DEPUTY DIRECTOR OF HIGHWAYS, REGION ENGINEER

ENGINEER OF DESIGN AND ENVIRONMENT

DIRECTOR OF HIGHWAYS, CHIEF ENGINEER

PRINTED BY THE AUTHORITY OF THE STATE OF ILLINOIS

GROSS LENGTH = 17,050 FT = 3.1 Miles
NET LENGTH = 16,963 FT = 3.1 Miles

COMMITMENTS

Commitments are not to be altered without the written approval of all parties to which the commitment was made.

No Commitments have been made for this project

UTILITIES

Utility companies could not be notified of the proposed work in this area.

A J.U.L.I.E. locate must be performed prior to any digging. If conflicts are found, the contractor shall notify the Resident immediately.

PROPERTY OWNER ACCESS REQUIREMENTS

Access must be maintained to all existing properties during construction per Article 107.03 unless arrangements are made in writing by the Contractor with the property owners with a copy to the Engineer for short-term closures.

WINTER SHUTDOWN RESTRICTIONS ON COLD MILLED PROJECTS

Prior to winter shutdown the following steps shall be taken:

- All cold related surfaces shall be overlaid.
- All lanes shall be reopened to traffic.
- Manholes, where applicable, shall be adjusted to the elevation of the binder course/leveling binder to ease in plowing snow, and re-adjusted to finished grade in the Spring. The initial manhole adjustment will be paid for at the contract unit price and any re-adjustment, as directed by the Engineer, will be paid for in accordance with Article 108.04.
- Temporary or permanent pavement marking shall be placed as applicable.

AGGREGATE FOR DRIVEWAY REPLACEMENT

The material used for construction of permanent aggregate driveways shall be gravel or crushed stone as directed by the Engineer, to replace in kind the existing aggregate driveways.

No additional compensation shall be provided for this requirement but shall be considered as included in the cost of the pay item for the aggregate as specified on the plans.

ENVIRONMENTAL REVIEWS

Prior to the use of any proposed borrow areas, use areas (temporary access roads, ditches, run-arounds, etc.) and/or waste areas, the Contractor shall file the required environmental resources request surveys according to Section 107.22 of the Standard Specifications. These surveys are required in order for the Department to conduct cultural and biological resource surveys for the proposed site.

Prior to any waste materials being removed from the construction site the required environmental resource surveys will need to be obtained and filed by the Contractor. Excess waste products removed from the construction site shall be disposed of as required in Section 202.03 of the Standard Specifications.

Any protruding metal bars shall be removed prior to the disposal of broken concrete at approved disposal sites.

The required environmental resource documentation shall include the following:

- BDE Form 2289 (Environmental Survey Request)
- A location map showing the site limits and location of the use area
- Signed property owner agreement form-D4 P10100
- Color photographs depicting the use area
- Borrow Area Entry Agreement form-D4 P10101

Please note that a minimum of two weeks shall be allowed for the District to obtain the required environmental clearances.

TREE REMOVAL

The District Four Tree Committee should be contacted and prior approval obtained for any tree removal beyond the limits/locations included in the plans.

ADDITIONAL HOT-MIX ASPHALT OVERLAY IN LIEU OF PATCHING

An additional thickness of hot-mix asphalt overlay is being placed on this project to allow pavement patching to be either eliminated or reduced to a very limited quantity. The intent of this treatment is to minimize or eliminate the need for any pavement patching.

CROSSING EXISTING STRUCTURES WITH EQUIPMENT

The following structure SN 072-2034 may be crossed with a loaded MTD. Any structures not listed shall be verified by the resident prior to beginning work.

STATE OF ILLINOIS
DEPARTMENT OF TRANSPORTATION

GENERAL NOTES

ROUTE	SECTION	COUNTY	SHEET
S.B.I. 9A	45RS-4	PEORIA	TOTAL
MKD. 0TH	CONTRACT NO. 68948		24
			2

BUTT JOINT CUTTING TIME RESTRICTION

Butt joints shall not be milled more than three (3) days prior to placement of the bituminous surface course.

PAVING SURFACE COURSE

Continuous paving operations on the main roadway shall be maintained at all times during the construction of the hot-mix asphalt surface. No interruptions for side roads, entrances, turn lanes, etc. will be allowed.

ORDERING LENGTH CONFIRMATION - DRAINAGE ITEMS

The Contractor shall consult with the Engineer in regard to the exact length of the box/pipe culverts, storm sewers, and/or pipe drains required prior to ordering these items.

ENGINEERS FIELD OFFICE

Add the following sentence to the end of paragraph 670.02 (f) and 670.04 (e):
All of the telephone lines provided shall have unpublished numbers.

AGGREGATE SHOULDERS, TYPE B

Aggregate Shoulders, Type B shall be required for all granular construction of side roads, entrances, and mailbox turnouts, whether or not portions of the surfaces thus constructed are to be covered with a bituminous surface, except where noted differently on the plans.

PAVEMENT STATIONING NUMBERS & PLACEMENT

The Contractor shall provide labor and materials required to imprint pavement station numbers in the finished surface of the pavement and/or overlay. The numbers shall be approximately 3/4 inch (20mm) wide, 5 inches (125 mm) high and 5/8 inch (15 mm) deep.

The pavement station numbers shall be installed as specified herein:

Interval - 200 feet (English stationing) or 100 meters (metric stationing)

Bottom of Numbers - 6 inches (150 mm) from the inside edge of the pavement marking

Location:

- 2, 3, & 5 Lane Pavements - right edge of pavement in direction of increasing stations
- Multi-Lane Divided Roadways - outside edge of pavement in both directions
- Ramps - along baseline edge of pavement

Position - stations shall be placed so they can be read from the adjacent shoulder

Format - English (Metric) pavement stations shall use this format "XXX (XX+X00)" where X represents the pavement station

This work will not be paid for separately, but will be considered included in the cost of the associated pavement and/or overlay pay items.

NO PASSING ZONE VERIFICATION

The resident shall contact Operations to verify the location of no passing zones prior to the placement of cantline striping.

HOT-MIX ASPHALT MIXTURE REQUIREMENTS

Mixture Use(s)	Surface Course	Binder Course (1/2" top size)	Incidental Surface Course	HMA Base Course & C/D Patch
AC/PGs	PG 64-22	PG 64-22	PG 64-22	PG 64-22
RAP% (Max) **	15%	25%	15%	25%
Design Air Voids	4.0% @ N=50	4.0% @ N=50	4.0% @ N=50	4.0% @ N=50
Mixture Composition (Gradation Mixture)	IL 9.5 or IL12.5	IL 12.5 Only	IL 9.5 or IL12.5	IL 19.0
Friction Aggregate	Mixture D	N.A.	Mixture C	N.A.

STATE OF ILLINOIS
DEPARTMENT OF TRANSPORTATION

GENERAL NOTES

ROUTE	SECTION	COUNTY	SHEET
S.B.L. 9A	45RS-4	PEORIA	TOTAL NO.
AKD. 0TH	CONTRACT NO.	68948	24
			3

Summary of Quantities

Code Order

ROUTE		SECTION	COUNTY	SHEET	
SBI	9A	45RS-4	PEORIA	TOTAL	NO.
OTH				25	4
CONTRACT NO.			68948		

CODE No.	ITEM	UNIT	Tot.QTY	CONSTRUCTION TYPE CODE	
				STATE	
				100%	
				1000	

20201006	GRADING AND SHAPING SHOULDERS	UNIT	339		339
20201200	REMOVAL AND DISPOSAL OF UNSUITABLE MATERIAL	CU YD	67		67
20800150	TRENCH BACKFILL	CU YD	9		9
21001000	GEOTECHNICAL FABRIC FOR GROUND STABILIZATION	SQ YD	204		204
21400100	GRADING AND SHAPING DITCHES	FOOT	1540		1540
28000305	TEMPORARY DITCH CHECKS	FOOT	60		60
28000500	INLET AND PIPE PROTECTION	EACH	4		4
31101100	SUB-BASE GRANULAR MATERIAL, TYPE B	CU YD	33.3		33.3
31102000	SUB-BASE GRANULAR MATERIAL, TYPE C	CU YD	40		40
35501320	HOT - MIX ASPHALT BASE COURSE, 9"	SQ YD	100		100

Summary of Quantities

Code Order

ROUTE		SECTION		COUNTY		SHEET	
SBI	9A	45RS-4		PEORIA		TOTAL	NO.
OTH						25	5
CONTRACT NO.				68948			

CONSTRUCTION TYPE CODE	STATE		
	100%		
	1000		
CODE No.	ITEM	UNIT	Tot.QTY

40200800	AGGREGATE SURFACE COURSE, TYPE B	TON	86	86
40600215	POLYMERIZED BITUMINOUS MATERIALS (PRIME COAT)	TON	11	11
40600895	CONSTRUCTING TEST STRIP	EACH	1	1
40600982	HOT - MIX ASPHALT SURFACE REMOVAL - BUTT JOINT	SQ YD	381	381
40600990	TEMPORARY RAMP	SQ YD	280	280
40603000	HOT - MIX ASPHALT BINDER COURSE, IL - 12.5, N50	TON	5772	5772
40603335	HOT - MIX ASPHALT SURFACE COURSE, MIX "D", N50	TON	2850	2850
40800050	INCIDENTAL HOT - MIX ASPHALT SURFACING	TON	219	219
44000100	PAVEMENT REMOVAL	SQ YD	100	100
44000400	GUTTER REMOVAL	FOOT	100	100

Summary of Quantities

Code Order

ROUTE		SECTION		COUNTY		SHEET	
SBI	9A	45RS-4		PEORIA		TOTAL	NO.
OTH						25	6
				CONTRACT NO. 68948			

CODE No.	ITEM	UNIT	Tot.QTY	CONSTRUCTION TYPE CODE	
				STATE	
				100%	
				1000	

CODE No.	ITEM	UNIT	Tot.QTY	SQ YD	TON	EACH	FOOT	CONC.	FLARED END SECTIONS	24"	FOOT	EACH	FOOT	EACH	FOOT	CONCRETE	HEADWALL FOR PIPE DRAINS	PIPE UNDERDRAINS	4"	PIPE UNDERDRAINS	4" (SPECIAL)	FRAMES AND LIDS, SPECIAL	CONCRETE GUTTER, TYPE A (MODIFIED)	ENGINEER'S FIELD OFFICE, TYPE A
44201821	CLASS D PATCHES, TYPE IV, 14 INCH		50	50																				
48101200	AGGREGATE SHOULDERS, TYPE B		1184		1184																			
54213669	PRECAST REINF. CONC. FLARED END SECTIONS 24"		1			1																		
542A1069	PIPE CULVERTS, CLASS A, TYPE 2 24"		54				54																	
60100060	CONCRETE HEADWALL FOR PIPE DRAINS		1			1																		
60107600	PIPE UNDERDRAINS 4"		18																					
60108100	PIPE UNDERDRAINS 4" (SPECIAL)		20																					
60406500	FRAMES AND LIDS, SPECIAL		1			1																		
60602600	CONCRETE GUTTER, TYPE A (MODIFIED)		100																					
67000400	ENGINEER'S FIELD OFFICE, TYPE A		2																					

Summary of Quantities

Code Order

ROUTE		SECTION	COUNTY	SHEET	
SBI	9A	45RS-4	PEORIA	TOTAL	NO.
OTH				25	7
CONTRACT NO.			68948		

CONSTRUCTION TYPE CODE	
STATE	
100%	
1000	

CODE No.	ITEM	UNIT	Tot.QTY	CONSTRUCTION TYPE CODE
67100100	MOBILIZATION	L SUM	1	1
70100460	TRAFFIC CONTROL AND PROTECTION, STANDARD 701306	L SUM	1	1
70101835	TRAFFIC CONTROL AND PROTECTION, STANDARD BLR 22	L SUM	1	1
70300100	SHORT-TERM PAVEMENT MARKING	FOOT	6531	6531
70300220	TEMPORARY PAVEMENT MARKING - LINE 4"	FOOT	44751	44751
70300280	TEMPORARY PAVEMENT MARKING - LINE 24"	FOOT	66	66
70301000	WORK ZONE PAVEMENT MARKING REMOVAL	SQ FT	702	702
X 78001110	PAINT PAVEMENT MARKING - LINE 4"	FOOT	44751	44751
X 78001180	PAINT PAVEMENT MARKING - LINE 24"	FOOT	66	66
X0322729	MATERIAL TRANSFER DEVICE	TON	2,850	2,850
X0323660	DROP BOX NO.1	EACH	1	1

Summary of Quantities

Code Order

ROUTE		SECTION		COUNTY	SHEET	
		SBI	9A		PEORIA	TOTAL
OTH					25	8
				CONTRACT NO.	68948	

CODE No.	ITEM	UNIT	Tot.QTY	CONSTRUCTION TYPE CODE	
				STATE	
				100%	
				1000	

X2503100	MOWING	UNIT	339		339

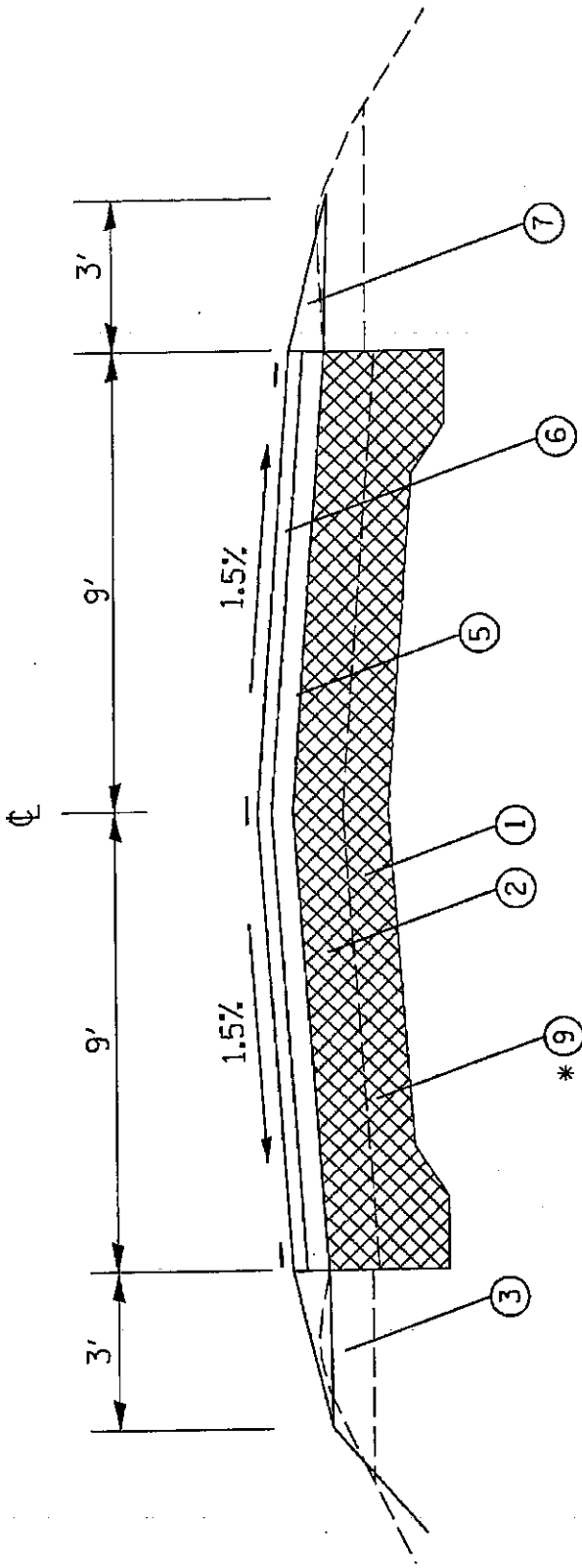

0+00 to 170+50

* 87+75 to 88+25

GLASFORD RD TO JUST SOUTH OF REED CITY RD
(APPROX. 3.07 MILES)

EXISTING ITEMS

- 1. EXISTING PAVEMENT
- 2. BITUMINOUS OVERLAY
- 3. EARTH SHOULDER
- 4. EXISTING GUTTER

PROPOSED ITEMS

- 5. HMA BINDER 2 1/4"
- 6. HMA SURFACE COURSE 1 1/2", MIX "D", N50
- 7. AGGREGATE SHOULDERS, TYPE B
- 8. CONCRETE GUTTER, TYPE A (MODIFIED)
- 9. PAVEMENT REMOVAL *
- 10. GUTTER REMOVAL

STATE OF ILLINOIS DEPARTMENT OF TRANSPORTATION	TYPICAL SECTIONS		ROUTE	SECTION	COUNTY	SHEET
			S.B.L. 9A	45RS-4	PEORIA	TOTAL NO.
			MKD. OTH	CONTRACT NO.	6894B	25
						9

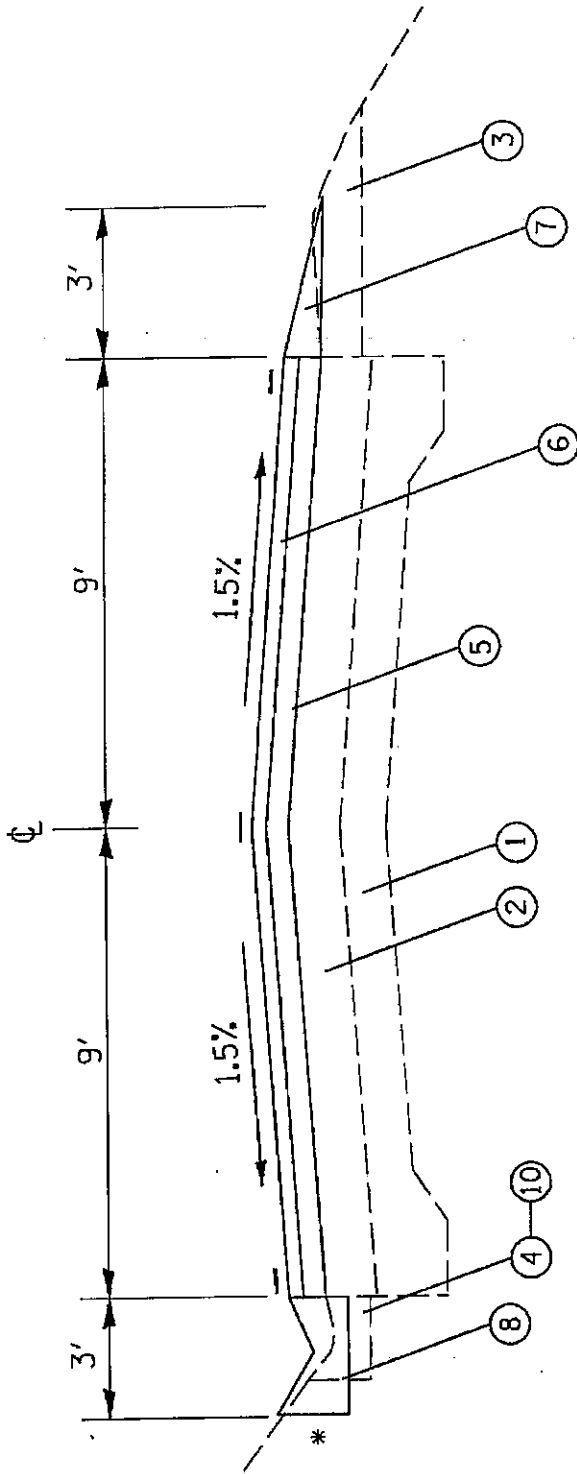

EXISTING ITEMS

1. EXISTING PAVEMENT
2. BITUMINOUS OVERLAY
3. EARTH SHOULDER
4. EXISTING GUTTER

PROPOSED ITEMS

5. HMA BINDER 2 1/4"
6. HMA SURFACE COURSE 1 1/2", MIX "D", N50
7. AGGREGATE SHOULDERS, TYPE B
8. CONCRETE GUTTER, TYPE A (MODIFIED)
9. PAVEMENT REMOVAL
10. GUTTER REMOVAL

LT. STA. 86+15 TO 87+15

* New concrete gutter will tie into existing outlet

STATE OF ILLINOIS DEPARTMENT OF TRANSPORTATION		TYPICAL SECTIONS		COUNTY PEORIA	SHEET TOTAL NO. 25 10
		ROUTE S.B.L. 9A MKD. 10TH	SECTION 45RS-4		
				CONTRACT NO. 6894B	

RESURFACING SCHEDULE

LOCATION	LENGTH		WIDTH		AREA SQ. YD.	POLY BIT. MATLS PRIMECOAT		HMA SURF. MIX D N50 1.5" TON	HMA BIND. CSE IL 12.5 N50 TON	INCIDENTAL HMA SURF TON	HMA SURF REM BUTT JOINTS SQ. YD.
	FT		FT			TON					
0+00 to 0+30	30		18		60.0	0.02	5.0	7.6			60.0
0+30 to 3+79	349		18		698.0	0.22	58.6	87.9			
3+79 to 4+09	30		18		60.0	0.02	5.0	7.6			60.0
BRIDGE OMISSION											
4+96 to 5+26	30		18		60.0	0.02	5.0	7.6			60.0
5+26 to 170+50	16524		18		33048.0	10.58	2776.0	4164.0			60.0
Various Build-up Locations											
Sideroads/Entrances											
Access Rd 15+83 Rt	437.5		18		875.0	0.18		110.25		73.50	12.00
Access Rd 62+43 Rt	225		18		450.0	0.09		56.70		37.80	12.00
P.E. 66+12 Lt	VAR		20		33.3	0.01				4.9	6.67
Kingston Mines Rd 85+57 Rt & Lt	100		18		200.0	0.04		25.20		16.80	12.00
P.E. 93+41 Lt	VAR		20		33.3	0.01				4.9	6.67
P.E. 95+00 Lt	VAR		20		33.3	0.01				4.9	6.67
P.E. 101+12 Lt	VAR		20		33.3	0.01				4.9	6.67
P.E. 105+81 Lt	VAR		20		33.3	0.01				4.9	6.67
P.E. 108+27 Lt	VAR		20		33.3	0.01				4.9	6.67
P.E. 107+98 Lt	VAR		20		33.3	0.01				4.9	6.67
P.E. 108+55 Lt	VAR		20		33.3	0.01				4.9	6.67
Access Rd 110+48 Rt	87.5		18		175.0	0.04		22.05		25.5	12.00
P.E. 118+68 Lt	VAR		20		33.3	0.01				4.9	6.67
P.E. 121+45 Lt	VAR		20		33.3	0.01				4.9	6.67
P.E. 122+81 Lt	VAR		20		33.3	0.01				4.9	6.67
P.E. 130+59 Lt	VAR		20		33.3	0.01				4.9	6.67
P.E. 149+96 Lt	VAR		20		33.3	0.01				4.9	6.67
Mailbox Turnout					16.7	0.01				2.4	6.67
TOTALS						11	2,860	5,772	219	381	381

STATE OF ILLINOIS DEPARTMENT OF TRANSPORTATION	SCHEDULE OF QUANTITIES				COUNTY	SHEET
	ROUTE	SECTION	CONTRACT NO.	PEORIA	TOTAL	NO.
	S.B.L. 9A	45RS-4	68948		25	11
	MKD. OTH					

Temporary Ramp	
LOCATION	SQ YD
Rt & Lt 0+00 to 170+50	280
TOTAL	280

Aggregate Shoulders Ty B	
LOCATION	TON
Rt & Lt 0+00 to 170+50	1184
TOTAL	1,184

Aggregate Surface Course, Ty B	
LOCATION	TON
Various Driveways (19 Locations)	88
TOTAL	88

Short-Term Pavement Marking	
LOCATION	FOOT
Rt & Lt 0+00 to 170+50	6531
TOTAL	6,531

Work Zone Pavement Marking Removal	
LOCATION	SQ FT
Rt & Lt 0+00 to 170+50	702
TOTAL	702

Paint Pavement Marking Line			
Temporary Pavement Marking Line			
LOCATION	WHITE 24" FEET	YELLOW 4" FEET	WHITE 4" FEET
Rt & Lt 0+00 to 170+50	66	10352	34399
SUBTOTALS	66	10352	34399
TOTALS	66	44,751	

Traffic Control & Protection, Standard 701306	
LOCATION	L SUM
Jobsite	1
TOTAL	1

Engineer's Field Office Type A	
LOCATION	CAL MO
Jobsite	2
TOTAL	2

Traffic Control & Protection, Standard BLR 22	
LOCATION	L SUM
Rt & Lt 21+23 & 87+75	2
TOTAL	2

Gutter Removal	
LOCATION	FOOT
Lt 86+15 to 87+15	100
TOTAL	100

Constructing Teest Strip	
LOCATION	EACH
Jobsite	1
TOTAL	1

Mobilization	
LOCATION	L SUM
Jobsite	1
TOTAL	1

Drop Box No. 1	
LOCATION	EACH
Lt 21+23	1
TOTAL	1

Concrete Gutter, Ty A (modified)	
LOCATION	FOOT
Lt 86+15 to 87+15	100
TOTAL	100

STATE OF ILLINOIS
DEPARTMENT OF TRANSPORTATION

SCHEDULE OF QUANTITIES

ROUTE	SECTION	COUNTY	SHEET
S.B.L. 9A	45RS-4	PEORIA	TOTAL
MKD. 10TH	CONTRACT NO. 6894B		25 12

Subbase Granular Material Ty C	
LOCATION	CY
Rt & Lt 87+75 to 88+25	40
TOTAL	40

Trench Backfill	
LOCATION	CU YD
Rt & Lt 21+23	9
TOTAL	9

Frames and Lids, Special	
LOCATION	EACH
Rt 17+50	1
TOTAL	1

HMA Base Course 9"	
LOCATION	SY YD
Rt & Lt 87+75 to 88+25	100
TOTAL	100

Temporary Ditch Checks	
LOCATION	FOOT
Lt 21+23 to 29+33	30
Lt 31+93 to 34+93	15
Lt 40+43 to 42+83	15
TOTAL	60

Pavement Removal	
LOCATION	SQ YD
Rt & Lt 87+75 to 88+25	100
TOTAL	100

Inlet And Pipe Protection	
LOCATION	EACH
Lt 21+23	1
Lt 34+93	1
Lt 87+47	1
Lt 89+40	1
TOTAL	4

Aggregate Surface Course, Ty B	
LOCATION	TON
Various Driveways (19 Locations)	86
TOTAL	86

Concrete Headwall For Pipe Drains	
LOCATION	EACH
Rt 88+00	1
TOTAL	1

Mowing	
LOCATION	UNIT
Rt & Lt 0+00 to 170+50	339
TOTAL	339

STATE OF ILLINOIS DEPARTMENT OF TRANSPORTATION		SCHEDULE OF QUANTITIES		COUNTY		SHEET	
		ROUTE	SECTION	PEORIA	TOTAL	NO.	
		S.B.L. 9A	45RS-4			25	14
		MKD. OTH	CONTRACT NO. 68948				

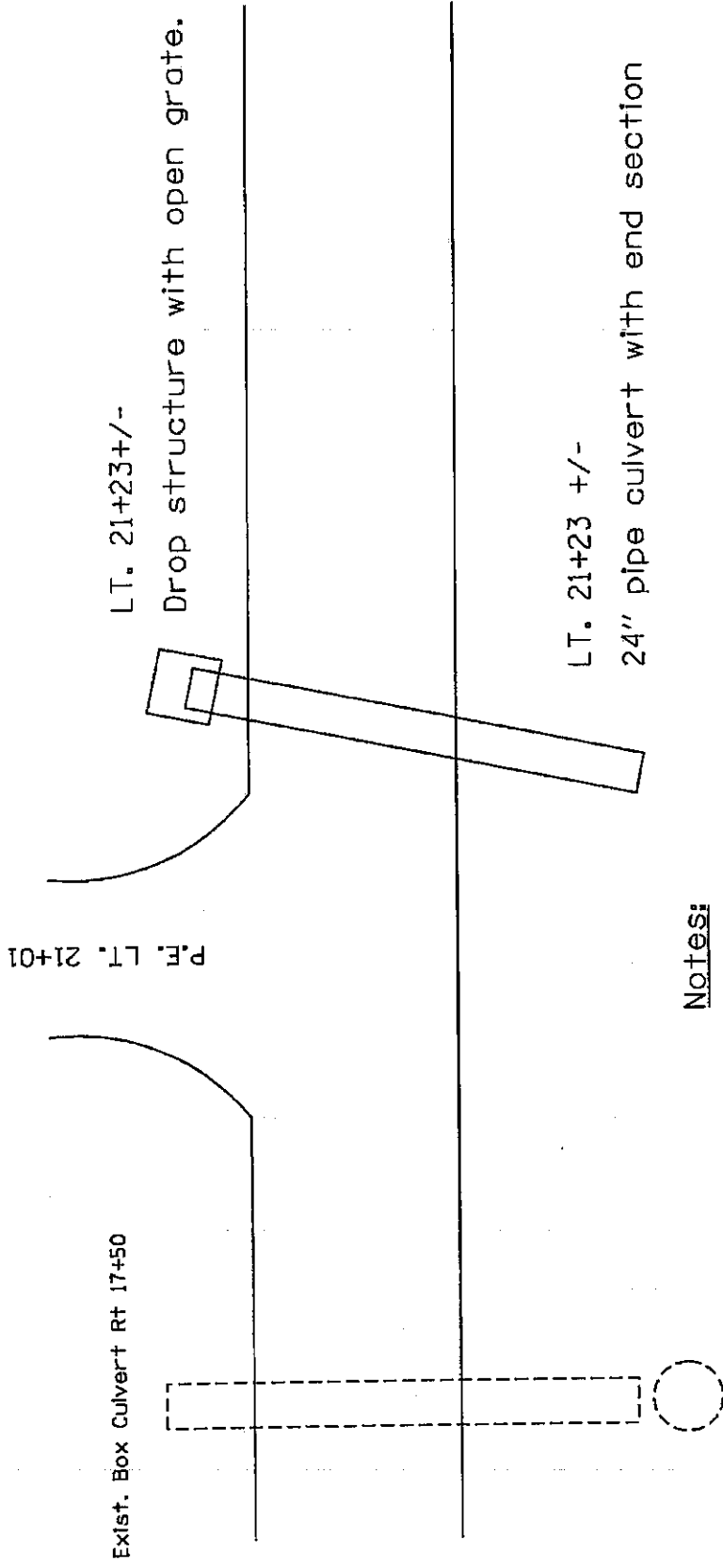

Notes:

1. Grade existing entrance to drain towards drop structure.
2. Resident may adjust angle of pipe culvert as needed to clear any unforeseen issues.
3. This work shall be performed in accordance with section 503 of the standard specifications.
4. Rt 17+50 drop structure has some undermining developing. Contractor shall fill this area with CLSM or by a method approved by the Engineer. This work will be paid for as specified in Article 109.04 of the Standard Specifications.
5. Recommended frame and lid is Neenah R-2565 series. Another lid may be used if approved by Engineer.

Exist. Drop Structure Rt 17+50
 - New frame and lid required

STATE OF ILLINOIS DEPARTMENT OF TRANSPORTATION	DROP STRUCTURE DETAIL		ROUTE	SECTION	COUNTY	SHEET
	S.B.L.	9A	45RS-4	PEORIA	TOTAL	NO.
	MKD.	OTH	CONTRACT NO.	68948	25	15

PLAN

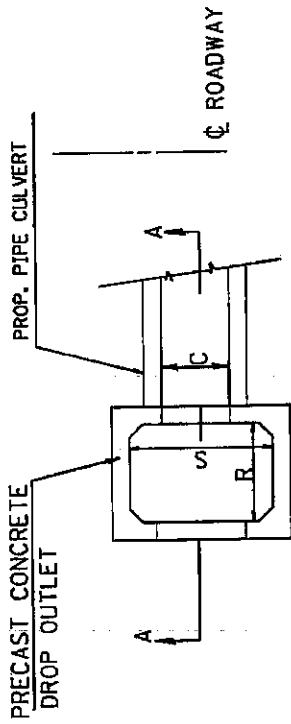

SECTION THRU DROP BOX

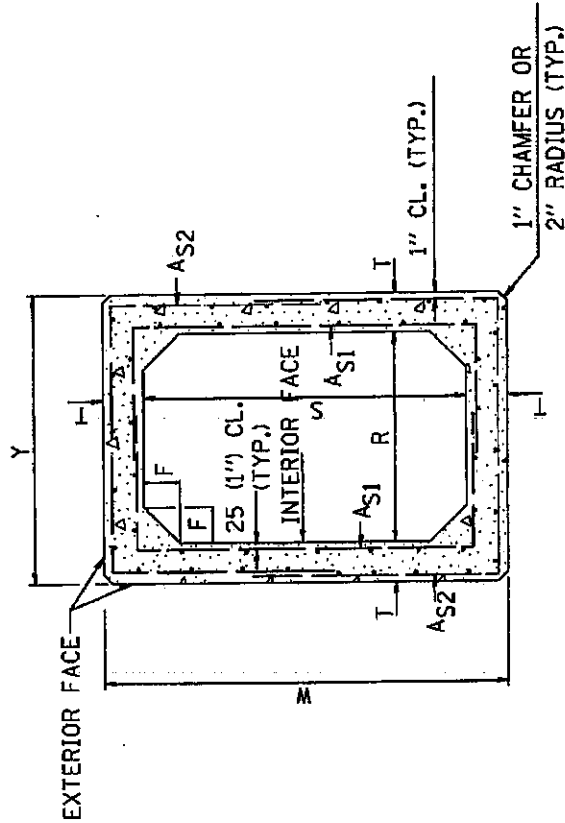

DIMENSIONS

S x R	T	W	Y	F	A-S1	A-S2
3' X 3'	6"	4'-0"	4'-0"	4"	0.10	0.10

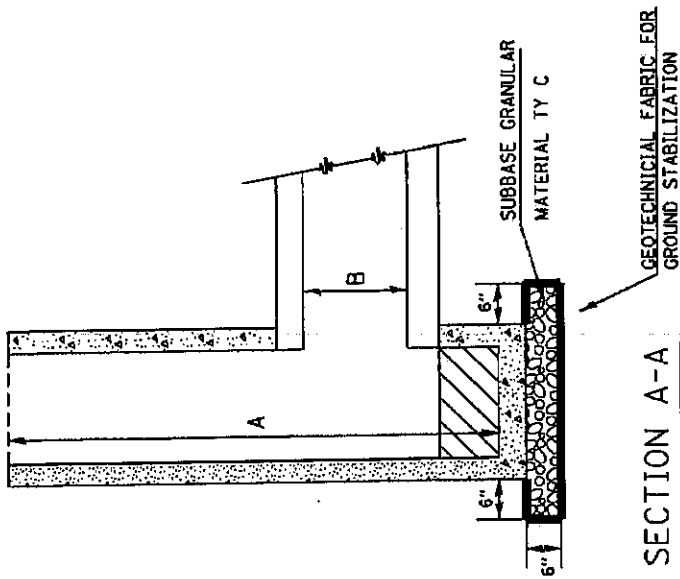

SECTION A-A

NOTE:

1. THE BOTTOM OF THE DROP BOX SHALL BE FILLED WITH CONCRETE. THE WORK AND MATERIAL SHALL BE INCLUDED IN THE COST OF THE DROP BOX.
2. THE TERMS A-S1 & A-S2 DENOTES THE MINIMUM REQUIRED STEEL AREAS FOR REINFORCEMENT AS SPECIFIED IN ASTM C 789. REINFORCEMENT SHALL BE WELDED WIRE FABRIC CONFORMING TO ASTM SPECIFICATION A185.
3. THIS WORK SHALL BE PERFORMED IN ACCORDANCE WITH SECTION 503 OF THE STANDARD SPECIFICATION.

LOCATION	DROP BOX SIZE	PIPE CULV. SIZE	A	SUBBASE GRANULAR MATERIAL	GEOTECH. FABRIC
LT. STA. 21+23	3' X 3'	24"	6'-0"	0.7	4.0

*FRAME AND GRATE USED SHALL BE ACCORDING TO HIGHWAY STD. 5425-46
THE FRAME AND GRATE SHALL BE INCLUDED IN THE COST OF DROP BOX.

PLAN VIEW

Stg. 87+75 Stg. 88+25

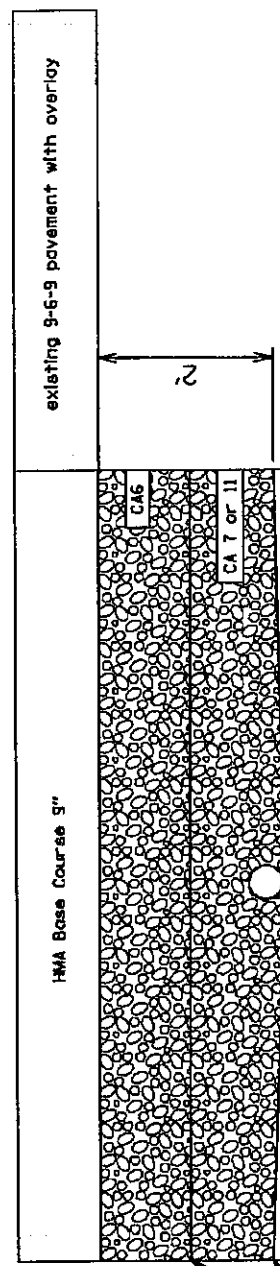
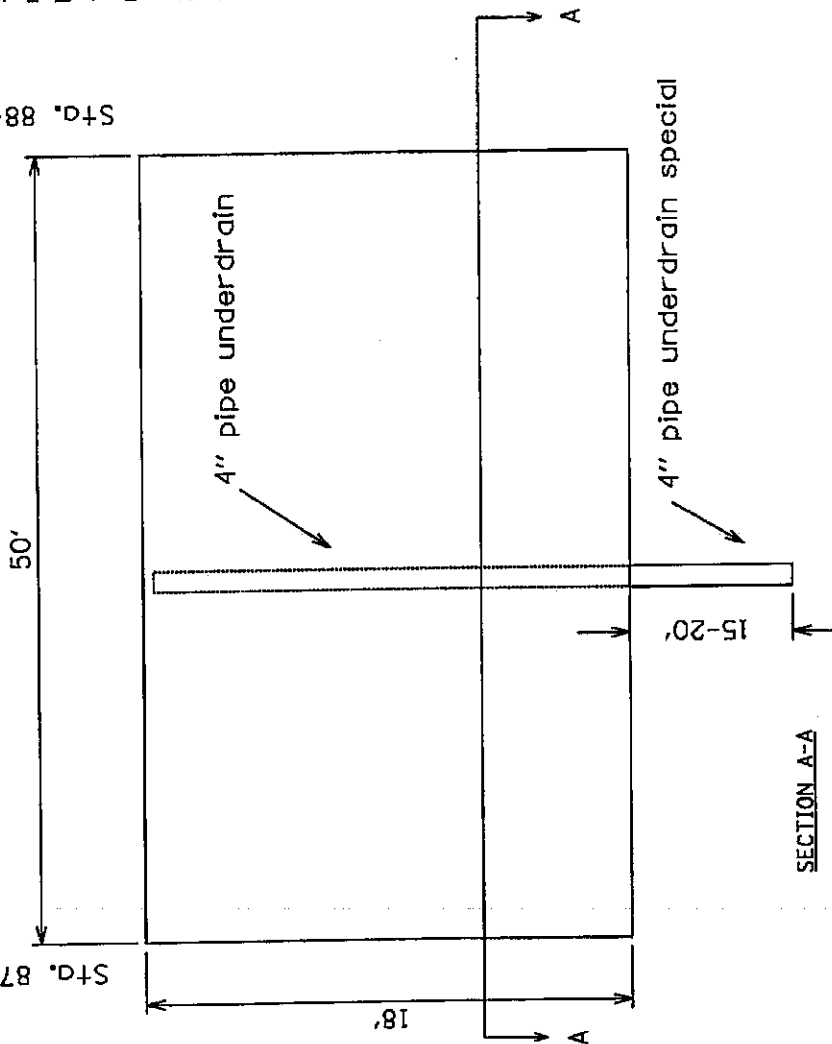

Geotechnical fabric for ground stabilization

NOTES:

1. Undercut roadway 2' below existing pavement. Depth may need to be adjusted in field. Undercut depth will be verified by DCP. Resident may contact Darren Reents for assistance. Additional undercut and materials, if required shall be paid as per pay item specified.
2. Proposed CA 7 or 11 (crushed stone) shall be paid for as Sub-base Granular Material Ty C.
3. Proposed CA 6 shall be paid for as Sub-base Granular Material Ty B.
4. Pipe underdrain shall be outlet approximately 2' above the flowline of US 24 ditch.

STATE OF ILLINOIS DEPARTMENT OF TRANSPORTATION		ROUTE S.B.I. 9A M.K.D. DTH		SECTION 45RS-4	COUNTY PEORIA	SHEET TOTAL NO.
PIPE UNDERDRAIN DETAIL		CONTRACT NO. 68948				25 17

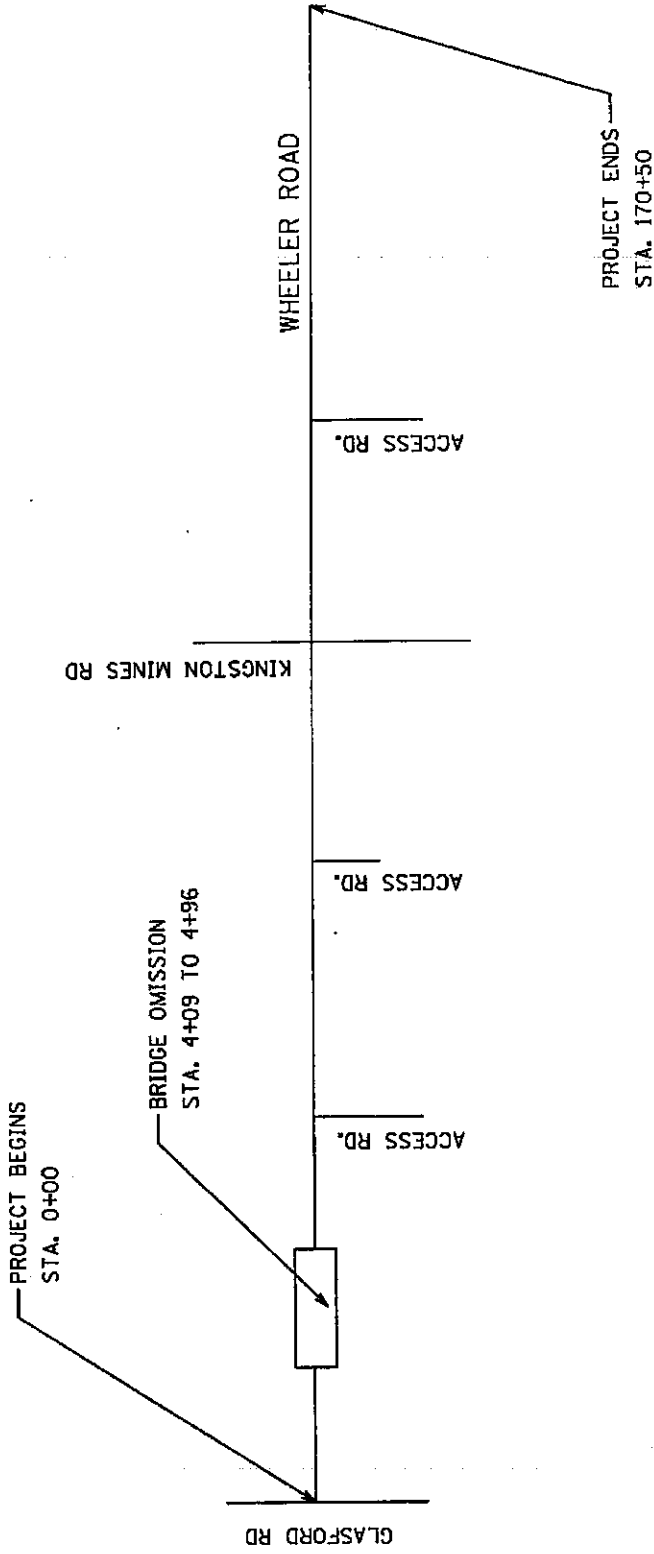

STATE OF ILLINOIS
DEPARTMENT OF TRANSPORTATION

LINE DIAGRAM

ROUTE	SECTION	COUNTY	SHEET
S.B.I. 9A	45RS-4	PEORIA	TOTAL
MKD. 1 OTH	CONTRACT NO. 68948		25 18

PLAN	NO. 1
DATE	
DRAWN BY	
CHECKED BY	

PROJECT	NO. 1
DATE	
DRAWN BY	
CHECKED BY	

75

70

65

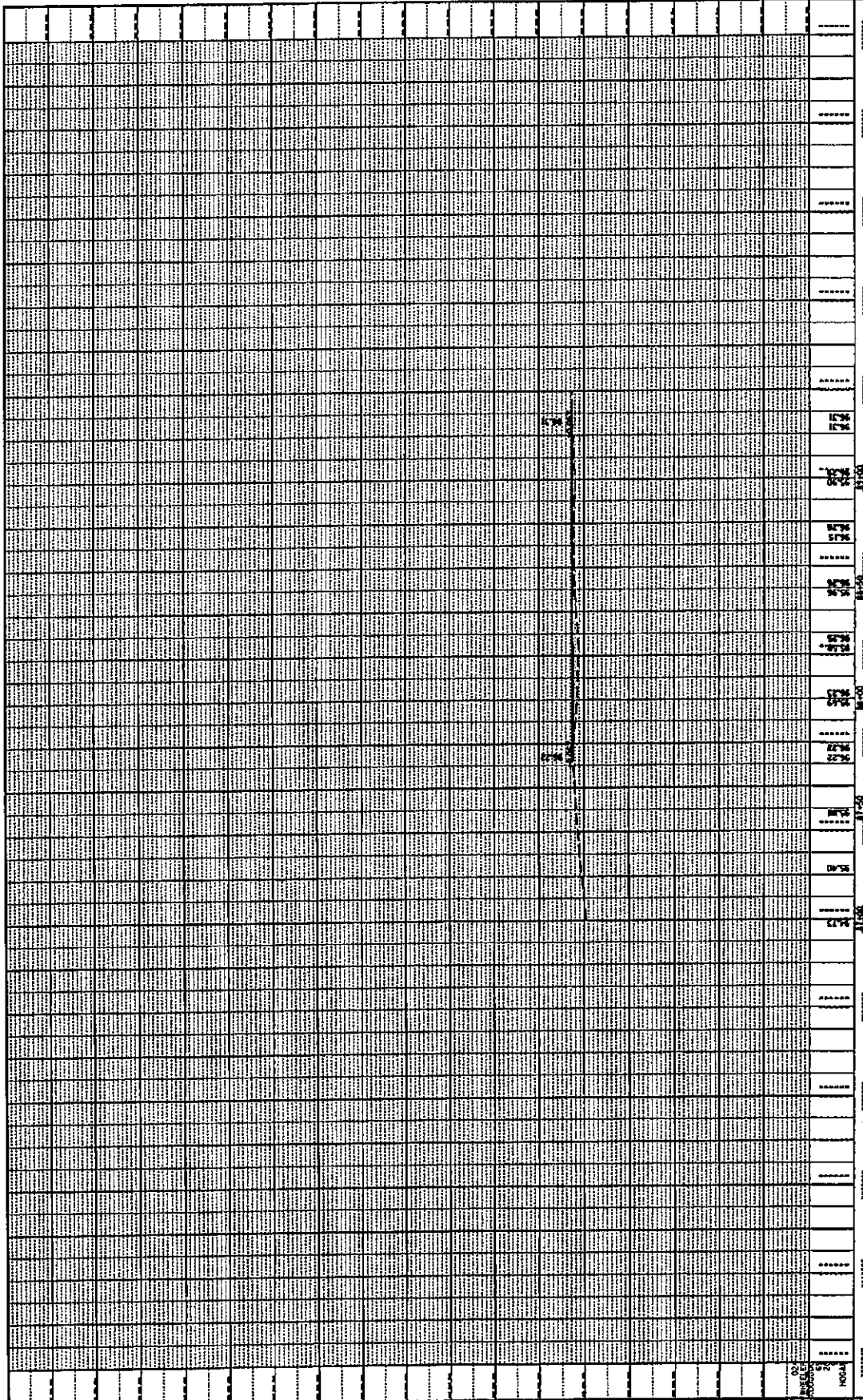

FILE NAME		DESIGNED BY		REVISIONS	
DATE		CHECKED BY		REVISIONS	
		DATE			
STATE OF ILLINOIS DEPARTMENT OF TRANSPORTATION					
PROJECT NO. 1			PROPOSED PROFILE 17+75 TO 24+40		
SHEET NO. 12			CONTRACT NO. 8848		
DATE			SCALE		

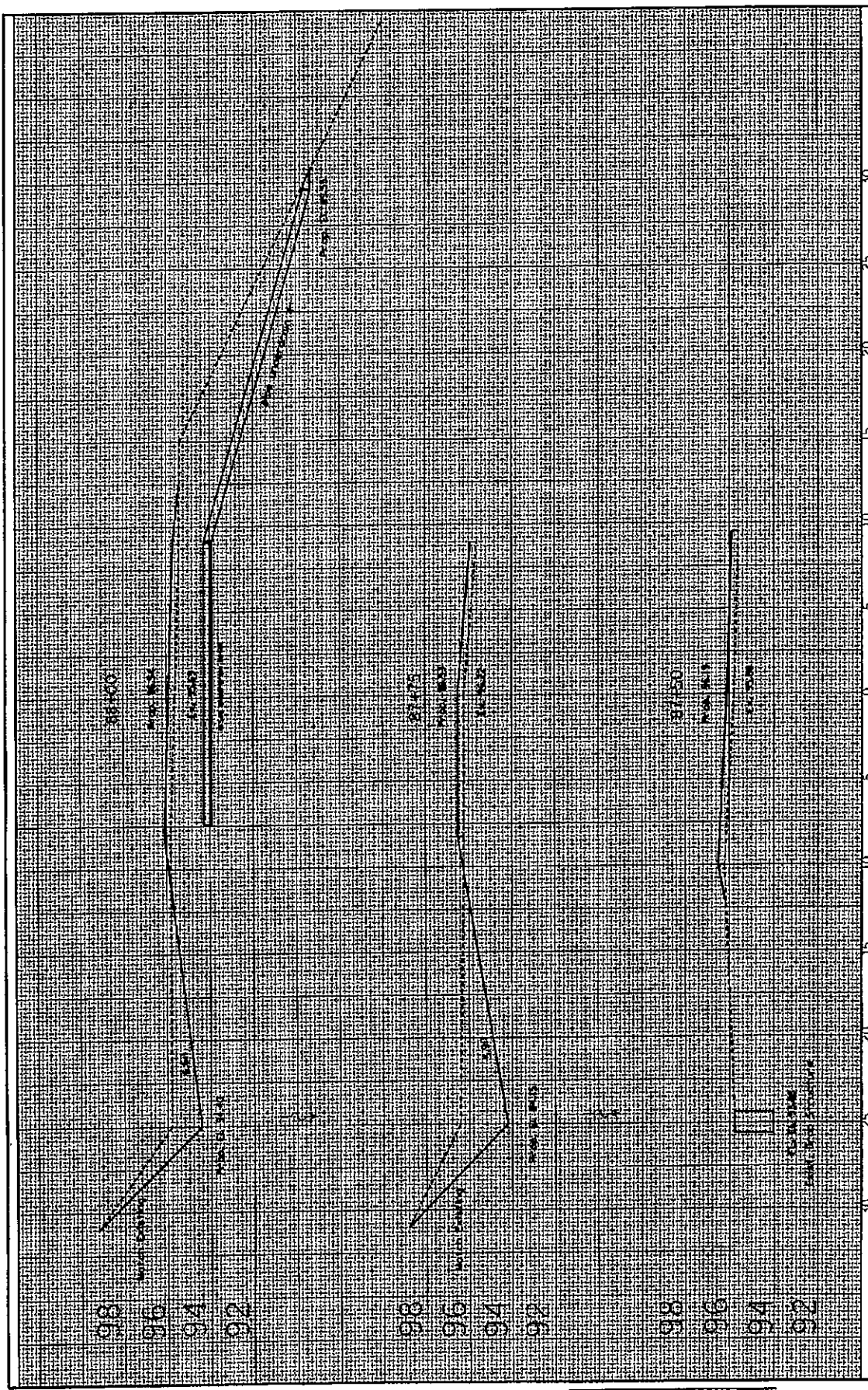

NO.	DATE	BY	REVISION

NO.	DATE	BY	REVISION

SHEET NO. OF 245 1/2 S.W. 31 S. 24 E. 1/4 S.E. 31 S.		COUNTY PULASKI MO.	
WHEELER RD 47+28 to 51+00		SECTION 18 T4N R9E	
STATE OF ILLINOIS DEPARTMENT OF TRANSPORTATION		CONTRACT NO. 8498	

98
 96
 94
 92

98
 96
 94
 92

98
 96
 94
 92

0 5 10 15 20 25 30

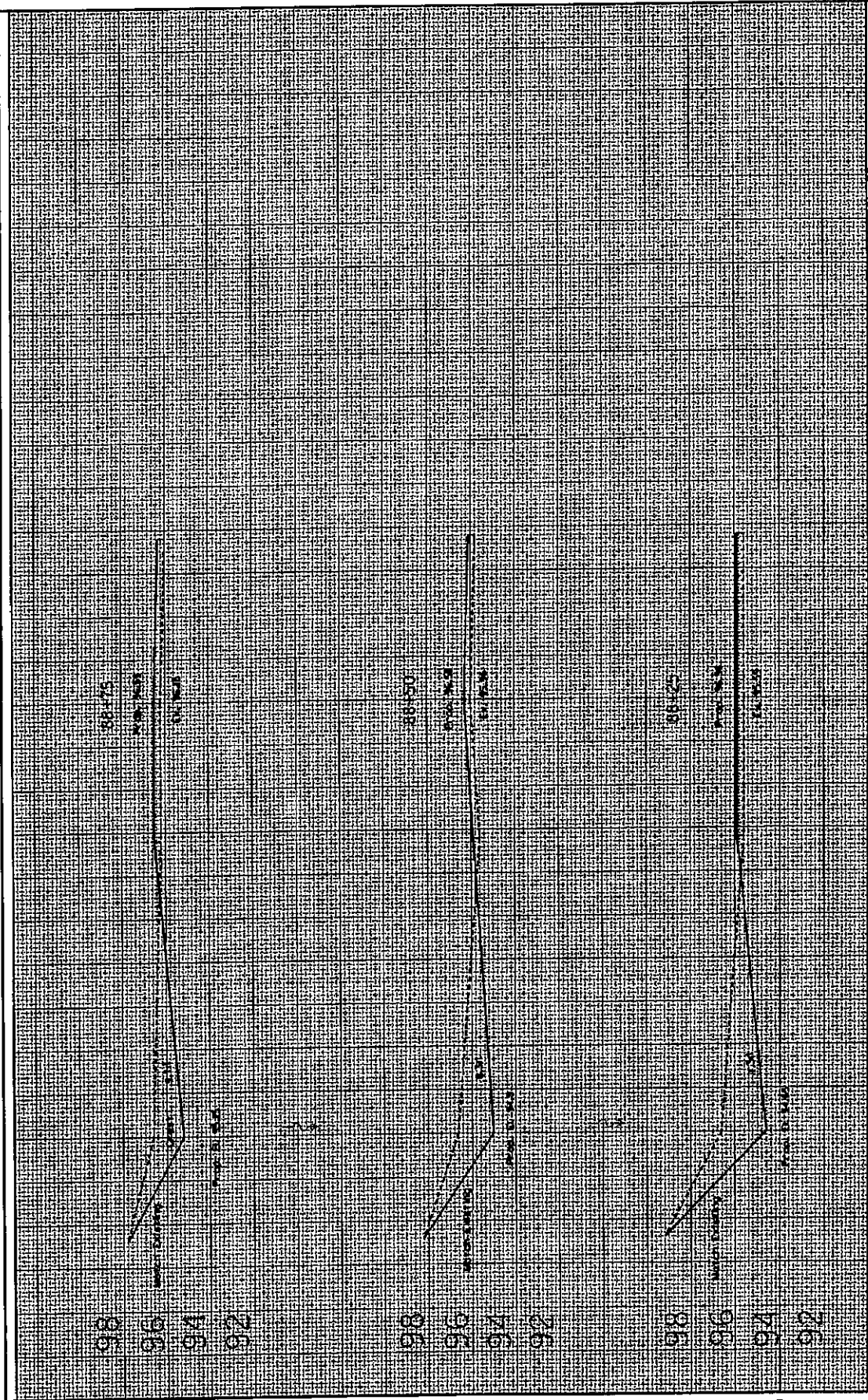

FILE NO. 1	DESIGNED BY	DATE	SCALE 1" = 40'	STATE OF ILLINOIS	SECTION	COUNTY	PLAT	CONTRACT NO.
100-100000	J. H. HARRIS	10/1/19	1" = 40'	DEPARTMENT OF TRANSPORTATION	100-100000	100-100000	100-100000	100-100000
PROJECT NO. 100-100000	BY	CHECKED	DATE	WHEELER RD 84+25 to 84+76	BY	DATE	BY	DATE
100-100000	J. H. HARRIS	J. H. HARRIS	10/1/19	SCALE 1" = 40'	J. H. HARRIS	10/1/19	J. H. HARRIS	10/1/19

NO.	DATE	REVISION

NO.	DATE	REVISION

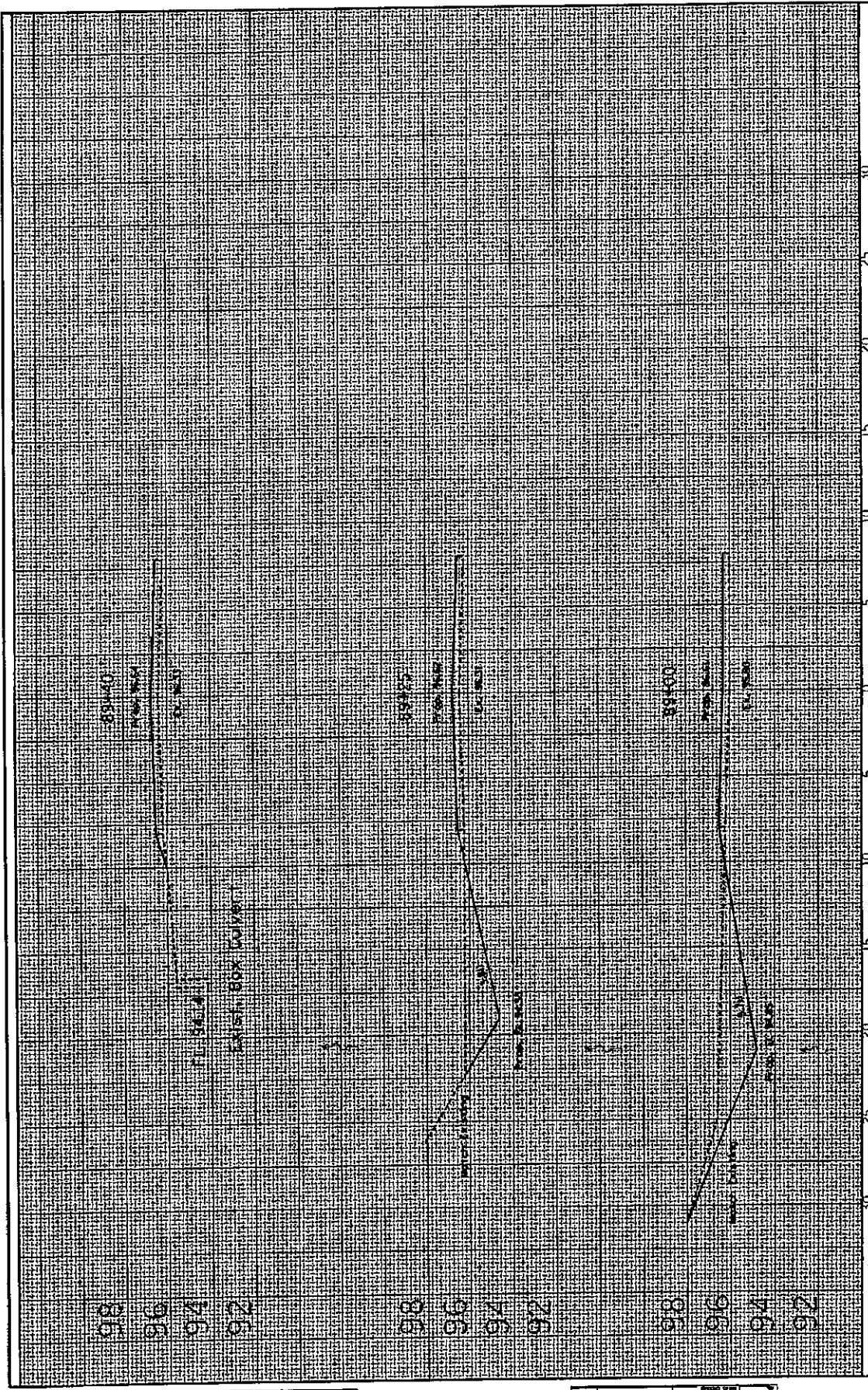

SHEET NO. 1 COUNTY: [] TOWNSHIP: [] RANGE: []	SECTION: 36 TOWNSHIP: 12 N RANGE: 10 W	STATE OF ILLINOIS DEPARTMENT OF TRANSPORTATION	LICENSE NO. [] WHEELER RD 93+00 to 94+00	SHEET NO. 2 COUNTY: [] TOWNSHIP: [] RANGE: []
---	--	---	--	---

DATE	BY	REVISION

DATE	BY	REVISION

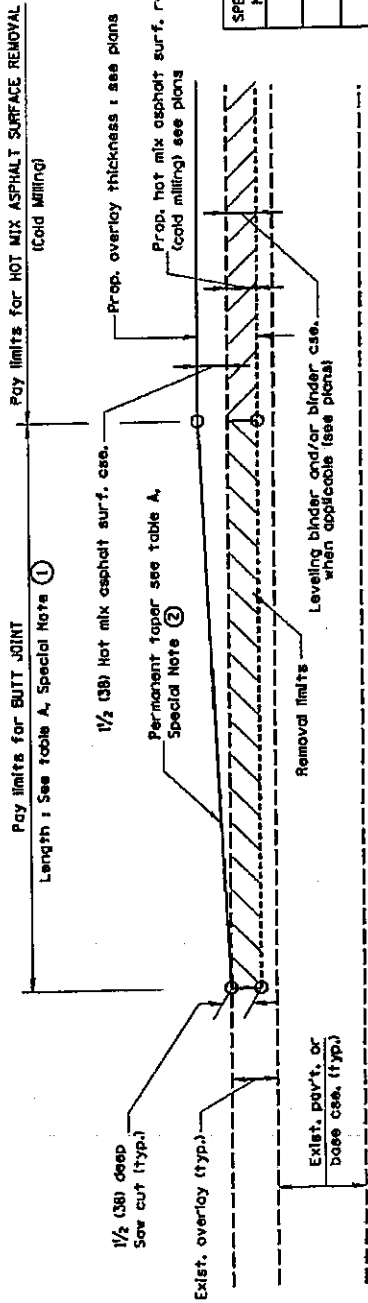

CASE 1 : WITH HOT MIX ASPHALT SURFACE REMOVAL (COLD MILLING)

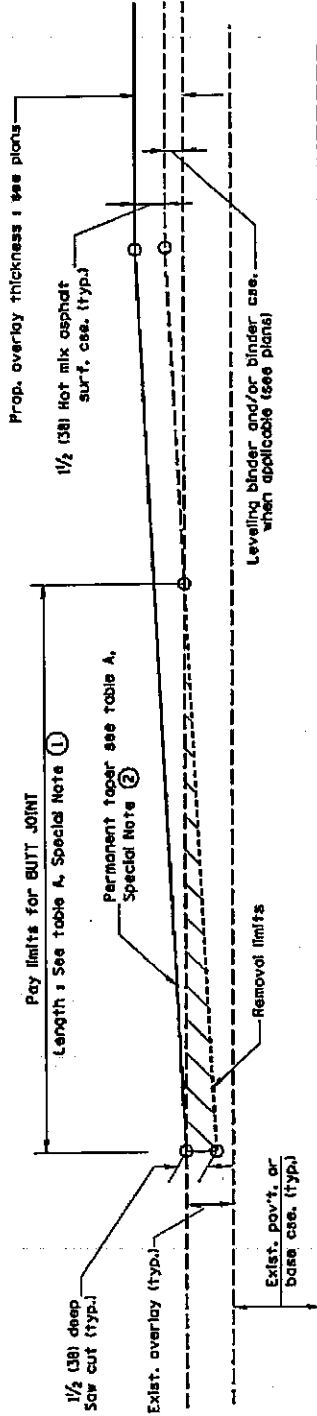

CASE 2 : NO HOT MIX ASPHALT SURFACE REMOVAL (COLD MILLING)

TABLE A
LENGTHS AND TAPER RATES

SPECIAL NOTE NUMBER	ELEMENT	MAINLINE INTERSTATES & 4-LANE EXPRESSWAYS	ALL OTHERS
①	LENGTH OF BUTT JOINT	60'(18.0 m)	30'(9.0 m)
②	PERMANENT TAPER RATE	1:480	1:240
③	TEMPORARY RAMP TAPER RATE	1:80	1:40
④	TEMPORARY RAMP LENGTH	10'(3.0 m)	5'(1.5 m)
⑤	LENGTH OF BUTT JOINT	10'(3.0 m)	10'(3.0 m)

GENERAL NOTES

1. The work shall be done in accordance with Article 405.08 and the Special Provision for Butt Joints.
2. The pavement surface to be removed may be either bituminous or P.C. concrete. The work shall be performed in accordance with Article 440.01 and the Special Provisions for Butt Joints.
3. The saw cut joints shall be primed just prior to the placing of bituminous material. The work will be in accordance with the applicable portions of Article 406.05.

All dimensions are in inches unless otherwise noted.

01-20-27 FEDERAL C-242, NEW SECTION BAY 01-20-27 CORRECTION TO BAY 01-15-06 REVISED MEASURE NOTES 01-15-06 REVISED TO NOT SPEC.	12. ALL M.A.A. N.A.	STATE OF ILLINOIS DEPARTMENT OF TRANSPORTATION	BUTT JOINTS NOT TO SCALE	SHEET 1 OF 3 C-400 STD. 06-04-04 CONTRACT NO. 04-04	COUNTY DISTRICT SECTION OFFICE CONTRACT NO. 04-04
--	------------------------------	---	-----------------------------	---	---

Pay limits for BUTT JOINT
Pay limits for HOT MIX ASPHALT SURFACE REMOVAL
 (Cold Milling)

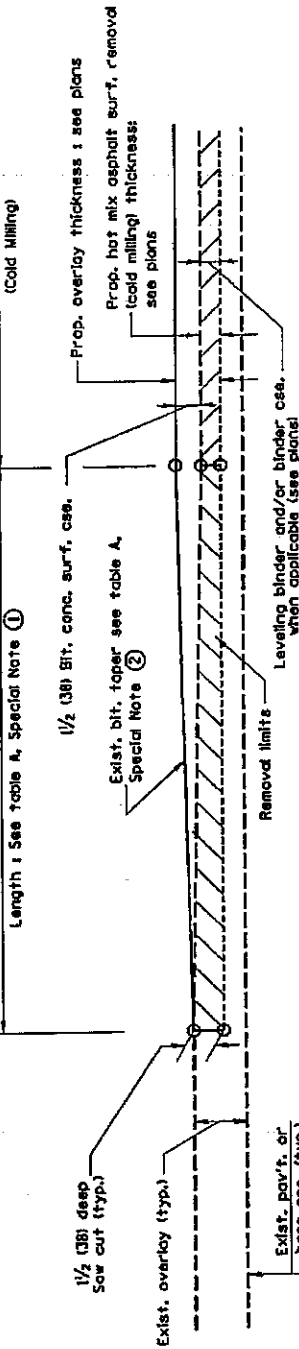

CASE 3 : WITH HOT MIX ASPHALT SURFACE REMOVAL (COLD MILLING)
TIE-IN TO EXISTING BITUMINOUS TAPER

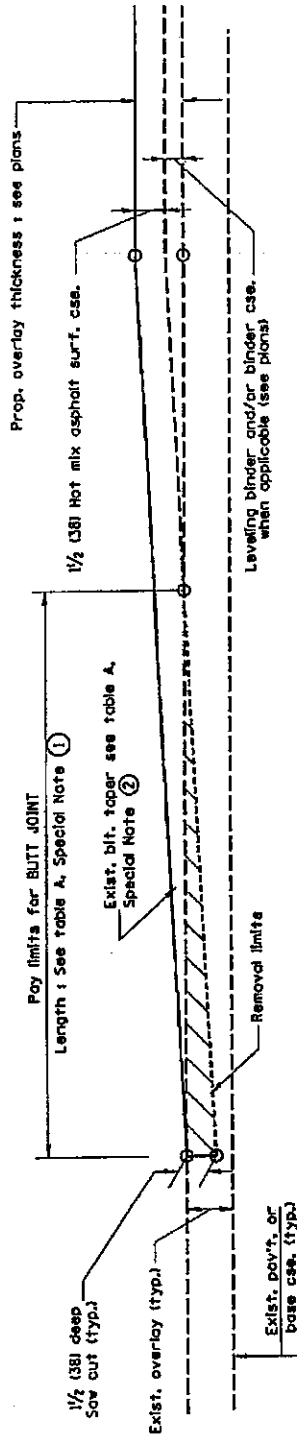

CASE 4 : NO HOT MIX ASPHALT SURFACE REMOVAL (COLD MILLING)
TIE-IN TO EXISTING BITUMINOUS TAPER

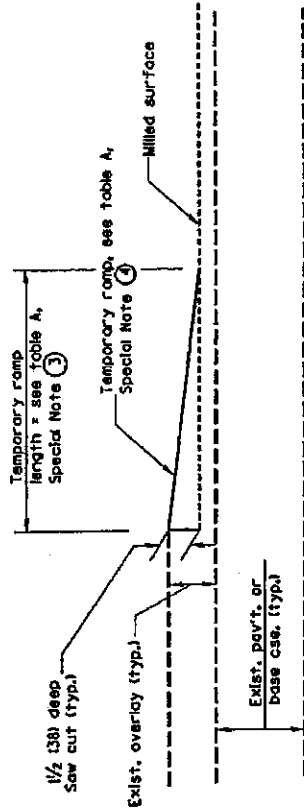

DETAIL TEMPORARY RAMP

All dimensions are in inches unless otherwise noted.

STATE OF ILLINOIS		DEPARTMENT OF TRANSPORTATION		BUTT JOINTS		CADD STD. 40-5101-01		SPT. 2 OF 3		CONTRACT NO. 405-1		SHEET NO.		TOTAL SHEETS	
DEPARTMENT OF TRANSPORTATION		DEPARTMENT OF TRANSPORTATION		BUTT JOINTS		CADD STD. 40-5101-01		SPT. 2 OF 3		CONTRACT NO. 405-1		SHEET NO.		TOTAL SHEETS	
DEPARTMENT OF TRANSPORTATION		DEPARTMENT OF TRANSPORTATION		BUTT JOINTS		CADD STD. 40-5101-01		SPT. 2 OF 3		CONTRACT NO. 405-1		SHEET NO.		TOTAL SHEETS	

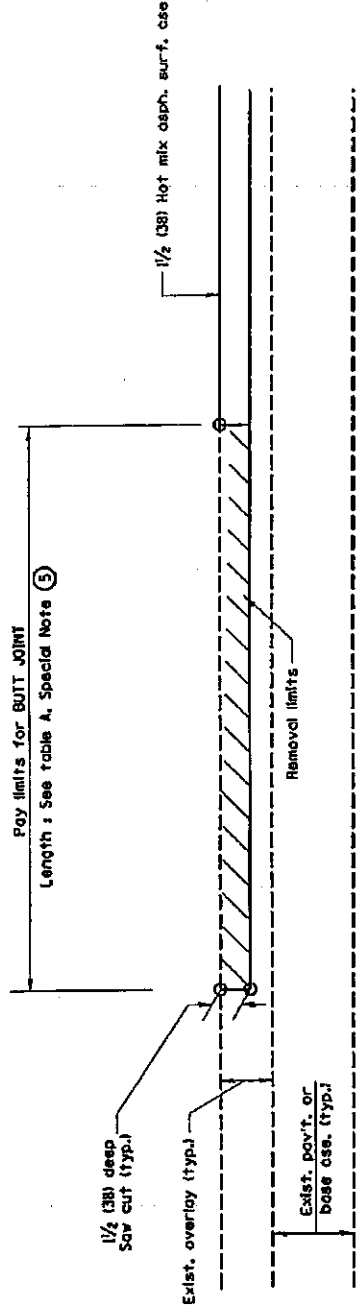

**CASE 5 : WITH HOT MIX ASPHALT SURFACE REMOVAL (COLD MILLING)
TIE-IN TO EXISTING BITUMINOUS TAPER**

As dimensions are in inches millimeter unless otherwise noted.

DATE	SECTION	COURT	TOILET	SHEET
11	090-4			15
OFF. 5 OF 5				
CADD STD. 60000-02				
BUTT JOINTS				
NOT TO SCALE				
STATE OF ILLINOIS DEPARTMENT OF TRANSPORTATION				

ILLINOIS DEPARTMENT OF LABOR

PREVAILING WAGES FOR PEORIA COUNTY EFFECTIVE MAY 2010

The Prevailing rates of wages are included in the Contract proposals which are subject to Check Sheet #5 of the Supplemental Specifications and Recurring Special Provisions. The rates have been ascertained and certified by the Illinois Department of Labor for the locality in which the work is to be performed and for each craft or type of work or mechanic needed to execute the work of the Contract. As required by Prevailing Wage Act (820 ILCS 130/0.01, et seq.) and Check Sheet #5 of the Contract, not less than the rates of wages ascertained by the Illinois Department of Labor and as revised during the performance of a Contract shall be paid to all laborers, workers and mechanics performing work under the Contract. Post the scale of wages in a prominent and easily accessible place at the site of work.

If the Illinois Department of Labor revises the prevailing rates of wages to be paid as listed in the specification of rates, the contractor shall post the revised rates of wages and shall pay not less than the revised rates of wages. Current wage rate information shall be obtained by visiting the Illinois Department of Labor web site at <http://www.state.il.us/agency/idol/> or by calling 312-793-2814. It is the responsibility of the contractor to review the rates applicable to the work of the contract at regular intervals in order to insure the timely payment of current rates. Provision of this information to the contractor by means of the Illinois Department of Labor web site satisfies the notification of revisions by the Department to the contractor pursuant to the Act, and the contractor agrees that no additional notice is required. The contractor shall notify each of its subcontractors of the revised rates of wages.

Peoria County Prevailing Wage for May 2010

Trade Name	RG	TYP	C	Base	FRMAN	*M-F>8	OSA	OSH	H/W	Pensn	Vac	Trng
=====	==	===	=	=====	=====	=====	===	===	=====	=====	=====	=====
ASBESTOS ABT-GEN		BLD		24.670	26.170	1.5	1.5	2.0	6.750	10.84	0.000	0.800
ASBESTOS ABT-GEN		HWY		26.250	27.250	1.5	1.5	2.0	6.750	11.36	0.000	0.800
ASBESTOS ABT-MEC		BLD		30.410	0.000	1.5	1.5	2.0	9.670	9.610	0.000	0.520
BOILERMAKER		BLD		34.170	37.170	2.0	2.0	2.0	6.820	8.550	0.000	0.350
BRICK MASON		BLD		29.620	31.120	1.5	1.5	2.0	6.550	8.080	0.000	0.460
CARPENTER		BLD		28.640	30.890	1.5	1.5	2.0	7.000	9.650	0.000	0.320
CARPENTER		HWY		29.830	32.080	1.5	1.5	2.0	7.000	9.940	0.000	0.320
CEMENT MASON		BLD		25.800	27.550	1.5	1.5	2.0	6.390	11.65	0.000	0.500
CEMENT MASON		HWY		27.000	28.250	1.5	1.5	2.0	6.390	12.11	0.000	0.500
CERAMIC TILE FNSHER		BLD		27.310	0.000	1.5	1.5	2.0	6.550	8.080	0.000	0.460
ELECTRIC PWR EQMT OP		ALL		32.770	0.000	1.5	1.5	2.0	4.750	9.170	0.000	0.000
ELECTRIC PWR GRNDMAN		ALL		22.480	0.000	1.5	1.5	2.0	4.750	6.290	0.000	0.000
ELECTRIC PWR LINEMAN		ALL		36.410	38.750	1.5	1.5	2.0	4.750	10.19	0.000	0.000
ELECTRIC PWR TRK DRV		ALL		23.590	0.000	1.5	1.5	2.0	4.750	6.610	0.000	0.000
ELECTRICIAN		BLD		33.790	36.290	1.5	1.5	2.0	5.250	9.370	0.000	0.250
ELECTRONIC SYS TECH		BLD		26.330	28.080	1.5	1.5	2.0	5.250	7.790	0.000	0.250
ELEVATOR CONSTRUCTOR		BLD		37.850	42.580	2.0	2.0	2.0	10.03	9.460	2.270	0.000
GLAZIER		BLD		28.420	30.420	1.5	1.5	2.0	7.500	6.750	0.000	0.750
HT/FROST INSULATOR		BLD		40.550	43.050	1.5	1.5	2.0	9.670	10.81	0.000	0.520
IRON WORKER		BLD		28.640	30.390	1.5	1.5	2.0	8.140	9.280	0.000	0.400
IRON WORKER		HWY		31.590	33.590	1.5	1.5	2.0	8.140	9.280	0.000	0.350
LABORER		BLD		23.670	25.170	1.5	1.5	2.0	6.750	10.84	0.000	0.800
LABORER		HWY		25.500	26.500	1.5	1.5	2.0	6.750	11.36	0.000	0.800
LABORER, SKILLED		BLD		24.070	25.570	1.5	1.5	2.0	6.750	10.84	0.000	0.800
LABORER, SKILLED		HWY		25.800	26.800	1.5	1.5	2.0	6.750	11.36	0.000	0.800
LATHER		BLD		28.640	30.890	1.5	1.5	2.0	7.000	9.650	0.000	0.320
MACHINERY MOVER		HWY		31.590	33.590	1.5	1.5	2.0	8.140	9.280	0.000	0.350
MACHINIST		BLD		42.770	44.770	1.5	1.5	2.0	7.750	8.690	0.650	0.000
MARBLE FINISHERS		BLD		27.310	0.000	1.5	1.5	2.0	6.550	8.080	0.000	0.460
MARBLE MASON		BLD		29.070	30.320	1.5	1.5	2.0	6.550	8.080	0.000	0.460
MILLWRIGHT		BLD		28.890	31.140	1.5	1.5	2.0	7.000	9.740	0.000	0.320
MILLWRIGHT		HWY		30.180	32.430	1.5	1.5	2.0	7.000	10.09	0.000	0.320
OPERATING ENGINEER		BLD	1	30.690	33.690	1.5	1.5	2.0	6.750	10.25	0.000	1.400
OPERATING ENGINEER		BLD	2	28.540	33.690	1.5	1.5	2.0	6.750	10.25	0.000	1.400
OPERATING ENGINEER		BLD	3	26.960	33.690	1.5	1.5	2.0	6.750	10.25	0.000	1.400
OPERATING ENGINEER		HWY	1	33.000	36.000	1.5	1.5	2.0	7.500	10.80	0.000	1.800
OPERATING ENGINEER		HWY	2	30.490	36.000	1.5	1.5	2.0	7.500	10.80	0.000	1.800
OPERATING ENGINEER		HWY	3	26.340	36.000	1.5	1.5	2.0	7.500	10.80	0.000	1.800
PAINTER		ALL		31.700	33.700	1.5	1.5	1.5	7.500	7.250	0.000	0.750
PAINTER SIGNS		BLD		31.740	35.640	1.5	1.5	1.5	2.600	2.540	0.000	0.000
PILEDRIIVER		BLD		29.140	31.390	1.5	1.5	2.0	7.000	9.650	0.000	0.320
PILEDRIIVER		HWY		30.830	33.030	1.5	1.5	2.0	7.000	9.940	0.000	0.320
PIPEFITTER		BLD		35.270	39.150	1.5	1.5	2.0	6.450	9.400	0.000	1.010
PLASTERER		BLD		27.000	28.250	1.5	1.5	2.0	6.390	10.63	0.000	0.500
PLUMBER		BLD		32.470	35.390	1.5	1.5	2.0	6.450	10.96	0.000	0.900
ROOFER		BLD		26.950	27.950	1.5	1.5	2.0	6.450	7.200	0.000	0.150
SHEETMETAL WORKER		BLD		30.740	32.280	1.5	1.5	2.0	6.070	11.71	0.000	0.460
SIGN HANGER		HWY		31.590	33.590	1.5	1.5	2.0	8.140	9.280	0.000	0.350
SPRINKLER FITTER		BLD		36.140	38.890	1.5	1.5	2.0	8.200	6.550	0.000	0.250
STEEL ERECTOR		HWY		31.590	33.590	1.5	1.5	2.0	8.140	9.280	0.000	0.350
STONE MASON		BLD		29.620	31.120	1.5	1.5	2.0	6.550	8.080	0.000	0.460
TERRAZZO FINISHER		BLD		27.310	0.000	1.5	1.5	2.0	6.550	8.080	0.000	0.460
TERRAZZO MASON		BLD		29.070	30.320	1.5	1.5	2.0	6.550	8.080	0.000	0.460
TILE MASON		BLD		29.070	30.320	1.5	1.5	2.0	6.550	8.080	0.000	0.460
TRUCK DRIVER		ALL	1	28.487	0.000	1.5	1.5	2.0	9.050	4.062	0.000	0.250
TRUCK DRIVER		ALL	2	28.887	0.000	1.5	1.5	2.0	9.050	4.062	0.000	0.250
TRUCK DRIVER		ALL	3	29.087	0.000	1.5	1.5	2.0	9.050	4.062	0.000	0.250
TRUCK DRIVER		ALL	4	29.337	0.000	1.5	1.5	2.0	9.050	4.062	0.000	0.250

TRUCK DRIVER	ALL	5	30.087	0.000	1.5	1.5	2.0	9.050	4.062	0.000	0.250
TRUCK DRIVER	O&C	1	22.790	0.000	1.5	1.5	2.0	9.050	4.062	0.000	0.250
TRUCK DRIVER	O&C	2	23.110	0.000	1.5	1.5	2.0	9.050	4.062	0.000	0.250
TRUCK DRIVER	O&C	3	23.270	0.000	1.5	1.5	2.0	9.050	4.062	0.000	0.250
TRUCK DRIVER	O&C	4	23.470	0.000	1.5	1.5	2.0	9.050	4.062	0.000	0.250
TRUCK DRIVER	O&C	5	24.070	0.000	1.5	1.5	2.0	9.050	4.062	0.000	0.250
TUCKPOINTER	BLD		29.620	31.120	1.5	1.5	2.0	6.550	8.080	0.000	0.460

Legend:

M-F>8 (Overtime is required for any hour greater than 8 worked each day, Monday through Friday.)

OSA (Overtime is required for every hour worked on Saturday)

OSH (Overtime is required for every hour worked on Sunday and Holidays)

H/W (Health & Welfare Insurance)

Pensn (Pension)

Vac (Vacation)

Trng (Training)

Explanations

PEORIA COUNTY

The following list is considered as those days for which holiday rates of wages for work performed apply: New Years Day, Memorial/Decoration Day, Fourth of July, Labor Day, Veterans Day, Thanksgiving Day, Christmas Day. Generally, any of these holidays which fall on a Sunday is celebrated on the following Monday. This then makes work performed on that Monday payable at the appropriate overtime rate for holiday pay. Common practice in a given local may alter certain days of celebration such as the day after Thanksgiving for Veterans Day. If in doubt, please check with IDOL.

Oil and chip resealing (O&C) means the application of road oils and liquid asphalt to coat an existing road surface, followed by application of aggregate chips or gravel to coated surface, and subsequent rolling of material to seal the surface.

EXPLANATION OF CLASSES

ASBESTOS - GENERAL - removal of asbestos material/mold and hazardous materials from any place in a building, including mechanical systems where those mechanical systems are to be removed. This includes the removal of asbestos materials/mold and hazardous materials from ductwork or pipes in a building when the building is to be demolished at the time or at some close future date.

ASBESTOS - MECHANICAL - removal of asbestos material from mechanical systems, such as pipes, ducts, and boilers, where the mechanical systems are to remain.

CERAMIC TILE FINISHER, MARBLE FINISHER, TERRAZZO FINISHER

Assisting, helping or supporting the tile, marble and terrazzo mechanic by performing their historic and traditional work assignments required to complete the proper installation of the work covered by said crafts. The term "Ceramic" is used for naming the classification only and is in no way a limitation of the product handled. Ceramic takes into consideration most hard tiles.

ELECTRONIC SYSTEMS TECHNICIAN

Installation, service and maintenance of low-voltage systems which utilizes the transmission and/or transference of voice, sound, vision, or digital for commercial, education, security and entertainment purposes for the following: TV monitoring and surveillance, background/foreground music, intercom and telephone interconnect, field programming, inventory control systems, microwave transmission, multi-media, multiplex, radio page, school, intercom and sound burglar alarms and low voltage master clock systems.

Excluded from this classification are energy management systems, life safety systems, supervisory controls and data acquisition systems not intrinsic with the above listed systems, fire alarm systems, nurse call systems and raceways exceeding fifteen feet in length.

LABORER, SKILLED - BUILDING

The skilled laborer building (BLD) classification shall encompass the following types of work, irrespective of the site of the work: cutting & acetylene torch, gunnite nozzlemen, gunnite pump men & pots, kettlemen & carriers of men handling hot stuff, sandblaster nozzle men, sandblasting pump men & pots, setting up and using concrete burning bars, wood block setters, underpinning & shoring of existing buildings, and the unloading and handling of all material coated with creosote.

LABORER, SKILLED - HIGHWAY

The skilled laborer heavy & highway (HWY) classification shall encompass the following types of work, irrespective of the site of the work: jackhammer & drill operator, gunite pump & pot man, puddlers, vibrator men, wire fabric placer, sandblast pump & pot man, strike off concrete, unloading, handling & carrying of all creosoted piles, ties or timber, concrete burning bars, power wheelbarrows or buggies, asphalt raker, bricksetters, cutting torchman (electric & acetylene), men setting lines to level forms, form setters, gunite nozzle man & sandblasting nozzle man, power man, and rip-rapping by hand.

TRUCK DRIVER - BUILDING, HEAVY AND HIGHWAY CONSTRUCTION

Class 1. Drivers on 2 axle trucks hauling less than 9 ton. Air compressor and welding machines and brooms, including those pulled by separate units, truck driver helpers, warehouse employees, mechanic helpers, greasers and tiremen, pickup trucks when hauling materials, tools, or workers to and from and on-the-job site, and fork lifts up to 6,000 lb. capacity.

Class 2. Two or three axle trucks hauling more than 9 ton but hauling less than 16 ton. A-frame winch trucks, hydrolift trucks, vector trucks or similar equipment when used for transportation purposes. Fork lifts over 6,000 lb. capacity, winch trucks, four axle combination units, and ticket writers.

Class 3. Two, three or four axle trucks hauling 16 ton or more. Drivers on water pulls, articulated dump trucks, mechanics and working

forepersons, and dispatchers. Five axle or more combination units.

Class 4. Low Boy and Oil Distributors.

Class 5. Drivers who require special protective clothing while employed on hazardous waste work.

TRUCK DRIVER - OIL AND CHIP RESEALING ONLY.

This shall encompass laborers, workers and mechanics who drive contractor or subcontractor owned, leased, or hired pickup, dump, service, or oil distributor trucks. The work includes transporting materials and equipment (including but not limited to, oils, aggregate supplies, parts, machinery and tools) to or from the job site; distributing oil or liquid asphalt and aggregate; stock piling material when in connection with the actual oil and chip contract. The Truck Driver (Oil & Chip Resealing) wage classification does not include supplier delivered materials.

OPERATING ENGINEERS - BUILDING

Class 1. Cranes; Overhead Cranes; Gradall; All Cherry Pickers; Mechanics; Central Concrete Mixing Plant Operator; Road Pavers (27E - Dual Drum - Tri Batchers); Blacktop Plant Operators and Plant Engineers; 3 Drum Hoist; Derricks; Hydro Cranes; Shovels; Skimmer Scoops; Koehring Scooper; Drag Lines; Backhoe; Derrick Boats; Pile Drivers and Skid Rigs; Clamshells; Locomotive Cranes; Dredge (all types) Motor Patrol; Power Blades - Dumore - Elevating and similar types; Tower Cranes (Crawler-Mobile) and Stationary; Crane-type Backfiller; Drott Yumbo and similar types considered as Cranes; Caisson Rigs; Dozer; Tournadozer; Work Boats; Ross Carrier; Helicopter; Tournapulls - all and similar types; Scoops (all sizes); Pushcats; Endloaders (all types); Asphalt Surfacing Machine; Slip Form Paver; Rock Crusher; Heavy Equipment Greaser; CMI, CMI Belt Placer, Auto Grade & 3 Track and similar types; Side Booms; Multiple Unit Earth Movers; Creter Crane; Trench Machine; Pump-crete-Belt Crete-Squeeze Cretes-Screw-type Pumps and Gypsum; Bulker & Pump - Operator will clean; Formless Finishing Machine; Flaherty Spreader or similar types; Screed Man on Laydown Machine; Wheel Tractors (industrial or Farm-type w/Dozer-Hoe-Endloader or other attachments); F.W.D. & Similar Types; Vermeer Concrete Saw.

Class 2. Dinkeys; Power Launches; PH One-pass Soil Cement Machine (and similar types); Pugmill with Pump; Backfillers; Euclid Loader; Forklifts; Jeeps w/Ditching Machine or other attachments; Tuneluger; Automatic Cement and Gravel Batching Plants; Mobile Drills (Soil Testing) and similar types; Gurries and Similar Types; (1) and (2) Drum Hoists (Buck Hoist and Similar Types); Chicago Boom; Boring Machine & Pipe Jacking Machine; Hydro Boom; Dewatering System; Straw Blower; Hydro Seeder; Assistant Heavy Equipment Greaser on Spread; Tractors (Track type) without Power Unit pulling Rollers; Rollers on Asphalt -- Brick Macadem; Concrete Breakers; Concrete Spreaders; Mule Pulling Rollers; Center Stripper; Cement Finishing Machines & CMI Texture & Reel Curing Machines; Cement Finishing Machine; Barber Green or similar loaders; Vibro Tamper (All similar types) Self-propelled; Winch or Boom Truck; Mechanical Bull Floats; Mixers over 3 Bag to 27E; Tractor pulling Power Blade or Elevating Grader; Porter Rex Rail; Clary Screed; Truck Type Hoptoe Oilers; Fireman; Spray Machine on Paving; Curb Machines; Truck Crane Oilers; Oil Distributor; Truck-Mounted Saws.

Class 3. Air Compressor; Power Subgrader; Straight Tractor; Trac Air

without attachments; Herman Nelson Heater, Dravo, Warner, Silent Glo, and similar types; Roller: Five (5) Ton and under on Earth or Gravel; Form Grader; Crawler Crane & Skid Rig Oilers; Freight Elevators - permanently installed; Pump; Light Plant; Generator; Conveyor (1) or (2) - Operator will clean; Welding Machine; Mixer (3) Bag and Under (Standard Capacity with skip); Bulk Cement Plant; Oiler on Central Concrete Mixing Plant.

OPERATING ENGINEERS - HEAVY AND HIGHWAY CONSTRUCTION

Class 1. Cranes; Hydro Crane; Shovels; Crane Type Backfiller; Tower Cranes - Mobile & Crawler & Stationary; Derricks & Hoists (3 Drum); Draglines; Drott Yumbo & similar types considered as Cranes; Back Hoe; Derrick Boats; Pile Driver and Skid Rigs; Clam Shell; Locomotive - Cranes; Road Pavers - Single Drum - Dual Drum - Tri Batcher; Motor Patrols & Power Blades - Dumore - Elevating & Similar Types; Mechanics; Central Concrete Mixing Plant Operator; Asphalt Batch Plant Operators and Plant Engineers; Gradall; Caisson Rigs; Skimmer Scoop - Koering Scooper; Dredges (all types); Hoptoe; All Cherry Pickers; Work Boat; Ross Carrier; Helicopter; Dozer; Tournadozer; Tournapulls - all and similar types; Multiple Unit Earth Movers; Scoops (all sizes); Pushcats; Endloaders (all types); Asphalt Surfacing Machine; Slip Form Paver; Rock Crusher; Heavy Equipment Greaser (top greaser on spread); CMI, Auto Grade, CMI Belt Placer & 3 Track and similar types; Side Booms; Starting Engineer on Pipeline; Asphalt Heater & Planer Combination (used to plane streets); Wheel Tractors (with dozer, hoe or endloader attachments); F.W.D. and Similar types; Blaw Knox Spreader and Similar types; Trench Machines; Pump Crete - Belt Crete - Squeeze Crete - screw type pumps and gypsum (operator will clean); Formless Finishing Machines; Flaherty Spreader or similar types; Screed Man on Laydown Machine; Vermeer Concrete Saw.

Class 2. Bulker & Pump; Power Launches; Boring Machine & Pipe Jacking Machine; Dinkeys; P-H One Pass Soil Cement Machines and similar types; Wheel Tractors (Industry or farm type - other); Back Fillers; Euclid Loader; Fork Lifts; Jeep w/Ditching Machine or other attachments; Tunneluger; Automatic Cement & Gravel Batching Plants; Mobile Drills - Soil Testing and similar types; Pugmill with pump; All (1) and (2) Drum Hoists; Dewatering System; Straw Blower; Hydro-Seeder; Boring Machine; Hydro-Boom; Bump Grinders (self-propelled); Assistant Heavy Equipment Greaser; Apsco Spreader; Tractors (track-type) without Power Units Pulling Rollers on Asphalt - Brick or Macadam; Concrete Breakers; Concrete Spreaders; Cement Strippers; Cement Finishing Machines & CMI Texture & Reel Curing Machines; Vibro-Tampers (all similar types self-propelled); Mechanical Bull Floats; Self-propelled Concrete Saws; Mixers-over three (3) bags to 27E; Winch and Boom Trucks; Tractor Pulling Power Blade or Elevating Grader; Porter Rex Rail; Clary Screed; Mule Pulling Rollers; Pugmill without Pump; Barber Greene or similar Loaders; Track Type Tractor w/Power Unit attached (minimum); Fireman; Spray Machine on Paving; Curb Machines; Paved Ditch Machine; Power Broom; Self-Propelled Conveyors; Power Subgrader; Oil Distributor; Straight Tractor; Truck Crane Oiler; Truck Type Oilers; Directional boring machine; Horizontal directional drill.

Class 3. Straight framed articulating end dump vehicles and Truck mounted vac unit (separately powered); Trac Air Machine (without attachments); Herman Nelson Heater, Dravo Warner, Silent Glo & similar types; Rollers - five ton and under on earth and gravel; Form Graders; Pumps; Light Plant; Generator; Air Compressor (1) or (2); Conveyor; Welding Machine; Mixer - 3 bags and under; Bulk Cement Plant; Oilers.

Other Classifications of Work:

For definitions of classifications not otherwise set out, the Department generally has on file such definitions which are available. If a task to be performed is not subject to one of the classifications of pay set out, the Department will upon being contacted state which neighboring county has such a classification and provide such rate, such rate being deemed to exist by reference in this document. If no neighboring county rate applies to the task, the Department shall undertake a special determination, such special determination being then deemed to have existed under this determination. If a project requires these, or any classification not listed, please contact IDOL at 217-782-1710 for wage rates or clarifications.

LANDSCAPING

Landscaping work falls under the existing classifications for laborer, operating engineer and truck driver. The work performed by landscape plantsman and landscape laborer is covered by the existing classification of laborer. The work performed by landscape operators (regardless of equipment used or its size) is covered by the classifications of operating engineer. The work performed by landscape truck drivers (regardless of size of truck driven) is covered by the classifications of truck driver.