

F.A.P. RTE.	SECTION	COUNTY	TOTAL SHEETS	SHEET NO.
*	**	WINNEBAGO	335	148
STA.		TO STA.		
FED. ROAD DIST. NO.		ILLINOIS	FED. AID PROJECT	
*FAP 505 (IL 75)				
**111RS-4, 111BR-1, Ya-15d-RS-1, & (W-15d)T-1				

# DROP BOX NO. 12

RT STA. 109 + 39

## PLAN

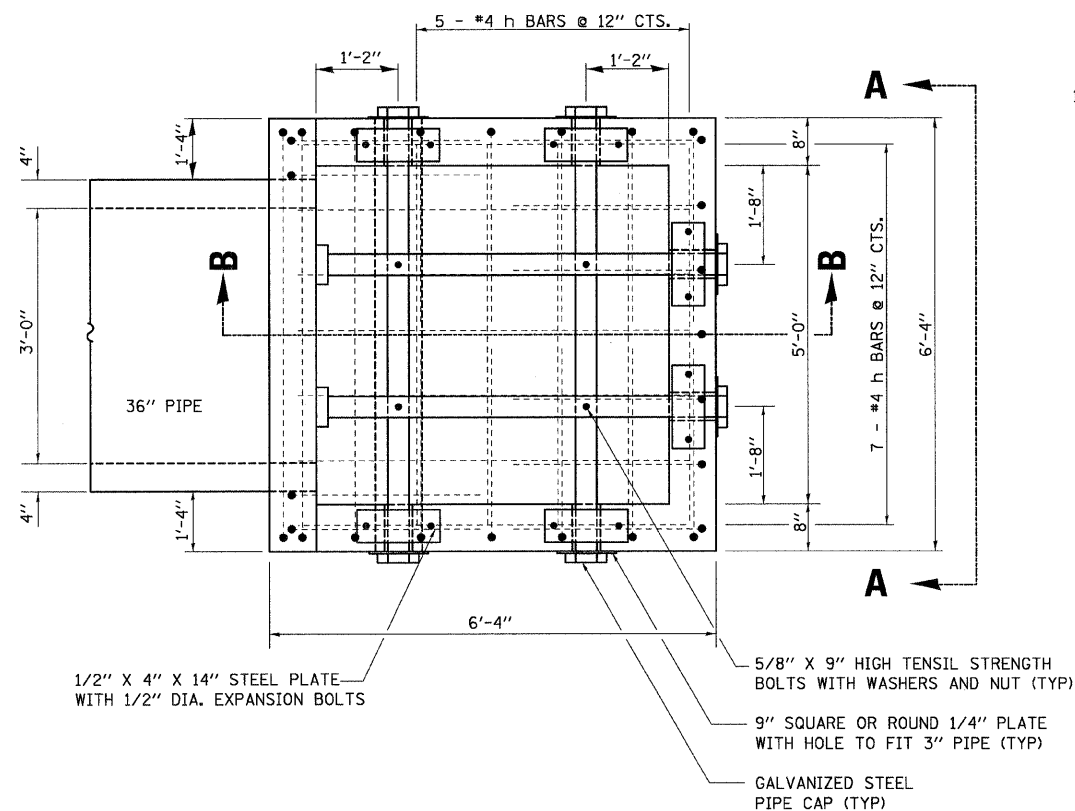

## SECTION B-B

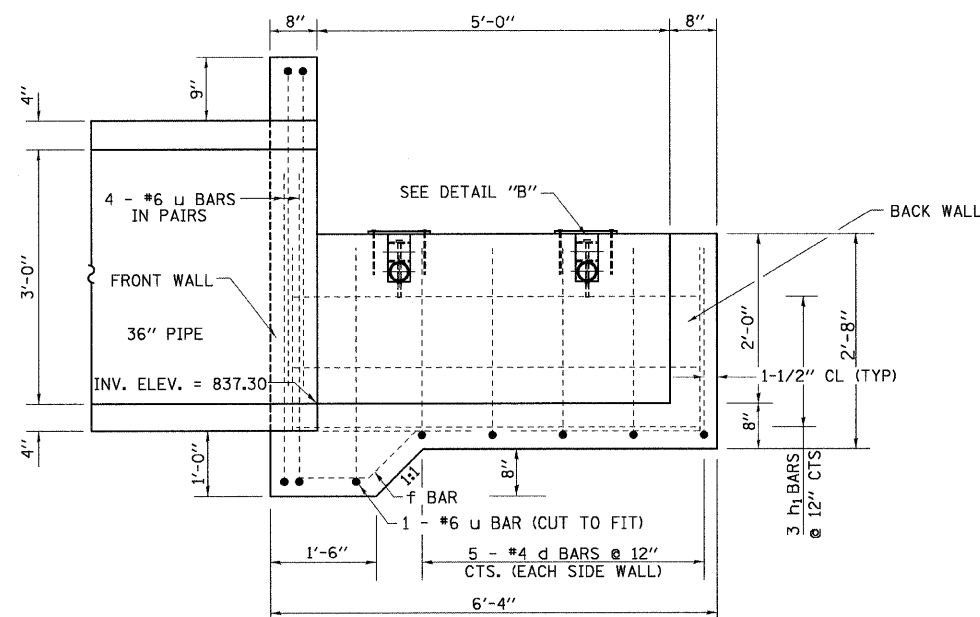

## DETAIL "B"

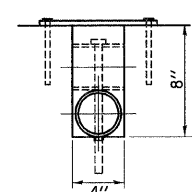

## TOP ANCHOR PLATE

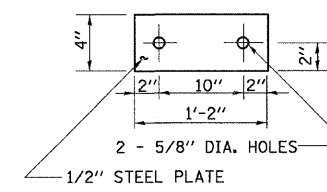

## DETAIL "A"

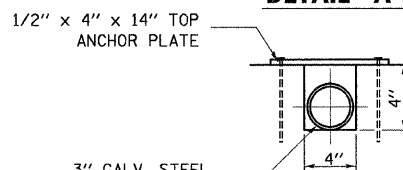

## BAR d

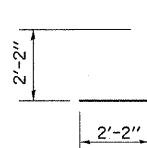

## BAR f

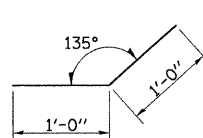

## BAR u

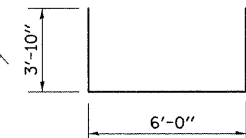

## BAR x

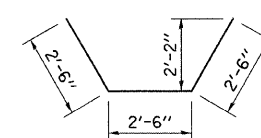

## VIEW A-A

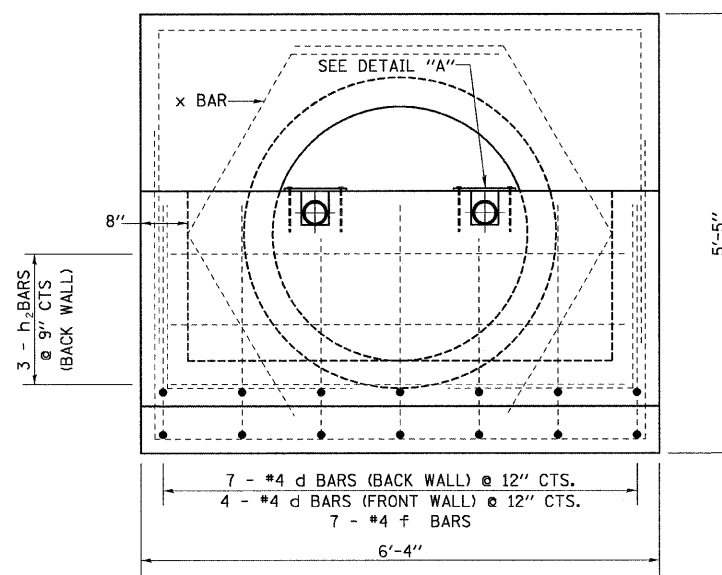

## BILL OF MATERIALS (FOR REINFORCEMENT)

BAR	SIZE	NO.	LENGTH	WEIGHT (LB)	
d	4	21	4'-4"	60.79	
f	4	7	2'-0"	9.35	
h	6	12	6'-0"	108.14	
u	6	5	13'-7"	102.01	
x	4	2	7'-6"	10.02	
DESCRIPTION				UNIT	QTY
CONCRETE STRUCTURES				CU YD	2.5
REINFORCEMENT BARS				LB	290

## BILL OF MATERIALS (FOR GRATED DROP BOX)

DESCRIPTION	UNIT	QTY.
3" GALVANIZED STEEL PIPE	FOOT	2 @ 6'-4"
3" GALV PIPE CAPS	EACH	8
1/4" GALV. STEEL PLATE (9" NOMINAL)	EACH	6
1/2" x 4" x 14" GALV. STEEL PLATE	EACH	6
5/8" x 9" GALV. STEEL BOLTS	EACH	4
EXPANSION BOLTS 1/2"φ	EACH	12

## GENERAL NOTES:

SLOPE FLOW LINE OF THE DROP BOX AT THE SAME RATE AS THE FLOW LINE OF THE BOX CULVERT.

BOLTS, NUTS, AND WASHERS SHALL BE IN ACCORDANCE WITH ARTICLE 1006.08 OF THE STANDARD SPECIFICATION AND SHALL BE GALVANIZED.

STEEL PIPES SHALL CONFORM TO A.S.T.M. A-53 (TYPE E OR S) GRADE B, SCHEDULE 40, AND SHALL BE GALVANIZED CONFORMING TO A.S.T.M. A-120. CONTRACTOR SHALL FIELD VERIFY PIPE LENGTH.

STEEL PLATES SHALL CONFORM TO AASHTO M-183 AND SHALL BE GALVANIZED CONFORMING TO AASHTO M-111.

REINFORCEMENT BARS SHALL CONFORM TO THE REQUIREMENTS OF A.S.T.M. A 706 GR 60 (IL MODIFIED). SEE SPECIAL PROVISION.

SEE PLAN AND PROFILE SHEET 78 OF 335 FOR MORE INFORMATION.

SEE SHEET 159 OF 335 FOR DETAILS OF BREAKER RUN CRUSHED STONE.

THE CONTRACT UNIT PRICE "CU. YD." FOR CONCRETE STRUCTURES SHALL INCLUDE THE GALVANIZED PIPE, BOLTS, NUTS, WASHERS, AND STEEL PLATES, AND ALL APPLICABLE WORK ACCORDING TO SECTION 503 OF THE STANDARD SPECIFICATIONS.